



TEST REPORT

APPLICANT : Great Talent Technology Limited
PRODUCT NAME : Smart phone
MODEL NAME : freedom turbo XL
BRAND NAME : Schok
FCC ID : 2ALZM-TURBOXL
STANDARD(S) : 47 CFR Part 2(2.1093)
IEEE 1528-2013
RECEIPT DATE : 2020-06-28
TEST DATE : 2020-07-14 to 2020-08-10
ISSUE DATE : 2020-08-23

Edited by : Liang Yumei
Liang Yumei (Rapporteur)
Approved by: Peng Huarui
Peng Huarui (Supervisor)

NOTE: This document is issued by MORLAB, the test report shall not be reproduced except in full without prior written permission of the company. The test results apply only to the particular sample(s) tested and to the specific tests carried out which is available on request for validation and information confirmed at our website.





DIRECTORY

- 1. SAR Results Summary..... 5
- 2. Technical Information..... 7
 - 2.1. Applicant and Manufacturer Information..... 7
 - 2.2. Equipment Under Test (EUT) Description 7
 - 2.3. Environment of Test Site/Conditions 9
- 3. Specific Absorption Rate (SAR)..... 10
 - 3.1. Introduction 10
 - 3.2. SAR Definition 10
- 4. RF Exposure Limits..... 11
 - 4.1. Uncontrolled Environment 11
 - 4.2. Controlled Environment..... 11
- 5. Applied Reference Documents 12
- 6. SAR Measurement System..... 13
 - 6.1. E-Field Probe 14
 - 6.2. Data Acquisition Electronics (DAE)..... 15
 - 6.3. Robot 16
 - 6.4. Measurement Server 16
 - 6.5. Light Beam Unit..... 17
 - 6.6. Phantom 17
 - 6.7. Device Holder 18
 - 6.8. Data Storage and Evaluation..... 19
 - 6.9. Test Equipment List..... 22
- 7. Tissue Simulating Liquids..... 24
- 8. SAR System Verification..... 26



- 8.1. Purpose of System Performance check 26
- 8.2. System Setup 26
- 8.3. Validation Results 27
- 9. EUT Testing Position 29
 - 9.1. Handset Reference Points 29
 - 9.2. Positioning for Cheek / Touch 30
 - 9.3. Positioning for Ear / 15° Tilt 31
 - 9.4. SAR Evaluations near the Mouth/Jaw Regions of the SAM Phantom 31
 - 9.5. Body-worn Configurations 32
 - 9.6. Hotspot Mode Exposure Position Conditions 32
- 10. Measurement Procedures 33
 - 10.1. Spatial Peak SAR Evaluation 33
 - 10.2. Power Reference Measurement 34
 - 10.3. Area Scan Procedures 34
 - 10.4. Zoom Scan Procedures 35
 - 10.5. SAR Averaged Methods 35
 - 10.6. Power Drift Monitoring 35
- 11. SAR Test Procedure 36
 - 11.1. General Scan Requirements 36
 - 11.2. Test Procedure 37
 - 11.3. Description of Interpolation/Extrapolation Scheme 37
 - 11.4. Wireless Router 37
- 12. SAR Test Configuration 39
- 13. Conducted RF Output Power 51
- 14. LTE Carrier Aggregation 94
 - 14.1. LTE Downlink Carrier Aggregation Conducted Power 95
- 15. Hot-Spot Mode Evaluation Procedure 97
- 16. Block Diagram of the Tests to be Performed 98



16.1. Head..... 98

16.2. Body..... 99

17. Test Results List100

17.1. Test Guidance.....100

17.2. Head SAR Data102

17.3. Body-worn SAR Data.....109

17.4. Hotspot SAR Data113

17.5. Extremity SAR Assessment119

17.6. Repeated SAR Assessment.....120

18. Simultaneous Transmission Evaluation122

18.1. Simultaneous Transmission Consideration.....122

18.2. Simultaneous Transmission Analysis.....123

19. Uncertainty Assessment.....129

Annex A General Information.....132

Annex B Test Setup Photos

Annex C Plots of System Performance Check

Annex D Plots of Maximum SAR Test Results

Annex E DASY Calibration Certificate

Changed History		
Version	Date	Reason for Change
1.0	2020-08-23	First edition

1. SAR Results Summary

The maximum results of Specific Absorption Rate (SAR) found during test as bellows:

<Highest Reported SAR Summary>

Frequency Band		Highest SAR Summary			
		Head (Gap 0mm)	Body-worn (Gap 10mm)	Hotspot (Gap 10mm)	Extremity (Gap 0mm)
		1g SAR (W/kg)			10g SAR (W/kg)
GSM	GSM850	0.128	0.391	0.391	N/A
	GSM1900	1.107	0.682	0.682	N/A
WCDMA	WCDMA Band II	1.199	0.498	0.519	N/A
	WCDMA Band IV	1.123	0.702	0.702	N/A
	WCDMA Band V	0.293	0.497	0.497	N/A
LTE	LTE Band 2	1.087	0.664	0.664	N/A
	LTE Band 4	1.100	0.545	0.545	N/A
	LTE Band 5	0.308	0.481	0.481	N/A
	LTE Band 12	0.180	0.320	0.320	N/A
	LTE Band 13	0.113	0.294	0.294	N/A
	LTE Band 25	1.081	0.661	0.661	N/A
	LTE Band 26	0.152	0.505	0.505	N/A
	LTE Band 30	0.140	1.046	1.185	N/A
	LTE Band 41	0.078	0.602	0.699	N/A
	LTE Band 66	1.117	0.450	0.517	N/A
WLAN	2.4GHz WLAN	0.152	0.084	0.084	N/A
	5GHz WLAN	0.135	0.110	0.110	0.246
2.4GHz Band	Bluetooth (Estimated)	N/A	0.165	0.165	N/A

Max Scaled SAR _{1g} (W/Kg):	Head:	1.199 W/kg	Limit(W/kg): 1.6 W/kg
	Body-worn:	1.046 W/kg	
	Hotspot:	1.185 W/kg	
Max Scaled SAR _{10g} (W/Kg):	Extremity:	0.246 W/kg	Limit(W/kg): 4.0 W/kg

Highest Simultaneous Transmission SAR _{1g} (W/Kg):	1.351 W/kg	Limit(W/kg): 1.6 W/kg
---	------------	-----------------------

Note:



1. This device is in compliance with Specific Absorption Rate (SAR) for general population or uncontrolled exposure limits (1.6W/kg as averaged over any 1 gram of tissue; specified in FCC 47 CFR part 2 (2.1093) and ANSI/IEEE C95.1-1992), and had been tested in accordance with the measurement methods and procedures specified in IEEE 1528-2013 and FCC KDB publications.
2. When the test result is a critical value, we will use the measurement uncertainty give the judgment result based on the 95% risk level.



2. Technical Information

Note: Provide by applicant.

2.1. Applicant and Manufacturer Information

Applicant:	Great Talent Technology Limited
Applicant Address:	RM602,T3 Software Park,Nanshan,Shenzhen,China
Manufacturer:	Unimaxcomm
Manufacturer Address:	Floor 35th, HBC Huilong Centre 2nd Phase office building, Minzhi Street, Longhua District, Shenzhen, P.R. China 518057

2.2. Equipment Under Test (EUT) Description

Product Name:	Smart phone
Hardware Version:	V10_0506
Software Version:	Q6501_SFT656128_V1.0.29-userdebug
Frequency Bands:	GSM 850: 824 MHz ~ 849 MHz GSM 1900: 1850 MHz ~ 1910 MHz WCDMA Band II: 1850 MHz ~ 1910 MHz WCDMA Band IV: 1710 MHz ~ 1755 MHz WCDMA Band V: 824 MHz ~ 849 MHz LTE Band 2: 1850 MHz ~ 1910 MHz LTE Band 4: 1710 MHz ~ 1755 MHz LTE Band 5: 824 MHz ~ 849 MHz LTE Band 12: 699 MHz ~ 716 MHz LTE Band 13: 777 MHz ~ 787 MHz LTE Band 17: 704 MHz ~ 716 MHz LTE Band 25: 1850 MHz ~ 1915 MHz LTE Band 26: 814 MHz ~ 849 MHz LTE Band 30: 2305 MHz ~ 2315 MHz LTE Band 41: 2496 MHz ~ 2690 MHz LTE Band 66: 1710 MHz ~ 1780 MHz LTE Band 71: 663 MHz ~ 698 MHz WLAN 2.4GHz: 2412 MHz ~ 2472 MHz WLAN 5.2GHz: 5180 MHz ~ 5240 MHz WLAN 5.3GHz: 5260 MHz ~ 5320 MHz WLAN 5.5GHz: 5500 MHz ~ 5720 MHz WLAN 5.8GHz: 5745 MHz ~ 5825 MHz



	Bluetooth: 2402 MHz ~ 2480 MHz NFC: 13.56 MHz	
Modulation Mode:	GSM/GPRS: GMSK EDGE: 8PSK WCDMA: QPSK/16QAM LTE: QPSK/16QAM/64QAM 802.11b: DSSS 802.11a/g/n-HT20/HT40/ac-VHT20/40/80: OFDM BR+EDR: GFSK(1Mbps), $\pi/4$ -DQPSK(2Mbps), 8-DPSK(3Mbps) Bluetooth LE: GFSK(1Mbps), $\pi/4$ -DQPSK(2Mbps) NFC: ASK	
LTE Carrier Aggregation Combinations	CA Downlink Only: 2A-12A,2A-5A,5A-66A,2A-66A,13A-66A,66A-66A	
Multi-slot Class:	GPRS: Multi-slot Class 12; EDGE: Multi-slot Class 12;	
Operation Class:	Class B	
Hotspot Mode:	WWAN/2.4GHz WLAN/5.2GHz WLAN/5.8GHz WLAN	
Antenna Type:	WWAN: Fixed Internal Antenna WLAN: PIFA Antenna Bluetooth: PIFA Antenna	
Battery:	Manufacturer:	DONGGUAN MILLET ELECTRONICE CO.LTD
	Model Name:	426684P4000
	Capacity:	4000mAh
	Rated Voltage:	3.85V
SIM Cards Description:	SIM 1	GSM+WCDMA+LTE
	SIM 2	GSM+WCDMA+LTE
	For dual SIM card version, SIM 1 and SIM 2 are the same chipset unit and tested as a single chipset, the SIM 1 is selected for testing	

Note: For a more detailed description, please refer to specification or user manual supplied by the applicant and/or manufacturer.



2.3.Environment of Test Site/Conditions

Normal Temperature (NT):	20-25 °C
Relative Humidity:	30-75 %
Air Pressure:	980-1020 hPa

Test Frequency:	GSM 850MHz/1900MHz WCDMA Band II/IV/V FDD-LTE Band 2/4/5/12/13/25/26/30/66/71 TDD-LTE Band 41 WLAN 2.4GHz WLAN 5GHz
Operation Mode:	Call established
Power Level:	GSM 850 MHz (Maximum output power(level 5)) GSM 1900MHz (Maximum output power(level 0)) WCDMA Band II/IV/V (All Up Bits) FDD-LTE Band 2/4/5/12/13/25/26/30/66/71 (Maximum output power) TDD-LTE Band 41(Maximum output power) WLAN 2.4GHz (Power Setting=18.5) WLAN 5GHz (Power Setting=20)

During SAR test, EUT is in Traffic Mode (Channel Allocated) at Normal Voltage Condition. A communication link is set up with a System Simulator (SS) by air link, and a call is established.

The EUT shall use its internal transmitter. The antenna(s), battery and accessories shall be those specified by the Factory. The EUT battery must be fully charged and checked periodically during the test to ascertain uniform power output. If a wireless link is used, the antenna connected to the output of the base station simulator shall be placed at least 50 cm away from the handset. The signal transmitted by the simulator to the antenna feeding point shall be lower than the output power level of the handset by at least 35 dB.

3. Specific Absorption Rate (SAR)

3.1. Introduction

SAR is related to the rate at which energy is absorbed per unit mass in an object exposed to a radio field. The SAR distribution in a biological body is complicated and is usually carried out by experimental techniques or numerical modeling. The standard recommends limits for two tiers of groups, occupational/controlled and general population/uncontrolled, based on a person's awareness and ability to exercise control over his or her exposure. In general, occupational/controlled exposure limits are Middle than the limits for general population/uncontrolled.

3.2. SAR Definition

The SAR definition is the time derivative (rate) of the incremental energy (dW) absorbed by(dissipated in) an incremental mass (dm) contained in a volume element (dv) of a given density. (ρ). The equation description is as below:

$$SAR = \frac{d}{dt} \left(\frac{dW}{dm} \right) = \frac{d}{dt} \left(\frac{dW}{\rho dv} \right)$$

SAR is expressed in units of Watts per kilogram (W/kg).

SAR measurement can be either related to the temperature elevation in tissue by,

$$SAR = C \left(\frac{\delta T}{\delta t} \right)$$

Where C is the specific head capacity, δT is the temperature rise and δt the exposure duration, or related to the electrical field in the tissue by

$$SAR = \frac{\sigma |E|^2}{\rho}$$

Where σ is the conductivity of the tissue, ρ is the mass density of the tissue and $|E|$ is the rmselectrical field strength.

However for evaluating SAR of low power transmitter, electrical field measurement is typically applied.



4. RF Exposure Limits

4.1. Uncontrolled Environment

Uncontrolled Environments are defined as locations where there is the exposure of individuals who have no knowledge or control of their exposure. The general population/uncontrolled exposure limits are applicable to situations in which the general public may be exposed or in which persons who are exposed as a consequence of their employment may not be made fully aware of the potential for exposure or cannot exercise control over their exposure. Members of the general public would come under this category when exposure is not employment-related; for example, in the case of a wireless transmitter that exposes persons in its vicinity.

4.2. Controlled Environment

Controlled Environments are defined as locations where there is exposure that may be incurred by persons who are aware of the potential for exposure, (i.e. as a result of employment or occupation). In general, occupational/controlled exposure limits are applicable to situations in which persons are exposed as a consequence of their employment, who have been made fully aware of the potential for exposure and can exercise control over their exposure. The exposure category is also applicable when the exposure is of a transient nature due to incidental passage through a location where the exposure levels may be higher than the general population/uncontrolled limits, but the exposed person is fully aware of the potential for exposure and can exercise control over his or her exposure by leaving the area or by some other appropriate means.

Limits for General Population/Uncontrolled Exposure (W/kg)

Type Exposure	Uncontrolled Environment Limit
Spatial Peak SAR (1g cube tissue for head and trunk)	1.6 W/kg
Spatial Peak SAR (10g cube tissue for limbs)	4.0 W/kg
Spatial Peak SAR (1g cube tissue for whole body)	0.08 W/kg

Note:

- Occupational/Uncontrolled Environments are defined as locations where there is exposure that may be incurred by people who are aware of the potential for exposure (i.e. as a result of employment or occupation).
- Whole-Body SAR is averaged over the entire body, partial-body SAR is averaged over any 1gram of tissue defined as a tissue volume in the shape of a cube. SAR for hands, wrists, feet and ankles is averaged over any 10 grams of tissue defined as a tissue volume in the shape of a cube.

5. Applied Reference Documents

Leading reference documents for testing:

No.	Identity	Document Title	Method Determination /Remark
1	47 CFR Part 2(2.1093)	Radio Frequency Radiation Exposure Evaluation: Portable Devices	No deviation
2	IEEE 1528-2013	IEEE Recommended Practice for Determining the Peak Spatial-Average Specific Absorption Rate (SAR) in the Human Head from Wireless Communications Devices: Measurement Techniques	No deviation
3	KDB 447498 D01v06	General RF Exposure Guidance	No deviation
4	KDB 248227 D01v02r02	SAR Measurement Procedures for 802.11 Transmitters	No deviation
5	KDB 865664 D01v01r04	SAR Measurement 100 MHz to 6 GHz	No deviation
6	KDB 865664 D02v01r02	RF Exposure Reporting	No deviation
7	KDB 648474 D04v01r03	Handset SAR	No deviation
8	KDB 941225 D01v03r01	3G SAR MEAUREMENT PROCEDURES	No deviation
9	KDB 941225 D05v02r05	SAR Evaluation Consideration for LTE Devices	No deviation
10	KDB 941225 D06v02r01	SAR Evaluation Procedures For Portable Devices With Wireless Router Capabilities	No deviation

Note 1: The test item is not applicable.

Note 2: Additions to, deviation, or exclusions from the method shall be judged in the "method determination" column of add, deviate or exclude from the specific method shall be explained in the "Remark" of the above table.

6. SAR Measurement System

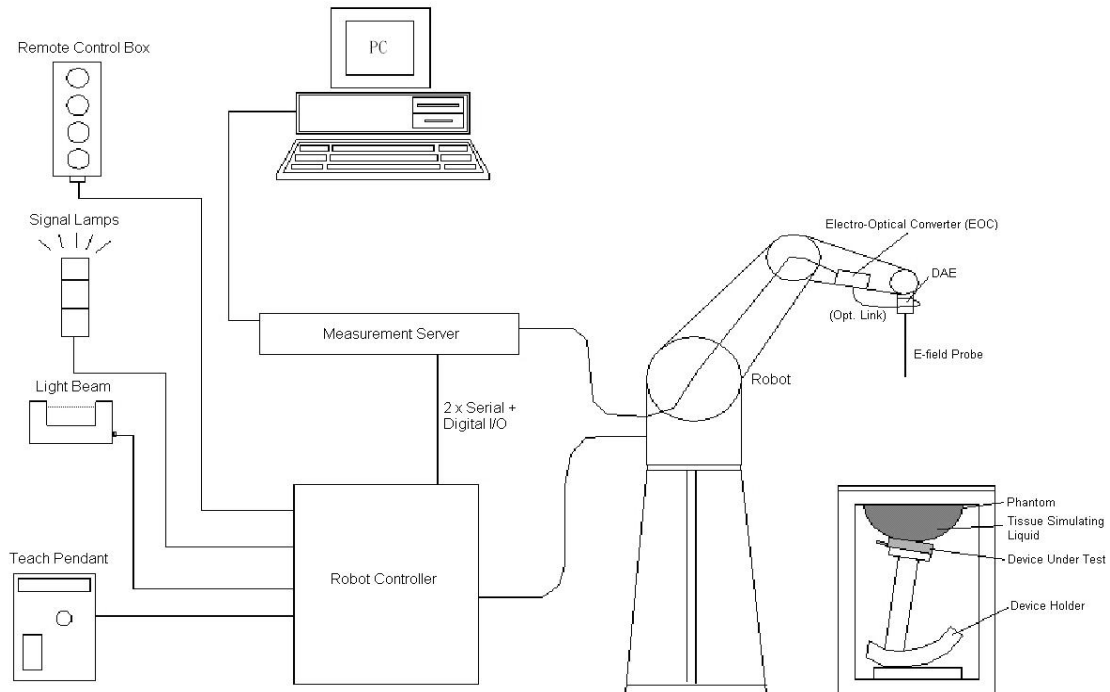

Fig 6.1 SPEAG DASY System Configurations

The DASY system for performance compliance tests is illustrated above graphically. This system consists of the following items:

- A standard high precision 6-axis robot with controller, a teach pendant and software.
- A data acquisition electronic (DAE) attached to the robot arm extension.
- A dosimetric probe equipped with an optical surface detector system.
- The electro-optical converter (ECO) performs the conversion between optical and electrical signals
- A measurement server performs the time critical tasks such as signal filtering, control of the robot operation and fast movement interrupts.
- A probe alignment unit which improves the accuracy of the probe positioning.
- A computer operating Windows XP.
- DASY software.
- Remote control with teach pendant and additional circuitry for robot safety such as warning lamps, etc.
- The SAM twin phantom.
- A device holder.
- Tissue simulating liquid.
- Dipole for evaluating the proper functioning of the system.
- Some of the components are described in details in the following sub-sections.

6.1. E-Field Probe

The SAR measurement is conducted with the dosimetric probe (manufactured by SPEAG). The probe is specially designed and calibrated for use in liquid with high permittivity. The dosimetric probe has special calibration in liquid at different frequency. This probe has a built in optical surface detection system to prevent from collision with phantom.

E-Field Probe Specification <ES3DV3 Probe>

Construction	Symmetrical design with triangular core Built-in optical fiber for surface detection system. Built-in shielding against static charges. PEEK enclosure material (resistant to organic solvents, e.g., DGBE)	
Frequency	10 MHz to 3 GHz; Linearity: ± 0.2 dB	
Directivity	± 0.2 dB in HSL (rotation around probe axis) ± 0.4 dB in HSL (rotation normal to probe axis)	
Dynamic Range	5 μ W/g to 100 mW/g; Linearity: ± 0.2 dB	
Dimensions	Overall length: 330 mm (Tip: 16 mm) Tip diameter: 6.8 mm (Body: 12 mm) Distance from probe tip to dipole centers: 2.7 mm	

Fig 6.2 Photo of ES3DV3

<EX3DV4 Probe>

Construction	Symmetrical design with triangular core Built-in shielding against static charges PEEK enclosure material (resistant to organic solvents, e.g., DGBE)	
Frequency	10 MHz to 6 GHz; Linearity: ± 0.2 dB	
Directivity	± 0.3 dB in HSL (rotation around probe axis) ± 0.5 dB in tissue material (rotation normal to probe axis)	
Dynamic Range	10 μ W/g to 100 mW/g; Linearity: ± 0.2 dB	
Dimensions	Overall length: 330 mm (Tip: 20 mm) Tip diameter: 2.5 mm (Body: 12 mm) Typical distance from probe tip to dipole centers: 1 mm	

Fig 6.3 Photo of EX3DV4

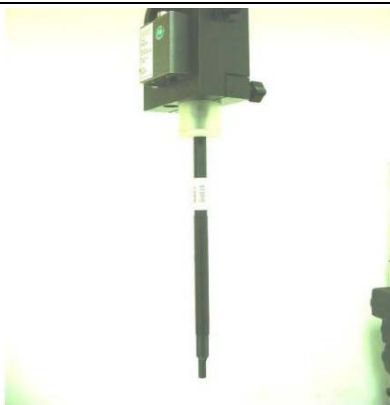
E-Field Probe Calibration

Each probe needs to be calibrated according to a dosimetric assessment procedure with accuracy better than $\pm 10\%$. The spherical isotropy shall be evaluated and within ± 0.25 dB. The sensitivity parameters (NormX, NormY, and NormZ), the diode compression parameter (DCP) and the conversion factor (ConvF) of the probe are tested. The calibration data can be referred to appendix C of this report.

6.2. Data Acquisition Electronics (DAE)

The data acquisition electronics(DAE) consists of a highly sensitive electrometer-grade preamplifier with auto-zeroing, a channel and gain-switching multiplexer, a fast16 bit AD-converter and a command decoder and control logic unit. AD-converter and a command decoder and control logic unit. Transmission to the measurement server is accomplished through an optical downlink for data and status information as well as an optical uplink for commands and the clock. The input impedance of the DAE is 200M Ω ; the inputs are symmetrical and floating. Common mode rejection is above 80 dB.



Fig 6.4 Photo of DAE

6.3. Robot

The SPEAG DASY system uses the high precision robots (DASY4: RX90BL; DASY5: TX90XL) type from Stäubli SA (France). For the 6-axis controller system, the robot controller version (DASY4: CS7MB; DASY5: CS8c) from Stäubli is used. The Stäubli robot series have many features that are important for our application:

High precision (repeatability ± 0.035 mm)

High reliability (industrial design)

Jerk-free straight movements

Low ELF interference (the closed metallic construction shields against motor control fields)



Fig 6.5 Photo of DASY5

6.4. Measurement Server

The measurement server is based on a PC/104 CPU board with CPU (DASY4: 166 MHz, Intel Pentium; DASY5: 400 MHz, Intel Celeron), chip disk (DASY4: 32 MB; DASY5: 128 MB), RAM (DASY4: 64 MB, DASY5: 128 MB). The necessary circuits for communication with the DAE electronic box, as well as the 16 bit AD converter system for optical detection and digital I/O interface are contained on the DASY I/O board, which is directly connected to the PC/104 bus of the CPU board.

The measurement server performs all the real-time data evaluation for field measurements and surface detection, controls robot movements and handles safety operations.



Fig 6.6 Photo of Server for DASY5

6.5. Light Beam Unit

The light beam switch allows automatic "tooling" of the probe. During the process, the actual position of the probe tip with respect to the robot arm is measured, as well as the probe length and the horizontal probe offset. The software then corrects all movements, such that the robot coordinates are valid for the probe tip.

The repeatability of this process is better than 0.1 mm. If a position has been taught with an aligned probe, the same position will be reached with another aligned probe within 0.1 mm, even if the other probe has different dimensions. During probe rotations, the probe tip will keep its actual position.



Fig. 6.7 Photo of Light Beam

6.6. Phantom

<SAM Twin Phantom>

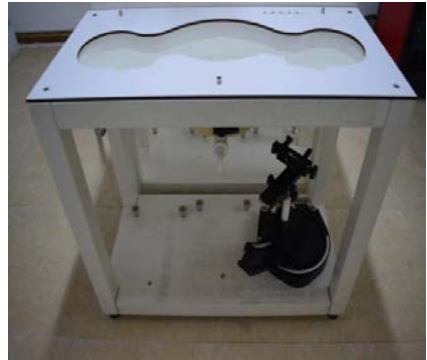
Shell Thickness	2 ± 0.2 mm (sagging: <1%) Center ear point: 6 ± 0.2 mm	
Filling Volume	Approx. 25 liters	
Dimensions	Length: 1000 mm; Width: 500 mm; Height: adjustable feet	
Measurement Areas	Left Hand, Right Hand, Flat Phantom	Fig 6.8 Photo of SAM Phantom

The bottom plate contains three pair of bolts for locking the device holder. The device holder positions are adjusted to the standard measurement positions in the three sections. A white cover is provided to tap the phantom during off-periods to prevent water evaporation and changes in the liquid parameters. On the phantom top, three reference markers are provided to identify the phantom position with respect to the robot.

6.7. Device Holder

<Device Holder for SAM Twin Phantom>

The SAR in the phantom is approximately inversely proportional to the square of the distance between the source and the liquid surface. For a source at 5 mm distance, a positioning uncertainty of ± 0.5 mm would produce a SAR uncertainty of ± 20 %. Accurate device positioning is therefore crucial for accurate and repeatable measurements. The positions in which the devices must be measured are defined by the standards.

The DASY device holder is designed to cope with different positions given in the standard. It has two scales for the device rotation (with respect to the body axis) and the device inclination (with respect to the line between the ear reference points). The rotation center for both scales is the ear reference point (EPR). Thus the device needs no repositioning when changing the angles.

The DASY device holder is constructed of low-loss POM material having the following dielectric parameters: relative permittivity $\epsilon = 3$ and loss tangent $\delta = 0.02$. The amount of dielectric material has been reduced in the closest vicinity of the device, since measurements have suggested that the influence of the clamp on the test results could thus be lowered.



Fig 6.9 Device Holder

<Laptop Extension Kit>

The extension is lightweight and made of POM, acrylic glass and foam. It fits easily on the upper part of the mounting device in place of the phone positioned. The extension is fully compatible with the SAM Twin and ELI phantoms.

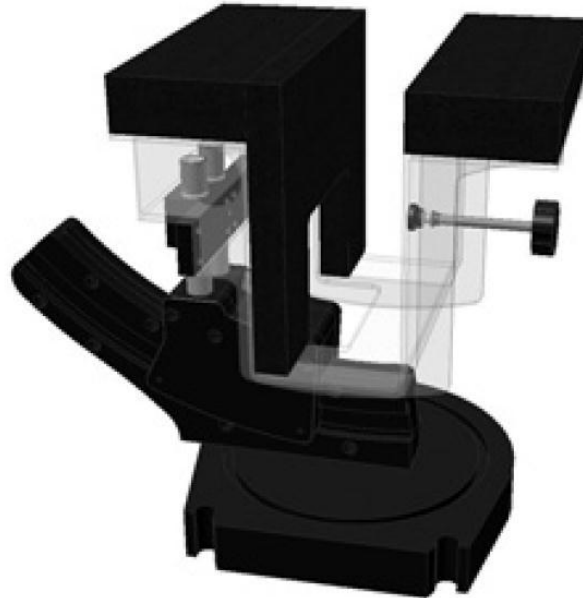

Fig 6.10 Laptop Extension Kit

6.8. Data Storage and Evaluation

➤ Data Storage

The DASY software stores the assessed data from the data acquisition electronics as raw data (in microvolt readings from the probe sensors), together with all the necessary software parameters for the data evaluation (probe calibration data, liquid parameters and device frequency and modulation data) in measurement files. The post-processing software evaluates the desired unit and format for output each time the data is visualized or exported. This allows verification of the complete software setup even after the measurement and allows correction of erroneous parameter settings. For example, if a measurement has been performed with an incorrect crest factor parameter in the device setup, the parameter can be corrected afterwards and the data can be reevaluated.

The measured data can be visualized or exported in different units or formats, depending on the selected probe type (e.g., [V/m], [A/m], [mW/g]). Some of these units are not available in certain situations or give meaningless results, e.g., a SAR-output in a non-loss media, will always be zero. Raw data can also be exported to perform the evaluation with other software packages.

➤ **Data Evaluation**

The DASY post-processing software (SEMCAD) automatically executes the following procedures to calculate the field units from the microvolt readings at the probe connector. The parameters used in the evaluation are stored in the configuration modules of the software.

Probe parameters:	- Sensitivity	Norm _i , a _{i0} , a _{i1} , a _{i2}
	- Conversion factor	ConvF _i
	- Diode compression point	dcpi
Device parameters:	- Frequency	f
	- Crest factor	cf
Media parameters:	- Conductivity	σ
	- Density	ρ

These parameters must be set correctly in the software. They can be found in the component documents or they can be imported into the software from the configuration files issued for the DASY components. In the direct measuring mode of the multi-meter option, the parameters of the actual system setup are used. In the scan visualization and export modes, the parameters stored in the corresponding document files are used.

The first step of the evaluation is a linearization of the filtered input signal to account for the compression characteristics of the detector diode. The compensation depends on the input signal, the diode type and the DC-transmission factor from the diode to the evaluation electronics. If the exciting field is pulsed, the crest factor of the signal must be known to correctly compensate for peak power.

The formula for each channel can be given as:

$$V_i = U_i + U_i^2 \times \frac{cf}{dcp_i}$$

With
 V_i = compensated signal of channel i, (i = x, y, z)
 U_i = input signal of channel i, (i = x, y, z)
 cf = crest factor of exciting field (DASY parameter)
 dcp_i = diode compression point (DASY parameter)

From the compensated input signals, the primary field data for each channel can be evaluated:

$$\text{E-field Probes: } E_i = \sqrt{\frac{V_i}{\text{Norm}_i \times \text{ConvF}}}$$

$$\text{H-field Probes: } H_i = \sqrt{V_i} \times \frac{a_{i0} + a_{i1} + a_{i2}f^2}{f}$$



With V_i = compensated signal of channel i , ($i = x, y, z$)
Norm $_i$ = sensor sensitivity of channel i , ($i = x, y, z$), $\mu V/(V/m)^2$ for E-field
Probes ConvF = sensitivity enhancement in solution
 a_{ij} = sensor sensitivity factors for H-field probes
 f = carrier frequency [GHz]
 E_i = electric field strength of channel i in V/m
 H_i = magnetic field strength of channel i in A/m

The RSS value of the field components gives the total field strength (Hermitian magnitude):

$$E_{\text{tot}} = \sqrt{E_x^2 + E_y^2 + E_z^2}$$

The primary field data are used to calculate the derived field units.

$$\text{SAR} = E_{\text{tot}}^2 \times \frac{\sigma}{\rho \times 1000}$$

with SAR = local specific absorption rate in mW/g

E_{tot} = total field strength in V/m

σ = conductivity in [mho/m] or [Siemens/m]

ρ = equivalent tissue density in g/cm^3

Note that the density is set to 1, to account for actual head tissue density rather than the density of the tissue simulating liquid.



6.9. Test Equipment List

Manufacturer	Name of Equipment	Type/Model	Serial Number	Calibration	
				Last Cal.	Due Date
SPEAG	750MHz System Validation Kit	D750V3	1173	2018.06.21	2021.06.20
SPEAG	835MHz System Validation Kit	D835V2	4d227	2018.06.22	2021.06.21
SPEAG	1750MHz System Validation Kit	D1750V2	1160	2018.06.25	2021.06.24
SPEAG	1900MHz System Validation Kit	D1900V2	5d221	2018.06.22	2021.06.21
SPEAG	2300MHz System Validation Kit	D2300V2	1107	2020.06.03	2023.06.02
SPEAG	2450MHz System Validation Kit	D2450V2	805	2018.10.26	2021.10.25
SPEAG	2600MHz System Validation Kit	D2600V2	1139	2018.06.25	2021.06.24
SPEAG	5000MHz System Validation Kit	D5GHzV2	1176	2018.11.06	2021.11.05
SPEAG	Dosimetric E-Field Probe	EX3DV4	3823	2020.01.03	2021.01.02
SPEAG	Dosimetric E-Field Probe	ES3DV3	3154	2019.07.16	2020.07.15
SPEAG	Data Acquisition Electronics	DAE4	480	2020.06.02	2021.06.01
SPEAG	Dielectric Assessment KIT	DAK-3.5	1279	2019.11.03	2020.11.02
SPEAG	SAM Twin Phantom 1	QD 000 P40 CB	TP-1471	NCR	NCR
SPEAG	SAM Twin Phantom 2	QD 000 P40 CB	TP-1464	NCR	NCR
SPEAG	Phone Positioner	N/A	N/A	NCR	NCR
R&S	Network Emulator	CMW500	124534	2020.04.01	2021.03.31
Agilent	Network Analyzer	E5071B	MY42404762	2020.04.01	2021.03.31
mini-circuits	Amplifier	ZHL-42W+	608501717	NCR	NCR
mini-circuits	Amplifier	ZVE-8G+	754401735	NCR	NCR
Agilent	Signal Generator	N5182B	MY53050509	2020.04.01	2021.03.31
Agilent	Power Sensor	N8482A	MY41090849	2019.10.28	2020.10.27
Agilent	Power Meter	E4416A	MY45102093	2019.10.28	2020.10.27
Anritsu	Power Sensor	MA2411B	N/A	2019.10.28	2020.10.27
Anritsu	Power Meter	NRVD	101066	2019.10.28	2020.10.27
Agilent	Dual Directional Coupler	778D	50422	NA	NA
MCL	Attenuation1	351-218-010	N/A	NA	NA
THERMOMETER	Thermo meter	DC-803	N/A	2020.06.03	2020.09.02
N/A	Tissue Simulating Liquids	700-6000MHz	N/A	24H	

Note:

1. The calibration certificate of DASY can be referred to appendix E of this report.
2. The Insertion Loss calibration of Dual Directional Coupler and Attenuator were characterized



via the network analyzer and compensated during system check.

3. The dielectric probe kit was calibrated via the network analyzer, with the specified procedure (calibrated in pure water) and calibration kit (standard) short circuit, before the dielectric measurement. The specific procedure and calibration kit are provided by Speag.
4. In system check we need to monitor the level on the power meter, and adjust the power amplifier level to have precise power level to the dipole; the measured SAR will be normalized to 1W input power according to the ratio of 1W to the input power to the dipole. For system check, the calibration of the power amplifier is deemed not critically required for correct measurement; the power meter is critical and we do have calibration for it.
5. Attenuator insertion loss is calibrated by the network Analyzer, which the calibration is valid, before system check.
6. N.C.R means No Calibration Requirement.

7. Tissue Simulating Liquids

For SAR measurement of the field distribution inside the phantom, the phantom must be filled with homogeneous tissue simulating liquid to a depth of at least 15cm. For head SAR testing, the liquid height from the ear reference point (ERP) of the phantom to the liquid top surface is larger than 15cm. For body SAR testing, the liquid height from the center of the flat phantom to the liquid top surface is larger than 15cm, which is shown in Fig. 7.1. For body SAR testing, the liquid height from the center of the flat phantom to the liquid top surface is larger than 15 cm, which is shown in Fig. 7.2. The nominal dielectric values of the tissue simulating liquids in the phantom and the tolerance of 5% are listed in below table.

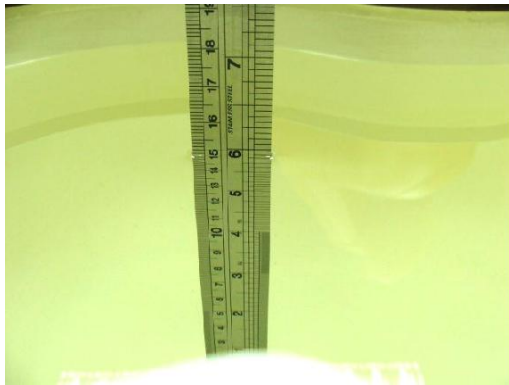

Fig 7.1 Photo of Liquid Height for Head SAR



Fig 7.2 Photo of Liquid Height for Body SAR

The following table gives the recipes for tissue simulating liquids.

Frequency (MHz)	Water (%)	Sugar (%)	Cellulose (%)	Salt (%)	Preventol (%)	DGBE (%)	Conductivity (σ)	Permittivity (ϵ_r)
Head								
750	41.1	57.0	0.2	1.4	0.2	0	0.89	41.9
835	40.3	57.9	0.2	1.4	0.2	0	0.90	41.5
1800, 1900, 2000	55.2	0	0	0.3	0	44.5	1.40	40.0
2450	55.0	0	0	0	0	45.0	1.80	39.2
2600	54.8	0	0	0.1	0	45.1	1.96	39.0
Body								
750	51.7	47.2	0	0.9	0.1	0	0.96	55.5
835	50.8	48.2	0	0.9	0.1	0	0.97	55.2
1800, 1900, 2000	70.2	0	0	0.4	0	29.4	1.52	53.3
2450	68.6	0	0	0	0	31.4	1.95	52.7
2600	68.1	0	0	0.1	0	31.8	2.16	52.5

Simulating Liquid for 5GHz, Manufactured by SPEAG.

Ingredients	(% by weight)
Water	64~78%
Mineral oil	11~18%
Emulsifiers	9~15%
Additives and Salt	2~3%

Note: Please refer to the validation results for dielectric parameters of each frequency band.



The dielectric properties of the tissue simulating liquids were verified prior to the SAR evaluation using an Agilent 85033E Dielectric Probe Kit and an Agilent Network Analyzer.

Table 1: Dielectric Performance of Tissue Simulating Liquid

Frequency (MHz)	Tissue Type	Liquid Temp. (°C)	Conductivity (σ)	Conductivity Target (σ)	Delta (σ) (%)	Limit (%)	Date
750	HSL	22.1	0.929	0.89	4.38	±5	2020.07.14
835	HSL	22.1	0.942	0.90	4.67	±5	2020.08.05
1750	HSL	22.2	1.433	1.37	4.60	±5	2020.08.05
1900	HSL	22.1	1.357	1.40	-3.07	±5	2020.07.29
2300	HSL	22.4	1.640	1.67	-1.80	±5	2020.07.31
2450	HSL	22.3	1.816	1.80	0.89	±5	2020.08.06
2600	HSL	22.1	1.988	1.96	1.43	±5	2020.08.10
5250	HSL	22.1	4.532	4.71	-3.78	±5	2020.07.15
5600	HSL	22.2	4.877	5.07	-3.81	±5	2020.07.17
5750	HSL	22.1	5.030	5.22	-3.64	±5	2020.07.18
Frequency (MHz)	Tissue Type	Liquid Temp. (°C)	Permittivity (ε _r)	Permittivity Target (ε _r)	Delta (ε _r) (%)	Limit (%)	Date
750	HSL	22.1	42.139	41.90	0.57	±5	2020.07.14
835	HSL	22.1	42.881	41.50	3.33	±5	2020.08.05
1750	HSL	22.2	39.532	40.10	-1.42	±5	2020.08.05
1900	HSL	22.1	39.745	40.00	-0.64	±5	2020.07.29
2300	HSL	22.4	39.251	39.50	-0.63	±5	2020.07.31
2450	HSL	22.3	38.802	39.20	-1.02	±5	2020.08.06
2600	HSL	22.1	38.293	39.00	-1.81	±5	2020.08.10
5250	HSL	22.1	34.968	35.95	-2.73	±5	2020.07.15
5600	HSL	22.2	34.502	35.50	-2.81	±5	2020.07.17
5750	HSL	22.1	34.288	35.35	-3.00	±5	2020.07.18



8. SAR System Verification

Each DASY system is equipped with one or more system validation kits. These units, together with the predefined measurement procedures within the DASY software, enable the user to conduct the system performance check and system validation. System validation kit includes a dipole, tripod holder to fix it underneath the flat phantom and a corresponding distance holder.

8.1. Purpose of System Performance check

The system performance check verifies that the system operates within its specifications. System and operator errors can be detected and corrected. It is recommended that the system performance check be performed prior to any usage of the system in order to guarantee reproducible results. The system performance check uses normal SAR measurements in a simplified setup with a well characterized source. This setup was selected to give a high sensitivity to all parameters that might fail or vary over time. The system check does not intend to replace the calibration of the components, but indicates situations where the system uncertainty is exceeded due to drift or failure.

8.2. System Setup

The output power on dipole port must be calibrated to 24 dBm (250 mW) before dipole is connected. In the simplified setup for system evaluation, the DUT is replaced by a calibrated dipole and the power source is replaced by a continuous wave which comes from a signal generator. The calibrated dipole must be placed beneath the flat phantom section of the SAM twin phantom with the correct distance holder. The distance holder should touch the phantom surface with a light pressure at the reference marking and be oriented parallel to the long side of the phantom. The system check verifies that the system operates within its specifications. It is performed daily or before every SAR measurement. The system check uses normal SAR measurements in the flat section of the phantom with a matched dipole at a specified distance. The system verification setup is shown as below.



Fig 8.1 Photo of Dipole Setup

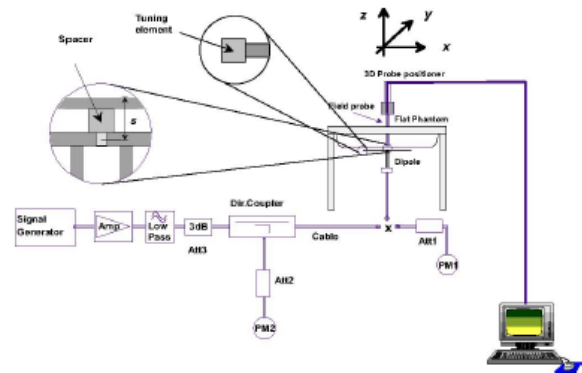

Fig 8.2 System Setup for System Evaluation

8.3. Validation Results

After system check testing, the SAR result will be normalized to 1W forward input power and compared with the reference SAR value derived from validation dipole certificate report. The deviation of system check should be within 10 %.

<Validation Setup>

Frequency (MHz)	Tissue Type	Input Power (mW)	Dipole S/N	Probe S/N	DAE S/N
750	HSL	250	D750V3-1173	3154	480
835	HSL	250	D835V2-4d227	3823	480
1750	HSL	250	D1750V2-1160	3823	480
1900	HSL	250	D1900V2-5d221	3823	480
2300	HSL	250	D2300V2-1107	3823	480
2450	HSL	250	D2450V2-805	3823	480
2600	HSL	250	D2600V2-1139	3823	480
5250	HSL	100	D5GHzV2-1176-5250	3823	480
5600	HSL	100	D5GHzV2-1176-5600	3823	480
5750	HSL	100	D5GHzV2-1176-5750	3823	480



<Validation Results>

Date	Frequency (MHz)	Tissue Type	Input Power (mW)	Measured 1g SAR (W/kg)	Targeted 1g SAR (W/kg)	Normalized 1g SAR (W/kg)	Deviation (%)
2020.07.14	750	HSL	250	2.13	8.26	8.52	3.15
2020.08.05	835	HSL	250	2.39	9.34	9.56	2.36
2020.08.05	1750	HSL	250	9.42	37.10	37.68	1.56
2020.07.29	1900	HSL	250	9.97	39.50	39.88	0.96
2020.07.31	2300	HSL	250	11.81	48.40	47.24	-2.40
2020.08.06	2450	HSL	250	13.40	52.00	53.6	3.08
2020.08.10	2600	HSL	250	13.89	54.00	55.56	2.89
2020.07.15	5250	HSL	100	7.86	78.90	78.6	-0.38
2020.07.17	5600	HSL	100	7.97	80.90	79.7	-1.48
2020.07.18	5750	HSL	100	8.04	80.00	80.4	0.50

Date	Frequency (MHz)	Tissue Type	Input Power (mW)	Measured 10g SAR (W/kg)	Targeted 10g SAR (W/kg)	Normalized 10g SAR (W/kg)	Deviation (%)
2020.07.14	750	HSL	250	1.41	5.45	5.64	3.49
2020.08.05	835	HSL	250	1.57	6.07	6.28	3.46
2020.08.05	1750	HSL	250	4.94	20.00	19.76	-1.20
2020.07.29	1900	HSL	250	5.18	20.60	20.72	0.58
2020.07.31	2300	HSL	250	5.73	23.00	22.92	-0.35
2020.08.06	2450	HSL	250	6.18	24.10	24.72	2.57
2020.08.10	2600	HSL	250	6.25	24.50	25	2.04
2020.07.15	5250	HSL	100	2.19	22.50	21.9	-2.67
2020.07.17	5600	HSL	100	2.27	23.10	22.7	-1.73
2020.07.18	5750	HSL	100	2.29	22.60	22.9	1.33

Note: System checks the specific test data please see Annex C.

9. EUT Testing Position

This EUT was tested in six different positions. They are right cheek/right tilted/left cheek/left tilted for head, Front/Back of the EUT with phantom 10 mm gap, as illustrated below, please refer to Appendix B for the test setup photos.

9.1. Handset Reference Points

The vertical centre line passes through two points on the front side of the handset – the midpoint of the width w_t of the handset at the level of the acoustic output, and the midpoint of the width w_b of the bottom of the handset.

The horizontal line is perpendicular to the vertical centre line and passes the center of the acoustic output. The horizontal line is also tangential to the handset at point A.

The two lines intersect at point A. Note that for many handsets, point A coincides with the center of the acoustic output; however, the acoustic output may be located elsewhere on the horizontal line. Also note that the vertical centre line is not necessarily parallel to the front face of the handset, especially for clamshell handsets, handsets with flip covers, and other irregularly shaped handsets.



Fig. 9.1 Illustration for Cheek Position

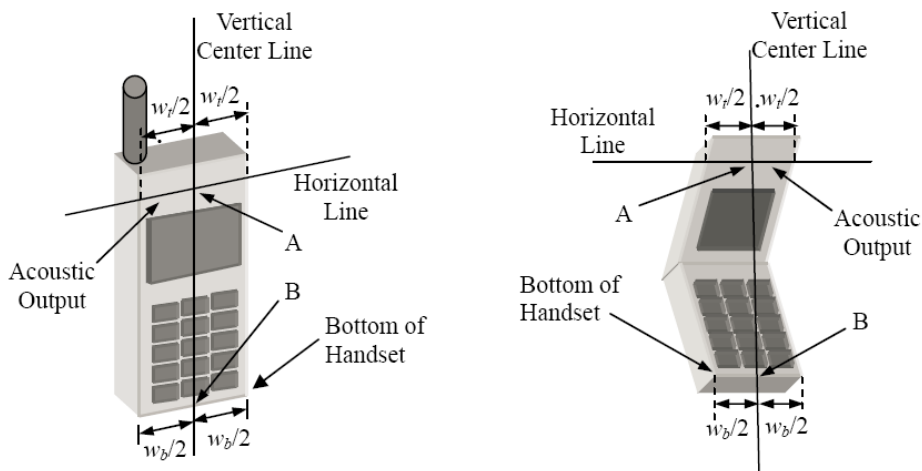

Fig. 9.2 Illustration for Handset Vertical and Horizontal Reference Lines

9.2. Positioning for Cheek / Touch

To position the device with the vertical center line of the body of the device and the horizontal line crossing the center piece in a plane parallel to the sagittal plane of the phantom. While maintaining the device in this plane, align the vertical center line with the reference plane containing the three ear and mouth reference point (M: Mouth, RE: Right Ear and LE: Left Ear) and align the center of the ear piece with the line RE-LE.

To move the device towards the phantom with the ear piece aligned with the line LE-RE until the phone touched the ear. While maintaining the device in the reference plane and maintaining the phone contact with the ear, move the bottom of the phone until any point on the front side is in contact with the cheek of the phantom or until contact with the ear is lost (see below figure)

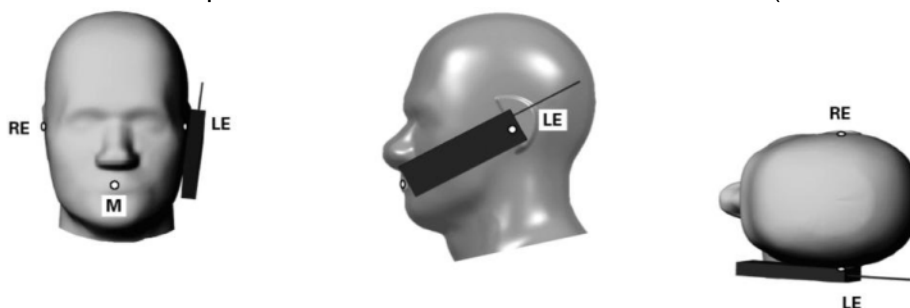

Fig 9.3 Illustration for Cheek Position

9.3. Positioning for Ear / 15° Tilt

To position the device in the “cheek” position described above.

While maintaining the device the reference plane described above and pivoting against the ear, moves it outward away from the mouth by an angle of 15 degrees or until contact with the ear is lost (see figure below).

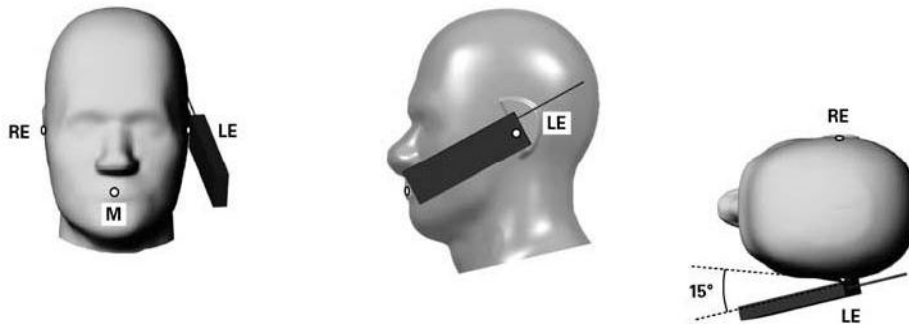

Fig 9.4 Illustration for Tilted Position

9.4. SAR Evaluations near the Mouth/Jaw Regions of the SAM Phantom

Antennas located near the bottom of a phone may require SAR measurements around the mouth and jaw regions of the SAM head phantom. This typically applies to clam-shell style phones that are generally longer in the unfolded normal use positions or to certain older style long rectangular phones.

Under these circumstances, the following procedures apply, adopted from the FCC guidance on SAR handsets document FCC KDB Publication 648474 D04v01r03. The SAR required in these regions of SAM should be measured using a flat phantom. The phone should be positioned with a separation distance of 4 mm between the ear reference point (ERP) and the outer surface of the flat phantom shell. While maintaining this distance at the ERP location, the low (bottom) edge of the phone should be lowered from the phantom to establish the same separation distance between the peak SAR locations identified by the truncated partial SAR distribution measured with the SAM phantom. The distance from the peak SAR location to the phone is determined by the straight line passing perpendicularly through the phantom surface. When it is not feasible to maintain 4 mm separation at the ERP while also establishing the required separation at the peak SAR location, the top edge of the phone will be allowed to touch the phantom with a separation < 4 mm at the ERP. The phone should not be tilted to the left or right while placed in this inclined position to the flat phantom.

9.5. Body-worn Configurations

The body-worn configurations shall be tested with the supplied accessories (belt-clips, holsters, etc.) attached to the device in normal use configuration.

For body-worn and other configurations a flat phantom shall be used which is comprised of material with electrical properties similar to the corresponding tissues.

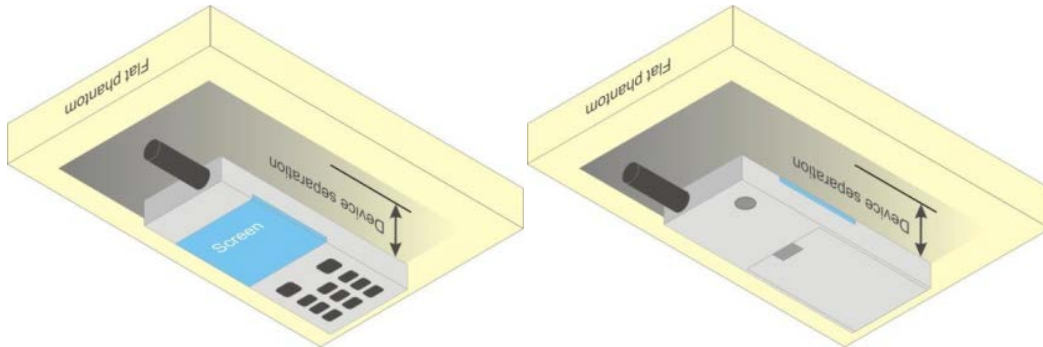

Fig 9.5 Illustration for Body Worn Position

9.6. Hotspot Mode Exposure Position Conditions

For handsets that support hotspot mode operations, with wireless router capabilities and various web browsing functions, the relevant hand and body exposure conditions are tested according to the hotspot SAR procedures in KDB 941225. A test separation distance of 10 mm is required between the phantom and all surfaces and edges with a transmitting antenna located within 25 mm from that surface or edge. When the form factor of a handset is smaller than 9 cm x 5 cm, a test separation distance of 5 mm (instead of 10 mm) is required for testing hotspot mode. When the separation distance required for body-worn accessory testing is larger than or equal to that tested for hotspot mode, in the same wireless mode and for the same surface of the phone, the hotspot mode SAR data may be used to support body-worn accessory SAR compliance for that particular configuration (surface).

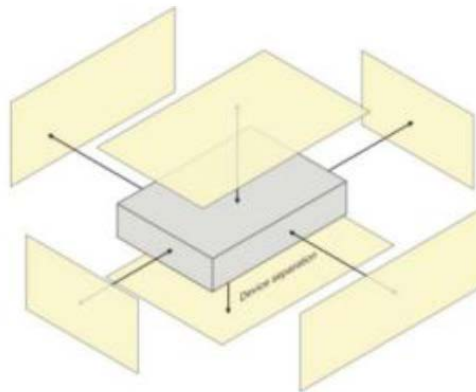

Fig 9.6 Illustration for Hotspot Position

10. Measurement Procedures

The measurement procedures are as follows:

<Conducted power measurement>

- (a) For WWAN power measurement, use base station simulator to configure EUT WWAN transmission in conducted connection with RF cable, at maximum power in each supported wireless interface and frequency band.
- (b) Read the WWAN RF power level from the base station simulator.
- (c) For WLAN/BT power measurement, use engineering software to configure EUT WLAN/BT continuously transmission, at maximum RF power in each supported wireless interface and frequency band.
- (d) Connect EUT RF port through RF cable to the power meter, and measure WLAN/BT output power.

<SAR measurement>

- (a) Use base station simulator to configure EUT WWAN transmission in radiated connection, and engineering software to configure EUT WLAN/BT continuously transmission, at maximum RF power, in the highest power channel.
- (b) Place the EUT in the positions as Appendix D demonstrates.
- (c) Set scan area, grid size and other setting on the DASY software.
- (d) Measure SAR results for the highest power channel on each testing position.
- (e) Find out the largest SAR result on these testing positions of each band.
- (f) Measure SAR results for other channels in worst SAR testing position if the reported SAR of highest power channel is larger than 0.8 W/kg.

According to the test standard, the recommended procedure for assessing the peak spatial-average SAR value consists of the following steps:

- (a) Power reference measurement.
- (b) Area scan.
- (c) Zoom scan.
- (d) Power drift measurement.

10.1. Spatial Peak SAR Evaluation

The procedure for spatial peak SAR evaluation has been implemented according to the test standard. It can be conducted for 1g and 10g, as well as for user-specific masses. The DASY software includes all numerical procedures necessary to evaluate the spatial peak SAR value. The base for the evaluation is a "cube" measurement. The measured volume must include the 1g and 10g cubes with the highest averaged SAR values. For that purpose, the center of the measured volume is aligned to the interpolated peak SAR value of a previously performed area



scan.

The entire evaluation of the spatial peak values is performed within the post-processing engine (SEMCAD). The system always gives the maximum values for the 1g and 10g cubes. The algorithm to find the cube with highest averaged SAR is divided into the following stages:

- (a) Extraction of the measured data (grid and values) from the Zoom Scan.
- (b) Calculation of the SAR value at every measurement point based on all stored data (A/D values and measurement parameters).
- (c) Generation of a high-resolution mesh within the measured volume.
- (d) Interpolation of all measured values from the measurement grid to the high-resolution grid.
- (e) Extrapolation of the entire 3-D field distribution to the phantom surface over the distance from sensor to surface.
- (f) Calculation of the averaged SAR within masses of 1g and 10g.

10.2. Power Reference Measurement

The Power Reference Measurement and Power Drift Measurements are for monitoring the power drift of the device under test in the batch process. The minimum distance of probe sensors to surface determines the closest measurement point to phantom surface. This distance cannot be smaller than the distance of sensor calibration points to probe tip as defined in the probe properties.

10.3. Area Scan Procedures

Area scans are defined prior to the measurement process being executed with a user defined variable spacing between each measurement point (integral) allowing low uncertainty measurements to be conducted. Scans defined for FCC applications utilize a 10mm² step integral, with 1mm interpolation used to locate the peak SAR area used for zoom scan assessments.

When an Area Scan has measured all reachable points, it computes the field maxima founding the scanned area, within a range of the global maximum. The range (in dB) is specified in the standards for compliance testing. For example, a 2 dB range is required in IEEE1528-2003.



10.4. Zoom Scan Procedures

Zoom Scans are used to assess the peak spatial SAR values within a cubic averaging volume containing 1 g and 10 g of simulated tissue. A density of 1000 kg/m³ is used to represent the head and body tissue density and not the phantom liquid density, in order to be consistent with the definition of the liquid dielectric properties, i.e. the side length of the 1g cube is 10mm, with the side length of the 10 g cube 21,5mm. The zoom scan integer steps can be user defined so as to reduce uncertainty, but normal practice for typical test applications utilize a physical step of 5x5x7 (8mmx8mmx5mm) providing a volume of 32mm in the X & Y axis, and 30mm in the Z axis.

10.5. SAR Averaged Methods

In DASy, the interpolation and extrapolation are both based on the modified Quadratic Sheppard's method. The interpolation scheme combines a least-square fitted function method and a weighted average method which are the two basic types of computational interpolation and approximation.

Extrapolation routines are used to obtain SAR values between the lowest measurement points and the inner phantom surface. The extrapolation distance is determined by the surface detection distance and the probe sensor offset. The uncertainty increases with the extrapolation distance. To keep the uncertainty within 1% for the 1 g and 10 g cubes, the extrapolation distance should not be larger than 5 mm.

10.6. Power Drift Monitoring

All SAR testing is under the DUT install full charged battery and transmit maximum output power. In DASy measurement software, the power reference measurement and power drift measurement procedures are used for monitoring the power drift of DUT during SAR test. Both these procedures measure the field at a specified reference position before and after the SAR testing. The software will calculate the field difference in dB. If the power drift more than 5%, the SAR will be retested.

11. SAR Test Procedure

11.1. General Scan Requirements

Probe boundary effect error compensation is required for measurements with the probe tip closer than half a probe tip diameter to the phantom surface. Both the probe tip diameter and sensor offset distance must satisfy measurement protocols; to ensure probe boundary effect errors are minimized and the higher fields closest to the phantom surface can be correctly measured and extrapolated to the phantom surface for computing 1-g SAR. Tolerances of the post-processing algorithms must be verified by the test laboratory for the scan resolutions used in the SAR measurements, according to the reference distribution functions specified in IEEE Std. 1528-2013.

		≤ 3 GHz	> 3 GHz
Maximum distance from closest measurement point (geometric center of probe sensors) to phantom surface		5 mm \pm 1 mm	$\frac{1}{2} \cdot \delta \cdot \ln(2)$ mm \pm 0.5 mm
Maximum probe angle from probe axis to phantom surface normal at the measurement location		$30^\circ \pm 1^\circ$	$20^\circ \pm 1^\circ$
Maximum area scan spatial resolution: Δx_{Area} , Δy_{Area}		≤ 2 GHz: ≤ 15 mm 2 – 3 GHz: ≤ 12 mm	3 – 4 GHz: ≤ 12 mm 4 – 6 GHz: ≤ 10 mm
		When the x or y dimension of the test device, in the measurement plane orientation, is smaller than the above, the measurement resolution must be \leq the corresponding x or y dimension of the test device with at least one measurement point on the test device.	
Maximum zoom scan spatial resolution: Δx_{Zoom} , Δy_{Zoom}		≤ 2 GHz: ≤ 8 mm 2 – 3 GHz: ≤ 5 mm*	3 – 4 GHz: ≤ 5 mm* 4 – 6 GHz: ≤ 4 mm*
Maximum zoom scan spatial resolution, normal to phantom surface	uniform grid: $\Delta z_{Zoom}(n)$	≤ 5 mm	3 – 4 GHz: ≤ 4 mm 4 – 5 GHz: ≤ 3 mm 5 – 6 GHz: ≤ 2 mm
	graded grid $\Delta z_{Zoom}(1)$: between 1 st two points closest to phantom surface	≤ 4 mm	3 – 4 GHz: ≤ 3 mm 4 – 5 GHz: ≤ 2.5 mm 5 – 6 GHz: ≤ 2 mm
	$\Delta z_{Zoom}(n>1)$: between subsequent points	$\leq 1.5 \cdot \Delta z_{Zoom}(n-1)$ mm	
Minimum zoom scan volume	x, y, z	≥ 30 mm	3 – 4 GHz: ≥ 28 mm 4 – 5 GHz: ≥ 25 mm 5 – 6 GHz: ≥ 22 mm
Note: δ is the penetration depth of a plane-wave at normal incidence to the tissue medium; see IEEE Std 1528-2013 for details.			
* When zoom scan is required and the <i>reported</i> SAR from the <i>area scan based 1-g SAR estimation</i> procedures of KDB Publication 447498 is ≤ 1.4 W/kg, ≤ 8 mm, ≤ 7 mm and ≤ 5 mm zoom scan resolution may be applied, respectively, for 2 GHz to 3 GHz, 3 GHz to 4 GHz and 4 GHz to 6 GHz.			



11.2. Test Procedure

The Following steps are used for each test position

1. Establish a call with the maximum output power with a base station simulator. The connection between the mobile and the base station simulator is established via air interface.
2. Measurement of the local E-field value at a fixed location. This value serves as a reference value for calculating a possible power drift.
3. Measurement of the SAR distribution with a grid of 8 to 16mm * 8 to 16 mm and a constant distance to the inner surface of the phantom. Since the sensors cannot directly measure at the inner phantom surface, the values between the sensors and the inner phantom surface are extrapolated. With these values the area of the maximum SAR is calculated by an interpolation scheme.
4. Around this point, a cube of 30 * 30 * 30 mm or 32 * 32 * 32 mm is assessed by measuring 5 or 8 * 5 or 8*4 or 5 mm. With these data, the peak spatial-average SAR value can be calculated.

11.3. Description of Interpolation/Extrapolation Scheme

The local SAR inside the phantom is measured using small dipole sensing elements inside a probe body. The probe tip must not be in contact with the phantom surface in order to minimize measurements errors, but the highest local SAR will occur at the surface of the phantom.

An extrapolation is using to determinate this highest local SAR values. The extrapolation is based on a fourth-order least-square polynomial fit of measured data. The local SAR value is then extrapolated from the liquid surface with a 1mm step.

The measurements have to be performed over a limited time (due to the duration of the battery) so the step of measurement is high. It could vary between 5 and 8 mm. To obtain an accurate assessment of the maximum SAR averaged over 10 grams and 1 gram requires a very fine resolution in the three dimensional scanned data array.

11.4. Wireless Router

Some battery-operated handsets have the capability to transmit and receive user through simultaneous transmission of WIFI simultaneously with a separate licensed transmitter. The FCC has provided guidance in FCC KDB Publication 941225 D06 v02r01 where SAR test considerations for handsets ($L \times W \geq 9 \text{ cm} \times 5 \text{ cm}$) are based on a composite test separation distance of 10 from the front, back and edges of the device containing transmitting antennas within



2.5cm of their edges, determined from general mixed use conditions for this type of devices. Since the hotspot SAR results may overlap with the body-worn accessory SAR requirements, the more conservative configurations can be considered, thus excluding some body-worn accessory SAR tests.

When the user enables the personal wireless router functions for the handset, actual operations include simultaneous transmission of both the WIFI transmitter and another licensed transmitter. Both transmitters often do not transmit at the same transmitting frequency and thus cannot be evaluated for SAR under actual use conditions due to the limitations of the SAR assessment probes. Therefore, SAR must be evaluated for each frequency transmission and mode separately and spatially summed with the WIFI transmitter according to FCC KDB Publication 447498 D01v06 publication procedures. The "Portable Hotspot" feature on the handset was NOT activated during SAR assessments, to ensure the SAR measurements were evaluated for a single transmission frequency RF signal at a time.



12. SAR Test Configuration

<GSM Mode>

A summary of these settings are illustrated below:

For GSM850 frequency band, the power control is set to 5 for GSM/GPRS mode (GSMK-CS1) and set to 8 for EDGE mode (MCS5); For GSM1900 frequency band, the power control is set to 0 for GSM/GPRS mode (GSMK-CS1) and set to 2 for EDGE mode (MCS5).

1. Per KDB 447498 D01v06, the maximum output power channel is used for SAR testing and for further SAR test reduction.
2. Per KDB 941225 D01v03r01, SAR test reduction for GSM / GPRS / EDGE modes is determined by the source-based time-averaged output power including tune-up tolerance. The mode with highest specified time-averaged output power should be tested for SAR compliance in the applicable exposure conditions. For modes with the same specified maximum output power and tolerance, the higher number time-slot configuration should be tested. Therefore, the GPRS (4Tx slots) for GSM850/GSM1900 is considered as the primary mode.
3. Other configurations of GSM / GPRS / EDGE are considered as secondary modes.

Timeslot consignations:

Remark:

1. The frame-averaged power is linearly reported the maximum burst averaged power over 8 time slots. The calculated method are shown as below:
The duty cycle "x" of different time slots as below:
1 TX slot is 1/8, 2 TX slots is 2/8, 3 TX slots is 3/8 and 4 TX slots is 4/8
Based on the calculation formula:
Frame-averaged power = Burst averaged power + 10 log (x)
So,
Frame-averaged power (1 TX slot) = Burst averaged power (1 TX slot)– 9.03
Frame-averaged power (2 TX slots) = Burst averaged power (2 TX slots)– 6.02
Frame-averaged power (3 TX slots) = Burst averaged power (3 TX slots)– 4.26
Frame-averaged power (4 TX slots) = Burst averaged power (4 TX slots) – 3.01
2. CS1 coding scheme was used in GPRS conducted power measurements and SAR testing, MCS5 coding scheme was used in EGPRS conducted power measurements and SAR testing (if necessary).

No. of Slots:	Slot 1	Slot 2	Slot 3	Slot 4
Slot Consignation:	1Up4Down	2Up3Down	3Up2Down	4Up1Down
Duty Cycle:	1:8.3	1:4.15	1:2.77	1:2.08
Correct Factor:	-9.03dB	-6.02dB	-4.26dB	-3.01dB



<WCDMA Mode>

Summary of UMTS conducted power measurement:

1. The 3G SAR test reduction procedure is applied, when the maximum output power and tune-up tolerance specified for production units in a secondary mode is $\leq \frac{1}{4}$ dB higher than the primary mode, SAR measurement is not required for the secondary mode.
2. The following tests were conducted according to the test requirements outlines in 3GPP TS 34.121 specification.
3. The procedures in KDB 941225 D01v03r01 are applied for 3GPP Rel. 6 HSPA to configure the device in the required sub-test mode(s) to determine SAR test exclusion.
4. For HSPA+ devices supporting 16 QAM in the uplink, power measurements procedure is according to the configurations in Table C.11.1.4 of 3GPP TS 34.121-1.
5. Per KDB 941225 D01v03r01, RMC 12.2kbps setting is used to evaluate SAR. The maximum output power and tune-up tolerance specified for production units in HSDPA / HSUPA / DC-HSDPA / HSPA+ is $\leq \frac{1}{4}$ dB higher than RMC 12.2Kbps or when the highest reported SAR of the RMC12.2Kbps is scaled by the ratio of specified maximum output power and tune-up tolerance of HSDPA / HSUPA / DC-HSDPA / HSPA+ to RMC12.2Kbps and the adjusted SAR is ≤ 1.2 W/kg, SAR measurement is not required for HSDPA / HSUPA / DC-HSDPA / HSPA+, and according to the following RF output power, the output power results of the secondary modes (HSDPA / HSUPA / DC-HSDPA / HSPA+) are less than $\frac{1}{4}$ dB higher than the primary modes; therefore, SAR measurement is not required for HSDPA / HSUPA / DC-HSDPA / HSPA+.
6. A fixed level power reduction is applied for WCDMA Band II when handset open Hotspot mode, the power reduction triggered.

HSDPA Setup Configuration

Sub-test	β_c	β_d	β_d (SF)	β_c/β_d	$\beta_{hr}^{(1)}$	CM (dB) ⁽²⁾
1	2/15	15/15	64	2/15	4/15	0.0
2	12/15 ⁽³⁾	15/15 ⁽³⁾	64	12/15 ⁽³⁾	24/15	1.0
3	15/15	8/15	64	15/8	30/15	1.5
4	15/15	4/15	64	15/4	30/15	1.5

Note 1: $\Delta_{ACK}, \Delta_{NACK}$ and $\Delta_{CQI} = 8 \Leftrightarrow A_{hr} = \beta_{hr}/\beta_c = 30/15 \Leftrightarrow \beta_{hr} = 30/15 * \beta_c$
 Note 2: CM = 1 for $\beta_c/\beta_d = 12/15, \beta_{hr}/\beta_c = 24/15$.
 Note 3: For subtest 2 the β_c/β_d ratio of 12/15 for the TFC during the measurement period (TF1, TF0) is achieved by setting the signaled gain factors for the reference TFC (TF1, TF1) to $\beta_c = 11/15$ and $\beta_d = 15/15$.

HSUPA Setup Configuration

Sub-test	β_c	β_d	β_d (SF)	β_c/β_d	$\beta_{hs}^{(1)}$	β_{ec}	β_{ed}	β_{ed} (SF)	β_{ed} (codes)	CM ⁽²⁾ (dB)	MPR (dB)	AG ⁽⁴⁾ Index	E-TFCI
1	11/15 ⁽³⁾	15/15 ⁽³⁾	64	11/15 ⁽³⁾	22/15	209/225	1039/225	4	1	1.0	0.0	20	75
2	6/15	15/15	64	6/15	12/15	12/15	94/75	4	1	3.0	2.0	12	67
3	15/15	9/15	64	15/9	30/15	30/15	$\beta_{ed1}: 47/15$ $\beta_{ed2}: 47/15$	4	2	2.0	1.0	15	92
4	2/15	15/15	64	2/15	4/15	2/15	56/75	4	1	3.0	2.0	17	71
5	15/15 ⁽⁴⁾	15/15 ⁽⁴⁾	64	15/15 ⁽⁴⁾	30/15	24/15	134/15	4	1	1.0	0.0	21	81

Note 1: $\Delta_{ACK}, \Delta_{NACK}$ and $\Delta_{CQI} = 8 \Leftrightarrow A_{hs} = \beta_{hs}/\beta_c = 30/15 \Leftrightarrow \beta_{hs} = 30/15 * \beta_c$.

Note 2: CM = 1 for $\beta_c/\beta_d = 12/15, \beta_{hs}/\beta_c = 24/15$. For all other combinations of DPDCH, DPCCH, HS-DPCCH, E-DPDCH and E-DPCCH the MPR is based on the relative CM difference.

Note 3: For subtest 1 the β_c/β_d ratio of 11/15 for the TFC during the measurement period (TF1, TF0) is achieved by setting the signaled gain factors for the reference TFC (TF1, TF1) to $\beta_c = 10/15$ and $\beta_d = 15/15$.

Note 4: For subtest 5 the β_c/β_d ratio of 15/15 for the TFC during the measurement period (TF1, TF0) is achieved by setting the signaled gain factors for the reference TFC (TF1, TF1) to $\beta_c = 14/15$ and $\beta_d = 15/15$.

Note 5: Testing UE using E-DPDCH Physical Layer category 1 Sub-test 3 is not required according to TS 25.306 Table 5.1g.

Note 6: β_{ed} cannot be set directly; it is set by Absolute Grant Value.

HSPA+ 3GPP release 7 (uplink category 7) 16QAM, Setup Configuration:
Table C.11.1.4: β values for transmitter characteristics tests with HS-DPCCH and E-DCH with 16QAM

Sub-test	β_c (Note 3)	β_d	β_{hs} (Note 1)	β_{ec}	β_{ed} (2xSF2) (Note 4)	β_{ed} (2xSF4) (Note 4)	CM (dB) (Note 2)	MPR (dB) (Note 2)	AG Index (Note 4)	E-TFCI (Note 5)	E-TFCI (boost)
1	1	0	30/15	30/15	$\beta_{ed1}: 30/15$ $\beta_{ed2}: 30/15$	$\beta_{ed3}: 24/15$ $\beta_{ed4}: 24/15$	3.5	2.5	14	105	105

Note 1: $\Delta_{ACK}, \Delta_{NACK}$ and $\Delta_{CQI} = 30/15$ with $\beta_{hs} = 30/15 * \beta_c$.

Note 2: CM = 3.5 and the MPR is based on the relative CM difference, MPR = MAX(CM-1,0).

Note 3: DPDCH is not configured, therefore the β_c is set to 1 and $\beta_d = 0$ by default.

Note 4: β_{ed} can not be set directly; it is set by Absolute Grant Value.

Note 5: All the sub-tests require the UE to transmit 2SF2+2SF4 16QAM EDCH and they apply for UE using E-DPDCH category 7. E-DCH TTI is set to 2ms TTI and E-DCH table index = 2. To support these E-DCH configurations DPDCH is not allocated. The UE is signaled to use the extrapolation algorithm.

DC-HSDPA Setup Configuration

The following tests were completed according to procedures in section 7.3.13 of 3GPP TS34.108 v9.5.0. A summary of these settings are illustrated below:

Downlink Physical Channels are set as per 3GPP TS34.121-1 v9.0.0 E.5.

Table E.5.0: Levels for HSDPA connection setup

Parameter During Connection setup	Unit	Value
P-CPICH_Ec/Ior	dB	-10
P-CCPCH and SCH_Ec/Ior	dB	-12
PICH_Ec/Ior	dB	-15
HS-PDSCH	dB	off
HS-SCCH_1	dB	off
DPCH_Ec/Ior	dB	-5
OCNS_Ec/Ior	dB	-3.1

Call is set up as per 3GPP TS34.108 v9.5.0 sub clause 7.3.13

The configurations of the fixed reference channels for HSDPA RF tests are described in 3GPP TS 34.121, annex C for FDD and 3GPP TS 34.122.

Table C.8.1.12: Fixed Reference Channel H-Set 12

Parameter	Unit	Value
Nominal Avg. Inf. Bit Rate	kbps	60
Inter-TTI Distance	TTI's	1
Number of HARQ Processes	Processes	6
Information Bit Payload (N_{INF})	Bits	120
Number Code Blocks	Blocks	1
Binary Channel Bits Per TTI	Bits	960
Total Available SML's in UE	SML's	19200
Number of SML's per HARQ Proc.	SML's	3200
Coding Rate		0.15
Number of Physical Channel Codes	Codes	1
Modulation		QPSK
Note 1: The RMC is intended to be used for DC-HSDPA mode and both cells shall transmit with identical parameters as listed in the table. Note 2: Maximum number of transmission is limited to 1, i.e., retransmission is not allowed. The redundancy and constellation version 0 shall be used.		

CCC

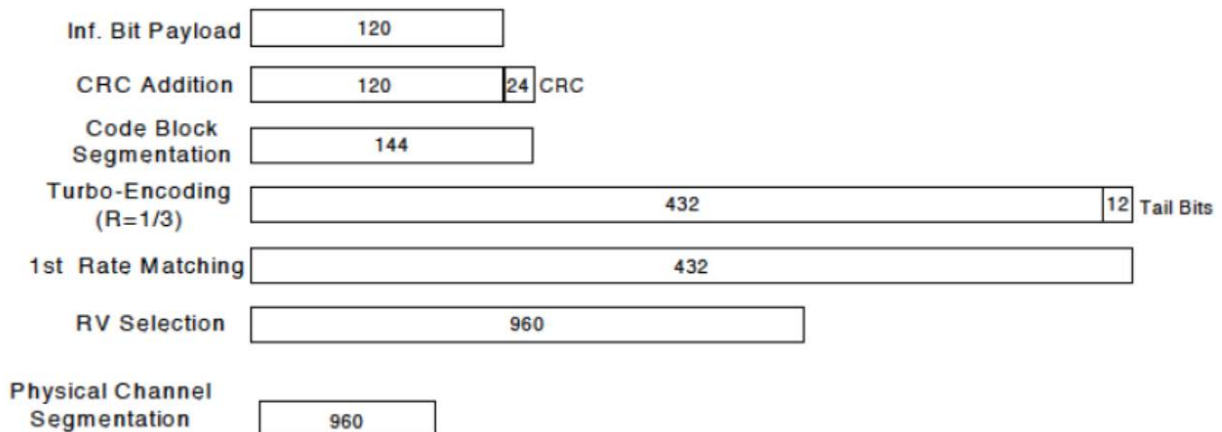
Figure C.8.19: Coding rate for Fixed reference Channel H-Set 12 (QPSK)



<CDMA Mode>

1xEV-DO Rev. B

Call box setup procedure

1xEV-DO Release B

1> CMW 500 Signal Generator > 1xEV-DO Taskbar Enable

2> CMW 500 1xEV-DO Signaling Configuration Window >

3> 1xEV-DO Signaling On Window:

Under Access Network Control:

Band Class: BC0: US Cellular

RF Channel: 31

1xEV-DO Power: -70 dBm

4> 1xEV-DO Signaling Configuration Window

Under RF Frequency Band / Channel: Enter Ch. Frequency

- Under Carrier Configuration: RF Frequency
For Two Carriers: Low Channel (1013)

	<u>RF Channel</u>	<u>RF Channel Offset</u>
Carrier [0]	31	0
Carrier [1]	1013	982

- Under Carrier Configuration: RF Pilot
- | | <u>Carrier Sector</u> | <u>Active on AN</u> | <u>Assigned to AT</u> |
|-----------|-----------------------|---------------------|-----------------------|
| Pilot [0] | C0/S0 | ✓ | ✓ |
| | CA/S1 | ✓ | ✓ |

For Three Carriers: Low Channel (1013)

	<u>RF Channel</u>	<u>RF Channel Offset</u>
Carrier [0]	72	0
Carrier [1]	31	-41
Carrier [2]	1013	941

- Under Carrier Configuration: RF Pilot
- | | <u>Carrier Sector</u> | <u>Active on AN</u> | <u>Assigned to AT</u> |
|-----------|-----------------------|---------------------|-----------------------|
| Pilot [0] | C0/S0 | ✓ | ✓ |
| Pilot [1] | C1/S1 | ✓ | ✓ |
| Pilot [2] | C2/S2 | ✓ | ✓ |



<LTE Mode>

LTE Target MPR level

The device implements maximum power reduction per 3GPP 36.101 requirements where the MPR target is as below table. The MPR settings are implemented configured into firmware and cannot be disabled by the end user or LTE carrier network.

Modulation	Channel bandwidth / Transmission bandwidth configuration [RB]						MPR	3GPP
	1.4	3.0	5	10	15	20	Target	MPR
	MHz	MHz	MHz	MHz	MHz	MHz	(dB)	(dB)
QPSK	> 5	> 4	> 8	> 12	> 16	> 18	1	≤ 1
16 QAM	≤ 5	≤ 4	≤ 8	≤ 12	≤ 16	≤ 18	1	≤ 1
64 QAM	> 5	> 4	> 8	> 12	> 16	> 18	2	≤ 2

Note: The measurement result showed some difference from the target MPR level, due to expected 0.5dB measurement tolerance

LTE Bands

LTE Bands	Channel bandwidth / Transmission bandwidth configuration [RB]					
	1.4	3.0	5	10	15	20
	MHz	MHz	MHz	MHz	MHz	MHz
2	v	v	v	v	v	v
4	v	v	v	v	v	v
5	v	v	v	v	N/A	N/A
12	v	v	v	v	N/A	N/A
13	N/A	N/A	v	v	N/A	N/A
17	N/A	N/A	v	v	N/A	N/A
25	v	v	v	v	v	v
26	v	v	v	v	v	N/A
30	N/A	N/A	v	v	N/A	N/A
41	N/A	N/A	v	v	v	v
66	v	v	v	v	v	v
71	N/A	N/A	v	v	v	v

Note:

1. Per KDB 941225 D05v02r05, when a properly configured base station simulator is used for the SAR and power measurements, spectrum plots for each RB allocation and offset configuration is not required.
2. Per KDB 941225 D05v02r05, start with the largest channel bandwidth and measure SAR for QPSK with 1 RB allocation, using the RB offset and required test channel combination with the highest maximum output power for RB offsets at the upper edge, middle and lower edge of each required test channel.
3. Per KDB 941225 D05v02r05, 50% RB allocation for QPSK SAR testing follows 1RB QPSK



allocation procedure.

4. Per KDB 941225 D05v02r05, for QPSK with 100% RB allocation, SAR is not required when the highest maximum output power for 100 % RB allocation is less than the highest maximum output power in 50% and 1 RB allocations and the highest reported SAR for 1 RB and 50% RB allocation are ≤ 0.8 W/kg. Otherwise, SAR is measured for the highest output power channel; and if the reported SAR is > 1.45 W/kg, the remaining required test channels must also be tested.
5. Per KDB 941225 D05v02r05, 16QAM/64QAM output power for each RB allocation configuration is $>$ not $\frac{1}{2}$ dB higher than the same configuration in QPSK and the reported SAR for the QPSK configuration is ≤ 1.45 W/kg; Per KDB941225 D05v02r05, 16QAM/64QAM SAR testing is not required.
6. Per KDB 941225 D05v02r05, smaller bandwidth output power for each RB allocation configuration is $>$ not $\frac{1}{2}$ Db higher than the same configuration in the largest supported bandwidth, and the reported SAR for the largest supported band width is ≤ 1.45 W/kg; Per KDB 941225 D05v02r05, smaller bandwidth SAR testing is not required.
7. For LTE B4 / B5 / B7 / B17 the maximum bandwidth does not support three non-overlapping channels, per KDB941225 D05v02r05, when a device supports overlapping channel assignment in a channel bandwidth configuration, the middle channel of the group of overlapping channels should be selected for testing.
8. LTE band 2 / 12 SAR test was covered by Band 25 / 17; according to April 2015 TCB workshop, SAR test for overlapping LTE bands can be reduced if
 - a. The maximum output power, including tolerance, for the smaller band is \leq the larger band to qualify for the SAR test exclusion.
 - b. The channel bandwidth and other operating parameters for the smaller band are fully supported by the larger band.
9. According to 2017 TCB workshop, for 64 QAM and 16 QAM should be verified by checking the signal constellation with a call box to avoid incorrect maximum power levels due to MPR and other requirements associated with signal modulation, and the following figure is taken from the "Fundamental Measurement >> Modulation Analysis >>constellation" mode of the device connect to the CMW500 base station, therefore, the device 64QAM and 16QAM signal modulation are correct. Identify if Maximum Power Reduction (MPR) is optional or mandatory, i.e. built-in by design: only mandatory MPR may be considered during SAR testing, when the maximum output power is permanently limited by the MPR implemented within the UE; and only for the applicable RB (resource block) configurations specified in LTE standards: b) A-MPR (additional MPR) must be disabled.
10. Per KDB 447498 D01v06, the reported SAR is the measured SAR value adjusted for maximum tune-up tolerance.
 - a. Tune-up scaling Factor = tune-up limit power (mW) / EUT RF power (mW), where tune-up limit is the maximum rated power among all production units.



- b. For SAR testing of WLAN signal with non-100% duty cycle, the measured SAR is scaled-up by the duty cycle scaling factor which is equal to "1/(duty cycle)"
 - c. For WWAN: Reported SAR(W/kg)= Measured SAR(W/kg)*Tune-up Scaling Factor
 - d. For WLAN/Bluetooth: Reported SAR(W/kg)= Measured SAR(W/kg)* Duty Cycle scaling factor * Tune-up scaling factor
 - e. For TDD LTE SAR measurement, the duty cycle 1:1.59 (62.9 %) was used perform testing and considering the theoretical duty cycle of 63.3% for extended cyclic prefix in the uplink, and the theoretical duty cycle of 62.9% for normal cyclic prefix in uplink, a scaling factor of extended cyclic prefix $63.3\%/62.9\% = 1.006$ is applied to scale-up the measured SAR result. The Reported TDD LTE SAR = measured SAR (W/kg)* Tune-up Scaling Factor* scaling factor for extended cyclic prefix.
11. Per KDB 447498 D01v06, for each exposure position, testing of other required channels within the operating mode of a frequency band is not required when the reported 1-g or 10-g SAR for the mid-band or highest output power channel is: ≤ 0.8 W/kg or 2.0 W/kg, for 1-g or 10-g respectively, when the transmission band is ≤ 100 MHz ≤ 0.6 W/kg or 1.5 W/kg, for 1-g or 10-g respectively, when the transmission band is between 100 MHz and 200 MHz ≤ 0.4 W/kg or 1.0 W/kg, for 1-g or 10-g respectively, when the transmission band is ≥ 200 MHz
 12. Per KDB 865664 D01v01r04, for each frequency band, repeated SAR measurement is required only when the measured SAR is ≥ 0.8 W/kg.
 13. Per KDB 648474 D04v01r03, when the reported SAR for a body-worn accessory measured without a headset connected to the handset is ≤ 1.2 W/kg, SAR testing with a headset connected to the handset is not required.

<WLAN 2.4GHz>

1. SAR is measured for 2.4 GHz 802.11b DSSS using either the fixed test position or, when applicable, the initial test position procedure. SAR test reduction is determined according to the following:
 - a. When the reported SAR of the highest measured maximum output power channel for the exposure configuration is ≤ 0.8 W/kg, no further SAR testing is required for 802.11b DSSS in that exposure configuration.
 - b. When the reported SAR is > 0.8 W/kg, SAR is required for that position using the next highest measured output power channel. When any reported SAR is > 1.2 W/kg, SAR is required for the third channel; i.e., all channels require testing.
2. 2.4 GHz 802.11 g/n OFDM are additionally evaluated for SAR if the highest reported SAR for 802.11b, adjusted by the ratio of the OFDM to DSSS specified maximum output power, is > 1.2 W/kg. When SAR is required for OFDM modes in 2.4 GHz band, the Initial Test configuration Procedures should be followed.
3. For held-to-ear and hotspot operations, the initial test position procedures were applied. The test position with the highest extrapolated peak SAR will be used as the initial test position. When reported SAR for the initial test position is ≤ 0.4 W/kg, no additional testing for the



remaining test positions was required. Otherwise, SAR is evaluated at the subsequent highest peak SAR positions until the reported SAR result is ≤ 0.8 W/kg or all test positions are measured.

4. Justification for test configurations for WLAN per KDB Publication 248227 D02DR02-41929 for 2.4 GHz WI-FI single transmission chain operations, the highest measured maximum output power channel for DSSS was selected for SAR measurement. SAR for OFDM modes (2.4 GHz 802.11g/n) was not required due to the maximum allowed powers and the highest reported DSSS SAR.
5. A fixed level power reduction is applied for WiFi when handset operates "held to the body" condition or "held to the ear" condition, the power reduction triggered by audio receiver detection and call establish status.
6. Per KDB 248227 D01v02r02, In the 2.4 GHz band, separate SAR procedures are applied to DSSS and OFDM configurations to simplify DSSS test requirements. SAR is not required for the following 2.4 GHz OFDM conditions:
 - a. When KDB Publication 447498 SAR test exclusion applies to the OFDM configuration.
 - b. When the highest reported SAR for DSSS is adjusted by the ratio of OFDM to DSSS specified maximum output power and the adjusted SAR is ≤ 1.2 W/kg.

<WLAN 5GHz>

A) U-NII-1 and U-NII-2A Bands

For devices that operate in only one of the U-NII-1 and U-NII-2A bands, the normally required SAR procedures for OFDM configurations are applied. For devices that operate in both U-NII bands using the same transmitter and antenna(s), SAR test reduction is determined according to the following:

1. When the same maximum output power is specified for both bands, begin SAR measurement in U-NII-2A band by applying the OFDM SAR requirements. If the highest reported SAR for a test configuration is ≤ 1.2 W/kg, SAR is not required for U-NII-1 band for that configuration (802.11 mode and exposure condition); otherwise, both bands are tested independently for SAR.
2. When different maximum output power is specified for the bands, begin SAR measurement in the band with higher specified maximum output power. The highest reported SAR for the tested configuration is adjusted by the ratio of lower to higher specified maximum output power for the two bands. When the adjusted SAR is ≤ 1.2 W/kg, SAR is not required for the band with lower maximum output power in that test configuration; otherwise, both bands are tested independently for SAR.
3. The two U-NII bands may be aggregated to support a 160 MHz channel on channel number 50.
4. Without additional testing, the maximum output power for this is limited to the lower of the maximum output power certified for the two bands. When SAR measurement is required for at least one of the bands and the highest reported SAR adjusted by the ratio of specified maximum output power of aggregated to standalone band is > 1.2 W/kg, SAR is required for the 160 MHz channel. This procedure does not apply to an aggregated band with maximum output higher



than the standalone band(s); the aggregated band must be tested independently for SAR. SAR is not required when the 160 MHz channel is operating at a reduced maximum power and also qualifies for SAR test exclusion.

B) U-NII-2C and U-NII-3 Bands

The frequency range covered by these bands is 380 MHz (5.47 – 5.85 GHz), which requires a minimum of at least two SAR probe calibration frequency points to support SAR measurements. when Terminal Doppler Weather Radar (TDWR) restriction applies, all channels that operate at 5.60 – 5.65 GHz must be included to apply the SAR test reduction and measurement procedures. When the same transmitter and antenna(s) are used for U-NII-2C band and U-NII-3 band or 5.8 GHz band of §15.247, the bands may be aggregated to enable additional channels with 20, 40 or 80 MHz bandwidth to span across the band gap, as illustrated in Appendix B. The maximum output power for the additional band gap channels is limited to the lower of those certified for the bands. Unless band gap channels are permanently disabled, they must be considered for SAR testing. The frequency range covered by these bands is 380 MHz (5.47 – 5.85 GHz), which requires a minimum of at least two SAR probe calibration frequency points to support SAR measurements. To maintain SAR measurement accuracy and to facilitate test reduction, the channels in U-NII-2C band above 5.65 GHz may be grouped with the 5.8 GHz channels in U-NII-3 or §15.247 band to enable two SAR probe calibration frequency points to cover the bands, including the band gap channels. When band gap channels are supported and the bands are not aggregated for SAR testing, band gap channels must be considered independently in each band according to the normally required OFDM SAR measurement and probe calibration frequency points requirements.

C) OFDM Transmission Mode SAR Test Configuration and Channel Selection Requirements

The initial test configuration for 5 GHz OFDM transmission modes is determined by the 802.11 configuration with the highest maximum output power specified for production units, including tune-up tolerance, in each standalone and aggregated frequency band. SAR for the initial test configuration is measured using the highest maximum output power channel determined by the default power measurement procedures. When multiple configurations in a frequency band have the same specified maximum output power, the initial test configuration is determined according to the following steps applied sequentially.

1. The largest channel bandwidth configuration is selected among the multiple configurations with the same specified maximum output power.
2. If multiple configurations have the same specified maximum output power and largest channel bandwidth, the lowest order modulation among the largest channel bandwidth configurations is selected.
3. If multiple configurations have the same specified maximum output power, largest channel bandwidth and lowest order modulation, the lowest data rate configuration among these configurations is selected.
4. When multiple transmission modes (802.11a/g/n/ac) have the same specified maximum output power, largest channel bandwidth, lowest order modulation and lowest data rate, the lowest



order 802.11 mode is selected; i.e., 802.11a is chosen over 802.11n then 802.11ac or 802.11g is chosen over 802.11n. After an initial test configuration is determined, if multiple test channels have the same measured maximum output power, the channel chosen for SAR measurement is determined according to the following. These channel selection procedures apply to both the initial test configuration and subsequent test configuration(s), with respect to the default power measurement procedures or additional power measurements required for further SAR test reduction. The same procedures also apply to subsequent highest output power channel(s) selection.

5. The channel closest to mid-band frequency is selected for SAR measurement.
6. For channels with equal separation from mid-band frequency; for example, high and low channels or two mid-band channels, the higher frequency (number) channel is selected for SAR measurement.

D) SAR Test Requirements for OFDM configurations

When SAR measurement is required for 802.11 a/n/ac OFDM configurations, each standalone and frequency aggregated band is considered separately for SAR test reduction. When the same transmitter and antenna(s) are used for U-NII-1 and U-NII-2A bands, additional SAR test reduction applies. When band gap channels between U-NII-2C band and 5.8 GHz U-NII-3 or §15.247 band are supported, the highest maximum output power transmission mode configuration and maximum output power channel across the bands must be used to determine SAR test reduction, according to the initial test configuration and subsequent test configuration requirements. In applying the initial test configuration and subsequent test configuration procedures, the 802.11 transmission configuration with the highest specified maximum output power and the channel within a test configuration with the highest measured maximum output power should be clearly distinguished to apply the procedures.

13. Conducted RF Output Power

➤ GSM Conducted Power

GSM850	Burst Average Power (dBm)			Tune-up Limit (dBm)	Frame-Average Power (dBm)			Tune-up Limit (dBm)
	TX Channel	128	189		251	128	189	
Frequency (MHz)	824.2	836.4	848.8		824.2	836.4	848.8	
GSM 1 Tx slot	32.00	32.08	32.06	32.50	23.00	23.08	23.06	23.50
GPRS 1 Tx slot	32.25	32.05	31.93	32.50	23.25	23.05	22.93	23.50
GPRS 2 Tx slots	31.02	31.12	31.03	32.00	25.02	25.12	25.03	26.00
GPRS 3 Tx slots	29.50	29.55	29.60	30.50	25.24	25.29	25.34	26.24
GPRS 4 Tx slots	27.20	27.27	27.35	28.00	24.20	24.27	24.35	25.00
EDGE 1 Tx slot	27.02	26.80	26.72	27.50	18.02	17.80	17.72	18.50
EDGE 2 Tx slots	26.80	26.61	26.58	27.00	20.80	20.61	20.58	21.00
EDGE 3 Tx slots	26.65	26.45	26.44	27.00	22.39	22.19	22.18	22.74
EDGE 4 Tx slots	26.39	26.26	26.27	26.50	23.39	23.26	23.27	23.50

GSM1900	Burst Average Power (dBm)			Tune-up Limit (dBm)	Frame-Average Power (dBm)			Tune-up Limit (dBm)
	TX Channel	512	661		810	512	661	
Frequency (MHz)	1850.2	1880	1909.8		1850.2	1880	1909.8	
GSM 1 Tx slot	29.80	29.80	29.82	30.50	20.80	20.80	20.82	21.50
GPRS 1 Tx slot	29.82	29.80	29.79	30.50	20.82	20.80	20.79	21.50
GPRS 2 Tx slots	28.61	28.60	28.53	29.50	22.61	22.60	22.53	23.50
GPRS 3 Tx slots	27.62	27.61	27.54	28.50	23.36	23.35	23.28	24.24
GPRS 4 Tx slots	25.03	25.07	25.10	26.00	22.03	22.07	22.10	23.00
EDGE 1 Tx slot	26.05	26.03	25.82	26.50	17.05	17.03	16.82	17.50
EDGE 2 Tx slots	25.06	24.89	24.76	25.50	19.06	18.89	18.76	19.50
EDGE 3 Tx slots	23.50	23.90	23.57	24.50	19.24	19.64	19.31	20.24
EDGE 4 Tx slots	22.48	22.85	22.68	23.00	19.48	19.85	19.68	20.00

Timeslot consignations:

No. of Slots	Slot 1	Slot 2	Slot 3	Slot 4
Slot Consignation	1Up4Down	2Up3Down	3Up2Down	4Up1Down
Duty Cycle	1:8.3	1:4.15	1:2.77	1:2.08
Correct Factor	-9.03dB	-6.02dB	-4.26dB	-3.01dB



➤ **WCDMA Conducted Power**

Band		WCDMA Band II			Tune-up Limit (dBm)
TX Channel		9262	9400	9538	
Rx Channel		9662	9800	9938	
Frequency (MHz)		1852.4	1880	1907.6	
3GPP Rel 99	RMC 12.2Kbps	22.36	22.25	22.28	22.50
3GPP Rel 5	HSDPA Subtest-1	21.94	21.88	21.89	22.00
3GPP Rel 5	HSDPA Subtest-2	21.93	21.86	21.89	22.00
3GPP Rel 5	HSDPA Subtest-3	21.43	21.37	21.43	21.50
3GPP Rel 5	HSDPA Subtest-4	21.42	21.39	21.42	21.50
3GPP Rel 6	HSUPA Subtest-1	21.82	21.76	21.80	22.00
3GPP Rel 6	HSUPA Subtest-2	21.80	21.76	21.82	22.00
3GPP Rel 6	HSUPA Subtest-3	20.84	20.77	20.82	21.00
3GPP Rel 6	HSUPA Subtest-4	19.82	19.78	19.82	20.00
3GPP Rel 6	HSUPA Subtest-5	19.82	19.78	19.82	20.00
3GPP Rel 7	HSPA+ (16QAM) Subtest-1	17.93	17.31	17.30	19.00

Band		WCDMA Band IV			Tune-up Limit (dBm)
TX Channel		1312	1413	1513	
Rx Channel		1537	1638	1738	
Frequency (MHz)		1712.4	1732.6	1752.6	
3GPP Rel 99	RMC 12.2Kbps	21.60	21.32	21.39	22.00
3GPP Rel 5	HSDPA Subtest-1	20.62	20.73	20.76	21.50
3GPP Rel 5	HSDPA Subtest-2	20.58	20.68	20.74	21.50
3GPP Rel 5	HSDPA Subtest-3	20.13	20.25	20.27	21.00
3GPP Rel 5	HSDPA Subtest-4	20.12	20.24	19.94	21.00
3GPP Rel 6	HSUPA Subtest-1	20.63	20.74	20.76	21.00
3GPP Rel 6	HSUPA Subtest-2	20.60	20.70	20.75	21.00
3GPP Rel 6	HSUPA Subtest-3	19.59	19.73	19.78	20.00
3GPP Rel 6	HSUPA Subtest-4	18.61	18.72	18.73	19.00
3GPP Rel 6	HSUPA Subtest-5	18.61	18.72	18.76	19.50
3GPP Rel 7	HSPA+ (16QAM) Subtest-1	18.75	18.57	18.45	19.00



Band		WCDMA Band V			Tune-up Limit (dBm)
TX Channel		4132	4183	4233	
Rx Channel		4357	4408	4458	
Frequency (MHz)		826.4	836.6	846.6	
3GPP Rel 99	RMC 12.2Kbps	23.70	23.83	23.70	24.50
3GPP Rel 5	HSDPA Subtest-1	22.70	22.56	22.65	23.50
3GPP Rel 5	HSDPA Subtest-2	21.66	21.64	21.74	23.50
3GPP Rel 5	HSDPA Subtest-3	20.89	20.76	20.82	23.00
3GPP Rel 5	HSDPA Subtest-4	20.84	20.76	21.07	23.00
3GPP Rel 6	HSUPA Subtest-1	21.64	21.44	21.71	22.00
3GPP Rel 6	HSUPA Subtest-2	21.61	21.54	21.69	22.00
3GPP Rel 6	HSUPA Subtest-3	21.41	21.38	21.44	22.00
3GPP Rel 6	HSUPA Subtest-4	22.59	22.54	22.55	23.00
3GPP Rel 6	HSUPA Subtest-5	21.65	21.45	21.35	22.00
3GPP Rel 7	HSPA+ (16QAM) Subtest-1	22.01	21.89	21.88	22.50



➤ LTE Conducted Power

<FDD-LTE Band 2>

BW [MHz]	Modulation	RB Size	RB Offset	Low Channel	Middle Channel	High Channel	Tune-up limit (dBm)
Channel				18700	18900	19100	
Frequency (MHz)				1860	1880	1900	
20	QPSK	1	0	21.65	21.83	21.75	22.50
20	QPSK	1	49	21.80	21.78	21.62	
20	QPSK	1	99	21.61	21.40	21.62	
20	QPSK	50	0	20.74	20.81	20.56	21.50
20	QPSK	50	24	20.76	20.70	20.72	
20	QPSK	50	50	20.66	20.67	20.66	
20	QPSK	100	0	20.82	20.71	20.55	
20	16QAM	1	0	20.90	21.31	21.03	21.50
20	16QAM	1	49	21.13	21.01	21.19	
20	16QAM	1	99	21.08	21.09	20.91	
20	16QAM	50	0	19.91	19.88	19.83	22.50
20	16QAM	50	24	19.91	19.87	19.94	
20	16QAM	50	50	19.87	19.77	19.79	
20	16QAM	100	0	19.91	19.76	19.60	
20	64QAM	1	0	20.80	20.98	20.87	21.50
20	64QAM	1	49	20.74	20.99	20.92	
20	64QAM	1	99	21.17	20.75	20.95	
20	64QAM	50	0	19.87	19.87	19.62	20.50
20	64QAM	50	24	19.96	19.88	19.78	
20	64QAM	50	50	19.88	19.70	19.86	
20	64QAM	100	0	19.83	19.98	19.73	
Channel				18675	18900	19125	Tune-up limit (dBm)
Frequency (MHz)				1857.5	1880	1902.5	
15	QPSK	1	0	21.76	21.64	21.39	22.50
15	QPSK	1	37	21.82	21.67	21.56	
15	QPSK	1	74	21.70	21.72	21.50	
15	QPSK	36	0	20.70	20.73	20.54	21.50
15	QPSK	36	20	20.81	20.69	20.59	
15	QPSK	36	39	20.82	20.60	20.64	
15	QPSK	75	0	20.70	20.61	20.65	
15	16QAM	1	0	21.32	21.30	20.93	21.50



15	16QAM	1	37	21.04	21.31	20.88	
15	16QAM	1	74	21.29	20.91	20.87	
15	16QAM	36	0	20.94	20.87	20.88	21.50
15	16QAM	36	20	21.06	20.82	20.67	
15	16QAM	36	39	21.01	20.95	20.57	
15	16QAM	75	0	19.98	19.76	19.66	
15	64QAM	1	0	21.26	21.12	21.15	
15	64QAM	1	37	21.00	21.05	21.17	21.50
15	64QAM	1	74	20.98	20.94	20.82	
15	64QAM	36	0	20.91	20.67	20.86	
15	64QAM	36	20	20.90	20.91	20.78	21.00
15	64QAM	36	39	20.89	20.83	20.79	
15	64QAM	75	0	19.92	19.70	19.69	
Channel				18650	18900	19150	
Frequency (MHz)				1855	1880	1905	
10	QPSK	1	0	21.81	21.78	21.54	22.50
10	QPSK	1	25	21.55	21.66	21.65	
10	QPSK	1	49	21.77	21.59	21.65	
10	QPSK	25	0	20.86	20.76	20.70	21.50
10	QPSK	25	12	20.73	20.75	20.61	
10	QPSK	25	25	20.68	20.64	20.61	
10	QPSK	50	0	20.76	20.70	20.64	
10	16QAM	1	0	20.98	21.00	21.35	21.50
10	16QAM	1	25	21.06	21.44	21.05	
10	16QAM	1	49	20.98	21.37	21.01	
10	16QAM	25	0	19.88	19.96	19.73	20.00
10	16QAM	25	12	20.00	19.88	19.83	
10	16QAM	25	25	19.93	19.93	19.78	
10	16QAM	50	0	19.83	19.77	19.89	
10	64QAM	1	0	21.17	21.09	20.82	21.50
10	64QAM	1	25	21.27	21.09	20.88	
10	64QAM	1	49	21.28	21.00	20.96	
10	64QAM	25	0	19.92	19.84	19.86	20.50
10	64QAM	25	12	19.86	19.94	19.74	
10	64QAM	25	25	19.99	19.81	19.77	
10	64QAM	50	0	19.87	19.78	19.84	
Channel				18625	18900	19175	Tune-up



Frequency (MHz)				1852.5	1880	1907.5	limit (dBm)
5	QPSK	1	0	21.74	21.80	21.43	22.50
5	QPSK	1	12	21.77	21.78	21.63	
5	QPSK	1	24	21.74	21.81	21.59	
5	QPSK	12	0	20.83	20.72	20.74	21.50
5	QPSK	12	7	20.90	20.75	20.80	
5	QPSK	12	13	20.80	20.66	20.71	
5	QPSK	25	0	20.85	20.66	20.65	
5	16QAM	1	0	21.08	21.05	21.12	21.50
5	16QAM	1	12	21.02	21.04	20.91	
5	16QAM	1	24	21.01	21.03	20.67	
5	16QAM	12	0	20.01	19.90	19.84	20.50
5	16QAM	12	7	19.94	20.03	19.81	
5	16QAM	12	13	20.02	19.88	19.80	
5	16QAM	25	0	19.94	19.92	19.94	
5	64QAM	1	0	21.32	21.09	20.92	21.50
5	64QAM	1	12	20.97	21.39	20.99	
5	64QAM	1	24	21.04	21.06	21.06	
5	64QAM	12	0	19.97	19.76	19.73	20.50
5	64QAM	12	7	19.87	20.02	19.74	
5	64QAM	12	13	19.93	19.81	19.89	
5	64QAM	25	0	19.91	19.82	19.78	
Channel				18615	18900	19185	Tune-up
Frequency (MHz)				1851.5	1880	1908.5	limit (dBm)
3	QPSK	1	0	21.73	21.67	21.57	22.50
3	QPSK	1	8	21.83	21.70	21.69	
3	QPSK	1	14	21.74	21.68	21.49	
3	QPSK	8	0	20.83	20.69	20.70	21.50
3	QPSK	8	4	20.80	20.79	20.67	
3	QPSK	8	7	20.80	20.71	20.77	
3	QPSK	15	0	20.78	20.80	20.65	
3	16QAM	1	0	20.92	20.98	21.19	21.50
3	16QAM	1	8	21.05	21.34	21.20	
3	16QAM	1	14	21.39	21.37	20.94	
3	16QAM	8	0	20.11	19.97	19.70	20.50
3	16QAM	8	4	20.18	20.06	19.93	



3	16QAM	8	7	20.00	20.05	19.76	
3	16QAM	15	0	19.84	20.02	19.92	
3	64QAM	1	0	21.27	21.06	20.90	21.50
3	64QAM	1	8	21.10	20.98	20.82	
3	64QAM	1	14	21.12	21.01	20.81	
3	64QAM	8	0	20.00	19.78	19.80	20.50
3	64QAM	8	4	19.99	20.01	19.90	
3	64QAM	8	7	20.00	19.90	19.77	
3	64QAM	15	0	19.85	19.79	19.79	
Channel				18607	18900	19193	Tune-up limit (dBm)
Frequency (MHz)				1850.7	1880	1909.3	
1.4	QPSK	1	0	21.76	21.64	21.39	22.50
1.4	QPSK	1	3	21.81	21.67	21.56	
1.4	QPSK	1	5	21.70	21.72	21.50	
1.4	QPSK	3	0	21.70	21.73	21.54	
1.4	QPSK	3	1	21.83	21.69	21.59	
1.4	QPSK	3	3	21.85	21.60	21.64	
1.4	QPSK	6	0	20.70	20.61	20.65	21.50
1.4	16QAM	1	0	21.22	21.21	20.93	21.50
1.4	16QAM	1	3	21.04	21.19	20.74	
1.4	16QAM	1	5	21.22	20.91	20.87	
1.4	16QAM	3	0	20.94	20.87	20.78	
1.4	16QAM	3	1	21.06	20.82	20.67	
1.4	16QAM	3	3	21.01	20.95	20.57	
1.4	16QAM	6	0	19.98	19.76	19.66	20.50
1.4	64QAM	1	0	21.40	21.12	21.15	21.50
1.4	64QAM	1	3	21.00	21.05	21.17	
1.4	64QAM	1	5	20.98	20.94	20.92	
1.4	64QAM	3	0	20.91	20.67	20.96	
1.4	64QAM	3	1	21.01	20.95	20.78	
1.4	64QAM	3	3	20.99	20.83	20.79	
1.4	64QAM	6	0	19.92	19.70	19.69	20.50



<FDD-LTE Band 4>

BW [MHz]	Modulation	RB Size	RB Offset	Low Channel	Middle Channel	High Channel	Tune-up limit (dBm)
Channel				20050	20175	20300	
Frequency (MHz)				1720	1732.5	1745	
20	QPSK	1	0	21.19	21.18	21.26	22.00
20	QPSK	1	49	21.20	21.10	21.06	
20	QPSK	1	99	21.05	21.04	21.01	
20	QPSK	50	0	20.15	20.30	20.31	21.00
20	QPSK	50	24	20.27	20.29	20.25	
20	QPSK	50	50	20.29	20.25	20.16	
20	QPSK	100	0	20.20	20.23	20.23	
20	16QAM	1	0	20.32	20.57	20.43	21.00
20	16QAM	1	49	20.29	20.47	20.08	
20	16QAM	1	99	20.33	20.20	20.56	
20	16QAM	50	0	19.37	19.39	19.34	20.00
20	16QAM	50	24	19.31	19.44	19.39	
20	16QAM	50	50	19.29	19.24	19.15	
20	16QAM	100	0	19.23	19.26	19.32	
20	64QAM	1	0	20.12	20.40	20.35	21.00
20	64QAM	1	49	20.39	20.44	20.27	
20	64QAM	1	99	20.35	20.12	20.23	
20	64QAM	50	0	19.26	19.40	19.28	20.00
20	64QAM	50	24	19.31	19.39	19.33	
20	64QAM	50	50	19.32	19.28	19.25	
20	64QAM	100	0	19.24	19.35	19.32	
Channel				20025	20175	20325	
Frequency (MHz)				1717.5	1732.5	1747.5	
15	QPSK	1	0	21.19	21.03	20.93	22.00
15	QPSK	1	37	21.19	20.94	20.73	
15	QPSK	1	74	21.06	20.74	20.76	
15	QPSK	36	0	20.29	20.12	19.88	21.00
15	QPSK	36	20	20.21	20.06	19.88	
15	QPSK	36	39	20.13	19.98	19.84	
15	QPSK	75	0	20.21	20.05	19.90	
15	16QAM	1	0	20.37	20.50	20.03	21.00
15	16QAM	1	37	20.35	20.28	20.01	



15	16QAM	1	74	20.17	20.00	20.42	
15	16QAM	36	0	19.37	19.26	19.00	20.00
15	16QAM	36	20	19.29	19.18	18.99	
15	16QAM	36	39	19.24	19.10	19.00	
15	16QAM	75	0	19.25	19.16	19.03	
15	64QAM	1	0	20.16	20.48	20.41	
15	64QAM	1	37	20.28	19.98	19.99	21.00
15	64QAM	1	74	19.99	20.17	19.99	
15	64QAM	36	0	19.30	19.29	19.03	
15	64QAM	36	20	19.34	19.14	19.01	20.00
15	64QAM	36	39	19.27	19.06	18.95	
15	64QAM	75	0	19.25	19.25	18.99	
Channel				20000	20175	20350	Tune-up limit (dBm)
Frequency (MHz)				1715	1732.5	1750	
10	QPSK	1	0	21.03	21.01	20.96	22.00
10	QPSK	1	25	21.00	20.98	20.79	
10	QPSK	1	49	20.99	20.78	20.63	
10	QPSK	25	0	20.20	20.24	20.06	21.00
10	QPSK	25	12	20.27	20.17	19.96	
10	QPSK	25	25	20.17	20.04	19.85	
10	QPSK	50	0	20.23	20.09	19.95	
10	16QAM	1	0	20.20	20.43	20.11	
10	16QAM	1	25	20.33	20.30	20.30	21.00
10	16QAM	1	49	20.22	20.29	19.95	
10	16QAM	25	0	19.37	19.29	19.05	
10	16QAM	25	12	19.32	19.25	19.12	20.00
10	16QAM	25	25	19.29	19.09	19.01	
10	16QAM	50	0	19.27	19.16	18.98	
10	64QAM	1	0	20.12	20.22	20.15	
10	64QAM	1	25	20.13	20.28	19.92	21.00
10	64QAM	1	49	20.11	19.83	19.82	
10	64QAM	25	0	19.28	19.28	19.02	
10	64QAM	25	12	19.37	19.19	19.02	20.00
10	64QAM	25	25	19.19	18.99	18.96	
10	64QAM	50	0	19.31	19.23	18.99	
Channel				19975	20175	20375	
Frequency (MHz)				1712.5	1732.5	1752.5	



							(dBm)
5	QPSK	1	0	21.15	21.12	20.92	22.00
5	QPSK	1	12	21.06	21.07	20.74	
5	QPSK	1	24	21.12	20.88	20.72	
5	QPSK	12	0	20.17	20.19	19.98	21.00
5	QPSK	12	7	20.19	20.15	19.99	
5	QPSK	12	13	20.05	19.97	19.84	
5	QPSK	25	0	20.20	20.11	19.98	
5	16QAM	1	0	20.19	20.41	20.30	21.00
5	16QAM	1	12	20.45	20.51	20.01	
5	16QAM	1	24	20.06	20.17	20.28	
5	16QAM	12	0	19.23	19.34	18.96	20.00
5	16QAM	12	7	19.27	19.28	18.98	
5	16QAM	12	13	19.28	19.12	18.95	
5	16QAM	25	0	19.35	19.17	18.98	
5	64QAM	1	0	20.04	20.33	19.97	21.00
5	64QAM	1	12	20.42	20.32	20.04	
5	64QAM	1	24	20.12	20.01	19.93	
5	64QAM	12	0	19.35	19.34	19.02	20.00
5	64QAM	12	7	19.27	19.19	19.02	
5	64QAM	12	13	19.23	19.04	18.96	
5	64QAM	25	0	19.27	19.22	18.99	
Channel				19965	20175	20385	Tune-up limit (dBm)
Frequency (MHz)				1711.5	1732.5	1753.5	
3	QPSK	1	0	21.24	21.19	20.93	22.00
3	QPSK	1	8	21.15	20.93	20.86	
3	QPSK	1	14	20.95	20.93	20.77	
3	QPSK	8	0	20.24	20.16	19.97	21.00
3	QPSK	8	4	20.18	20.11	19.95	
3	QPSK	8	7	20.17	20.05	19.81	
3	QPSK	15	0	20.19	20.11	19.94	
3	16QAM	1	0	20.33	20.56	20.40	21.00
3	16QAM	1	8	20.52	20.26	20.12	
3	16QAM	1	14	20.14	20.31	20.06	
3	16QAM	8	0	19.29	19.33	19.06	20.00
3	16QAM	8	4	19.26	19.21	18.96	
3	16QAM	8	7	19.22	19.04	18.92	



3	16QAM	15	0	19.27	19.24	18.95	
3	64QAM	1	0	20.26	20.48	20.04	21.00
3	64QAM	1	8	20.32	19.99	20.02	
3	64QAM	1	14	20.03	20.01	19.98	
3	64QAM	8	0	19.26	19.29	18.99	20.00
3	64QAM	8	4	19.25	19.27	19.11	
3	64QAM	8	7	19.27	19.09	19.08	
3	64QAM	15	0	19.30	19.18	18.97	
Channel				19957	20175	20393	Tune-up limit (dBm)
Frequency (MHz)				1710.7	1732.5	1754.3	
1.4	QPSK	1	0	21.09	21.06	20.95	22.00
1.4	QPSK	1	3	21.09	20.99	20.86	
1.4	QPSK	1	5	21.06	20.80	20.68	
1.4	QPSK	3	0	20.29	20.12	19.98	
1.4	QPSK	3	1	20.21	20.07	19.98	
1.4	QPSK	3	3	20.13	20.03	19.86	
1.4	QPSK	6	0	20.21	20.07	19.99	21.00
1.4	16QAM	1	0	20.43	20.37	20.25	21.00
1.4	16QAM	1	3	20.25	20.51	20.04	
1.4	16QAM	1	5	20.17	20.07	20.02	
1.4	16QAM	3	0	19.37	19.38	19.03	
1.4	16QAM	3	1	19.29	19.22	18.98	
1.4	16QAM	3	3	19.24	19.06	18.94	
1.4	16QAM	6	0	19.25	19.22	19.02	20.00
1.4	64QAM	1	0	20.16	20.33	20.03	21.00
1.4	64QAM	1	3	20.28	20.37	20.01	
1.4	64QAM	1	5	20.13	20.27	19.88	
1.4	64QAM	3	0	19.30	19.22	19.02	
1.4	64QAM	3	1	19.34	19.28	19.00	
1.4	64QAM	3	3	19.27	19.13	18.95	
1.4	64QAM	6	0	19.25	19.20	19.01	20.00



<FDD-LTE Band 5>

BW [MHz]	Modulation	RB Size	RB Offset	Low Channel	Middle Channel	High Channel	Tune-up limit (dBm)
Channel				20450	20525	20600	
Frequency (MHz)				829	836.5	844	
10	QPSK	1	0	23.29	23.55	23.50	24.00
10	QPSK	1	25	23.34	23.50	23.45	
10	QPSK	1	49	23.47	23.43	23.40	
10	QPSK	25	0	22.48	22.60	22.53	23.00
10	QPSK	25	12	22.55	22.63	22.62	
10	QPSK	25	25	22.45	22.51	22.45	
10	QPSK	50	0	22.58	22.56	22.46	23.00
10	16QAM	1	0	22.51	22.63	22.58	
10	16QAM	1	25	22.83	22.92	22.69	
10	16QAM	1	49	22.93	22.68	22.56	22.00
10	16QAM	25	0	21.50	21.65	21.64	
10	16QAM	25	12	21.65	21.63	21.68	
10	16QAM	25	25	21.61	21.65	21.49	22.00
10	16QAM	50	0	21.53	21.61	21.60	
10	64QAM	1	0	22.39	22.60	22.31	
10	64QAM	1	25	22.52	22.63	22.75	23.00
10	64QAM	1	49	22.42	22.42	22.53	
10	64QAM	25	0	21.56	21.64	21.55	
10	64QAM	25	12	21.62	21.68	21.72	22.00
10	64QAM	25	25	21.53	21.57	21.62	
10	64QAM	50	0	21.59	21.66	21.56	
Channel				20425	20525	20625	Tune-up limit (dBm)
Frequency (MHz)				826.5	836.5	846.5	
5	QPSK	1	0	23.26	23.38	23.51	24.00
5	QPSK	1	12	23.39	23.33	23.41	
5	QPSK	1	24	23.25	23.30	23.51	
5	QPSK	12	0	22.46	22.52	22.57	23.00
5	QPSK	12	7	22.52	22.60	22.57	
5	QPSK	12	13	22.53	22.57	22.44	
5	QPSK	25	0	22.49	22.57	22.45	23.00
5	16QAM	1	0	22.85	22.61	22.62	
5	16QAM	1	12	22.60	22.59	22.46	



5	16QAM	1	24	22.83	22.39	22.43	
5	16QAM	12	0	21.55	21.66	21.63	22.00
5	16QAM	12	7	21.57	21.54	21.67	
5	16QAM	12	13	21.48	21.60	21.53	
5	16QAM	25	0	21.54	21.66	21.59	
5	64QAM	1	0	22.52	22.51	22.96	
5	64QAM	1	12	22.91	22.50	22.95	23.00
5	64QAM	1	24	22.54	22.54	22.51	
5	64QAM	12	0	21.51	21.51	21.60	
5	64QAM	12	7	21.53	21.56	21.47	22.00
5	64QAM	12	13	21.51	21.62	21.54	
5	64QAM	25	0	21.49	21.64	21.55	
Channel				20415	20525	20635	Tune-up limit (dBm)
Frequency (MHz)				825.5	836.5	847.5	
3	QPSK	1	0	23.36	23.39	23.37	24.00
3	QPSK	1	8	23.33	23.56	23.41	
3	QPSK	1	14	23.33	23.33	23.27	
3	QPSK	8	0	22.39	22.58	22.52	23.00
3	QPSK	8	4	22.52	22.52	22.54	
3	QPSK	8	7	22.50	22.52	22.45	
3	QPSK	15	0	22.45	22.62	22.44	
3	16QAM	1	0	22.51	22.39	22.58	23.00
3	16QAM	1	8	22.39	22.43	22.72	
3	16QAM	1	14	22.89	22.81	22.65	
3	16QAM	8	0	21.48	21.64	21.54	22.00
3	16QAM	8	4	21.47	21.71	21.58	
3	16QAM	8	7	21.59	21.53	21.51	
3	16QAM	15	0	21.63	21.64	21.46	
3	64QAM	1	0	22.47	22.58	22.45	23.00
3	64QAM	1	8	22.46	22.56	22.57	
3	64QAM	1	14	22.86	22.92	22.55	
3	64QAM	8	0	21.44	21.48	21.57	22.00
3	64QAM	8	4	21.43	21.55	21.54	
3	64QAM	8	7	21.55	21.63	21.58	
3	64QAM	15	0	21.55	21.55	21.63	
Channel				20407	20525	20643	Tune-up limit
Frequency (MHz)				824.7	836.5	848.3	



							(dBm)
1.4	QPSK	1	0	23.30	23.39	23.34	24.00
1.4	QPSK	1	3	23.34	23.45	23.44	
1.4	QPSK	1	5	23.28	23.35	23.26	
1.4	QPSK	3	0	23.34	23.31	23.43	
1.4	QPSK	3	1	23.35	23.40	23.39	
1.4	QPSK	3	3	23.32	23.42	23.27	
1.4	QPSK	6	0	22.36	22.45	22.46	23.00
1.4	16QAM	1	0	22.45	22.51	22.43	23.00
1.4	16QAM	1	3	22.46	22.61	22.24	
1.4	16QAM	1	5	22.27	22.59	22.72	
1.4	16QAM	3	0	22.32	22.31	22.33	
1.4	16QAM	3	1	22.44	22.40	22.39	
1.4	16QAM	3	3	22.31	22.37	22.35	
1.4	16QAM	6	0	21.48	21.53	21.63	22.00
1.4	64QAM	1	0	22.63	22.52	22.44	23.00
1.4	64QAM	1	3	22.76	22.58	22.56	
1.4	64QAM	1	5	22.67	22.77	22.28	
1.4	64QAM	3	0	22.20	22.59	22.44	
1.4	64QAM	3	1	22.44	22.43	22.37	
1.4	64QAM	3	3	22.35	22.43	22.35	
1.4	64QAM	6	0	21.45	21.49	21.51	22.00

<FDD-LTE Band 12>

BW [MHz]	Modulation	RB Size	RB Offset	Low Channel	Middle Channel	High Channel	Tune-up limit (dBm)
Channel				23060	23095	23130	24.00
Frequency (MHz)				704	707.5	711	
10	QPSK	1	0	23.09	23.37	23.35	24.00
10	QPSK	1	25	23.40	23.41	23.29	
10	QPSK	1	49	23.35	23.32	23.45	
10	QPSK	25	0	22.40	22.42	22.43	23.00
10	QPSK	25	12	22.50	22.42	22.51	
10	QPSK	25	25	22.49	22.38	22.43	
10	QPSK	50	0	22.53	22.43	22.42	
10	16QAM	1	0	22.59	22.39	22.87	23.00
10	16QAM	1	25	22.86	22.51	22.54	
10	16QAM	1	49	22.57	22.60	22.55	



10	16QAM	25	0	21.38	21.50	21.45	22.00
10	16QAM	25	12	21.57	21.46	21.58	
10	16QAM	25	25	21.47	21.55	21.41	
10	16QAM	50	0	21.53	21.57	21.42	
10	64QAM	1	0	22.69	22.37	22.50	23.00
10	64QAM	1	25	22.81	22.35	22.51	
10	64QAM	1	49	22.55	22.61	22.63	
10	64QAM	25	0	21.40	21.53	21.49	22.00
10	64QAM	25	12	21.48	21.48	21.53	
10	64QAM	25	25	21.53	21.53	21.40	
10	64QAM	50	0	21.52	21.49	21.52	
Channel				23035	23095	23155	Tune-up limit (dBm)
Frequency (MHz)				701.5	707.5	713.5	
5	QPSK	1	0	23.19	23.40	23.22	24.00
5	QPSK	1	12	23.20	23.43	23.41	
5	QPSK	1	24	23.45	23.36	23.38	
5	QPSK	12	0	22.35	22.40	22.32	23.00
5	QPSK	12	7	22.36	22.47	22.47	
5	QPSK	12	13	22.33	22.41	22.48	
5	QPSK	25	0	22.39	22.43	22.41	
5	16QAM	1	0	22.74	22.50	22.55	23.00
5	16QAM	1	12	22.86	22.64	22.52	
5	16QAM	1	24	22.79	22.62	22.39	
5	16QAM	12	0	21.42	21.45	21.38	22.00
5	16QAM	12	7	21.42	21.42	21.59	
5	16QAM	12	13	21.42	21.49	21.49	
5	16QAM	25	0	21.42	21.52	21.39	
5	64QAM	1	0	22.43	22.49	22.90	23.00
5	64QAM	1	12	22.70	22.46	22.92	
5	64QAM	1	24	22.72	22.62	22.91	
5	64QAM	12	0	21.42	21.57	21.35	22.00
5	64QAM	12	7	21.46	21.63	21.55	
5	64QAM	12	13	21.40	21.43	21.50	
5	64QAM	25	0	21.39	21.58	21.45	
Channel				23025	23095	23165	Tune-up limit (dBm)
Frequency (MHz)				700.5	707.5	714.5	



3	QPSK	1	0	23.23	23.33	23.40	24.00
3	QPSK	1	8	23.42	23.41	23.30	
3	QPSK	1	14	23.33	23.34	23.27	
3	QPSK	8	0	22.33	22.52	22.44	23.00
3	QPSK	8	4	22.41	22.55	22.54	
3	QPSK	8	7	22.41	22.47	22.43	
3	QPSK	15	0	22.51	22.47	22.40	23.00
3	16QAM	1	0	22.52	22.73	22.79	
3	16QAM	1	8	22.39	22.54	22.47	
3	16QAM	1	14	22.82	22.64	22.49	22.00
3	16QAM	8	0	21.43	21.61	21.59	
3	16QAM	8	4	21.48	21.58	21.51	
3	16QAM	8	7	21.48	21.64	21.48	23.00
3	16QAM	15	0	21.57	21.54	21.56	
3	64QAM	1	0	22.36	22.56	22.58	
3	64QAM	1	8	22.44	22.54	22.48	22.00
3	64QAM	1	14	22.55	22.53	22.40	
3	64QAM	8	0	21.41	21.44	21.53	
3	64QAM	8	4	21.59	21.59	21.44	23.00
3	64QAM	8	7	21.43	21.49	21.59	
3	64QAM	15	0	21.54	21.63	21.47	
Channel				23017	23095	23173	Tune-up limit (dBm)
Frequency (MHz)				699.7	707.5	715.3	
1.4	QPSK	1	0	23.20	23.41	23.33	24.00
1.4	QPSK	1	3	23.35	23.43	23.38	
1.4	QPSK	1	5	23.17	23.41	23.26	
1.4	QPSK	3	0	23.35	23.32	23.36	
1.4	QPSK	3	1	23.36	23.44	23.43	
1.4	QPSK	3	3	23.30	23.45	23.40	
1.4	QPSK	6	0	22.38	22.47	22.38	23.00
1.4	16QAM	1	0	22.73	22.80	22.35	23.00
1.4	16QAM	1	3	22.64	22.49	22.65	
1.4	16QAM	1	5	22.39	22.57	22.36	
1.4	16QAM	3	0	22.28	22.29	22.41	
1.4	16QAM	3	1	22.28	22.38	22.45	
1.4	16QAM	3	3	22.42	22.43	22.40	
1.4	16QAM	6	0	21.54	21.51	21.63	22.00



1.4	64QAM	1	0	22.20	22.29	22.24	23.00
1.4	64QAM	1	3	22.27	22.59	22.20	
1.4	64QAM	1	5	22.24	22.51	22.41	
1.4	64QAM	3	0	22.27	22.57	22.37	
1.4	64QAM	3	1	22.45	22.43	22.48	
1.4	64QAM	3	3	22.41	22.45	22.24	
1.4	64QAM	6	0	21.37	21.41	21.52	22.00

<FDD-LTE Band 13>

BW [MHz]	Modulation	RB Size	RB Offset	Low Channel	Middle Channel	High Channel	Tune-up limit (dBm)
Channel				23230			Tune-up limit (dBm)
Frequency (MHz)				782			
10	QPSK	1	0	23.37			24.00
10	QPSK	1	25	23.51			
10	QPSK	1	49	23.37			
10	QPSK	25	0	22.54			23.00
10	QPSK	25	12	22.61			
10	QPSK	25	25	22.59			
10	QPSK	50	0	22.62			23.00
10	16QAM	1	0	22.59			
10	16QAM	1	25	22.77			
10	16QAM	1	49	22.81			
10	16QAM	25	0	21.56			
10	16QAM	25	12	21.67			
10	16QAM	25	25	21.61			
10	16QAM	50	0	21.73			22.00
10	64QAM	1	0	22.53			
10	64QAM	1	25	22.69			
10	64QAM	1	49	22.33			23.00
10	64QAM	25	0	21.57			
10	64QAM	25	12	21.68			
10	64QAM	25	25	21.60			22.00
10	64QAM	50	0	21.64			
Channel				23205	23230	23255	
Frequency (MHz)				779.5	782	784.5	
5	QPSK	1	0	23.40	23.42	23.49	24.00



5	QPSK	1	12	23.47	23.50	23.47	
5	QPSK	1	24	23.51	23.49	23.48	
5	QPSK	12	0	22.52	22.58	22.66	23.00
5	QPSK	12	7	22.57	22.66	22.55	
5	QPSK	12	13	22.53	22.44	22.55	
5	QPSK	25	0	22.53	22.55	22.54	
5	16QAM	1	0	22.81	22.70	22.75	
5	16QAM	1	12	22.92	22.83	22.63	23.00
5	16QAM	1	24	23.12	22.72	22.79	
5	16QAM	12	0	21.58	21.73	21.56	
5	16QAM	12	7	21.55	21.81	21.68	22.00
5	16QAM	12	13	21.62	21.56	21.52	
5	16QAM	25	0	21.60	21.64	21.58	
5	64QAM	1	0	22.29	22.62	22.72	
5	64QAM	1	12	22.45	22.73	22.64	23.00
5	64QAM	1	24	22.63	22.65	22.52	
5	64QAM	12	0	21.53	21.67	21.62	
5	64QAM	12	7	21.61	21.64	21.40	22.00
5	64QAM	12	13	21.79	21.70	21.45	
5	64QAM	25	0	21.50	21.68	21.52	

<FDD-LTE Band 17>

BW [MHz]	Modulation	RB Size	RB Offset	Low Channel	Middle Channel	High Channel	Tune-up limit (dBm)
Channel				23780	23790	23800	
Frequency (MHz)				709	710	711	
10	QPSK	1	0	23.40	23.24	23.24	24.00
10	QPSK	1	25	23.40	23.35	23.35	
10	QPSK	1	49	23.43	23.39	23.39	
10	QPSK	25	0	22.44	22.40	22.40	23.00
10	QPSK	25	12	22.35	22.45	22.44	
10	QPSK	25	25	22.38	22.42	22.42	
10	QPSK	50	0	22.44	22.47	22.47	
10	16QAM	1	0	22.71	22.73	22.73	23.00
10	16QAM	1	25	22.59	22.59	22.59	
10	16QAM	1	49	22.80	22.77	22.77	
10	16QAM	25	0	21.41	21.46	21.46	22.00
10	16QAM	25	12	21.49	21.46	21.46	



10	16QAM	25	25	21.47	21.50	21.50	
10	16QAM	50	0	21.50	21.48	21.48	
10	64QAM	1	0	22.39	22.32	22.32	23.00
10	64QAM	1	25	22.59	22.68	22.68	
10	64QAM	1	49	22.75	22.76	22.74	
10	64QAM	25	0	21.42	21.55	21.55	22.00
10	64QAM	25	12	21.51	21.50	21.50	
10	64QAM	25	25	21.39	21.46	21.46	
10	64QAM	50	0	21.45	21.41	21.41	
Channel				23755	23790	23825	Tune-up limit (dBm)
Frequency (MHz)				706.5	710	713.5	
5	QPSK	1	0	23.24	23.42	23.34	24.00
5	QPSK	1	12	23.36	23.40	23.42	
5	QPSK	1	24	23.31	23.41	23.41	
5	QPSK	12	0	22.32	22.42	22.38	23.00
5	QPSK	12	7	22.42	22.37	22.44	
5	QPSK	12	13	22.41	22.35	22.48	
5	QPSK	25	0	22.36	22.36	22.44	
5	16QAM	1	0	22.52	22.43	22.69	23.00
5	16QAM	1	12	22.68	22.54	22.69	
5	16QAM	1	24	22.79	22.51	22.70	
5	16QAM	12	0	21.39	21.49	21.48	22.00
5	16QAM	12	7	21.58	21.50	21.70	
5	16QAM	12	13	21.44	21.45	21.61	
5	16QAM	25	0	21.53	21.51	21.46	
5	64QAM	1	0	22.28	22.72	22.60	23.00
5	64QAM	1	12	22.29	22.72	22.49	
5	64QAM	1	24	22.53	22.75	22.43	
5	64QAM	12	0	21.30	21.47	21.56	22.00
5	64QAM	12	7	21.51	21.46	21.60	
5	64QAM	12	13	21.44	21.46	21.57	
5	64QAM	25	0	21.41	21.52	21.51	



<FDD-LTE Band 25>

BW [MHz]	Modulation	RB Size	RB Offset	Low Channel	Middle Channel	High Channel	Tune-up limit (dBm)
Channel				26140	26365	26590	
Frequency (MHz)				1860	1882.5	1905	
20	QPSK	1	0	21.96	21.98	21.62	22.50
20	QPSK	1	49	22.07	21.78	21.78	
20	QPSK	1	99	21.79	21.67	21.67	
20	QPSK	50	0	21.05	20.87	20.63	21.50
20	QPSK	50	24	20.96	20.78	20.79	
20	QPSK	50	50	20.80	20.77	20.77	
20	QPSK	100	0	20.94	20.76	20.75	
20	16QAM	1	0	21.53	21.47	21.19	21.50
20	16QAM	1	49	21.20	21.57	21.24	
20	16QAM	1	99	21.20	21.26	21.09	
20	16QAM	50	0	20.15	19.97	19.88	20.50
20	16QAM	50	24	20.05	19.96	19.87	
20	16QAM	50	50	20.00	19.89	19.92	
20	16QAM	100	0	20.07	19.82	19.87	
20	64QAM	1	0	20.97	21.37	20.98	22.00
20	64QAM	1	49	21.38	21.02	21.00	
20	64QAM	1	99	21.05	21.15	20.88	
20	64QAM	50	0	20.21	19.93	19.75	21.00
20	64QAM	50	24	20.16	19.99	20.01	
20	64QAM	50	50	19.93	19.84	19.96	
20	64QAM	100	0	20.11	20.08	19.97	
Channel				26115	26365	26615	
Frequency (MHz)				1857.5	1882.5	1907.5	
15	QPSK	1	0	21.97	21.83	21.73	22.50
15	QPSK	1	37	21.94	21.93	21.70	
15	QPSK	1	74	21.92	21.83	21.73	
15	QPSK	36	0	21.06	20.81	20.80	21.50
15	QPSK	36	20	21.12	20.97	20.91	
15	QPSK	36	39	21.01	20.88	20.85	
15	QPSK	75	0	20.90	20.95	20.81	
15	16QAM	1	0	21.60	21.20	21.22	21.50
15	16QAM	1	37	21.34	21.26	21.44	



15	16QAM	1	74	21.47	21.55	21.17	
15	16QAM	36	0	20.14	20.03	20.01	20.50
15	16QAM	36	20	20.22	20.03	20.01	
15	16QAM	36	39	20.07	20.02	19.93	
15	16QAM	75	0	20.11	20.02	19.93	
15	64QAM	1	0	21.20	21.01	20.96	
15	64QAM	1	37	21.14	20.82	21.23	22.00
15	64QAM	1	74	21.02	20.79	20.85	
15	64QAM	36	0	20.20	19.99	19.87	
15	64QAM	36	20	20.25	20.05	20.03	21.00
15	64QAM	36	39	20.00	20.06	19.83	
15	64QAM	75	0	20.05	19.88	19.76	
Channel				26090	26365	26640	
Frequency (MHz)				1855	1882.5	1910	
10	QPSK	1	0	22.07	21.74	21.77	22.50
10	QPSK	1	25	21.93	21.82	21.65	
10	QPSK	1	49	22.00	21.88	21.78	
10	QPSK	25	0	21.05	20.73	20.63	21.50
10	QPSK	25	12	20.97	20.73	20.79	
10	QPSK	25	25	20.89	20.75	20.71	
10	QPSK	50	0	20.97	20.79	20.72	
10	16QAM	1	0	21.47	21.48	21.03	21.50
10	16QAM	1	25	21.47	21.09	21.07	
10	16QAM	1	49	21.41	21.01	21.25	
10	16QAM	25	0	20.23	19.95	19.89	20.50
10	16QAM	25	12	20.11	19.93	19.89	
10	16QAM	25	25	20.15	19.98	19.85	
10	16QAM	50	0	20.06	19.88	19.95	
10	64QAM	1	0	21.31	21.20	20.89	22.00
10	64QAM	1	25	21.39	21.14	21.23	
10	64QAM	1	49	21.26	20.91	20.90	
10	64QAM	25	0	20.10	19.99	19.95	21.00
10	64QAM	25	12	20.24	20.05	19.91	
10	64QAM	25	25	20.12	19.90	19.96	
10	64QAM	50	0	20.02	19.91	19.78	
Channel				26065	26365	26665	Tune-up limit
Frequency (MHz)				1852.5	1882.5	1912.5	



							(dBm)
5	QPSK	1	0	21.88	21.69	21.67	22.50
5	QPSK	1	12	21.99	21.78	21.65	
5	QPSK	1	24	21.97	21.72	21.72	
5	QPSK	12	0	21.03	20.85	20.66	21.50
5	QPSK	12	7	21.11	20.80	20.78	
5	QPSK	12	13	20.97	20.78	20.67	
5	QPSK	25	0	21.03	20.82	20.79	
5	16QAM	1	0	21.06	21.31	21.34	21.50
5	16QAM	1	12	21.05	21.44	20.97	
5	16QAM	1	24	21.33	21.45	21.06	
5	16QAM	12	0	20.15	20.06	20.03	20.50
5	16QAM	12	7	20.45	20.12	20.00	
5	16QAM	12	13	20.27	20.11	20.10	
5	16QAM	25	0	20.08	20.00	19.83	
5	64QAM	1	0	21.44	21.02	21.07	22.00
5	64QAM	1	12	21.29	21.24	21.03	
5	64QAM	1	24	21.21	21.14	21.08	
5	64QAM	12	0	20.28	20.01	19.95	21.00
5	64QAM	12	7	20.20	20.11	19.95	
5	64QAM	12	13	20.27	19.95	19.79	
5	64QAM	25	0	20.05	20.08	19.89	
Channel				26055	26365	26675	Tune-up limit (dBm)
Frequency (MHz)				1851.5	1882.5	1913.5	
3	QPSK	1	0	21.98	21.66	21.75	22.50
3	QPSK	1	8	21.95	21.86	21.65	
3	QPSK	1	14	21.89	21.56	21.74	
3	QPSK	8	0	21.02	20.79	20.72	21.50
3	QPSK	8	4	21.07	20.81	20.72	
3	QPSK	8	7	20.95	20.86	20.73	
3	QPSK	15	0	20.94	21.03	20.78	
3	16QAM	1	0	21.23	20.96	21.32	21.50
3	16QAM	1	8	21.42	21.03	20.94	
3	16QAM	1	14	21.08	21.27	21.32	
3	16QAM	8	0	20.01	19.99	19.92	20.50
3	16QAM	8	4	20.23	20.06	19.97	
3	16QAM	8	7	20.23	20.06	19.99	



3	16QAM	15	0	20.17	20.05	19.99	
3	64QAM	1	0	21.42	21.35	20.92	22.00
3	64QAM	1	8	21.34	21.01	20.95	
3	64QAM	1	14	21.04	20.97	20.93	
3	64QAM	8	0	20.11	20.03	19.97	21.00
3	64QAM	8	4	20.25	20.01	19.80	
3	64QAM	8	7	20.28	19.95	19.95	
3	64QAM	15	0	20.28	19.96	19.78	
Channel				26047	26365	26683	Tune-up limit (dBm)
Frequency (MHz)				1850.7	1882.5	1914.3	
1.4	QPSK	1	0	21.95	21.68	21.55	22.50
1.4	QPSK	1	3	22.01	21.79	21.68	
1.4	QPSK	1	5	21.98	21.65	21.60	
1.4	QPSK	3	0	21.94	21.66	21.58	
1.4	QPSK	3	1	21.96	21.77	21.71	
1.4	QPSK	3	3	21.92	21.70	21.65	
1.4	QPSK	6	0	20.88	20.64	20.71	21.50
1.4	16QAM	1	0	21.35	20.88	21.03	21.50
1.4	16QAM	1	3	21.32	21.25	20.96	
1.4	16QAM	1	5	21.27	20.90	20.92	
1.4	16QAM	3	0	21.13	20.96	20.82	
1.4	16QAM	3	1	20.97	20.96	20.91	
1.4	16QAM	3	3	21.26	20.92	20.76	
1.4	16QAM	6	0	20.24	19.80	19.85	20.50
1.4	64QAM	1	0	21.25	20.83	20.81	22.00
1.4	64QAM	1	3	21.23	20.85	20.94	
1.4	64QAM	1	5	21.29	21.02	20.88	
1.4	64QAM	3	0	21.22	21.03	20.79	
1.4	64QAM	3	1	21.08	20.94	20.89	
1.4	64QAM	3	3	21.12	20.82	20.93	
1.4	64QAM	6	0	20.09	19.90	19.82	21.00



<FDD-LTE Band 26>

BW [MHz]	Modulation	RB Size	RB Offset	Low Channel	Middle Channel	High Channel	Tune-up limit (dBm)
Channel				26765	26865	26965	
Frequency (MHz)				821.5	831.5	841.5	
15	QPSK	1	0	23.42	23.41	23.40	24.00
15	QPSK	1	37	23.40	23.48	23.51	
15	QPSK	1	74	23.31	23.39	23.34	
15	QPSK	36	0	22.54	22.57	22.37	23.00
15	QPSK	36	20	22.58	22.54	22.52	
15	QPSK	36	39	22.48	22.53	22.46	
15	QPSK	75	0	22.56	22.47	22.52	
15	16QAM	1	0	22.44	22.85	22.55	23.00
15	16QAM	1	37	22.78	22.69	22.63	
15	16QAM	1	74	22.65	22.88	22.69	
15	16QAM	36	0	21.54	21.57	21.48	22.00
15	16QAM	36	20	21.64	21.50	21.62	
15	16QAM	36	39	21.54	21.51	21.55	
15	16QAM	75	0	21.63	21.57	21.55	
15	64QAM	1	0	22.56	22.63	22.54	23.00
15	64QAM	1	37	22.58	22.57	22.51	
15	64QAM	1	74	22.74	22.41	22.28	
15	64QAM	36	0	21.55	21.58	21.46	22.00
15	64QAM	36	20	21.62	21.51	21.57	
15	64QAM	36	39	21.50	21.52	21.55	
15	64QAM	75	0	21.50	21.54	21.53	
Channel				26740	26865	26990	Tune-up limit (dBm)
Frequency (MHz)				819	831.5	844	
10	QPSK	1	0	23.50	23.33	23.51	24.00
10	QPSK	1	25	23.46	23.45	23.50	
10	QPSK	1	49	23.35	23.40	23.43	
10	QPSK	25	0	22.56	22.58	22.46	23.00
10	QPSK	25	12	22.54	22.54	22.49	
10	QPSK	25	25	22.44	22.47	22.46	
10	QPSK	50	0	22.55	22.50	22.49	
10	16QAM	1	0	22.53	22.87	22.60	23.00
10	16QAM	1	25	22.51	22.55	22.67	



10	16QAM	1	49	22.68	22.44	22.40	
10	16QAM	25	0	21.62	21.53	21.63	22.00
10	16QAM	25	12	21.57	21.63	21.60	
10	16QAM	25	25	21.42	21.63	21.64	
10	16QAM	50	0	21.54	21.60	21.57	
10	64QAM	1	0	22.56	22.52	22.62	
10	64QAM	1	25	22.68	22.58	22.90	23.00
10	64QAM	1	49	22.41	22.48	22.40	
10	64QAM	25	0	21.62	21.55	21.59	
10	64QAM	25	12	21.53	21.59	21.52	22.00
10	64QAM	25	25	21.56	21.57	21.67	
10	64QAM	50	0	21.60	21.58	21.59	
Channel				26715	26865	27015	Tune-up limit (dBm)
Frequency (MHz)				816.5	831.5	846.5	
5	QPSK	1	0	23.38	23.46	23.46	24.00
5	QPSK	1	12	23.37	23.40	23.51	
5	QPSK	1	24	23.50	23.41	23.50	
5	QPSK	12	0	22.46	22.57	22.59	23.00
5	QPSK	12	7	22.45	22.54	22.56	
5	QPSK	12	13	22.48	22.45	22.50	
5	QPSK	25	0	22.52	22.56	22.57	
5	16QAM	1	0	22.85	22.59	22.90	23.00
5	16QAM	1	12	22.85	22.57	23.00	
5	16QAM	1	24	22.73	22.57	22.70	
5	16QAM	12	0	21.53	21.58	21.69	22.00
5	16QAM	12	7	21.52	21.55	21.68	
5	16QAM	12	13	21.50	21.49	21.52	
5	16QAM	25	0	21.62	21.50	21.52	
5	64QAM	1	0	22.76	22.61	22.74	23.00
5	64QAM	1	12	22.41	22.90	22.58	
5	64QAM	1	24	22.41	22.81	22.54	
5	64QAM	12	0	21.53	21.53	21.61	22.00
5	64QAM	12	7	21.43	21.46	21.55	
5	64QAM	12	13	21.44	21.57	21.60	
5	64QAM	25	0	21.57	21.52	21.63	
Channel				26705	26865	27025	Tune-up limit
Frequency (MHz)				815.5	831.5	847.5	



							(dBm)
3	QPSK	1	0	23.29	23.40	23.47	24.00
3	QPSK	1	8	23.42	23.41	23.46	
3	QPSK	1	14	23.45	23.37	23.34	
3	QPSK	8	0	22.50	22.53	22.55	23.00
3	QPSK	8	4	22.44	22.58	22.42	
3	QPSK	8	7	22.45	22.47	22.53	
3	QPSK	15	0	22.48	22.48	22.53	
3	16QAM	1	0	22.46	22.43	22.89	23.00
3	16QAM	1	8	22.50	22.52	22.85	
3	16QAM	1	14	22.40	22.51	22.62	
3	16QAM	8	0	21.46	21.60	21.56	22.00
3	16QAM	8	4	21.50	21.65	21.46	
3	16QAM	8	7	21.45	21.64	21.63	
3	16QAM	15	0	21.49	21.71	21.68	
3	64QAM	1	0	22.24	22.39	22.35	23.00
3	64QAM	1	8	22.22	22.33	22.58	
3	64QAM	1	14	22.38	22.32	22.71	
3	64QAM	8	0	21.37	21.57	21.76	22.00
3	64QAM	8	4	21.45	21.53	21.53	
3	64QAM	8	7	21.35	21.50	21.48	
3	64QAM	15	0	21.50	21.50	21.56	
Channel				26697	26865	27033	Tune-up limit (dBm)
Frequency (MHz)				814.7	831.5	848.3	
1.4	QPSK	1	0	23.32	23.40	23.37	24.00
1.4	QPSK	1	3	23.39	23.51	23.38	
1.4	QPSK	1	5	23.40	23.35	23.33	
1.4	QPSK	3	0	23.29	23.35	23.48	
1.4	QPSK	3	1	23.33	23.50	23.41	
1.4	QPSK	3	3	23.39	23.42	23.42	
1.4	QPSK	6	0	22.39	22.45	22.52	23.00
1.4	16QAM	1	0	22.49	22.65	22.59	23.00
1.4	16QAM	1	3	22.86	22.48	22.45	
1.4	16QAM	1	5	22.66	22.58	22.44	
1.4	16QAM	3	0	22.39	22.45	22.47	
1.4	16QAM	3	1	22.43	22.56	22.38	
1.4	16QAM	3	3	22.26	22.27	22.34	



1.4	16QAM	6	0	21.48	21.50	21.70	22.00
1.4	64QAM	1	0	22.28	22.74	22.42	23.00
1.4	64QAM	1	3	22.52	22.68	22.42	
1.4	64QAM	1	5	22.42	22.40	22.40	
1.4	64QAM	3	0	22.51	22.60	22.27	
1.4	64QAM	3	1	22.50	22.27	22.50	
1.4	64QAM	3	3	22.43	22.71	22.35	
1.4	64QAM	6	0	21.55	21.43	21.59	22.00

<FDD-LTE Band 30>

BW [MHz]	Modulation	RB Size	RB Offset	Low Channel	Middle Channel	High Channel	Tune-up limit (dBm)
Channel				27710			Tune-up limit (dBm)
Frequency (MHz)				2310			
10	QPSK	1	0	23.29			24.00
10	QPSK	1	25	23.19			
10	QPSK	1	49	23.39			
10	QPSK	25	0	22.32			23.00
10	QPSK	25	12	22.38			
10	QPSK	25	25	22.27			
10	QPSK	50	0	22.32			
10	16QAM	1	0	22.85			23.00
10	16QAM	1	25	22.45			
10	16QAM	1	49	22.44			
10	16QAM	25	0	21.27			22.00
10	16QAM	25	12	21.28			
10	16QAM	25	25	21.43			
10	16QAM	50	0	21.33			
10	64QAM	1	0	22.54			23.00
10	64QAM	1	25	22.39			
10	64QAM	1	49	22.39			
10	64QAM	25	0	21.34			22.00
10	64QAM	25	12	21.32			
10	64QAM	25	25	21.32			
10	64QAM	50	0	21.30			
Channel				27685	27710	27735	Tune-up limit (dBm)
Frequency (MHz)				2307.5	2310	2312.5	



5	QPSK	1	0	23.26	23.28	23.33	24.00
5	QPSK	1	12	23.32	23.25	23.23	
5	QPSK	1	24	23.39	23.24	23.21	
5	QPSK	12	0	22.29	22.31	22.28	23.00
5	QPSK	12	7	22.28	22.32	22.27	
5	QPSK	12	13	22.23	22.30	22.28	
5	QPSK	25	0	23.31	23.25	23.27	23.00
5	16QAM	1	0	22.66	22.63	22.74	
5	16QAM	1	12	22.65	22.64	22.26	
5	16QAM	1	24	22.64	22.63	22.46	22.00
5	16QAM	12	0	21.23	21.26	21.39	
5	16QAM	12	7	21.37	21.37	21.23	
5	16QAM	12	13	21.30	21.24	21.35	22.00
5	16QAM	25	0	22.34	22.34	22.36	
5	64QAM	1	0	22.32	22.49	22.57	
5	64QAM	1	12	22.36	22.50	22.50	23.00
5	64QAM	1	24	22.43	22.14	22.51	
5	64QAM	12	0	21.31	21.36	21.28	
5	64QAM	12	7	21.30	21.44	21.21	22.00
5	64QAM	12	13	21.29	21.26	21.26	
5	64QAM	25	0	21.56	21.25	21.28	

<TDD-LTE Band 41>

BW [MHz]	Modulation	RB Size	RB Offset	Low Channel	Low Middle Channel	Middle Channel	High Middle Channel	High Channel	Tune-up limit (dBm)
Channel				39750	40185	40620	41055	41490	
Frequency (MHz)				2506	2549.5	2593	2636.5	2680	
20	QPSK	1	0	25.57	25.65	26.34	25.95	25.27	27.00
20	QPSK	1	49	25.80	26.16	26.57	26.17	25.98	
20	QPSK	1	99	25.87	26.04	26.30	25.78	25.55	
20	QPSK	50	0	25.66	25.95	25.97	25.91	25.89	26.50
20	QPSK	50	24	25.67	25.94	25.96	25.88	25.95	
20	QPSK	50	50	25.43	25.93	25.91	25.80	25.90	
20	QPSK	100	0	25.53	25.89	25.77	25.86	25.73	26.00
20	16QAM	1	0	24.47	25.03	25.64	25.29	24.56	
20	16QAM	1	49	24.76	25.63	25.54	25.63	25.44	
20	16QAM	1	99	24.25	25.46	25.45	25.23	24.95	



20	16QAM	50	0	24.56	24.79	24.93	24.88	24.55	26.00
20	16QAM	50	24	24.77	24.97	24.69	24.76	24.84	
20	16QAM	50	50	24.64	24.92	24.90	24.70	24.79	
20	16QAM	100	0	24.74	24.70	24.91	24.53	24.72	
20	64QAM	1	0	24.45	25.10	25.65	25.36	24.69	26.00
20	64QAM	1	49	24.79	25.63	25.59	25.49	25.56	
20	64QAM	1	99	24.27	25.49	25.44	25.30	25.05	
20	64QAM	50	0	24.75	24.74	24.91	24.56	24.79	25.00
20	64QAM	50	24	24.76	24.93	24.91	24.77	24.81	
20	64QAM	50	50	24.58	24.68	24.80	24.65	24.56	
20	64QAM	100	0	24.78	24.97	24.83	24.87	24.82	
Channel				39725	40173	40620	41068	41515	Tune-up limit (dBm)
Frequency (MHz)				2503.5	2548.3	2593	2637.8	2682.5	
15	QPSK	1	0	25.31	25.84	26.53	25.97	25.65	27.00
15	QPSK	1	37	25.42	26.17	26.54	26.14	26.02	
15	QPSK	1	74	25.45	26.08	26.50	25.88	25.86	
15	QPSK	36	0	25.60	25.79	25.84	25.60	25.77	26.00
15	QPSK	36	20	25.60	25.88	25.85	25.63	25.79	
15	QPSK	36	39	25.39	25.76	25.81	25.70	25.68	
15	QPSK	75	0	25.46	25.85	25.86	25.67	25.71	
15	16QAM	1	0	24.50	25.18	25.77	25.20	24.94	26.00
15	16QAM	1	37	24.63	25.55	25.65	25.31	25.37	
15	16QAM	1	74	24.21	25.38	25.46	25.24	25.23	
15	16QAM	36	0	24.43	24.71	24.69	24.55	24.55	26.00
15	16QAM	36	20	24.57	24.63	24.69	24.49	24.59	
15	16QAM	36	39	24.37	24.63	24.68	24.59	24.55	
15	16QAM	75	0	24.67	24.84	24.88	24.49	24.71	
15	64QAM	1	0	24.51	25.26	25.70	25.31	25.05	26.00
15	64QAM	1	37	24.72	25.63	25.72	25.54	25.49	
15	64QAM	1	74	24.51	24.71	24.70	24.70	24.71	
15	64QAM	36	0	24.57	24.84	24.71	24.48	24.78	25.00
15	64QAM	36	20	24.49	24.78	24.83	24.43	24.67	
15	64QAM	36	39	24.64	24.84	24.70	24.61	24.65	
15	64QAM	75	0	24.55	24.78	24.68	24.32	24.58	
Channel				39700	40160	40620	41080	41540	Tune-up limit (dBm)
Frequency (MHz)				2501	2547	2593	2639	2685	



10	QPSK	1	0	25.44	25.87	26.51	25.99	25.79	27.00
10	QPSK	1	25	25.35	26.03	26.55	26.05	25.94	
10	QPSK	1	49	25.09	26.05	26.59	25.91	25.90	
10	QPSK	25	0	25.63	25.87	25.98	25.78	25.94	26.00
10	QPSK	25	12	25.60	25.94	25.85	25.91	25.99	
10	QPSK	25	25	25.37	25.82	25.93	25.77	25.90	
10	QPSK	50	0	25.49	25.92	25.96	25.77	25.84	26.00
10	16QAM	1	0	24.67	25.31	25.67	25.39	25.18	
10	16QAM	1	25	24.67	25.47	25.53	25.50	25.41	
10	16QAM	1	49	24.41	25.51	25.71	25.39	25.36	26.00
10	16QAM	25	0	24.57	24.54	24.79	24.69	24.79	
10	16QAM	25	12	24.63	24.78	24.92	24.67	24.73	
10	16QAM	25	25	24.55	24.68	24.74	24.74	24.72	26.00
10	16QAM	50	0	24.48	24.75	24.90	24.78	24.82	
10	64QAM	1	0	24.73	25.41	25.71	25.45	25.28	
10	64QAM	1	25	24.72	25.50	25.60	25.55	25.47	26.00
10	64QAM	1	49	24.44	25.57	25.78	25.42	25.42	
10	64QAM	25	0	24.54	24.68	24.80	24.63	24.70	
10	64QAM	25	12	24.55	24.76	24.86	24.60	24.69	25.00
10	64QAM	25	25	24.55	24.62	24.67	24.68	24.67	
10	64QAM	50	0	24.64	24.56	24.79	24.72	24.76	
Channel				39675	40148	40620	41093	41565	Tune-up limit (dBm)
Frequency (MHz)				2498.5	2545.8	2593	2640.30	2687.5	
5	QPSK	1	0	25.71	26.05	26.43	26.15	26.04	27.00
5	QPSK	1	12	25.38	26.00	26.54	26.01	25.91	
5	QPSK	1	24	25.38	25.98	25.93	25.98	25.99	
5	QPSK	12	0	25.68	25.89	25.95	25.77	25.92	26.00
5	QPSK	12	7	25.66	25.85	25.92	25.81	25.93	
5	QPSK	12	13	25.61	25.78	25.85	25.90	25.91	
5	QPSK	25	0	25.59	25.77	25.91	25.78	25.87	26.00
5	16QAM	1	0	24.91	25.51	25.70	25.54	25.42	
5	16QAM	1	12	24.64	25.49	25.64	25.47	25.40	
5	16QAM	1	24	24.74	25.57	25.51	25.54	25.51	26.00
5	16QAM	12	0	24.58	24.61	24.79	24.53	24.74	
5	16QAM	12	7	24.64	24.68	24.78	24.76	24.70	
5	16QAM	12	13	24.61	24.71	24.81	24.64	24.68	26.00
5	16QAM	25	0	24.62	24.64	24.74	24.55	24.61	



5	64QAM	1	0	25.02	25.53	25.63	25.51	25.52	26.00
5	64QAM	1	12	24.73	25.54	25.76	25.54	25.46	
5	64QAM	1	24	24.79	25.61	25.69	25.61	25.57	
5	64QAM	12	0	24.54	24.67	24.77	24.64	24.73	25.00
5	64QAM	12	7	24.61	24.69	24.85	24.69	24.75	
5	64QAM	12	13	24.52	24.75	24.80	24.66	24.67	
5	64QAM	25	0	24.53	24.71	24.69	24.49	24.55	

<FDD-LTE Band 66>

BW [MHz]	Modulation	RB Size	RB Offset	Low Channel	Middle Channel	High Channel	Tune-up limit (dBm)
Channel				132072	132322	132572	22.00
Frequency (MHz)				1720	1745	1770	
20	QPSK	1	0	20.97	20.91	20.82	21.00
20	QPSK	1	49	20.88	20.81	20.68	
20	QPSK	1	99	20.91	20.54	20.53	
20	QPSK	50	0	19.90	19.89	19.68	21.00
20	QPSK	50	24	19.88	19.84	19.71	
20	QPSK	50	50	19.86	19.77	19.63	
20	QPSK	100	0	19.92	19.81	19.67	
20	16QAM	1	0	20.21	20.39	20.41	21.00
20	16QAM	1	49	20.35	20.23	20.09	
20	16QAM	1	99	20.41	20.20	20.13	
20	16QAM	50	0	18.98	19.03	18.84	20.00
20	16QAM	50	24	19.00	18.94	18.84	
20	16QAM	50	50	19.02	18.88	18.73	
20	16QAM	100	0	19.00	18.94	18.80	
20	64QAM	1	0	20.24	20.32	20.27	21.00
20	64QAM	1	49	20.29	20.23	19.97	
20	64QAM	1	99	20.33	20.18	20.05	
20	64QAM	50	0	18.91	18.95	18.75	20.00
20	64QAM	50	24	18.98	18.94	18.74	
20	64QAM	50	50	18.95	18.89	18.74	
20	64QAM	100	0	18.98	18.92	18.85	
Channel				132047	132322	132597	22.00
Frequency (MHz)				1717.5	1745	1772.5	
15	QPSK	1	0	20.85	20.79	20.70	22.00



15	QPSK	1	37	20.76	20.69	20.56	
15	QPSK	1	74	20.79	20.42	20.41	
15	QPSK	36	0	19.78	19.77	19.56	
15	QPSK	36	20	19.76	19.72	19.59	21.00
15	QPSK	36	39	19.74	19.65	19.51	
15	QPSK	75	0	19.80	19.69	19.55	
15	16QAM	1	0	20.09	20.27	20.29	21.00
15	16QAM	1	37	20.23	20.11	19.97	
15	16QAM	1	74	20.29	20.08	20.01	
15	16QAM	36	0	18.86	18.91	18.72	20.00
15	16QAM	36	20	18.88	18.82	18.72	
15	16QAM	36	39	18.90	18.76	18.61	
15	16QAM	75	0	18.88	18.82	18.68	
15	64QAM	1	0	20.12	20.20	20.15	
15	64QAM	1	37	20.17	20.11	19.85	21.00
15	64QAM	1	74	20.21	20.06	19.93	
15	64QAM	36	0	18.79	18.83	18.63	
15	64QAM	36	20	18.86	18.82	18.62	20.00
15	64QAM	36	39	18.83	18.77	18.62	
15	64QAM	75	0	18.86	18.80	18.73	
Channel				132022	132322	132622	Tune-up limit (dBm)
Frequency (MHz)				1715	1745	1775	
10	QPSK	1	0	20.78	20.72	20.63	22.00
10	QPSK	1	25	20.69	20.62	20.49	
10	QPSK	1	49	20.72	20.35	20.34	
10	QPSK	25	0	19.71	19.70	19.49	21.00
10	QPSK	25	12	19.69	19.65	19.52	
10	QPSK	25	25	19.67	19.58	19.44	
10	QPSK	50	0	19.73	19.62	19.48	
10	16QAM	1	0	20.02	20.20	20.22	21.00
10	16QAM	1	25	20.16	20.04	19.90	
10	16QAM	1	49	20.22	20.01	19.94	
10	16QAM	25	0	18.79	18.84	18.65	20.00
10	16QAM	25	12	18.81	18.75	18.65	
10	16QAM	25	25	18.83	18.69	18.54	
10	16QAM	50	0	18.81	18.75	18.61	
10	64QAM	1	0	20.05	20.13	20.08	21.00



10	64QAM	1	25	20.10	20.04	19.78	20.00
10	64QAM	1	49	20.14	19.99	19.86	
10	64QAM	25	0	18.72	18.76	18.56	
10	64QAM	25	12	18.79	18.75	18.55	
10	64QAM	25	25	18.76	18.70	18.55	
10	64QAM	50	0	18.79	18.73	18.66	
Channel				131997	132322	132647	Tune-up limit (dBm)
Frequency (MHz)				1712.5	1745	1777.5	
5	QPSK	1	0	20.88	20.82	20.73	22.00
5	QPSK	1	12	20.79	20.72	20.59	
5	QPSK	1	24	20.82	20.45	20.44	
5	QPSK	12	0	19.81	19.80	19.59	21.00
5	QPSK	12	7	19.79	19.75	19.62	
5	QPSK	12	13	19.77	19.68	19.54	
5	QPSK	25	0	19.83	19.72	19.58	
5	16QAM	1	0	20.12	20.30	20.32	21.00
5	16QAM	1	12	20.26	20.14	20.00	
5	16QAM	1	24	20.32	20.11	20.04	
5	16QAM	12	0	18.89	18.94	18.75	20.00
5	16QAM	12	7	18.91	18.85	18.75	
5	16QAM	12	13	18.93	18.79	18.64	
5	16QAM	25	0	18.91	18.85	18.71	
5	64QAM	1	0	20.15	20.23	20.18	21.00
5	64QAM	1	12	20.20	20.14	19.88	
5	64QAM	1	24	20.24	20.09	19.96	
5	64QAM	12	0	18.82	18.86	18.66	20.00
5	64QAM	12	7	18.89	18.85	18.65	
5	64QAM	12	13	18.86	18.80	18.65	
5	64QAM	25	0	18.89	18.83	18.76	
Channel				131987	132322	132657	Tune-up limit (dBm)
Frequency (MHz)				1711.5	1745	1778.5	
3	QPSK	1	0	20.94	20.88	20.79	22.00
3	QPSK	1	8	20.85	20.78	20.65	
3	QPSK	1	14	20.88	20.51	20.50	
3	QPSK	8	0	19.87	19.86	19.65	21.00
3	QPSK	8	4	19.85	19.81	19.68	



3	QPSK	8	7	19.83	19.74	19.60	
3	QPSK	15	0	19.89	19.78	19.64	
3	16QAM	1	0	20.18	20.36	20.38	21.00
3	16QAM	1	8	20.32	20.20	20.06	
3	16QAM	1	14	20.38	20.17	20.10	
3	16QAM	8	0	18.95	19.00	18.81	20.00
3	16QAM	8	4	18.97	18.91	18.81	
3	16QAM	8	7	18.99	18.85	18.70	
3	16QAM	15	0	18.97	18.91	18.77	
3	64QAM	1	0	20.21	20.29	20.24	21.00
3	64QAM	1	8	20.26	20.20	19.94	
3	64QAM	1	14	20.30	20.15	20.02	
3	64QAM	8	0	18.88	18.92	18.72	20.00
3	64QAM	8	4	18.95	18.91	18.71	
3	64QAM	8	7	18.92	18.86	18.71	
3	64QAM	15	0	18.95	18.89	18.82	
Channel				131979	132322	132665	Tune-up limit (dBm)
Frequency (MHz)				1710.7	1745	1779.3	
1.4	QPSK	1	0	20.76	20.70	20.61	22.00
1.4	QPSK	1	3	20.67	20.60	20.47	
1.4	QPSK	1	5	20.70	20.33	20.32	
1.4	QPSK	3	0	19.69	19.68	19.47	
1.4	QPSK	3	1	19.67	19.63	19.50	
1.4	QPSK	3	3	19.65	19.56	19.42	
1.4	QPSK	6	0	19.71	19.60	19.46	21.00
1.4	16QAM	1	0	20.00	20.18	20.20	21.00
1.4	16QAM	1	3	20.14	20.02	19.88	
1.4	16QAM	1	5	20.20	19.99	19.92	
1.4	16QAM	3	0	18.77	18.82	18.63	
1.4	16QAM	3	1	18.79	18.73	18.63	
1.4	16QAM	3	3	18.81	18.67	18.52	
1.4	16QAM	6	0	18.79	18.73	18.69	20.00
1.4	64QAM	1	0	19.03	19.11	19.06	21.00
1.4	64QAM	1	3	19.08	19.02	18.76	
1.4	64QAM	1	5	19.12	18.97	18.84	
1.4	64QAM	3	0	18.70	18.74	18.84	
1.4	64QAM	3	1	18.77	18.73	18.83	



1.4	64QAM	3	3	18.74	18.68	18.73	
1.4	64QAM	6	0	18.77	18.71	18.64	20.00

<FDD-LTE Band 71>

BW [MHz]	Modulation	RB Size	RB Offset	Low Channel	Middle Channel	High Channel	Tune-up limit (dBm)
Channel				133222	133322	133372	
Frequency (MHz)				673	680.5	688	
20	QPSK	1	0	23.90	23.71	23.77	24.50
20	QPSK	1	49	23.56	23.39	23.34	
20	QPSK	1	99	23.48	23.37	23.41	
20	QPSK	50	0	22.99	22.80	22.77	23.50
20	QPSK	50	24	22.65	22.48	22.43	
20	QPSK	50	50	22.57	22.46	22.50	
20	QPSK	100	0	22.60	22.52	22.48	
20	16QAM	1	0	22.89	22.80	22.83	23.00
20	16QAM	1	49	22.95	22.78	22.73	
20	16QAM	1	99	22.87	22.76	22.80	
20	16QAM	50	0	22.90	22.82	22.78	23.00
20	16QAM	50	24	22.88	22.39	22.42	
20	16QAM	50	50	22.54	22.37	22.32	
20	16QAM	100	0	22.46	22.35	22.39	
20	64QAM	1	0	23.23	23.15	23.11	23.00
20	64QAM	1	49	23.21	22.72	22.75	
20	64QAM	1	99	22.87	22.70	22.65	
20	64QAM	50	0	22.91	22.83	22.79	23.00
20	64QAM	50	24	22.89	22.40	22.43	
20	64QAM	50	50	22.55	22.38	22.33	
20	64QAM	100	0	22.58	22.40	22.40	
Channel				133297	133397	133497	Tune-up limit (dBm)
Frequency (MHz)				670.5	680.5	690.5	
15	QPSK	1	0	23.53	23.42	23.65	24.50
15	QPSK	1	37	23.51	23.39	23.41	
15	QPSK	1	74	23.48	23.36	23.36	
15	QPSK	36	0	22.62	22.51	22.74	23.50
15	QPSK	36	20	22.60	22.48	22.50	
15	QPSK	36	39	22.57	22.45	22.45	



15	QPSK	75	0	22.53	22.42	22.48	
15	16QAM	1	0	22.92	22.81	23.04	23.50
15	16QAM	1	37	22.90	22.78	22.80	
15	16QAM	1	74	22.87	22.75	22.75	
15	16QAM	36	0	22.83	22.72	22.78	23.00
15	16QAM	36	20	22.51	22.40	22.63	
15	16QAM	36	39	22.49	22.37	22.39	
15	16QAM	75	0	22.46	22.34	22.34	
15	64QAM	1	0	22.76	22.78	22.85	23.00
15	64QAM	1	37	22.84	22.73	22.96	
15	64QAM	1	74	22.82	22.70	22.72	
15	64QAM	36	0	22.84	22.73	22.79	23.00
15	64QAM	36	20	22.52	22.41	22.64	
15	64QAM	36	39	22.50	22.38	22.40	
15	64QAM	75	0	22.55	22.43	22.39	
Channel				133272	133397	133522	Tune-up limit (dBm)
Frequency (MHz)				668	680.5	693	
10	QPSK	1	0	23.56	23.55	23.37	24.50
10	QPSK	1	25	23.53	23.43	23.27	
10	QPSK	1	49	23.55	23.30	23.30	
10	QPSK	25	0	22.65	22.64	22.46	23.50
10	QPSK	25	12	22.62	22.52	22.36	
10	QPSK	25	25	22.64	22.39	22.39	
10	QPSK	50	0	22.61	22.47	22.42	
10	16QAM	1	0	22.95	22.94	22.76	23.50
10	16QAM	1	25	22.92	22.82	22.66	
10	16QAM	1	49	22.94	22.69	22.69	
10	16QAM	25	0	22.91	22.77	22.72	23.00
10	16QAM	25	12	22.54	22.53	22.35	
10	16QAM	25	25	22.51	22.41	22.25	
10	16QAM	50	0	22.53	22.28	22.28	
10	64QAM	1	0	22.78	22.89	22.85	23.00
10	64QAM	1	25	22.87	22.86	22.68	
10	64QAM	1	49	22.84	22.74	22.58	
10	64QAM	25	0	22.92	22.78	22.73	23.00
10	64QAM	25	12	22.55	22.54	22.36	
10	64QAM	25	25	22.52	22.42	22.26	



10	64QAM	50	0	22.49	22.41	22.35	
Channel				133247	133397	133547	Tune-up limit (dBm)
Frequency (MHz)				665.5	680.5	695.5	
5	QPSK	1	0	23.64	23.51	23.36	24.50
5	QPSK	1	12	23.62	23.44	23.33	
5	QPSK	1	24	23.52	23.32	23.16	
5	QPSK	12	0	22.73	22.60	22.45	23.50
5	QPSK	12	7	22.71	22.53	22.42	
5	QPSK	12	13	22.61	22.41	22.25	
5	QPSK	25	0	22.60	22.42	22.42	
5	16QAM	1	0	23.03	22.90	22.75	23.50
5	16QAM	1	12	23.01	22.83	22.72	
5	16QAM	1	24	22.91	22.71	22.55	
5	16QAM	12	0	22.90	22.72	22.72	23.00
5	16QAM	12	7	22.62	22.49	22.34	
5	16QAM	12	13	22.60	22.42	22.31	
5	16QAM	25	0	22.50	22.30	22.14	
5	64QAM	1	0	22.98	22.85	22.75	
5	64QAM	1	12	22.95	22.82	22.67	23.00
5	64QAM	1	24	22.93	22.75	22.64	
5	64QAM	12	0	22.91	22.73	22.73	23.00
5	64QAM	12	7	22.63	22.50	22.35	
5	64QAM	12	13	22.61	22.43	22.32	
5	64QAM	12	13	22.61	22.43	22.32	
5	64QAM	25	0	22.55	22.44	22.40	

➤ **WLAN Conducted Power**

<2.4GHz WLAN>

	Mode	Channel	Frequency (MHz)	Average power (dBm)	Tune-Up Limit	Duty Cycle %
2.4GHz WLAN	802.11b 1Mbps	CH 1	2412	18.42	18.50	100.00
		CH 6	2437	18.30	18.50	
		CH 11	2462	18.21	18.50	
	802.11g 6Mbps	CH 1	2412	17.54	18.50	100.00
		CH 6	2437	18.11	18.50	
		CH 11	2462	18.01	18.50	
	802.11n-HT20 MCS0	CH 1	2412	17.21	18.00	100.00
		CH 6	2437	17.35	18.00	
		CH 11	2462	17.19	18.00	
	802.11n-HT40 MCS0	CH 3	2422	16.86	17.50	100.00
		CH 6	2437	16.94	17.50	
		CH 9	2452	16.67	17.50	

Note:

- Per KDB 447498 D01v06, the 1-g SAR test exclusion thresholds for 100 MHz to 6 GHz at *test separation distances* ≤ 50 mm are determined by:

$[(\text{max. power of channel, including tune-up tolerance, mW}) / (\text{min. test separation distance, mm})] \cdot [\sqrt{f(\text{GHz})}] \leq 3.0$ for 1-g SAR, where

- f(GHz) is the RF channel transmit frequency in GHz
- Power and distance are rounded to the nearest mW and mm before calculation
- The result is rounded to one decimal place for comparison

Channel	Frequency (GHz)	Max. Tune-up Power (dBm)	Max. Power (mW)	Test distance (mm)	Result	exclusion thresholds for 1-g SAR
CH 1	2.412	18.50	70.79	5	21.99	3.0

- Base on the result of note1, RF exposure evaluation of 802.11 b and g mode is required.
- Per KDB 248227 D01v02r02, choose the highest output power channel to test SAR and determine further SAR exclusion.
- Per KDB 248227 D01v02r02, In the 2.4 GHz band, separate SAR procedures are applied to DSSS and OFDM configurations to simplify DSSS test requirements. SAR is not required for the following 2.4 GHz OFDM conditions:
 - 1) When KDB Publication 447498 SAR test exclusion applies to the OFDM configuration.
 - 2) When the highest reported SAR for DSSS is adjusted by the ratio of OFDM to DSSS specified maximum output power and the adjusted SAR is ≤ 1.2 W/kg.



5. The output power of all data rate were pre-scan, just the worst case (the lowest data rate) of all mode were shown in report.

<5.2GHz WLAN>

	Mode	Channel	Frequency (MHz)	Average power (dBm)	Tune-Up Limit	Duty Cycle %
5.2GHz WLAN	802.11a 6Mbps	CH 36	5180	15.81	16.50	98.10
		CH 40	5200	15.94	16.50	
		CH 48	5240	16.24	16.50	
	802.11n-HT20 MCS0	CH 36	5180	16.23	16.50	97.96
		CH 40	5200	16.16	16.50	
		CH 48	5240	16.39	17.00	
	802.11n-HT40 MCS0	CH 38	5190	14.85	15.00	96.94
		CH 46	5230	14.56	15.00	
	802.11ac-VHT20 MCS0	CH 36	5180	14.59	15.00	97.96
		CH 40	5200	14.72	15.00	
		CH 48	5240	14.88	15.00	
	802.11ac-VHT40 MCS0	CH 38	5190	15.09	15.50	96.97
		CH 46	5230	14.40	15.00	
	802.11ac-VHT80 MCS0	CH 42	5210	11.78	12.50	94.00

Note:

1. Per KDB 447498 D01v06, the 1-g SAR test exclusion thresholds for 100 MHz to 6 GHz at *test separation distances* ≤50 mm are determined by:

$$[(\text{max. power of channel, including tune-up tolerance, mW}) / (\text{min. test separation distance, mm})] \cdot [\sqrt{f(\text{GHz})}] \leq 3.0 \text{ for 1-g SAR, where}$$

- f(GHz) is the RF channel transmit frequency in GHz
- Power and distance are rounded to the nearest mW and mm before calculation
- The result is rounded to one decimal place for comparison

Channel	Frequency (GHz)	Max. Tune-up Power (dBm)	Max. Power (mW)	Test distance (mm)	Result	exclusion thresholds for 1-g SAR
CH 48	5.240	17.00	50.12	5	22.95	3.0

2. Per KDB 248227 D01v02r02, choose the highest output power channel to test SAR and determine further SAR exclusion.
3. The output power of all data rate were pre-scan, just the worst case (the lowest data rate) of all mode were shown in report.

<5.3GHz WLAN>

	Mode	Channel	Frequency (MHz)	Average power (dBm)	Tune-Up Limit	Duty Cycle %
5.3GHz WLAN	802.11a 6Mbps	CH 52	5260	16.33	17.00	98.10
		CH 60	5300	16.38	17.00	
		CH 64	5320	16.62	17.50	
	802.11n-HT20 MCS0	CH 52	5260	16.46	17.00	97.96
		CH 60	5300	16.59	17.00	
		CH 64	5320	16.51	17.00	
	802.11n-HT40 MCS0	CH 54	5270	14.99	15.50	96.94
		CH 62	5310	14.99	15.50	
	802.11ac-VHT20 MCS0	CH 52	5260	14.85	15.50	97.96
		CH 60	5300	14.57	15.50	
		CH 64	5320	15.21	15.50	
	802.11ac-VHT40 MCS0	CH 54	5270	14.39	15.50	96.97
		CH 62	5310	14.66	15.50	
	802.11ac-VHT80 MCS0	CH 58	5290	11.84	12.50	94.00

Note:

- Per KDB 447498 D01v06, the 1-g SAR test exclusion thresholds for 100 MHz to 6 GHz at *test separation distances* ≤50 mm are determined by:

$[(\text{max. power of channel, including tune-up tolerance, mW}) / (\text{min. test separation distance, mm})] \cdot [\sqrt{f(\text{GHz})}] \leq 3.0$ for 1-g SAR, where

- $f(\text{GHz})$ is the RF channel transmit frequency in GHz
- Power and distance are rounded to the nearest mW and mm before calculation
- The result is rounded to one decimal place for comparison

Channel	Frequency (GHz)	Max. Tune-up Power (dBm)	Max. Power (mW)	Test distance (mm)	Result	exclusion thresholds for 1-g SAR
CH 64	5.320	17.50	56.23	5	25.94	3.0

- Per KDB 248227 D01v02r02, choose the highest output power channel to test SAR and determine further SAR exclusion.
- The output power of all data rate were pre-scan, just the worst case (the lowest data rate) of all mode were shown in report.

<5.5GHz WLAN>

	Mode	Channel	Frequency (MHz)	Average power (dBm)	Tune-Up Limit	Duty Cycle %
5.5GHz WLAN	802.11a 6Mbps	CH 100	5500	16.54	17.00	98.10
		CH 120	5600	16.90	17.50	
		CH 144	5720	16.83	17.50	
	802.11n-HT20 MCS0	CH 100	5500	16.42	17.00	97.96
		CH 120	5600	16.78	17.50	
		CH 144	5720	16.82	17.50	
	802.11n-HT40 MCS0	CH 102	5510	15.46	16.00	96.94
		CH 118	5590	15.57	16.00	
		CH 142	5710	16.22	16.50	
	802.11ac-VHT20 MCS0	CH 100	5500	15.33	16.00	97.96
		CH 120	5600	15.58	16.00	
		CH 144	5720	15.73	16.50	
	802.11ac-VHT40 MCS0	CH 102	5510	14.98	15.50	96.97
		CH 118	5590	15.13	15.50	
		CH 142	5710	15.43	16.00	
	802.11ac-VHT80 MCS0	CH 106	5530	12.20	12.50	94.00
		CH 138	5690	12.35	12.50	

Note:

- Per KDB 447498 D01v06, the 1-g SAR test exclusion thresholds for 100 MHz to 6 GHz at *test separation distances* ≤50 mm are determined by:

$$[(\text{max. power of channel, including tune-up tolerance, mW}) / (\text{min. test separation distance, mm})] \cdot [\sqrt{f(\text{GHz})}] \leq 3.0$$
 for 1-g SAR, where

- $f(\text{GHz})$ is the RF channel transmit frequency in GHz
- Power and distance are rounded to the nearest mW and mm before calculation
- The result is rounded to one decimal place for comparison

Channel	Frequency (GHz)	Max. Tune-up Power (dBm)	Max. Power (mW)	Test distance (mm)	Result	exclusion thresholds for 1-g SAR
CH 120	5.600	17.50	56.23	5	26.61	3.0

- Per KDB 248227 D01v02r02, choose the highest output power channel to test SAR and determine further SAR exclusion.
- The output power of all data rate were pre-scan, just the worst case (the lowest data rate) of all mode were shown in report.

<5.8GHz WLAN>

	Mode	Channel	Frequency (MHz)	Average power (dBm)	Tune-Up Limit	Duty Cycle %
5.8GHz WLAN	802.11a MCS0	CH 149	5745	16.80	17.50	98.10
		CH 157	5785	16.85	17.50	
		CH 165	5825	17.07	18.00	
	802.11n-HT20 MCS0	CH 149	5745	16.79	17.50	97.96
		CH 157	5785	16.85	17.50	
		CH 165	5825	16.80	17.50	
	802.11n-HT40 MCS0	CH 151	5755	15.79	16.50	96.94
		CH 159	5795	15.86	16.50	
	802.11ac-VHT20 MCS0	CH 149	5745	15.60	16.50	97.96
		CH 157	5785	15.79	16.50	
		CH 165	5825	15.75	16.50	
	802.11ac-VHT40 MCS0	CH 151	5755	15.38	16.00	96.97
		CH 159	5795	15.36	16.00	
	802.11ac-VHT80 MCS0	CH 155	5775	12.34	12.50	94.00

Note:

- Per KDB 447498 D01v06, the 1-g SAR test exclusion thresholds for 100 MHz to 6 GHz at *test separation distances* ≤50 mm are determined by:

$$[(\text{max. power of channel, including tune-up tolerance, mW}) / (\text{min. test separation distance, mm})] \cdot [\sqrt{f(\text{GHz})}] \leq 3.0$$
 for 1-g SAR, where

- f(GHz) is the RF channel transmit frequency in GHz
- Power and distance are rounded to the nearest mW and mm before calculation
- The result is rounded to one decimal place for comparison

Channel	Frequency (GHz)	Max. Tune-up Power (dBm)	Max. Power (mW)	Test distance (mm)	Result	exclusion thresholds for 1-g SAR
CH 165	5.825	18.00	63.10	5	30.46	3.0

- Per KDB 248227 D01v02r02, choose the highest output power channel to test SAR and determine further SAR exclusion.
- The output power of all data rate were pre-scan, just the worst case (the lowest data rate) of all mode were shown in report.

> **Bluetooth Conducted Power**

Mode	Channel	Frequency (MHz)	Average power (dBm)		
			1Mbps	2Mbps	3Mbps
BR / EDR	CH 00	2402	8.46	5.49	6.36
	CH 39	2441	8.67	5.88	5.71
	CH 78	2480	8.33	5.99	5.80
Tune-up Limit (dBm)			9.00	6.00	6.00

Mode	Channel	Frequency (MHz)	Average power (dBm)	
			1Mbps	2Mbps
LE	CH 00	2402	2.24	-0.67
	CH 19	2440	2.45	-0.21
	CH 39	2480	2.71	0.42
Tune-up Limit (dBm)			3.00	1.00

Note:

- Per KDB 447498 D01v06, the 1-g SAR test exclusion thresholds for 100 MHz to 6 GHz at *test separation distances* ≤ 50 mm are determined by:

$$[(\text{max. power of channel, including tune-up tolerance, mW}) / (\text{min. test separation distance, mm})] \cdot [\sqrt{f(\text{GHz})}] \leq 3.0$$
 for 1-g SAR, where

- $f(\text{GHz})$ is the RF channel transmit frequency in GHz
- Power and distance are rounded to the nearest mW and mm before calculation
- The result is rounded to one decimal place for comparison

Channel	Frequency (GHz)	Max. Tune-up Power (dBm)	Max. Power (mW)	Test distance (mm)	Result	exclusion thresholds for 1-g SAR
CH 39	2.441	9.00	7.94	10.0	1.24	3.0

- Per KDB 248227 D01v02r02, choose the highest output power channel to test SAR and determine further SAR exclusion.
- The output power of all data rate were pre-scan, just the worst case (the lowest data rate) of all mode were shown in report.
- Per KDB 248227 D01V02r02 section 2.2, when the EUT in continuously transmitting mode, the actual duty cycle is 100%, so the duty cycle factor is 1.
- Held-to ear configuration is not applicable to Bluetooth operations and therefore were not considered for simultaneous transmission.

14. LTE Carrier Aggregation

This device supports Carrier Aggregation on downlink for inter. For the device supports bands and bandwidths and configurations are provided as follow table was according to 3GPP.

E-UTRA CA configuration	Downlink CA configurations (NOTE 3)	Component carriers in order of increasing carrier frequency			Maximum aggregated bandwidth [MHz]	Bandwidth combination set
		Channel bandwidths for carrier [MHz]	Channel bandwidths for carrier [MHz]	Channel bandwidths for carrier [MHz]		
CA_2A-5A	CA_2A-5A	5, 10, 15, 20	5, 10		30	0
		5, 10	5, 10			
CA_2A-12A	CA_2A-12A	5, 10, 15, 20	5, 10		30	0
		5, 10, 15, 20	3, 5, 10		30	1
		5, 10	5, 10		20	2
CA_2A-66A	CA_2A-66A	1.4, 3, 5, 10, 15, 20	5, 10, 15, 20		40	0
		5, 10	5, 10		20	1
		5, 10, 15, 20	5, 10, 15, 20		40	2
CA_5A-66A	CA_5A-66A	5, 10	5, 10, 15, 20		30	0
CA_13A-66A	CA_13A-66A	5, 10	5, 10, 15, 20		30	0
CA_66A-66A	CA_66A-66A	5	5, 10, 15, 20		25	0
		10	10, 15, 20		30	1
		15	15, 20		35	2
		20	20		40	3

14.1. LTE Downlink Carrier Aggregation Conducted Power

1. According to KDB941225 D05A v01r02, Uplink maximum output power measurement with downlink carrier aggregation active should be measured, using the highest output channel measured without downlink carrier aggregation, to confirm that uplink maximum output power with downlink carrier aggregation active remains within the specified tune-up tolerance limits and not more than $\frac{1}{4}$ dB higher than the maximum output measured without downlink carrier aggregation active.
2. Uplink maximum output power with downlink carrier aggregation active does not show more than $\frac{1}{4}$ dB higher than the maximum output power without downlink carrier aggregation active, therefore SAR evaluation with downlink carrier aggregation active can be excluded.
3. For power measurement were control and acknowledge data is sent on uplink channels that operate identical to specifications when downlink carrier aggregation is inactive.
4. Selected highest measured power when downlink carrier aggregation is inactive for conducted power comparison with downlink carrier aggregation is active, to confirm that when downlink carrier aggregation is active uplink maximum output power remains within the specified tune-up tolerance limits and not more than $\frac{1}{4}$ dB higher than the maximum output power measured when downlink carrier aggregation inactive.
5. For non-contiguous intra-band CA, the SCC selected to provide maximum separation from the PCC and must remain fully within the downlink transmission band.
6. For Intra-band, contiguous CA, the downlink channels selected to perform the uplink power measurement must satisfy
7. 3GPP channel spacing (5.4.1A of 3GPP TS 36.521 or equivalent) and channel bandwidth (5.4.2A) requirements.

$$\text{Nominal channel spacing} = \left\lceil \frac{BW_{\text{Channel}(1)} + BW_{\text{Channel}(2)} - 0.1 |BW_{\text{Channel}(1)} - BW_{\text{Channel}(2)}|}{0.6} \right\rceil 0.3 \text{ [MHz]}$$



Full Power for Two Carrier power verification:

PCC						SCC1					Power	
CA_Band	BW (MHz)	RB	Offset	UL Channel	UL Freq. (MHz)	BW (MHz)	RB	Offset	DL Channel	DL Freq. (MHz)	Rel.10 Tx. Power	Rel.8 Tx. Power
out-band CA (2CC)												
CA_2A-5A	20	1	0	18900	1880	10	1	0	2525	881.5	18.53	21.83
CA_2A-12A	20	1	0	18900	1880	10	1	49	5130	741	18.60	21.83
CA_2A-66A	20	1	0	18900	1880	20	1	0	66536	2120	18.23	21.83
CA_5A-66A	10	1	0	20525	836.5	20	1	0	66536	2120	23.31	23.55
CA_13A-66A	10	1	25	23230	782	20	1	0	66536	2120	23.46	23.51
CA_66A-66A	20	1	0	132072	1720	20	1	0	66536	2120	20.93	20.97

15. Hot-Spot Mode Evaluation Procedure

➤ EUT Antenna Location

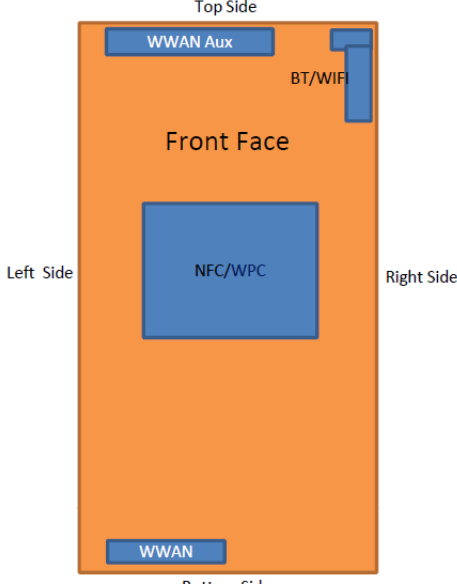
	WWAN Aux antenna supports TX bands: GSM 1900 UMTS Band II/IV FDD LTE Band 2/4/25/66 WWAN antenna supports TX bands: GSM 850 UMTS Band V FDD LTE Band 5/12/13/17/26/30/71 TDD LTE Band 41 WLAN antenna supports bands : 2.4GHz/5GHz BT antenna supported bands: 2.4GHz
---	---

➤ EUT Antenna Distance

Antenna Location	Support Function	Top Side(mm)	Bottom Side(mm)	Left Side(mm)	Right Side(mm)
WWAN Aux Antenna	TX/RX	5	152	9	24
WWAN Antenna	TX/RX	153	6	11	21
WLAN/BT Antenna	TX/RX	4	137	56	5

➤ Hotspot Evaluation

Assessment	Hotspot side for SAR Test distance: 10mm					
	Back	Front	Top	Bottom	Left	Right
Antennas						
WWAN Aux Antenna	Yes	Yes	Yes	No	Yes	Yes
WWAN Antenna	Yes	Yes	No	Yes	Yes	Yes
WLAN/BT Antenna	Yes	Yes	Yes	No	No	Yes

Note :

1. The SAR evaluation procedures for Portable Devices with Wireless Router function is according to KDB 941225 D06 Hotspot SAR v02r01.
2. Head/Body-worn/Hotspot mode SAR assessments are required.
3. Referring to KDB 941225 D06, when the overall device length and width are $\geq 9\text{cm} \times 5\text{cm}$, the test distance is 10 mm. SAR must be measured for all sides and surfaces with a transmitting antenna located within 25mm from that surface or edge.

16. Block Diagram of the Tests to be Performed

16.1. Head

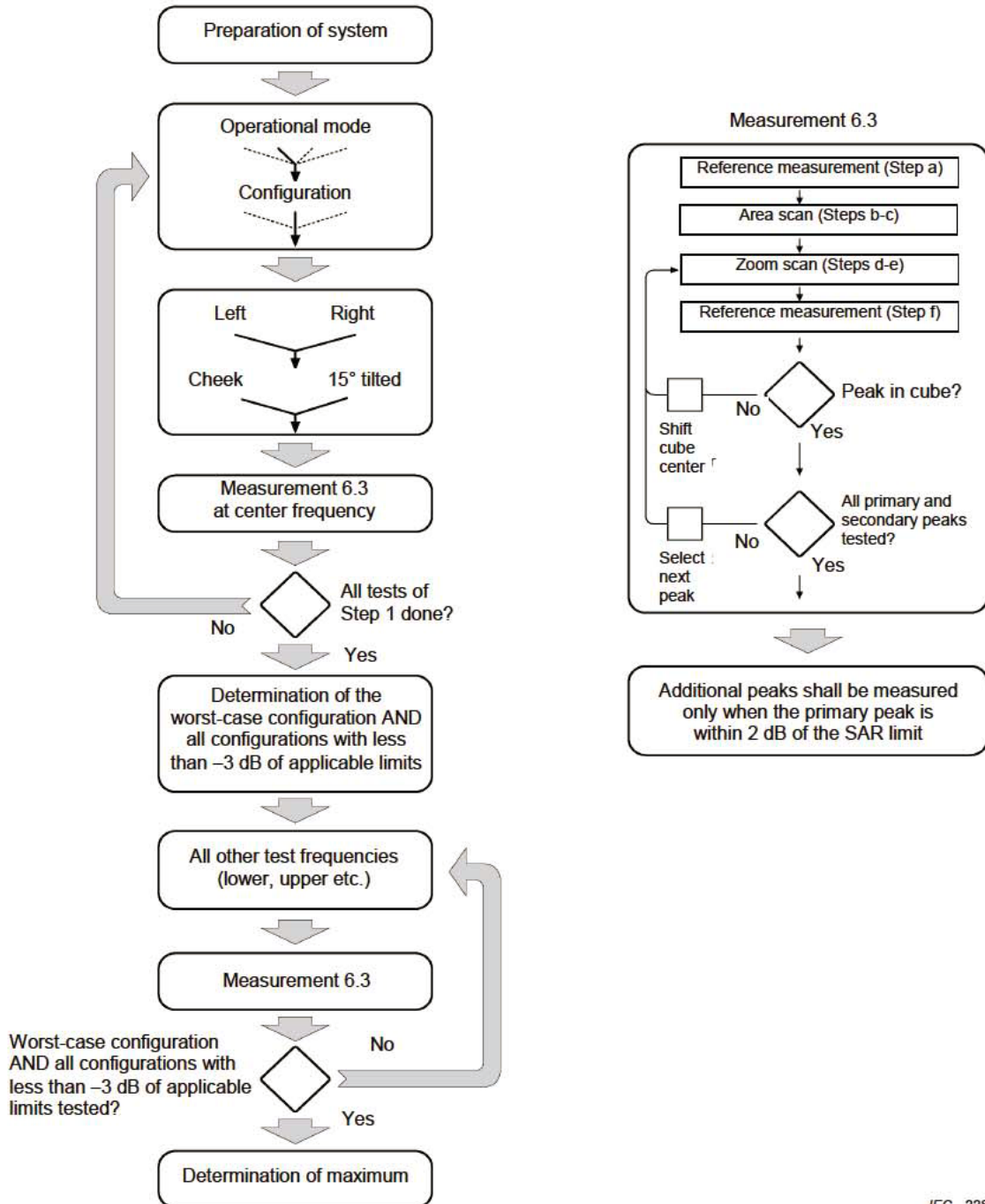

IEC 228/05

16.2. Body

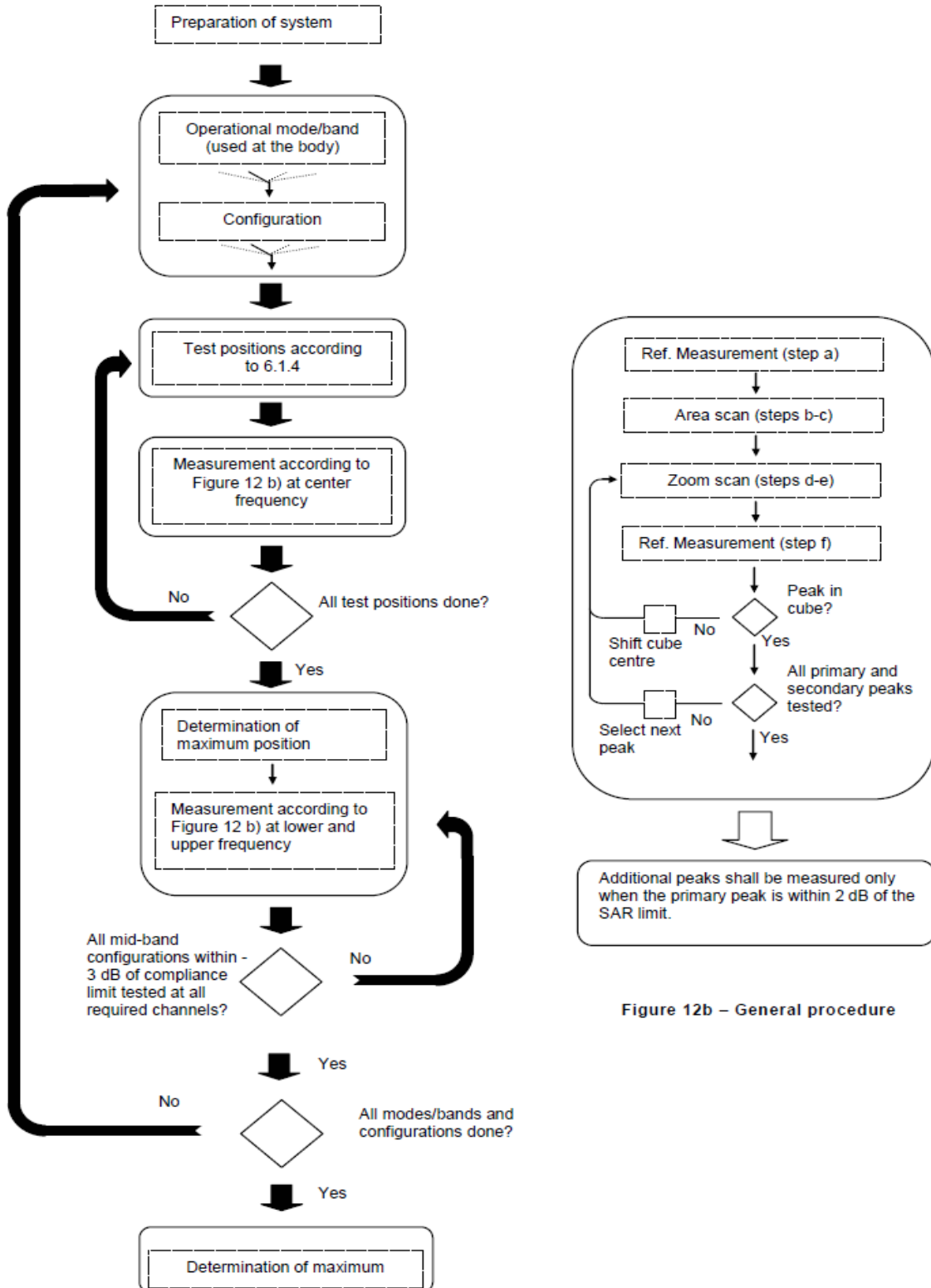

Figure 12b – General procedure

17. Test Results List

17.1. Test Guidance

1. Per KDB 447498 D01v06, the reported SAR is the measured SAR value adjusted for maximum tune-up tolerance.
 - a. Tune-up scaling Factor = tune-up limit power (mW) / EUT RF power (mW), where tune-up limit is the maximum rated power among all production units.
 - b. For SAR testing of WLAN signal with non-100% duty cycle, the measured SAR is scaled-up by the duty cycle scaling factor which is equal to "1/(duty cycle)".
 - c. For WWAN: Reported SAR(W/kg)= Measured SAR(W/kg)*Tune-up Scaling Factor.
 - d. For WLAN/Bluetooth: Reported SAR(W/kg)= Measured SAR(W/kg)* Duty Cycle scaling factor * Tune-up scaling factor.
2. Per KDB 447498 D01v06, for each exposure position, testing of other required channels within the operating mode of a frequency band is not required when the *reported* 1-g or 10-g SAR for the mid-band or highest output power channel is:
 - a. ≤ 0.8 W/kg or 2.0 W/kg, for 1-g or 10-g respectively, when the transmission band is ≤ 100 MHz
 - b. ≤ 0.6 W/kg or 1.5 W/kg, for 1-g or 10-g respectively, when the transmission band is between 100 MHz and 200 MHz
 - c. ≤ 0.4 W/kg or 1.0 W/kg, for 1-g or 10-g respectively, when the transmission band is ≥ 200 MHz
3. Per KDB 865664 D01v01r04, for each frequency band, repeated SAR measurement is required only when the measured SAR is ≥ 0.8 W/kg.
4. Per KDB 648474 D04v01r03, when the reported SAR for a body-worn accessory measured without a headset connected to the handset is ≤ 1.2 W/kg, SAR testing with a headset connected to the handset is not required.
5. Per KDB648474 D04v01r03, for smart phones with a display diagonal dimension > 15.0 cm or an overall diagonal dimension > 16.0 cm, when hotspot mode applies, 10-g extremity SAR is required only for the surfaces and edges with hotspot mode 1-g reported SAR > 1.2 W/kg, however, when power reduction applies to hotspot mode the measured SAR must be scaled



to the maximum output power, including tolerance, allowed for tablet modes to compare with the 1.2 W/kg SAR test reduction threshold.

6. Per KDB248227 D01v02r02, a Wi-Fi device must be configured to transmit continuously at the required data rate, channel bandwidth and signal modulation, using the highest transmission duty factor supported by the test mode tools for SAR measurement. The test frequencies established using test mode must correspond to the actual channel frequencies required for operations in the U.S. When 802.11 frame gaps are accounted for in the transmission, a maximum transmission duty factor of 92 - 96% is typically achievable in most test mode configurations. A minimum transmission duty factor of 85% is required to avoid certain hardware and device implementation issues related to wide range SAR scaling. In addition, a periodic transmission duty factor is required for current generation SAR systems to measure SAR correctly. Unless it is permitted by specific KDB procedures or continuous transmission is specifically restricted by the device, the reported SAR must be scaled to 100% transmission duty factor to determine compliance at the maximum tune-up tolerance limit. When a device is not capable of sustaining continuous transmission or the output can become nonlinear, and it is limited by hardware design and unable to transmit at higher than 85% duty factor, a periodic duty factor within 15% of the maximum duty factor the device is capable of transmitting should be used. The reported SAR must be scaled to the maximum transmission duty factor to determine compliance. Descriptions of the procedures applied to establish the specific duty factor used for SAR testing are required in SAR reports to support the test results.



17.2. Head SAR Data

➤ GSM Head SAR

Plot No.	Band/Mode	Test Position	CH.	Ave. Power (dBm)	Tune-up Limit (dBm)	Tune-up Scaling Factor	Meas. SAR1g (W/kg)	Reported SAR1g (W/kg)
1#	GPRS 850/3 TX slots	Right Cheek	251	29.60	30.50	1.230	0.104	0.128
	GPRS 850/3 TX slots	Right Tilt	251	29.60	30.50	1.230	0.053	0.065
	GPRS 850/3 TX slots	Left Cheek	251	29.60	30.50	1.230	0.074	0.091
	GPRS 850/3 TX slots	Left Tilt	251	29.60	30.50	1.230	0.057	0.070
	GPRS 1900/3 TX slots	Right Cheek	512	27.62	28.50	1.225	0.686	0.840
	GPRS 1900/3 TX slots	Right Tilt	512	27.62	28.50	1.225	0.766	0.938
2#	GPRS 1900/3 TX slots	Left Cheek	512	27.62	28.50	1.225	0.904	1.107
	GPRS 1900/3 TX slots	Left Tilt	512	27.62	28.50	1.225	0.677	0.829
	GPRS 1900/3 TX slots	Right Cheek	661	27.61	28.50	1.227	0.482	0.592
	GPRS 1900/3 TX slots	Right Cheek	810	27.54	28.50	1.247	0.506	0.631
	GPRS 1900/3 TX slots	Right Tilt	661	27.61	28.50	1.227	0.466	0.572
	GPRS 1900/3 TX slots	Right Tilt	810	27.54	28.50	1.247	0.467	0.583
	GPRS 1900/3 TX slots	Left Tilt	661	27.61	28.50	1.227	0.494	0.606
	GPRS 1900/3 TX slots	Left Tilt	810	27.54	28.50	1.247	0.513	0.640
	GPRS 1900/3 TX slots	Left Cheek	661	27.61	28.50	1.227	0.519	0.637
	GPRS 1900/3 TX slots	Left Cheek	810	27.54	28.50	1.247	0.491	0.612



➤ WCDMA Head SAR

Plot No.	Band/Mode	Test Position	CH.	Ave. Power (dBm)	Tune-up Limit (dBm)	Tune-up Scaling Factor	Meas. SAR1g (W/kg)	Reported SAR1g (W/kg)
	Band II/RMC	Right Cheek	9262	22.36	22.50	1.033	0.632	0.653
	Band II/RMC	Right Tilt	9262	22.36	22.50	1.033	0.838	0.865
	Band II/RMC	Left Cheek	9262	22.36	22.50	1.033	0.696	0.719
	Band II/RMC	Left Tilt	9262	22.36	22.50	1.033	0.926	0.956
	Band II/RMC	Right Tilt	9400	22.25	22.50	1.059	0.877	0.929
	Band II/RMC	Right Tilt	9538	22.28	22.50	1.052	0.960	1.010
	Band II/RMC	Left Tilt	9400	22.25	22.50	1.059	1.040	1.102
3#	Band II/RMC	Left Tilt	9538	22.28	22.50	1.052	1.140	1.199
	Band IV/RMC	Right Cheek	1312	21.60	22.00	1.096	0.615	0.674
	Band IV/RMC	Right Tilt	1312	21.60	22.00	1.096	0.831	0.911
	Band IV/RMC	Left Cheek	1312	21.60	22.00	1.096	0.707	0.775
	Band IV/RMC	Left Tilt	1312	21.60	22.00	1.096	0.947	1.038
	Band IV/RMC	Right Tilt	1413	21.32	22.00	1.169	0.830	0.971
	Band IV/RMC	Right Tilt	1513	21.39	22.00	1.151	0.832	0.957
4#	Band IV/RMC	Left Tilt	1413	21.32	22.00	1.169	0.960	1.123
	Band IV/RMC	Left Tilt	1513	21.39	22.00	1.151	0.928	1.068
5#	Band V/RMC	Right Cheek	4183	23.83	24.50	1.167	0.251	0.293
	Band V/RMC	Right Tilt	4183	23.83	24.50	1.167	0.153	0.179
	Band V/RMC	Left Cheek	4183	23.83	24.50	1.167	0.214	0.250
	Band V/RMC	Left Tilt	4183	23.83	24.50	1.167	0.138	0.161



➤ LTE QPSK Head SAR

Plot No.	Band/Mode	Test Position	CH.	Ave. Power (dBm)	Tune-up Limit (dBm)	Tune-up Scaling Factor	Meas. SAR1g (W/kg)	Reported SAR1g (W/kg)
	LTE Band 2/1RB#0 20M	Right Cheek	18900	21.83	22.50	1.167	0.646	0.754
	LTE Band 2/1RB#0 20M	Right Tilt	18900	21.83	22.50	1.167	0.816	0.952
	LTE Band 2/1RB#0 20M	Left Cheek	18900	21.83	22.50	1.167	0.515	0.601
	LTE Band 2/1RB#0 20M	Left Tilt	18900	21.83	22.50	1.167	0.880	1.027
	LTE Band 2/1RB#0 20M	Right Tilt	18700	21.65	22.50	1.216	0.720	0.876
	LTE Band 2/1RB#0 20M	Right Tilt	19100	21.75	22.50	1.189	0.912	1.084
	LTE Band 2/1RB#0 20M	Left Tilt	18700	21.65	22.50	1.216	0.777	0.945
6#	LTE Band 2/1RB#0 20M	Left Tilt	19100	21.75	22.50	1.189	0.915	1.087
	LTE Band 2/ 100RB#0 20M	Left Tilt	19100	20.71	21.50	1.199	0.625	0.750
	LTE Band 2/50RB#0 20M	Right Cheek	18900	20.81	21.50	1.172	0.454	0.532
	LTE Band 2/50RB#0 20M	Right Tilt	18900	20.81	21.50	1.172	0.512	0.600
	LTE Band 2/50RB#0 20M	Left Cheek	18900	20.81	21.50	1.172	0.501	0.587
	LTE Band 2/50RB#0 20M	Left Tilt	18900	20.81	21.50	1.172	0.655	0.768
	LTE Band 4/1RB#0 20M	Right Cheek	20300	21.26	22.00	1.186	0.544	0.645
	LTE Band 4/1RB#0 20M	Right Tilt	20300	21.26	22.00	1.186	0.778	0.923
	LTE Band 4/1RB#0 20M	Left Cheek	20300	21.26	22.00	1.186	0.612	0.726
	LTE Band 4/1RB#0 20M	Left Tilt	20300	21.26	22.00	1.186	0.870	1.032
	LTE Band 4/1RB#0 20M	Left Tilt	20050	21.19	22.00	1.205	0.904	1.089
7#	LTE Band 4/1RB#0 20M	Left Tilt	20175	21.18	22.00	1.208	0.911	1.100
	LTE Band 4/1RB#0 20M	Right Tilt	20050	21.19	22.00	1.205	0.758	0.913
	LTE Band 4/1RB#0 20M	Right Tilt	20175	21.18	22.00	1.208	0.757	0.914
	LTE Band 4/ 100RB#0 20M	Left Tilt	20300	20.23	21.00	1.194	0.594	0.709
	LTE Band 4/50RB#0 20M	Right Cheek	20300	20.31	21.00	1.172	0.417	0.489
	LTE Band 4/50RB#0 20M	Right Tilt	20300	20.31	21.00	1.172	0.609	0.714
	LTE Band 4/50RB#0 20M	Left Cheek	20300	20.31	21.00	1.172	0.452	0.530
	LTE Band 4/50RB#0 20M	Left Tilt	20300	20.31	21.00	1.172	0.652	0.764
8#	LTE Band 5/1RB#0 10M	Right Cheek	20525	23.55	24.00	1.109	0.278	0.308
	LTE Band 5/1RB#0 10M	Right Tilt	20525	23.55	24.00	1.109	0.162	0.180
	LTE Band 5/1RB#0 10M	Left Cheek	20525	23.55	24.00	1.109	0.201	0.223
	LTE Band 5/1RB#0 10M	Left Tilt	20525	23.55	24.00	1.109	0.146	0.162



	LTE Band 5/25RB#12 10M	Right Cheek	20525	22.63	23.00	1.089	0.215	0.234
	LTE Band 5/25RB#12 10M	Right Tilt	20525	22.63	23.00	1.089	0.126	0.137
	LTE Band 5/25RB#12 10M	Left Cheek	20525	22.63	23.00	1.089	0.156	0.170
	LTE Band 5/25RB#12 10M	Left Tilt	20525	22.63	23.00	1.089	0.116	0.126
9#	LTE Band 12/1RB#49 10M	Right Cheek	23130	23.45	24.00	1.135	0.159	0.180
	LTE Band 12/1RB#49 10M	Right Tilt	23130	23.45	24.00	1.135	0.074	0.083
	LTE Band 12/1RB#49 10M	Left Cheek	23130	23.45	24.00	1.135	0.136	0.154
	LTE Band 12/1RB#49 10M	Left Tilt	23130	23.45	24.00	1.135	0.082	0.093
	LTE Band 12/25RB#12 10M	Right Cheek	23130	22.51	23.00	1.119	0.117	0.131
	LTE Band 12/25RB#12 10M	Right Tilt	23130	22.51	23.00	1.119	0.055	0.061
	LTE Band 12/25RB#12 10M	Left Cheek	23130	22.51	23.00	1.119	0.099	0.111
	LTE Band 12/25RB#12 10M	Left Tilt	23130	22.51	23.00	1.119	0.061	0.068
10#	LTE Band 13/1RB#25 10M	Right Cheek	23230	23.51	24.00	1.119	0.101	0.113
	LTE Band 13/1RB#25 10M	Right Tilt	23230	23.51	24.00	1.119	0.050	0.056
	LTE Band 13/1RB#25 10M	Left Cheek	23230	23.51	24.00	1.119	0.082	0.091
	LTE Band 13/1RB#25 10M	Left Tilt	23230	23.51	24.00	1.119	0.056	0.063
	LTE Band 13/25RB#12 10M	Right Cheek	23230	22.61	23.00	1.094	0.087	0.095
	LTE Band 13/25RB#12 10M	Right Tilt	23230	22.61	23.00	1.094	0.044	0.048
	LTE Band 13/25RB#12 10M	Left Cheek	23230	22.61	23.00	1.094	0.068	0.074
	LTE Band 13/25RB#12 10M	Left Tilt	23230	22.61	23.00	1.094	0.046	0.051
	LTE Band 25/1RB#49 20M	Right Cheek	26140	22.07	22.50	1.104	0.631	0.697
	LTE Band 25/1RB#49 20M	Right Tilt	26140	22.07	22.50	1.104	0.603	0.666
	LTE Band 25/1RB#49 20M	Left Cheek	26140	22.07	22.50	1.104	0.650	0.718
	LTE Band 25/1RB#49 20M	Left Tilt	26140	22.07	22.50	1.104	0.721	0.796
	LTE Band 25/1RB#49 20M	Right Tilt	26365	21.78	22.50	1.180	0.850	1.003
11#	LTE Band 25/1RB#49 20M	Right Tilt	26590	21.78	22.50	1.180	0.916	1.081
	LTE Band 25/1RB#49 20M	Left Tilt	26365	21.78	22.50	1.180	0.793	0.936
	LTE Band 25/1RB#49 20M	Left Tilt	26590	21.78	22.50	1.180	0.833	0.983
	LTE Band 25/100RB#0 20M	Right Tilt	26140	20.94	21.50	1.138	0.603	0.686
	LTE Band 25/50RB#0 20M	Right Cheek	26140	21.05	21.50	1.109	0.401	0.445
	LTE Band 25/50RB#0 20M	Right Tilt	26140	21.05	21.50	1.109	0.625	0.693



	LTE Band 25/50RB#0 20M	Left Cheek	26140	21.05	21.50	1.109	0.467	0.518
	LTE Band 25/50RB#0 20M	Left Tilt	26140	21.05	21.50	1.109	0.406	0.450
	LTE Band 26/1RB#37 15M	Right Cheek	26965	23.51	24.00	1.119	0.105	0.118
	LTE Band 26/1RB#37 15M	Right Tilt	26965	23.51	24.00	1.119	0.066	0.074
12#	LTE Band 26/1RB#37 15M	Left Cheek	26965	23.51	24.00	1.119	0.136	0.152
	LTE Band 26/1RB#37 15M	Left Tilt	26965	23.51	24.00	1.119	0.084	0.094
	LTE Band 26/36RB#20 15M	Right Cheek	26965	22.52	23.00	1.117	0.084	0.094
	LTE Band 26/36RB#20 15M	Right Tilt	26965	22.52	23.00	1.117	0.053	0.060
	LTE Band 26/36RB#20 15M	Left Cheek	26965	22.52	23.00	1.117	0.111	0.124
	LTE Band 26/36RB#20 15M	Left Tilt	26965	22.52	23.00	1.117	0.068	0.075
	LTE Band 30/1RB#49 10M	Right Cheek	27710	23.39	24.00	1.151	0.061	0.070
13#	LTE Band 30/1RB#49 10M	Right Tilt	27710	23.39	24.00	1.151	0.122	0.140
	LTE Band 30/1RB#49 10M	Left Cheek	27710	23.39	24.00	1.151	0.049	0.056
	LTE Band 30/1RB#49 10M	Left Tilt	27710	23.39	24.00	1.151	0.055	0.064
	LTE Band 30/25RB#12 10M	Right Cheek	27710	22.38	23.00	1.153	0.051	0.058
	LTE Band 30/25RB#12 10M	Right Tilt	27710	22.38	23.00	1.153	0.090	0.103
	LTE Band 30/25RB#12 10M	Left Cheek	27710	22.38	23.00	1.153	0.037	0.043
	LTE Band 30/25RB#12 10M	Left Tilt	27710	22.38	23.00	1.153	0.046	0.053
	LTE Band 41/1RB#49 20M	Right Cheek	40620	26.57	27.00	1.104	0.069	0.076
14#	LTE Band 41/1RB#49 20M	Right Tilt	40620	26.57	27.00	1.104	0.070	0.078
	LTE Band 41/1RB#49 20M	Left Cheek	40620	26.57	27.00	1.104	0.042	0.047
	LTE Band 41/1RB#49 20M	Left Tilt	40620	26.57	27.00	1.104	0.026	0.028
	LTE Band 41/50RB#0 20M	Right Cheek	40620	25.97	26.50	1.130	0.067	0.076
	LTE Band 41/50RB#0 20M	Right Tilt	40620	25.97	26.50	1.130	0.068	0.077
	LTE Band 41/50RB#0 20M	Left Cheek	40620	25.97	26.50	1.130	0.038	0.043
	LTE Band 41/50RB#0 20M	Left Tilt	40620	25.97	26.50	1.130	0.022	0.025
	LTE Band 66/1RB#0 20M	Right Cheek	132072	20.97	22.00	1.268	0.591	0.749
	LTE Band 66/1RB#0 20M	Right Tilt	132072	20.97	22.00	1.268	0.795	1.008
	LTE Band 66/1RB#0 20M	Left Cheek	132072	20.97	22.00	1.268	0.623	0.790
15#	LTE Band 66/1RB#0 20M	Left Tilt	132072	20.97	22.00	1.268	0.881	1.117
	LTE Band 66/1RB#0 20M	Right Tilt	132322	20.91	22.00	1.285	0.748	0.961



	LTE Band 66/1RB#0 20M	Right Tilt	132572	20.82	22.00	1.312	0.753	0.988
	LTE Band 66/1RB#0 20M	Left Tilt	132322	20.91	22.00	1.285	0.820	1.054
	LTE Band 66/1RB#0 20M	Left Tilt	132572	20.82	22.00	1.312	0.751	0.985
	LTE Band 66/100RB#0 20M	Left Tilt	132072	19.92	21.00	1.282	0.521	0.668
	LTE Band 66/50RB#0 20M	Right Cheek	132072	19.90	21.00	1.288	0.288	0.371
	LTE Band 66/50RB#0 20M	Right Tilt	132072	19.90	21.00	1.288	0.545	0.702
	LTE Band 66/50RB#0 20M	Left Cheek	132072	19.90	21.00	1.288	0.320	0.412
	LTE Band 66/50RB#0 20M	Left Tilt	132072	19.90	21.00	1.288	0.553	0.712
16#	LTE Band 71/1RB#0 20M	Right Cheek	133222	23.90	24.50	1.148	0.073	0.083
	LTE Band 71/1RB#0 20M	Right Tilt	133222	23.90	24.50	1.148	0.035	0.040
	LTE Band 71/1RB#0 20M	Left Cheek	133222	23.90	24.50	1.148	0.066	0.076
	LTE Band 71/1RB#0 20M	Left Tilt	133222	23.90	24.50	1.148	0.036	0.042
	LTE Band 71/50RB#0 20M	Right Cheek	133222	22.99	23.50	1.125	0.068	0.076
	LTE Band 71/50RB#0 20M	Right Tilt	133222	22.99	23.50	1.125	0.032	0.036
	LTE Band 71/50RB#0 20M	Left Cheek	133222	22.99	23.50	1.125	0.051	0.057
	LTE Band 71/50RB#0 20M	Left Tilt	133222	22.99	23.50	1.125	0.033	0.037



➤ WLAN Head SAR

Plot No.	Band/Mode	Test Position	CH.	Ave. Power (dBm)	Tune-up Limit (dBm)	Tune-up Scaling Factor	Meas. SAR1g (W/kg)	Reported SAR1g (W/kg)
	WLAN2.4GHz/802.11b	Right Cheek	1	18.42	18.50	1.019	0.095	0.097
	WLAN2.4GHz/802.11b	Right Tilt	1	18.42	18.50	1.019	0.103	0.105
	WLAN2.4GHz/802.11b	Left Cheek	1	18.42	18.50	1.019	0.100	0.102
17#	WLAN2.4GHz/802.11b	Left Tilt	1	18.42	18.50	1.019	0.149	0.152
	WLAN5.2GHz/802.11n-20	Right Cheek	48	16.39	17.00	1.151	0.026	0.031
	WLAN5.2GHz/802.11n-20	Right Tilt	48	16.39	17.00	1.151	0.020	0.023
18#	WLAN5.2GHz/802.11n-20	Left Cheek	48	16.39	17.00	1.151	0.103	0.121
	WLAN5.2GHz/802.11n-20	Left Tilt	48	16.39	17.00	1.151	0.071	0.083
	WLAN5.3GHz/802.11a	Right Cheek	64	16.62	17.50	1.225	0.012	0.015
	WLAN5.3GHz/802.11a	Right Tilt	64	16.62	17.50	1.225	0.020	0.024
19#	WLAN5.3GHz/802.11a	Left Cheek	64	16.62	17.50	1.225	0.103	0.129
	WLAN5.3GHz/802.11a	Left Tilt	64	16.62	17.50	1.225	0.077	0.096
	WLAN5.5GHz/802.11a	Right Cheek	120	16.90	17.50	1.148	0.029	0.034
	WLAN5.5GHz/802.11a	Right Tilt	120	16.90	17.50	1.148	0.031	0.036
20#	WLAN5.5GHz/802.11a	Left Cheek	120	16.90	17.50	1.148	0.115	0.135
	WLAN5.5GHz/802.11a	Left Tilt	120	16.90	17.50	1.148	0.103	0.121
	WLAN5.8GHz/802.11a	Right Cheek	165	17.07	18.00	1.239	0.035	0.044
	WLAN5.8GHz/802.11a	Right Tilt	165	17.07	18.00	1.239	0.038	0.048
21#	WLAN5.8GHz/802.11a	Left Cheek	165	17.07	18.00	1.239	0.104	0.131
	WLAN5.8GHz/802.11a	Left Tilt	165	17.07	18.00	1.239	0.084	0.106

Note:

1. Per KDB 447498 D01v06, for each exposure position, if the highest output power channel Reported SAR ≤ 0.8 W/kg, other channels SAR testing is not necessary.
2. Per KDB 865664 D01v01r04, for each frequency band, repeated SAR measurement is required when the measured SAR is ≥ 0.8 W/kg.
3. Per KDB 941225 D05v02r05, 100% RB allocation SAR measurement is not required when the highest reported SAR for 1 RB and 50% RB allocation are ≤ 0.8 W/kg.
4. Per KDB 248227 D01v02r02, for 802.11b DSSS, when the reported SAR of the highest measured maximum output power channel for the exposure configuration is ≤ 0.8 W/kg, no further SAR testing is required in that exposure configuration.



5. Per KDB 248227 D01v02r02, OFDM SAR is not required when the highest reported SAR for DSSS is adjusted by the ratio of OFDM to DSSS specified maximum output power and the adjusted SAR is ≤ 1.2 W/kg.
6. According to KDB 865664 D02v01r02, SAR plot is required for the highest measured SAR in each exposure configuration, wireless mode and frequency band combination.
7. The reported 1g SAR (W/kg) has been calculated together with the duty cycle scaling factor 1.006 for LTE Band 41, 1.021 for 5.2GHz WLAN and 1.019 for 5.3GHz/5.5Hz/5.8GHz WLAN.

17.3. Body-worn SAR Data

➤ **GSM Body-worn SAR**

Plot No.	Band/Mode	Test Position	CH.	Ave. Power (dBm)	Tune-up Limit (dBm)	Tune-up Scaling Factor	Meas. SAR1g (W/kg)	Reported SAR1g (W/kg)
	GPRS 850/3 TX slots	Front Side	251	29.60	30.50	1.230	0.147	0.181
22#	GPRS 850/3 TX slots	Back Side	251	29.60	30.50	1.230	0.318	0.391
	GPRS 1900/3 TX slots	Front Side	512	27.62	28.50	1.225	0.209	0.256
23#	GPRS 1900/3 TX slots	Back Side	512	27.62	28.50	1.225	0.557	0.682

➤ **WCDMA Body-worn SAR**

Plot No.	Band/Mode	Test Position	CH.	Ave. Power (dBm)	Tune-up Limit (dBm)	Tune-up Scaling Factor	Meas. SAR1g (W/kg)	Reported SAR1g (W/kg)
	Band II/RMC	Front Side	9262	22.36	22.50	1.033	0.288	0.297
24#	Band II/RMC	Back Side	9262	22.36	22.50	1.033	0.482	0.498
	Band IV/RMC	Front Side	1312	21.60	22.00	1.096	0.222	0.243
25#	Band IV/RMC	Back Side	1312	21.60	22.00	1.096	0.640	0.702
	Band V/RMC	Front Side	4183	23.83	24.50	1.167	0.309	0.361
26#	Band V/RMC	Back Side	4183	23.83	24.50	1.167	0.426	0.497



➤ LTE QPSK Body-worn SAR

Plot No.	Band/Mode	Test Position	CH.	Ave. Power (dBm)	Tune-up Limit (dBm)	Tune-up Scaling Factor	Meas. SAR1g (W/kg)	Reported SAR1g (W/kg)
	LTE Band 2/1RB#0 20M	Front Side	18900	21.83	22.50	1.167	0.179	0.209
27#	LTE Band 2/1RB#0 20M	Back Side	18900	21.83	22.50	1.167	0.569	0.664
	LTE Band 2/50RB#0 20M	Front Side	18900	20.81	21.50	1.172	0.116	0.136
	LTE Band 2/50RB#0 20M	Back Side	18900	20.81	21.50	1.172	0.471	0.552
	LTE Band 4/1RB#0 20M	Front Side	20300	21.26	22.00	1.186	0.130	0.154
28#	LTE Band 4/1RB#0 20M	Back Side	20300	21.26	22.00	1.186	0.460	0.545
	LTE Band 4/50RB#0 20M	Front Side	20300	20.31	21.00	1.172	0.101	0.118
	LTE Band 4/50RB#0 20M	Back Side	20300	20.31	21.00	1.172	0.375	0.440
	LTE Band 5/1RB#0 10M	Front Side	20525	23.55	24.00	1.109	0.199	0.221
29#	LTE Band 5/1RB#0 10M	Back Side	20525	23.55	24.00	1.109	0.434	0.481
	LTE Band 5/25RB#12 10M	Front Side	20525	22.63	23.00	1.089	0.160	0.174
	LTE Band 5/25RB#12 10M	Back Side	20525	22.63	23.00	1.089	0.346	0.377
	LTE Band 12/1RB#49 10M	Front Side	23130	23.45	24.00	1.135	0.219	0.249
30#	LTE Band 12/1RB#49 10M	Back Side	23130	23.45	24.00	1.135	0.282	0.320
	LTE Band 12/25RB#12 10M	Front Side	23130	22.51	23.00	1.119	0.185	0.207
	LTE Band 12/25RB#12 10M	Back Side	23130	22.51	23.00	1.119	0.235	0.263
	LTE Band 13/1RB#25 10M	Front Side	23230	23.51	24.00	1.119	0.147	0.165
31#	LTE Band 13/1RB#25 10M	Back Side	23230	23.51	24.00	1.119	0.263	0.294
	LTE Band 13/25RB#12 10M	Front Side	23230	22.61	23.00	1.094	0.139	0.152
	LTE Band 13/25RB#12 10M	Back Side	23230	22.61	23.00	1.094	0.245	0.268
	LTE Band 25/1RB#49 20M	Front Side	26140	22.07	22.50	1.104	0.149	0.165
32#	LTE Band 25/1RB#49 20M	Back Side	26140	22.07	22.50	1.104	0.599	0.661
	LTE Band 25/50RB#0 20M	Front Side	26140	21.05	21.50	1.109	0.124	0.138



	LTE Band 25/50RB#0 20M	Back Side	26140	21.05	21.50	1.109	0.479	0.531
	LTE Band 26/1RB#37 15M	Front Side	26965	23.51	24.00	1.119	0.230	0.257
33#	LTE Band 26/1RB#37 15M	Back Side	26965	23.51	24.00	1.119	0.451	0.505
	LTE Band 26/36RB#20 15M	Front Side	26965	22.52	23.00	1.117	0.184	0.206
	LTE Band 26/36RB#20 15M	Back Side	26965	22.52	23.00	1.117	0.358	0.400
	LTE Band 30/1RB#49 10M	Front Side	27710	23.39	24.00	1.151	0.419	0.482
34#	LTE Band 30/1RB#49 10M	Back Side	27710	23.39	24.00	1.151	0.909	1.046
	LTE Band 30/50RB#0 10M	Back Side	27710	22.32	23.00	1.169	0.795	0.930
	LTE Band 30/25RB#12 10M	Front Side	27710	22.38	23.00	1.153	0.215	0.248
	LTE Band 30/25RB#12 10M	Back Side	27710	22.38	23.00	1.153	0.684	0.789
	LTE Band 41/1RB#49 20M	Front Side	40620	26.57	27.00	1.104	0.020	0.022
35#	LTE Band 41/1RB#49 20M	Back Side	40620	26.57	27.00	1.104	0.542	0.602
	LTE Band 41/50RB#0 20M	Front Side	40620	25.97	26.50	1.130	0.016	0.018
	LTE Band 41/50RB#0 20M	Back Side	40620	25.97	26.50	1.130	0.468	0.532
	LTE Band 66/1RB#0 20M	Front Side	132072	20.97	22.00	1.268	0.081	0.102
36#	LTE Band 66/1RB#0 20M	Back Side	132072	20.97	22.00	1.268	0.355	0.450
	LTE Band 66/50RB#0 20M	Front Side	132072	19.90	21.00	1.288	0.066	0.085
	LTE Band 66/50RB#0 20M	Back Side	132072	19.90	21.00	1.288	0.285	0.367
	LTE Band 71/1RB#0 20M	Front Side	133222	23.90	24.50	1.148	0.106	0.122
37#	LTE Band 71/1RB#0 20M	Back Side	133222	23.90	24.50	1.148	0.155	0.178
	LTE Band 71/50RB#0 20M	Front Side	133222	22.99	23.50	1.125	0.100	0.112
	LTE Band 71/50RB#0 20M	Back Side	133222	22.99	23.50	1.125	0.132	0.148



➤ WLAN Body-worn SAR

Plot No.	Band/Mode	Test Position	CH.	Ave. Power (dBm)	Tune-up Limit (dBm)	Tune-up Scaling Factor	Meas. SAR1g (W/kg)	Reported SAR1g (W/kg)
	WLAN2.4GHz/802.11b	Front Side	1	18.42	18.50	1.019	0.069	0.070
38#	WLAN2.4GHz/802.11b	Back Side	1	18.42	18.50	1.019	0.083	0.084
	WLAN5.2GHz/802.11n-20	Front Side	48	16.39	17.00	1.151	0.027	0.032
39#	WLAN5.2GHz/802.11n-20	Back Side	48	16.39	17.00	1.151	0.052	0.061
	WLAN5.3GHz/802.11a	Front Side	64	16.62	17.50	1.225	0.030	0.037
40#	WLAN5.3GHz/802.11a	Back Side	64	16.62	17.50	1.225	0.067	0.083
	WLAN5.5GHz/802.11a	Front Side	120	16.90	17.50	1.148	0.031	0.037
41#	WLAN5.5GHz/802.11a	Back Side	120	16.90	17.50	1.148	0.077	0.090
	WLAN5.8GHz/802.11a	Front Side	165	17.07	18.00	1.239	0.023	0.029
42#	WLAN5.8GHz/802.11a	Back Side	165	17.07	18.00	1.239	0.088	0.110

Note:

1. The reported 1g SAR (W/kg) has been calculated together with the duty cycle scaling factor 1.006 for LTE Band 41, 1.021 for 5.2GHz WLAN and 1.019 for 5.3GHz/5.5Hz/5.8GHz WLAN.



17.4. Hotspot SAR Data

➤ GSM Hotspot SAR

Plot No.	Band/Mode	Test Position	CH.	Ave. Power (dBm)	Tune-up Limit (dBm)	Tune-up Scaling Factor	Meas. SAR1g (W/kg)	Reported SAR1g (W/kg)
	GPRS 850/3 TX slots	Front Side	251	29.60	30.50	1.230	0.147	0.181
43#	GPRS 850/3 TX slots	Back Side	251	29.60	30.50	1.230	0.318	0.391
	GPRS 850/3 TX slots	Left Side	251	29.60	30.50	1.230	0.018	0.022
	GPRS 850/3 TX slots	Right Side	251	29.60	30.50	1.230	0.085	0.105
	GPRS 850/3 TX slots	Bottom Side	251	29.60	30.50	1.230	0.243	0.299
	GPRS 1900/3 TX slots	Front Side	512	27.62	28.50	1.225	0.209	0.256
44#	GPRS 1900/3 TX slots	Back Side	512	27.62	28.50	1.225	0.557	0.682
	GPRS 1900/3 TX slots	Left Side	512	27.62	28.50	1.225	0.084	0.103
	GPRS 1900/3 TX slots	Right Side	512	27.62	28.50	1.225	0.078	0.096
	GPRS 1900/3 TX slots	Top Side	512	27.62	28.50	1.225	0.537	0.658

➤ WCDMA Hotspot SAR

Plot No.	Band/Mode	Test Position	CH.	Ave. Power (dBm)	Tune-up Limit (dBm)	Tune-up Scaling Factor	Meas. SAR1g (W/kg)	Reported SAR1g (W/kg)
	Band II/RMC	Front Side	9262	22.36	22.50	1.033	0.288	0.297
	Band II/RMC	Back Side	9262	22.36	22.50	1.033	0.482	0.498
	Band II/RMC	Left Side	9262	22.36	22.50	1.033	0.098	0.101
	Band II/RMC	Right Side	9262	22.36	22.50	1.033	0.087	0.090
45#	Band II/RMC	Top Side	9262	22.36	22.50	1.033	0.503	0.519
	Band IV/RMC	Front Side	1312	21.60	22.00	1.096	0.222	0.243
46#	Band IV/RMC	Back Side	1312	21.60	22.00	1.096	0.640	0.702
	Band IV/RMC	Left Side	1312	21.60	22.00	1.096	0.121	0.133
	Band IV/RMC	Right Side	1312	21.60	22.00	1.096	0.105	0.115
	Band IV/RMC	Top Side	1312	21.60	22.00	1.096	0.459	0.503
	Band V/RMC	Front Side	4183	23.83	24.50	1.167	0.309	0.361
47#	Band V/RMC	Back Side	4183	23.83	24.50	1.167	0.426	0.497
	Band V/RMC	Left Side	4183	23.83	24.50	1.167	0.087	0.102
	Band V/RMC	Right Side	4183	23.83	24.50	1.167	0.288	0.336



	Band V/RMC	Bottom Side	4183	23.83	24.50	1.167	0.327	0.382
--	------------	-------------	------	-------	-------	-------	-------	-------

➤ LTE QPSK Hotspot SAR

Plot No.	Band/Mode	Test Position	CH.	Ave. Power (dBm)	Tune-up Limit (dBm)	Tune-up Scaling Factor	Meas. SAR1g (W/kg)	Reported SAR1g (W/kg)
	LTE Band 2/1RB#0 20M	Front Side	18900	21.83	22.50	1.167	0.179	0.209
48#	LTE Band 2/1RB#0 20M	Back Side	18900	21.83	22.50	1.167	0.569	0.664
	LTE Band 2/1RB#0 20M	Left Side	18900	21.83	22.50	1.167	0.071	0.083
	LTE Band 2/1RB#0 20M	Right Side	18900	21.83	22.50	1.167	0.031	0.036
	LTE Band 2/1RB#0 20M	Top Side	18900	21.83	22.50	1.167	0.456	0.532
	LTE Band 2/50RB#0 20M	Front Side	18900	20.81	21.50	1.172	0.116	0.136
	LTE Band 2/50RB#0 20M	Back Side	18900	20.81	21.50	1.172	0.471	0.552
	LTE Band 2/50RB#0 20M	Left Side	18900	20.81	21.50	1.172	0.060	0.070
	LTE Band 2/50RB#0 20M	Right Side	18900	20.81	21.50	1.172	0.025	0.029
	LTE Band 2/50RB#0 20M	Top Side	18900	20.81	21.50	1.172	0.378	0.443
	LTE Band 4/1RB#0 20M	Front Side	20300	21.26	22.00	1.186	0.130	0.154
49#	LTE Band 4/1RB#0 20M	Back Side	20300	21.26	22.00	1.186	0.460	0.545
	LTE Band 4/1RB#0 20M	Left Side	20300	21.26	22.00	1.186	0.055	0.065
	LTE Band 4/1RB#0 20M	Right Side	20300	21.26	22.00	1.186	0.021	0.025
	LTE Band 4/1RB#0 20M	Top Side	20300	21.26	22.00	1.186	0.421	0.499
	LTE Band 4/50RB#0 20M	Front Side	20300	20.31	21.00	1.172	0.101	0.118
	LTE Band 4/50RB#0 20M	Back Side	20300	20.31	21.00	1.172	0.375	0.440
	LTE Band 4/50RB#0 20M	Left Side	20300	20.31	21.00	1.172	0.042	0.049
	LTE Band 4/50RB#0 20M	Right Side	20300	20.31	21.00	1.172	0.029	0.034
	LTE Band 4/50RB#0 20M	Top Side	20300	20.31	21.00	1.172	0.334	0.392
	LTE Band 5/1RB#0 10M	Front Side	20525	23.55	24.00	1.109	0.199	0.221
50#	LTE Band 5/1RB#0 10M	Back Side	20525	23.55	24.00	1.109	0.434	0.481
	LTE Band 5/1RB#0 10M	Left Side	20525	23.55	24.00	1.109	0.024	0.027
	LTE Band 5/1RB#0 10M	Right Side	20525	23.55	24.00	1.109	0.015	0.017
	LTE Band 5/1RB#0 10M	Bottom Side	20525	23.55	24.00	1.109	0.248	0.275
	LTE Band 5/25RB#12 10M	Front Side	20525	22.63	23.00	1.089	0.160	0.174
	LTE Band 5/25RB#12 10M	Back Side	20525	22.63	23.00	1.089	0.346	0.377



	LTE Band 5/25RB#12 10M	Left Side	20525	22.63	23.00	1.089	0.021	0.023
	LTE Band 5/25RB#12 10M	Right Side	20525	22.63	23.00	1.089	0.013	0.014
	LTE Band 5/25RB#12 10M	Bottom Side	20525	22.63	23.00	1.089	0.009	0.010
	LTE Band 12/1RB#49 10M	Front Side	23130	23.45	24.00	1.135	0.219	0.249
51#	LTE Band 12/1RB#49 10M	Back Side	23130	23.45	24.00	1.135	0.282	0.320
	LTE Band 12/1RB#49 10M	Left Side	23130	23.45	24.00	1.135	0.158	0.179
	LTE Band 12/1RB#49 10M	Right Side	23130	23.45	24.00	1.135	0.215	0.244
	LTE Band 12/1RB#49 10M	Bottom Side	23130	23.45	24.00	1.135	0.229	0.260
	LTE Band 12/25RB#12 10M	Front Side	23130	22.51	23.00	1.119	0.185	0.207
	LTE Band 12/25RB#12 10M	Back Side	23130	22.51	23.00	1.119	0.235	0.263
	LTE Band 12/25RB#12 10M	Left Side	23130	22.51	23.00	1.119	0.121	0.135
	LTE Band 12/25RB#12 10M	Right Side	23130	22.51	23.00	1.119	0.200	0.224
	LTE Band 12/25RB#12 10M	Bottom Side	23130	22.51	23.00	1.119	0.172	0.193
	LTE Band 13/1RB#25 10M	Front Side	23230	23.51	24.00	1.119	0.147	0.165
52#	LTE Band 13/1RB#25 10M	Back Side	23230	23.51	24.00	1.119	0.263	0.294
	LTE Band 13/1RB#25 10M	Left Side	23230	23.51	24.00	1.119	0.035	0.039
	LTE Band 13/1RB#25 10M	Right Side	23230	23.51	24.00	1.119	0.229	0.256
	LTE Band 13/1RB#25 10M	Bottom Side	23230	23.51	24.00	1.119	0.252	0.282
	LTE Band 13/25RB#12 10M	Front Side	23230	22.61	23.00	1.094	0.139	0.152
	LTE Band 13/25RB#12 10M	Back Side	23230	22.61	23.00	1.094	0.245	0.268
	LTE Band 13/25RB#12 10M	Left Side	23230	22.61	23.00	1.094	0.026	0.028
	LTE Band 13/25RB#12 10M	Right Side	23230	22.61	23.00	1.094	0.190	0.208
	LTE Band 13/25RB#12 10M	Bottom Side	23230	22.61	23.00	1.094	0.192	0.210
	LTE Band 25/1RB#49 20M	Front Side	26140	22.07	22.50	1.104	0.149	0.165
53#	LTE Band 25/1RB#49 20M	Back Side	26140	22.07	22.50	1.104	0.599	0.661
	LTE Band 25/1RB#49 20M	Left Side	26140	22.07	22.50	1.104	0.056	0.062
	LTE Band 25/1RB#49 20M	Right Side	26140	22.07	22.50	1.104	0.048	0.053
	LTE Band 25/1RB#49 20M	Top Side	26140	22.07	22.50	1.104	0.429	0.474
	LTE Band 25/50RB#0 20M	Front Side	26140	21.05	21.50	1.109	0.124	0.138
	LTE Band 25/50RB#0 20M	Back Side	26140	21.05	21.50	1.109	0.479	0.531
	LTE Band 25/50RB#0 20M	Left Side	26140	21.05	21.50	1.109	0.046	0.051
	LTE Band 25/50RB#0 20M	Right Side	26140	21.05	21.50	1.109	0.040	0.044



	LTE Band 25/50RB#0 20M	Top Side	26140	21.05	21.50	1.109	0.335	0.372
	LTE Band 26/1RB#37 15M	Front Side	26965	23.51	24.00	1.119	0.230	0.257
54#	LTE Band 26/1RB#37 15M	Back Side	26965	23.51	24.00	1.119	0.451	0.505
	LTE Band 26/1RB#37 15M	Left Side	26965	23.51	24.00	1.119	0.012	0.013
	LTE Band 26/1RB#37 15M	Right Side	26965	23.51	24.00	1.119	0.147	0.165
	LTE Band 26/1RB#37 15M	Bottom Side	26965	23.51	24.00	1.119	0.239	0.268
	LTE Band 26/36RB#20 15M	Front Side	26965	22.52	23.00	1.117	0.184	0.206
	LTE Band 26/36RB#20 15M	Back Side	26965	22.52	23.00	1.117	0.358	0.400
	LTE Band 26/36RB#20 15M	Left Side	26965	22.52	23.00	1.117	0.011	0.012
	LTE Band 26/36RB#20 15M	Right Side	26965	22.52	23.00	1.117	0.114	0.127
	LTE Band 26/36RB#20 15M	Bottom Side	26965	22.52	23.00	1.117	0.198	0.221
	LTE Band 30/1RB#49 10M	Front Side	27710	23.39	24.00	1.151	0.419	0.482
	LTE Band 30/1RB#49 10M	Back Side	27710	23.39	24.00	1.151	0.909	1.046
	LTE Band 30/1RB#49 10M	Left Side	27710	23.39	24.00	1.151	0.030	0.034
	LTE Band 30/1RB#49 10M	Right Side	27710	23.39	24.00	1.151	0.009	0.010
55#	LTE Band 30/1RB#49 10M	Bottom Side	27710	23.39	24.00	1.151	1.030	1.185
	LTE Band 30/50RB#0 10M	Bottom Side	27710	22.32	23.00	1.169	0.861	1.007
	LTE Band 30/25RB#12 10M	Front Side	27710	22.38	23.00	1.153	0.215	0.248
	LTE Band 30/25RB#12 10M	Back Side	27710	22.38	23.00	1.153	0.684	0.789
	LTE Band 30/25RB#12 10M	Left Side	27710	22.38	23.00	1.153	0.024	0.028
	LTE Band 30/25RB#12 10M	Right Side	27710	22.38	23.00	1.153	0.007	0.009
	LTE Band 30/25RB#12 10M	Bottom Side	27710	22.38	23.00	1.153	0.859	0.991
	LTE Band 41/1RB#49 20M	Front Side	40620	26.57	27.00	1.104	0.020	0.022
	LTE Band 41/1RB#49 20M	Back Side	40620	26.57	27.00	1.104	0.542	0.602
	LTE Band 41/1RB#49 20M	Left Side	40620	26.57	27.00	1.104	0.030	0.033
	LTE Band 41/1RB#49 20M	Right Side	40620	26.57	27.00	1.104	0.017	0.019
56#	LTE Band 41/1RB#49 20M	Bottom Side	40620	26.57	27.00	1.104	0.629	0.699
	LTE Band 41/50RB#0 20M	Front Side	40620	25.97	26.50	1.130	0.016	0.018
	LTE Band 41/50RB#0 20M	Back Side	40620	25.97	26.50	1.130	0.468	0.532
	LTE Band 41/50RB#0 20M	Left Side	40620	25.97	26.50	1.130	0.023	0.027
	LTE Band 41/50RB#0 20M	Right Side	40620	25.97	26.50	1.130	0.010	0.011
	LTE Band 41/50RB#0 20M	Bottom Side	40620	25.97	26.50	1.130	0.541	0.615



	LTE Band 66/1RB#0 20M	Front Side	132072	20.97	22.00	1.268	0.081	0.102
	LTE Band 66/1RB#0 20M	Back Side	132072	20.97	22.00	1.268	0.355	0.450
	LTE Band 66/1RB#0 20M	Left Side	132072	20.97	22.00	1.268	0.036	0.045
	LTE Band 66/1RB#0 20M	Right Side	132072	20.97	22.00	1.268	0.027	0.034
57#	LTE Band 66/1RB#0 20M	Top Side	132072	20.97	22.00	1.268	0.408	0.517
	LTE Band 66/50RB#0 20M	Front Side	132072	19.90	21.00	1.288	0.066	0.085
	LTE Band 66/50RB#0 20M	Back Side	132072	19.90	21.00	1.288	0.285	0.367
	LTE Band 66/50RB#0 20M	Left Side	132072	19.90	21.00	1.288	0.030	0.039
	LTE Band 66/50RB#0 20M	Right Side	132072	19.90	21.00	1.288	0.022	0.029
	LTE Band 66/50RB#0 20M	Top Side	132072	19.90	21.00	1.288	0.387	0.499
	LTE Band 71/1RB#0 20M	Front Side	133222	23.90	24.50	1.148	0.106	0.122
58#	LTE Band 71/1RB#0 20M	Back Side	133222	23.90	24.50	1.148	0.155	0.178
	LTE Band 71/1RB#0 20M	Left Side	133222	23.90	24.50	1.148	0.043	0.049
	LTE Band 71/1RB#0 20M	Right Side	133222	23.90	24.50	1.148	0.129	0.148
	LTE Band 71/1RB#0 20M	Bottom Side	133222	23.90	24.50	1.148	0.101	0.116
	LTE Band 71/50RB#0 20M	Front Side	133222	22.99	23.50	1.125	0.100	0.112
	LTE Band 71/50RB#0 20M	Back Side	133222	22.99	23.50	1.125	0.132	0.148
	LTE Band 71/50RB#0 20M	Left Side	133222	22.99	23.50	1.125	0.032	0.036
	LTE Band 71/50RB#0 20M	Right Side	133222	22.99	23.50	1.125	0.086	0.097
	LTE Band 71/50RB#0 20M	Bottom Side	133222	22.99	23.50	1.125	0.092	0.103

➤ **WLAN Hotspot SAR**

Plot No.	Band/Mode	Test Position	CH.	Ave. Power (dBm)	Tune-up Limit (dBm)	Tune-up Scaling Factor	Meas. SAR1g (W/kg)	Reported SAR1g (W/kg)
	WLAN2.4GHz/802.11b	Front Side	1	18.42	18.50	1.019	0.069	0.070
59#	WLAN2.4GHz/802.11b	Back Side	1	18.42	18.50	1.019	0.083	0.084
	WLAN2.4GHz/802.11b	Right Side	1	18.42	18.50	1.019	0.059	0.060
	WLAN2.4GHz/802.11b	Top Side	1	18.42	18.50	1.019	0.048	0.049
	WLAN5.2GHz/802.11n-20	Front Side	48	16.39	17.00	1.151	0.027	0.032
60#	WLAN5.2GHz/802.11n-20	Back Side	48	16.39	17.00	1.151	0.052	0.061
	WLAN5.2GHz/802.11n-20	Right Side	48	16.39	17.00	1.151	0.040	0.047
	WLAN5.2GHz/802.11n-20	Top Side	48	16.39	17.00	1.151	0.017	0.020
	WLAN5.8GHz/802.11a	Front Side	165	17.07	18.00	1.239	0.023	0.029
61#	WLAN5.8GHz/802.11a	Back Side	165	17.07	18.00	1.239	0.088	0.110
	WLAN5.8GHz/802.11a	Right Side	165	17.07	18.00	1.239	0.053	0.067
	WLAN5.8GHz/802.11a	Top Side	165	17.07	18.00	1.239	0.033	0.042

Note:

1. The reported 1g SAR (W/kg) has been calculated together with the duty cycle scaling factor 1.006 for LTE Band 41, 1.021 for 5.2GHz WLAN and 1.019 for 5.3GHz/5.5Hz/5.8GHz WLAN.



17.5. Extremity SAR Assessment

Guidance:

1. According to KDB 648747 D04v01r03 The UMPC mini-tablet procedures must also be applied to test the SAR of all surfaces and edges with an antenna located at ≤ 25 mm from that surface or edge, in direct contact with a flat phantom, for 10-g extremity SAR according to the body-equivalent tissue dielectric parameters in KDB Publication 865664 D01 to address interactive hand use exposure conditions.
2. When hotspot mode applies, 10-g extremity SAR is required only for the surfaces and edges with hotspot mode 1-g reported SAR > 1.2 W/kg.
3. According to the user manual, the EUT diagonal size is greater than 16cm, therefore the 0mm extremity SAR of WLAN 5GHz is required. Only the worst was tested the extremity SAR in this report.
4. Test results as below:

Plot No.	Band/Mode	Test Position	CH.	Ave. Power (dBm)	Tune-up Limit (dBm)	Tune-up Scaling Factor	Meas. SAR _{10g} (W/kg)	Reported SAR _{10g} (W/kg)
OR	WLAN5.3GHz/802.11a	Back Side	64	16.62	17.50	1.225	0.067	0.083
62#	WLAN5.3GHz/802.11a	Back Side	64	16.62	17.50	1.225	0.197	0.246
OR	WLAN5.5GHz/802.11a	Back Side	120	16.90	17.50	1.148	0.077	0.090
63#	WLAN5.5GHz/802.11a	Back Side	120	16.90	17.50	1.148	0.202	0.236

17.6. Repeated SAR Assessment

In accordance with published RF Exposure KDB procedure 865664 D01 SAR measurement 100 MHz to 6 GHz. These additional measurements are repeated after the completion of all measurements requiring the same head or body tissue-equivalent medium in a frequency band. The test device should be returned to ambient conditions (normal room temperature) with the battery fully charged before it is re-mounted on the device holder for the repeated measurement(s) to minimize any unexpected variations in the repeated results.

- 1) Repeated measurement is not required when the original highest measured SAR is < 0.80 W/kg; steps 2) through 4) do not apply.
- 2) When the original highest measured SAR is ≥ 0.80 W/kg, repeat that measurement once.
- 3) Perform a second repeated measurement only if the ratio of largest to smallest SAR for the original and first repeated measurements is > 1.20 or when the original or repeated measurement is ≥ 1.45 W/kg (~ 10% from the 1-g SAR limit).
- 4) Perform a third repeated measurement only if the original, first or second repeated measurement is ≥ 1.5 W/kg and the ratio of largest to smallest SAR for the original, first and second repeated measurements is > 1.20 .

➤ Repeated SAR

Plot No.	Band/Mode	Test Position	CH.	Ave. Power (dBm)	Tune-up Limit (dBm)	Tune-up Scaling Factor	Meas. SAR1g (W/kg)	Reported SAR1g (W/kg)
OR	GPRS 1900/3 TX slots	Left Cheek	512	27.62	28.50	1.225	0.904	1.107
	GPRS 1900/3 TX slots	Left Cheek	512	27.62	28.50	1.225	0.901	1.103
OR	Band II/RMC	Left Tilt	9538	22.28	22.50	1.052	1.140	1.199
	Band II/RMC	Left Tilt	9538	22.28	22.50	1.052	1.125	1.183
OR	Band IV/RMC	Left Tilt	1413	21.32	22.00	1.169	0.960	1.123
	Band IV/RMC	Left Tilt	1413	21.32	22.00	1.169	0.957	1.120
OR	LTE Band 2/1RB#0 20M	Left Tilt	19100	21.75	22.50	1.189	0.915	1.087
	LTE Band 2/1RB#0 20M	Left Tilt	19100	21.75	22.50	1.189	0.912	1.084
OR	LTE Band 4/1RB#0 20M	Left Tilt	20175	21.18	22.00	1.208	0.911	1.100
	LTE Band 4/1RB#0 20M	Left Tilt	20175	21.18	22.00	1.208	0.910	1.099
OR	LTE Band 25/1RB#49 20M	Right Tilt	26590	21.78	22.50	1.180	0.916	1.081



	LTE Band 25/1RB#49 20M	Right Tilt	26590	21.78	22.50	1.180	0.914	1.079
OR	LTE Band 66/1RB#0 20M	Left Tilt	132072	20.97	22.00	1.268	0.881	1.117
	LTE Band 66/1RB#0 20M	Left Tilt	132072	20.97	22.00	1.268	0.879	1.114
OR	LTE Band 30/1RB#49 10M	Bottom Side	27710	23.39	24.00	1.151	1.030	1.185
	LTE Band 30/1RB#49 10M	Bottom Side	27710	23.39	24.00	1.151	1.028	1.183

18. Simultaneous Transmission Evaluation

18.1. Simultaneous Transmission Consideration

No.	Simultaneous Transmission Consideration	Head	Body-Worn	Hotspot
1	WWAN+WLAN 2.4GHz	Yes	Yes	Yes
2	WWAN+WLAN 5.2GHz/5.8GHz	Yes	Yes	Yes
3	WWAN+WLAN 5.3GHz/5.5GHz	Yes	Yes	NO
4	WWAN+Bluetooth	NO	Yes	Yes

Note:

- When the user enables the personal wireless router functions for the handset, actual operations include simultaneous transmission of both the Wi-Fi transmitter and another WWAN transmitter. Both transmitter often do not transmit at the same transmitting frequency and thus cannot be evaluated for SAR under actual use conditions. The "Portable Hotspot" feature on the handset was not activated, to ensure the SAR measurements were evaluated for a single transmission frequency RF signal.
- The hotspot SAR result may overlap with the body-worn accessory SAR requirements, per KDB 941225 D06, the more conservative configurations can be considered, thus excluding some unnecessary body-worn accessory SAR tests.
- Simultaneous Transmission SAR evaluation is not required for BT and Wi-Fi, because the software mechanism have been incorporated to guarantee that the WLAN and Bluetooth transmitters would not simultaneously operate.
- Per KDB 447498D01v06, Simultaneous Transmission SAR Evaluation procedures is as followed:

Step 1: If sum of 1 g SAR < 1.6 W/kg, Simultaneous SAR measurement is not required.

Step 2: If sum of 1 g SAR > 1.6 W/kg, ratio of SAR to peak separation distance for pair of transmitters calculated.

Step 3: If the ratio of SAR to peak separation distance is ≤ 0.04 , Simultaneous SAR measurement is not required.

Step 4: If the ratio of SAR to peak separation distance is > 0.04 , Simultaneous SAR measurement is required and simultaneous transmission SAR value is calculated.

(The ratio is determined by: $(SAR1 + SAR2) \wedge 1.5/Ri \leq 0.04$,

Ri is the separation distance between the peak SAR locations for the antenna pair in mm.

18.2. Simultaneous Transmission Analysis

➤ Head Simultaneous Transmission

WWAN Band		Exposure Position	1	2	3	1+2 Summed 1g SAR (W/kg)	1+3 Summed 1g SAR (W/kg)
			WWAN	2.4GHz WLAN	5GHz WLAN		
			1g SAR (W/kg)	1g SAR (W/kg)	1g SAR (W/kg)		
GSM	GSM850	Right Cheek	0.128	0.097	0.044	0.225	0.172
		Right Tilt	0.065	0.105	0.048	0.170	0.113
		Left Cheek	0.091	0.102	0.135	0.193	0.226
		Left Tilt	0.070	0.152	0.121	0.222	0.191
	GSM1900	Right Cheek	0.840	0.097	0.044	0.937	0.884
		Right Tilt	0.938	0.105	0.048	1.043	0.986
		Left Cheek	1.107	0.102	0.135	1.209	1.242
		Left Tilt	0.829	0.152	0.121	0.981	0.950
WCDMA	WCDMA Band II	Right Cheek	0.653	0.097	0.044	0.750	0.697
		Right Tilt	1.010	0.105	0.048	1.115	1.058
		Left Cheek	0.719	0.102	0.135	0.821	0.854
		Left Tilt	1.199	0.152	0.121	1.351	1.320
	WCDMA Band IV	Right Cheek	0.674	0.097	0.044	0.771	0.718
		Right Tilt	0.971	0.105	0.048	1.076	1.019
		Left Cheek	0.775	0.102	0.135	0.877	0.910
		Left Tilt	1.123	0.152	0.121	1.275	1.244
	WCDMA Band V	Right Cheek	0.293	0.097	0.044	0.390	0.337
		Right Tilt	0.179	0.105	0.048	0.284	0.227
		Left Cheek	0.250	0.102	0.135	0.352	0.385
		Left Tilt	0.161	0.152	0.121	0.313	0.282
CDMA	LTE Band 2	Right Cheek	0.754	0.097	0.044	0.851	0.798
		Right Tilt	1.084	0.105	0.048	1.189	1.132
		Left Cheek	0.601	0.102	0.135	0.703	0.736
		Left Tilt	1.087	0.152	0.121	1.239	1.208
LTE	LTE Band 4	Right Cheek	0.645	0.097	0.044	0.742	0.689
		Right Tilt	0.923	0.105	0.048	1.028	0.971
		Left Cheek	0.726	0.102	0.135	0.828	0.861
		Left Tilt	1.100	0.152	0.121	1.252	1.221
	LTE Band 5	Right Cheek	0.308	0.097	0.044	0.405	0.352
		Right Tilt	0.180	0.105	0.048	0.285	0.228



		Left Cheek	0.223	0.102	0.135	0.325	0.358
		Left Tilt	0.162	0.152	0.121	0.314	0.283
	LTE Band 12	Right Cheek	0.180	0.097	0.044	0.277	0.224
		Right Tilt	0.083	0.105	0.048	0.188	0.131
		Left Cheek	0.154	0.102	0.135	0.256	0.289
		Left Tilt	0.093	0.152	0.121	0.245	0.214
	LTE Band 13	Right Cheek	0.113	0.097	0.044	0.210	0.157
		Right Tilt	0.056	0.105	0.048	0.161	0.104
		Left Cheek	0.091	0.102	0.135	0.193	0.226
		Left Tilt	0.063	0.152	0.121	0.215	0.184
	LTE Band 25	Right Cheek	0.697	0.097	0.044	0.794	0.741
		Right Tilt	1.081	0.105	0.048	1.186	1.129
		Left Cheek	0.718	0.102	0.135	0.820	0.853
		Left Tilt	0.983	0.152	0.121	1.135	1.104
	LTE Band 26	Right Cheek	0.118	0.097	0.044	0.215	0.162
		Right Tilt	0.074	0.105	0.048	0.179	0.122
		Left Cheek	0.152	0.102	0.135	0.254	0.287
		Left Tilt	0.094	0.152	0.121	0.246	0.215
	LTE Band 30	Right Cheek	0.070	0.097	0.044	0.167	0.114
		Right Tilt	0.140	0.105	0.048	0.245	0.188
		Left Cheek	0.056	0.102	0.135	0.158	0.191
		Left Tilt	0.064	0.152	0.121	0.216	0.185
	LTE Band 41	Right Cheek	0.076	0.097	0.044	0.173	0.120
		Right Tilt	0.078	0.105	0.048	0.183	0.126
		Left Cheek	0.047	0.102	0.135	0.149	0.182
		Left Tilt	0.028	0.152	0.121	0.180	0.149
	LTE Band 66	Right Cheek	0.749	0.097	0.044	0.846	0.793
		Right Tilt	1.008	0.105	0.048	1.113	1.056
Left Cheek		0.790	0.102	0.135	0.892	0.925	
Left Tilt		1.117	0.152	0.121	1.269	1.238	
LTE Band 71	Right Cheek	0.083	0.097	0.044	0.180	0.127	
	Right Tilt	0.040	0.105	0.048	0.145	0.088	
	Left Cheek	0.076	0.102	0.135	0.178	0.211	
	Left Tilt	0.042	0.152	0.121	0.194	0.163	



➤ **Body-worn Simultaneous Transmission**

WWAN Band		Exposure Position	1	2	3	4	1+2	1+3	1+4
			WWAN 1g SAR (W/kg)	2.4GHz WLAN 1g SAR (W/kg)	5GHz WLAN 1g SAR (W/kg)	Bluetooth Estimated 1g SAR (W/kg)	Sum. 1g SAR (W/kg)	Sum. 1g SAR (W/kg)	Sum. 1g SAR (W/kg)
GSM	GSM850	Front	0.181	0.070	0.037	0.165	0.251	0.218	0.346
		Back	0.391	0.084	0.110	0.165	0.475	0.501	0.556
	GSM1900	Front	0.256	0.070	0.037	0.165	0.326	0.293	0.421
		Back	0.682	0.084	0.110	0.165	0.766	0.792	0.847
WCDMA	WCDMA Band II	Front	0.297	0.070	0.037	0.165	0.367	0.334	0.462
		Back	0.498	0.084	0.110	0.165	0.582	0.608	0.663
	WCDMA Band IV	Front	0.243	0.070	0.037	0.165	0.313	0.280	0.408
		Back	0.702	0.084	0.110	0.165	0.786	0.812	0.867
	WCDMA Band V	Front	0.361	0.070	0.037	0.165	0.431	0.398	0.526
		Back	0.497	0.084	0.110	0.165	0.581	0.607	0.662
CDMA	LTE Band 2	Front	0.209	0.070	0.037	0.165	0.279	0.246	0.374
		Back	0.664	0.084	0.110	0.165	0.748	0.774	0.829
LTE	LTE Band 4	Front	0.154	0.070	0.037	0.165	0.224	0.191	0.319
		Back	0.545	0.084	0.110	0.165	0.629	0.655	0.710
	LTE Band 5	Front	0.221	0.070	0.037	0.165	0.291	0.258	0.386
		Back	0.481	0.084	0.110	0.165	0.565	0.591	0.646
	LTE Band 12	Front	0.249	0.070	0.037	0.165	0.319	0.286	0.414
		Back	0.320	0.084	0.110	0.165	0.404	0.430	0.485
	LTE Band 13	Front	0.165	0.070	0.037	0.165	0.235	0.202	0.330
		Back	0.294	0.084	0.110	0.165	0.378	0.404	0.459
	LTE Band 25	Front	0.165	0.070	0.037	0.165	0.235	0.202	0.330
		Back	0.661	0.084	0.110	0.165	0.745	0.771	0.826
	LTE Band 26	Front	0.257	0.070	0.037	0.165	0.327	0.294	0.422
		Back	0.505	0.084	0.110	0.165	0.589	0.615	0.670
	LTE Band 30	Front	0.482	0.070	0.037	0.165	0.552	0.519	0.647
		Back	1.046	0.084	0.110	0.165	1.130	1.156	1.211
	LTE Band 41	Front	0.022	0.070	0.037	0.165	0.092	0.059	0.187
		Back	0.602	0.084	0.110	0.165	0.686	0.712	0.767
	LTE Band 66	Front	0.102	0.070	0.037	0.165	0.172	0.139	0.267
		Back	0.450	0.084	0.110	0.165	0.534	0.560	0.615
LTE Band	Front	0.122	0.070	0.037	0.165	0.192	0.159	0.287	



	71	Back	0.178	0.084	0.110	0.165	0.262	0.288	0.343
--	----	------	-------	-------	-------	-------	-------	-------	-------

➤ Hotspot Simultaneous Transmission

WWAN Band		Exposure Position	1	2	3	4	1+2	1+3	1+4
			WWAN	2.4GHz WLAN	5GHz WLAN	Bluetooth	Sum. 1g SAR (W/kg)	Sum. 1g SAR (W/kg)	Sum. 1g SAR (W/kg)
			1g SAR (W/kg)	1g SAR (W/kg)	1g SAR (W/kg)	Estimated 1g SAR (W/kg)			
GSM	GSM850	Front	0.181	0.070	0.037	0.165	0.251	0.218	0.346
		Back	0.391	0.084	0.110	0.165	0.475	0.501	0.556
		Left	0.022			0.165	0.022	0.022	0.187
		Right	0.105	0.060	0.067	0.165	0.165	0.172	0.270
		Top		0.049	0.042	0.165	0.049	0.042	0.165
		Bottom	0.299			0.165	0.299	0.299	0.464
	GSM1900	Front	0.256	0.070	0.037	0.165	0.326	0.293	0.421
		Back	0.682	0.084	0.110	0.165	0.766	0.792	0.847
		Left	0.103			0.165	0.103	0.103	0.268
		Right	0.096	0.060	0.067	0.165	0.156	0.163	0.261
Top		0.658	0.049	0.042	0.165	0.707	0.700	0.823	
WCDMA	WCDMA Band II	Front	0.297	0.070	0.037	0.165	0.367	0.334	0.462
		Back	0.498	0.084	0.110	0.165	0.582	0.608	0.663
		Left	0.101			0.165	0.101	0.101	0.266
		Right	0.090	0.060	0.067	0.165	0.150	0.157	0.255
		Top	0.519	0.049	0.042	0.165	0.568	0.561	0.684
	WCDMA Band IV	Front	0.243	0.070	0.037	0.165	0.313	0.280	0.408
		Back	0.702	0.084	0.110	0.165	0.786	0.812	0.867
		Left	0.133			0.165	0.133	0.133	0.298
		Right	0.115	0.060	0.067	0.165	0.175	0.182	0.280
		Top	0.503	0.049	0.042	0.165	0.552	0.545	0.668
	WCDMA Band V	Front	0.361	0.070	0.037	0.165	0.431	0.398	0.526
		Back	0.497	0.084	0.110	0.165	0.581	0.607	0.662
		Left	0.102			0.165	0.102	0.102	0.267
		Right	0.336	0.060	0.067	0.165	0.396	0.403	0.501
		Top		0.049	0.042	0.165	0.049	0.042	0.165
Bottom		0.382			0.165	0.382	0.382	0.547	
CDMA	LTE Band 2	Front	0.209	0.070	0.037	0.165	0.279	0.246	0.374
		Back	0.664	0.084	0.110	0.165	0.748	0.774	0.829



LTE		Left	0.083			0.165	0.083	0.083	0.248
		Right	0.036	0.060	0.067	0.165	0.096	0.103	0.201
		Top	0.532	0.049	0.042	0.165	0.581	0.574	0.697
	LTE Band 4	Front	0.154	0.070	0.037	0.165	0.224	0.191	0.319
		Back	0.545	0.084	0.110	0.165	0.629	0.655	0.710
		Left	0.065			0.165	0.065	0.065	0.230
		Right	0.034	0.060	0.067	0.165	0.094	0.101	0.199
		Top	0.499	0.049	0.042	0.165	0.548	0.541	0.664
		Bottom							
	LTE Band 5	Front	0.221	0.070	0.037	0.165	0.291	0.258	0.386
		Back	0.481	0.084	0.110	0.165	0.565	0.591	0.646
		Left	0.027			0.165	0.027	0.027	0.192
		Right	0.017	0.060	0.067	0.165	0.077	0.084	0.182
		Top		0.049	0.042	0.165	0.049	0.042	0.165
		Bottom	0.275			0.165	0.275	0.275	0.440
	LTE Band 12	Front	0.249	0.070	0.037	0.165	0.319	0.286	0.414
		Back	0.320	0.084	0.110	0.165	0.404	0.430	0.485
		Left	0.179			0.165	0.179	0.179	0.344
		Right	0.244	0.060	0.067	0.165	0.304	0.311	0.409
		Top		0.049	0.042	0.165	0.049	0.042	0.165
		Bottom	0.260			0.165	0.260	0.260	0.425
	LTE Band 13	Front	0.165	0.070	0.037	0.165	0.235	0.202	0.330
		Back	0.294	0.084	0.110	0.165	0.378	0.404	0.459
		Left	0.039			0.165	0.039	0.039	0.204
		Right	0.256	0.060	0.067	0.165	0.316	0.323	0.421
		Top		0.049	0.042	0.165	0.049	0.042	0.165
		Bottom	0.282			0.165	0.282	0.282	0.447
LTE Band 25	Front	0.165	0.070	0.037	0.165	0.235	0.202	0.330	
	Back	0.661	0.084	0.110	0.165	0.745	0.771	0.826	
	Left	0.062			0.165	0.062	0.062	0.227	
	Right	0.053	0.060	0.067	0.165	0.113	0.120	0.218	
	Top	0.474	0.049	0.042	0.165	0.523	0.516	0.639	
LTE Band 26	Front	0.257	0.070	0.037	0.165	0.327	0.294	0.422	
	Back	0.505	0.084	0.110	0.165	0.589	0.615	0.670	
	Left	0.013			0.165	0.013	0.013	0.178	
	Right	0.165	0.060	0.067	0.165	0.225	0.232	0.330	
	Top		0.049	0.042	0.165	0.049	0.042	0.165	
	Bottom	0.268			0.165	0.268	0.268	0.433	
LTE Band	Front	0.482	0.070	0.037	0.165	0.552	0.519	0.647	



	30	Back	1.046	0.084	0.110	0.165	1.130	1.156	1.211
		Left	0.034			0.165	0.034	0.034	0.199
		Right	0.010	0.060	0.067	0.165	0.070	0.077	0.175
		Top		0.049	0.042	0.165	0.049	0.042	0.165
		Bottom	1.185			0.165	1.185	1.185	1.350
	LTE Band 41	Front	0.022	0.070	0.037	0.165	0.092	0.059	0.187
		Back	0.602	0.084	0.110	0.165	0.686	0.712	0.767
		Left	0.033			0.165	0.033	0.033	0.198
		Right	0.019	0.060	0.067	0.165	0.079	0.086	0.184
		Top		0.049	0.042	0.165	0.049	0.042	0.165
		Bottom	0.699			0.165	0.699	0.699	0.864
	LTE Band 66	Front	0.102	0.070	0.037	0.165	0.172	0.139	0.267
		Back	0.450	0.084	0.110	0.165	0.534	0.560	0.615
		Left	0.045			0.165	0.045	0.045	0.210
		Right	0.034	0.060	0.067	0.165	0.094	0.101	0.199
		Top	0.517	0.049	0.042	0.165	0.566	0.559	0.682
	LTE Band 71	Front	0.122	0.070	0.037	0.165	0.192	0.159	0.287
		Back	0.178	0.084	0.110	0.165	0.262	0.288	0.343
		Left	0.049			0.165	0.049	0.049	0.214
		Right	0.148	0.060	0.067	0.165	0.208	0.215	0.313
		Top		0.049	0.042	0.165	0.049	0.042	0.165
Bottom		0.116			0.165	0.116	0.116	0.281	

19. Uncertainty Assessment

The component of uncertainty may generally be categorized according to the methods used to evaluate them. The evaluation of uncertainty by the statistical analysis of a series of observations is termed a Type A evaluation of uncertainty. The evaluation of uncertainty by means other than the statistical analysis of a series of observation is termed a Type B evaluation of uncertainty. Each component of uncertainty, however evaluated, is represented by an estimated standard deviation, termed standard uncertainty, which is determined by the positive square root of the estimated variance.

A Type A evaluation of standard uncertainty may be based on any valid statistical method for treating data. This includes calculating the standard deviation of the mean of a series of independent observations; using the method of least squares to fit a curve to the data in order to estimate the parameter of the curve and their standard deviations; or carrying out an analysis of variance in order to identify and quantify random effects in certain kinds of measurement.

A type B evaluation of standard uncertainty is typically based on scientific judgment using all of the relevant information available. These may include previous measurement data, experience, and knowledge of the behavior and properties of relevant materials and instruments, manufacture's specification, data provided in calibration reports and uncertainties assigned to reference data taken from handbooks. Broadly speaking, the uncertainty is either obtained from an outdoor source or obtained from an assumed distribution, such as the normal distribution, rectangular or triangular distributions indicated in table below.

Uncertainty	Normal	Rectangular	Triangular	U-Shape
Multi-plying Factor ^(a)	1/k ^(b)	1/√3	1/√6	1/√2

Standard Uncertainty for Assumed Distribution

- (a) standard uncertainty is determined as the product of the multiplying factor and the estimated range of variations in the measured quantity
- (b) κ is the coverage factor

The combined standard uncertainty of the measurement result represents the estimated standard deviation of the result. It is obtained by combining the individual standard uncertainties of both Type A and Type B evaluation using the usual "root-sum-squares" (RSS) methods of combining standard deviations by taking the positive square root of the estimated variances.

Expanded uncertainty is a measure of uncertainty that defines an interval about the measurement result within which the measured value is confidently believed to lie. It is obtained by multiplying the combined standard uncertainty by a coverage factor. Typically, the coverage factor ranges from 2 to 3. Using a coverage factor allows the true value of a measured quantity to be specified with a defined probability within the specified uncertainty range. For purpose of this document, a coverage factor two is used, which corresponds to confidence interval of about 95 %. The DASY uncertainty Budget is shown in the following



tables.

Error Description	Uncertainty Value (±%)	Probability	Divisor	(Ci) 1g	(Ci) 10g	Standard Uncertainty (1g) (±%)	Standard Uncertainty (10g) (±%)
Measurement System							
Probe Calibration	6.0	N	1	1	1	6.0	6.0
Axial Isotropy	4.7	R	1.732	0.7	0.7	1.9	1.9
Hemispherical Isotropy	9.6	R	1.732	0.7	0.7	3.9	3.9
Boundary Effects	1.0	R	1.732	1	1	0.6	0.6
Linearity	4.7	R	1.732	1	1	2.7	2.7
System Detection Limits	1.0	R	1.732	1	1	0.6	0.6
Modulation Response	3.2	R	1.732	1	1	1.8	1.8
Readout Electronics	0.3	N	1	1	1	0.3	0.3
Response Time	0.0	R	1.732	1	1	0.0	0.0
Integration Time	2.6	R	1.732	1	1	1.5	1.5
RF Ambient Noise	3.0	R	1.732	1	1	1.7	1.7
RF Ambient Reflections	3.0	R	1.732	1	1	1.7	1.7
Probe Positioner	0.4	R	1.732	1	1	0.2	0.2
Probe Positioning	2.9	R	1.732	1	1	1.7	1.7
Max. SAR Eval.	2.0	R	1.732	1	1	1.2	1.2
Test Sample Related							
Device Positioning	3.0	N	1	1	1	3.0	3.0
Device Holder	3.6	N	1	1	1	0.089	0.089
Power Drift	5.0	R	1.732	1	1	2.9	2.9
Power Scaling	0.0	R	1.732	1	1	0.0	0.0
Phantom and Setup							
Phantom Uncertainty	6.1	R	1.732	1	1	3.5	3.5
SAR correction	0.0	R	1.732	1	0.84	0.0	0.0
Liquid Conductivity Repeatability	0.2	N	1	0.78	0.71	0.1	0.1
Liquid Conductivity (target)	5.0	R	1.732	0.78	0.71	2.3	2.0
Liquid Conductivity (mea.)	2.5	R	1.732	0.78	0.71	1.1	1.0
Temp. unc. - Conductivity	3.4	R	1.732	0.78	0.71	1.5	1.4
Liquid Permittivity Repeatability	0.15	N	1	0.23	0.26	0.0	0.0
Liquid Permittivity (target)	5.0	R	1.732	0.23	0.26	0.7	0.8
Liquid Permittivity (mea.)	2.5	R	1.732	0.23	0.26	0.3	0.4
Temp. unc. - Permittivity	0.83	R	1.732	0.23	0.26	0.1	0.1
Combined Std. Uncertainty						11.4%	11.4%
Coverage Factor for 95 %						K=2	K=2
Expanded STD Uncertainty						22.9%	22.7%

Error Description	Uncertainty Value (±%)	Probability	Divisor	(Ci) 1g	(Ci) 10g	Standard Uncertainty (1g) (±%)	Standard Uncertainty (10g) (±%)
Measurement System							
Probe Calibration	6.55	N	1	1	1	6.0	6.0



Axial Isotropy	4.7	R	1.732	0.7	0.7	1.9	1.9
Hemispherical Isotropy	9.6	R	1.732	0.7	0.7	3.9	3.9
Boundary Effects	2.0	R	1.732	1	1	1.2	1.2
Linearity	4.7	R	1.732	1	1	2.7	2.7
System Detection Limits	1.0	R	1.732	1	1	0.6	0.6
Modulation Response	3.2	R	1.732	1	1	1.8	1.8
Readout Electronics	0.3	N	1	1	1	0.3	0.3
Response Time	0.0	R	1.732	1	1	0.0	0.0
Integration Time	2.6	R	1.732	1	1	1.5	1.5
RF Ambient Noise	3.0	R	1.732	1	1	1.7	1.7
RF Ambient Reflections	3.0	R	1.732	1	1	1.7	1.7
Probe Positioner	0.4	R	1.732	1	1	0.2	0.2
Probe Positioning	6.7	R	1.732	1	1	3.9	3.9
Max. SAR Eval.	4.0	R	1.732	1	1	2.3	2.3
Test Sample Related							
Device Positioning	3.0	N	1	1	1	3.0	3.0
Device Holder	3.6	N	1	1	1	0.089	0.089
Power Drift	5.0	R	1.732	1	1	2.9	2.9
Power Scaling	0.0	R	1.732	1	1	0.0	0.0
Phantom and Setup							
Phantom Uncertainty	6.1	R	1.732	1	1	3.8	3.8
SAR correction	0.0	R	1.732	1	0.84	0.0	0.0
Liquid Conductivity Repeatability	0.2	N	1	0.78	0.71	0.1	0.1
Liquid Conductivity (target)	5.0	R	1.732	0.78	0.71	2.3	2.0
Liquid Conductivity (mea.)	2.5	R	1.732	0.78	0.71	1.1	1.0
Temp. unc. - Conductivity	3.4	R	1.732	0.78	0.71	1.5	1.4
Liquid Permittivity Repeatability	0.15	N	1	0.23	0.26	0.0	0.0
Liquid Permittivity (target)	5.0	R	1.732	0.23	0.26	0.7	0.8
Liquid Permittivity (mea.)	2.5	R	1.732	0.23	0.26	0.3	0.4
Temp. unc. - Permittivity	0.83	R	1.732	0.23	0.26	0.1	0.1
Combined Std. Uncertainty						12.5%	12.5%
Coverage Factor for 95 %						K=2	K=2
Expanded STD Uncertainty						25.1 %	25.1%



Annex A General Information

1. Identification of the Responsible Testing Laboratory

Laboratory Name:	Shenzhen Morlab Communications Technology Co., Ltd. Morlab Laboratory
Laboratory Address:	FL.3, Building A, FeiYang Science Park, No.8 LongChang Road, Block 67, BaoAn District, ShenZhen, Guangdong Province, P. R. China
Telephone:	+86 755 36698555
Facsimile:	+86 755 36698525

2. Identification of the Responsible Testing Location

Name:	Shenzhen Morlab Communications Technology Co., Ltd. Morlab Laboratory
Address:	FL.3, Building A, FeiYang Science Park, No.8 LongChang Road, Block 67, BaoAn District, ShenZhen, Guangdong Province, P. R. China

Note:

The main report is end here and the other Annex (B,C,D,E) will be submitted separately.

***** END OF MAIN REPORT *****