



Hearing Aid Compatibility (HAC) RF Emissions Test Report

APPLICANT : Great Talent Technology Limited
PRODUCT NAME : Smart Phone
MODEL NAME : ACK2326
BRAND NAME : ANS
FCC ID : 2ALZM-ACK2326
STANDARD(S) : FCC 47 CFR Part 20(20.19)
ANSI C63.19-2011
RECEIPT DATE : 2022-04-01
TEST DATE : 2022-05-08
ISSUE DATE : 2022-05-25

Edited by: Xie Yiyun
Xie Yiyun (Rapporteur)

Approved by: Shen Junsheng
Shen Junsheng (Supervisor)

NOTE: This document is issued by Shenzhen Morlab Communications Technology Co., Ltd., the test report shall not be reproduced except in full without prior written permission of the company. The test results apply only to the particular sample(s) tested and to the specific tests carried out which is available on request for validation and information confirmed at our website.





DIRECTORY

- 1. Attestation of Testing Summary 4
- 2. Technical Information..... 5
 - 2.1. Applicant and Manufacturer Information..... 5
 - 2.2. Equipment under Test (EUT) Description..... 5
 - 2.3. Photographs of the EUT..... 7
 - 2.4. Applied Reference Documents 7
- 3. RF Audio Interference Level..... 8
- 4. Air Interface and Operating Mode 9
- 5. HAC (RF) Measurement System 11
 - 5.1. RF Measurement Setup..... 11
 - 5.2. System Unit..... 12
- 6. RF Measurement Procedure..... 14
 - 6.1. General Guidance 14
 - 6.2. RF Test Instructions 15
- 7. Test Equipment List..... 17
- 8. System Validation 18
 - 8.1. Test setup..... 18
 - 8.2. Validation Result..... 19
- 9. Modulation Interference Factor 20
- 10. Conducted Power 22
- 11. Low-power Exemption 22
- 12. Summary Test Results 23
- 13. Uncertainty Assessment..... 24
- Annex A General Information..... 25



Change History		
Version	Date	Reason for Change
1.0	2022-05-25	First edition



1. Attestation of Testing Summary

Air Interface	Frequency Band	E-field M-Rating
GSM CMRS Voice	GSM850	M4
	GSM1900	M4
VoLTE	Band 41	M4

Note:

1. It is compliance with HAC limits for this device that specified in FCC 47 CFR Part 20.19 and ANSI C63.19.
2. When the test result is a critical value, we will use the measurement uncertainty give the judgment result based on the 95% confidence intervals.



2. Technical Information

Note: Provide by Applicant.

2.1. Applicant and Manufacturer Information

Applicant:	Great Talent Technology Limited
Applicant Address:	35F, HBC HuiLong Center Building-II Minzhi Street, Longhua, Shenzhen, P. R. China 518110
Manufacturer:	Great Talent Technology Limited
Manufacturer Address:	35F, HBC HuiLong Center Building-II Minzhi Street, Longhua, Shenzhen, P. R. China 518110

2.2. Equipment under Test (EUT) Description

Product Name:	Smart Phone
EUT IMEI:	990019120001294
Hardware Version:	Q6002_V1.0
Software Version:	ACK2326V1.0.0B001
Frequency Bands:	GSM 850: 824 MHz ~ 849 MHz GSM 1900: 1850 MHz ~ 1910 MHz WCDMA Band II: 1850 MHz ~ 1910 MHz WCDMA Band IV: 1710 MHz ~ 1755 MHz WCDMA Band V: 824 MHz ~ 849 MHz LTE Band 2: 1850 MHz ~ 1910 MHz LTE Band 4: 1710 MHz ~ 1755 MHz LTE Band 5: 824 MHz ~ 849 MHz LTE Band 12: 699 MHz ~ 716 MHz LTE Band 25: 1850 MHz ~ 1915 MHz LTE Band 26: 814 MHz ~ 849 MHz LTE Band 41: 2496 MHz ~ 2690 MHz LTE Band 66: 1710 MHz ~ 1780 MHz LTE Band 71: 663 MHz ~ 698 MHz WLAN 2.4GHz: 2412 MHz ~ 2462 MHz WLAN 5.2GHz: 5180 MHz ~ 5240 MHz WLAN 5.8GHz: 5745 MHz ~ 5825 MHz Bluetooth: 2402 MHz ~ 2480 MHz
Modulation Mode:	GSM/GPRS: GMSK EDGE: 8PSK WCDMA: QPSK, 16QAM



	LTE: QPSK, 16QAM, 64QAM 802.11b: DSSS 802.11a/g/n-HT20/HT40/ac-VHT20/40/80: OFDM BR+EDR: GFSK(1Mbps), $\pi/4$ -DQPSK(2Mbps), 8-DPSK(3Mbps) Bluetooth LE: GFSK(1Mbps)
VoLTE Mode:	Support
VoWi-Fi Mode:	Not Support
SIM Cards Description:	GSM+WCDMA +LTE

Note:

For more detailed description, please refer to specification or user manual supplied by the applicant and/or manufacturer.



2.3. Photographs of the EUT

Note: Please refer to the External Photos for the Photos of the EUT

2.4. Applied Reference Documents

Leading reference documents for testing:

No.	Identity	Document Title	Method determination /Remark
1	FCC 47 CFR Part 20 (20.19)	Hearing aid-compatible mobile handsets.	No deviation
2	ANSI C63.19-2011	American National Standard Methods of Measurement of Compatibility between Wireless Communications Devices and Hearing Aids	No deviation
3	KDB 285076 D01v06	HAC Guidance	No deviation

Note 1: The test item is not applicable.
Note 2: Additions to, deviation, or exclusions from the method shall be judged in the "method determination" column of add, deviate or exclude from the specific method shall be explained in the "Remark" of the above table.

3. RF Audio Interference Level

FCC wireless hearing aid compatibility rules ensure that consumers with hearing loss are able to access wireless communications services through a wide selection of handsets without experiencing disabling radio frequency (RF) interference or other technical obstacles. To define and measure the hearing aid compatibility of handsets, in CFR47 part 20.19 ANSI C63.19 is referenced.

A handset is considered hearing aid-compatible for acoustic coupling if it meets a rating of at least M3 under ANSI C63.19, and A handset is considered hearing aid compatible for inductive coupling if it meets a rating of at least T3. According to ANSI C63.19 2011 version, for acoustic coupling, the RF electric field emissions of wireless communication devices should be measured and rated according to the emission level as below.

Table 3.1 WD RF audio Interference level categories in logarithmic units

Emission Categories	E-field Emissions	
	<960MHz	>960MHz
M1	50 to 55 dB (V/m)	45 to 50 dB (V/m)
M2	45 to 50 dB (V/m)	35 to 40 dB (V/m)
M3	40 to 45 dB (V/m)	30 to 35 dB (V/m)
M4	<40 dB (V/m)	<30 dB (V/m)

Table 3.2 System performance classification table

System classification	Category sum
	Hearing aid category + telephone category
Usable	Hearing aid category + telephone category = 4
Normal use	Hearing aid category + telephone category = 5
Excellent performance	Hearing aid category + telephone category = ≥ 6



4. Air Interface and Operating Mode

Air Interface	Band	Transport Type	Simultaneous Transmitter	Name of Voice Service	Power Reduction
GSM	GSM850	VO	Wi-Fi &BT	CMRS Voice	No
	GSM1900				No
WCDMA (UMTS)	Band II	VO	Wi-Fi &BT	CMRS Voice	No
	Band IV				No
	Band V				No
FDD-LTE	Band 2	VD	Wi-Fi &BT	VoLTE	No
	Band 4				No
	Band 5				No
	Band 12				No
	Band 25				No
	Band 26				No
	Band 66				No
	Band 71	No			
TDD-LTE	Band 41	VD	Wi-Fi &BT	VoLTE	No
Wi-Fi	2450	DT	GSM,UMTS, LTE	N/A	No
	5200 (U-NII-1)				No
	5800 (U-NII-3)				No
BT	2450	DT	GSM,UMTS, LTE	N/A	No

Where:

VO=Voice Only

DT=Digital Transport only

VD=CMRS and IP Voice Service over Digital Transport

BT=Bluetooth

* Ref Lev in accordance with 7.4.2.1 of ANSI C63.19-2011 and the July 2012 VoLTE interpretation

** Ref Lev -20 dBm0

*** Ref Lev XYNNet established by KDB Inquiry NNNNNN @ -16 dBm0

Note:

- 1) Air Interface/Band MHz: List of all air interfaces and bands supported by the handset.
- 2) Type: For each air interface, indicate the type of voice transport mode:
 - i. VO = legacy Cellular Voice Service, from Table 7.1 in 7.4.2.1 of ANSI C63.19-2011;
 - ii. DT = Digital Transport only (no voice);
 - iii. VD = IP Voice Service over Digital Transport.
- 3) Simultaneous Transmitter: Indicate any air interface/bands that operate in simultaneous or



concurrent service transmission mode.

- 4) Name of Voice Service: See Q4 in 285076 D03 HAC FAQ for further clarification.
 - a) Ref Lev in accordance with 7.4.2.1 of ANSI C63.19-2011 and the July 2012 VoLTE interpretation
 - b) ** Ref Lev -20 dBm0
 - c) *** Ref Lev XYNet established by KDB Inquiry NNNNNN @ -16 dBm0

5. HAC (RF) Measurement System

5.1. RF Measurement Setup

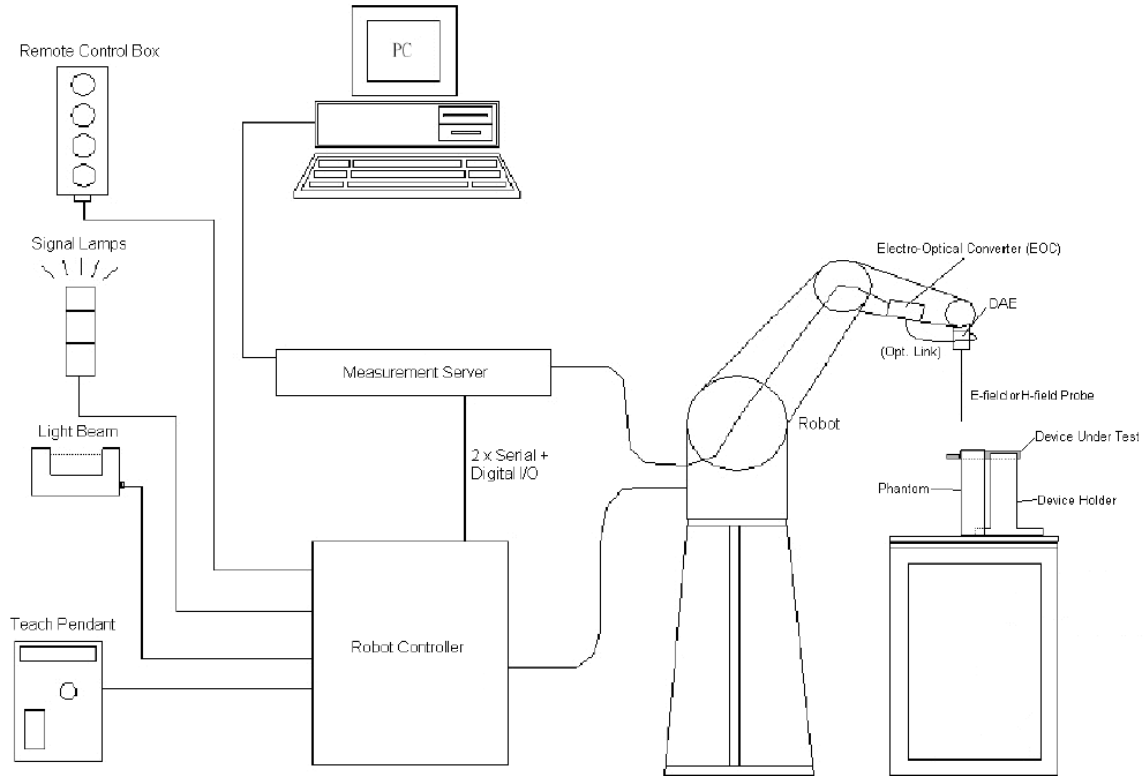

Fig 5.1 SPEAG RF System Configurations

5.2. System Unit

➤ E-Field Probe

The RF measurement is conducted with the dosimetric probe (manufactured by SPEAG). The probe is specially designed and calibrated for use with high permittivity. The dosimetric probe has special calibration at different frequency. This probe has a built in optical surface detection system to prevent from collision with phantom.

E-Field Probe Specification

<ER3DV6>

Construction	One dipole parallel, two dipoles normal to probe axis Built-in shielding against static charges	 <p style="text-align: center;">Fig 5.2 Photo of ER3DV6</p>
Calibration	In air from 100 MHz to 3.0 GHz (Absolute accuracy $\pm 6.0\%$, $k=2$)	
Frequency	10 MHz to 6 GHz; Linearity: ± 0.2 dB	
Directivity	± 0.2 dB in HSL (rotation around probe axis) ± 0.4 dB in HSL (rotation normal to probe axis)	
Dynamic Range	2 V/m to 1000 V/m (M3 or better device readings fall well below diode compression point)	
Linearity	± 0.2 dB	
Dimensions	Overall length: 330 mm (Tip: 16 mm) Tip diameter: 8 mm (Body: 12 mm) Distance from probe tip to dipole centers: 2.5 mm	
Probe Tip Description: HAC field measurements take place in the close near field with high gradients. Increasing the measuring distance from the source will generally decrease the measured field values (in case of the validation dipole approx. 10% per mm).		

➤ **Data Acquisition Electronics (DAE)**

The data acquisition electronics (DAE) consists of a highly sensitive electrometer-grade preamplifier with auto-zeroing, a channel and gain-switching multiplexer, a fast 16 bit AD-converter and a command decoder and control logic unit. AD-converter and a command decoder and control logic unit. Transmission to the measurement server is accomplished through an optical downlink for data and status information as well as an optical uplink for commands and the clock.

The input impedance of the DAE is 200 MOhm; the inputs are symmetrical and floating. Common mode rejection is above 80 dB.

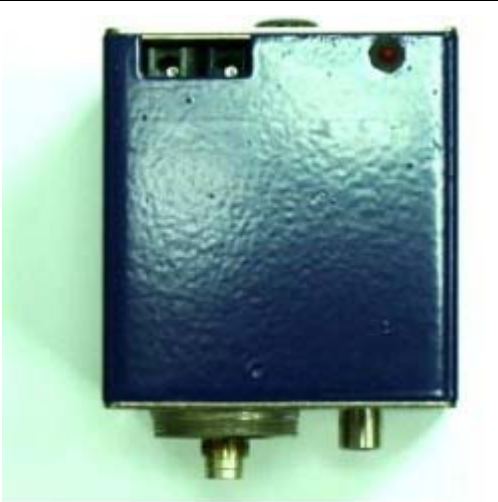

Fig 5.3 Photo of DAE

➤ **Test Arch**

Construction	Active single sensor probe for both the axial and radial measurement scans – Fully RF shielded, compatible with DAE and adapted probe cup.
Dimensions	Length: 370 mm Width: 370 mm Height: 370 mm



Fig 5.4 Photo of Arch



6. RF Measurement Procedure

6.1. General Guidance

Referenced from ANSI C63.19 -2011 section 5.5.1:

1. Confirm the proper operation of the field probe, probe measurement system, and other instrumentation and the positioning system.
2. Position the WD in its intended test position.
3. Set the WD to transmit a fixed and repeatable combination of signal power and modulation characteristic that is representative of the worst case (highest interference potential) encountered in normal use. Transiently occurring start-up, changeover, or termination conditions, or other operations likely to occur less than 1% of the time during normal operation, may be excluded from consideration. Transiently occurring start-up, changeover, or termination conditions, or other operations likely to occur less than 1% of the time during normal operation, may be excluded from consideration.
4. The center sub-grid shall be centered on the T-Coil mode perpendicular measurement point or the acoustic output, as appropriate. Locate the field probe at the initial test position in the 50 mm by 50 mm grid, which is contained in the measurement plane, refer to illustrated in Figure 8.2. If the field alignment method is used, align the probe for maximum field reception.
5. Record the reading at the output of the measurement system.
6. Scan the entire 50 mm by 50 mm region in equality spaced increments and record the reading at each measurement point, the distance between measurement points shall be sufficient to assure the identification of the maximum reading.
7. Identify the five contiguous sub-grids around the center sub-grid whose maximum reading is the lowest of all available choices. This eliminates the three sub-grids with the maximum readings. Thus, the six areas to be used to determine the WD's highest emissions are identified.
8. Identify the maximum reading within the non-excluded sub-grids identified in step 7).
9. Convert the maximum reading identified in step 8) to RF audio interference level, in, V/m, by taking the square root of the reading and then dividing it by the measurement system transfer function, established in ANSI C63.19 -2011 section 5.5.1.1. Convert the result to dB(V/m) by taking the base-10 logarithm and multiplying it by 20. Expressed as a formula:

$$\text{RF audio interference level in dB(V/m)} = 20 \times \log(R_{\max}^{1/2}/TF),$$

where R_{\max} is the maximum reading.

10. The RF audio interference level in dB (V/m) is obtained by adding the MIF (in dB) to the maximum steady-state rms field-strength reading, in dB (V/m)
11. Compare this RF audio interference level with the categories in ANSI C63.19-2011 clause 8 and record the resulting WD category rating.

6.2. RF Test Instructions

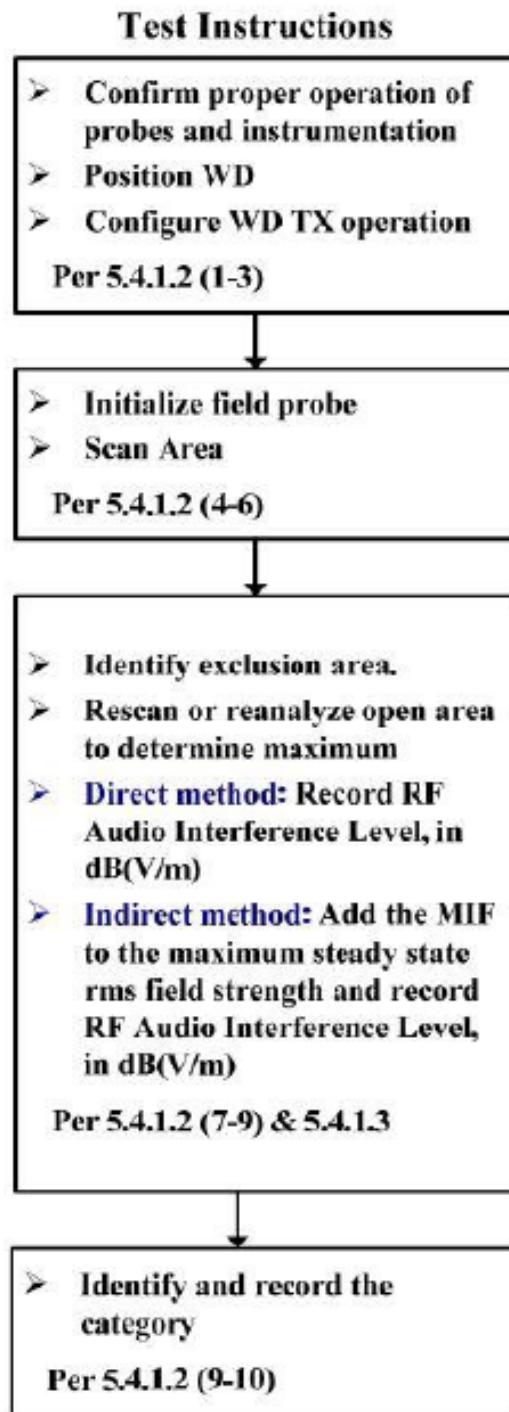

Fig 6.1 WD near-field emission scan flowchart

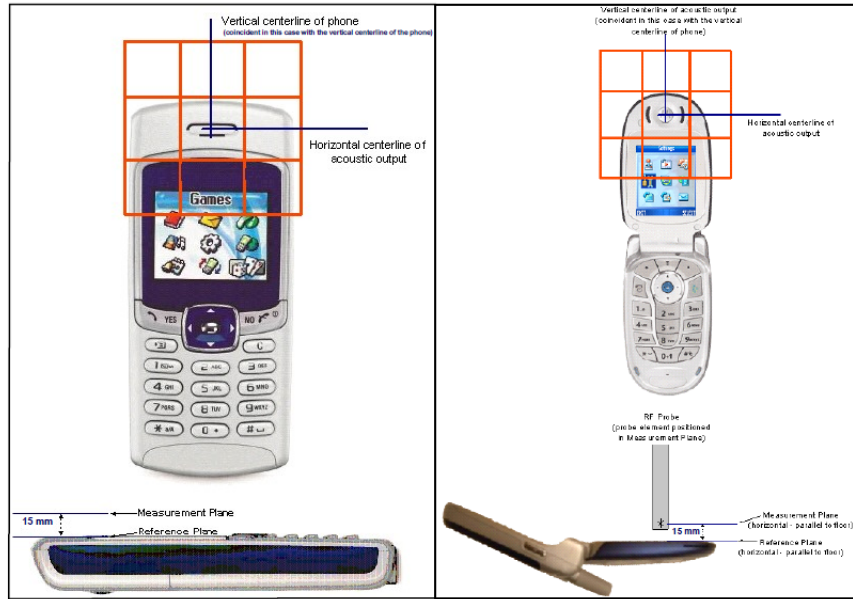

Fig 6.2 WD reference and plane for RF emission measurements

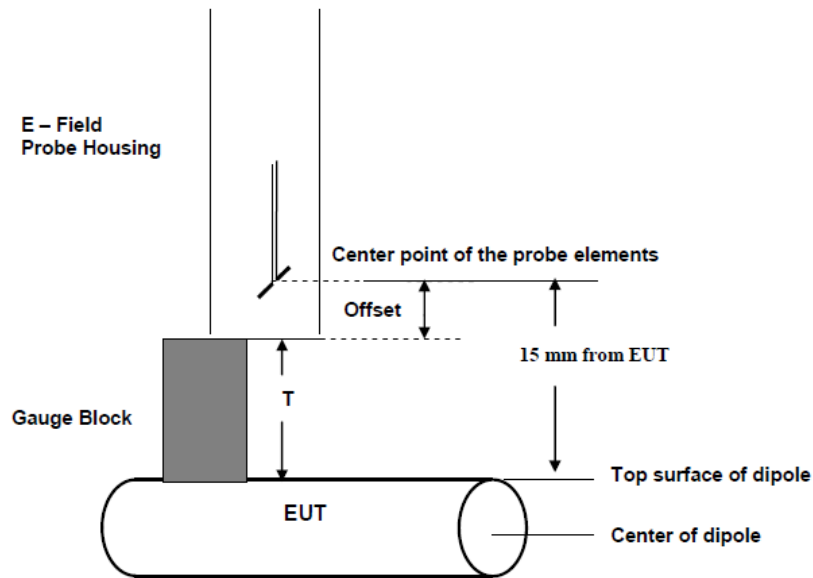

Fig 6.3 Gauge block with E-field probe



7. Test Equipment List

Manufacturer	Name of Equipment	Type/Model	Serial Number	Calibration	
				Last Cal.	Due Date
SPEAG	Isotropic E-Field Probe	ER3DV6	2434	2022.03.04	2023.03.03
SPEAG	Audio Holder	N/A	1094	NCR	NCR
SPEAG	835MHz Calibration Dipole	CD835V3	1113	2021.10.23	2024.10.22
SPEAG	1880MHz Calibration Dipole	CD1880V3	1111	2021.10.23	2024.10.22
SPEAG	2600MHz Calibration Dipole	CD2600V3	1010	2021.10.23	2024.10.22
SPEAG	DOSIMETRIC ASSESSMENT SYSTEM	DASY52	52.10.4.1527	NCR	NCR
SPEAG	Data Acquisition Electronics	DAE4	480	2021.06.22	2022.06.21
R&S	Base Station	CMU200	107082	2021.07.26	2022.07.27
R&S	Network Emulator	CMW500	165755	2022.02.14	2023.02.13
Agilent	Signal Generator	N5182B	MY53050509	2022.01.07	2023.01.06
Agilent	Power Sensor	N8482A	MY41090849	2021.10.21	2022.10.20
Agilent	Power Meter	E4416A	MY45102093	2021.10.21	2022.10.20
Anritsu	Power Sensor	MA2411B	N/A	2021.10.21	2022.10.20
Anritsu	Power Meter	NRVD	101066	2021.10.21	2022.10.20
mini-circuits	Amplifier	ZHL-42W+	608501717	NCR	NCR
Agilent	Dual Directional Coupler	778D	50422	NA	NA

8. System Validation

According to ANSI C63.19, before hearing aid testing commences, the experimental setup shall be validated. Sub clauses 6.3.1 through 6.3.5 include a set of pretest procedures designed to validate the experimental setup to ensure the accuracy of the results. To verify that the hearing aid performs per the manufacturer's specifications, 6.3.5 advises that the hearing aid be pretested per ANSI S3.22.

8.1. Test setup

1. In the simplified setup for system evaluation, the EUT is replaced by a calibrated dipole and the power source is replaced by a continuous wave which comes from a signal generator.
2. Position the E-field probe at a 15 mm distance from the top surface of the dipole, which is also fixed in an appropriate fixture.
3. Make sure that the desired measuring channel of the probe is aligned for maximum reception of the E-field generated by the dipole. This may be accomplished by rotating the probe until the maximum value is located. The E-field probe shall have been calibrated over the frequency range to be measured using standard calibration techniques.
4. Adjust the power level (20dBm \rightarrow 100mW) of the signal generator at the initial starting frequency such that the desired E-field strength at the 15 mm distance from the tip of the dipole is achieved. Setting the field strength to be in the range of category M2 is advised.
5. Step the frequency in increments of $\leq 1\%$, adjusting the power fed into the dipole such that the desired E-field strength is maintained.

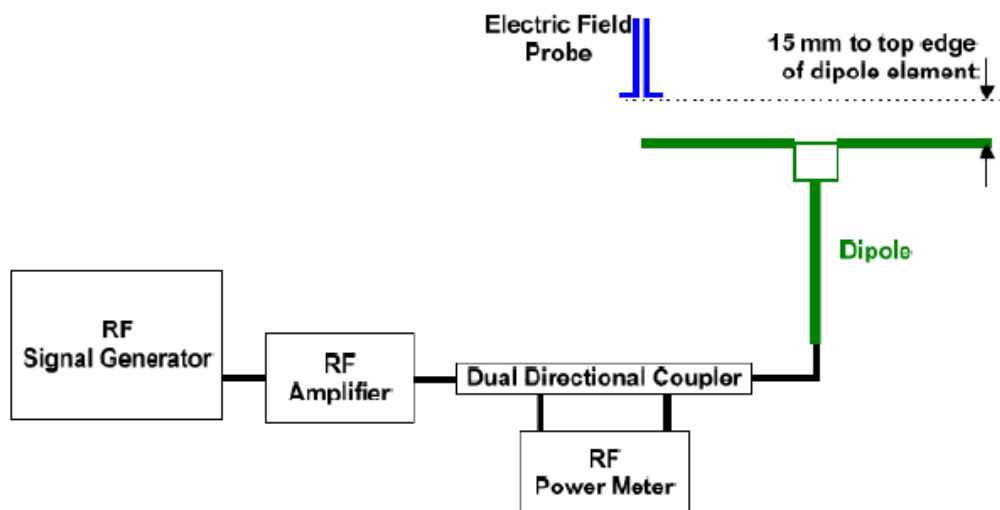

Fig 8.1 WD dipole calibration procedure



8.2. Validation Result

After testing, record the frequency and signal generator setting at each frequency for use during the actual immunity test. Comparing to the original E-field value provided by SPEAG, the verification data should be within its specification of 25 %. Table 6.1 shows the target value and measured value. The table below indicates the system performance check can meet the variation criterion and the plots can be referred to annex A of this report. Deviation = ((Average E-field Value) - (Target value)) / (Target value) * 100%

Fre. (MHz)	Input Power (mW)	Target Value (V/m)	E-Field above high end (V/m)	E-Field above low end (V/m)	Average Value (V/m)	Deviation (%)	Limit (%)	Date
835	100	110.80	120.64	120.5	120.57	8.82	±12.8	2022.05.08
1880	100	89.50	97.05	95.83	96.44	7.75	±12.8	2022.05.08
2600	100	86.80	94.51	91.94	93.225	7.40	±12.8	2022.05.08



9. Modulation Interference Factor

The HAC Standard ANSI C63.19-2011 defines a new scaling using the Modulation Interference Factor (MIF). For any specific fixed and repeatable modulated signal, a modulation interference factor (MIF, expressed in dB) may be developed that relates its interference potential to its steady-state rms signal level or average power level.

This factor is a function only of the audio-frequency amplitude modulation characteristics of the signal and is the same for field-strength and conducted power measurements. It is important to emphasize that the MIF is valid only for a specific repeatable audio-frequency amplitude modulation characteristic. Any change in modulation characteristic requires determination and application of a new MIF.

The Modulation Interference factor (MIF, in dB) is added to the measured average E-field (in dBV/m) and converts it to the RF Audio Interference level (in dBV/m). This level considers the audible amplitude modulation components in the RF E-field. CW fields without amplitude modulation are assumed to not interfere with the hearing aid electronics. Modulations without time slots and low fluctuations at low frequencies have low MIF values, TDMA modulations with narrow transmission and repetition rates of few 100 Hz have high MIF values and give similar classifications as ANSI C63.19-2011. ER3D, EF3D and EU2D E-field probes have a bandwidth <10 kHz and can therefore not evaluate the RF envelope in the full audio band. DASY52 is therefore using the indirect measurement method according to ANSI C63.19-2011 which is the primary method. These near field probes read the averaged E-field measurement. Especially for the new high peak-to-average (PAR) signal types, the probes shall be linearized by PMR calibration in order to not overestimate the field reading. Probe Modulation Response (PMR) calibration linearizes the probe response over its dynamic range for specific modulations which are characterized by their UID and result in an uncertainty specified in the probe calibration certificate. The MIF is characteristic for a given waveform envelope and can be used as a constant conversion factor if the probe has been PMR calibrated. The evaluation method for the MIF is defined in ANSI C63.19-2011 section D.7. An RMS demodulated RF signal is fed to a spectral filter (similar to an A weighting filter) and forwarded to a temporal filter acting as a quasi-peak detector. The averaged output of these filtering is scaled to a 1 kHz 80% AM signal as reference. MIF measurement requires additional instrumentation and is not well suited for evaluation by the end user with reasonable uncertainty. It may alternatively be determined through analysis and simulation, because it is constant and characteristic for a communication signal. DASY52 uses well-defined signals for PMR calibration. The MIF of these signals has been determined by simulation and it is automatically applied. The MIF measurement uncertainty is estimated as follows, declared by HAC equipment provider SPEAG, for modulation frequencies from slotted waveforms with fundamental frequency and at least 2 harmonics within 10 kHz:

0.2 dB for MIF	0.5 dB for MIF	1 dB for MIF
-7dB to +5 dB	-13dB to +11 dB	> -20 dB



MIF values applied in this test report were provided by the HAC equipment provider of SPEAG, and the worst values for all air interface are listed below to be determine the Low-power Exemption.

UID	Communication System Name	MIF(dB)
10021	GSM-FDD(TDMA,GMSK)	3.63
10025	EDGE-FDD (TDMA, 8PSK, TN 0)	3.75
10460	UMTS-FDD(WCDMA, AMR)	-25.43
10225	UMTS-FDD (HSPA+)	-20.39
10169	LTE-FDD(SC-FDMA,1RB,20MHz,QPSK)	-15.63
10170	LTE-FDD(SC-FDMA,1RB,20MHz,16-QAM)	-9.76
10179	LTE-FDD(SC-FDMA,1RB,20MHz,64-QAM)	-9.93
10181	LTE-FDD(SC-FDMA,1RB,15MHz,QPSK)	-15.63
10175	LTE-FDD(SC-FDMA,1RB,10MHz,QPSK)	-15.63
10177	LTE-FDD(SC-FDMA,1RB,5MHz,QPSK)	-15.63
10184	LTE-FDD(SC-FDMA,1RB,3MHz,QPSK)	-15.62
10187	LTE-FDD(SC-FDMA,1RB,1.4MHz,QPSK)	-15.62
10172	LTE-TDD (SC-FDMA, 1 RB, 20 MHz, QPSK)	-1.62
10173	LTE-TDD (SC-FDMA, 1 RB, 20 MHz, 16-QAM)	-1.44
10174	LTE-TDD (SC-FDMA, 1 RB, 20 MHz, 64-QAM)	-1.54
10240	LTE-TDD (SC-FDMA, 1 RB, 15 MHz, QPSK)	-1.62
10237	LTE-TDD (SC-FDMA, 1 RB, 10 MHz, QPSK)	-1.62
10234	LTE-TDD (SC-FDMA, 1 RB, 5 MHz, QPSK)	-1.62
10231	LTE-TDD (SC-FDMA, 1 RB, 3 MHz, QPSK)	-1.62
10228	LTE-TDD (SC-FDMA, 1 RB, 1.4 MHz, QPSK)	-1.62
10061	IEEE 802.11b WiFi 2.4 GHz (DSSS, 11 Mbps)	-2.02
10077	IEEE 802.11g WiFi 2.4 GHz (DSSS/OFDM, 54 Mbps)	0.12
10427	IEEE 802.11n (HT Greeneld, 150 Mbps, 64-QAM)	-13.44
10069	IEEE 802.11a/h WiFi 5 GHz (OFDM, 54 Mbps)	-3.15
10616	IEEE 802.11ac WiFi (40MHz, MCS0, 90pc duty cycle)	-5.57

10. Conducted Power

The maximum tune-up power of WWAN & WLAN was recorded in the annex E of SZ22040005S01.

11. Low-power Exemption

Air Interface	Max Tune-up Limit (dBm)	Worst Case MIF (dB)	Power + MIF(dB)	C63.19 Test Required
GSM850	30.00	3.63	33.63	Yes
GSM1900	30.00	3.63	33.63	Yes
WCDMA II	23.50	-25.43	-1.93	No
WCDMA IV	23.50	-25.43	-1.93	No
WCDMA V	23.50	-25.43	-1.93	No
LTE Band 2	23.50	-9.76	13.74	No
LTE Band 4	24.50	-9.76	14.74	No
LTE Band 5	23.50	-9.76	13.74	No
LTE Band 12	23.50	-9.76	13.74	No
LTE Band 25	23.50	-9.76	13.74	No
LTE Band 26	23.50	-9.76	13.74	No
LTE Band 41	24.00	-1.62	22.38	Yes
LTE Band 66	24.50	-9.76	14.74	No
LTE Band 71	24.50	-9.76	14.74	No

Note:

1. According to ANSI C63.19 2011-version, for the air interface technology of a device is exempt from testing when its average antenna input power plus its MIF is ≤ 17 dBm for any of its operating modes.
2. For all of bands, the worst case of maximum tune-up limit will be test RF emission, therefore WCDMA and FDD-LTE mode is not necessary for testing.
3. For GSM mode, only GSM voice will be tested for the low power exemption.
4. HAC RF rating is M4 for the air interface which meets the low power exemption.



12. Summary Test Results

Air Interface	Mode	Channel	MIF	E-Field (dBV/m)	Margin to FCC M3 limit (dB)	E-Field M Rating
GSM850	GSM Voice	128	3.63	33.18	11.82	M4
GSM850	GSM Voice	189	3.63	33.22	11.78	M4
GSM850	GSM Voice	251	3.63	33.12	11.88	M4
GSM1900	GSM Voice	512	3.63	27.01	7.99	M4
GSM1900	GSM Voice	661	3.63	27.14	7.86	M4
GSM1900	GSM Voice	810	3.63	27.09	7.91	M4
LTE Band 41	QPSK/1RB#0/20MHz	39750	-1.44	21.85	13.15	M4
LTE Band 41	QPSK/1RB#0/20MHz	40185	-1.44	21.78	13.22	M4
LTE Band 41	QPSK/1RB#0/20MHz	40620	-1.44	21.82	13.18	M4
LTE Band 41	QPSK/1RB#0/20MHz	41055	-1.44	21.78	13.22	M4
LTE Band 41	QPSK/1RB#0/20MHz	41490	-1.44	21.83	13.17	M4

Remark:

Phone condition: HAC Air on, Backlight off, maximum volume.



13. Uncertainty Assessment

The component of uncertainty may generally be categorized according to the methods used to evaluate them. The evaluation of uncertainty by the statistical analysis of a series of observations is termed a Type A evaluation of uncertainty. The evaluation of uncertainty by means other than the statistical analysis of a series of observations is termed a Type B evaluation of uncertainty. Each component of uncertainty, however evaluated, is represented by an estimated standard deviation, termed standard uncertainty, which is determined by the positive square root of the estimated variance.

The combined standard uncertainty of the measurement result represents the estimated standard deviation of the result. It is obtained by combining the individual standard uncertainties of both Type A and Type B evaluation using the usual "root-sum-squares" (RSS) methods of combining standard deviations by taking the positive square root of the estimated variances. Expanded uncertainty is a measure of uncertainty that defines an interval about the measurement result within which the measured value is confidently believed to lie. It is obtained by multiplying the combined standard uncertainty by a coverage factor. For purpose of this document, a coverage factor two is used, which corresponds to confidence interval of about 95 %. The DASY uncertainty Budget is shown in Table 12.1.



Annex A General Information

1. Identification of the Responsible Testing Laboratory

Laboratory Name:	Shenzhen Morlab Communications Technology Co., Ltd.
Laboratory Address:	FL. 3, Building A, FeiYang Science Park, No.8 LongChang Road, Block 67, BaoAn District, ShenZhen, GuangDong Province, P. R. China
Telephone:	+86 755 36698555
Facsimile:	+86 755 36698525

2. Identification of the Responsible Testing Location

Name:	Shenzhen Morlab Communications Technology Co., Ltd.
Address:	FL. 3, Building A, FeiYang Science Park, No.8 LongChang Road, Block 67, BaoAn District, ShenZhen, GuangDong Province, P. R. China

Note:

The main report is end here and the other annex (B,C,D,E) will be submitted separately.

***** END OF MAIN REPORT *****