

TEST REPORT

FCC Rules Part 15.249

Report Reference No..... : MTEB24050014-R1

FCC ID..... : 2ALZG-327

Compiled by

(position+printed name+signature)..: File administrators Alisa Luo



Supervised by

(position+printed name+signature)..: Test Engineer Sunny Deng



Approved by

(position+printed name+signature)..: Manager Yvette Zhou



Date of issue.....: **May 07,2024**

Representative Laboratory Name. : Shenzhen Most Technology Service Co., Ltd.

Address.....: No.5, 2nd Langshan Road, North District, Hi-tech Industrial Park,
Nanshan, Shenzhen, Guangdong, China.

Applicant's name..... : Qingdao Magene Intelligence Technology Co., Ltd.

Address.....: Room 302, Building 3, No.328A Chengkang Road, Xiazhuang
Subdistrict, Chengyang District, Qingdao, Shandong, China.

Test specification/ Standard..... : FCC Part15 Subpart C, Section 15.249

TRF Originator.....: Shenzhen Most Technology Service Co., Ltd.

Shenzhen Most Technology Service Co., Ltd. All rights reserved.

This publication may be reproduced in whole or in part for non-commercial purposes as long as the Shenzhen Most Technology Service Co., Ltd. is acknowledged as copyright owner and source of the material. Shenzhen Most Technology Service Co., Ltd. takes no responsibility for and will not assume liability for damages resulting from the reader's interpretation of the reproduced material due to its placement and context.

Test item description..... : AT Series Smart Bike Headlight

Trade Mark.....: Magene

Model/Type reference.....: P0108307(This model have two versions of AT1200 and AT1600,
which control brightness differences through firmware.)

Listed Models: N/A

Modulation Type.....: GFSK

Operation Frequency.....: 2457MHz

Hardware version.....: 1.0

Software version: 1.0

Rating.....: Input: 5.0V $\overline{=}$,2.0A, Output: 5.0V $\overline{=}$,2.0A

Battery: 3.6V, 5.0Ah

Result.....: **PASS**

TEST REPORT

Equipment under Test : AT Series Smart Bike Headlight

Model /Type : P0108307(This model have two versions of AT1200 and AT1600, which control brightness differences through firmware.)

Listed Models : N/A

Remark : N/A

Applicant : Qingdao Magene Intelligence Technology Co., Ltd.

Address : Room 302, Building 3, No.328A Chengkang Road, Xiazhuang Subdistrict, Chengyang District, Qingdao, Shandong, China.

Manufacturer : Qingdao Magene Intelligence Technology Co., Ltd.

Address : Room 302, Building 3, No.328A Chengkang Road, Xiazhuang Subdistrict, Chengyang District, Qingdao, Shandong, China.

Test Result:	PASS
---------------------	-------------

The test report merely corresponds to the test sample.
It is not permitted to copy extracts of these test result without the written permission of the test laboratory.

Contents

1. REVISION HISTORY	4
2. TEST STANDARDS	5
3. SUMMARY	6
3.1. General Remarks	6
3.2. Product Description	6
3.3. Equipment Under Test	6
3.4. Short description of the Equipment under Test (EUT)	6
3.5. EUT operation mode	6
3.6. Block Diagram of Test Setup	7
3.7. Test Item (Equipment Under Test) Description	7
3.8. Auxiliary Equipment (AE) Description	7
3.9. Antenna Information*	7
3.10. EUT configuration	7
3.11. Modifications	8
4. TEST ENVIRONMENT	9
4.1. Address of the test laboratory	9
4.2. Environmental conditions	9
4.3. Test Description	10
4.4. Statement of the measurement uncertainty	10
4.5. Equipments Used during the Test	11
5. TEST CONDITIONS AND RESULTS	12
5.1. AC Power Conducted Emission	12
5.2. Radiated Spurious Emissions and Bandedge Emission	15
5.3. 20dB Bandwidth	21
5.4. Radiated field strength of the fundamental signal	23
5.5. Antenna Requirement	26
6. TEST SETUP PHOTOS OF THE EUT	28
7. EXTERNAL AND INTERNAL PHOTOS OF THE EUT	29

1. Revision History

Revision	Issue Date	Revisions	Revised By
00	2024.05.07	Initial Issue	Alisa Luo

2. TEST STANDARDS

The tests were performed according to following standards:

The tests were performed according to following standards:

[FCC Rules Part 15.249](#): Operation within the bands 902-928 MHz, 2400-2483.5 MHz, 5725-5875 MHz, and 24.0-24.25 GHz.

[RSS-210](#): Licence-Exempt Radio Apparatus: Category I Equipment

[ANSI C63.10-2013](#): American National Standard for Testing Unlicensed Wireless Devices.

3. SUMMARY

3.1. General Remarks

Date of receipt of test sample	:	2024.04.27
Testing commenced on	:	2024.04.28
Testing concluded on	:	2024.05.07

3.2. Product Description

Product Name:	AT Series Smart Bike Headlight
Model/Type reference:	P0108307
Power Supply:	DC 3.6V by Battery DC 5V by USB Port
Testing sample ID:	MTYP04986/4987/4985
ANT+ :	
Supported Type:	ANT+
Modulation:	GFSK
Operation frequency:	2457MHz
Channel number:	1
Antenna type:	loop antenna
Antenna gain:	0dBi

3.3. Equipment Under Test

Power supply system utilised

Power supply voltage	:	<input type="radio"/> 230V / 50 Hz	<input type="radio"/> 120V / 60Hz
		<input type="radio"/> 12 V DC	<input type="radio"/> 24 V DC
		<input checked="" type="radio"/> Other (specified in blank below)	

DC 3.6V by Battery
DC 5V by USB Port

3.4. Short description of the Equipment under Test (EUT)

This is a AT Series Smart Bike Headlight For more details, refer to the user's manual of the EUT.

3.5. EUT operation mode

Channel	Freq.(MHz)	Note(Modulation Type)
01	2457	GFSK

For RF test items

The engineering test program was provided and enabled to make EUT continuous transmit. (duty cycle>98%).

For AC power line conducted emissions:

The EUT was set to connect with large package sizes transmission.
 For Radiated spurious emissions test item:

The engineering test program was provided and enabled to make EUT continuous transmit. The EUT in each of three orthogonal axis emissions had been tested, but only the worst case (X axis) data recorded in the report.

3.6. Block Diagram of Test Setup

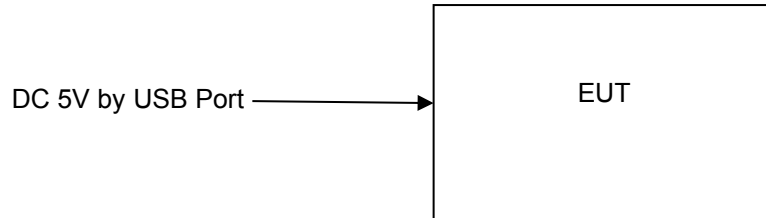

3.7. Test Item (Equipment Under Test) Description

Short designation	EUT Name	EUT Description	Serial number	Hardware status	Software status
EUT A	/	/	/	/	/
EUT B	/	/	/	/	/

*: declared by the applicant. According to customers information EUTs A and B are the same devices.

3.8. Auxiliary Equipment (AE) Description

AE short designation	EUT Name (if available)	EUT Description	Serial number (if available)	Software (if used)
AE 1	Adapter	UP0512	/	/
AE 2	-	/	/	/

3.9. Antenna Information*

Short designation	Antenna Name	Antenna Type	Frequency Range	Serial number	Antenna Peak Gain
Antenna 1	---	/	2457	---	0dBi
Antenna 2	/	/	/	/	/

*: declared by the applicant.

3.10. EUT configuration

The following peripheral devices and interface cables were connected during the measurement:

○ - supplied by the manufacturer

● - Supplied by the lab

● ADAPTER	M/N:	UP0512
	Manufacturer:	Salcomp (Shenzhen) Co., Ltd.

3.11. Modifications

No modifications were implemented to meet testing criteria.

4. TEST ENVIRONMENT

4.1. Address of the test laboratory

Shenzhen Most Technology Service Co., Ltd.

No.5, 2nd Langshan Road, North District, Hi-tech Industrial Park, Nanshan, Shenzhen, Guangdong, China.
The 3m-Semi anechoic test site fulfils CISPR 16-1-4 according to ANSI C63.4:2014 and CISPR 16-1-4:2010 SVSWR requirement for radiated emission above 1GHz.

Test Facility

The test facility is recognized, certified, or accredited by the following organizations:

FCC-Registration No.: 0031192610

Shenzhen Most Technology Service Co., Ltd. EMC Laboratory has been registered and fully described in a report filed with the (FCC) Federal Communications Commission. The acceptance letter from the FCC is maintained in our files.

A2LA-Lab Cert. No.: 6343.01

Shenzhen Most Technology Service Co., Ltd. EMC Laboratory has been accredited by A2LA for technical competence in the field of electrical testing, and proved to be in compliance with ISO/IEC 17025: 2005 General Requirements for the Competence of Testing and Calibration Laboratories and any additional program requirements in the identified field of testing.

4.2. Environmental conditions

Radiated Emission:

Temperature:	23 ° C
Humidity:	48 %
Atmospheric pressure:	950-1050mbar

Conducted testing:

Temperature:	24 ° C
Humidity:	45 %
Atmospheric pressure:	950-1050mbar

4.3. Test Description

FCC and IC Requirements		
FCC Part 15.203	Antenna Requirement	PASS
FCC Part 15.207	AC Power Conducted Emission	PASS
FCC Part 15. 15.249(a)	Field strength of the Fundamental signal	PASS
FCC Part 15.209/15.249(a)	Spurious Emissions	PASS
FCC Part 15.205/15.249(d)	Band edge Emissions	PASS
FCC Part 15.215/15.249	20dB Occupied Bandwidth	PASS

Remark:

1. The measurement uncertainty is not included in the test result.
2. NA = Not Applicable; NP = Not Performed

4.4. Statement of the measurement uncertainty

The data and results referenced in this document are true and accurate. The reader is cautioned that there may be errors within the calibration limits of the equipment and facilities. The measurement uncertainty was calculated for all measurements listed in this test report acc. to CISPR 16 - 4 „Specification for radio disturbance and immunity measuring apparatus and methods – Part 4: Uncertainty in EMC Measurements“ and is documented in the Shenzhen Most Technology Service Co., Ltd. quality system acc. to DIN EN ISO/IEC 17025. Furthermore, component and process variability of devices similar to that tested may result in additional deviation. The manufacturer has the sole responsibility of continued compliance of the device.

Hereafter the best measurement capability for Shenzhen Most Technology Service Co., Ltd. is reported:

Test	Range	Measurement Uncertainty	Notes
Radiated Emission	30~1000MHz	4.10 dB	(1)
Radiated Emission	1~18GHz	4.32 dB	(1)
Radiated Emission	18-40GHz	5.54 dB	(1)
Conducted Disturbance	0.15~30MHz	3.12 dB	(1)

- (1) This uncertainty represents an expanded uncertainty expressed at approximately the 95% confidence level using a coverage factor of k=2.

4.5. Equipments Used during the Test

Item	Equipment	Manufacturer	Model No.	Serial No.	Firmware versions	Last Cal.
1.	L.I.S.N.	R&S	ENV216	100093	/	2024/03/15
2	Three-phase artificial power network	Schwarzback Mess	NNLK8129	8129178	/	2024/03/15
3.	Receiver	R&S	ESCI	100492	V3.0-10-2	2024/03/15
4	Receiver	R&S	ESPI	101202	V3.0-10-2	2024/03/15
5	Spectrum analyzer	Agilent	9020A	MT-E306	A14.16	2024/03/15
6	Bilong Antenna	Sunol Sciences	JB3	A121206	/	2023/08/15
7	Horn antenna	HF Antenna	HF Antenna	MT-E158	/	2024/03/15
8	Loop antenna	Beijing Daze	ZN30900B	/	/	2024/03/15
9	Horn antenna	R&S	OBH100400	26999002	/	2024/03/15
10	Wireless Communication Test Set	R&S	CMW500	/	CMW-BASE-3.7.21	2024/03/15
11	Spectrum analyzer	R&S	FSP	100019	V4.40 SP2	2024/03/15
12	High gain antenna	Schwarzbeck	LB-180400KF	MT-E389	/	2024/03/15
13	Preamplifier	Schwarzbeck	BBV 9743	MT-E390	/	2024/03/15
14	Pre-amplifier	EMCI	EMC051845S E	MT-E391	/	2024/03/15
15	Pre-amplifier	Agilent	83051A	MT-E392	/	2024/03/15
16	High pass filter unit	Tonscend	JS0806-F	MT-E393	/	2024/03/15
17	RF Cable(below1GHz)	Times	9kHz-1GHz	MT-E394	/	2024/03/15
18	RF Cable(above 1GHz)	Times	1-40G	MT-E395	/	2024/03/15
19	RF Cable (9KHz-40GHz)	Tonscend	170660	N/A	/	2024/03/15
20	Power meter	R&S	NRVS	100444	/	2024/03/15

Note: 1. The Cal.Interval was one year.

5. TEST CONDITIONS AND RESULTS

5.1. AC Power Conducted Emission

TEST CONFIGURATION

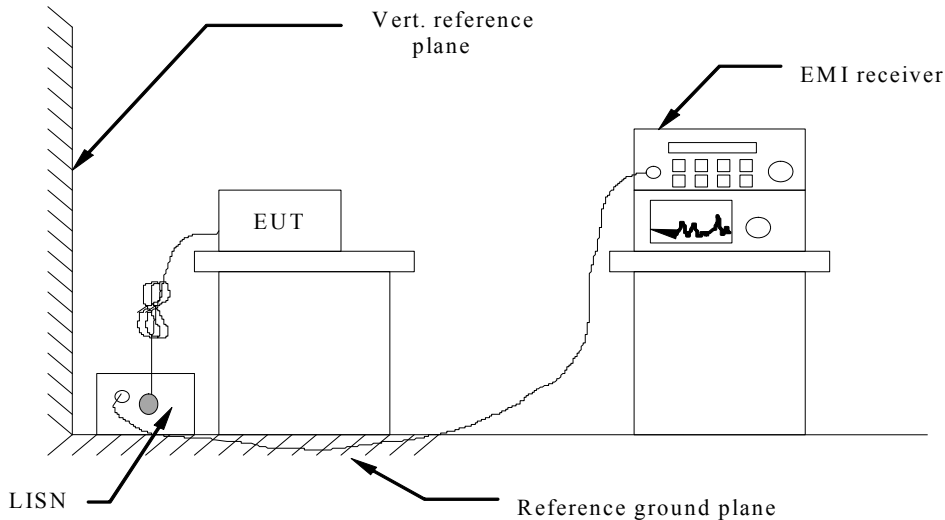

TEST PROCEDURE

- 1 The equipment was set up as per the test configuration to simulate typical actual usage per the user's manual. The EUT is a tabletop system, a wooden table with a height of 0.8 meters is used and is placed on the ground plane as per ANSI C63.10-2013.
- 2 Support equipment, if needed, was placed as per ANSI C63.10-2013
- 3 All I/O cables were positioned to simulate typical actual usage as per ANSI C63.10-2013
- 4 The EUT received DC5V power, the adapter received AC120V/60Hz power through a Line Impedance Stabilization Network (LISN) which supplied power source and was grounded to the ground plane.
- 5 All support equipments received AC power from a second LISN, if any.
- 6 The EUT test program was started. Emissions were measured on each current carrying line of the EUT using a spectrum Analyzer / Receiver connected to the LISN powering the EUT. The LISN has two monitoring points: Line 1 (Hot Side) and Line 2 (Neutral Side). Two scans were taken: one with Line 1 connected to Analyzer / Receiver and Line 2 connected to a 50 ohm load; the second scan had Line 1 connected to a 50 ohm load and Line 2 connected to the Analyzer / Receiver.
- 7 Analyzer / Receiver scanned from 150 KHz to 30MHz for emissions in each of the test modes.
- 8 During the above scans, the emissions were maximized by cable manipulation.

AC Power Conducted Emission Limit

For unintentional device, according to RSS Gen 8.8 and § 15.207(a) Line Conducted Emission Limits is as following:

Frequency range (MHz)	Limit (dBuV)	
	Quasi-peak	Average
0.15-0.5	66 to 56*	56 to 46*
0.5-5	56	46
5-30	60	50

* Decreases with the logarithm of the frequency.

TEST RESULTS

Pass

Note : Both the AT1200 and AT1600 versions have been tested, only the worst case(AT1600 versions) is recorded in this report.

Power supply:

DC 5V by USB Port

Polarization

L

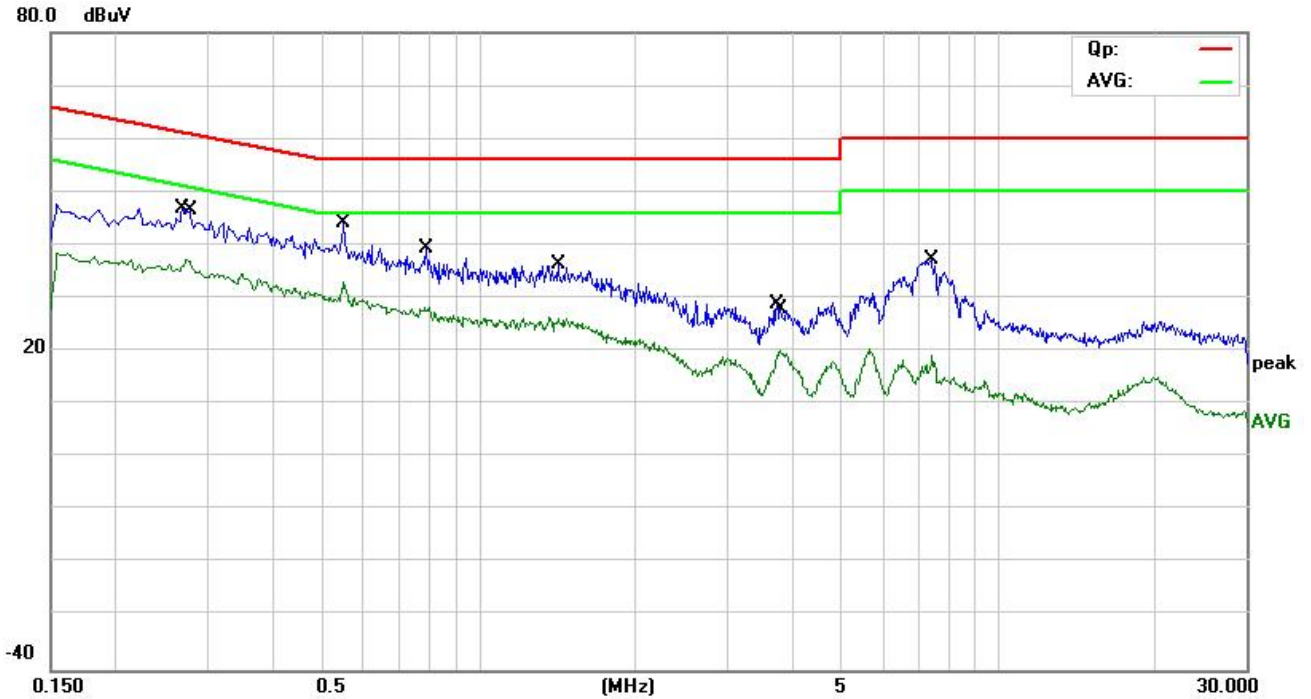

No.	Mk.	Freq. MHz	Reading Level dBuV	Correct Factor dB	Measure- ment dBuV	Limit dBuV	Over dB	Detector	Comment
1		0.2700	37.35	9.60	46.95	61.12	-14.17	QP	
2		0.2740	27.61	9.60	37.21	51.00	-13.79	AVG	
3	*	0.5500	34.56	9.59	44.15	56.00	-11.85	QP	
4		0.5500	23.49	9.59	33.08	46.00	-12.92	AVG	
5		0.7900	18.66	9.60	28.26	46.00	-17.74	AVG	
6		0.7940	29.74	9.60	39.34	56.00	-16.66	QP	
7		1.4220	26.63	9.60	36.23	56.00	-19.77	QP	
8		1.4220	16.40	9.60	26.00	46.00	-20.00	AVG	
9		3.7420	19.17	9.62	28.79	56.00	-27.21	QP	
10		3.8060	10.56	9.62	20.18	46.00	-25.82	AVG	
11		7.4340	27.72	9.66	37.38	60.00	-22.62	QP	
12		7.4580	9.48	9.66	19.14	50.00	-30.86	AVG	

*:Maximum data x:Over limit !:over margin

Power supply:

DC 5V by USB Port

Polarization

N

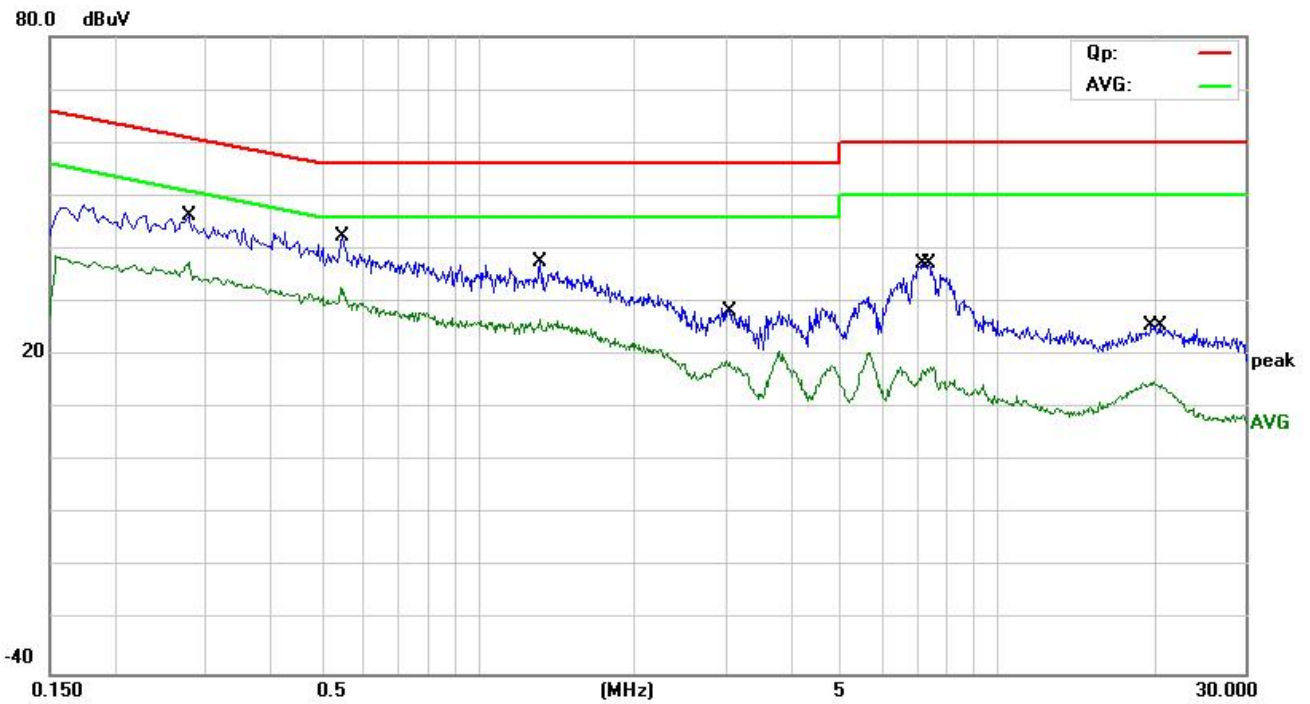

No.	Mk.	Freq. MHz	Reading Level dBuV	Correct Factor dB	Measure- ment dBuV	Limit dBuV	Over dB	Detector	Comment
1		0.2780	36.63	9.59	46.22	60.88	-14.66	QP	
2		0.2780	27.83	9.59	37.42	50.88	-13.46	AVG	
3	*	0.5460	23.02	9.59	32.61	46.00	-13.39	AVG	
4		0.5500	32.74	9.59	42.33	56.00	-13.67	QP	
5		1.3180	27.98	9.60	37.58	56.00	-18.42	QP	
6		1.3180	17.03	9.60	26.63	46.00	-19.37	AVG	
7		3.0620	18.75	9.61	28.36	56.00	-27.64	QP	
8		3.0620	8.66	9.61	18.27	46.00	-27.73	AVG	
9		7.1940	27.73	9.65	37.38	60.00	-22.62	QP	
10		7.4420	8.08	9.66	17.74	50.00	-32.26	AVG	
11		19.9500	5.27	9.73	15.00	50.00	-35.00	AVG	
12		20.5460	15.73	9.73	25.46	60.00	-34.54	QP	

*:Maximum data x:Over limit !:over margin

5.2. Radiated Spurious Emissions and Bandedge Emission

TEST CONFIGURATION

Frequency range 9 KHz – 30MHz

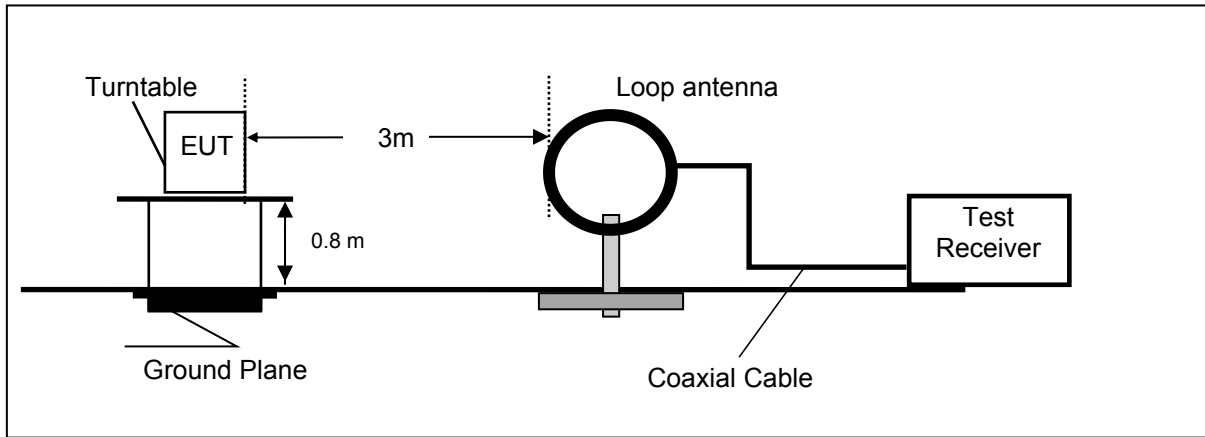

Frequency range 30MHz – 1000MHz

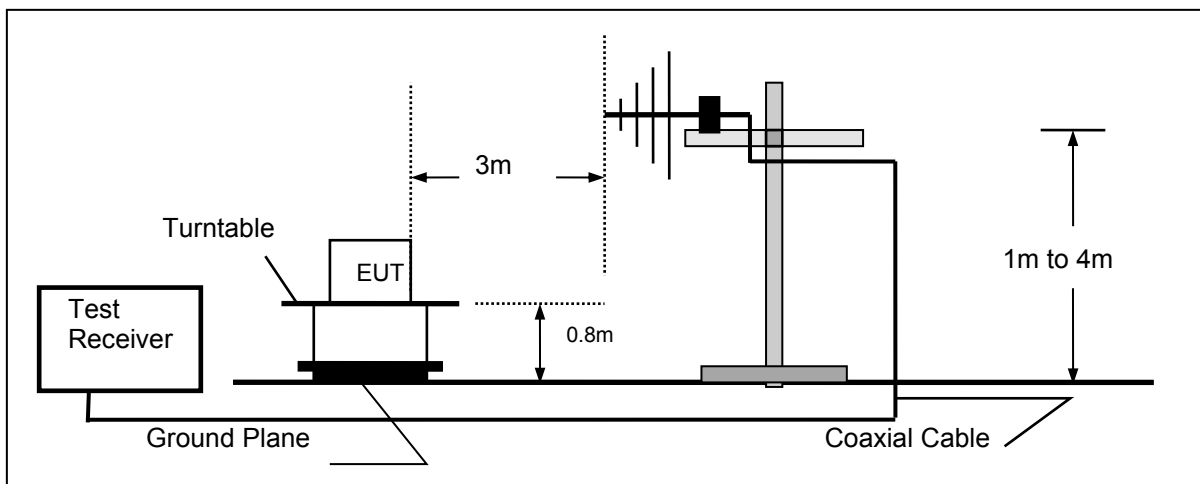

Frequency range above 1GHz-25GHz

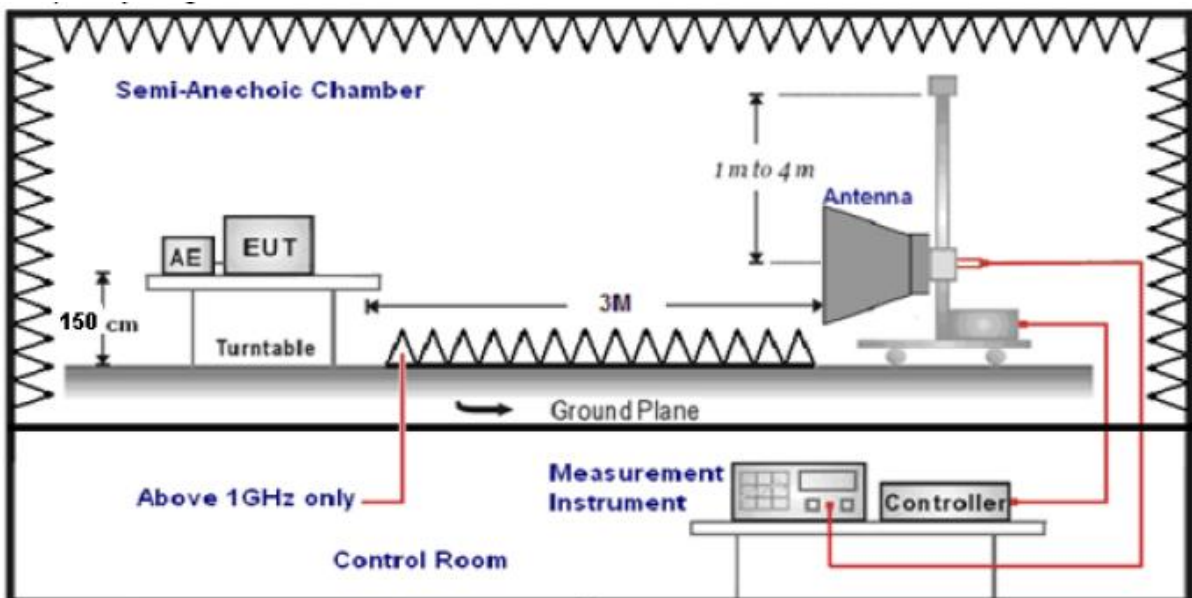

TEST PROCEDURE

1. The EUT was setup and tested according to ANSI C63.10:2013 requirements.
2. The EUT is placed on a turn table which is 0.1 meter above ground for below 1 GHz, and 0.1 m for above 1 GHz. The turn table is rotated 360 degrees to determine the position of the maximum emission level.
3. The EUT was set 3 meters from the receiving antenna, which was mounted on the top of a variable height antenna tower. For each suspected emission, the EUT was arranged to its worst case and then tune the Antenna tower (from 1 m to 4 m) and turntable (from 0 degree to 360 degrees) to find the maximum reading. A pre-amp and a high pass filter are used for the test in order to get better signal level to comply with the guidelines.
4. Set to the maximum power setting and enable the EUT transmit continuously.
5. Use the following spectrum analyzer settings
Span shall wide enough to fully capture the emission being measured;
(1)Below 1 GHz:
RBW=120 kHz, VBW=300 kHz, Sweep=auto, Detector function=peak, Trace=max hold;
If the emission level of the EUT measured by the peak detector is 3 dB lower than the applicable limit, the peak emission level will be reported. Otherwise, the emission measurement will be repeated using the quasi-peak detector and reported.
(2)From 1 GHz to 10th harmonic:
RBW=1MHz, VBW=3MHz Peak detector for Peak value.
RBW=1MHz, VBW=3MHz RMS detector for Average value.

RADIATION LIMIT

FCC CFR Title 47 Part 15 Subpart C Section 15.209

Frequency	Limit (dBuV/m @3m)	Value
30MHz~88MHz	40.00	Quasi-peak
88MHz~216MHz	43.50	Quasi-peak
216MHz~960MHz	46.00	Quasi-peak
960MHz~1GHz	54.00	Quasi-peak
Above 1GHz	54.00	Average
	74.00	Peak

Test Results

Radiated Spurious Emissions

For 9 kHz ~ 30 MHz

The EUT was pre-scanned the frequency band (9 kHz ~ 30 MHz), found the radiated level lower than the limit, so don't show on the report.

Note : Both the AT1200 and AT1600 versions have been tested, only the worst case(AT1600 versions) is recorded in this report.

For 30MHz-1GHz

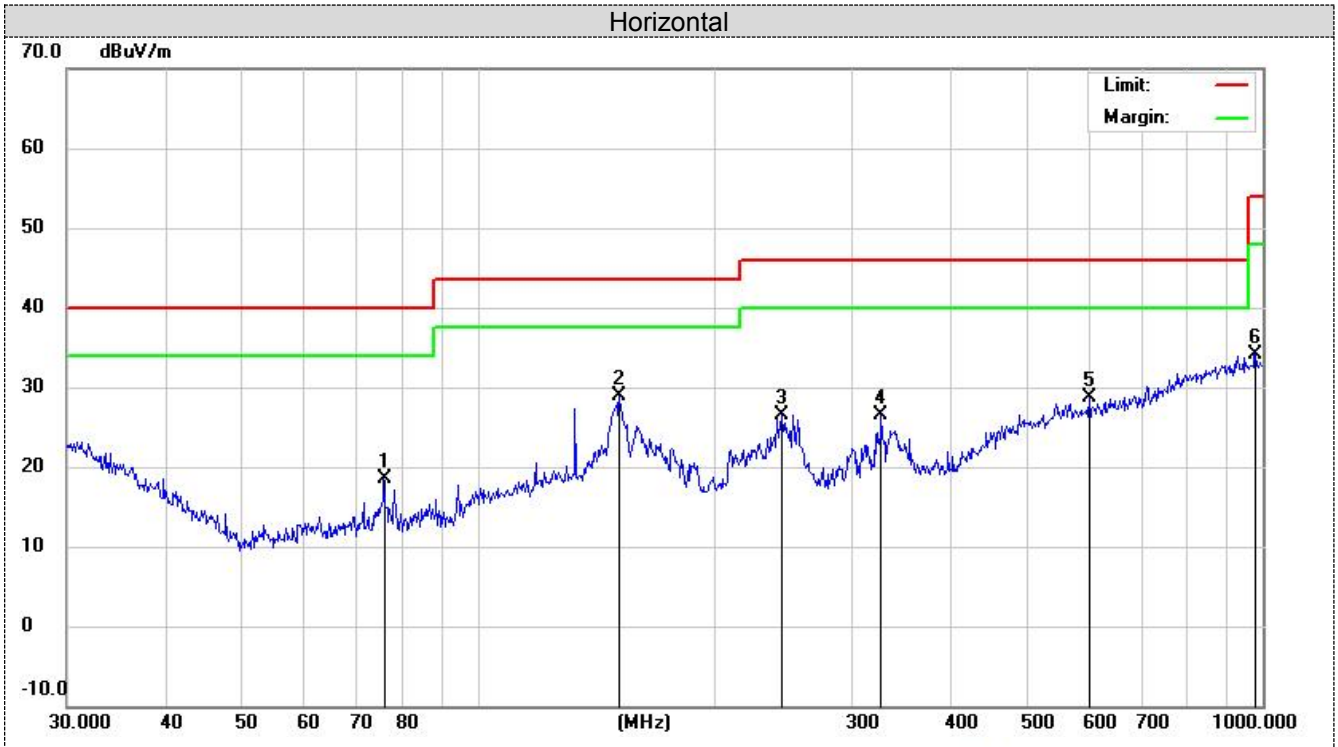

No.	Mk.	Freq. MHz	Reading Level dBuV	Correct Factor dB	Measure- ment dBuV/m	Limit dBuV/m	Over dB	Detector	Antenna Height cm	Table Degree	Comment
1		75.9773	8.74	9.78	18.52	40.00	-21.48	QP	200	20	
2	*	151.5972	11.17	17.64	28.81	43.50	-14.69	QP	200	70	
3		244.2321	12.47	13.96	26.43	46.00	-19.57	QP	200	120	
4		326.7395	10.42	16.01	26.43	46.00	-19.57	QP	200	230	
5		601.4265	4.91	23.82	28.73	46.00	-17.27	QP	200	300	
6		979.1804	4.40	29.79	34.19	54.00	-19.81	QP	200	330	

*:Maximum data x:Over limit !:over margin

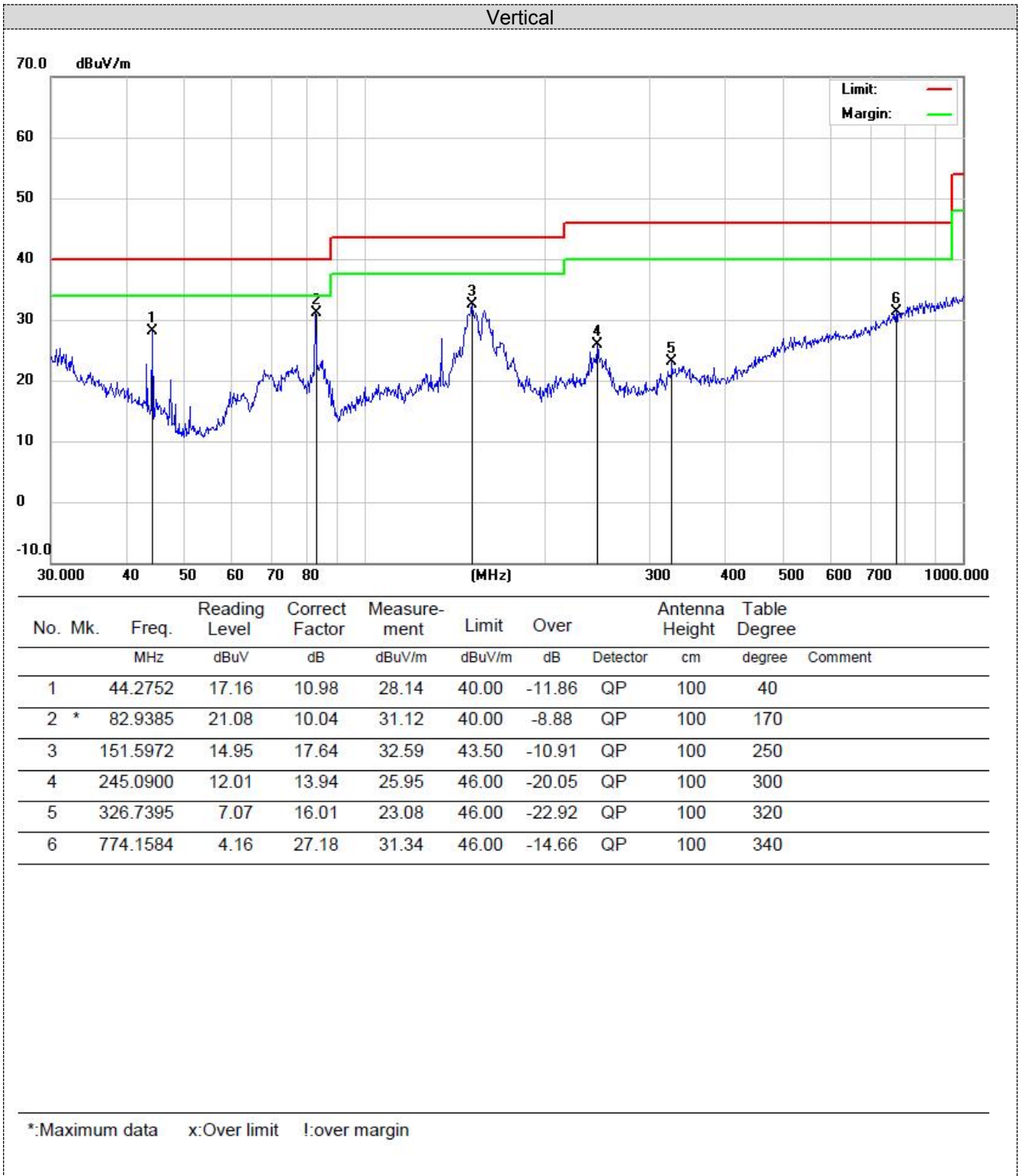

For Above 1 GHz

Frequency(MHz):			2457		Polarity:		HORIZONTAL		
Frequency (MHz)	Emission Level (dBuV/m)		Limit (dBuV/m)	Margin (dB)	Raw Value (dBuV)	Antenna Factor (dB/m)	Cable Factor (dB)	Pre-amplifier (dB)	Correction Factor (dB/m)
4914.00	55.26	PK	74	18.74	55.07	31.42	6.98	36.5	1.9
4914.00	42.06	AV	54	11.94	42.22	31.42	6.98	36.5	1.9
7371.00	51.77	PK	74	22.23	41.83	37.03	8.87	35.3	10.6
7371.00	40.59	AV	54	13.41	31.76	37.03	8.87	35.3	10.6

Frequency(MHz):			2457		Polarity:		VERTICAL		
Frequency (MHz)	Emission Level (dBuV/m)		Limit (dBuV/m)	Margin (dB)	Raw Value (dBuV)	Antenna Factor (dB/m)	Cable Factor (dB)	Pre-amplifier (dB)	Correction Factor (dB/m)
4914.00	53.69	PK	74	20.31	50.36	31.42	6.98	36.5	1.9
4914.00	44.21	AV	54	9.79	42.41	31.42	6.98	36.5	1.9
7371.00	52.18	PK	74	21.82	41.58	37.03	8.87	35.3	10.6
7371.00	41.02	AV	54	12.98	31.78	37.03	8.87	35.3	10.6

REMARKS:

1. Emission level (dBuV/m) =Raw Value (dBuV)+Correction Factor (dB/m)
2. Correction Factor (dB/m) = Antenna Factor (dB/m)+Cable Factor (dB)- Pre-amplifier
3. Margin value = Limit value- Emission level.
4. -- Mean the PK detector measured value is below average limit.
5. The other emission levels were very low against the limit.

Bandedge Emission

GFSK

Frequency(MHz):			2402		Polarity:		HORIZONTAL		
Frequency (MHz)	Emission Level (dBuV/m)		Limit (dBuV/m)	Margin (dB)	Raw Value (dBuV)	Antenna Factor (dB/m)	Cable Factor (dB)	Pre-amplifier (dB)	Correction Factor (dB/m)
2390.00	57.55	PK	74	16.45	62.96	27.49	3.32	36.22	-5.41
2390.00	42.1	AV	54	11.9	47.51	27.49	3.32	36.22	-5.41
Frequency(MHz):			2402		Polarity:		VERTICAL		
Frequency (MHz)	Emission Level (dBuV/m)		Limit (dBuV/m)	Margin (dB)	Raw Value (dBuV)	Antenna Factor (dB/m)	Cable Factor (dB)	Pre-amplifier (dB)	Correction Factor (dB/m)
2390.00	56.36	PK	74	17.64	61.77	27.49	3.32	36.22	-5.41
2390.00	39.54	AV	54	14.46	44.95	27.49	3.32	36.22	-5.41
Frequency(MHz):			2480		Polarity:		HORIZONTAL		
Frequency (MHz)	Emission Level (dBuV/m)		Limit (dBuV/m)	Margin (dB)	Raw Value (dBuV)	Antenna Factor (dB/m)	Cable Factor (dB)	Pre-amplifier (dB)	Correction Factor (dB/m)
2483.50	56.39	PK	74	17.61	61.9	27.45	3.38	36.34	-5.51
2483.50	41.33	AV	54	12.67	46.84	27.45	3.38	36.34	-5.51
Frequency(MHz):			2480		Polarity:		VERTICAL		
Frequency (MHz)	Emission Level (dBuV/m)		Limit (dBuV/m)	Margin (dB)	Raw Value (dBuV)	Antenna Factor (dB/m)	Cable Factor (dB)	Pre-amplifier (dB)	Correction Factor (dB/m)
2483.50	58.41	PK	74	15.59	63.92	27.45	3.38	36.34	-5.51
2483.50	40.8	AV	54	13.2	46.31	27.45	3.38	36.34	-5.51

5.3. 20dB Bandwidth

TEST CONFIGURATION



TEST PROCEDURE

- 1: The transmitter output was connected to the spectrum analyzer through an attenuator, the path loss was compensated to the results for each measurement.
- 2: Set to the maximum power setting and enable the EUT transmit continuously.
- 3: Use the following spectrum analyzer settings:
Span = approximately 2 to 3 times the 20 dB bandwidth, centered on a test channel RBW \geq 1% of the 20 dB bandwidth, VBW \geq RBW
Sweep = auto, Detector function = peak, Trace = max hold
- 4: Measure and record the results in the test report.

TEST RESULTS

Modulation	Channel Frequency (MHz)	99% OBW (KHz)	20dB bandwidth (KHz)	Result
GFSK	2457	1041.4	1268	Pass

Test plot as follows:
99%

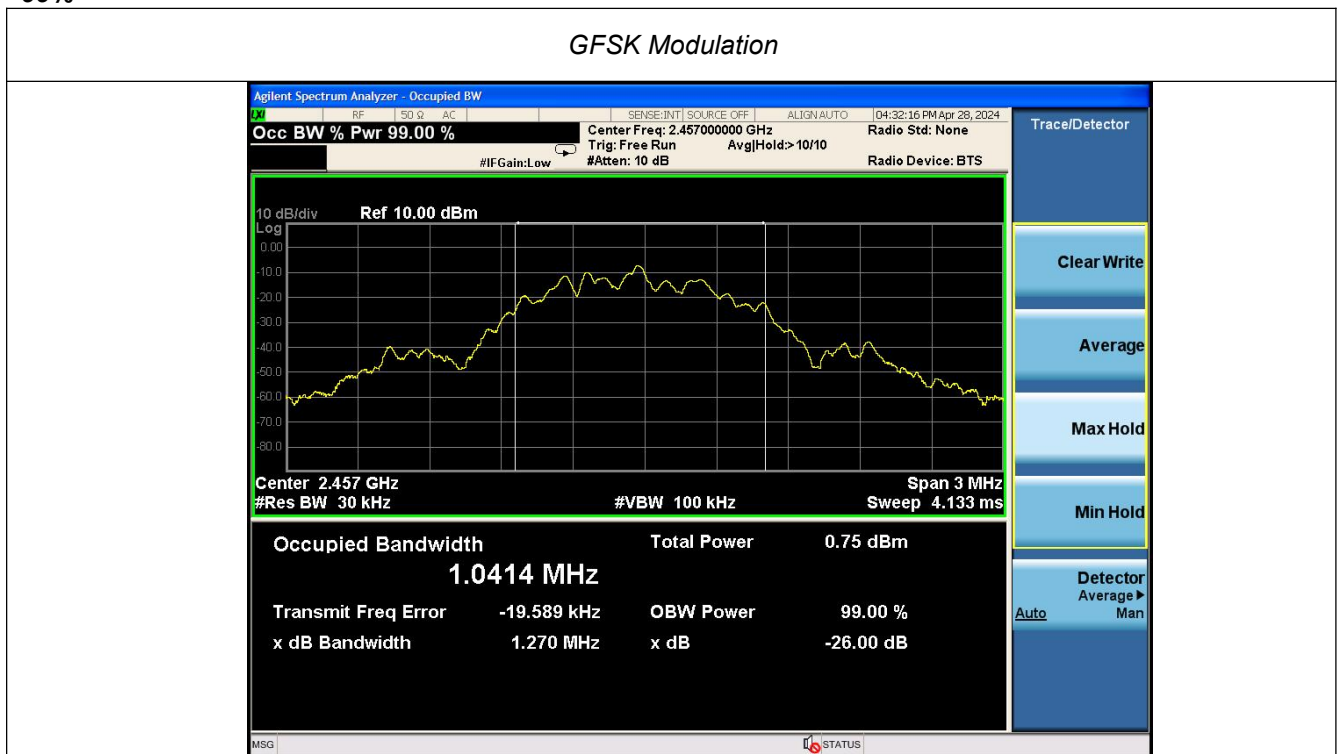

20dB:

GFSK Modulation



5.4. Radiated field strength of the fundamental signal

Limit

Fundamental frequency	Field strength of fundamental (millivolts/meter/ AVG)	Field strength of harmonics (microvolts/meter/ AVG)
902-928 MHz	50 (94dBuV/m @3m)	500 (54dBuV/m @3m)
2400-2483.5 MHz	50 (94dBuV/m @3m)	500 (54dBuV/m @3m)
5725-5875 MHz	50 (94dBuV/m @3m)	500 (54dBuV/m @3m)
24.0-24.25 GHz	250 (108dBuV/m @3m)	2500 (68dBuV/m @3m)

Frequencies above 1000 MHz, the field strength limits are based on average limits

Test Configuration

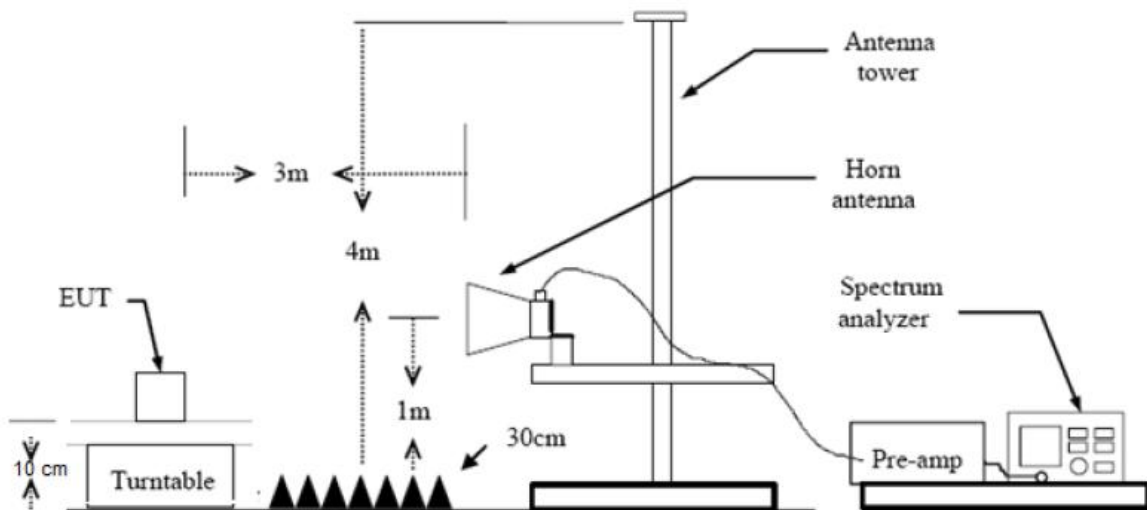

TEST PROCEDURE

1. The EUT was setup and tested according to ANSI C63.10:2013 requirements.
2. The EUT is placed on a turn table which is 0.1 meter above ground. The turn table is rotated 360 degrees to determine the position of the maximum emission level.
3. The EUT was positioned such that the distance from antenna to the EUT was 3 meters.
4. The antenna is scanned from 1 meter to 4 meters to find out the maximum emission level. This is repeated for both horizontal and vertical polarization of the antenna. In order to find the maximum emission, all of the interface cables were manipulated according to ANSI C63.10:2013 on radiated measurement.
5. The receiver set as follow: RBW=1MHz, VBW=3MHz Peak detector for Peak value.

TEST RESULTS

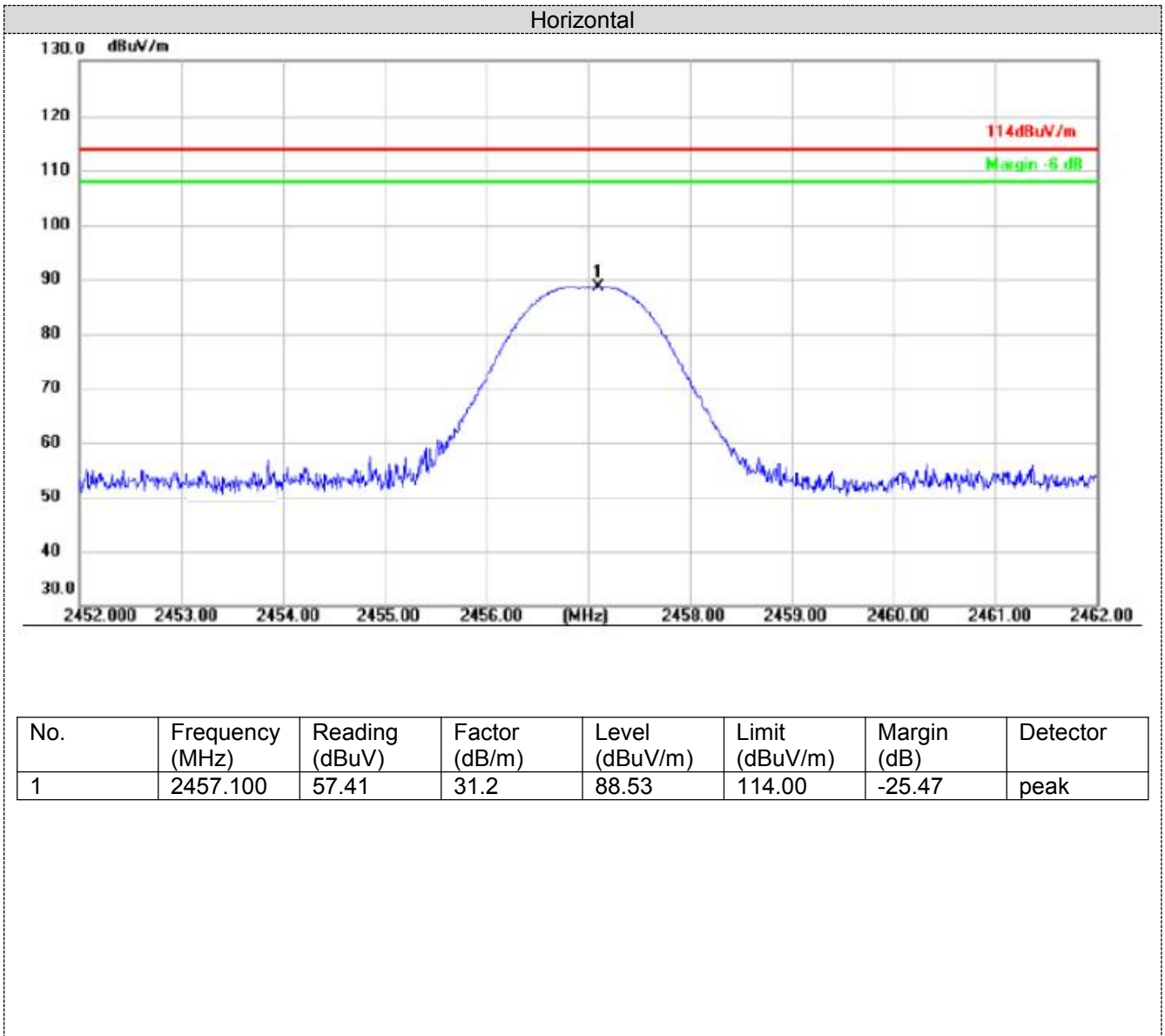

Vertical

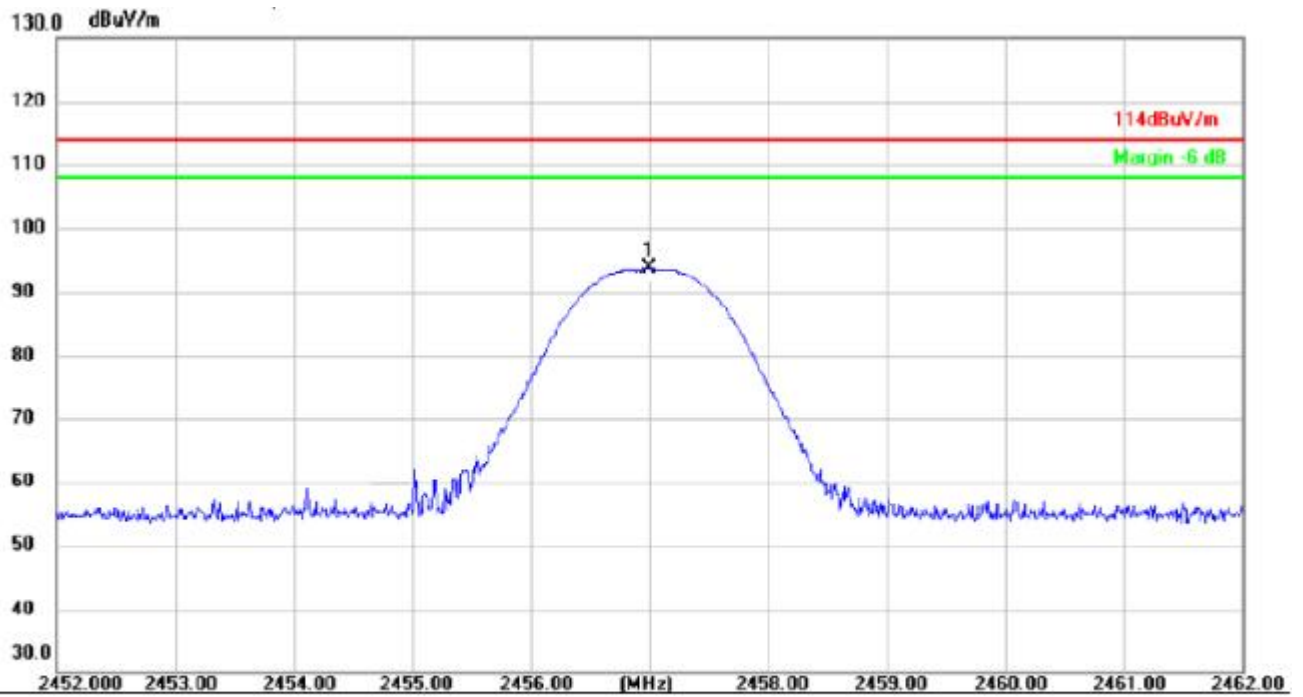

No.	Frequency (MHz)	Reading (dBuV)	Factor (dB/m)	Level (dBuV/m)	Limit (dBuV/m)	Margin (dB)	Detector
1	2457.100	62.09	31.2	93.29	114.00	-20.71	peak

5.5. Antenna Requirement

Standard Applicable

For intentional device, according to FCC 47 CFR Section 15.203, an intentional radiator shall be designed to ensure that no antenna other than that furnished by the responsible party shall be used with the device.

Refer to statement below for compliance

The manufacturer may design the unit so that the user can replace a broken antenna, but the use of a standard antenna jack or electrical connector is prohibited. Further, this requirement does not apply to intentional radiators that must be professionally installed.

Antenna Connected Construction

The directional gains of antenna used for transmitting is 0dBi, and the antenna is a loop antenna connect to PCB board and no consideration of replacement. Please see EUT photo for details.

Results: Compliance.

6. Test Setup Photos of the EUT

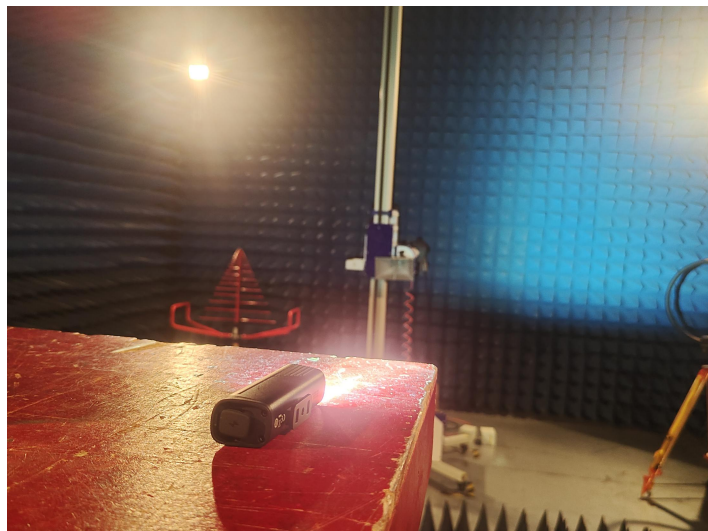
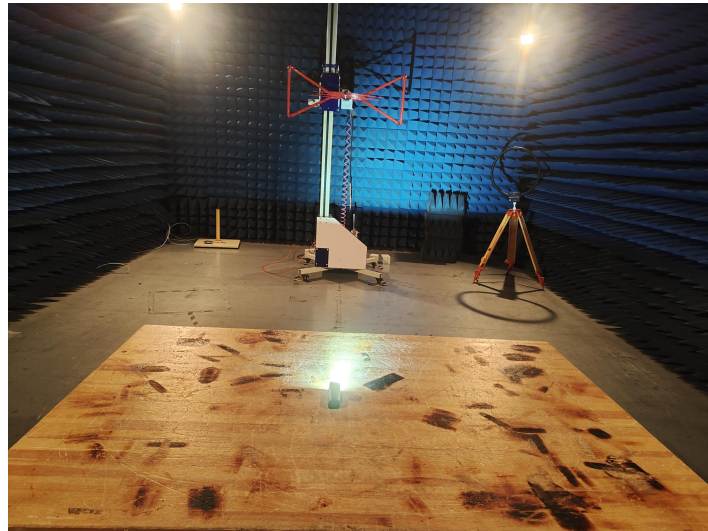

7. External and Internal Photos of the EUT

See related photo report.

.....**End of Report**.....