

GSM

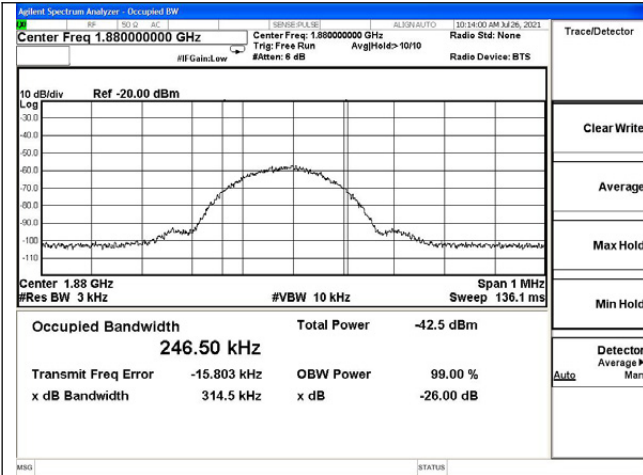

PCS band UL input

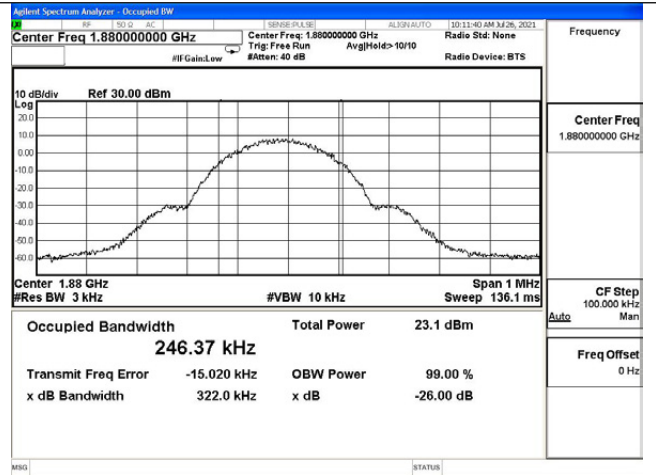

PCS band UL output

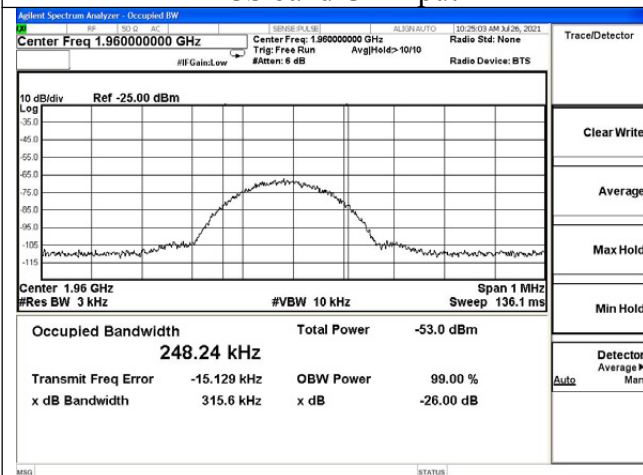

PCS band DL input



PCS band DL output

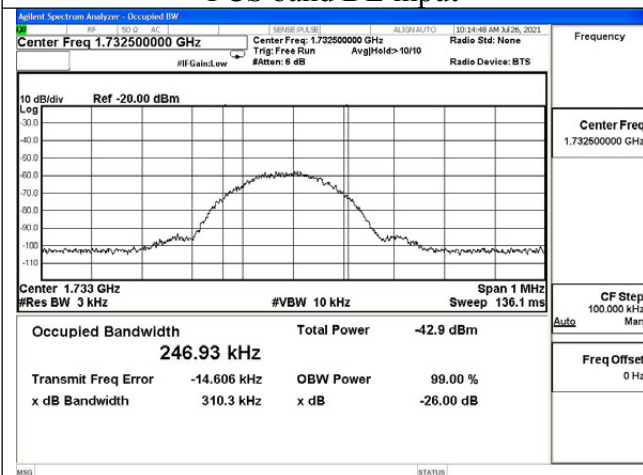

AWS band UL input

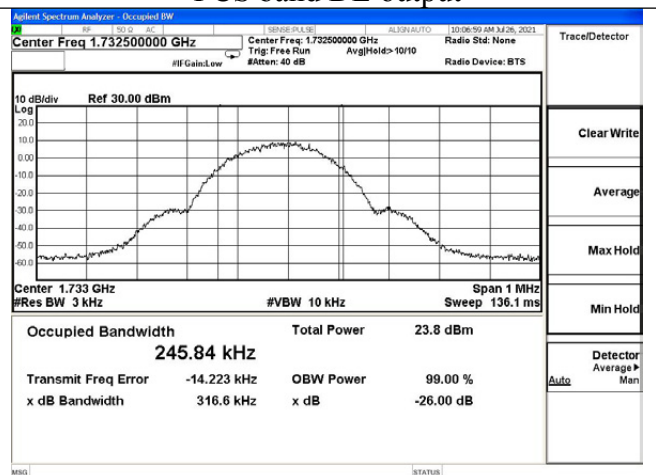

AWS band UL output

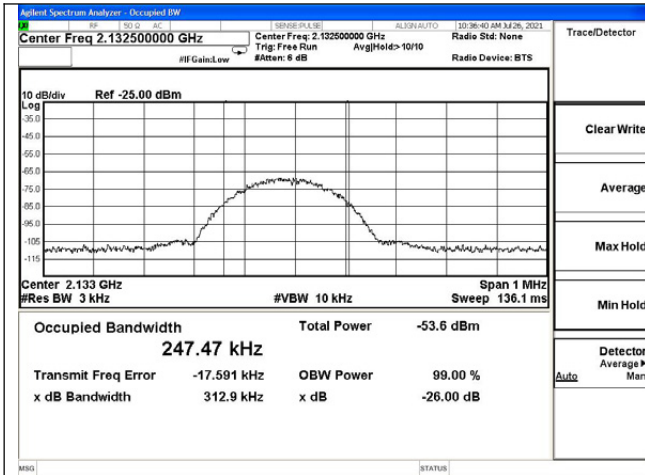

AWS band DL input

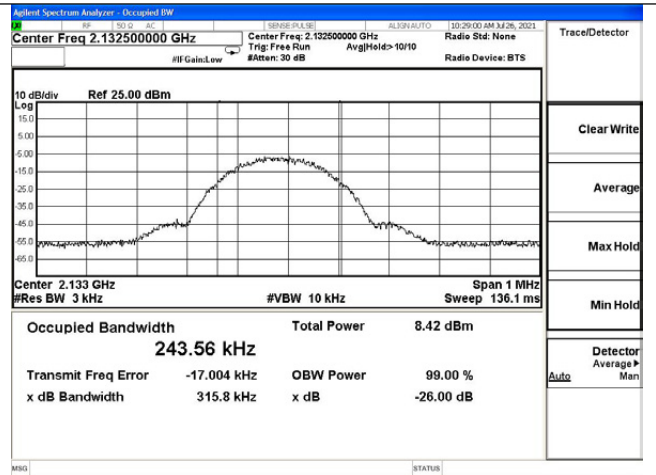

AWS band DL output

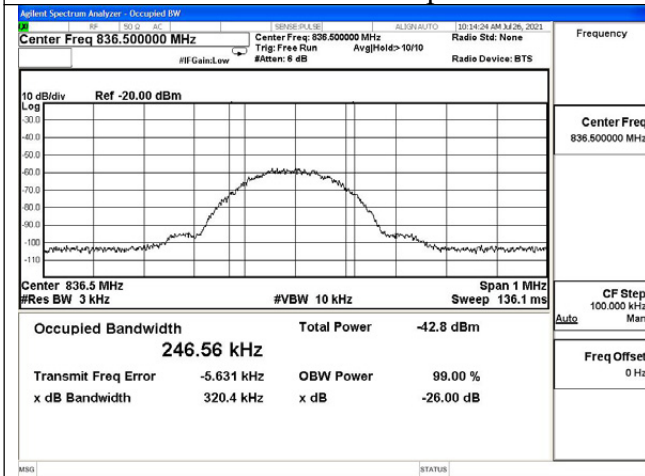

Cellular band UL input

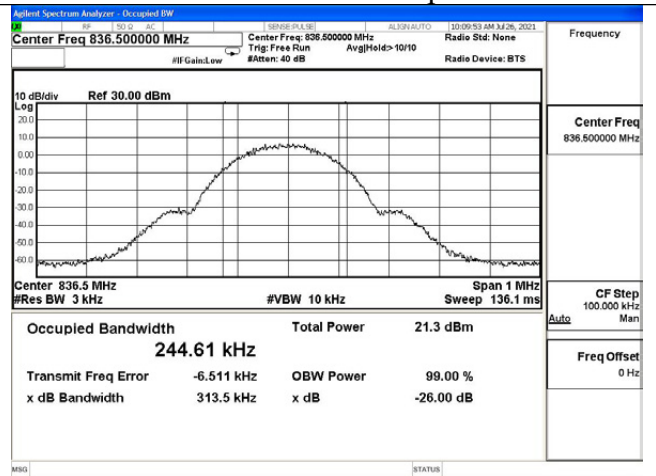

Cellular band UL output

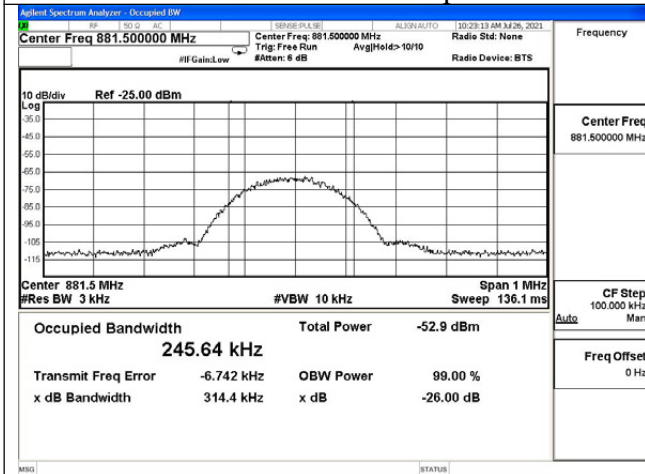

Cellular band DL input



Cellular band DL output

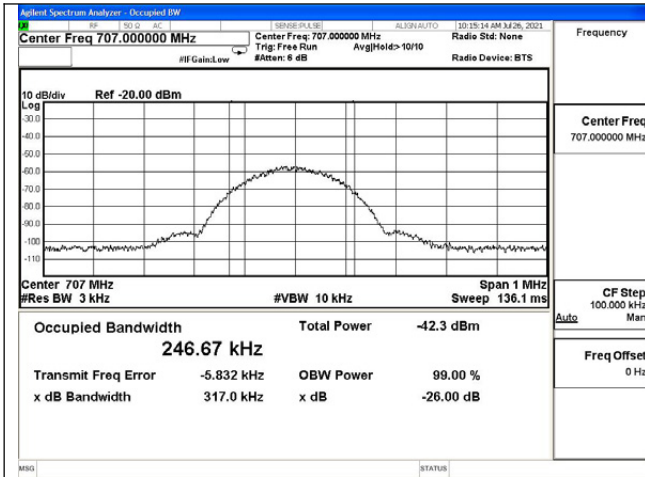

Lower 700MHz band UL input

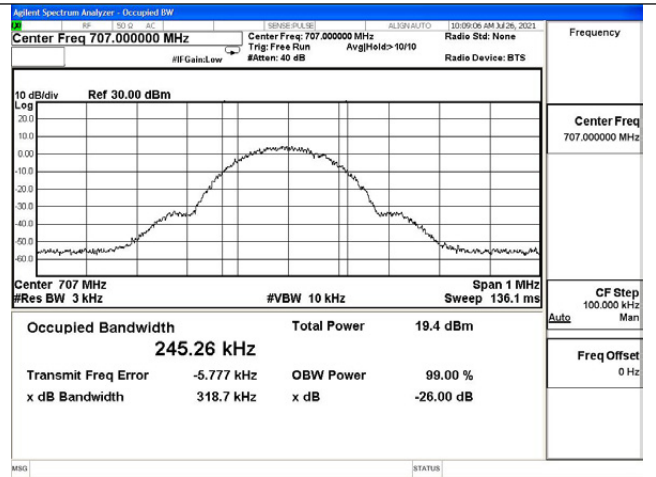

Lower 700MHz UL output

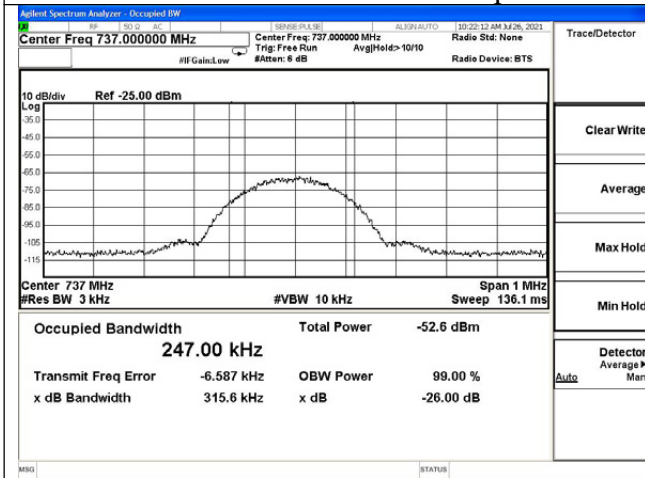

Lower 700MHz band DL input

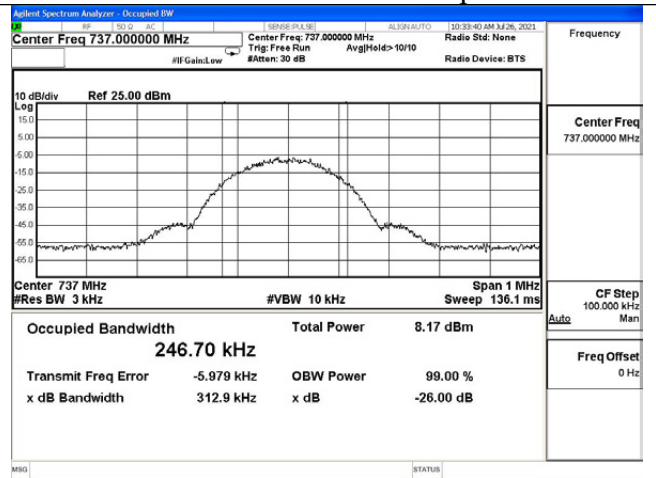

Lower 700MHz DL output

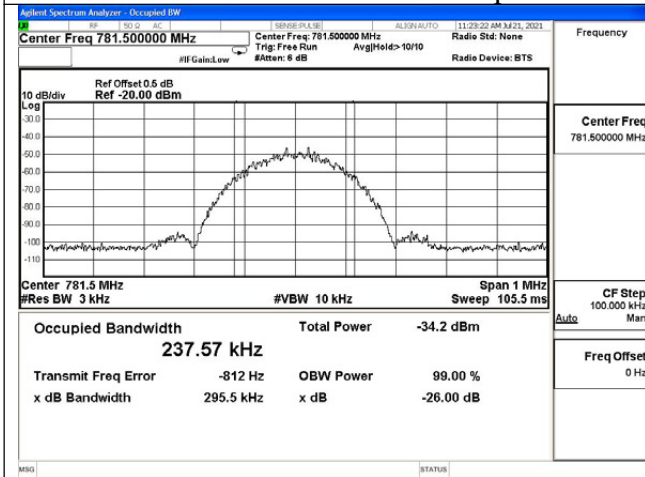

Upper 700MHz band UL input

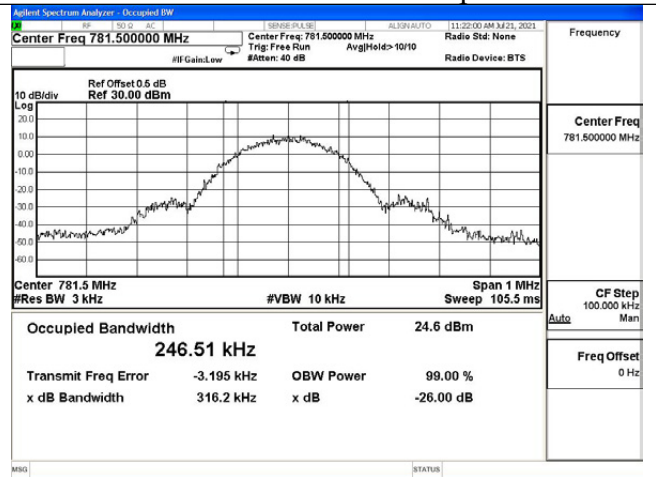

Upper 700MHz UL output

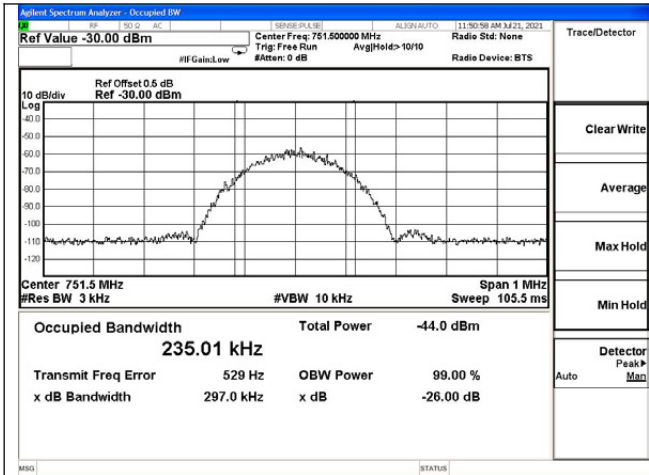

Upper 700MHz band DL input

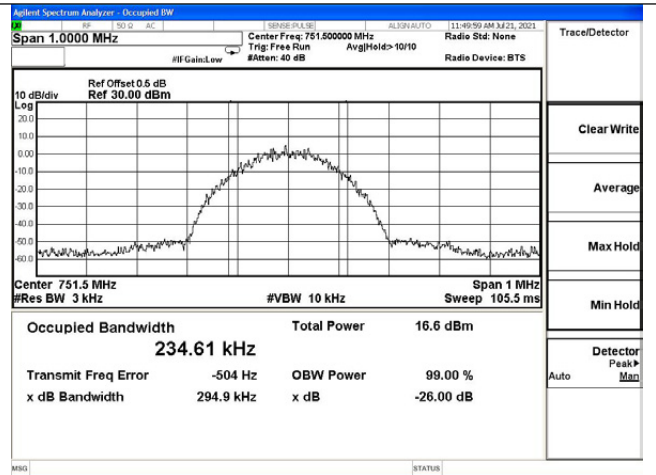

Upper 700MHz DL output

CDMA

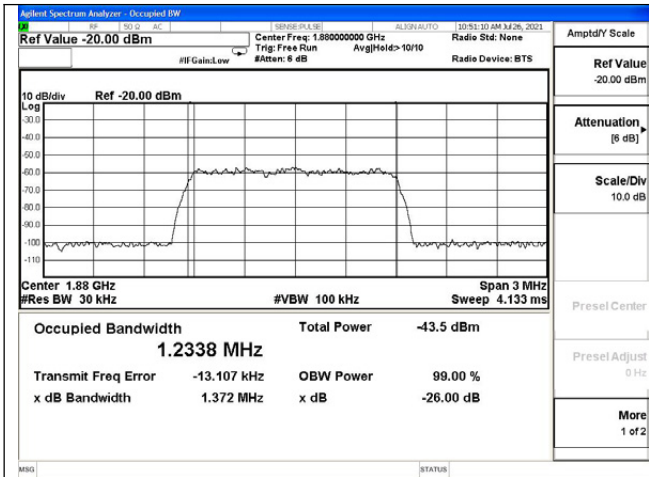

PCS band UL input

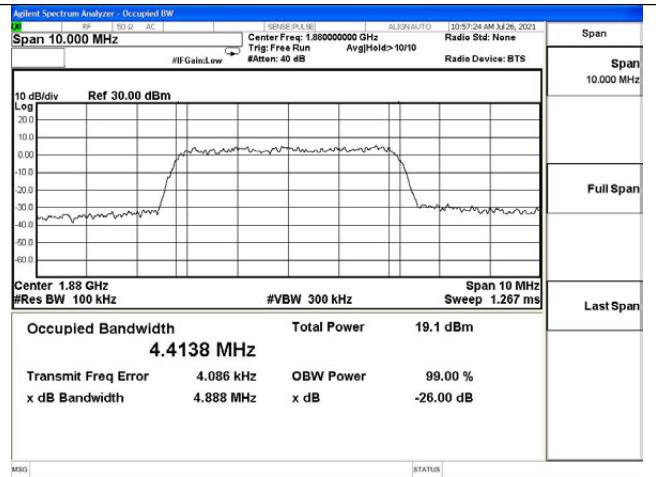

PCS band UL output

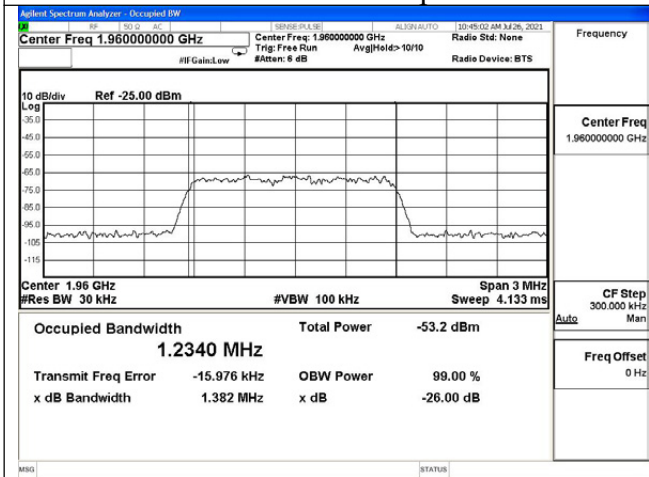

PCS band DL input

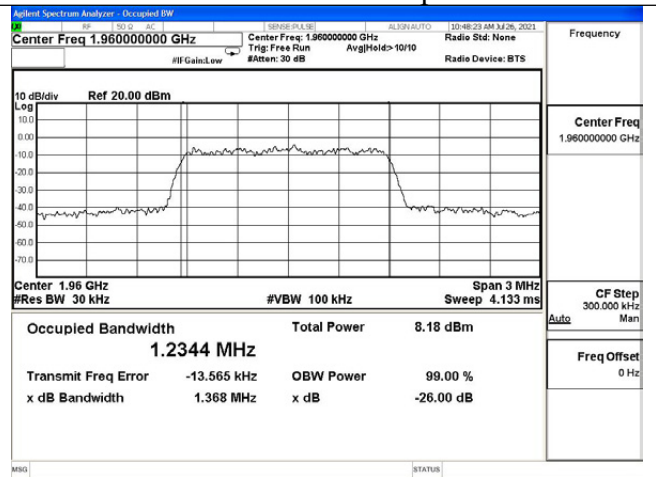

PCS band DL output

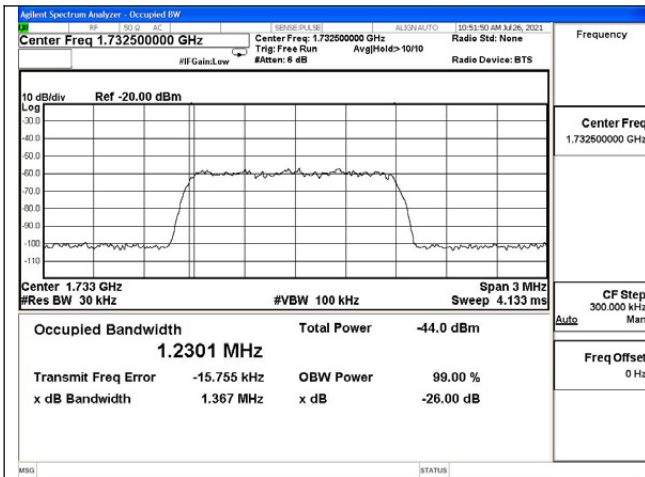

AWS band UL input

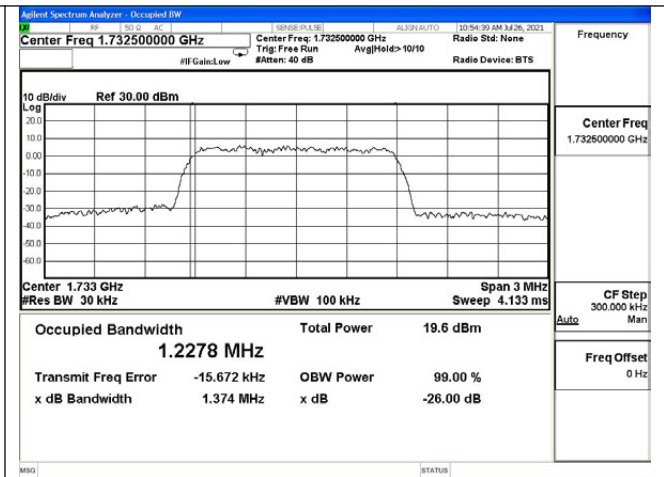

AWS band UL output

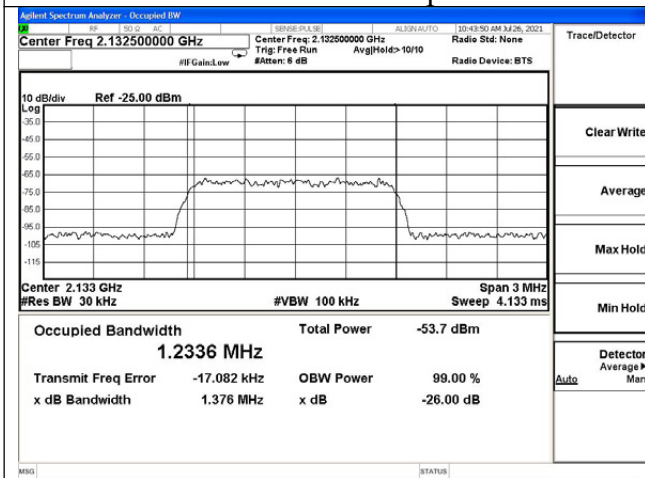

AWS band DL input

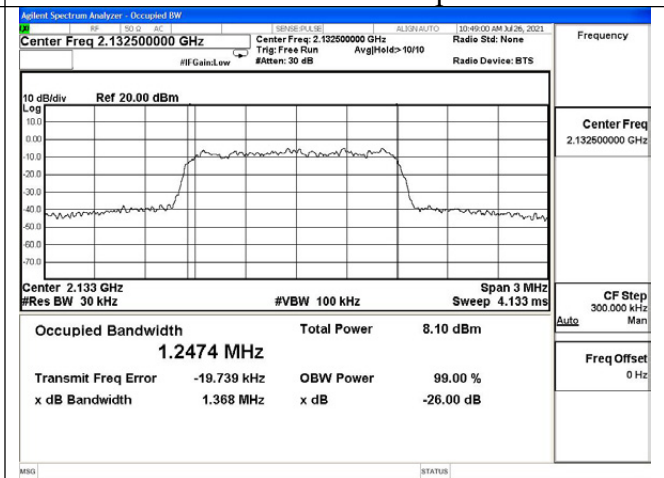

AWS band DL output

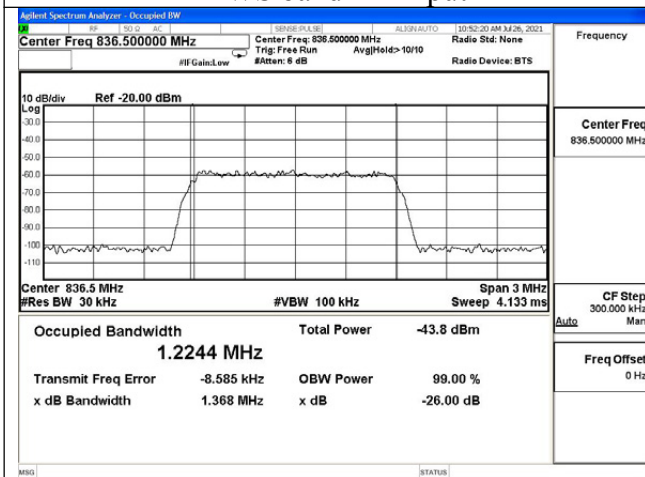

Cellular band UL input

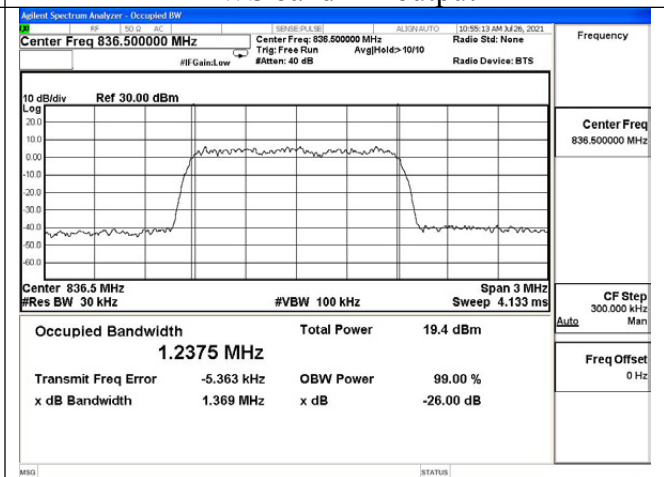

Cellular band UL output

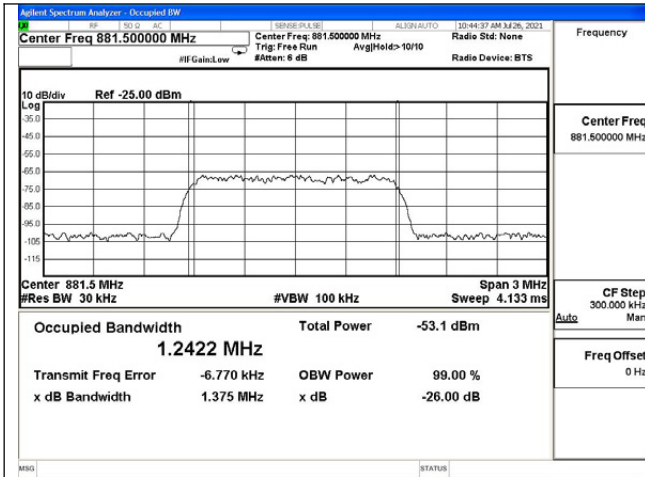

Cellular band DL input

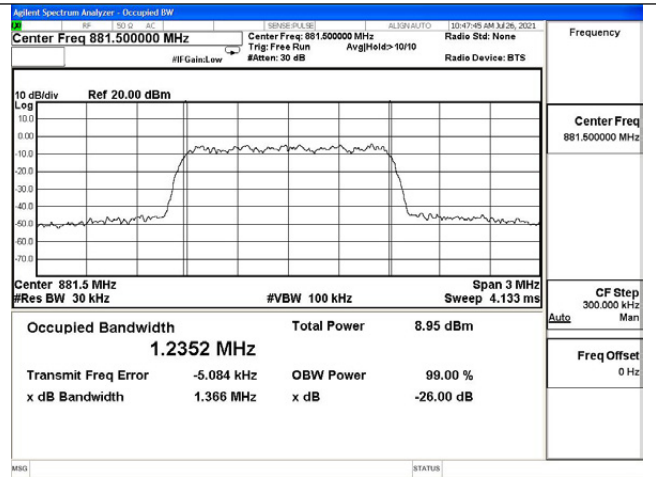

Cellular band DL output

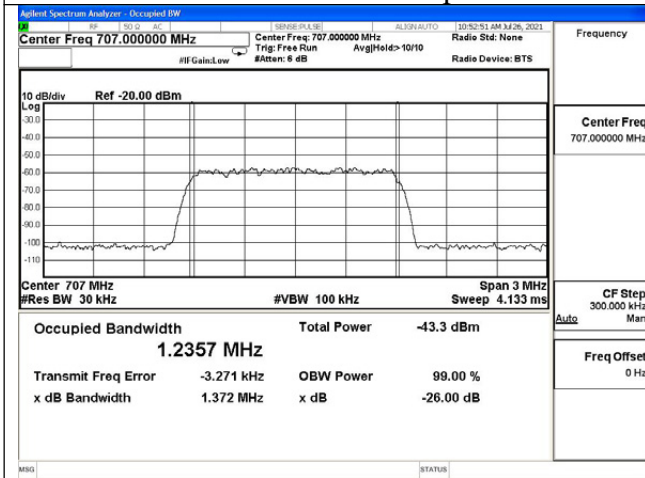

Lower 700MHz band UL input

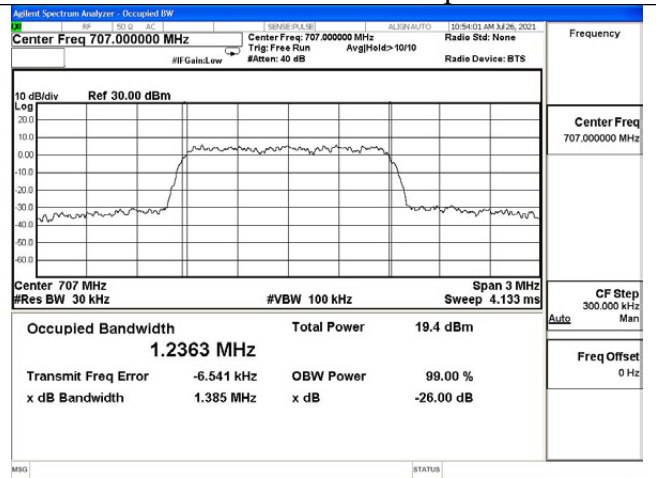

Lower 700MHz UL output

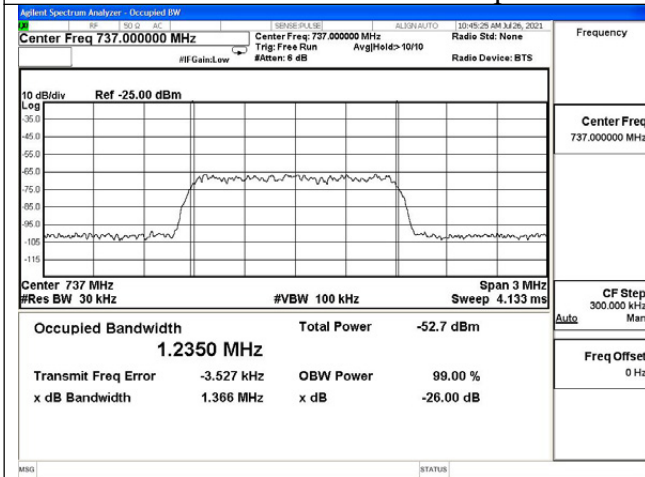

Lower 700MHz band DL input

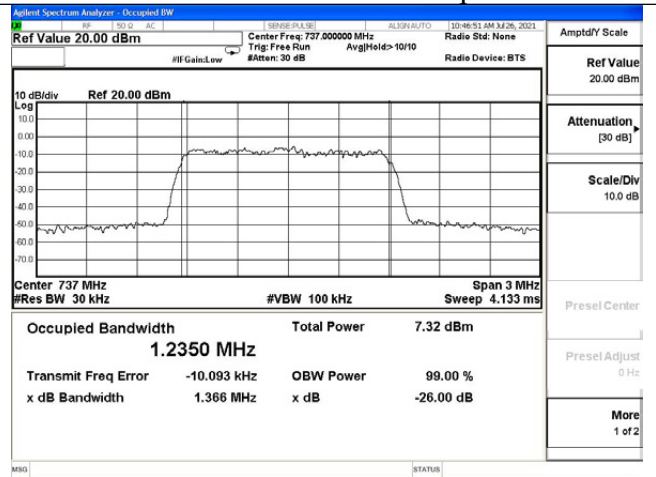

Lower 700MHz DL output

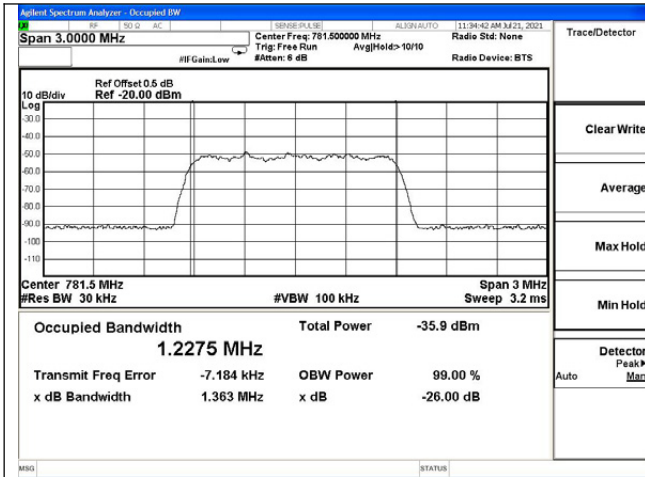

Upper 700MHz band UL input

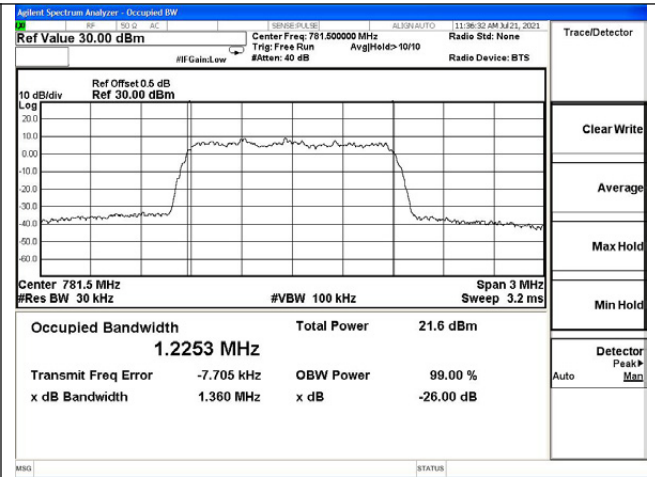

Upper 700MHz UL output

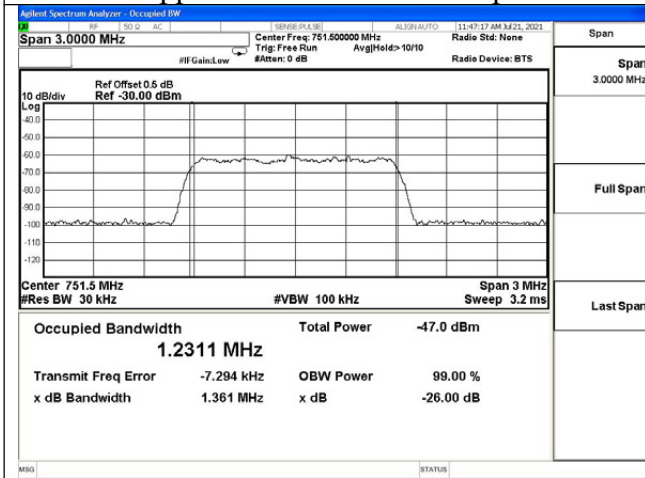

Upper 700MHz band DL input

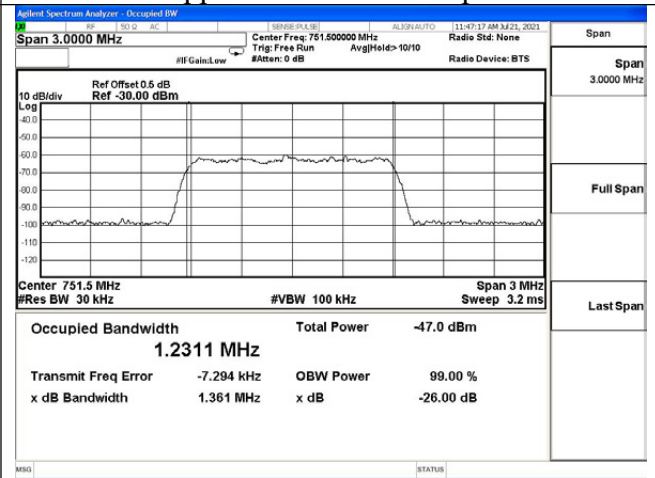

Upper 700MHz DL output

AWGN

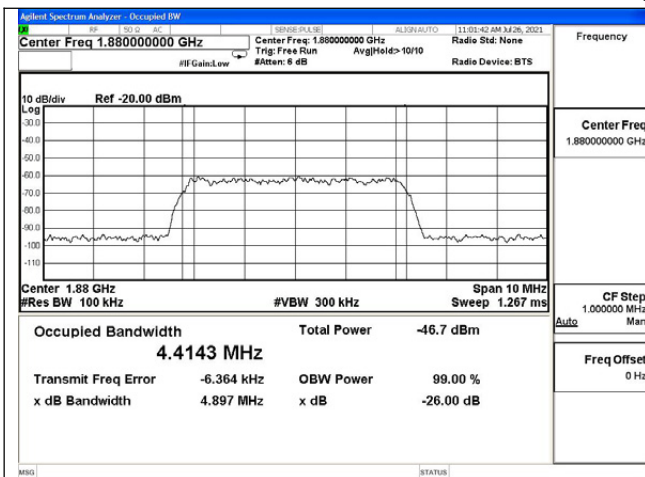

PCS band UL input

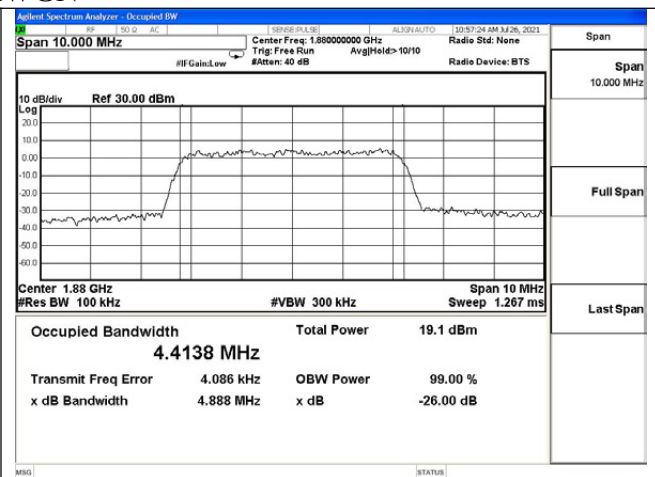

PCS band UL output

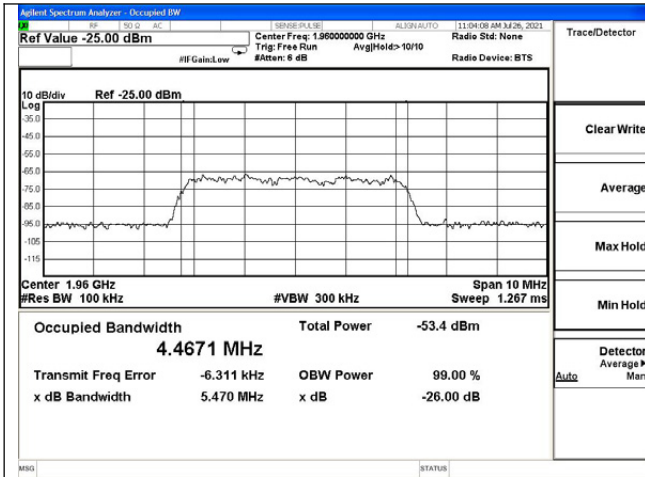

PCS band DL input

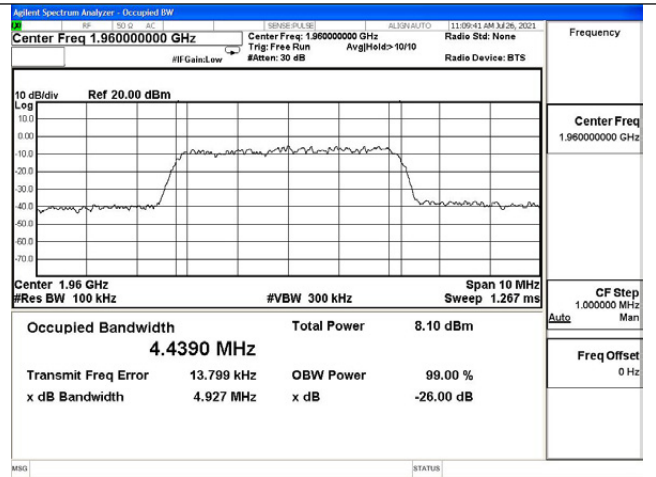

PCS band DL output

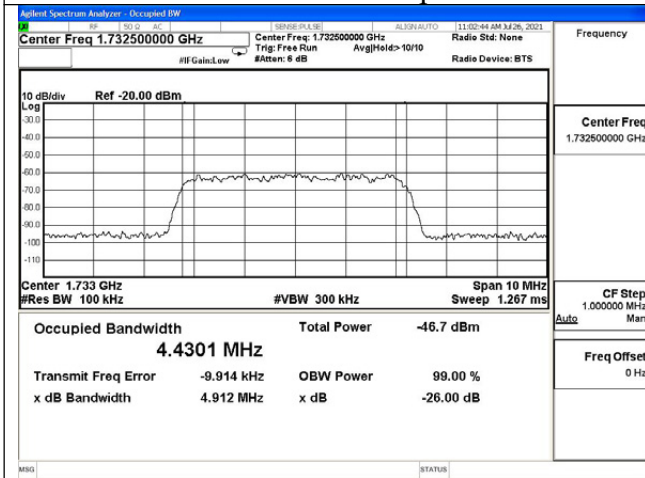

AWS band UL input

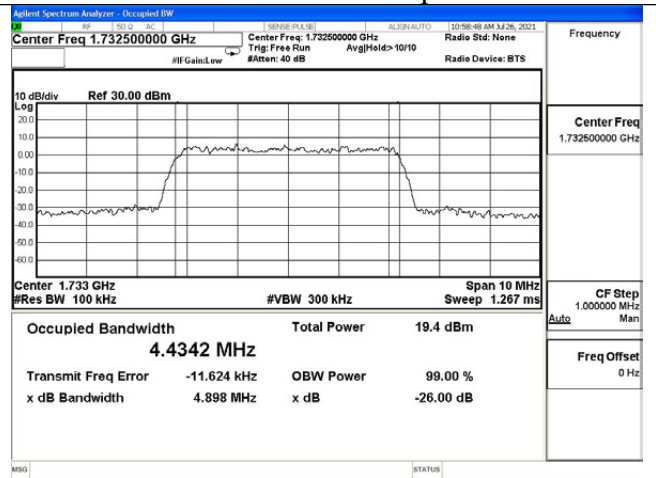

AWS band UL output

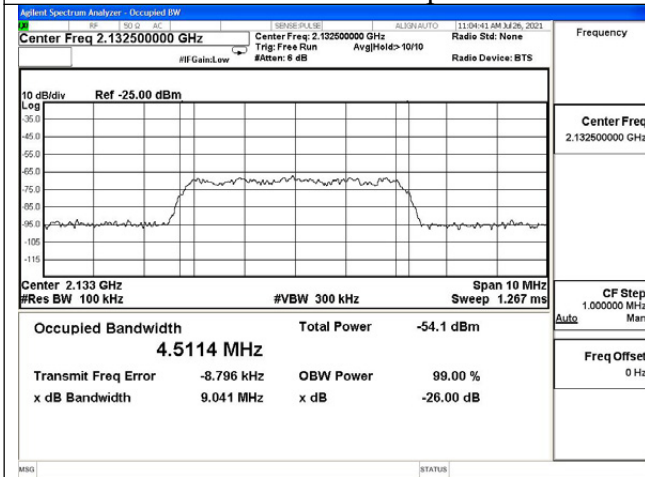

AWS band DL input

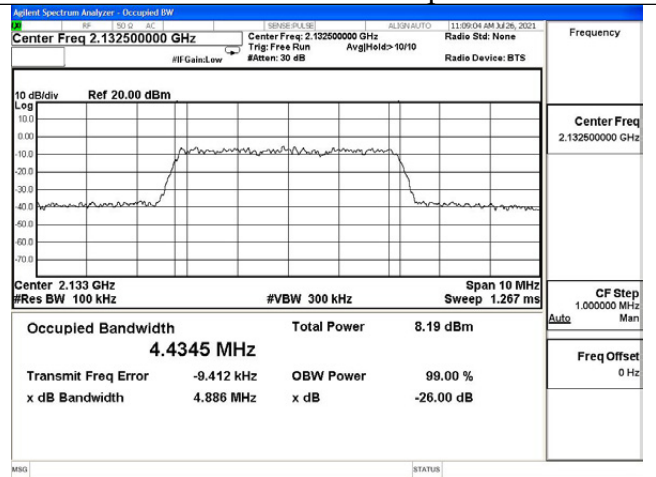

AWS band DL output

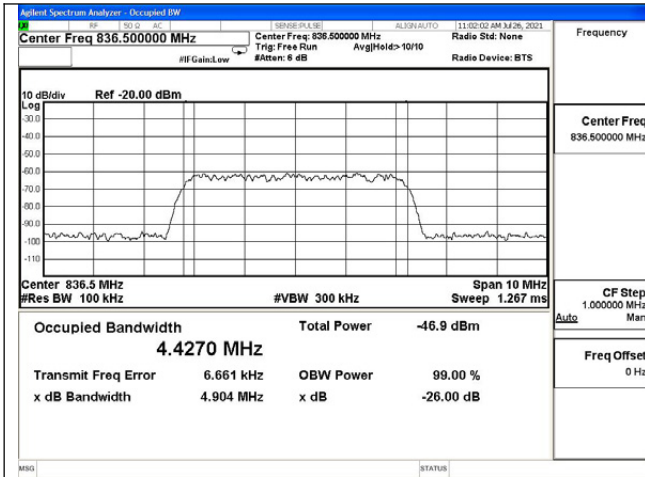

Cellular band UL input

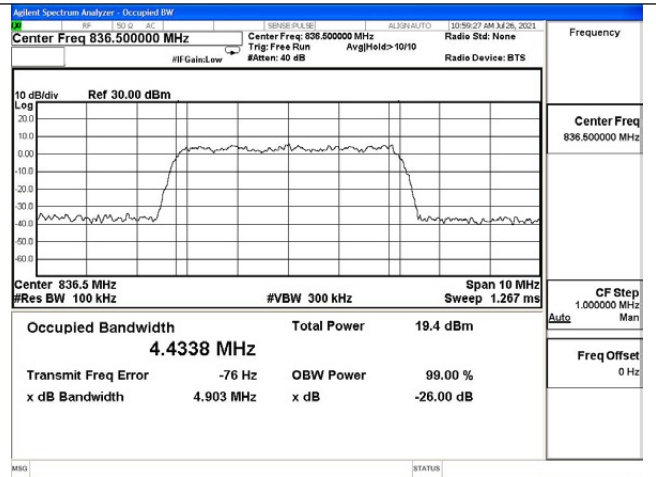

Cellular band UL output

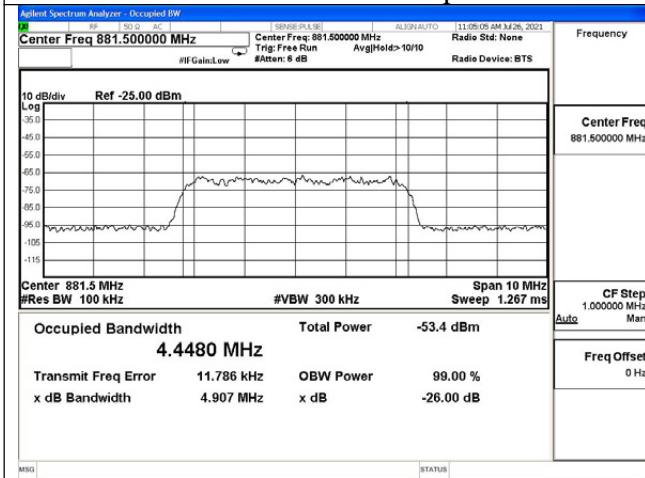

Cellular band DL input

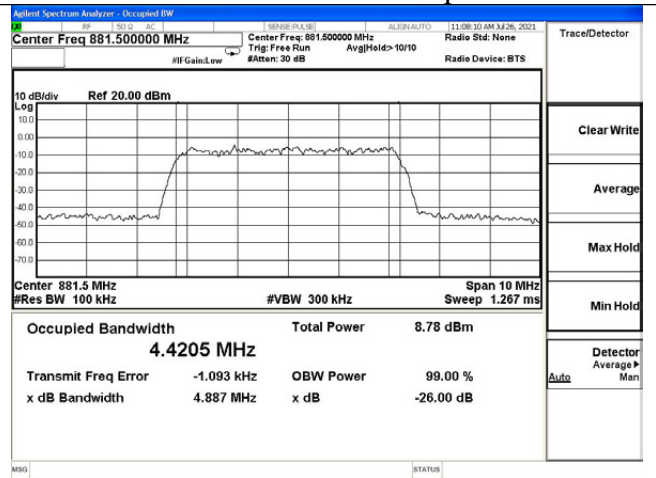

Cellular band DL output

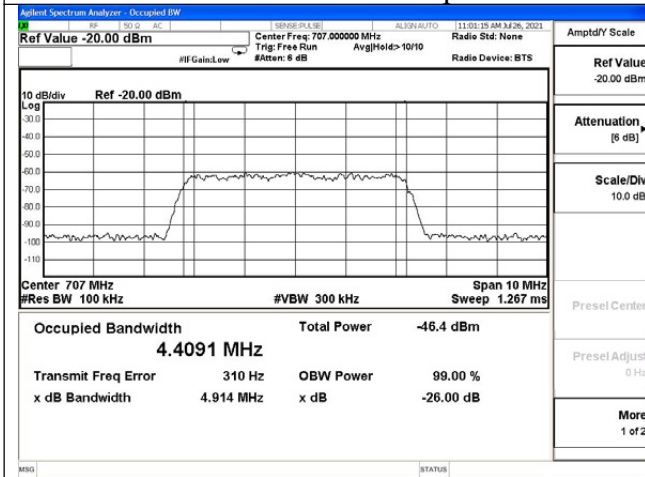

Lower 700MHz band UL input

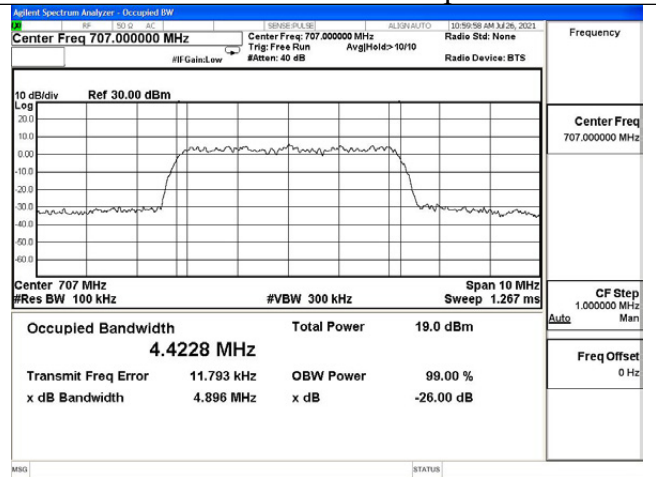

Lower 700MHz UL output

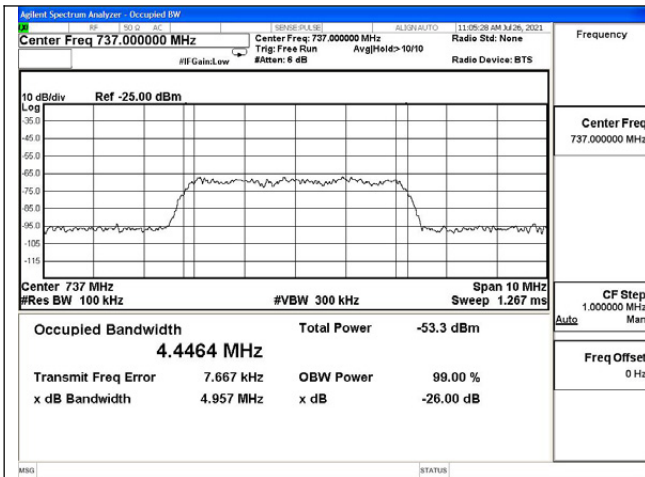

Lower 700MHz band DL input

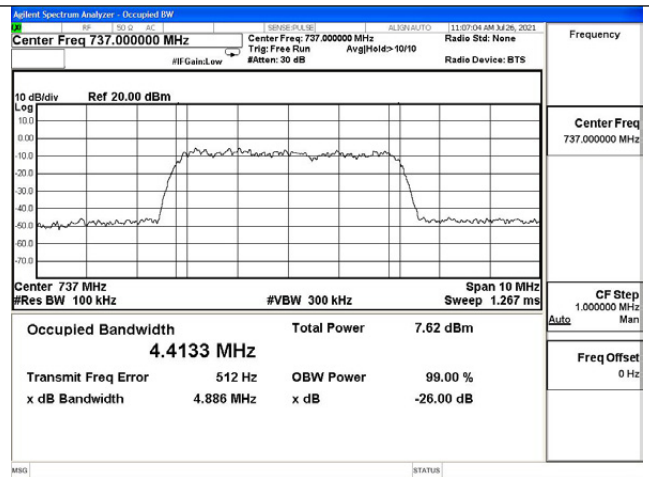

Lower 700MHz DL output

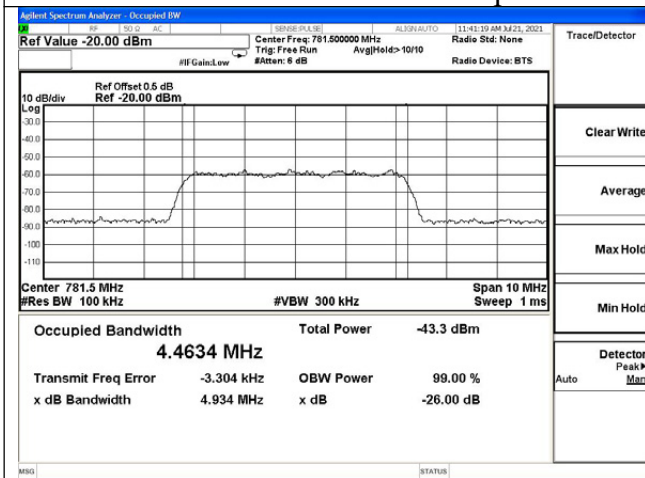

Upper 700MHz band UL input

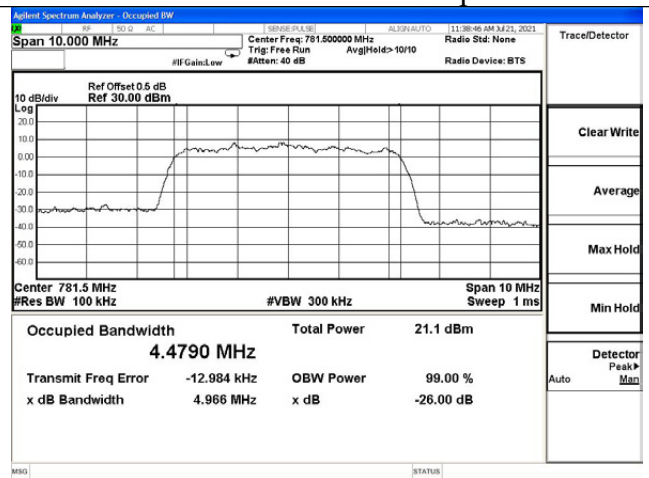

Upper 700MHz UL output

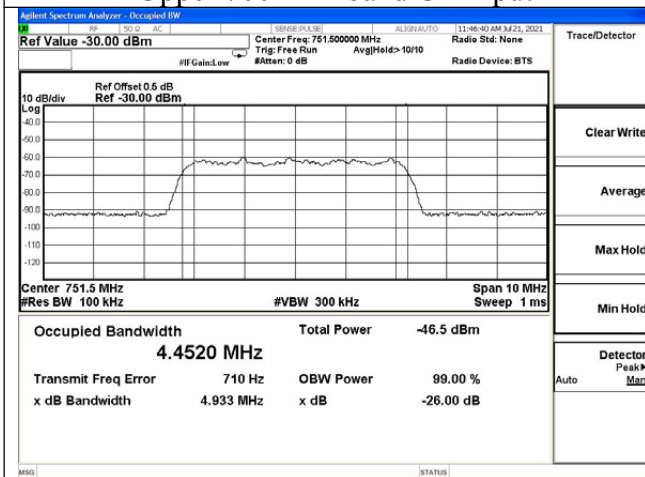

Upper 700MHz band DL input

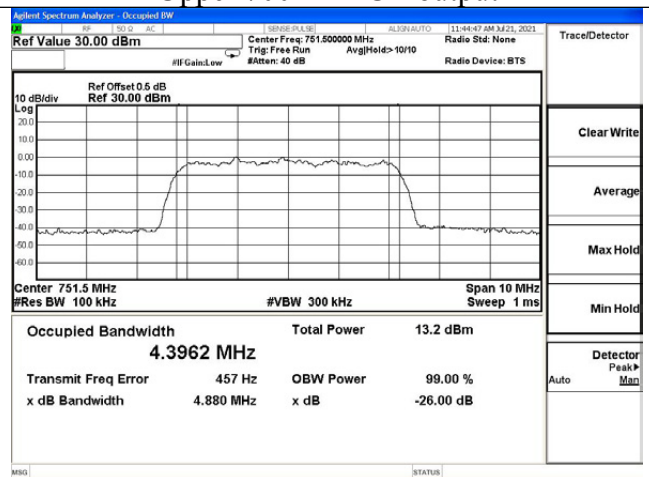

Upper 700MHz DL output

6.11 Oscillation Detection and Mitigation

Applicable Standard

According to §20.21(e)(8)(ii)(A) Anti-Oscillation.

Use of two EUTs is permitted for this measurement, which can greatly reduce the test time required. One EUT shall operate in a normal mode, and the second EUT shall operate in a test mode that is capable of disabling the uplink inactivity function and/or allows a reduction to 5 seconds of the time between restarts.

The procedures in 7.11.3 and 7.11.4 do not apply for devices that operate only as direct-connection mobile boosters having gain of less than or equal to 15 dB.

Test Procedure

Oscillation restart tests

a) Connect the normal-operating mode EUT to the test equipment as shown in Figure 7 beginning with the spectrum analyzer on the uplink output (donor) port. Confirm that the RF coupled path is connected to the spectrum analyzer.

NOTE—The band-pass filter shall provide sufficient out-of-band rejection to prevent oscillations from occurring in bands not under test.

b) Spectrum analyzer settings:

- 1) Center frequency at the center of the band under test
- 2) Span equal or slightly exceeding the width of the band under test
- 3) Continuous sweep, max-hold
- 4) $RBW \geq 1$ MHz, $VBW > 3$ RBW

c) Decrease the variable attenuator until the spectrum analyzer displays a signal within the band under test. Using a marker, identify the approximate center frequency of this signal on the max-hold display, increase the attenuation by 10 dB, then reset the EUT (e.g., cycle ac/dc power).

d) Repeat 7.11.2c) twice to ensure that the center of the signal created by the booster remains within 250 kHz of the spectrum analyzer display center frequency. If the frequency of the signal is unstable, confirm that the spectrum analyzer display is centered between the frequency extremes observed. If the signal is wider than 1 MHz, ensure that the spectrum analyzer display is centered on the signal by increasing the RBW. Reset the EUT (e.g., cycle ac/dc power) after each oscillation event, if necessary. Set the spectrum analyzer sweep trigger level to just below the peak amplitude of the displayed EUT oscillation signal.

e) Set the spectrum analyzer to zero-span, with a sweep time of 5 seconds, and single-sweep with max-hold. The spectrum analyzer sweep trigger level in this and the subsequent steps shall be the level identified in 7.11.2d).

f) Decrease the variable attenuator until the spectrum analyzer sweep is triggered, increase the attenuation by 10 dB, then reset the EUT (e.g., cycle ac/dc power).

g) Reset the zero-span trigger of the spectrum analyzer, then repeat 7.11.2f) twice to ensure that the spectrum analyzer is reliably triggered, resetting the EUT (e.g., cycle ac/dc power) after each oscillation event if necessary.

h) Reset the zero-span sweep trigger of the spectrum analyzer, and reset the EUT (e.g., cycle ac/dc power).

i) Force the EUT into oscillation by reducing the attenuation.

j) Use the marker function of the spectrum analyzer to measure the time from the onset of oscillation until the EUT turns off, by setting Marker 1 on the leading edge of the oscillation signal and Marker 2 on the trailing edge. The spectrum analyzer sweep time may be adjusted to improve the time resolution of these cursors.

- k) Capture the spectrum analyzer zero-span trace for inclusion in the test report. Report the power level associated with the oscillation separately if it can't be displayed on the trace.
- l) Repeat 7.11.2b) to 7.11.2k) for all operational uplink and downlink bands.
- m) Set the spectrum analyzer zero-span sweep time for longer than 60 seconds, then measure the restart time for each operational uplink and downlink band.
- n) Replace the normal-operating mode EUT with the EUT that supports an anti-oscillation test mode.
- o) Set the spectrum analyzer zero-span time for a minimum of 120 seconds, and a single sweep.
- p) Manually trigger the spectrum analyzer zero-span sweep, and manually force the booster into oscillation as described in 7.11.2i).
- q) When the sweep is complete, place cursors between the first two oscillation detections, and save the plot for inclusion in the test report. The time between restarts must match the manufacturer's timing for the test mode, and there shall be no more than 5 restarts.
- r) Repeat 7.11.2m) to 7.11.2q) for all operational uplink and downlink bands.

oscillation mitigation or shutdown

- a) Connect the normal-operating mode EUT to the test equipment as shown in Figure 8.
- b) Set the spectrum analyzer center frequency to the center of band under test, and use the following settings:
 - 1) $RBW=30$ kHz, $VBW \geq 3 \times RBW$,
 - 2) power averaging (rms) detector,
 - 3) trace averages ≥ 100 ,
 - 4) span $\geq 120\%$ of operational band under test,
 - 5) number of sweep points $\geq 2 \times \text{Span}/RBW$.
- c) Configure the signal generator for AWGN operation with a 99% OBW of 4.1 MHz, tuned to the frequency of 2.5 MHz above the lower edge or below the upper edge of the operating band under test. Adjust the RF output level of the signal generator such that the measured power level of the AWGN signal at the output port of the booster is 30 dB less than the maximum power of the booster for the band under test. Affirm that the input signal is not obstructing the measurement of the strongest oscillation peak in the band, and is not included within the span in the measurement.
 - 1) Boosters with operating spectrum passbands of 10 MHz or less may use a CW signal source at the band edge rather than AWGN.
 - 2) For device passbands greater than 10 MHz, standard CMRS signal sources (i.e., CDMA, W-CDMA, LTE) may be used instead of AWGN at the band edge.
- d) Set the variable attenuator to a high attenuation setting such that the booster will operate at maximum gain when powered on. Reset the EUT (e.g., cycle ac/dc power). Allow the EUT to complete its boot-up process, to reach full operational gain, and to stabilize its operation.
- e) Set the variable attenuator such that the insertion loss for the center of the band under test (isolation) between the booster donor port and server port is 5 dB greater than the maximum gain, as recorded in the maximum gain test procedure (see 7.3), for the band under test.
- f) Verify the EUT shuts down, i.e., to mitigate the oscillations. If the booster does not shut down, measure and verify the peak oscillation level as follows.
 - 1) Allow the spectrum analyzer trace to stabilize.
 - 2) Place the marker at the highest oscillation level occurring within the span, and record its output level and frequency.
 - 3) Set the spectrum analyzer center frequency to the frequency with the highest oscillation signal level, and reduce the span such that the upper and lower adjacent oscillation peaks are within the span.
 - 4) Use the Minimum Search Marker function to find the lowest output level that is within the span, and within the operational band under test, and record its output level and frequency.
 - 5) Affirm that the peak oscillation level measured in 7.11.3f2), does not exceed by 12.0 dB the minimal output level measured in 7.11.3f4). Record the measurement results of 7.11.3f2) and 7.11.3f4) in tabular format for inclusion in the test report.

- 6) The procedure of 7.11.3f1) to 7.11.3.f5) allows the spectrum analyzer trace to stabilize, and verification of shutdown or oscillation level measurement must occur within 300 seconds.20
- g) Decrease the variable attenuator in 1 dB steps, and repeat step 7.11.3f) for each 1 dB step. Continue testing to the level when the insertion loss for the center of band under test (isolation) between the booster donor port and server port is 5 dB lower than the maximum gain (see 7.3).
- h) Repeat 7.11.3a) to 7.11.3g) for all operational uplink and downlink bands.

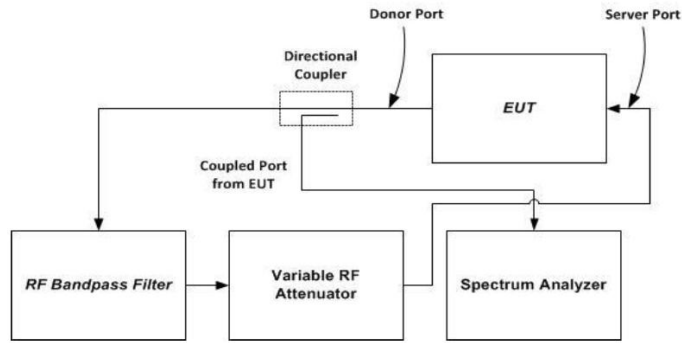

NOTE—This figure shows the test setup for uplink bands transmission path tests; i.e., signal flow is out from the donor port into the directional coupler. For downlink bands transmission path tests, the feedback signal flow path direction and equipment connections shall be reversed, i.e., signal flow is out from the server port into the directional coupler, and signal flow is into the donor port from the variable RF attenuator.

Figure 7 – Oscillation detection (7.11.2) test setup

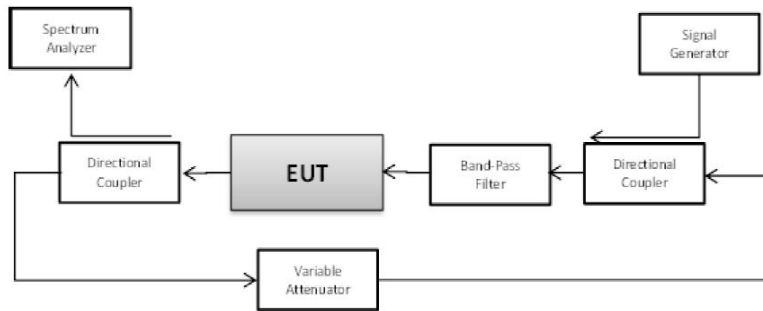

Figure 8 – Oscillation mitigation/shutdown test setup

Test data

Temperature	21.8°C	Humidity	53.6%
Test Engineer	Diamond Lu	Test Mode	Transmitting

Test results of detection time

Operation Bands		Detection Time (s)	Limit (s)	Result
Uplink	PCS	0.270	0.300	PASS
	AWS	0.140	0.300	PASS
	Cellular	0.220	0.300	PASS
	Lower 700	0.225	0.300	PASS
	Upper 700	0.235	0.300	PASS
Downlink	PCS	0.280	1.000	PASS
	AWS	0.255	1.000	PASS
	Cellular	0.175	1.000	PASS
	Lower 700	0.195	1.000	PASS
	Upper 700	0.275	1.000	PASS

Test results of detection time

Operation Bands		Restarting Time(s)	Limit (s)	Restarting Counts	Limit	Result
Uplink	PCS	128.3	60	3	5	PASS
	AWS	92.25	60	3	5	PASS
	Cellular	70.20	60	3	5	PASS
	Lower 700	72.00	60	2	5	PASS
	Upper 700	75.20	60	2	5	PASS
Downlink	PCS	70.11	60	4	5	PASS
	AWS	69.70	60	3	5	PASS
	Cellular	74.21	60	3	5	PASS
	Lower 700	116	60	2	5	PASS
	Upper 700	88.97	60	3	5	PASS

detection time

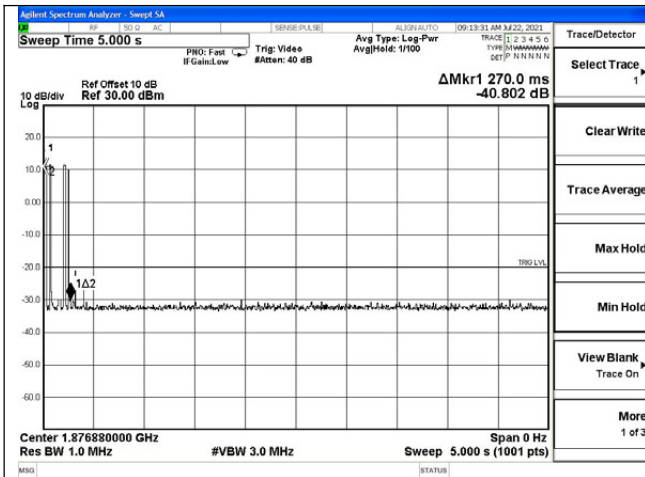

PCS band UL

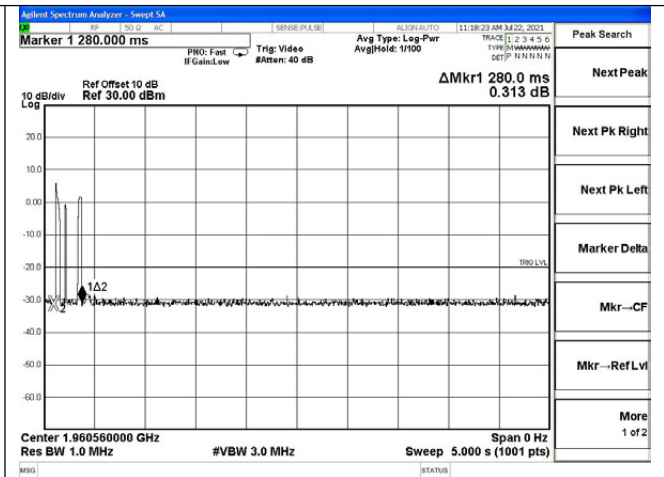

PCS band DL

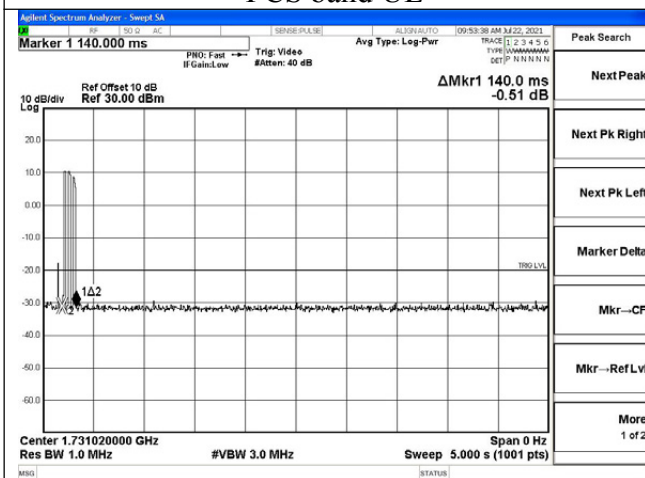

AWS band UL

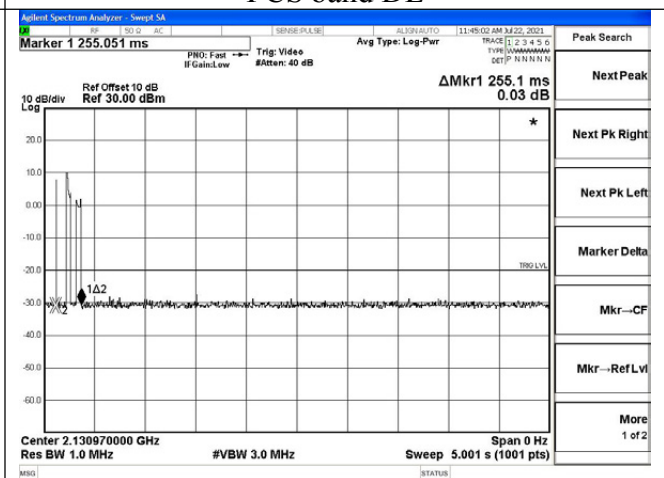

AWS band DL

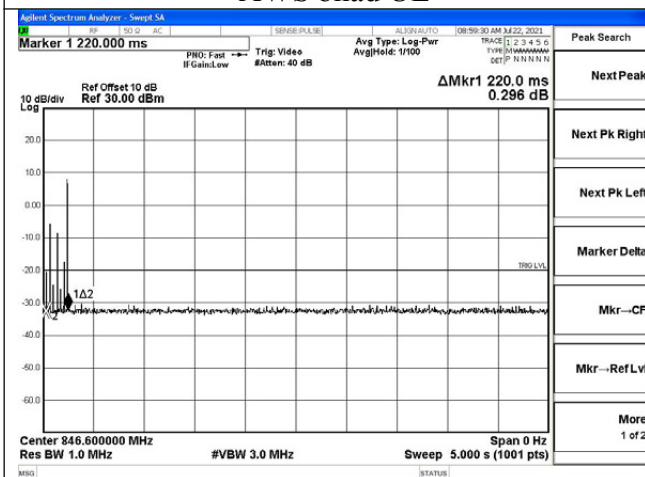

Cellular band UL

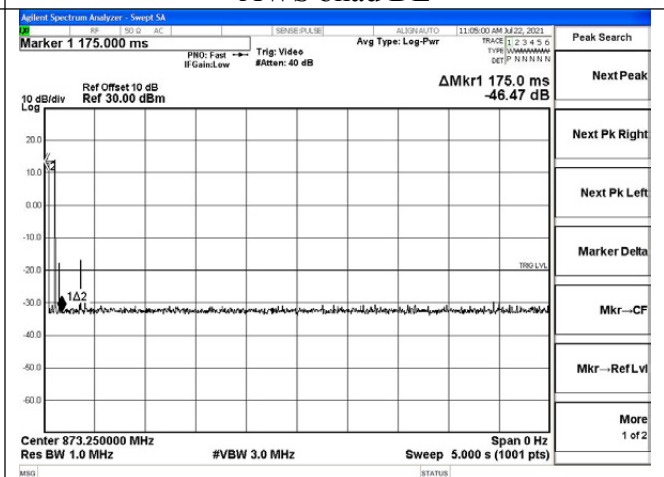

Cellular band DL

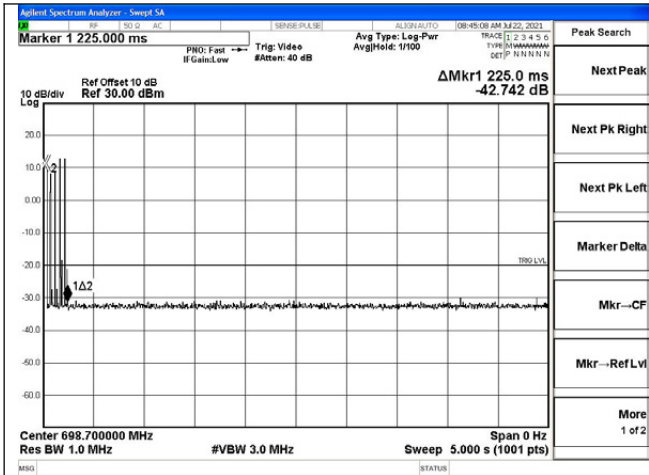

Lower 700

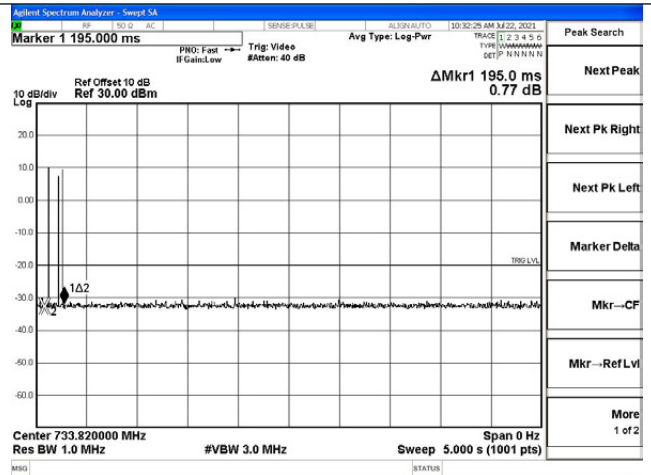

Lower 700

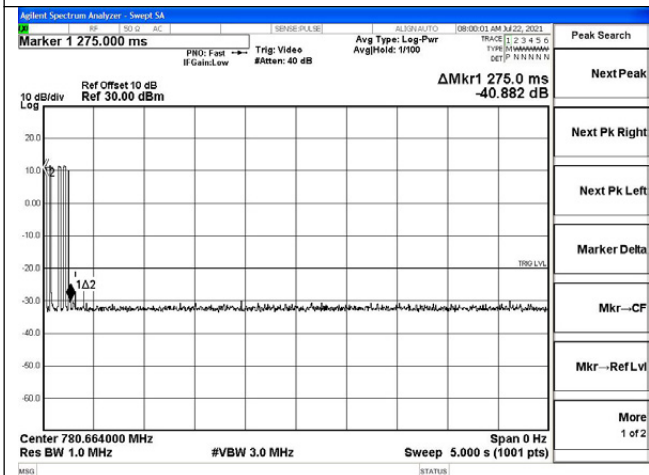

Upper 700

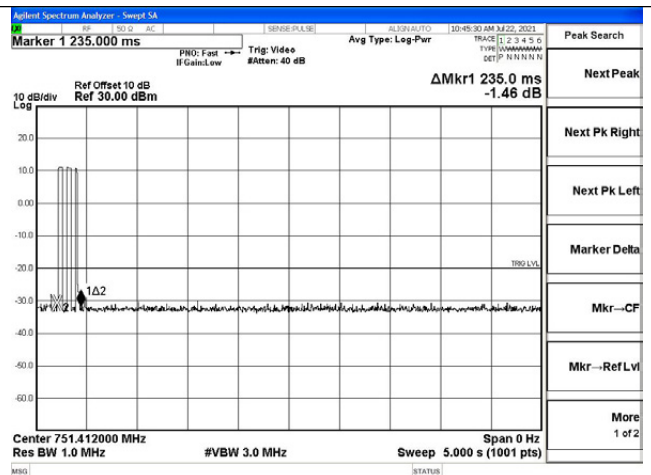

Upper 700

restarting time

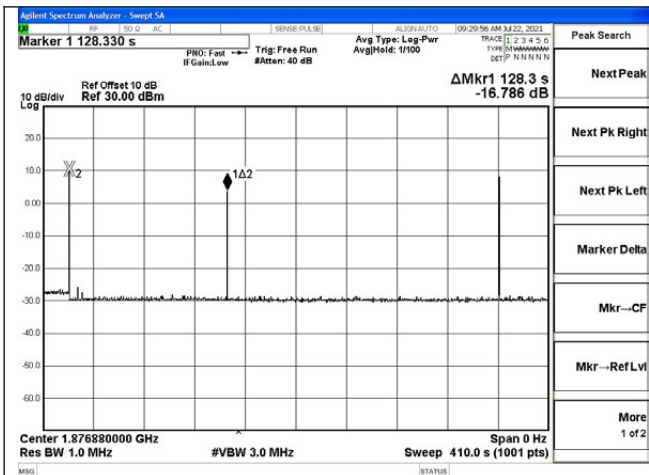

PCS band UL

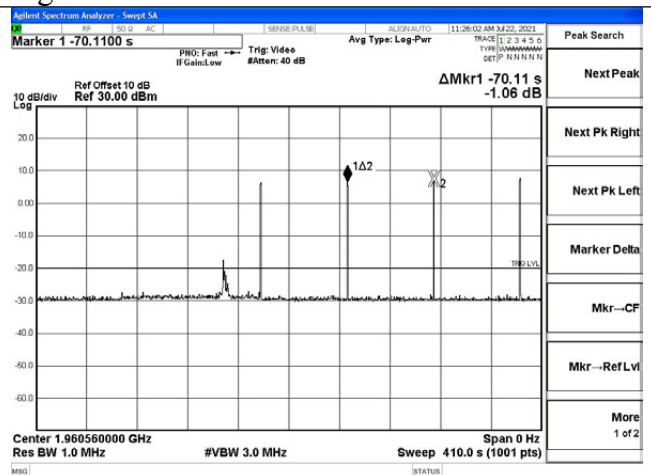

PCS band DL

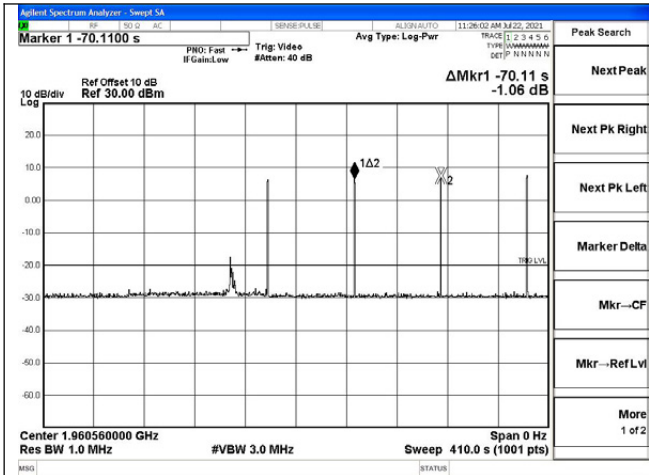

AWS band UL

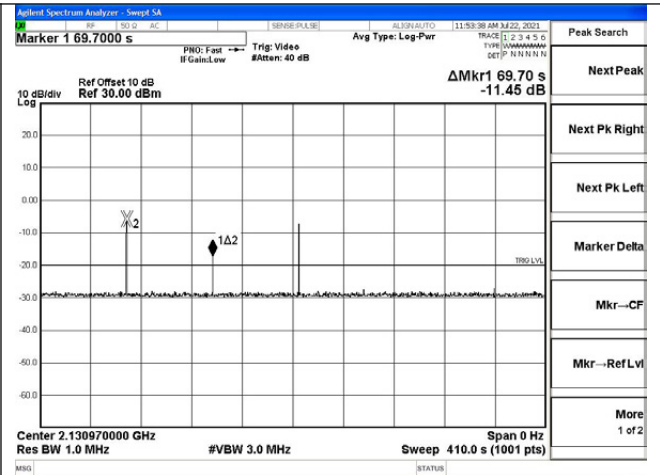

AWS band DL

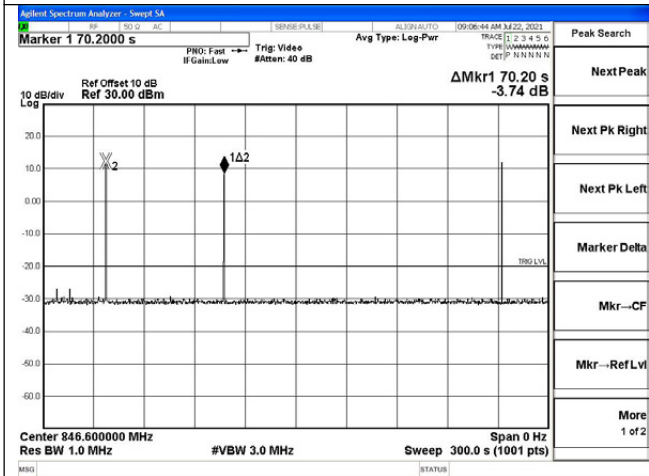

Cellular band UL

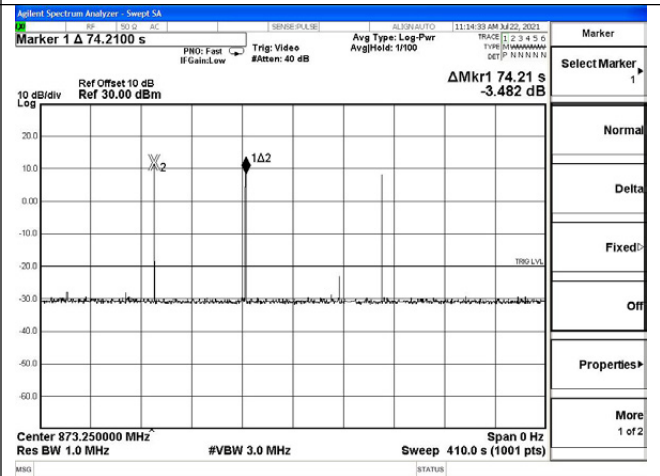

Cellular band DL

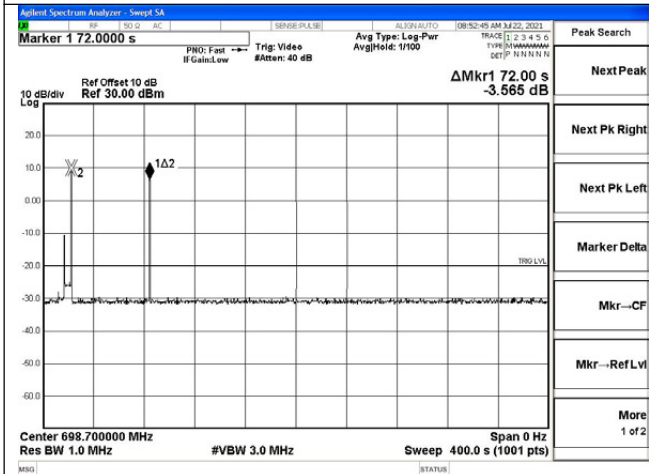

Lower 700 band UL

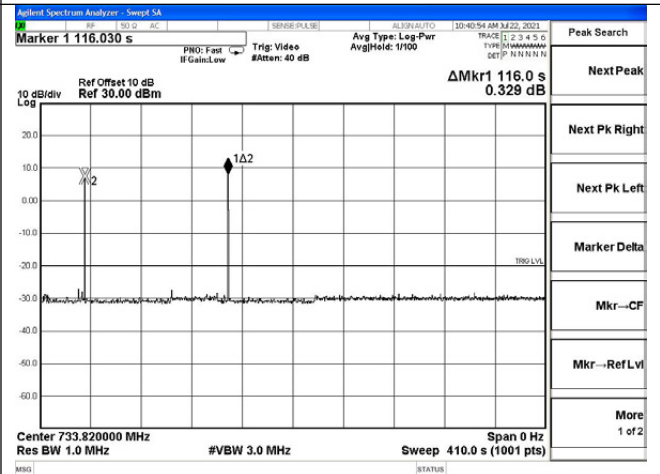

Lower 700 band DL

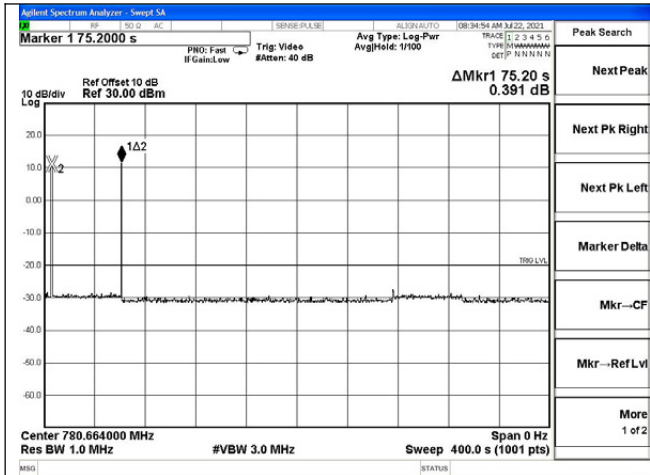

Upper 700 band UL

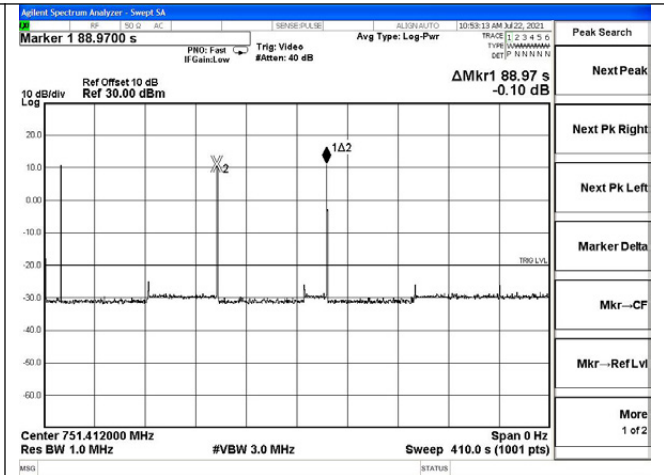

Upper 700 band DL

oscillation mitigation or shutdown

PCS Band	Uplink(1850-1910MHz)		
Signal Type	AWGN		
Isolation	Deffrence	Limit	Result
dB	dB	dB	
+5	4.57	<12	Pass
+4	5.38	<12	Pass
+3	5.79	<12	Pass
+2	7.83	<12	Pass
+1	10.27	<12	Pass
0	shutdown		

PCS Band	Downlink(1930-1990MHz)		
Signal Type	AWGN		
Isolation	Deffrence	Limit	Result
dB	dB	dB	
+5	4.68	<12	Pass
+4	6.57	<12	Pass
+3	4.69	<12	Pass
+2	8.28	<12	Pass
+1	9.32	<12	Pass
0	11.02	<12	Pass
-1	shutdown		

AWS band	Uplink(1710-1755MHz)		
Signal Type	AWGN		
Isolation	Deffrence	Limit	Result
dB	dB	dB	
+5	6.53	<12	Pass
+4	5.86	<12	Pass
+3	7.85	<12	Pass
+2	9.14	<12	Pass
+1	9.59	<12	Pass
0	11.04	<12	Pass
-1	shutdown		

AWS band	Downlink(2110-2155MHz)		
Signal Type	AWGN		
Isolation	Deffrence	Limit	Result
dB	dB	dB	
+5	5.32	<12	Pass
+4	6.13	<12	Pass
+3	7.19	<12	Pass
+2	8.58	<12	Pass
+1	10.17	<12	Pass
0	shutdown		

Cellular Band	Uplink(824-849MHz)		
Signal Type	AWGN		
Isolation	Deffrence	Limit	Result
dB	dB	dB	
+5	4.89	<12	Pass
+4	6.77	<12	Pass
+3	9.26	<12	Pass
+2	11.24	<12	Pass
+1	shutdown		

Cellular Band	Downlink(869-894MHz)		
Signal Type	AWGN		
Isolation	Deffrence	Limit	Result
dB	dB	dB	
+5	5.72	<12	Pass
+4	7.24	<12	Pass
+3	8.36	<12	Pass
+2	9.12	<12	Pass
+1	11.58	<12	Pass
0	shutdown		

Lower700MHz band	Uplink(698-716MHz)		
Signal Type	AWGN		
Isolation	Deffrence	Limit	Result
dB	dB	dB	
+5	4.35	<12	Pass
+4	3.59	<12	Pass
+3	6.87	<12	Pass
+2	7.46	<12	Pass
+1	9.03	<12	Pass
0	9.86	<12	Pass
-1	11.25	<12	Pass
-2	shutdown		

Lower700MHz band	Downlink(728-746MHz)		
Signal Type	AWGN		
Isolation	Deffrence	Limit	Result
dB	dB	dB	
+5	6.33	<12	Pass
+4	7.24	<12	Pass
+3	5.38	<12	Pass
+2	8.75	<12	Pass
+1	9.25	<12	Pass
0	10.24	<12	Pass
-1	shutdown		

Upper 700Mhz Band	Uplink(776-787MHz)		
Signal Type	AWGN		
Isolation	Deffrence	Limit	Result
dB	dB	dB	
+5	5.68	<12	Pass
+4	4.39	<12	Pass
+3	7.28	<12	Pass
+2	8.31	<12	Pass
+1	9.02	<12	Pass
0	10.69	<12	Pass
-1	11.26	<12	Pass
-2	shutdown		

Upper 700Mhz Band	Downlink(746-757MHz)		
Signal Type	AWGN		
Isolation	Deffrence	Limit	Result
dB	dB	dB	
+5	7.14	<12	Pass
+4	5.28	<12	Pass
+3	4.29	<12	Pass
+2	8.34	<12	Pass
+1	10.27	<12	Pass
0	shutdown		

7. RADIATION SPURIOUS EMISSION

Applicable Standard

According to §2.1053 Measurements required: Field strength of spurious radiation.

This procedure is intended to satisfy the requirements specified in Section 2.1053. The applicable limits are those specified for mobile station emissions in the rule part appropriate to the band of operation (see Appendix A).

Separate compliance requirements are applicable for any digital device circuitry that controls additional functions or capabilities and that is not used only to enable operation of the transmitter in a booster device [i.e., Section 15.3(k) digital device definition]. Separate compliance requirements are applicable for any receiver components/functions that tune within 30 MHz to 960 MHz contained in booster devices [Section 15.101(b)].

Test Procedure

- a) Place the EUT on an OATS or semi-anechoic chamber turntable 3 m from the receiving antenna.
- b) Connect the EUT to the test equipment as shown in Figure 10 beginning with the uplink output (donor) port.
- c) Set the signal generator to produce a CW signal with the frequency set to the center of the operational band under test, and the power level set at PIN as determined from measurement results per 7.2.
- d) Measure the radiated spurious emissions from the EUT from the lowest to the highest frequencies as specified in Section 2.1057. Maximize the radiated emissions by using the procedures described in ANSI C63.26.
- e) Capture the peak emissions plots using a peak detector with Max-Hold for inclusion in the test report. Tabular data is acceptable in lieu of spectrum analyzer plots.
- f) Repeat 7.12c) through 7.12e) for all uplink and downlink operational bands.

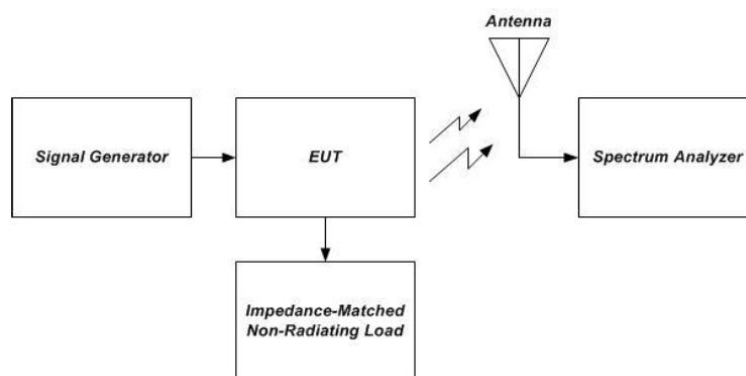

Figure 10 – Radiated spurious emissions test and instrumentation setup

Test Data

Temperature	22.4°C	Humidity	53.7%
Test Engineer	Diamond Lu	Test Mode	Transmitting

Uplink, Test Frequency 1880MHz

Frequency (MHz)	PMea (dBm)	Pcl (dB)	Diatance	Ga Antenna Gain(dB)	Convert Factor	Peak EIRP (dBm)	Limit (dBm)	Polarization
947.25	-42.68	5.32	3.00	10.03	-37.97	-13.00	-24.97	H
2640.00	-46.08	6.19	3.00	11.41	-40.86	-13.00	-27.86	H
946.34	-46.99	5.32	3.00	10.03	-42.28	-13.00	-29.28	V
2647.89	-51.63	6.19	3.00	11.41	-46.41	-13.00	-33.41	V

Uplink, Test Frequency 1732.5MHz

Frequency (MHz)	PMea (dBm)	Pcl (dB)	Diatance	Ga Antenna Gain(dB)	Convert Factor	Peak EIRP (dBm)	Limit (dBm)	Polarization
824.80	-50.15	4.62	3.00	9.81	-44.96	-13.00	-31.96	H
1796.20	-50.94	5.94	3.00	10.86	-46.02	-13.00	-33.02	H
836.82	-52.43	4.62	3.00	9.81	-47.24	-13.00	-34.24	V
1786.68	-53.86	5.94	3.00	10.86	-48.94	-13.00	-35.94	V

Uplink, Test Frequency 836.5MHz

Frequency (MHz)	PMea (dBm)	Pcl (dB)	Diatance	Ga Antenna Gain(dB)	Convert Factor	Peak EIRP (dBm)	Limit (dBm)	Polarization
872.80	-46.21	3.90	3.00	8.58	-41.53	-13.00	-28.53	H
2509.27	-46.65	4.32	3.00	6.80	-44.17	-13.00	-31.17	H
872.83	-46.54	3.90	3.00	8.58	-41.86	-13.00	-28.86	V
2509.20	-49.52	4.32	3.00	6.80	-47.04	-13.00	-34.04	V

Uplink, Test Frequency 707.5MHz

Frequency (MHz)	PMea (dBm)	Pcl (dB)	Diatance	Ga Antenna Gain(dB)	Convert Factor	Peak EIRP (dBm)	Limit (dBm)	Polarization
675.28	-40.04	4.75	3.00	10.44	-34.35	-13.00	-21.35	H
1632.49	-44.22	5.66	3.00	12.33	-37.55	-13.00	-24.55	H
648.25	-44.06	4.75	3.00	10.44	-38.37	-13.00	-25.37	V
1634.28	-47.86	5.66	3.00	12.33	-41.19	-13.00	-28.19	V

Uplink, Test Frequency 782MHz

Frequency (MHz)	PMea (dBm)	Pcl (dB)	Diatance	Ga Antenna Gain(dB)	Convert Factor	Peak EIRP (dBm)	Limit (dBm)	Polarization
587.46	-39.78	4.99	3.00	11.12	-33.65	-13.00	-20.65	H
2874.36	-45.12	5.85	3.00	12.02	-38.95	-13.00	-25.95	H
588.10	-43.00	4.99	3.00	11.12	-36.87	-13.00	-23.87	V
2877.49	-48.78	5.85	3.00	12.02	-42.61	-13.00	-29.61	V

Downlink, Test Frequency1960MHz

Frequency (MHz)	PMea (dBm)	Pcl (dB)	Diatance	Ga Antenna Gain(dB)	Convert Factor	Peak EIRP (dBm)	Limit (dBm)	Polarization
175.32	-42.70	3.26	3.00	5.88	-40.08	-13.00	-27.08	H
3897.14	-48.93	6.11	3.00	11.36	-43.68	-13.00	-30.68	H
175.32	-46.49	3.26	3.00	5.88	-43.87	-13.00	-30.87	V
3899.25	-51.52	6.11	3.00	11.36	-46.27	-13.00	-33.27	V

Downlink, Test Frequency2132.5MHz

Frequency (MHz)	PMea (dBm)	Pcl (dB)	Diatance	Ga Antenna Gain(dB)	Convert Factor	Peak EIRP (dBm)	Limit (dBm)	Polarization
941.25	-42.70	3.28	3.00	5.83	-40.08	-13.00	-27.08	H
4297.14	-48.93	6.11	3.00	11.36	-43.68	-13.00	-30.68	H
941.89	-46.49	3.27	3.00	5.85	-43.87	-13.00	-30.87	V
4299.34	-51.52	6.11	3.00	11.36	-46.27	-13.00	-33.27	V

Downlink, Test Frequency 881.5MHz

Frequency (MHz)	PMea (dBm)	Pcl (dB)	Diatance	Ga Antenna Gain(dB)	Convert Factor	Peak EIRP (dBm)	Limit (dBm)	Polarization
693.24	-40.89	3.73	3.00	5.25	-39.37	-13.00	-26.37	H
1702.38	-46.76	4.61	3.00	9.58	-41.79	-13.00	-28.79	H
693.24	-44.50	3.73	3.00	5.25	-42.98	-13.00	-29.98	V
1702.38	-49.69	4.61	3.00	9.58	-44.72	-13.00	-31.72	V

Downlink, Test Frequency 737MHz

Frequency (MHz)	PMea (dBm)	Pcl (dB)	Diatance	Ga Antenna Gain(dB)	Convert Factor	Peak EIRP (dBm)	Limit (dBm)	Polarization
693.24	-40.89	3.73	3.00	5.25	-39.37	-13.00	-26.37	H
1702.38	-46.76	4.61	3.00	9.58	-41.79	-13.00	-28.79	H
693.24	-44.50	3.73	3.00	5.25	-42.98	-13.00	-29.98	V
1702.38	-49.69	4.61	3.00	9.58	-44.72	-13.00	-31.72	V

Downlink, Test Frequency 751.5MHz

Frequency (MHz)	PMea (dBm)	Pcl (dB)	Diatance	Ga Antenna Gain(dB)	Convert Factor	Peak EIRP (dBm)	Limit (dBm)	Polarization
693.28	-40.76	3.73	3.00	5.26	-39.23	-13.00	-26.23	H
1731.04	-46.47	4.66	3.00	9.63	-41.50	-13.00	-28.50	H
693.28	-44.19	3.73	3.00	5.26	-42.66	-13.00	-29.66	V
1731.04	-49.65	4.66	3.00	9.63	-44.68	-13.00	-31.68	V

8. TEST SETUP PHOTOGRAPHS OF EUT

Please refer to separated files for Test Setup Photos of the EUT.

9. EXTERIOR PHOTOGRAPHS OF THE EUT

Please refer to separated files for External Photos of the EUT.

10. INTERIOR PHOTOGRAPHS OF THE EUT

Please refer to separated files for Internal Photos of the EUT.

-----THE END OF TEST REPORT-----