

## TEST REPORT

**Report Number: 17080004HKG-001**

Application for Original Grant of 47 CFR Part 15 Certification

**FCC ID: 2ALZ7-8478A1705**

This report contains the data of (WI-FI) portion only.

**PREPARED AND CHECKED BY:**

**APPROVED BY:**

Signed On File  
Leung Sung Tak, Andy  
Engineer

---

Koo Wai Ip  
Technical Supervisor  
Date: September 07, 2017

Intertek's standard Terms and Conditions can be obtained at our website <http://www.intertek.com/terms/>.

The test report only allows to be revised within the retention period unless further standard or the requirement was noticed

This report is for the exclusive use of Intertek's Client and is provided pursuant to the agreement between Intertek and its Client. Intertek's responsibility and liability are limited to the terms and conditions of the agreement. Intertek assumes no liability to any party, other than to the Client in accordance with the agreement, for any loss, expense or damage occasioned by the use of this report. Only the Client is authorized to permit copying or distribution of this report and then only in its entirety. Any use of the Intertek name or one of its marks for the sale or advertisement of the tested material, product or service must first be approved in writing by Intertek. The observations and test results in this report are relevant only to the sample tested. This report by itself does not imply that the material, product, or service is or has ever been under an Intertek certification program.

© 2017 Intertek

## TEST REPORT

### GENERAL INFORMATION

<b>Applicant Name:</b>	CCL Electronics Ltd.
<b>Applicant Address:</b>	Unit 1-3, 9/F., Wang Lung Industrial Building, 11 Lung Tak Street, Tsuen Wan, N.T., Hong Kong.
<b>FCC Specification Standard:</b>	FCC Part 15, October 1, 2015 Edition
<b>FCC ID:</b>	2ALZ7-8478A1705
<b>FCC Model(s):</b>	C8478
<b>Type of EUT:</b>	Spread Spectrum Transmitter
<b>Description of EUT:</b>	Wifi Weather Station
<b>Serial Number:</b>	N/A
<b>Sample Receipt Date:</b>	August 01, 2017
<b>Date of Test:</b>	August 01, 2017 to September 06, 2017
<b>Report Date:</b>	September 07, 2017
<b>Environmental Conditions:</b>	Temperature: +10 to 40°C Humidity: 10 to 90%

**TEST REPORT**

**TABLE OF CONTENTS**

**1.0 Test Results Summary & Statement of Compliance** ..... 4

    1.1 Summary of Test Results ..... 4

    1.2 Statement of Compliance ..... 4

**2.0 General Description** ..... 5

    2.1 Product Description ..... 5

    2.2 Test Methodology ..... 6

    2.3 Test Facility ..... 6

    2.4 Related Submittal(s) Grants ..... 6

**3.0 System Test Configuration** ..... 7

    3.1 Justification ..... 7

    3.2 EUT Exercising Software ..... 8

    3.3 Details of EUT and Description of Accessories ..... 9

    3.4 Measurement Uncertainty ..... 9

**4.0 Test Results** ..... 10

    4.1 Maximum Conducted Output Power at Antenna Terminals ..... 10

    4.2 Minimum 6dB RF Bandwidth ..... 12

    4.3 Maximum Power Spectral Density ..... 19

    4.4 Out of Band Conducted Emissions ..... 26

    4.5 Field Strength Calculation ..... 39

    4.6 Transmitter Radiated Emissions in Restricted Bands and Spurious Emissions ..... 40

        4.6.1 Radiated Emission Configuration Photograph ..... 40

        4.6.2 Radiated Emission Data ..... 40

        4.6.3 Radiated Emission Test Setup ..... 51

        4.6.4 Transmitter Duty Cycle Calculation ..... 52

    4.7 AC Power Line Conducted Emission ..... 53

        4.7.1 AC Power Line Conducted Emission Configuration Photograph ..... 53

        4.7.2 AC Power Line Conducted Emission Data ..... 53

        4.7.3 Conducted Emission Test Setup ..... 56

**5.0 Equipment List** ..... 57

**TEST REPORT**

**EXHIBIT 1 TEST RESULTS SUMMARY & STATEMENT OF COMPLIANCE**

**1.0 TEST RESULTS SUMMARY & STATEMENT OF COMPLIANCE**

1.1 Summary of Test Results

TEST ITEMS	FCC PART 15 SECTION	RESULTS	DETAILS SEE SECTION
Antenna Requirement	15.203	Pass	2.1
Max. Conducted Output Power (Peak)	15.247(b)(3)&(4)	Pass	4.1
Min. 6dB RF Bandwidth	15.247(a)(2)	Pass	4.2
Max. Power Density (average)	15.247(e)	Pass	4.3
Out of Band Antenna Conducted Emission	15.247(d)	Pass	4.4
Radiated Emission in Restricted Bands and Spurious Emissions	15.247(d), 15.209 & 15.109	Pass	4.6
AC Power Line Conducted Emission	15.207 & 15.107	Pass	4.7

Note: Pursuant to FCC Part 15 Section 15.215(c), the 20dB bandwidth of the emission was contained within the frequency band designated (mentioned as above) which the EUT operated. The effects, if any, from frequency sweeping, frequency hopping, other modulation techniques and frequency stability over expected variations in temperature and supply voltage were considered.

1.2 Statement of Compliance

The equipment under test is found to be complying with the following standard:

FCC Part 15, October 1, 2015 Edition

## TEST REPORT

### EXHIBIT 2 GENERAL DESCRIPTION

#### 2.0 GENERAL DESCRIPTION

##### 2.1 Product Description

The Equipment Under Test (EUT) is a Wifi Weather Station. The EUT is powered by an AC/DC adaptor (Input: 100-240V, 50/60Hz, 0.5A; Output 5.0V, 1.0A). The EUT contains a 915MHz receiver and a WIFI module. The 915 MHz receiver is for the weather information (from the 915MHz weather sensor). After finishing the setup between the EUT and the smart phone through WIFI, the weather information can be shown on the web page.

The Equipment Under Test (EUT) operates at frequency range of 2412MHz to 2462MHz with 11 channels.

For 802.11b mode, it operates at frequency range of 2412.000MHz to 2462.000MHz with 11 channels. It transmits via Direct-sequence spread spectrum (DSSS) modulation. Maximum bit rate can be up to 11Mbps.

For 802.11g mode, it operates at frequency range of 2412.000MHz to 2462.000MHz with 11 channels. It transmits via Orthogonal Frequency Division Multiplexing (OFDM) modulation. Maximum bit rate can be up to 54Mbps.

For 802.11n (with 20MHz bandwidth) mode, it operates at frequency range of 2412.000MHz to 2462.000MHz with 11 channels. It transmits via Orthogonal Frequency Division Multiplexing (OFDM) modulation. Maximum bit rate can support up to 65Mbps.

The antenna(s) used in the EUT is integral, and the test sample is a prototype.

The circuit description is saved with filename: descri.pdf.

## TEST REPORT

### 2.2 Test Methodology

Both AC power line-conducted and radiated emission measurements were performed according to the procedures in ANSI C63.10 (2013). Preliminary radiated scans and all radiated measurements were performed in radiated emission test sites. All Radiated tests were performed at an antenna to EUT distance of 3 meters, unless stated otherwise in the "**Justification Section**" of this Application. Antenna port conducted measurements were performed according to ANSI C63.10 (2013) and KDB Publication No.558074 D01 v04 (05-April-2017) All other measurements were made in accordance with the procedures in 47 CFR Part 2.

### 2.3 Test Facility

The radiated emission test site and antenna port conducted measurement facility used to collect the radiated data and conductive data are at Workshop No. 3, G/F., World-Wide Industrial Centre, 43-47 Shan Mei Street, Fo Tan, Sha Tin, N.T., Hong Kong. This test facility and site measurement data have been fully placed on file with the FCC.

### 2.4 Related Submittal(s) Grants

This is a single application for certification of a transceiver (WiFi portion)

## TEST REPORT

### EXHIBIT 3 SYSTEM TEST CONFIGURATION

#### 3.0 SYSTEM TEST CONFIGURATION

##### 3.1 Justification

For radiated emissions testing, the equipment under test (EUT) was setup to transmit / receive continuously to simplify the measurement methodology. Care was taken to ensure proper power supply voltages during testing. During testing, all cables (if any) were manipulated to produce worst case emissions.

The EUT is powered by an AC/DC adaptor (Input: 100-240V, 50/60Hz, 0.5A; Output 5.0V, 1.0A).

For the measurements, the EUT was attached to a plastic stand if necessary and placed on the wooden turntable. If the base unit attached to peripherals, they were connected and operational (as typical as possible).

The signal was maximized through rotation and placement in the three orthogonal axes. The antenna height and polarization were varied during the search for maximum signal level. The antenna height was varied from 1 to 4 meters. Radiated emissions were taken at three meters unless the signal level was too low for measurement at that distance. If necessary, a pre-amplifier was used and/or the test was conducted at a closer distance.

For any intentional radiator powered by AC power line, measurements of the radiated signal level of the fundamental frequency component of the emission was performed with the supply voltage varied between 85% and 115% of the nominal rated supply voltage.

Radiated emission measurement for transmitter were performed from the lowest radio frequency signal generated in the device which is greater than 9 kHz to the tenth harmonic of the highest fundamental frequency or to 40 GHz, whichever is lower.

Emission that are directly caused by digital circuits in the transmit path and transmitter portion were measured, and the limit are according to FCC Part 15 Section 15.209. Digital circuitries used to control additional functions other than the operation of the transmitter are subject to FCC Part 15 Section 15.109.

## TEST REPORT

### 3.1 Justification – Cont'd

Detector function for radiated emissions was in peak mode. Average readings, when required, were taken by measuring the duty cycle of the equipment under test and subtracting the corresponding amount in dB from the measured peak readings. A detailed description for the calculation of the average factor can be found in section 4.8.3.

Determination of pulse desensitization was made according to *Hewlett Packard Application Note 150-2, Spectrum Analysis... Pulsed RF*. The effective period (Teff) was referred to Exhibit 4.8.3. With the resolution bandwidth 1MHz and spectrum analyzer IF bandwidth 3dB, the pulse desensitization factor was 0dB.

For AC line conducted emission test, the EUT along with its peripherals were placed on a 1.0m(W)x1.5m(L) and 0.8m in height wooden table and the EUT was adjusted to maintain a 0.4 meter space from a vertical reference plane. The EUT was connected to power mains through a line impedance stabilization network (LISN), which provided 50ohm coupling impedance for measuring instrument. The LISN housing, measuring instrument case, reference ground plane, and vertical ground plane were bounded together. The excess power cable between the EUT and the LISN was bundled.

All connecting cables of EUT and peripherals were manipulated to find the maximum emission.

Different data rates have been tested. Worst case is reported only.

All relevant operation modes have been tested, and the worst case data is included in this report.

All data rates were tested under normal mode of WiFi. Only the worst-case data is shown in the report for DSSS and OFDM

### 3.2 EUT Exercising Software

The EUT exercise program (if any) used during radiated and conducted testing was designed to exercise the various system components in a manner similar to a typical use.



## TEST REPORT

### 3.3 Details of EUT and Description of Accessories

Details of EUT:

- (1) An AC/DC adaptor (Input: 100-240V, 50/60Hz, 0.5A; Output 5.0V, 1.0A). (Provided by Client)

Description of Accessories:

There are no accessories for compliance of this product.

### 3.4 Measurement Uncertainty

When determining of the test conclusion, the Measurement Uncertainty of test at a level of confidence of 95% has been considered. The values of the Measurement uncertainty for radiated emission test and RF conducted measurement test are  $\pm 5.3\text{dB}$  and  $\pm 0.99\text{dB}$  respectively. The value of the Measurement uncertainty for conducted emission test is  $\pm 4.2\text{dB}$ .

Uncertainty and Compliance - Unless the standard specifically states that measured values are to be extended by the measurement uncertainty in determining compliance, all compliance determinations are based on the actual measured value.

## TEST REPORT

### EXHIBIT 4 TEST RESULTS

#### 4.0 TEST RESULTS

##### 4.1 Maximum Conducted (peak) Output Power at Antenna Terminals

###### RF Conduct Measurement Test Setup

The figure below shows the test setup, which is utilized to make these measurements.

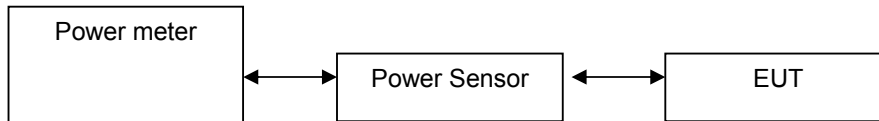

The antenna port of the EUT was connected to the input of a spectrum analyzer.

- The antenna power of the EUT was connected to the input of a power meter. Power was read directly and cable loss correction was added to the reading to obtain power at the EUT antenna terminals. The measurement procedure [PK29.1.2 was used](#).
- The EUT should be configured to transmit continuously (at a minimum duty cycle of 98%) at full power over the measurement duration. The measurement procedure AVG1 was used.

###### IEEE 802.11b (DSSS, 1 Mbps) Antenna Gain = 0 dBi

Frequency (MHz)	Output in dBm	Output in mWatt
Low Channel: 2412	16.63	46.03
Middle Channel: 2437	17.71	59.02
High Channel: 2462	17.28	53.46

###### IEEE 802.11g (OFDM, 6 Mbps) Antenna Gain = 0 dBi

Frequency (MHz)	Output in dBm	Output in mWatt
Low Channel: 2412	19.78	95.06
Middle Channel: 2437	20.10	102.33
High Channel: 2462	19.86	96.83

###### IEEE 802.11n (20MHz) (OFDM, MCS0) Antenna Gain = 0 dBi

Frequency (MHz)	Output in dBm	Output in mWatt
Low Channel: 2412	19.78	95.06
Middle Channel: 2437	19.98	99.54
High Channel: 2462	19.88	97.27

**TEST REPORT**

## 4.1 Maximum Conducted Output Power at Antenna Terminals – Cont'd

Cable loss : 0.5 dB External Attenuation : 0 dBCable loss, external attenuation:  included in OFFSET function  
 added to SA raw reading

IEEE 802.11b (DSSS, 1 Mbps)

max. conducted (peak) output level = 17.71 dBm

IEEE 802.11g (OFDM, 9 Mbps)

max. conducted (peak) output level = 20.10 dBm

IEEE 802.11n (20MHz) (OFDM, MCS0)

max. conducted (peak) output level = 19.98 dBm

Limits:

 1W (30dBm) for antennas with gains of 6dBi or less \_\_\_W (\_\_\_dBm) for antennas with gains more than 6dBi

**TEST REPORT**

## 4.2 Minimum 6dB RF Bandwidth

The antenna port of the EUT was connected to the input of a spectrum analyzer. The EBW measurement procedure was used. A PEAK output reading was taken, a DISPLAY line was drawn 6dB lower than PEAK level. The 6dB bandwidth was determined from where the channel output spectrum intersected the display line.

## IEEE 802.11b (DSSS, 1 Mbps)

Frequency (MHz)	6dB Bandwidth (MHz)	
Low Channel:	2412	9.3
Middle Channel:	2437	9.4
High Channel:	2462	9.3

## IEEE 802.11g (OFDM, 6 Mbps)

Frequency (MHz)	6dB Bandwidth (MHz)	
Low Channel:	2412	15.4
Middle Channel:	2437	15.4
High Channel:	2462	15.4

## IEEE 802.11n (20MHz) (OFDM, MCS0)

Frequency (MHz)	6dB Bandwidth (MHz)	
Low Channel:	2412	15.4
Middle Channel:	2437	15.3
High Channel:	2462	15.4

## Limits

6 dB bandwidth shall be at least 500kHz

The plots of 6dB RF bandwidth are saved as below.

## TEST REPORT

### PLOTS OF 6dB RF BANDWIDTH

802.11b, Lowest Channel

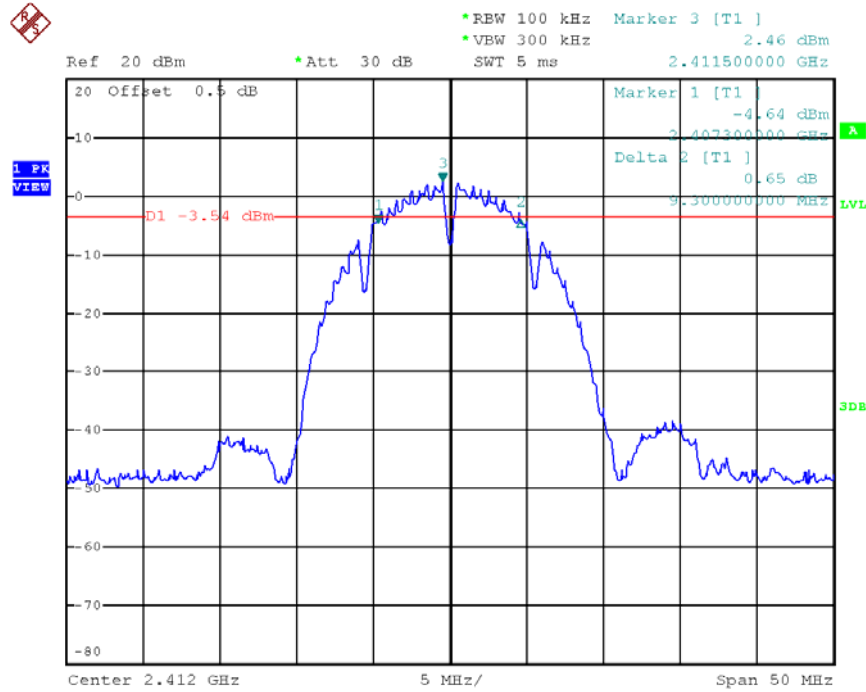

802.11b, Middle Channel

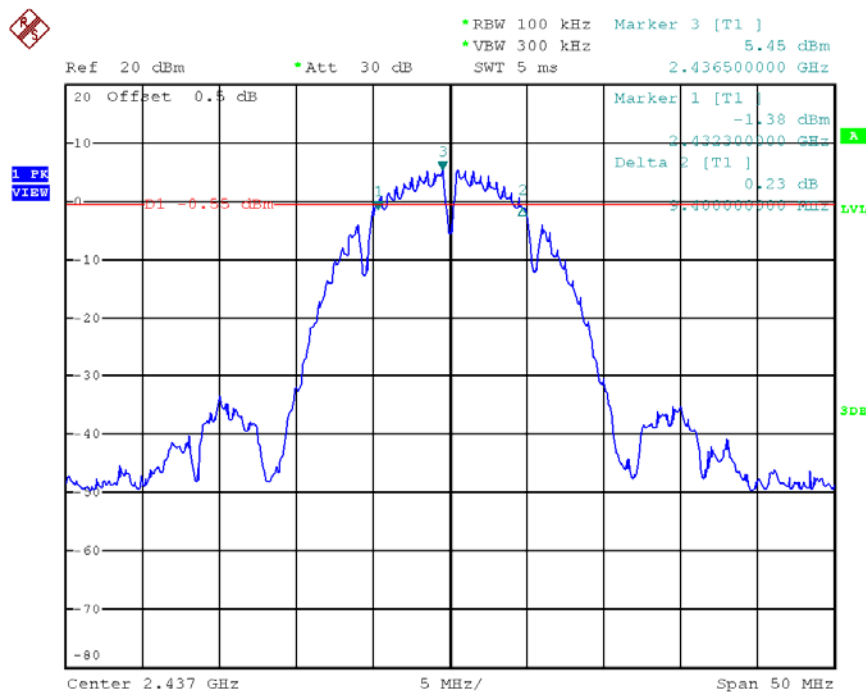

## TEST REPORT

### PLOTS OF 6dB RF BANDWIDTH

802.11b, Highest Channel

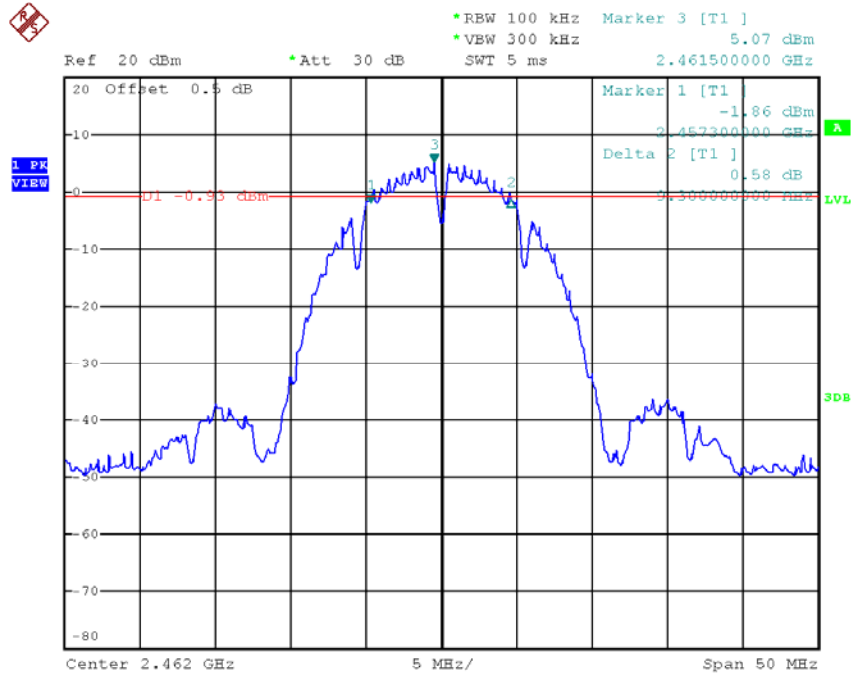

## TEST REPORT

### PLOTS OF 6dB RF BANDWIDTH

802.11g, Lowest Channel

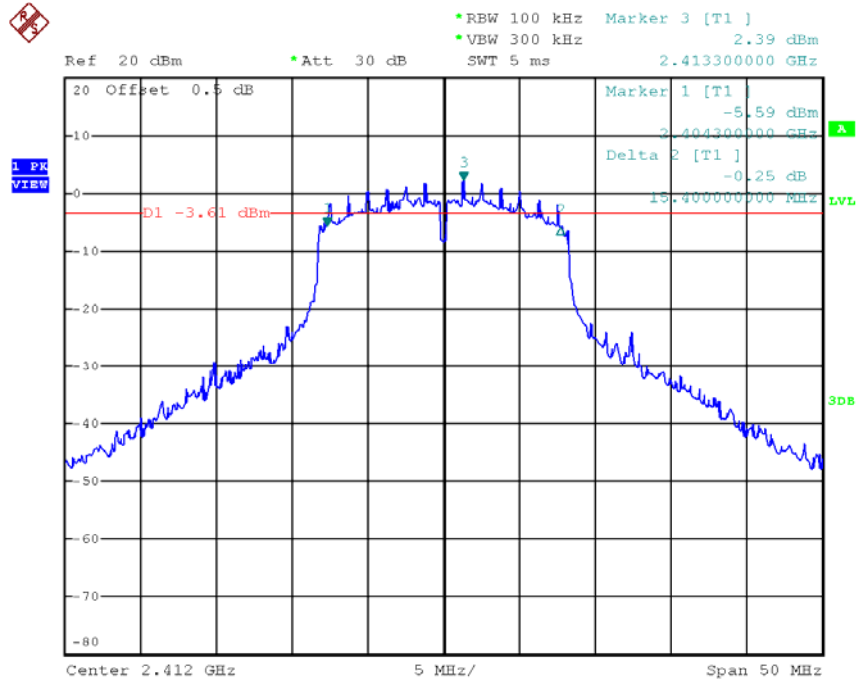

802.11g, Middle Channel

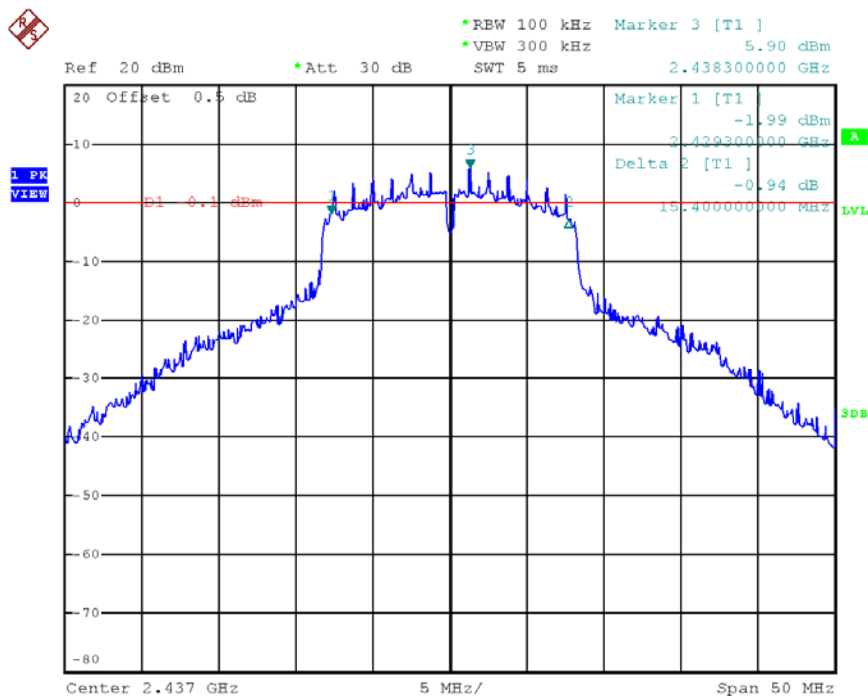

**TEST REPORT**

**PLOTS OF 6dB RF BANDWIDTH**

802.11g, Highest Channel

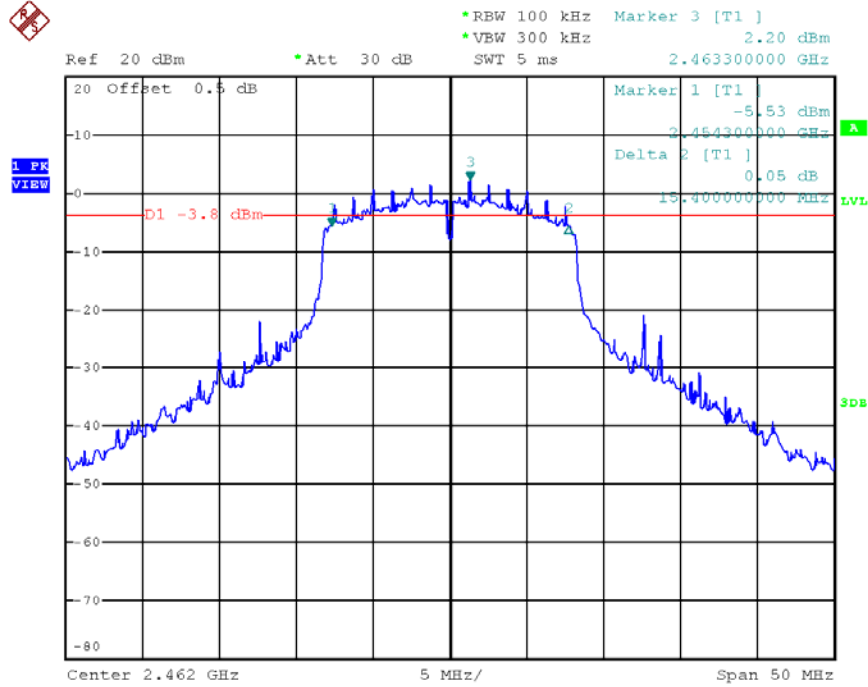



**TEST REPORT**

**PLOTS OF 6dB RF BANDWIDTH**

802.11n (20MHz), Lowest Channel

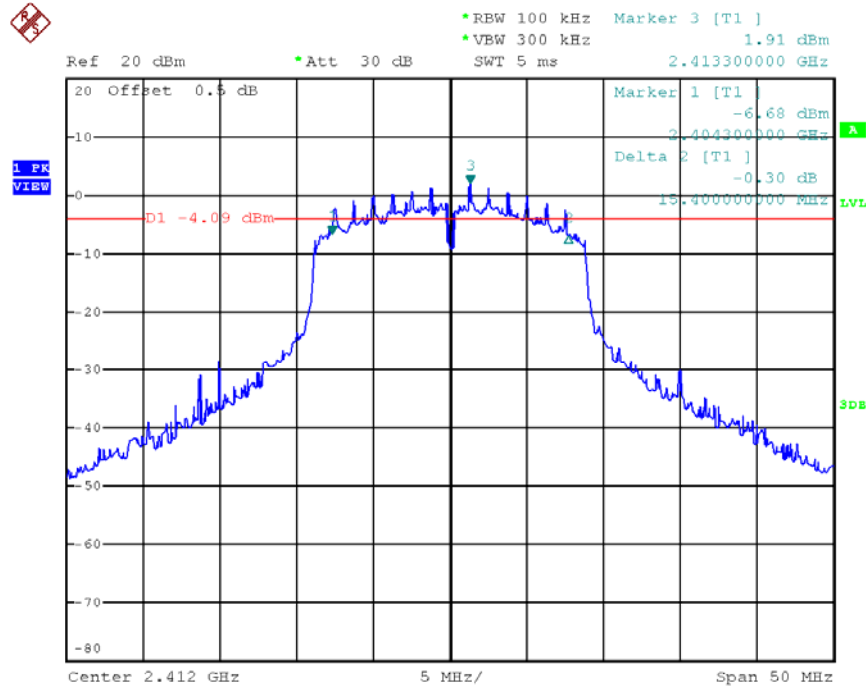

802.11n (20MHz), Middle Channel

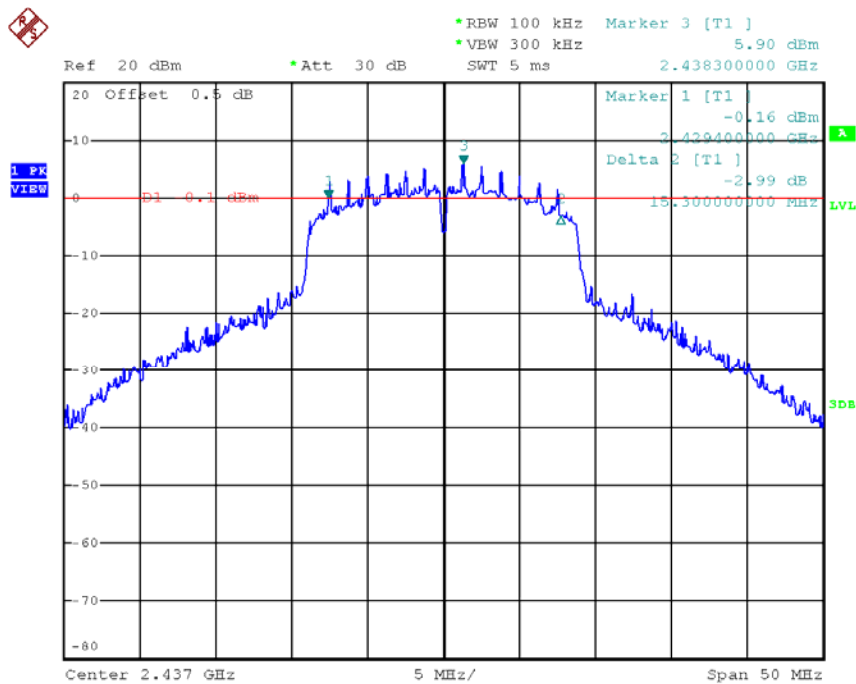

## TEST REPORT

### PLOTS OF 6dB RF BANDWIDTH

802.11n (20MHz), Highest Channel

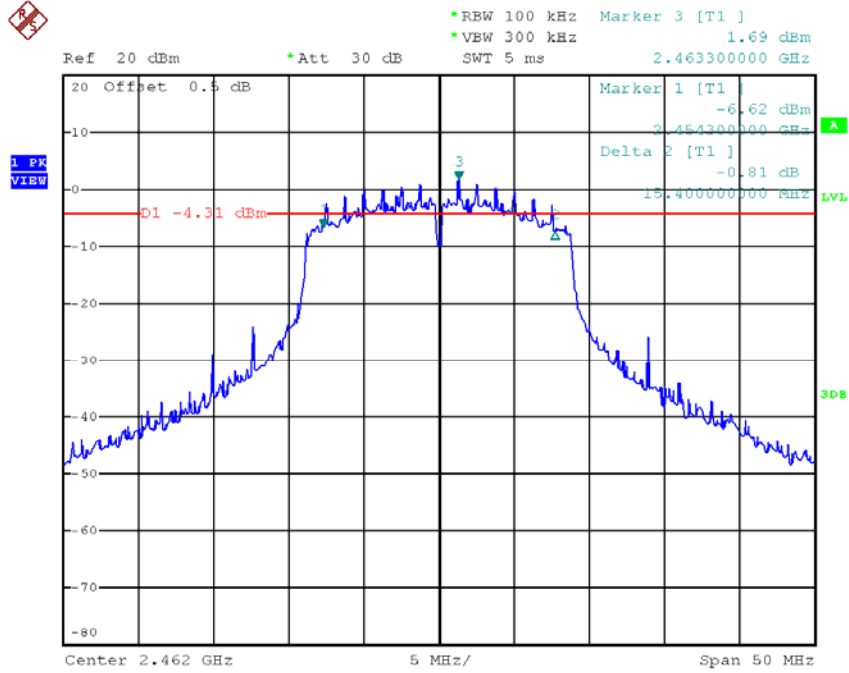

**TEST REPORT**

## 4.3 Maximum Power Spectral Density

Antenna output of the EUT was coupled directly to spectrum analyzer. The measurement procedure 10.2 PKPSD was used. If an external attenuator and/or cable was used, these losses are compensated for using the OFFSET function of the analyser.

## IEEE 802.11b (DSSS, 1 Mbps)

Frequency (MHz)	PSD in 100kHz (dBm)	
Low Channel:	2412	4.00
Middle Channel:	2437	5.83
High Channel:	2462	5.17

## IEEE 802.11g (OFDM, 6 Mbps)

Frequency (MHz)	PSD in 100kHz (dBm)	
Low Channel:	2412	2.38
Middle Channel:	2437	5.85
High Channel:	2462	2.17

## IEEE 802.11n (20MHz) (OFDM, MCS0)

Frequency (MHz)	PSD in 100kHz (dBm)	
Low Channel:	2412	1.88
Middle Channel:	2437	6.00
High Channel:	2462	1.71

Cable Loss: 0.5 dB

Limit:  
8dBm

The plots of power spectral density are as below.

## TEST REPORT

### PLOTS OF POWER SPECTRAL DENSITY

802.11b, Lowest channel

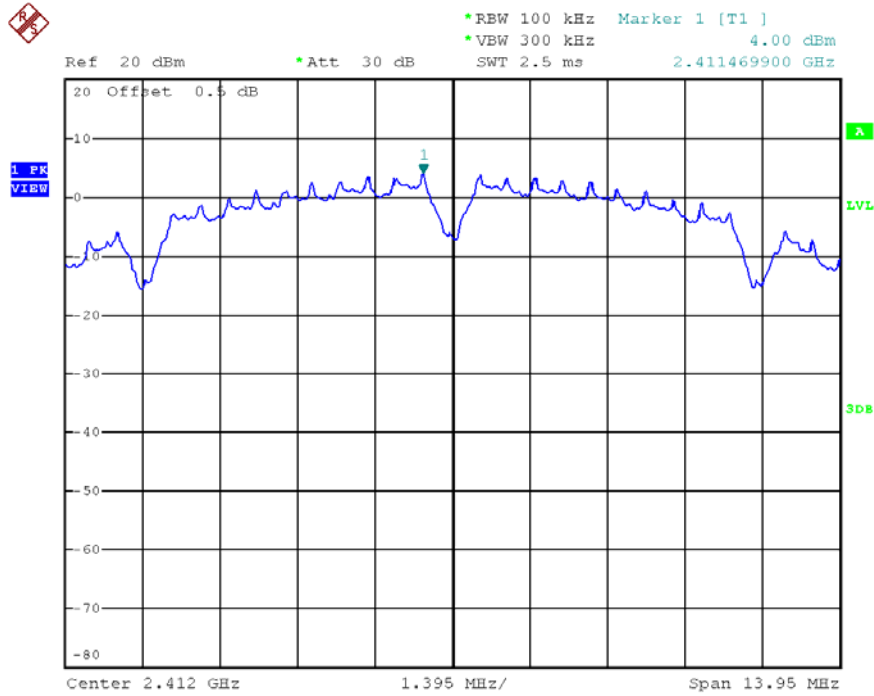

802.11b, Middle channel

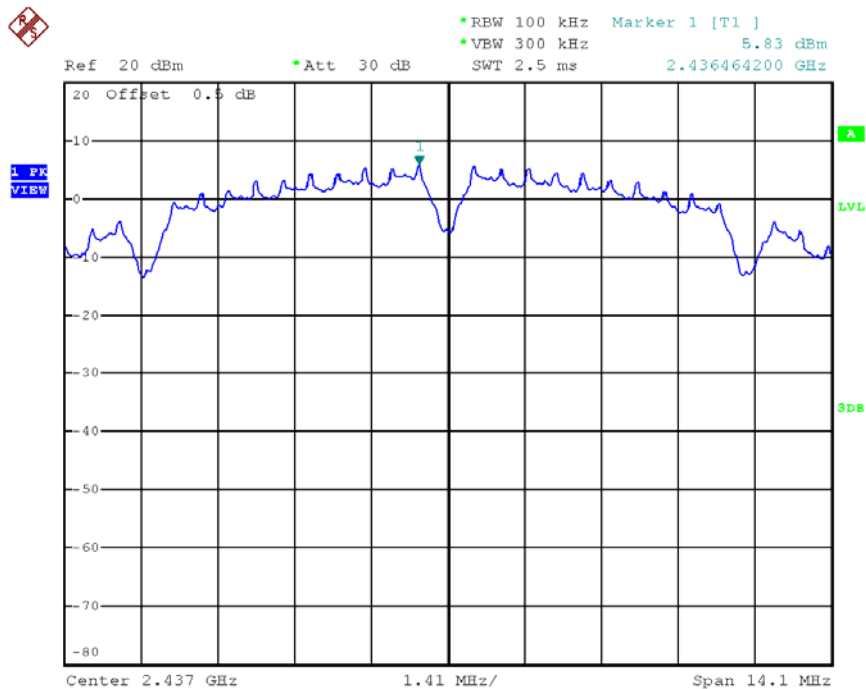

**TEST REPORT**

**PLOTS OF POWER SPECTRAL DENSITY**

802.11b, Highest channel

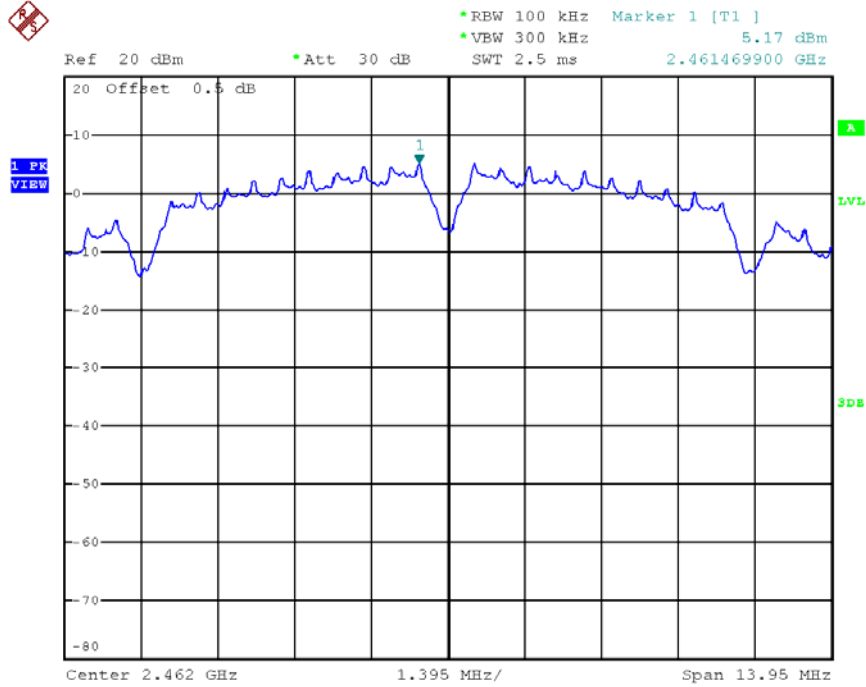

## TEST REPORT

### PLOTS OF POWER SPECTRAL DENSITY

802.11g, Lowest channel

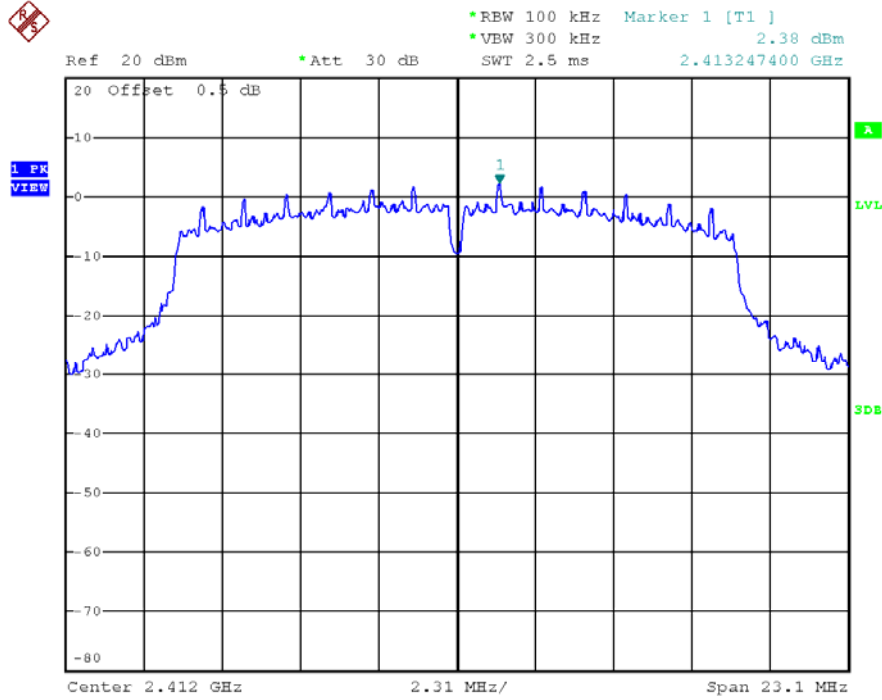

802.11g, Middle channel

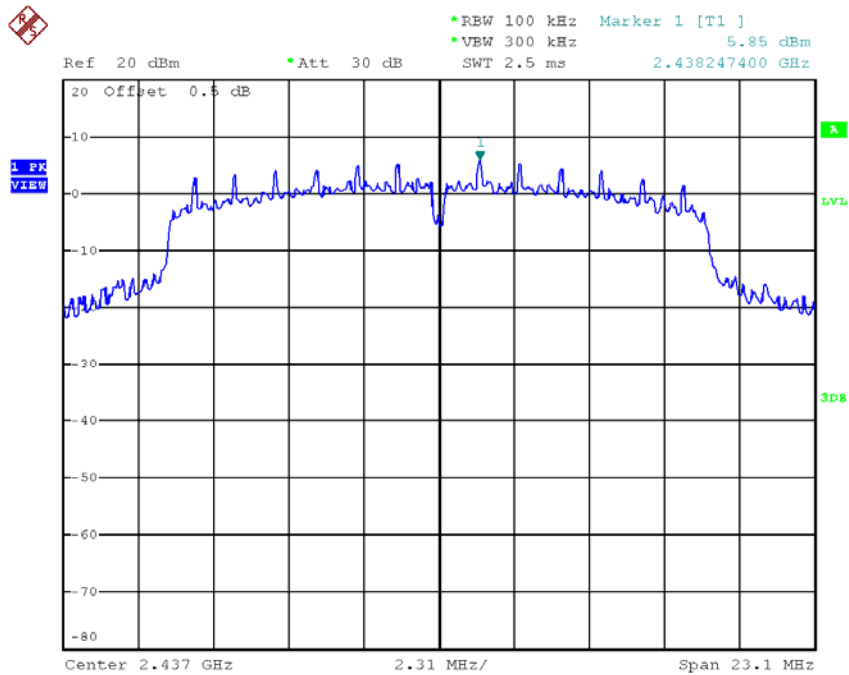

## TEST REPORT

### PLOTS OF POWER SPECTRAL DENSITY

802.11g, Highest channel

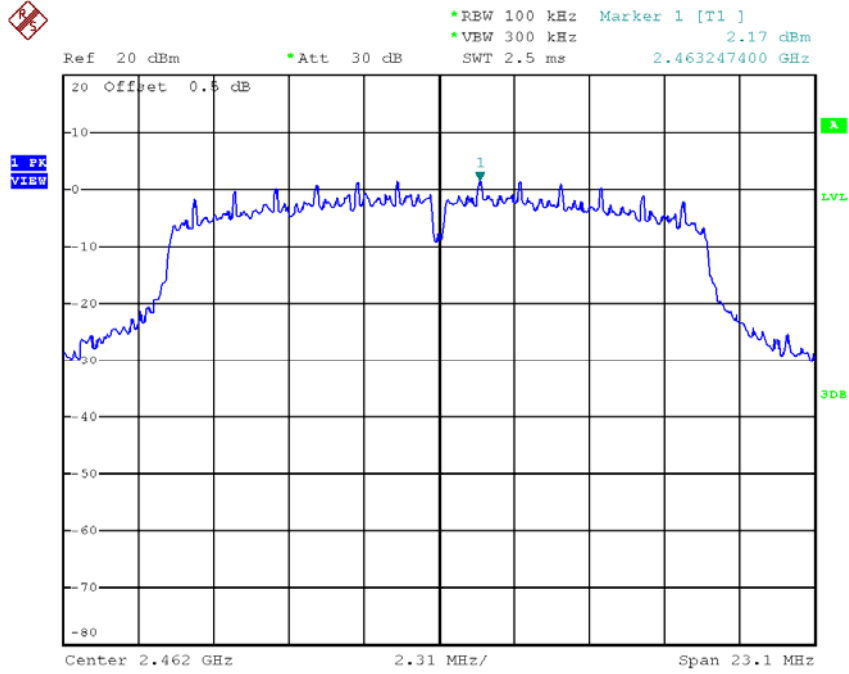

## TEST REPORT

### PLOTS OF POWER SPECTRAL DENSITY

802.11n (20MHz), Lowest channel

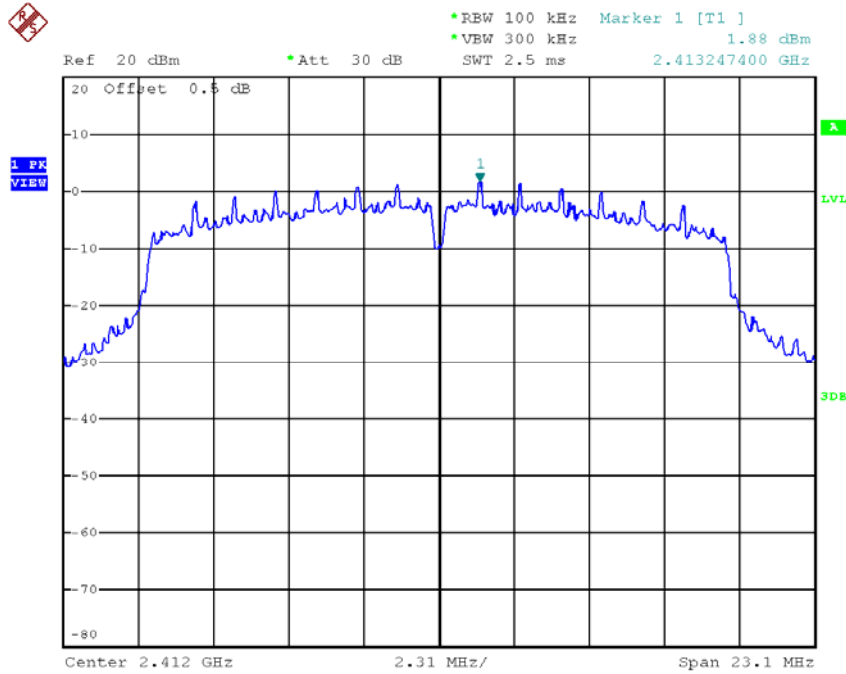

802.11n (20MHz), Middle channel

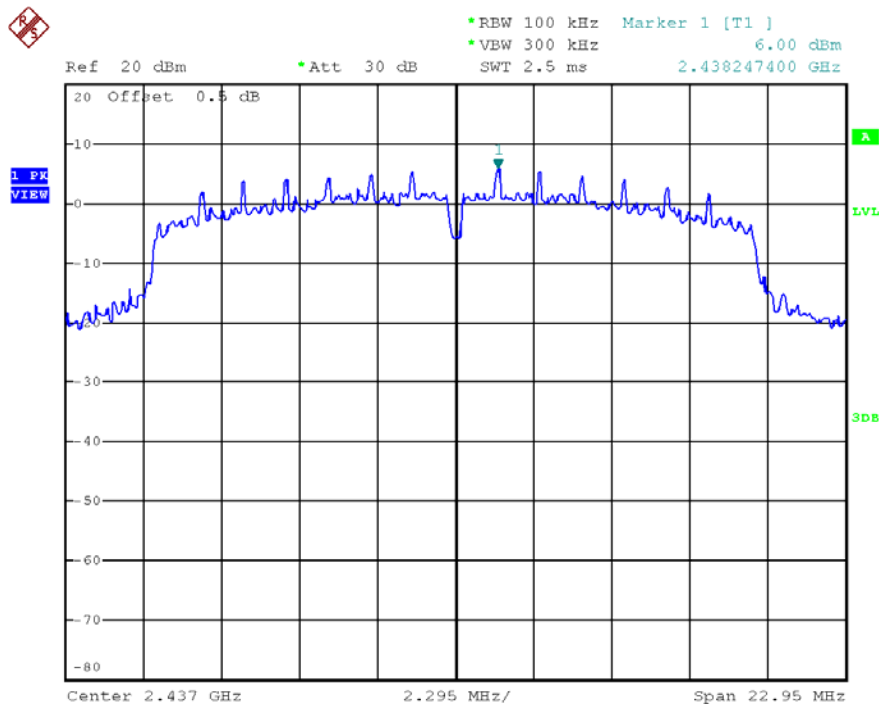



## TEST REPORT

### PLOTS OF POWER SPECTRAL DENSITY

802.11n (20MHz), Highest channel

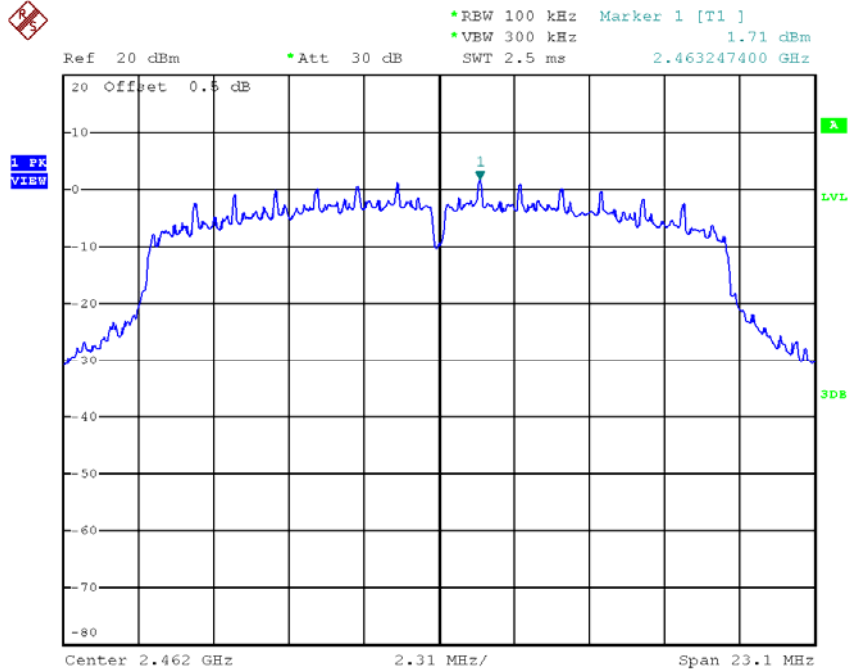

**TEST REPORT****4.4 Out of Band Conducted Emissions**

For 802.11b/g/n20MHz, the maximum conducted (peak) output power was used to demonstrate compliance as described in 9.1. Then the display line (in red) shown in the following plots denotes the limit at 20dB below maximum measured in-band peak PSD level in 100 KHz bandwidth for 802.11b/g/n20MHz.

The measurement procedures under sections 11 of KDB558074 D01 v04 (05-April-2017) were used.

Furthermore, delta measurement technique for measuring bandedge emissions was incorporated in the test of the edge at 2483.5MHz.

**Limits:**

All spurious emission and up to the tenth harmonic was measured and they were found to be at least for 802.11b,g,n20MHz below the maximum measured in-band peak PSD level.

## TEST REPORT

### PLOTS OF OUT OF BAND CONDUCTED EMISSIONS

802.11b, Lowest Channel

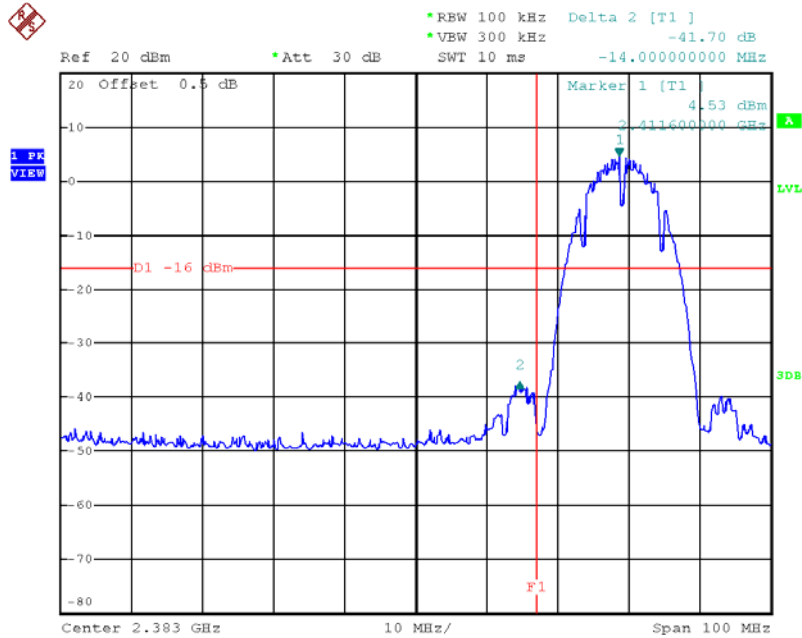

802.11b, Highest Channel

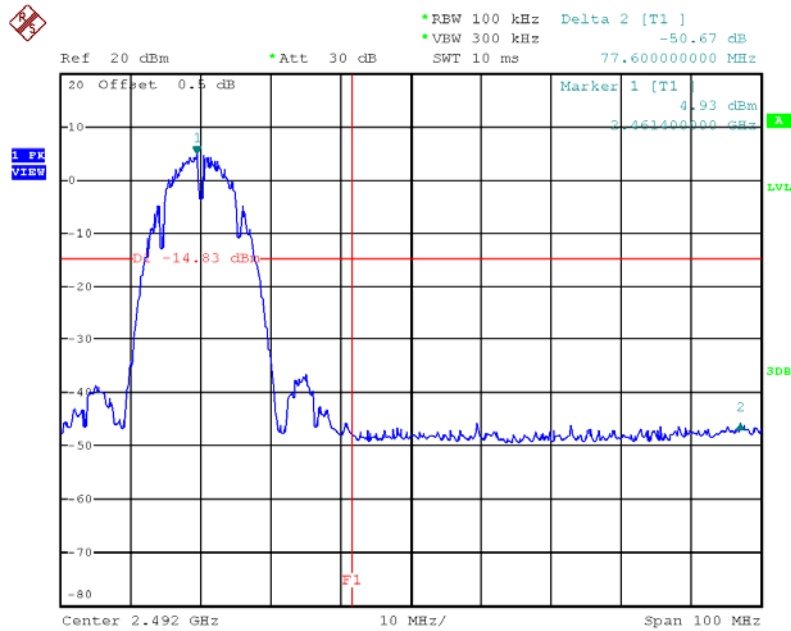

## TEST REPORT

### PLOTS OF OUT OF BAND CONDUCTED EMISSIONS

802.11b, Lowest Channel, Plot A

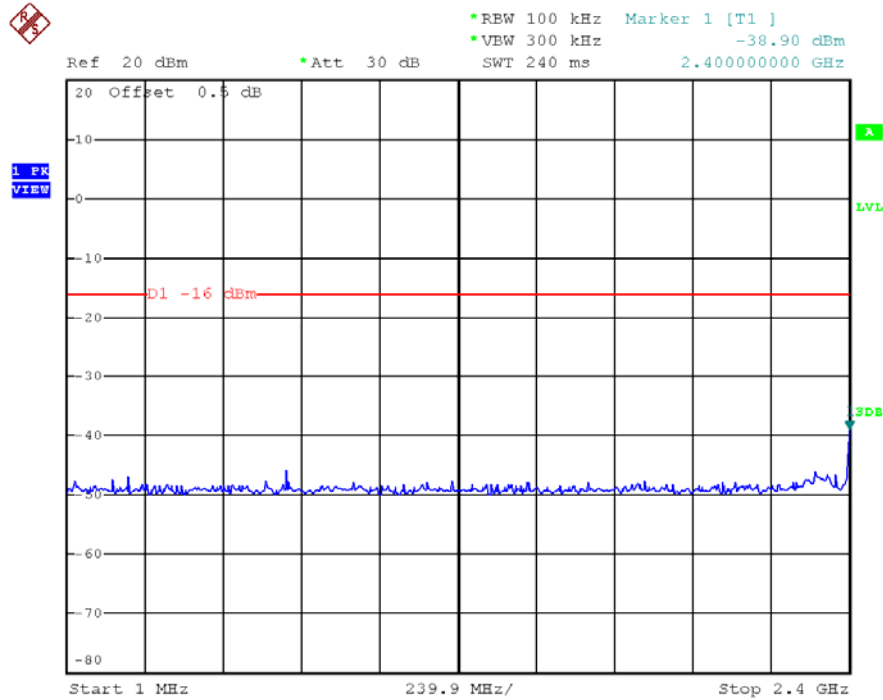

802.11b, Lowest Channel, Plot B

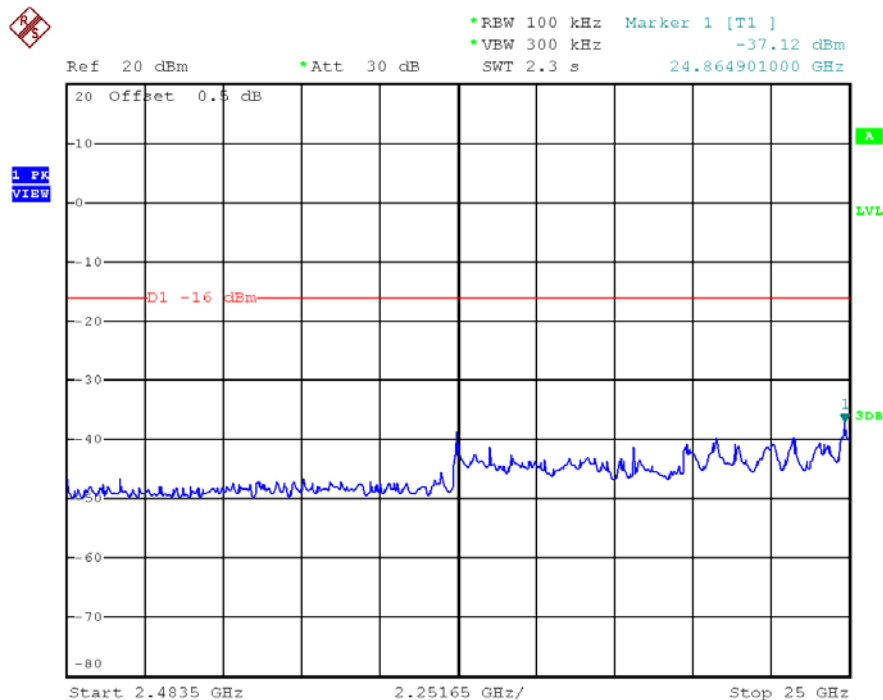

## TEST REPORT

### PLOTS OF OUT OF BAND CONDUCTED EMISSIONS

802.11b, Middle Channel, Plot A

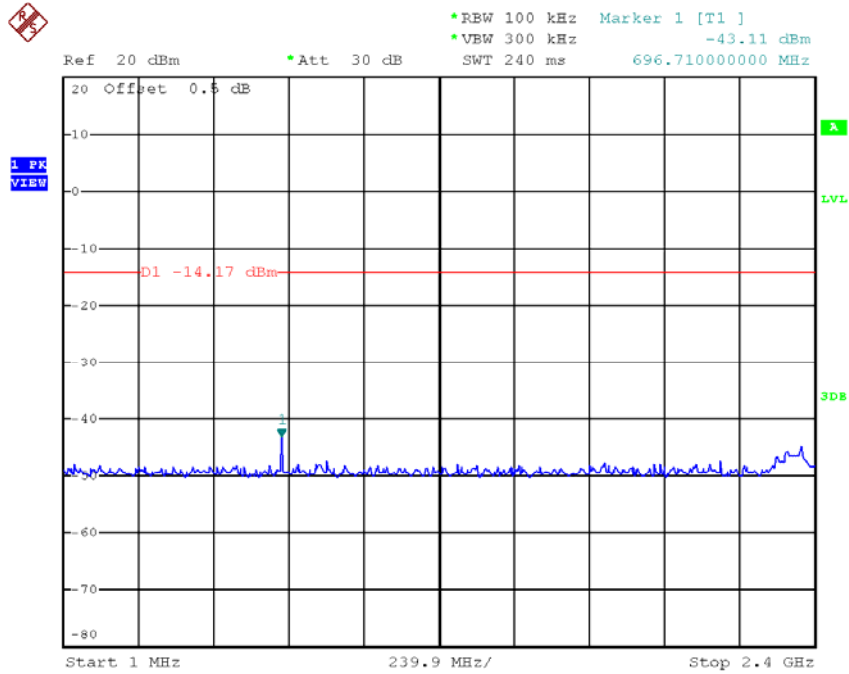

802.11b, Middle Channel, Plot B

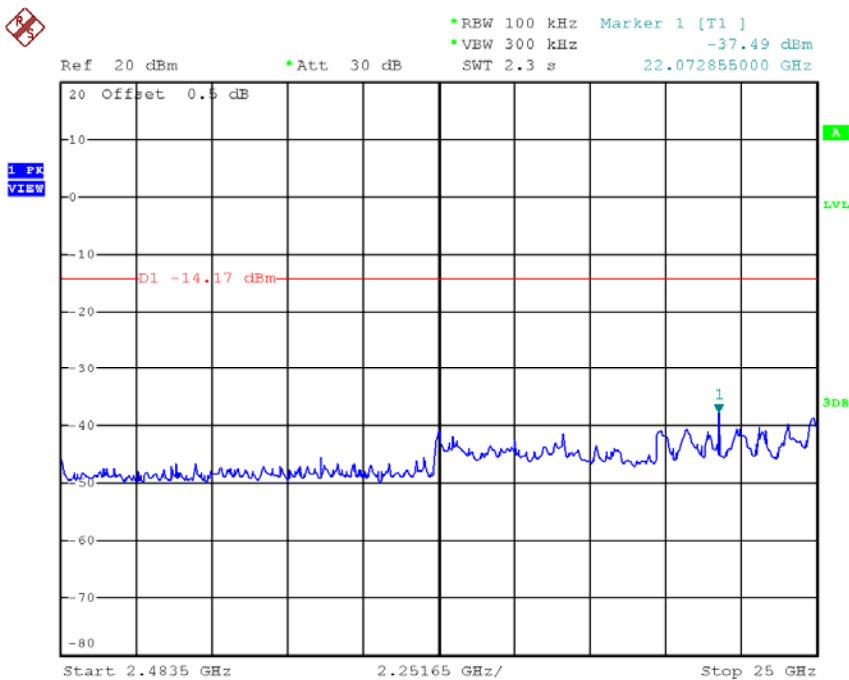

## TEST REPORT

### PLOTS OF OUT OF BAND CONDUCTED EMISSIONS

802.11b, Highest Channel, Plot A

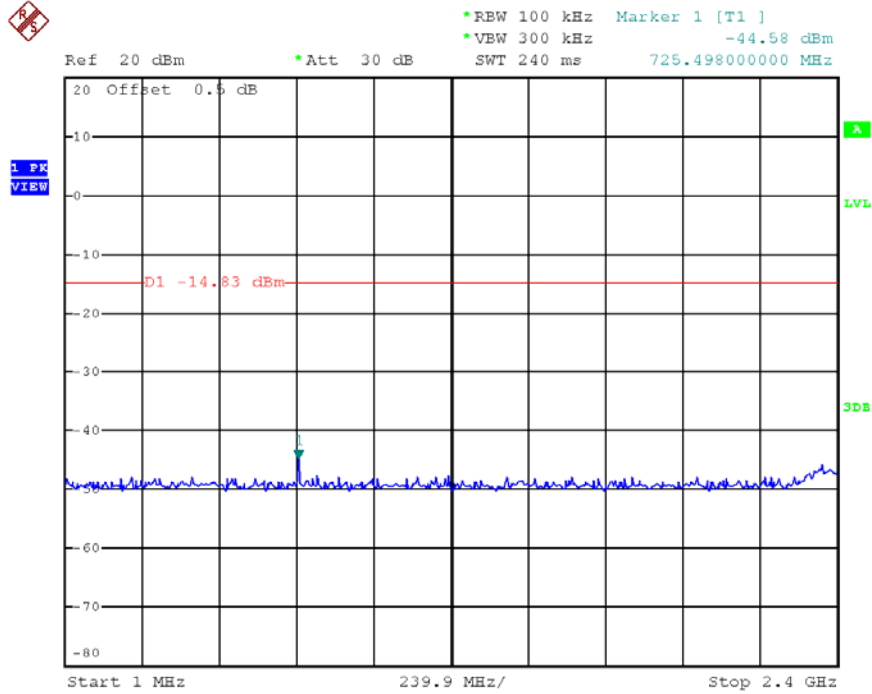

802.11b, Highest Channel, Plot B

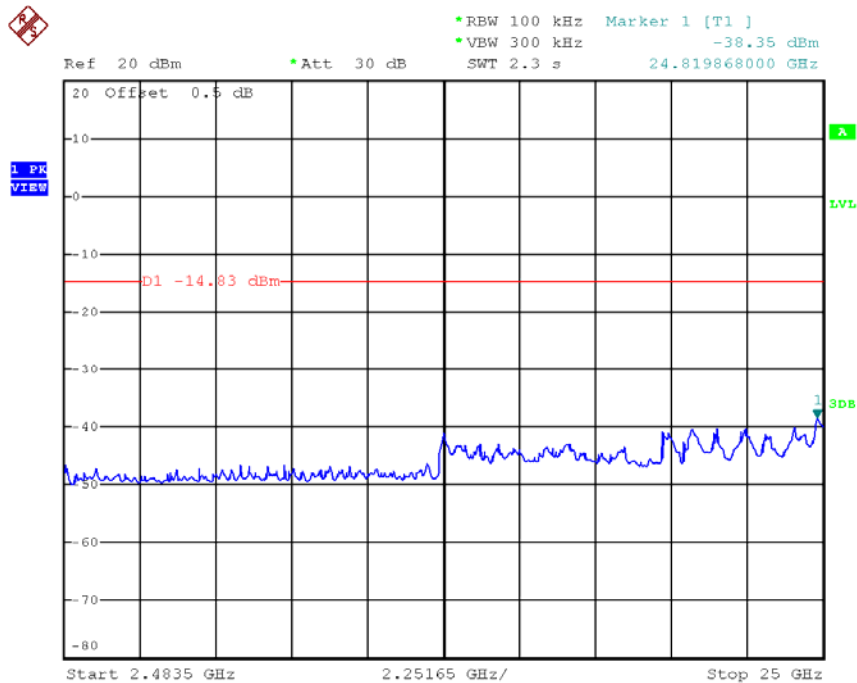

TEST REPORT

PLOTS OF OUT OF BAND CONDUCTED EMISSIONS

802.11g, Lowest Channel

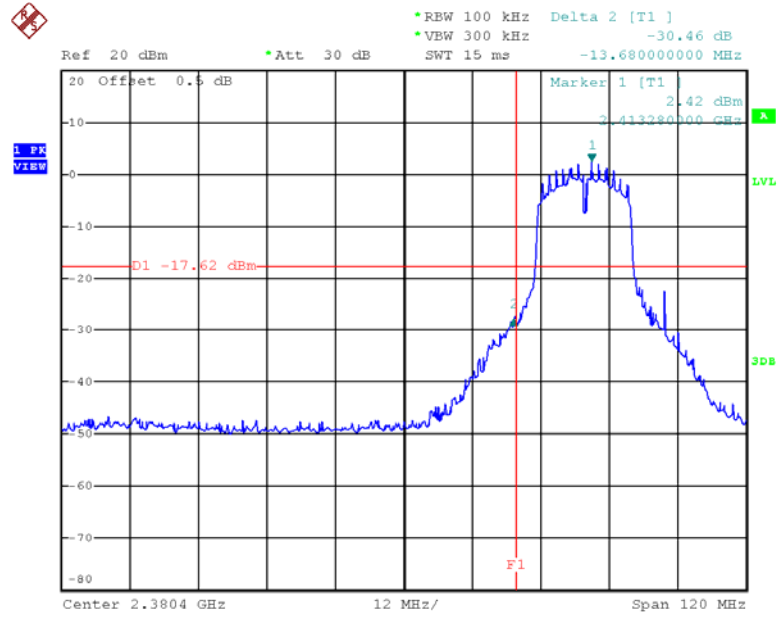

802.11g, Highest Channel

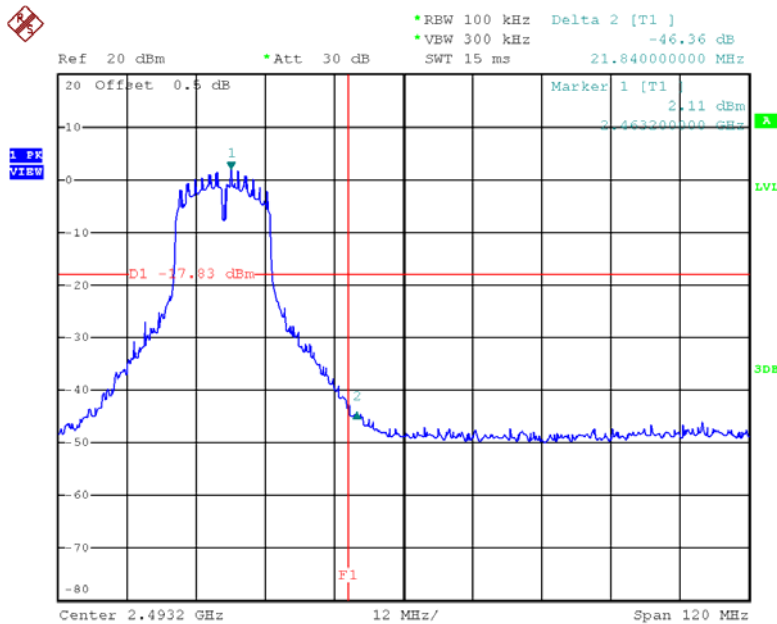

## TEST REPORT

### PLOTS OF OUT OF BAND CONDUCTED EMISSIONS

802.11g, Lowest Channel, Plot A

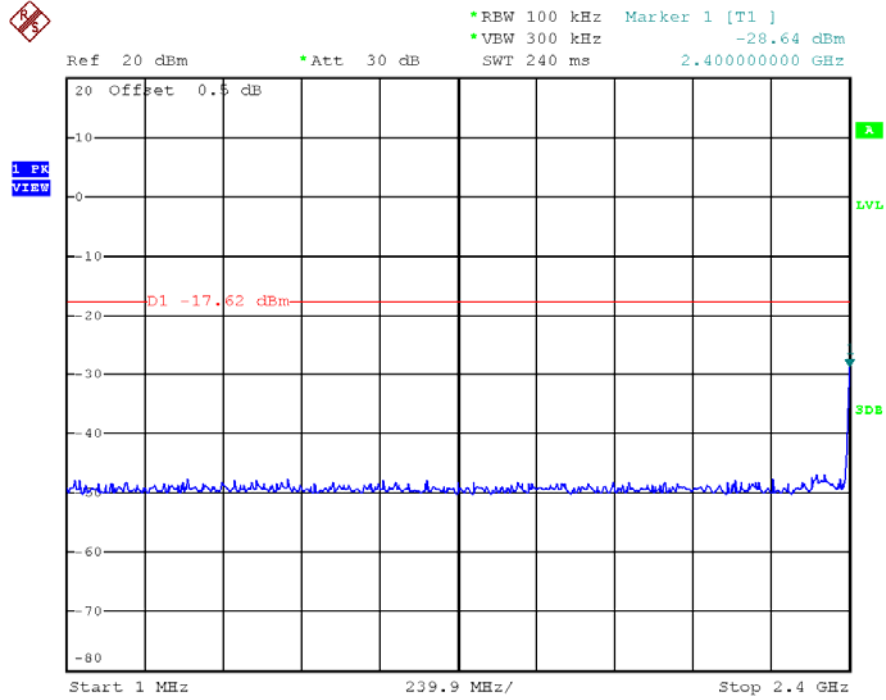

802.11g, Lowest Channel, Plot B

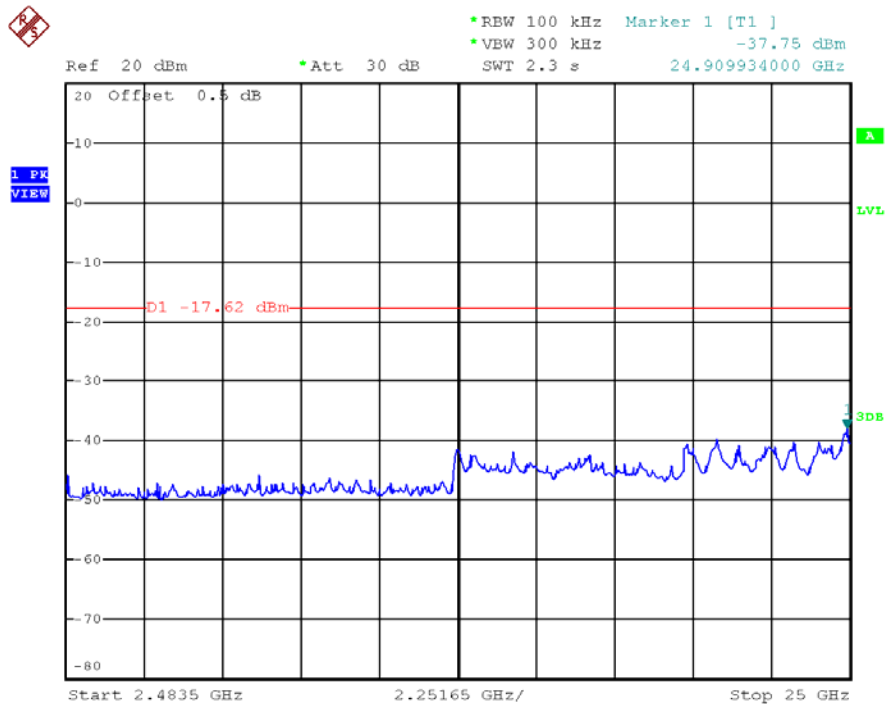



## TEST REPORT

### PLOTS OF OUT OF BAND CONDUCTED EMISSIONS

802.11g, Middle Channel, Plot A

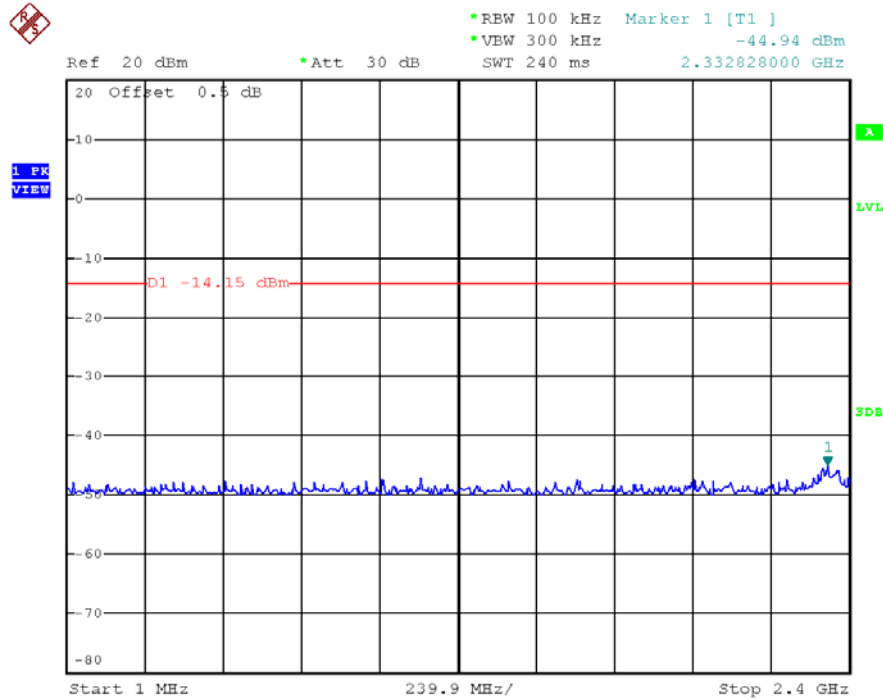

802.11g, Middle Channel, Plot B

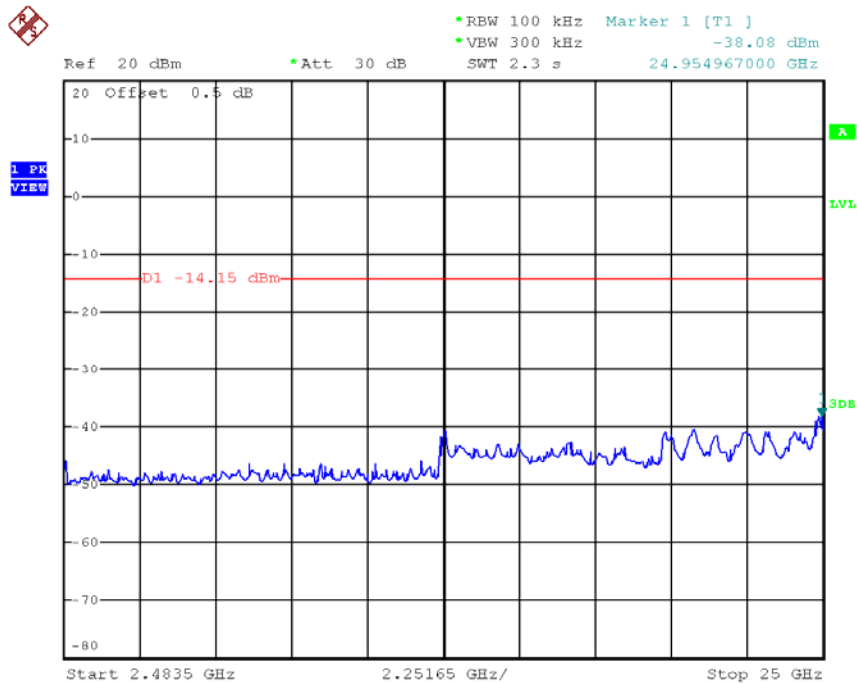

## TEST REPORT

### PLOTS OF OUT OF BAND CONDUCTED EMISSIONS

802.11g, Highest Channel, Plot A

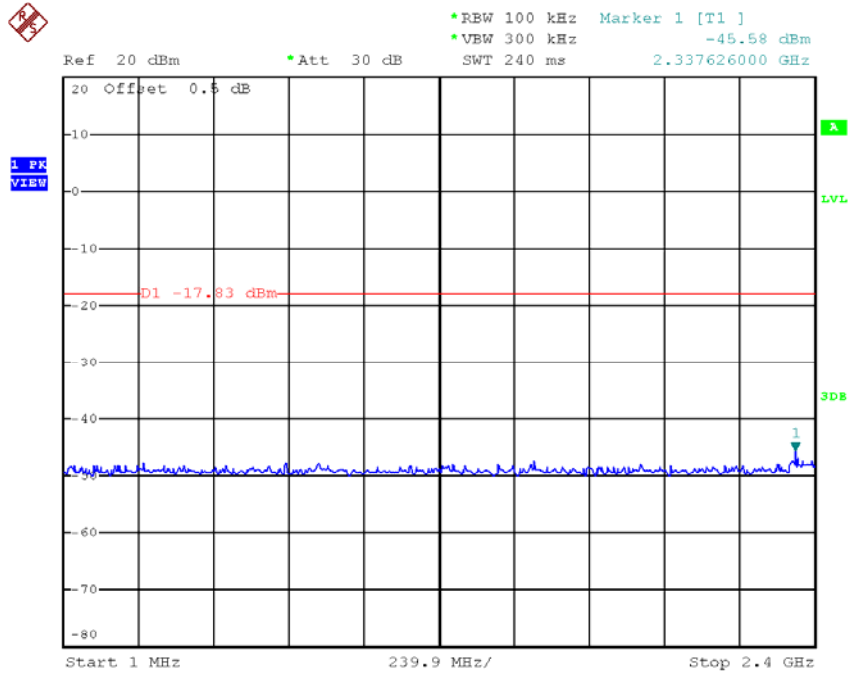

802.11g, Highest Channel, Plot B

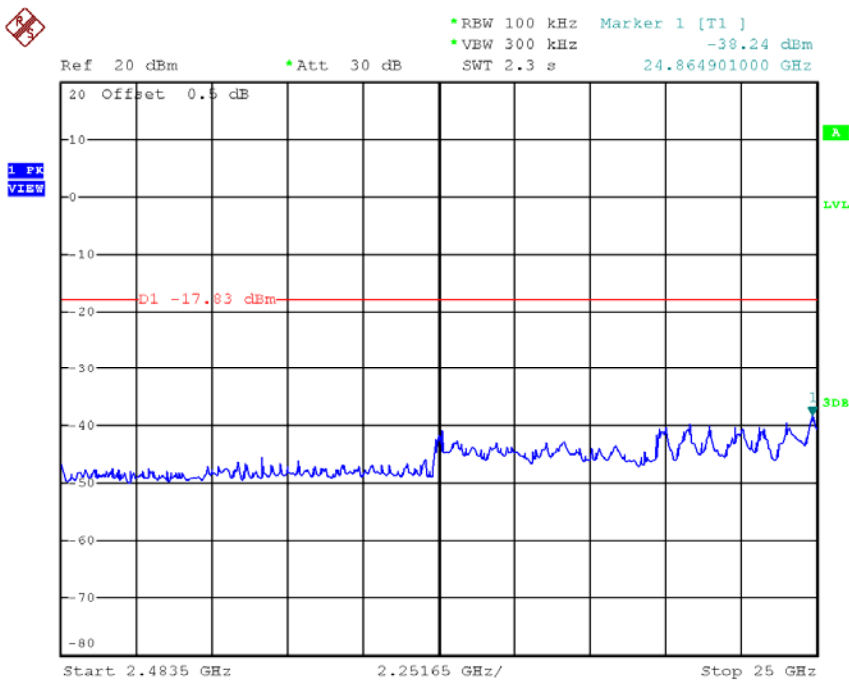

## TEST REPORT

### PLOTS OF OUT OF BAND CONDUCTED EMISSIONS

802.11n (20MHz), Lowest Channel

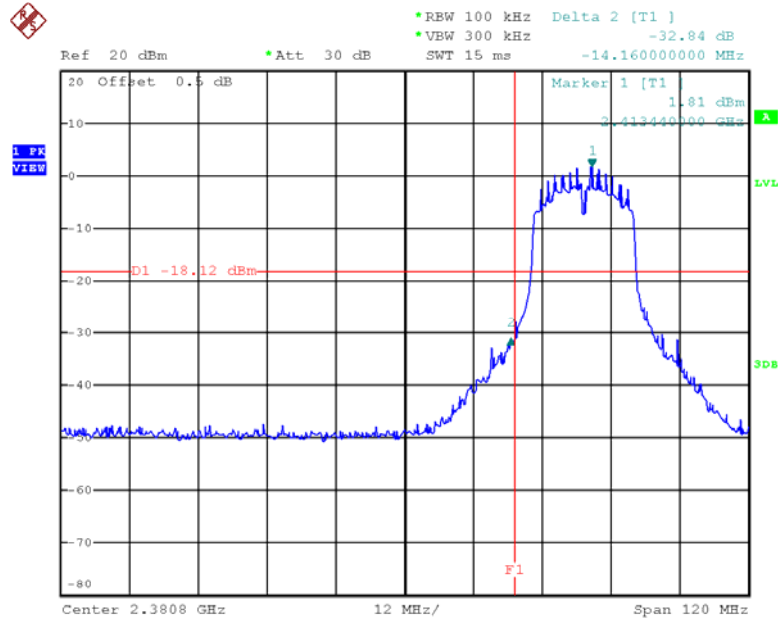

802.11n (20MHz), Highest Channel

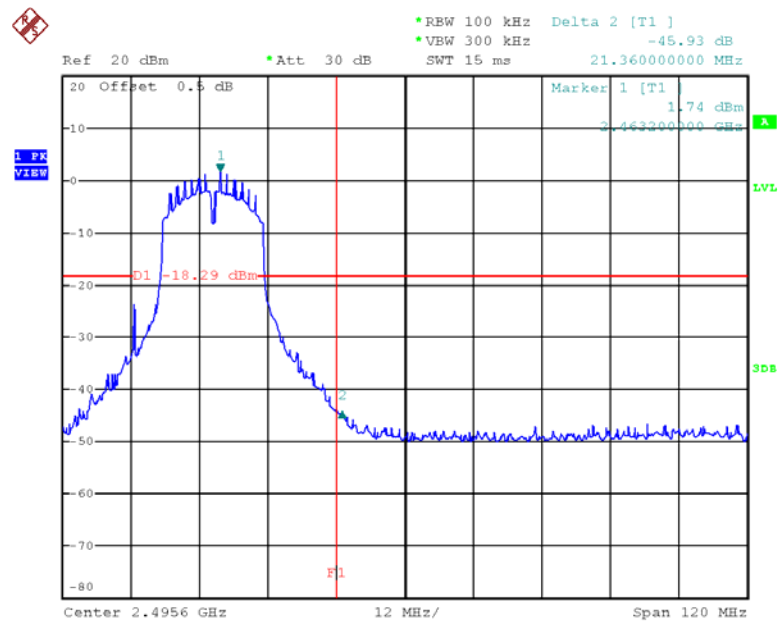

## TEST REPORT

### PLOTS OF OUT OF BAND CONDUCTED EMISSIONS

802.11n (20MHz), Lowest Channel, Plot A

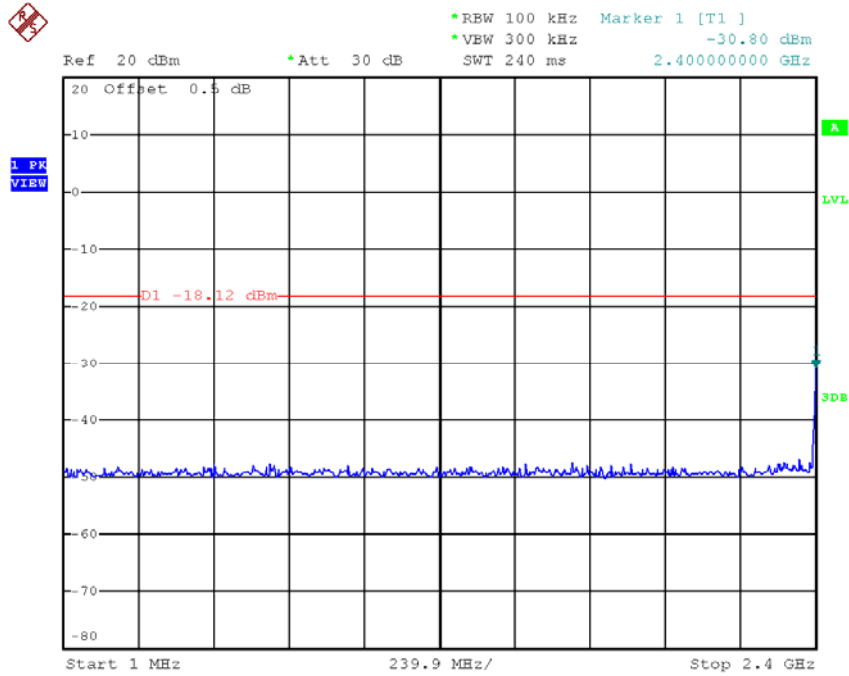

802.11n (20MHz), Lowest Channel, Plot B

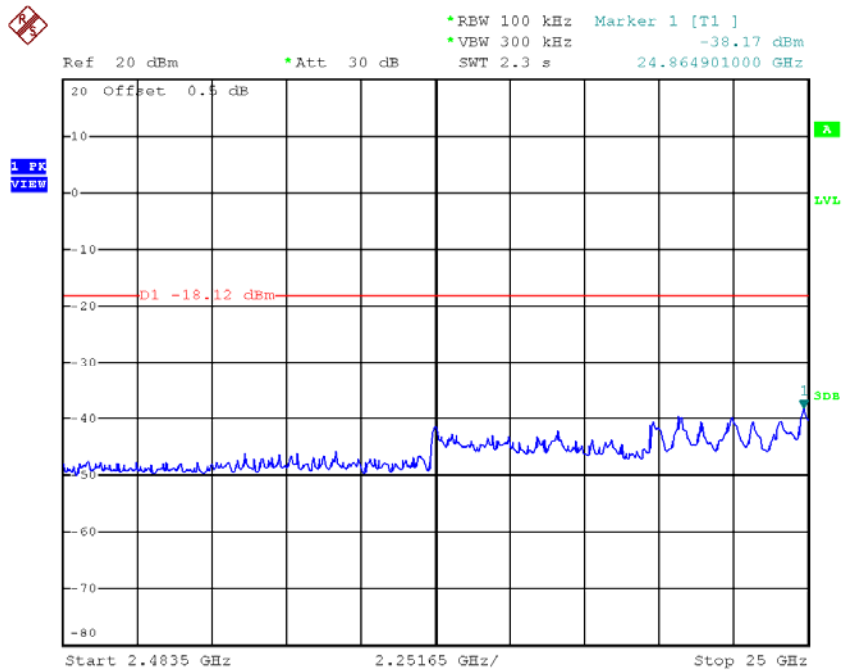

## TEST REPORT

### PLOTS OF OUT OF BAND CONDUCTED EMISSIONS

802.11n (20MHz), Middle Channel, Plot A

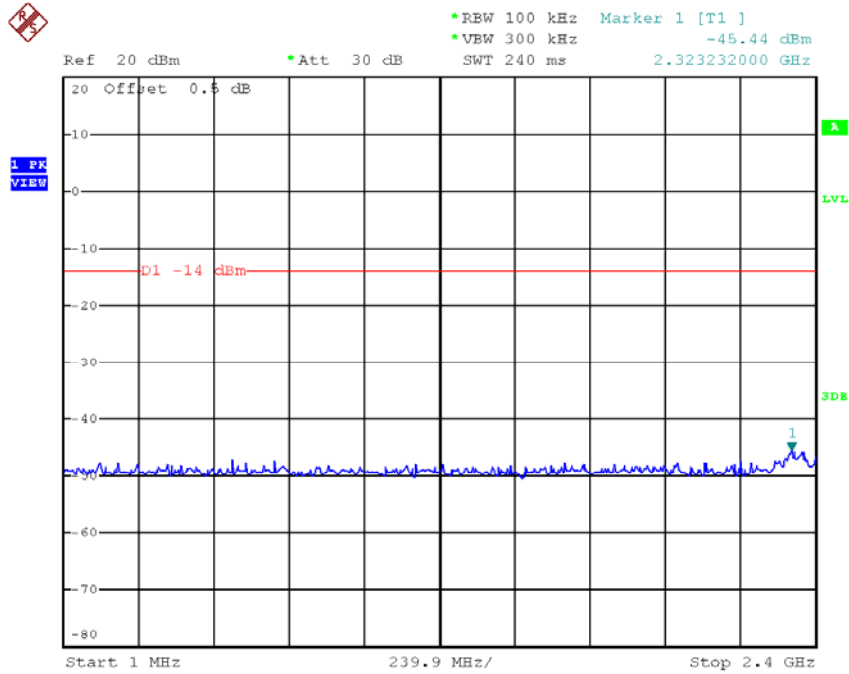

802.11n (20MHz), Middle Channel, Plot B

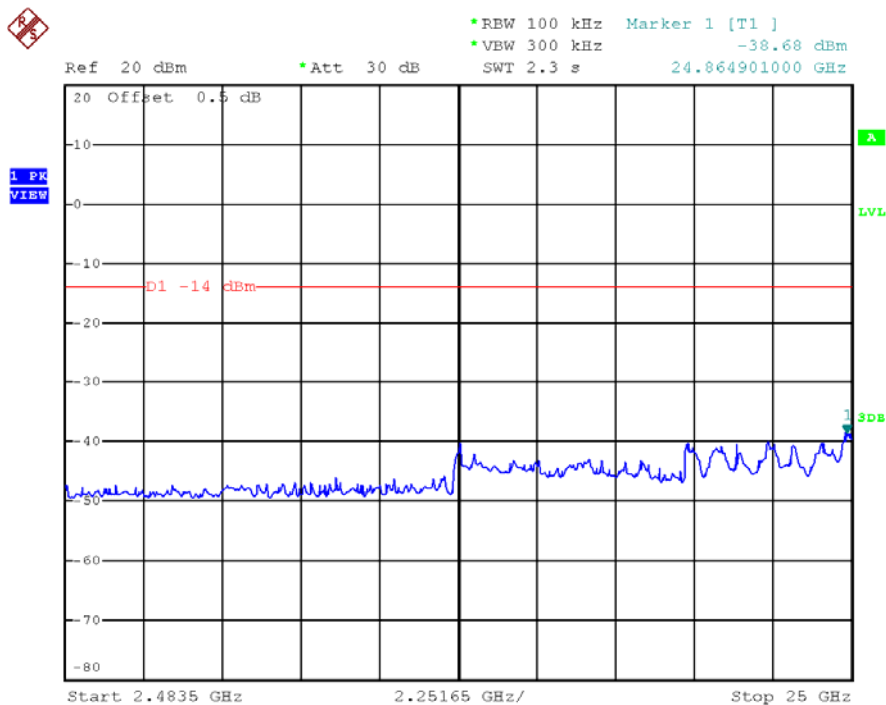

## TEST REPORT

### PLOTS OF OUT OF BAND CONDUCTED EMISSIONS

802.11n (20MHz), Highest Channel, Plot A

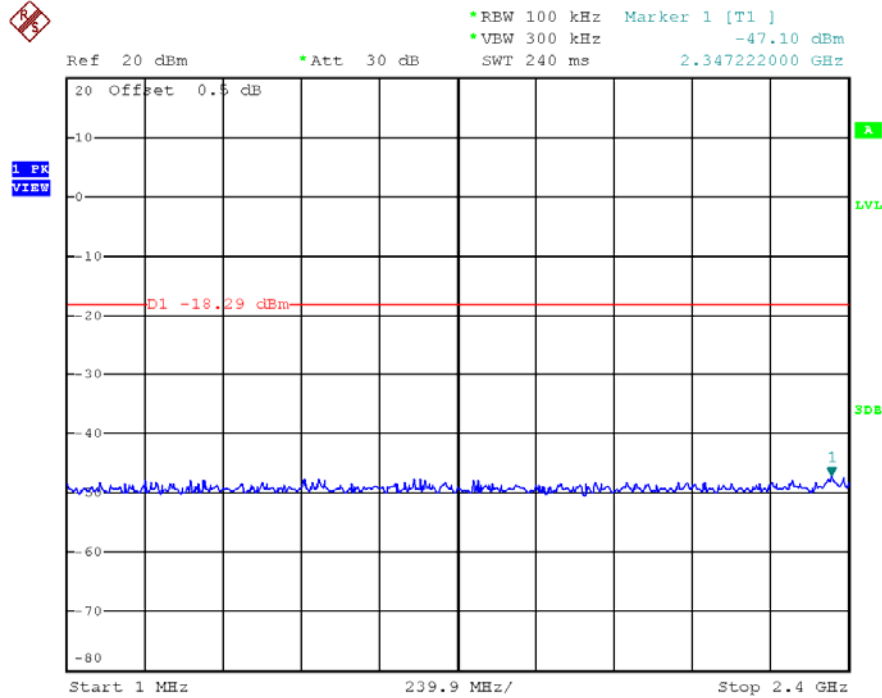

802.11n (20MHz), Highest Channel, Plot B

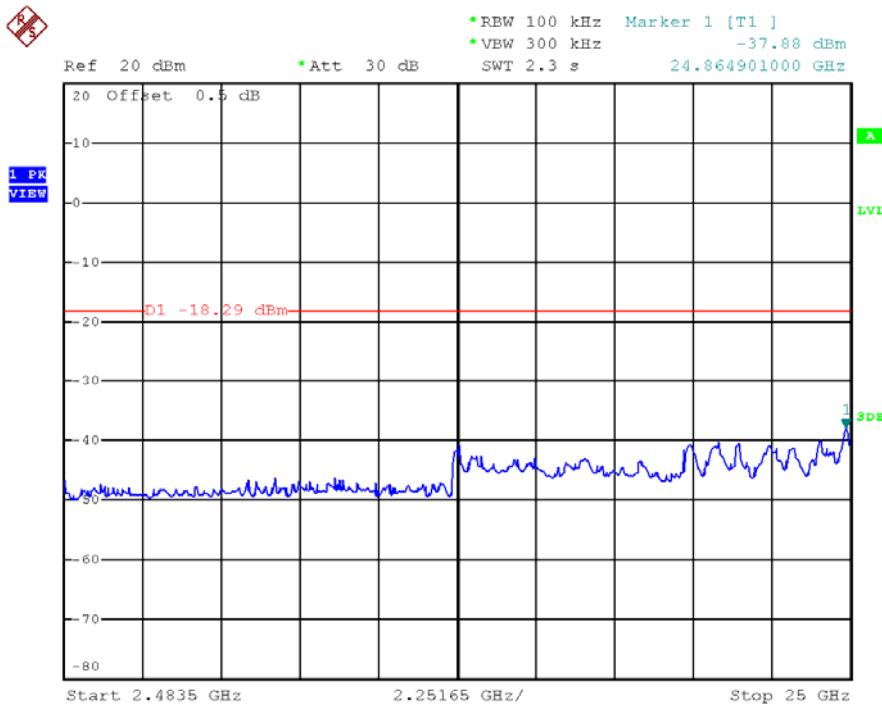

**TEST REPORT**

## 4.5 Field Strength Calculation

The field strength is calculated by adding the reading on the Spectrum Analyzer to the factors associated with preamplifiers (if any), antennas, cables, pulse desensitization and average factors (when specified limit is in average and measurements are made with peak detectors). A sample calculation is included below.

$$FS = RA + AF + CF - AG + PD + AV$$

Where FS = Field Strength in dB $\mu$ V/m

RA = Receiver Amplitude (including preamplifier) in dB $\mu$ V

CF = Cable Attenuation Factor in dB

AF = Antenna Factor in dB

AG = Amplifier Gain in dB

PD = Pulse Desensitization in dB

AV = Average Factor in -dB

In the radiated emission table which follows, the reading shown on the data table may reflect the preamplifier gain. An example of the calculations, where the reading does not reflect the preamplifier gain, follows:

$$FS = RA + AF + CF - AG + PD + AV$$

Example

Assume a receiver reading of 62.0 dB $\mu$ V is obtained. The antenna factor of 7.4 dB and cable factor of 1.6 dB is added. The amplifier gain of 29.0 dB is subtracted. The pulse desensitization factor of the spectrum analyzer is 0.0 dB, and the resultant average factor is -10.0 dB. The net field strength for comparison to the appropriate emission limit is 32.0 dB $\mu$ V/m. This value in dB $\mu$ V/m is converted to its corresponding level in  $\mu$ V/m.

$$RA = 62.0 \text{ dB}\mu\text{V}$$

$$AF = 7.4 \text{ dB}$$

$$CF = 1.6 \text{ dB}$$

$$AG = 29.0 \text{ dB}$$

$$PD = 0.0 \text{ dB}$$

$$AV = -10 \text{ dB}$$

$$FS = 62.0 + 7.4 + 1.6 - 29.0 + 0.0 + (-10.0) = 32.0 \text{ dB}\mu\text{V/m}$$

$$\text{Level in } \mu\text{V/m} = \text{Common Antilogarithm } [(32.0 \text{ dB}\mu\text{V/m})/20] = 39.8 \mu\text{V/m}$$

**TEST REPORT****4.6 Transmitter Radiated Emissions in Restricted Bands and Spurious Emissions**

Data is included of the worst case configuration (the configuration which resulted in the highest emission levels). A sample calculation, configuration photographs and data tables of the emissions are included.

The data on the following pages list the significant emission frequencies, the limit and the margin of compliance.

**4.6.1 Radiated Emission Configuration Photograph**

Worst Case Restricted Band Radiated Emission

at

960.230 MHz

The worst case radiated emission configuration photographs are saved with filename: config photos.pdf

**4.6.2 Radiated Emission Data**

The data in tables 1-10 list the significant emission frequencies, the limit and the margin of compliance.

Judgement -

Passed by 3.2 dB margin



**TEST REPORT**

**RADIATED EMISSION DATA**

Mode: TX-Channel 01

Table 1  
IEEE 802.11b (DSSS, 1 Mbps)

Polarization	Frequency (MHz)	Reading (dBμV)	Pre-Amp Gain (dB)	Antenna Factor (dB)	Net at 3m (dBμV/m)	Average Limit at 3m (dBμV/m)	Margin (dB)
<b><i>H</i></b>	<b><i>2390.000</i></b>	<b><i>51.0</i></b>	<b><i>33</i></b>	<b><i>29.4</i></b>	<b><i>47.4</i></b>	<b><i>54.0</i></b>	<b><i>-6.6</i></b>
<b><i>H</i></b>	<b><i>4824.000</i></b>	<b><i>46.3</i></b>	<b><i>33</i></b>	<b><i>34.9</i></b>	<b><i>48.2</i></b>	<b><i>54.0</i></b>	<b><i>-5.8</i></b>
<b><i>H</i></b>	<b><i>12060.000</i></b>	<b><i>31.8</i></b>	<b><i>33</i></b>	<b><i>40.5</i></b>	<b><i>39.3</i></b>	<b><i>54.0</i></b>	<b><i>-14.7</i></b>
<b><i>H</i></b>	<b><i>14472.000</i></b>	<b><i>33.7</i></b>	<b><i>33</i></b>	<b><i>40.0</i></b>	<b><i>40.7</i></b>	<b><i>54.0</i></b>	<b><i>-13.3</i></b>

Polarization	Frequency (MHz)	Reading (dBμV)	Pre-Amp Gain (dB)	Antenna Factor (dB)	Net at 3m - Peak (dBμV/m)	Peak Limit at 3m (dBμV/m)	Margin (dB)
<b><i>H</i></b>	<b><i>2390.000</i></b>	<b><i>60.4</i></b>	<b><i>33</i></b>	<b><i>29.4</i></b>	<b><i>56.8</i></b>	<b><i>74.0</i></b>	<b><i>-17.2</i></b>
<b><i>H</i></b>	<b><i>4824.000</i></b>	<b><i>52.5</i></b>	<b><i>33</i></b>	<b><i>34.9</i></b>	<b><i>54.4</i></b>	<b><i>74.0</i></b>	<b><i>-19.6</i></b>
<b><i>H</i></b>	<b><i>12060.000</i></b>	<b><i>43.8</i></b>	<b><i>33</i></b>	<b><i>40.5</i></b>	<b><i>51.3</i></b>	<b><i>74.0</i></b>	<b><i>-22.7</i></b>
<b><i>H</i></b>	<b><i>14472.000</i></b>	<b><i>45.4</i></b>	<b><i>33</i></b>	<b><i>40.0</i></b>	<b><i>52.4</i></b>	<b><i>74.0</i></b>	<b><i>-21.6</i></b>

- NOTES:
1. Peak detector is used for the emission measurement.
  2. Average detector is used for the average data of emission measurement.
  3. All measurements were made at 3 meters. Radiated emissions not detected at the 3-meter distance were measured at 0.3-meter and an inverse proportional extrapolation was performed to compare the signal level to the 3-meter limit. No other radiated emissions than those reported were detected at a test distance of 0.3-meter.
  4. Negative value in the margin column shows emission below limit.
  5. Horn antenna is used for the emission over 1000MHz.
  6. Emission (the row indicated by ***bold italic***) within the restricted band meets the requirement of FCC Part 15 Section 15.205.

**TEST REPORT**

Mode: TX-Channel 06

Table 2  
IEEE 802.11b (DSSS, 1 Mbps)

Polarization	Frequency (MHz)	Reading (dBμV)	Pre-Amp Gain (dB)	Antenna Factor (dB)	Net at 3m (dBμV/m)	Average Limit at 3m (dBμV/m)	Margin (dB)
<b>H</b>	<b>4874.000</b>	<b>46.0</b>	<b>33</b>	<b>34.9</b>	<b>47.9</b>	<b>54.0</b>	<b>-6.1</b>
<b>H</b>	<b>7311.000</b>	<b>32.1</b>	<b>33</b>	<b>37.9</b>	<b>37.0</b>	<b>54.0</b>	<b>-17.0</b>
<b>H</b>	<b>12185.000</b>	<b>31.9</b>	<b>33</b>	<b>40.5</b>	<b>39.4</b>	<b>54.0</b>	<b>-14.6</b>

Polarization	Frequency (MHz)	Reading (dBμV)	Pre-Amp Gain (dB)	Antenna Factor (dB)	Net at 3m - Peak (dBμV/m)	Peak Limit at 3m (dBμV/m)	Margin (dB)
<b>H</b>	<b>4874.000</b>	<b>52.2</b>	<b>33</b>	<b>34.9</b>	<b>54.1</b>	<b>74.0</b>	<b>-19.9</b>
<b>H</b>	<b>7311.000</b>	<b>42.4</b>	<b>33</b>	<b>37.9</b>	<b>47.3</b>	<b>74.0</b>	<b>-26.7</b>
<b>H</b>	<b>12185.000</b>	<b>44.0</b>	<b>33</b>	<b>40.5</b>	<b>51.5</b>	<b>74.0</b>	<b>-22.5</b>

- NOTES:
1. Peak detector is used for the emission measurement.
  2. Average detector is used for the average data of emission measurement
  3. All measurements were made at 3 meters. Radiated emissions not detected at the 3-meter distance were measured at 0.3-meter and an inverse proportional extrapolation was performed to compare the signal level to the 3-meter limit. No other radiated emissions than those reported were detected at a test distance of 0.3-meter.
  4. Negative value in the margin column shows emission below limit.
  5. Horn antenna is used for the emission over 1000MHz.
  6. Emission (the row indicated by **bold italic**) within the restricted band meets the requirement of FCC Part 15 Section 15.205.

**TEST REPORT**

Mode: TX-Channel 11

Table 3  
IEEE 802.11b (DSSS, 1 Mbps)

Polarization	Frequency (MHz)	Reading (dBμV)	Pre-Amp Gain (dB)	Antenna Factor (dB)	Net at 3m (dBμV/m)	Average Limit at 3m (dBμV/m)	Margin (dB)
<b>H</b>	<b>2483.500</b>	<b>51.4</b>	<b>33</b>	<b>29.4</b>	<b>47.8</b>	<b>54.0</b>	<b>-6.2</b>
<b>H</b>	<b>4924.000</b>	<b>45.8</b>	<b>33</b>	<b>34.9</b>	<b>47.7</b>	<b>54.0</b>	<b>-6.3</b>
<b>H</b>	<b>7386.000</b>	<b>32.7</b>	<b>33</b>	<b>37.9</b>	<b>37.6</b>	<b>54.0</b>	<b>-16.4</b>
<b>H</b>	<b>12310.000</b>	<b>31.7</b>	<b>33</b>	<b>40.5</b>	<b>39.2</b>	<b>54.0</b>	<b>-14.8</b>

Polarization	Frequency (MHz)	Reading (dBμV)	Pre-Amp Gain (dB)	Antenna Factor (dB)	Net at 3m - Peak (dBμV/m)	Peak Limit at 3m (dBμV/m)	Margin (dB)
<b>H</b>	<b>2483.500</b>	<b>60.7</b>	<b>33</b>	<b>29.4</b>	<b>57.1</b>	<b>74.0</b>	<b>-16.9</b>
<b>H</b>	<b>4924.000</b>	<b>51.8</b>	<b>33</b>	<b>34.9</b>	<b>53.7</b>	<b>74.0</b>	<b>-20.3</b>
<b>H</b>	<b>7386.000</b>	<b>42.8</b>	<b>33</b>	<b>37.9</b>	<b>47.7</b>	<b>74.0</b>	<b>-26.3</b>
<b>H</b>	<b>12310.000</b>	<b>43.6</b>	<b>33</b>	<b>40.5</b>	<b>51.1</b>	<b>74.0</b>	<b>-22.9</b>

- NOTES:
1. Peak detector is used for the emission measurement.
  2. Average detector is used for the average data of emission measurement
  3. All measurements were made at 3 meters. Radiated emissions not detected at the 3-meter distance were measured at 0.3-meter and an inverse proportional extrapolation was performed to compare the signal level to the 3-meter limit. No other radiated emissions than those reported were detected at a test distance of 0.3-meter.
  4. Negative value in the margin column shows emission below limit.
  5. Horn antenna is used for the emission over 1000MHz.
  6. Emission (the row indicated by **bold italic**) within the restricted band meets the requirement of FCC Part 15 Section 15.205.

**TEST REPORT**

Mode: TX-Channel 01

Table 4  
IEEE 802.11g (OFDM, 6 Mbps)

Polarization	Frequency (MHz)	Reading (dBμV)	Pre-Amp Gain (dB)	Antenna Factor (dB)	Net at 3m (dBμV/m)	Average Limit at 3m (dBμV/m)	Margin (dB)
<b>H</b>	<b>2390.000</b>	<b>51.8</b>	<b>33</b>	<b>29.4</b>	<b>48.2</b>	<b>54.0</b>	<b>-5.8</b>
<b>H</b>	<b>4824.000</b>	<b>38.9</b>	<b>33</b>	<b>34.9</b>	<b>40.8</b>	<b>54.0</b>	<b>-13.2</b>
<b>H</b>	<b>12060.000</b>	<b>31.7</b>	<b>33</b>	<b>40.5</b>	<b>39.2</b>	<b>54.0</b>	<b>-14.8</b>
<b>H</b>	<b>14472.000</b>	<b>33.7</b>	<b>33</b>	<b>40.0</b>	<b>40.7</b>	<b>54.0</b>	<b>-13.3</b>

Polarization	Frequency (MHz)	Reading (dBμV)	Pre-Amp Gain (dB)	Antenna Factor (dB)	Net at 3m - Peak (dBμV/m)	Peak Limit at 3m (dBμV/m)	Margin (dB)
<b>H</b>	<b>2390.000</b>	<b>62.4</b>	<b>33</b>	<b>29.4</b>	<b>58.8</b>	<b>74.0</b>	<b>-15.2</b>
<b>H</b>	<b>4824.000</b>	<b>49.4</b>	<b>33</b>	<b>34.9</b>	<b>51.3</b>	<b>74.0</b>	<b>-22.7</b>
<b>H</b>	<b>12060.000</b>	<b>43.6</b>	<b>33</b>	<b>40.5</b>	<b>51.1</b>	<b>74.0</b>	<b>-22.9</b>
<b>H</b>	<b>14472.000</b>	<b>45.5</b>	<b>33</b>	<b>40.0</b>	<b>52.5</b>	<b>74.0</b>	<b>-21.5</b>

- NOTES:
1. Peak detector is used for the emission measurement.
  2. Average detector is used for the average data of emission measurement
  3. All measurements were made at 3 meters. Radiated emissions not detected at the 3-meter distance were measured at 0.3-meter and an inverse proportional extrapolation was performed to compare the signal level to the 3-meter limit. No other radiated emissions than those reported were detected at a test distance of 0.3-meter.
  4. Negative value in the margin column shows emission below limit.
  5. Horn antenna is used for the emission over 1000MHz.
  6. Emission (the row indicated by **bold italic**) within the restricted band meets the requirement of FCC Part 15 Section 15.205.

**TEST REPORT**

Mode: TX-Channel 06

Table 5  
IEEE 802.11g (OFDM, 6 Mbps)

Polarization	Frequency (MHz)	Reading (dBμV)	Pre-Amp Gain (dB)	Antenna Factor (dB)	Net at 3m (dBμV/m)	Average Limit at 3m (dBμV/m)	Margin (dB)
<b>H</b>	<b>4874.000</b>	<b>37.9</b>	<b>33</b>	<b>34.9</b>	<b>39.8</b>	<b>54.0</b>	<b>-14.2</b>
<b>H</b>	<b>7311.000</b>	<b>32.5</b>	<b>33</b>	<b>37.9</b>	<b>37.4</b>	<b>54.0</b>	<b>-16.6</b>
<b>H</b>	<b>12185.000</b>	<b>32.0</b>	<b>33</b>	<b>40.5</b>	<b>39.5</b>	<b>54.0</b>	<b>-14.5</b>

Polarization	Frequency (MHz)	Reading (dBμV)	Pre-Amp Gain (dB)	Antenna Factor (dB)	Net at 3m - Peak (dBμV/m)	Peak Limit at 3m (dBμV/m)	Margin (dB)
<b>H</b>	<b>4874.000</b>	<b>48.3</b>	<b>33</b>	<b>34.9</b>	<b>50.2</b>	<b>74.0</b>	<b>-23.8</b>
<b>H</b>	<b>7311.000</b>	<b>42.7</b>	<b>33</b>	<b>37.9</b>	<b>47.6</b>	<b>74.0</b>	<b>-26.4</b>
<b>H</b>	<b>12185.000</b>	<b>43.9</b>	<b>33</b>	<b>40.5</b>	<b>51.4</b>	<b>74.0</b>	<b>-22.6</b>

- NOTES:
1. Peak detector is used for the emission measurement.
  2. Average detector is used for the average data of emission measurement
  3. All measurements were made at 3 meters. Radiated emissions not detected at the 3-meter distance were measured at 0.3-meter and an inverse proportional extrapolation was performed to compare the signal level to the 3-meter limit. No other radiated emissions than those reported were detected at a test distance of 0.3-meter.
  4. Negative value in the margin column shows emission below limit.
  5. Horn antenna is used for the emission over 1000MHz.
  6. Emission (the row indicated by **bold italic**) within the restricted band meets the requirement of FCC Part 15 Section 15.205.

**TEST REPORT**

Mode: TX-Channel 11

Table 6  
IEEE 802.11g (OFDM, 6 Mbps)

Polarization	Frequency (MHz)	Reading (dBμV)	Pre-Amp Gain (dB)	Antenna Factor (dB)	Net at 3m (dBμV/m)	Average Limit at 3m (dBμV/m)	Margin (dB)
<b>H</b>	<b>2483.500</b>	<b>52.1</b>	<b>33</b>	<b>29.4</b>	<b>48.5</b>	<b>54.0</b>	<b>-5.5</b>
<b>H</b>	<b>4924.000</b>	<b>36.3</b>	<b>33</b>	<b>34.9</b>	<b>38.2</b>	<b>54.0</b>	<b>-15.8</b>
<b>H</b>	<b>7386.000</b>	<b>32.6</b>	<b>33</b>	<b>37.9</b>	<b>37.5</b>	<b>54.0</b>	<b>-16.5</b>
<b>H</b>	<b>12310.000</b>	<b>31.9</b>	<b>33</b>	<b>40.5</b>	<b>39.4</b>	<b>54.0</b>	<b>-14.6</b>

Polarization	Frequency (MHz)	Reading (dBμV)	Pre-Amp Gain (dB)	Antenna Factor (dB)	Net at 3m - Peak (dBμV/m)	Peak Limit at 3m (dBμV/m)	Margin (dB)
<b>H</b>	<b>2483.500</b>	<b>62.9</b>	<b>33</b>	<b>29.4</b>	<b>59.3</b>	<b>74.0</b>	<b>-14.7</b>
<b>H</b>	<b>4924.000</b>	<b>46.9</b>	<b>33</b>	<b>34.9</b>	<b>48.8</b>	<b>74.0</b>	<b>-25.2</b>
<b>H</b>	<b>7386.000</b>	<b>42.8</b>	<b>33</b>	<b>37.9</b>	<b>47.7</b>	<b>74.0</b>	<b>-26.3</b>
<b>H</b>	<b>12310.000</b>	<b>43.7</b>	<b>33</b>	<b>40.5</b>	<b>51.2</b>	<b>74.0</b>	<b>-22.8</b>

- NOTES:
1. Peak detector is used for the emission measurement.
  2. Average detector is used for the average data of emission measurement
  3. All measurements were made at 3 meters. Radiated emissions not detected at the 3-meter distance were measured at 0.3-meter and an inverse proportional extrapolation was performed to compare the signal level to the 3-meter limit. No other radiated emissions than those reported were detected at a test distance of 0.3-meter.
  4. Negative value in the margin column shows emission below limit.
  5. Horn antenna is used for the emission over 1000MHz.
  6. Emission (the row indicated by **bold italic**) within the restricted band meets the requirement of FCC Part 15 Section 15.205.

**TEST REPORT**

Mode: TX-Channel 01

Table 7  
IEEE 802.11n (20MHz) (OFDM, MCS0)

Polarization	Frequency (MHz)	Reading (dBμV)	Pre-Amp Gain (dB)	Antenna Factor (dB)	Net at 3m (dBμV/m)	Average Limit at 3m (dBμV/m)	Margin (dB)
<b>H</b>	<b>2390.000</b>	<b>51.5</b>	<b>33</b>	<b>29.4</b>	<b>47.9</b>	<b>54.0</b>	<b>-6.1</b>
<b>H</b>	<b>4824.000</b>	<b>38.1</b>	<b>33</b>	<b>34.9</b>	<b>40.0</b>	<b>54.0</b>	<b>-14.0</b>
<b>H</b>	<b>12060.000</b>	<b>31.8</b>	<b>33</b>	<b>40.5</b>	<b>39.3</b>	<b>54.0</b>	<b>-14.7</b>
<b>H</b>	<b>14472.000</b>	<b>33.4</b>	<b>33</b>	<b>40.0</b>	<b>40.4</b>	<b>54.0</b>	<b>-13.6</b>

Polarization	Frequency (MHz)	Reading (dBμV)	Pre-Amp Gain (dB)	Antenna Factor (dB)	Net at 3m - Peak (dBμV/m)	Peak Limit at 3m (dBμV/m)	Margin (dB)
<b>H</b>	<b>2390.000</b>	<b>61.9</b>	<b>33</b>	<b>29.4</b>	<b>58.3</b>	<b>74.0</b>	<b>-15.7</b>
<b>H</b>	<b>4824.000</b>	<b>48.7</b>	<b>33</b>	<b>34.9</b>	<b>50.6</b>	<b>74.0</b>	<b>-23.4</b>
<b>H</b>	<b>12060.000</b>	<b>43.7</b>	<b>33</b>	<b>40.5</b>	<b>51.2</b>	<b>74.0</b>	<b>-22.8</b>
<b>H</b>	<b>14472.000</b>	<b>45.3</b>	<b>33</b>	<b>40.0</b>	<b>52.3</b>	<b>74.0</b>	<b>-21.7</b>

- NOTES:
1. Peak detector is used for the emission measurement.
  2. Average detector is used for the average data of emission measurement
  3. All measurements were made at 3 meters. Radiated emissions not detected at the 3-meter distance were measured at 0.3-meter and an inverse proportional extrapolation was performed to compare the signal level to the 3-meter limit. No other radiated emissions than those reported were detected at a test distance of 0.3-meter.
  4. Negative value in the margin column shows emission below limit.
  5. Horn antenna is used for the emission over 1000MHz.
  6. Emission (the row indicated by **bold italic**) within the restricted band meets the requirement of FCC Part 15 Section 15.205.

**TEST REPORT**

Mode: TX-Channel 06

Table 8  
IEEE 802.11n (20MHz) (OFDM, MCS0)

Polarization	Frequency (MHz)	Reading (dBμV)	Pre-Amp Gain (dB)	Antenna Factor (dB)	Net at 3m (dBμV/m)	Average Limit at 3m (dBμV/m)	Margin (dB)
<b>H</b>	<b>4874.000</b>	<b>38.4</b>	<b>33</b>	<b>34.9</b>	<b>40.3</b>	<b>54.0</b>	<b>-13.7</b>
<b>H</b>	<b>7311.000</b>	<b>32.3</b>	<b>33</b>	<b>37.9</b>	<b>37.2</b>	<b>54.0</b>	<b>-16.8</b>
<b>H</b>	<b>12185.000</b>	<b>31.7</b>	<b>33</b>	<b>40.5</b>	<b>39.2</b>	<b>54.0</b>	<b>-14.8</b>

Polarization	Frequency (MHz)	Reading (dBμV)	Pre-Amp Gain (dB)	Antenna Factor (dB)	Net at 3m - Peak (dBμV/m)	Peak Limit at 3m (dBμV/m)	Margin (dB)
<b>H</b>	<b>4874.000</b>	<b>48.9</b>	<b>33</b>	<b>34.9</b>	<b>50.8</b>	<b>74.0</b>	<b>-23.2</b>
<b>H</b>	<b>7311.000</b>	<b>42.5</b>	<b>33</b>	<b>37.9</b>	<b>47.4</b>	<b>74.0</b>	<b>-26.6</b>
<b>H</b>	<b>12185.000</b>	<b>43.5</b>	<b>33</b>	<b>40.5</b>	<b>51.0</b>	<b>74.0</b>	<b>-23.0</b>

- NOTES:
1. Peak detector is used for the emission measurement.
  2. Average detector is used for the average data of emission measurement
  3. All measurements were made at 3 meters. Radiated emissions not detected at the 3-meter distance were measured at 0.3-meter and an inverse proportional extrapolation was performed to compare the signal level to the 3-meter limit. No other radiated emissions than those reported were detected at a test distance of 0.3-meter.
  4. Negative value in the margin column shows emission below limit.
  5. Horn antenna is used for the emission over 1000MHz.
  6. Emission (the row indicated by **bold italic**) within the restricted band meets the requirement of FCC Part 15 Section 15.205.



**TEST REPORT**

Mode: TX-Channel 11

Table 9  
IEEE 802.11n (20MHz) (OFDM, MCS0)

Polarization	Frequency (MHz)	Reading (dBμV)	Pre-Amp Gain (dB)	Antenna Factor (dB)	Net at 3m (dBμV/m)	Average Limit at 3m (dBμV/m)	Margin (dB)
<b>H</b>	<b>2483.500</b>	<b>51.7</b>	<b>33</b>	<b>29.4</b>	<b>48.1</b>	<b>54.0</b>	<b>-5.9</b>
<b>H</b>	<b>4924.000</b>	<b>35.7</b>	<b>33</b>	<b>34.9</b>	<b>37.6</b>	<b>54.0</b>	<b>-16.4</b>
<b>H</b>	<b>7386.000</b>	<b>32.3</b>	<b>33</b>	<b>37.9</b>	<b>37.2</b>	<b>54.0</b>	<b>-16.8</b>
<b>H</b>	<b>12310.000</b>	<b>32.0</b>	<b>33</b>	<b>40.5</b>	<b>39.5</b>	<b>54.0</b>	<b>-14.5</b>

Polarization	Frequency (MHz)	Reading (dBμV)	Pre-Amp Gain (dB)	Antenna Factor (dB)	Net at 3m - Peak (dBμV/m)	Peak Limit at 3m (dBμV/m)	Margin (dB)
<b>H</b>	<b>2483.500</b>	<b>62.3</b>	<b>33</b>	<b>29.4</b>	<b>58.7</b>	<b>74.0</b>	<b>-15.3</b>
<b>H</b>	<b>4924.000</b>	<b>46.4</b>	<b>33</b>	<b>34.9</b>	<b>48.3</b>	<b>74.0</b>	<b>-25.7</b>
<b>H</b>	<b>7386.000</b>	<b>42.4</b>	<b>33</b>	<b>37.9</b>	<b>47.3</b>	<b>74.0</b>	<b>-26.7</b>
<b>H</b>	<b>12310.000</b>	<b>43.8</b>	<b>33</b>	<b>40.5</b>	<b>51.3</b>	<b>74.0</b>	<b>-22.7</b>

- NOTES:
1. Peak detector is used for the emission measurement.
  2. Average detector is used for the average data of emission measurement
  3. All measurements were made at 3 meters. Radiated emissions not detected at the 3-meter distance were measured at 0.3-meter and an inverse proportional extrapolation was performed to compare the signal level to the 3-meter limit. No other radiated emissions than those reported were detected at a test distance of 0.3-meter.
  4. Negative value in the margin column shows emission below limit.
  5. Horn antenna is used for the emission over 1000MHz.
  6. Emission (the row indicated by **bold italic**) within the restricted band meets the requirement of FCC Part 15 Section 15.205.

**TEST REPORT**

Mode: Normal Used Connect Wifi

Table 10

Polarization	Frequency (MHz)	Reading (dBµV)	Pre-amp (dB)	Antenna Factor (dB)	Net at 3m (dBµV/m)	Limit at 3m (dBµV/m)	Margin (dB)
V	31.334	41.9	16	10.0	35.9	40.0	-4.1
V	52.068	31.1	16	11.0	26.1	40.0	-13.9
V	98.628	29.1	16	12.0	25.1	40.0	-14.9
<b>V</b>	<b>162.163</b>	<b>35.7</b>	<b>16</b>	<b>16.0</b>	<b>35.7</b>	<b>40.0</b>	<b>-4.4</b>
V	374.956	19.8	16	24.0	27.8	47.0	-19.2
<b>V</b>	<b>960.230</b>	<b>26.9</b>	<b>16</b>	<b>33.0</b>	<b>43.9</b>	<b>47.0</b>	<b>-3.2</b>

- NOTES:
1. Peak detector is used for the emission measurement.
  2. All measurements were made at 3 meters. Radiated emissions not detected at the 3-meter distance were measured at 0.3-meter and an inverse proportional extrapolation was performed to compare the signal level to the 3-meter limit. No other radiated emissions than those reported were detected at a test distance of 0.3-meter.
  3. Negative value in the margin column shows emission below limit.
  4. Emission (the row indicated by **bold italic**) within the restricted band meets the requirement of FCC Part 15 Section 15.205.

**TEST REPORT**

4.6.3 Radiated Emission Test Setup

The figure below shows the test setup, which is utilized to make these measurements.

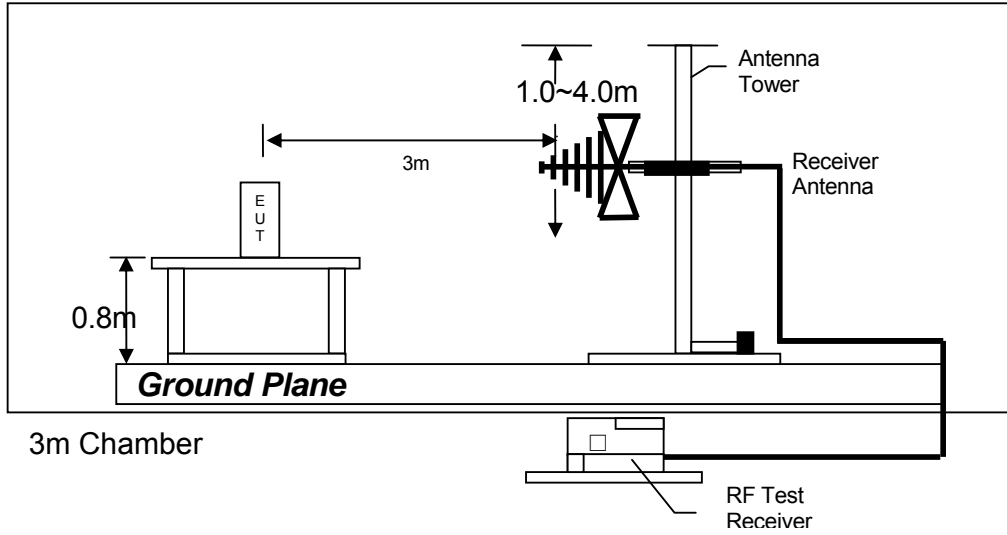

Test setup of radiated emissions up to 1GHz

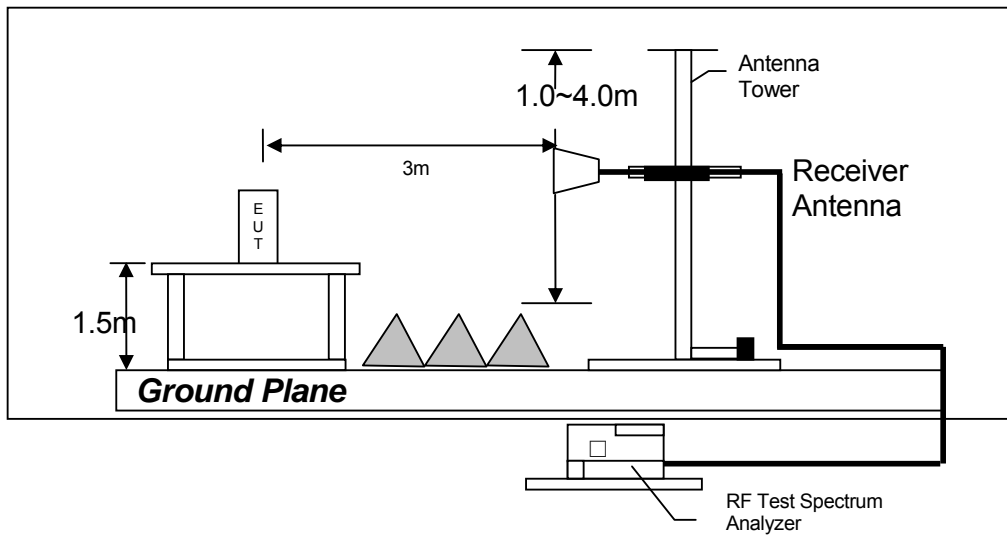

Test setup of radiated emissions above 1GHz

**TEST REPORT**

4.6.4 Transmitter Duty Cycle Calculation

Not applicable – No average factor is required.

**TEST REPORT**

## 4.7 AC Power Line Conducted Emission

- Not applicable – EUT is only powered by battery for operation.
- EUT connects to AC power line. Emission Data is listed in following pages.
  
- Base Unit connects to AC power line and has transmission. Handset connects to AC power line but has no transmission. Emission Data of Base Unit is listed in following pages.

## 4.7.1 AC Power Line Conducted Emission Configuration Photograph

Worst Case Line-Conducted Configuration  
at

388.5 kHz

The worst case line conducted configuration photographs are attached in the Appendix and saved with filename: config photos.pdf

## 4.7.2 AC Power Line Conducted Emission Data

The plot(s) and data in the following pages list the significant emission frequencies, the limit and the margin of compliance.

Passed by 17.7 dB margin compare with CISPR Average limit

## TEST REPORT

### AC POWER LINE CONDUCTED EMISSION

Worst Case: Operating



RBW 9 kHz

MT 1 s

Att 10 dB AUTO PREAMP OFF

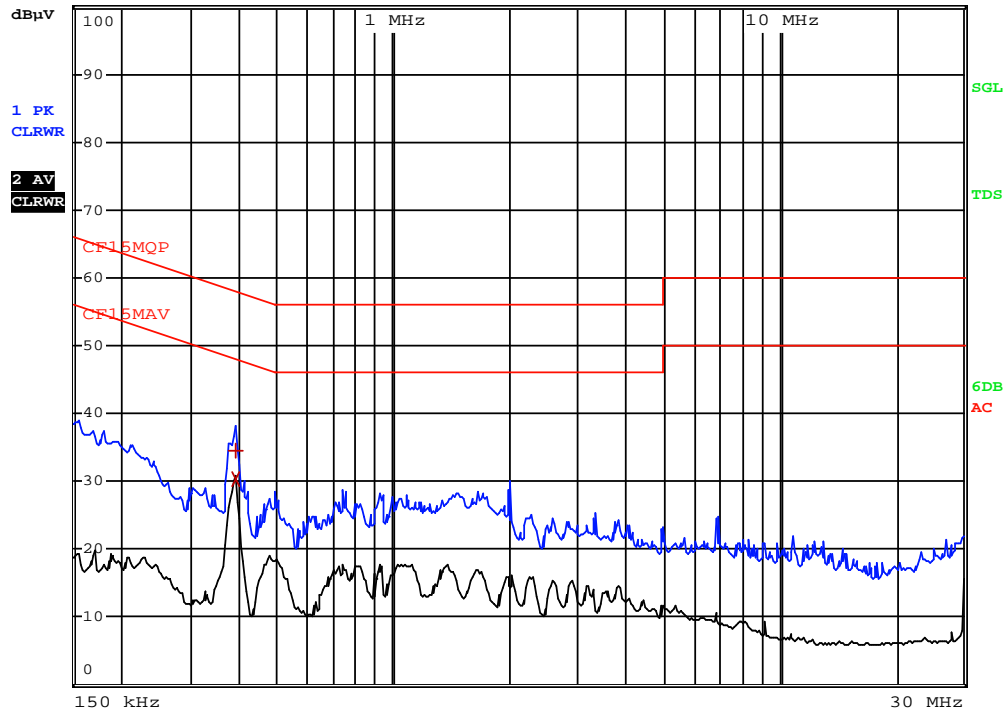

Date: 6.SEP.2017 16:17:33

**TEST REPORT**

Worst Case: Operating

EDIT PEAK LIST (Final Measurement Results)				
Trace1:	CF15MQP			
Trace2:	CF15MAV			
Trace3:	---			
TRACE	FREQUENCY	LEVEL dBµV		DELTA LIMIT dB
1 Quasi Peak	388.5 kHz	34.49	N	-23.59
2 CISPR Average	388.5 kHz	30.39	L1	-17.70

Date: 6.SEP.2017 16:17:14

## TEST REPORT

### 4.7.3 Conducted Emission Test Setup

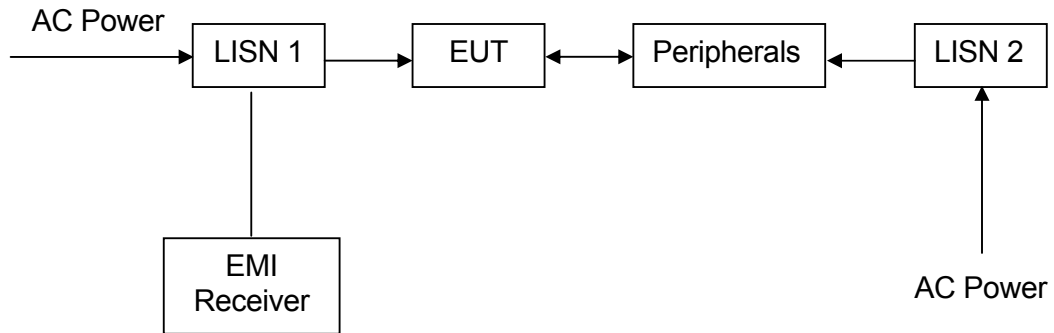



**TEST REPORT**

**EXHIBIT 5 EQUIPMENT LIST**

**5.0 EQUIPMENT LIST**

1) Radiated Emissions Test

Equipment	EMI Test Receiver	Spectrum Analyzer	BiConiLog Antenna
Registration No.	EW-3156	EW-3110	EW-3061
Manufacturer	R&S	R&S	EMCO
Model No.	ESR26	FSP30	3142E
Calibration Date	Dec. 06, 2016	Feb. 06, 2017	Sep. 23, 2016
Calibration Due Date	Dec. 06, 2017	Feb. 06, 2018	Sep. 23, 2017

Equipment	Log Periodic Antenna	Biconical Antenna	Double Ridged Guide Antenna
Registration No.	EW-0447	EW-0571	EW-0194
Manufacturer	EMCO	EMCO	EMCO
Model No.	3146	3104C	6502
Calibration Date	May. 18, 2016	May. 18, 2016	Mar. 11, 2016
Calibration Due Date	Nov. 18, 2017	Nov. 18, 2017	Sep. 11, 2017

Equipment	Active Loop H-field (9kHz to 30MHz)	RF Cable 9kHz to 1000MHz	RF Cable (up to 40GHz)
Registration No.	EW-2313	EW-3170	EW-3155
Manufacturer	ELECTROMETRI	N/A	N/A
Model No.	EM-6876	9kHz to 1000MHz	1-40 GHz
Calibration Date	May. 18, 2016	Mar. 20, 2017	Dec. 05, 2016
Calibration Due Date	Nov. 18, 2017	Mar. 20, 2018	Dec. 05, 2017

2) Conducted Emissions Test

Equipment	EMI Test Receiver	Artificial Mains	Pulse Limiter
Registration No.	EW-3156	EW-2041	EW-3248
Manufacturer	R&S	KYORITSU	R&S
Model No.	ESR26	KNW-403D	E3H3-Z2
Calibration Date	Dec. 06, 2016	Oct. 20, 2016	Oct. 12, 2016
Calibration Due Date	Dec. 06, 2017	Oct. 20, 2017	Oct. 12, 2017

Equipment	RF Power Meter with Power Sensor (N1921A)
Registration No.	EW-2270
Manufacturer	AGILENTTECH
Model No.	N1911A
Calibration Date	Jan. 04, 2017
Calibration Due Date	Jan. 04, 2018

## TEST REPORT

### 3) Conductive Measurement Test

<b>Equipment</b>	<b>Spectrum Analyzer</b>	<b>RF Power Meter with Power Sensor</b>
Registration No.	EW-2249	EW-2270
Manufacturer	R&S	AGILENTTECH
Model No.	FSP30	N1911A
Calibration Date	Dec. 23, 2016	Jan. 04, 2017
Calibration Due Date	Nov, 27. 2017	Jan. 04, 2018