

Overview

Thank you for purchasing this portable digital video camera, this camera features video recording at 4K. With resolution of 3840*2160 , it adopted Sony 1/3-inch image sensor,H.264 video encoding format, the video file storage usage is small while it has high image quality! You can connect your camera via Wi-Fi using your smart Phone remotely, to view the camera live screen and use your phone to record or shooting.

Safety Instructions

- Do not drop, impact or puncture the camera.
- Do not expose the camera to high/low temperature, excessive dust, humidity or strong vibration, otherwise the product may be damaged.
- Do not use corrosive chemicals or solvents to clean the product.
- Do not disassemble this camera or attempt to repair or modify it in any manner, if there is any damage to the camera, stop using the camera and return this product to the store where you have purchased it from, the product will be sent back to the company and fix.

Cautions

- Keep children away from the product, accessories and its packaging materials, it may cause suffocation.
- Do not put the product in a fire, otherwise it may cause an explosion.
- Remove the battery if the camera is not going to be used for long periods, and please fully-charged the battery before using it again.

TABLE OF CONTENTS

Getting to Know Your Camera.....	1
Standard Accessories.....	1
Charging the Battery.....	1
Component Introduction.....	3
Getting Started.....	7
Inserting an SD Card.....	7
Loading Battery.....	8
Recording Mode.....	9
Photo Mode.....	14
Setting Mode.....	19
PlayBack.....	21
Connecting to TV.....	24
Connecting to the Computer.....	25
APP Using.....	26
Downloading the APP.....	26
How to Connect Wi-Fi.....	26
Get Started.....	28
Technical Parameters.....	32
Troubleshooting.....	34

Getting to Know Your Camera

Standard Accessories

4K Ultra HD Camera

Infrared remote control

Battery

HDMI Cable

Charger

User Manual

USB Cable

Warranty Card

The above are all accessories, if there is any missing, please contact the seller for replacement.

Charging the Battery

Before using the camera, you must load and charge the battery

Charging with the Charger

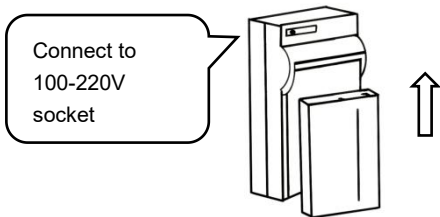

Note: Insert the battery into the charger to charge it, the indicator light will be red when charging; The indicator light will turn green when the charging is completed.

Charging with USB Cable (Direct Charge)

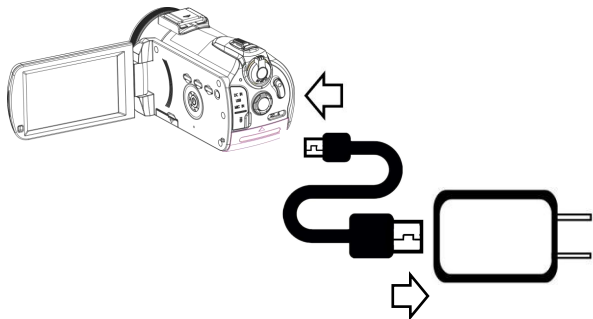

1. Please Connect the USB Cable to the charging adapter when camera is running low.
2. Connect the other side to the Camera's USB charging interface.
3. The indicator light will be red when charging; The indicator light will turn green when the charging is completed.



Note:

1. When using the charger, please install the battery in the charger slot correctly.
2. For direct charge, please use the 5V/2A-2.5A charging adapter for charging.
3. When using the USB Cable to charge, if charge during working condition, the camera will automatically shut down after the charging adapter is powered off.

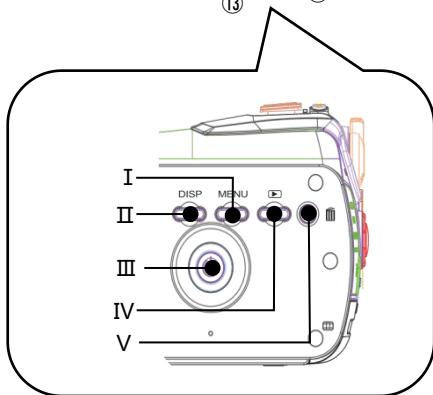
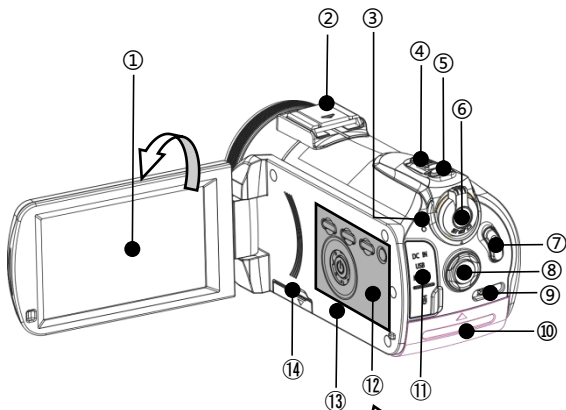
Rear View



For the function description of the related parts in the above figure, please refer to the following table.

No.	Name	Function description
①	IPS Touch Panel	Screen preview and video/photo playback.
②	Hot shoe interface	Mount hot shoe products.
③	State Light	Display of mode status.
④	T/W Zoom Button	In video/Photo Mode, pull left/right to zoom in/out; In Playback Mode, pull to switch photos/videos In Menu, pull to menu selection; In Video Playback, pull to adjust the volume.
⑤	Photo Button	Two-stage button, tap to focus and press to photo in photo mode.
⑥	Mode dial	Record、 Photo、 Setting Mode : SET Stands for Setting Mode  Stands for Record Mode  Stands for Photo Mode
⑦	Video Button	“START/STOP” is the recording/stop button; Stop playback when the video is playing.
⑧	IR Night Vision	Turn on/off the IR Light.

	Switch	
⑨	Battery compartment switch	Toggle to the right to open the battery compartment.
⑩	Battery Compartment	Load NP-120 Battery.
⑪	I/O Interface	10PIN USB interface: Access the USB Cable to charge Access to an external microphone and charging with“one-to-two” cable switcher HDMI: External HD Cable to connect to TV.
⑫	Menu Button	Press to enter the Menu.
	DISP Button	Short press to switch screen display mode
	Power Button	Power On/Off.
	Playback Button	Press to enter the playback mode
	Focus	Macro/Near Focus/Far Focus switch.
⑬	Built-in microphone	Recording sound.
⑭	SD slot	Open and insert the SD Card.

Front View

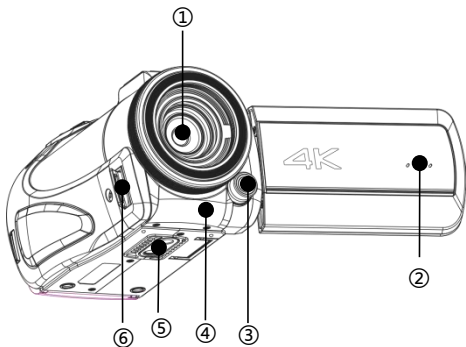

For the function description of the related parts in the above figure, please refer to the following table

No.	Name	Function Description
①	Lens	Framing.
②	Horn	Plays back sounds.
③	IR night vision light	Infrared light.
④	Infrared remote-control receiver	Receiving remote command.
⑤	1/4 Tripod Socket	Tripod installation.
⑥	Hand strap mounting hole	Install adjustable hand strap.

Getting Started

Inserting an SD Card

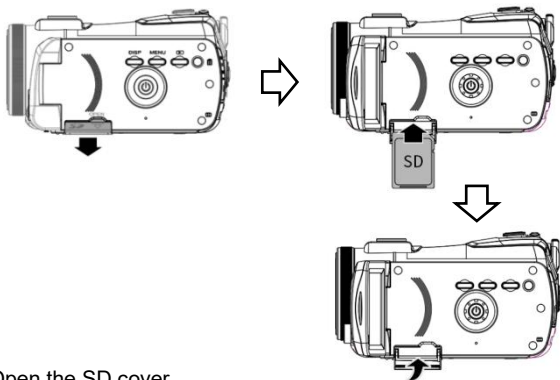

1. Open the SD cover.
 2. Insert the memory card in the direction shown until you hear “**Clicks**”.
 3. Close the SD cover.
- ※**Open the SD cover and press the memory card.**

Note:

1. When using for the first time, format the SD card On this unit. The SD card needs to be U3.
2. Do not forcefully remove the SD card while working, otherwise it may cause loss of files or machine damage.

Loading Battery

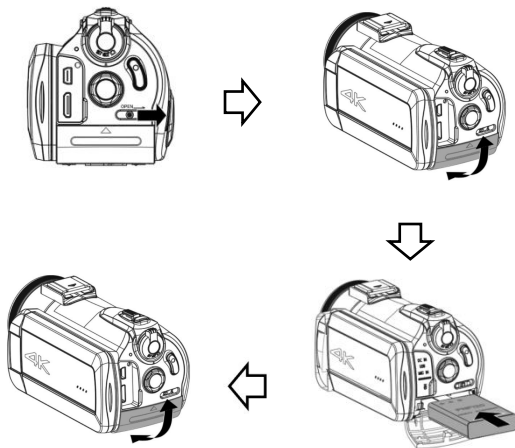

1. Push the OPEN button to the right as shown.
2. The battery compartment pops open, inserts a lithium battery.
3. Close the battery compartment.

Note:

1. Do not violently open the battery compartment and remove the battery.
2. The battery needs to be loaded into the battery compartment in a correct direction.

Recording Mode

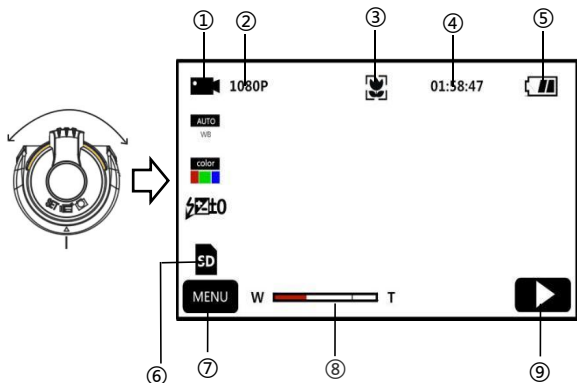

①	Recording mode	⑥	Memory Card
②	Resolution	⑦	Menu
③	Focus	⑧	Zoom
④	Remaining video recording time	⑨	Playback
⑤	Battery Status		

1. Press the power button or open the screen to turn on the camera, push the mode switch button to the video mode to enter the video mode.
2. Set the option of the function you need by the option setting menu.
3. Press the Rec button to start shooting.
4. Press the Rec button again to stop shooting.

Video setting menu

Enter the menu by button or touch, you can set the resolution, white balance, exposure and other function parameters to get better video results

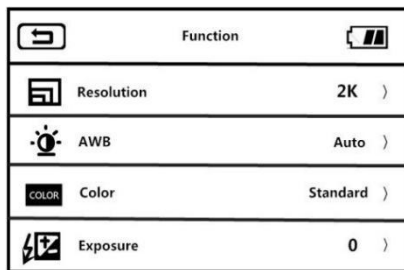
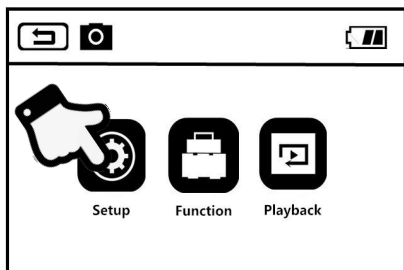

1. Press the power button to turn on the camera.
2. Press the menu button or touch the **MENU** icon on the screen to enter the menu.

3.Touch the **Setup** icon on the screen to enter the menu.

Name	Function Description
Resolution	4K 30fps/2K 30fps/FHD 30fps/ HD 30fps/VGA 30fps/FHD 60fps(S)/ HD 120fps(S)/ VGA 240fps(S)
AWB	Auto/Daylight/Cloudy/Fluorescent/ Tungsten
Color	Standard/Brown/Black/White/ Realistic Color
Exposure	+3/+2+1/0/-1/-2/-3
Date Stamp	On/Off
Metering	Multi/Center/Spor

4.By switching the T/W zoom button or swipe screen to select the setting option freely.

5.By touching or pressing the “Photo button” to select the option, for example: Resolution, enter the option menu,

select the resolution you need, press  to return to the

main menu, press  to return to the standby main interface.

Function

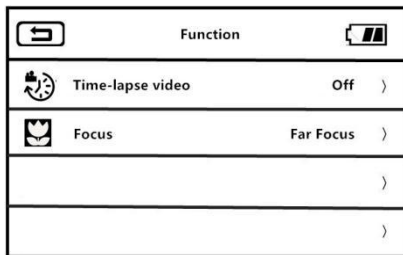
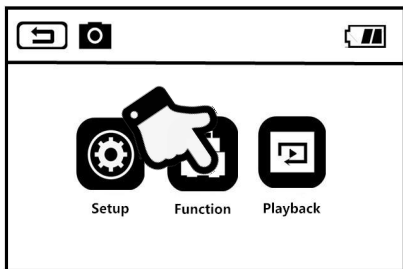

Name	Function Description
Time-lapse video	By selecting: Off, 1s, 3s, 5s to to compress a few minutes, hours or even days of video playback in a short period of time.
Focus	By selecting: Macro, Near Focus, Far Focus to adapt to different focus



1. Enter the Video mode, press "**Menu button**" or press button, to enter the main menu.
2. Touch "**Function**" to enter the option menu.
3. By switching the T/W zoom button to select the setting option freely.
4. By touching or pressing the "**Photo**" button to select the option, for example: Focus, enter the option menu, select the option you need, press  to return to the main menu, press  to return to the standby main interface.

Photo Mode



①	Photo mode	⑥	Memory Card
②	Resolution	⑦	Menu
③	Focus	⑧	Zoom
④	Remaining number of shoots	⑨	Playback
⑤	Battery Status		

1. Press the power button or open the screen to turn on the camera, push the mode switch button to the Photo mode to enter the Photo mode.

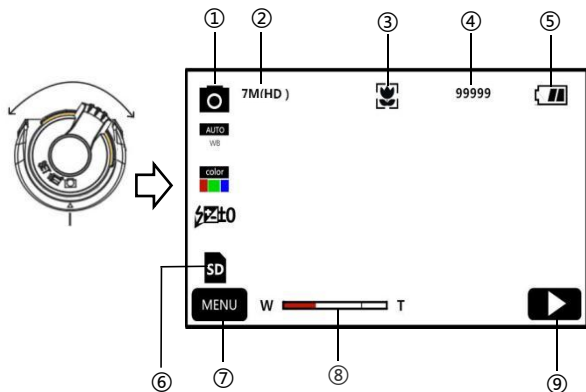
2. Set the option of the function you need by the option setting menu.

3. Press the "Photo" button, finish the photo .

Photo setting menu

Enter the menu by button or touch. You can set the resolution, white balance, exposure and other function parameters to get better photo results in the menu.

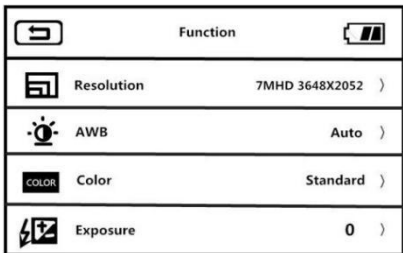
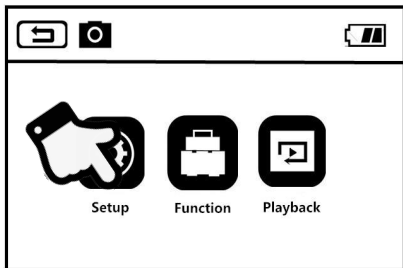

1. Press the power button to turn on the camera.
2. Press the menu button or touch the **MENU** icon on the screen to enter the menu.

3.Touch the **Setup**” icon on the screen to enter the menu.

Name	Function Description
Resolution	30M/24M/20M/16M/12M/10M/7MHD/5M/ 2MHD/VGA
AWB	Auto/Daylight/Cloudy/Fluorescent/ Tungsten
Color	Standard/Brown/Black/White/ Realistic Color
Exposure	+3/+2+1/0/-1/-2/-3
Date Stamp	On/Off
Metering	Multi/Center/Spot
Sharpness	Soft/Normal/Sharp
ISO	Auto/100/200/400/800/1600

4.By switching the T/W zoom button or swipe screen to select the setting option freely.

5.By touching or pressing the **Photo** “button to select the option, for example: Resolution, enter the option menu,

select the resolution you need, press  to return to the

main menu, press  to return to the standby main interface.

Function

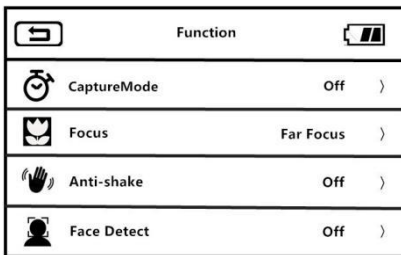
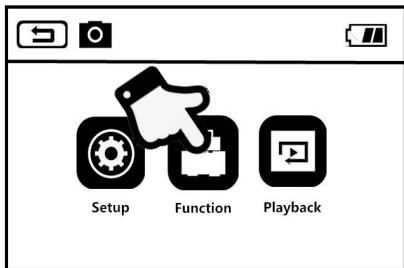

By using various features in this option menu allows you to take pictures easier and faster



Name	Function Description
Capture Mode	By selecting: Off, 2s, 5s, 10s to selfie.
Focus	By selecting: Macro, Near Focus, Far Focus to adapt to different focus

	distance.
Anti-Shake	Turn on this function can effectively reduce the picture jitter cause by strong vibration.
Face Detect	When this function is turned on, the face will be in priority focus when the camera detects a human face
Burst Mode	Take three consecutive photos
Date Stamp	Turn on this function to add a date watermark in the lower right corner of the photo

MENU

1. Enter the photo mode, press "**Menu button**" or press button, to enter the main menu.
2. Touch "**Function**" to enter the option menu.
3. By switching the T/W zoom button or swipe screen to select the setting option freely.
4. By touching or pressing the "**Photo**" button to select the option, for example: Capture Mode, enter the option menu, select the option you need, press  to return to the main menu, press  to return to the standby main interface.

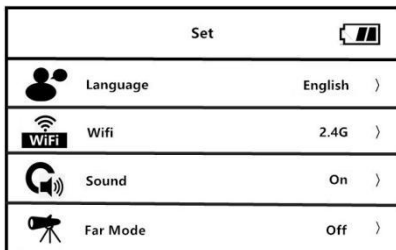

Setting Mode

Through this setting menu, you can customize the function parameters such as language, date and frequency.



Name	Function Description
Language	13 Languages
WI-FI	Turning on this function by selecting 2.4G/5G, you can connect the camera with the mobile app and remotely control the camera
Sound	Turn On/Off the camera button sound
Far Mode	On/Off
Set Date	Customize the date and time of the photo or video.
Frequency	Normally, 60HZ is suitable for US or other countries. While 50 HZ is suitable for European countries and Japan and so on
Auto Off	Off/3mins/5mins/10mins

Format	Yes/No
Default	Yes/No





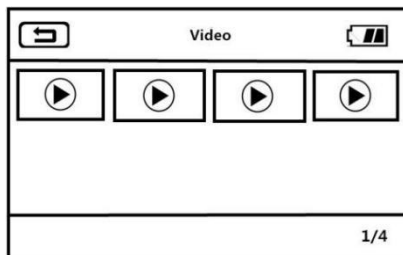
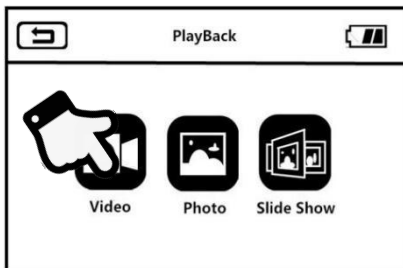

1. Press the power button or open the screen to turn on the camera, push the mode switch button to the SET mode to enter the SET mode.
2. By switching the T/W zoom button or swipe screen to select the setting option freely.
3. By touching or pressing the "**Photo**" button to select the option.
4. press  or  to return to the main menu.

Play Back



This function allows you to play recorded video or photo in the camera





Video

1. Touch  the playback button in the photo or video mode to enter the main playback interface.
2. Touch  the video button to enter the video playback interface.
3. Select any one of the video thumbnail to enter the preview screen.
4. Switch to the previous or next by clicking  or 
5. By selecting  button or “photo button” to start playback.
6. During the playback, press “T/W zoom button” to adjust the sound, press the “photo button” to pause playback, press “record button” to stop playing.
7. By tapping  or pressing the “Menu” button, you can delete the current file, delete all files, lock or unlock current file or all files.

Photo

1. Touch  the playback button in the photo or video mode to enter the main playback interface.
2. Touch the  Photo button to enter the Photo playback interface.
3. Select any one of the Photo thumbnail to Browse photos.

4. Switch to the previous or next by clicking  or 

5. By tapping  or pressing the “**Menu**” button, you can delete the current file, delete all files, lock or unlock current file or all files.

Slide Show

1. Touch  the playback button in the photo or video mode to enter the main playback interface

2. Touch the  Photo button to enter the Slide Show interface

3. By selecting the  play button or “**photo**” button to start play

4. By tapping  or pressing the “**Menu**” button, you can select 3S, 5S, 10S play time

Note: 3S, 5S, 10S options are the interval time of each picture.

Connecting to TV

When connect the HDMI to your camera's HDMI output and your TV, the image on your screen can also be displayed on your TV screen.

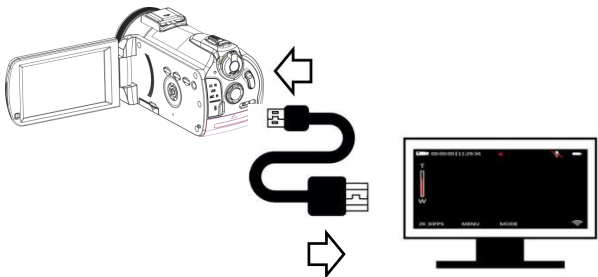

1. Press the power button or open the screen to turn on the camera and enter the standby state.
2. Take out the HDM cable and connect the camera with the HDMI connector of the TV.
3. Turn the TV to the HDMI channel, the preview screen will appears on the TV.

Connecting to the Computer

This function allows you to use your camera as a MSDC disk or PC Camera

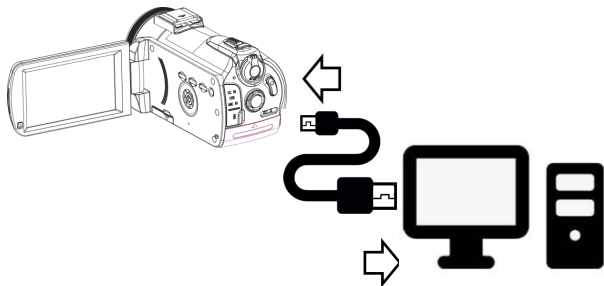

MSDC Mode

1. Power on the camera and enter the standby mode.
2. Connect the camera and computer with the cable.
3. The screen will display two options: "MSDC" and "PC Camera".
4. Select the "**MSDC**" by turning the Zoom button.
5. Press photo button to confirm.

PC Camera

1. Power on the camera and enter the standby mode.
2. Connect the camera and computer with the cable.
3. The screen will display two options: "MSDC" and "PC Camera".

4. Select the "PC Camera" by turning the Zoom button.

5. Press photo button to confirm.

Note: When use the camera as a PC Camera, the camera is not able to record video.

APP Using

Downloading the APP

For Android: Search "D Video" in Play store and download

For IOS: Search "D Video" in App store and download.

Or scan the QR Code to download the APP.



How to Connect Wi-Fi

1. Press the power button or open the screen to turn on the camera, push the mode switch button to the SET mode to enter the "SET" mode.
2. Click or "T/W zoom button" to select up and down and confirm the selection of Wi-Fi function options, confirm the choice of 2.4G or 5G mode according to the mobile phone configuration.
3. Open your phone and open the Wi-Fi search the name with **HDVxxxxxx**, Enter the password : **12345678** .

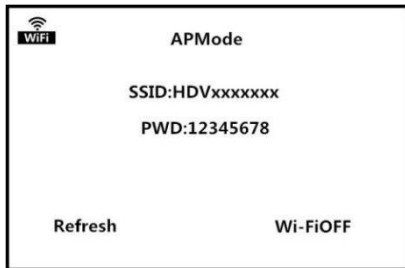

4. Enter the APP, touch " Camera".



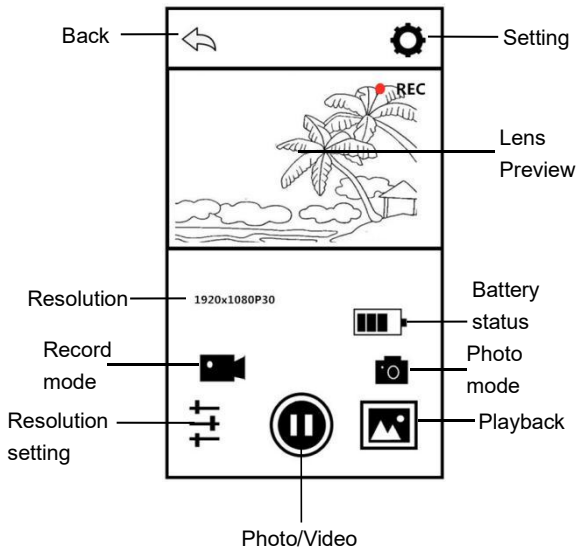

Note: The Wi-Fi function is a point-to-point wireless connection with a limited distance. The maximum distance is about 7 meters. Please use this function within the effective distance.



Get Started



You can remote control the camera to record, photo taking, playback and parameter setting on the APP

APP Video Mode

1. Press the  on the App user interface to enter the Video mode.
2. Touch the  icon , "REC" will be displayed at the top Right of the interface and flashes on the live preview., Start

- recording.
- 3.Touch the  icon again, Stop recording.

APP Photo Mode

- 1.Press the  on the App user interface to enter the Photo mode.
- 2.Press the  icon in live preview mode,the app will sound "click".
- 3.Finished.

APP Setting

This setting function allows you to customize the parameters of the camera, such as the resolution, audiorecording, and date

Press the  on the App user interface to enter the Setting menu.

Video Setting	Resolution	Different Video Resolution for Options
Photo Setting	Photo Size	Different Photo Size for Options
	Exposure	+3.0/+2.0/+1.0/0.0/ -1.0/-2.0/-3.0
Other Setting	WB	Auto/Day/Cloudy/ Fluorescent/Tungsten
	Color	Stand/Sepia/ Monochrome/Vivid

	ISO	Auto/100/200/400/800/ 1600
	Wi-Fi setting	ID/Password
	Format	YES/NO
	Default Setting	YES/NO
	Surplus Space	View the storage of camera
	Firmware Version	Camera Version

APP PlayBack

Through this function, the recorded video and photos can be played online on the APP and downloaded to the Phone





A.Photo

1. Press the  on the App user interface to enter the Play Back mode.
2. In the main interface of the playback, select “**Photo**” to enter the thumbnail preview interface.
3. Select any one of the document thumbnail to play or  delete  download the video to local.
4. After you press  to download the photo to the local album, you can share it to the social media by clicking .

B.Video

1. Press the  on the App user interface to enter the Play

Back mode.

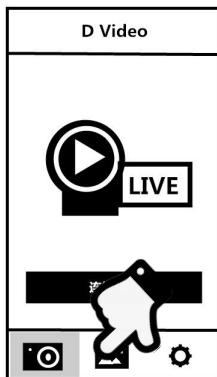

2. In the main interface of the playback, select **"Video"** to enter the thumbnail preview interface.
3. Select any one of the document thumbnail to play or download the video to local.
4. By selecting the  on the upper right corner to single-select/multi-select video, you can delete  or download  it to the local album.
5. After you press  to download the photo to the local album, you can share it to the social media by clicking .

C. Album



1. Press  on the main interface to enter the local album.
2. In the main interface of the playback, select **"Video"**

or **Photo**” to enter the thumbnail preview interface.
3. Select any one of the document thumbnail to play ,

delete  or share it to the social media by clicking 

Technical Parameters

Sensor	Sony 13.0 MP CMOS
Aperture	F: 2.0
Focal length	f=4.22mm
Focus range	Macro: 5cm~10cm Near Focus: 25cm~100cm Far Focus: 1m~INF
Lens type	Digital zoom lens
Zoom	64X
External Storage	Support SD/SDHC Card(U3), Maximum 256GB
Screen	3.1-inch IPS Touch Screen
Video Resolution	Standard: 4K :3840x2160 30fps 2K :2560x1440 30fps FHD :1920x1080 30fps HD:1280x720 30fps VGA:640x480 30fps Sports: FHD :1920x1080 60fps HD:1280x720 120fps VGA:640x480 240fps

Photo Resolution	6400x4800(30M)/5600x4200(24M) 5200x3900(20M)/4608x3456(16M) 4000x3000(12M)/3648x2736 (10M) 3648x2052(7MHD)/2592x1944 (5M) 1920x1080(2MHD)/640x480 (VGA)
File format	Video:MP4 Photo:JPEG
ISO	Auto/100/200/400/800/1600
Wi-Fi	Support
IR Night vision	Yes
Hot shoe	Support external Mic/LED Light
USB port	USB2.0: MIC IN/DC IN
Lens caliber	M=37mm
Speaker	Built-in
Microphone	Built-in
Battery	NP120 Li-ion battery
Working Temperature	0 ~ 40 °C

Troubleshooting

Trouble	Possible reason	Solution
Cannot power on	Battery is not inserted correctly/dead	Insert battery correctly/Charge
Unclear Focus	Out of focus range / lens dirty	Shooting in focus able range/Clean the lens
Unable to use memory card/unable to record	Card damage / SD card does not meet requirement	Replace the SD card / Format the SD Card / Use the U3 Card
Fail to use it as a PC Cam	USB Cable is loose / Computer system version is not compatible	Replace the USB interface / Select a compatible system

RF warning for Portable device:

The device has been evaluated to meet general RF exposure requirement. The device can be used in portable exposure condition without restriction.

NOTE:

This device complies with part 15 of the FCC Rules. Operation is subject to the following two conditions:

1. This device may not cause harmful interference, and
2. this device must accept any interference received, including interference that may cause undesired operation.

Any Changes or modifications not expressly approved by the

party responsible for compliance could void the user's authority to operate the equipment.

Note: This equipment has been tested and found to comply with the limits for a Class B digital device, pursuant to part 15 of the FCC Rules. These limits are designed to provide reasonable protection against harmful interference in a residential installation. This equipment generates uses and can radiate radio frequency energy and, if not installed and used in accordance with the instructions, may cause harmful interference to radio communications. However, there is no guarantee that interference will not occur in a particular installation. If this equipment does cause harmful interference to radio or television reception, which can be determined by turning the equipment off and on, the user is encouraged to try to correct the interference by one or more of the following measures:

- Reorient or relocate the receiving antenna.
- Increase the separation between the equipment and Receiver.
- Connect the equipment into an outlet on a circuit different from that to which the receiver is connected.
- Consult the dealer or an experienced radio/TV technician for help.