



FCC Part 15C Test Report

FCC ID: 2ALYRHG-F02B

Product Name:	TAKE
Trademark:	 高巨创新 HIGH GREAT
Model Name :	HG-F02B
Prepared For : Address :	Shenzhen HighGreat Innovation Technology Development Co., Ltd. NO.6 Yuanlingzai Park, Henggang Town, Longgang District, Shenzhen City, Guangdong Province, China
Prepared By : Address :	Shenzhen BCTC Technology Co., Ltd. No.101, Yousong Road, Longhua New District, Shenzhen, China
Test Date:	Apr. 20, 2017 – May 08, 2017
Date of Report :	May 08, 2017
Report No.:	BCTC-170401623E



VERIFICATION OF COMPLIANCE

Applicant's name..... Shenzhen HighGreat Innovation Technology Development Co., Ltd.
 Address NO.6 Yuanlingzai Park, Henggang Town, Longgang District, Shenzhen City, Guangdong Province, China

Manufacture's Name Shenzhen HighGreat Innovation Technology Development Co., Ltd.
 Address NO.6 Yuanlingzai Park, Henggang Town, Longgang District, Shenzhen City, Guangdong Province, China

Product description

Product name..... : TAKE

Trademark :  高巨创新
 HIGH GREAT

Model Name : HG-F02B

Test procedure : FCC Part15.407
 ANSI C63.10-2013

Standards KDB789033 D02 General UNII Test Procedures New Rules v01r02

This device described above has been tested by BCTC, and the test results show that the equipment under test (EUT) is in compliance with the FCC requirements. And it is applicable only to the tested sample identified in the report.

This report shall not be reproduced except in full, without the written approval of BCTC, this document may be altered or revised by BCTC, personal only, and shall be noted in the revision of the document.

Test Result **Pass**

Prepared by(Engineer): Snow Zeng

Reviewer(Supervisor): Jade Yang

Approved(Manager): Carson Zhang





TABLE OF CONTENTS

	Page
Test Report Declaration	
1. TEST SUMMARY	4
2. GENERAL PRODUCT INFORMATION	5
2.1. Product Function	5
2.2. Description of Device (EUT)	5
2.3. Independent Operation Modes	6
2.4. Test Supporting System	6
2.5. Test Sites	6
2.6. List of Test and Measurement Instruments	6
3. TEST SET-UP AND OPERATION MODES	8
3.1. Block Diagram of Test Set-up	8
3.2. Special Accessories and Auxiliary Equipment	8
3.3. Countermeasures to Achieve EMC Compliance	8
3.4. Test Operation Mode and Test Software	8
4. EMISSION TEST RESULTS	9
4.1. Conducted Emission Measurement	9
4.2. Radiated Emission Measurement	11
5. BAND EDGE COMPLIANCE TEST	20
5.1. Limits	20
5.2. TEST PROCEDURE	20
5.3. Test Data	20
6. 26DB AND 99% BANDWIDTH TEST	23
6.1. Limits	23
7. OUTPUT POWER TEST	28
7.1. Limits	28
7.2. Test setup	28
7.3. Test result	29
8. PEAK POWER SPECTRAL DENSITY TEST	30
8.1. Limits	30
8.2. Test setup	30
8.3. Test data	31
9. DUTY CYCLE TEST SIGNAL	34
10. FREQUENCY STABILITY	36
10.1. Limits	36
10.2. Test setup	36
10.3. Test data	37
11. TRANSMISSION IN THE ABSENCE OF DATA	39
11.1. Limits	39
11.2. Test result	39
12. ANTENNA REQUIREMENT	40
12.1. STANDARD REQUIREMENT	40
12.2. EUT ANTENNA	40
13. PHOTOGRAPHS OF TEST SET-UP	41
14. PHOTOGRAPHS OF THE EUT	42



1.TEST SUMMARY

Test Items	Test Requirement	Result
Conducted Emissions	15.207	N/A
Radiated Emissions	15.407(b), 15.209	PASS
26dB bandwidth and 99%dB Bandwidth	15.403(i) 15.407(e)	PASS
Power density	15.407 (a)	PASS
Maximum Peak Output Power	15.407 (a)	PASS
Emissions from out of band	15.407 (b)	PASS
Transmission in case of Absence of Information	15.407(c)	PASS
Frequency Stability	15.407(g)	PASS
Antenna Requirement	15.203	PASS

Note: N/A means not applicable.



2.GENERAL PRODUCT INFORMATION

2.1. Product Function

Refer to Technical Construction Form and User Manual.

2.2. Description of Device (EUT)

Equipment	TAKE	
Trade Name	 高巨创新 HIGH GREAT	
Model Name	HG-F02B	
Model Difference	N/A	
Product Description	The EUT is TAKE	
	Operation Frequency:	5745-5825MHz(802.11a/n(HT20)) 5755-5795MHz(802.11n(HT40))
	Modulation Type:	OFDM/DSSS
	Bit Rate of Transmitter	Data speed (IEEE 802.11a): 6Mbps, 9Mbps, 12Mbps, 18Mbps, 24Mbps, 36Mbps, 48Mbps,54Mbps Data speed (IEEE 802.11n): Up to 300Mbps
	Antenna Type:	external Antenna
	Antenna Gain:	2.0dBi
	Based on the application, features, or specification exhibited in User's Manual, the EUT is considered as an ITE/Computing Device. More details of EUT technical specification, please refer to the User's Manual.	
Channel List	Please refer to the Note 2.	
Power Source	DC 11.4V from battery	
Adapter	N/A	
hardware version	---	
Software version	---	



Channel list

802.11a/n20

Channel	Frequency (MHz)	Channel	Frequency (MHz)	Channel	Frequency (MHz)
		149	5745	153	5765
157	5785	161	5805	165	5825

the Directional Gain=2dBi+10log(2)=5.01dBi .

2.3. Independent Operation Modes

The basic operation modes are:

Pretest Mode	Description
Mode 1	802.11a CH149/CH157/CH165
Mode 2	802.11n(HT20) CH149/CH157/CH165
Mode 3	Link Mode

For Radiated Emission	
Final Test Mode	Description
Mode 1	802.11a CH149/CH157/CH165
Mode 2	802.11n(HT20) CH149/CH157/CH165

Note:

- (1) The measurements are performed at the highest, middle, lowest available channels.
- (2) The measurements are performed at all Bit Rate of Transmitter, the worst data was reported
- (3) According to ANSI C63.10 standards, the test results are both the "worst case" and "worst setup" MCS0 for 802.a , MCS0 for 802.11n(HT20), MCS1 for 802.11n(H40).

2.4. Test Supporting System

None.

2.5. Test Sites

2.5.1. Test Facilities

Lab Qualifications : FCC Registration No.:187086

2.6. List of Test and Measurement Instruments

Conduction test equipment



Item	Equipment	Manufacturer	Type No.	Serial No.	Last calibration	Calibrated until
1	Test Receiver	R&S	ESCI	1166.5950K03 -101165-ha	2016.08.27	2017.08.26
2	LISN	SCHWARZBECK	NSLK8127	8127739	2016.08.27	2017.08.26
3	LISN	R&S	NSLK8126	8126487	2016.08.27	2017.08.26
4	RF cables	R&S	R204	R20X	2016.08.27	2017.08.26
5	Attenuator	R&S	ESH3-Z2	143206	2016.08.27	2017.08.26

Radiation test, Band-edge test and 6db bandwidth test equipment

Item	equipment	Manufacturer	Type No.	Serial No.	Last calibration	Calibrated until
1	Spectrum Analyzer (9kHz-26.5GHz)	Agilent	E4407B	MY45108040	2016.08.27	2017.08.26
2	Test Receiver (9kHz-7GHz)	R&S	ESPI	101318	2016.08.27	2017.08.26
3	Bilog Antenna (30MHz-1GHz)	R&S	VULB 9168	VULB91 68-438	2016.08.27	2017.08.26
4	Horn Antenna (1GHz-18GHz)	SCHWARZBECK	BBHA9120D	1201	2016.09.03	2017.09.03
5	Horn Antenna (14GHz-40GHz)	SCHWARZBECK	BBHA 9170	9170-181	2016.09.03	2017.09.03
6	Amplifier (9KHz-6GHz)	SCHWARZBECK	BBV9744	9744-0037	2016.08.27	2017.08.26
7	Amplifier (1GHz-18GHz)	SCHWARZBECK	BBV9718	9718-309	2016.08.27	2017.08.26
8	Amplifier (18GHz-40GHz)	SCHWARZBECK	BBV 9721	9721-205	2016.08.27	2017.08.26
9	Loop Antenna (9KHz-30MHz)	SCHWARZBECK	FMZB1519B	00014	2016.09.03	2017.09.03
10	RF cables1 (9kHz-1GHz)	R&S	R203	R20X	2016.08.27	2017.08.26
11	RF cables2 (1GHz-40GHz)	R&S	R204	R21X	2016.08.27	2017.08.26
12	Antenna connector	Florida RF Labs	N/A	RF 01#	2016.08.27	2017.08.26
13	Power Metter	ANRITSU	ML2487A	6K00001568	2016.08.27	2017.08.26
14	Power Sensor (AV)	ANRITSU	ML2491A	030989	2016.08.27	2017.08.26
15	Signal Analyzer 9kHz-26.5GHz	Agilent	N9010A	MY48030494	2016.08.27	2017.08.26
16	Test Receiver 20kHz-40GHz	R&S	ESU 40	100376	2016.08.27	2017.08.26
17	D.C. Power Supply	LongWei	PS-305D	010964729	2016.08.27	2017.08.26



3. TEST SET-UP AND OPERATION MODES

3.1. Block Diagram of Test Set-up

System Diagram of Connections between EUT and Simulators



3.2. Special Accessories and Auxiliary Equipment

Item	Equipment	Mfr/Brand	Model/Type No.	Series No.	Note
E-1	TAKE	N/A	HG-F02B	N/A	EUT

Item	Shielded Type	Ferrite Core	Length	Note

3.3. Countermeasures to Achieve EMC Compliance

None.

3.4. Test Operation Mode and Test Software

None.



4. EMISSION TEST RESULTS

4.1. Conducted Emission Measurement

POWER LINE CONDUCTED EMISSION Limits (Frequency Range 150KHz-30MHz)

FREQUENCY (MHz)	Class B (dBuV)		Standard
	Quasi -peak	Average	
0.15 -0.5	66 - 56 *	56 - 46 *	FCC
0.50 -5.0	56.00	46.00	FCC
5.0 -30.0	60.00	50.00	FCC

Note:

- (1) The tighter limit applies at the band edges.
- (2) The limit of " * " marked band means the limitation decreases linearly with the logarithm of the frequency in the range.

The following table is the setting of the receiver

Receiver Parameters	Setting
Attenuation	10 dB
Start Frequency	0.15 MHz
Stop Frequency	30 MHz
IF Bandwidth	9 kHz

4.1.1. TEST PROCEDURE

- a. The EUT was placed 0.8 meters from the horizontal ground plane with EUT being connected to the power mains through a line impedance stabilization network (LISN). All other support equipments powered from additional LISN(s). The LISN provide 50 Ohm/ 50uH of coupling impedance for the measuring instrument.
- b. Interconnecting cables that hang closer than 40 cm to the ground plane shall be folded back and forth in the center forming a bundle 30 to 40 cm long.
- c. I/O cables that are not connected to a peripheral shall be bundled in the center. The end of the cable may be terminated, if required, using the correct terminating impedance. The overall length shall not exceed 1 m.
- d. LISN at least 80 cm from nearest part of EUT chassis.
- e. For the actual test configuration, please refer to the related Item –EUT Test Photos.

4.1.2. DEVIATION FROM TEST STANDARD

No deviation

4.1.3. TEST SETUP

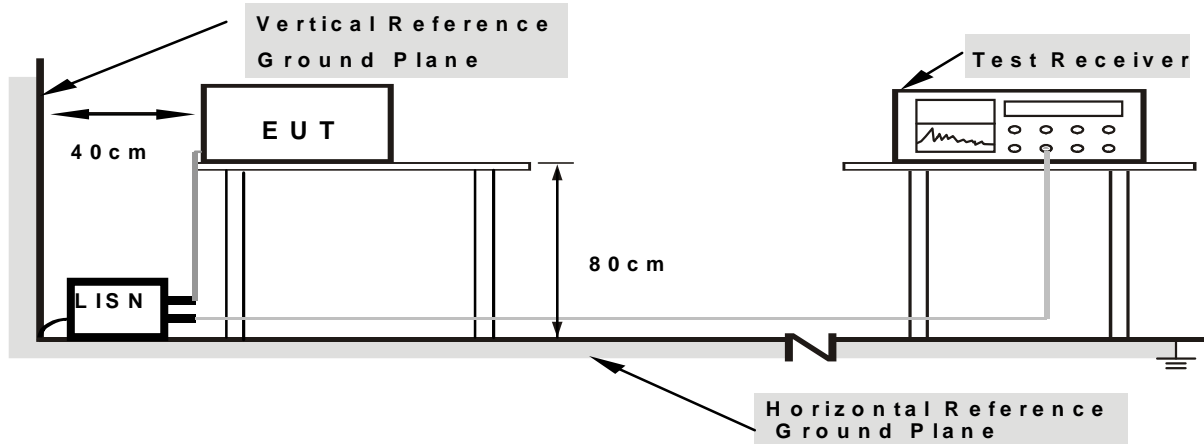

- Note: 1. Support units were connected to second LISN.
2. Both of LISNs (AMN) are 80 cm from EUT and at least 80 cm from other units and other metal planes

4.1.4. EUT OPERATING CONDITIONS

The EUT was configured for testing in a typical fashion (as a customer would normally use it). The EUT has been programmed to continuously transmit during test. This operating condition was tested and used to collect the included data.

We pretest all adapter's emission, only the adapter 1's data was worst and the data was recording in the report.

The data only show the worst mode.

If peak level comply with Quasi-Peak limit, then the Quasi-Peak level is deemed to comply with Quasi-Peak limit.

We pretest AC 120V and AC 240V, the worst voltage was AC 120V and the data recording in the report.

4.1.5. TEST RESULTS

N/A: The EUT's power provide by battery, no requirements for this item.



4.2. Radiated Emission Measurement

4.2.1. Radiated Emission Limits (Frequency Range 9kHz-1000MHz)

20dBc in any 100 kHz bandwidth outside the operating frequency band. In case the emission fall within the restricted band specified on 15.205(a), then the 15.209(a) limit in the table below has to be followed.

Frequencies (MHz)	Field Strength (micorvolts/meter)	Measurement Distance (meters)
0.009~0.490	2400/F(KHz)	300
0.490~1.705	24000/F(KHz)	30
1.705~30.0	30	30
30~88	100	3
88~216	150	3
216~960	200	3
Above 960	500	3

LIMITS OF RADIATED EMISSION MEASUREMENT (Above 1000MHz)

FREQUENCY (MHz)	Class B (dBuV/m) (at 3M)	
	PEAK	AVERAGE
Above 1000	74	54

Notes:

- (1) The limit for radiated test was performed according to FCC PART 15C.
- (2) The tighter limit applies at the band edges.
- (3) Emission level (dBuV/m)=20log Emission level (uV/m).

FREQUENCY RANGE OF RADIATED MEASUREMENT (For unintentional radiators)

Highest frequency generated or Upper frequency of measurement used in the device or on which the device operates or tunes (MHz)	Range (MHz)
Below 1.705	30
1.705 – 108	1000
108 – 500	2000
500 – 1000	5000
Above 1000	5th harmonic of the highest frequency or 40 GHz, whichever is lower



Spectrum Parameter	Setting
Attenuation	Auto
Start Frequency	1000 MHz
Stop Frequency	10th carrier harmonic
RB / VB (emission in restricted band)	1 MHz / 1 MHz for Peak, 1 MHz / 10Hz for Average

Receiver Parameter	Setting
Attenuation	Auto
Start ~ Stop Frequency	9kHz~150kHz / RB 200Hz for QP
Start ~ Stop Frequency	150kHz~30MHz / RB 9kHz for QP
Start ~ Stop Frequency	30MHz~1000MHz / RB 120kHz for QP

4.2.2. TEST PROCEDURE

- The EUT was placed on the top of a rotating table 0.8 meters above the ground at a 3 meter semi-anechoic chamber. The table was rotated 360 degrees to determine the position of the highest radiation.
- The EUT was set 3 meters away from the interference-receiving antenna, which was mounted on the top of a variable-height antenna tower.
- The antenna height is varied from one meter to four meters above the ground to determine the maximum value of the field strength. Both horizontal and vertical polarizations of the antenna are set to make the measurement.
- For each suspected emission, the EUT was arranged to its worst case and then the antenna was tuned to heights from 1 meter to 4 meters (for the test frequency of below 30MHz, the antenna was tuned to heights 1 meter) and the rotatable table was turned from 0 degrees to 360 degrees to find the maximum reading.
- The test-receiver system was set to Peak Detect Function and Specified Bandwidth with Maximum Hold Mode.
- If the emission level of the EUT in peak mode was 10dB lower than the limit specified, then testing could be stopped and the peak values of the EUT would be reported. Otherwise the emissions that did not have 10dB margin would be re-tested one by one using peak, quasi-peak or average method as specified and then reported in a data sheet.

Above 1GHz test procedure as below:

- Different between above is the test site, change from Semi- Anechoic Chamber to fully Anechoic Chamber and change form table 0.8 meter to 1.5 meter.
- Test the EUT in the lowest channel ,the middle channel ,the Highest channel

Note:

Both horizontal and vertical antenna polarities were tested and performed pretest to three orthogonal axis. The worst case emissions were reported

4.2.3. DEVIATION FROM TEST STANDARD

No deviation

4.2.4. TEST SETUP

(A) Radiated Emission Test-Up Frequency Below 30MHz

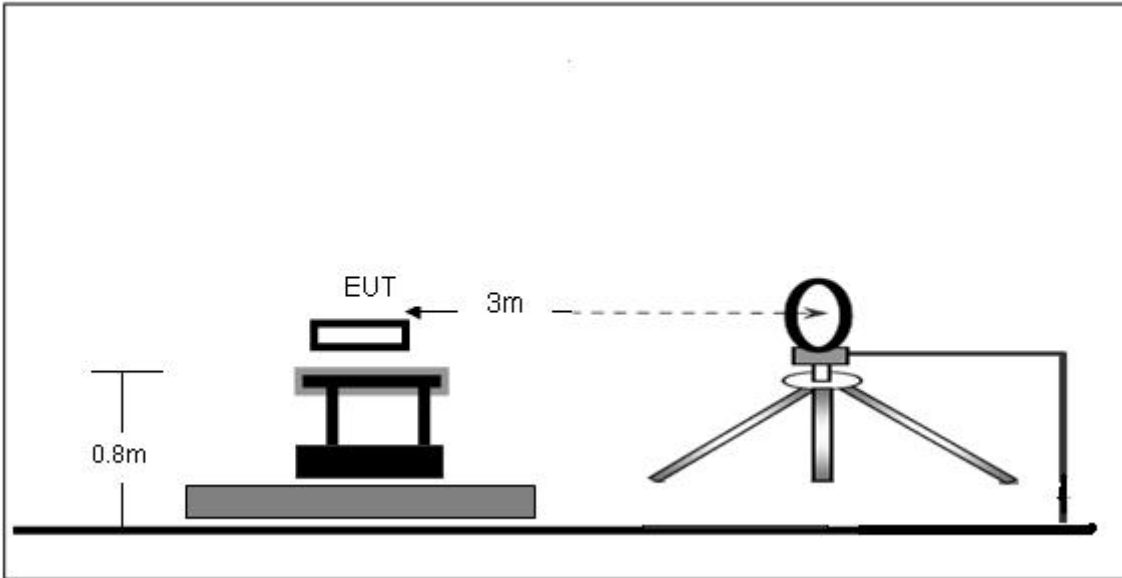

(B) Radiated Emission Test-Up Frequency 30MHz~1GHz

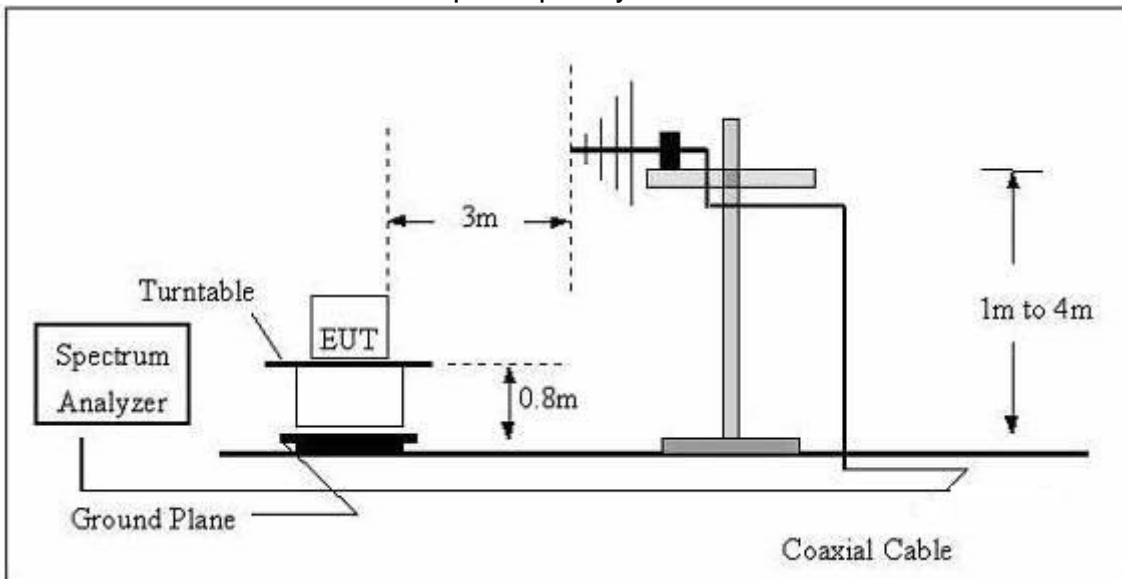

(C) Radiated Emission Test-Up Frequency Above 1GHz

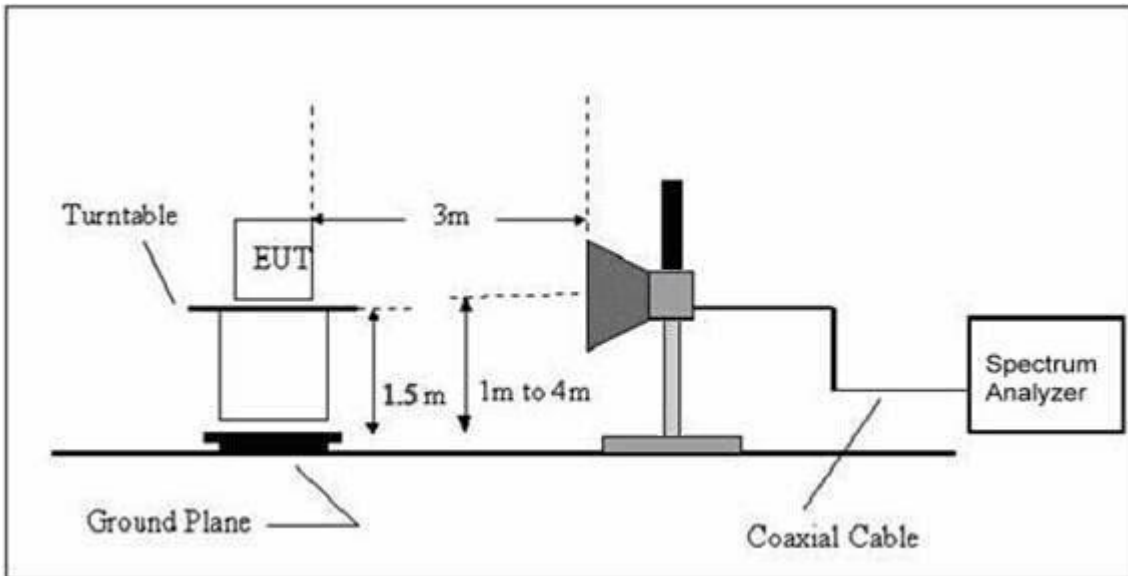

4.2.5. EUT OPERATING CONDITIONS

The EUT tested system was configured as the statements of 2.4 Unless otherwise a special operating condition is specified in the follows during the testing.

We pretest all adapter's emission, only the adapter 1's data was worst and the data was recording in the report.

The data only show the worst mode.



Radiated Spurious Emission (Below 30MHz)

Temperature :	20 °C	Relative Humidity :	48%
Pressure :	1010 hPa	Polarization :	---
Test Voltage :	DC 11.4V		
Test Mode :	TX		

Freq. (MHz)	Reading (dBuV/m)	Limit (dBuV/m)	Margin (dB)	State P/F
--	--	--	--	PASS
--	--	--	--	PASS

Note:

The amplitude of spurious emissions which are attenuated by more than 20dB below the permissible value has no need to be reported.

Distance extrapolation factor = $40 \log (\text{specific distance}/\text{test distance})$ (dB);

Limit line = specific limits(dBuv) + distance extrapolation factor.



Radiated Spurious Emission (Between 30MHz – 1GHz)

Temperature :	26 °C	Relative Humidity :	54%
Pressure :	1010 hPa	Polarization :	Horizontal
Test Voltage :	DC 11.4V		
Test Mode : (Worst)	Link Mode		



Remark:

Factor = Antenna Factor + Cable Loss – Pre-amplifier.

All interfaces was connected, and BT TX mode was link.

No.	Mk.	Freq.	Reading Level	Correct Factor	Measurement	Limit	Over	Detector
		MHz	dBuV	dB/m	dBuV/m	dBuV/m	dB	
1		36.0007	25.79	-8.59	17.20	40.00	-22.80	QP
2		53.8818	28.13	-10.93	17.20	40.00	-22.80	QP
3	*	319.9370	56.94	-12.06	44.88	46.00	-1.12	QP
4		399.0302	48.52	-10.20	38.32	46.00	-7.68	QP
5		531.9635	43.27	-7.57	35.70	46.00	-10.30	QP
6		798.9797	35.40	-2.52	32.88	46.00	-13.12	QP



Temperature :	26 °C	Relative Humidity :	54%
Pressure :	1010 hPa	Polarization :	Vertical
Test Voltage :	DC 11.4V		
Test Mode : (Worst)	Link Mode		

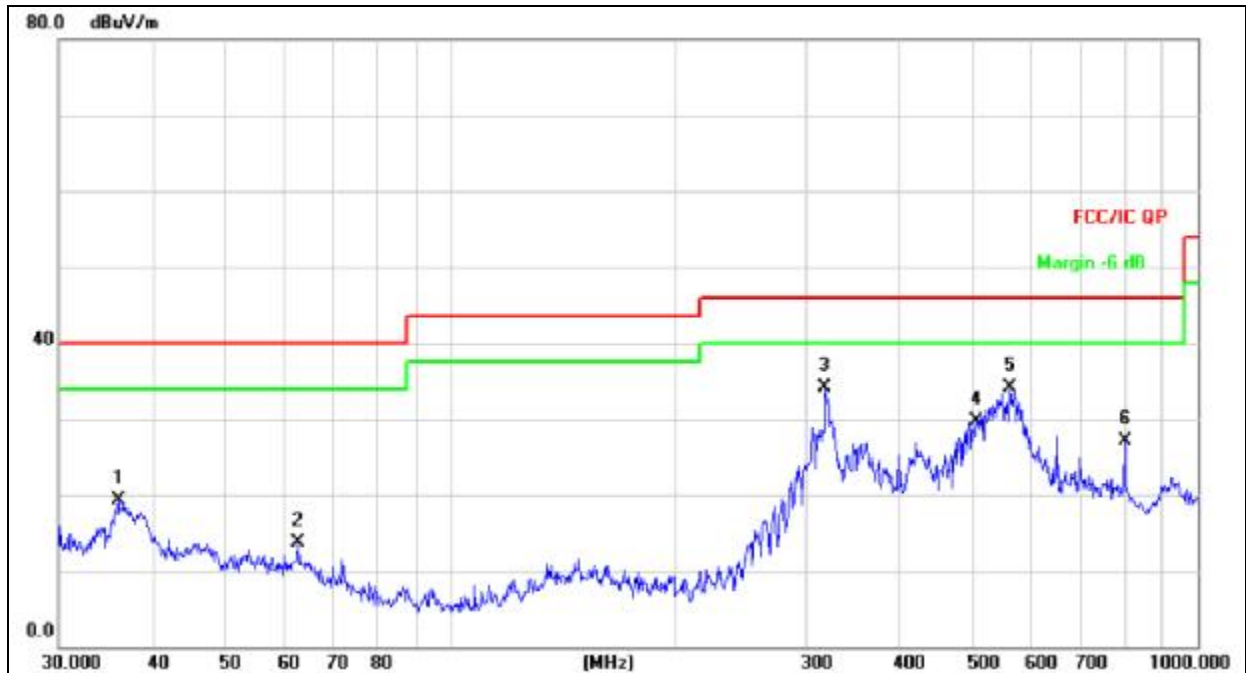

Remark:

Factor = Antenna Factor + Cable Loss – Pre-amplifier.

All interfaces was connected, and BT TX mode was link.

No.	Mk.	Freq. MHz	Reading Level dBuV	Correct Factor dB/m	Measure- ment dBuV/m	Limit dBuV/m	Over dB	Detector
1		36.0007	27.97	-8.59	19.38	40.00	-20.62	QP
2		62.6507	25.80	-12.05	13.75	40.00	-26.25	QP
3	*	317.7011	46.14	-12.11	34.03	46.00	-11.97	QP
4		506.4791	37.83	-8.09	29.74	46.00	-16.26	QP
5		560.6928	40.82	-6.80	34.02	46.00	-11.98	QP
6		798.9797	29.68	-2.52	27.16	46.00	-18.84	QP



Radiated Spurious Emission (Above 1GHz)

Polar (H/V)	Frequency	Meter Reading	Pre-amplifier	Cable Loss	Antenna Factor	Emission Level	Limits	Margin	Detector Type
	(MHz)	(dBuV)	(dB)	(dB)	(dB/m)	(dBuV/m)	(dBuV/m)	(dB)	
802.11a Band 4 Operation frequency:5745									
V	11490.00	57.22	39.73	18.19	27.31	62.99	74	-11.01	PK
V	11490.00	38.23	39.73	18.19	27.31	44.00	54	-10.00	AV
V	17235.00	53.28	38.59	18.92	28.41	62.02	74	-11.98	PK
V	17235.00	33.73	38.59	18.92	28.41	42.47	54	-11.53	AV
V	25450.00	37.24	37.23	20.36	30.35	50.72	74	-23.28	PK
H	11490.00	57.73	39.73	18.19	27.31	63.50	74	-10.50	PK
H	11490.00	38.69	39.73	18.19	27.31	44.46	54	-9.54	AV
H	17235.00	53.47	38.59	18.92	28.41	62.21	74	-11.79	PK
H	17235.00	33.96	38.59	18.92	28.41	42.70	54	-11.30	AV
H	25450.00	37.02	37.23	20.36	30.35	50.50	74	-23.50	PK
802.11a Band 4 Operation frequency:5785									
V	11570.00	57.45	39.76	18.25	27.39	63.33	74	-10.67	PK
V	11570.00	38.83	39.76	18.25	27.39	44.71	54	-9.29	AV
V	17355.00	53.57	38.62	19.16	28.48	62.59	74	-11.41	PK
V	17355.00	33.45	38.62	19.16	28.48	42.47	54	-11.53	AV
V	25450.00	37.46	37.23	20.36	30.35	50.94	74	-23.06	PK
H	11570.00	56.78	39.76	18.25	27.39	62.66	74	-11.34	PK
H	11570.00	38.71	39.76	18.25	27.39	44.59	54	-9.41	AV
H	17355.00	53.18	38.62	19.16	28.48	62.20	74	-11.80	PK
H	17355.00	34.01	38.62	19.16	28.48	43.03	54	-10.97	AV
H	25450.00	37.84	37.23	20.36	30.35	51.32	74	-22.68	PK
802.11a Band 4 Operation frequency:5825									
V	11650.00	57.31	39.79	18.32	27.42	63.26	74	-10.74	PK
V	11650.00	38.01	39.79	18.32	27.42	43.96	54	-10.04	AV
V	17475.00	53.72	38.66	19.24	28.53	62.83	74	-11.17	PK
V	17475.00	33.60	38.66	19.24	28.53	42.71	54	-11.29	AV
V	25450.00	37.77	37.23	20.36	30.35	51.25	74	-22.75	PK
H	11650.00	57.20	39.79	18.32	27.42	63.15	74	-10.85	PK
H	11650.00	38.61	39.79	18.32	27.42	44.56	54	-9.44	AV
H	17475.00	52.63	38.66	19.24	28.53	61.74	74	-12.26	PK
H	17475.00	33.50	38.66	19.24	28.53	42.61	54	-11.39	AV
H	25450.00	37.68	37.23	20.36	30.35	51.16	74	-22.84	PK

Remark:

1. Emission Level = Meter Reading + Antenna Factor + Cable Loss – Pre-amplifier, Margin= Emission Level - Limit
2. If peak below the average limit, the average emission was no test.
3. The amplitude of spurious emissions which are attenuated by more than 20dB below the permissible value has no need to be reported.



Polar (H/V)	Frequency	Meter Reading	Pre-amplifier	Cable Loss	Antenna Factor	Emission Level	Limits	Margin	Detector Type
	(MHz)	(dBuV)	(dB)	(dB)	(dB/m)	(dBuV/m)	(dBuV/m)	(dB)	
802.11n(HT20) Band 4 Operation frequency:5745									
V	11490.00	57.19	39.73	18.19	27.31	62.96	74	-11.04	PK
V	11490.00	38.21	39.73	18.19	27.31	43.98	54	-10.02	AV
V	17235.00	53.25	38.59	18.92	28.41	61.99	74	-12.01	PK
V	17235.00	34.71	38.59	18.92	28.41	43.45	54	-10.55	AV
V	25450.00	37.73	37.23	20.36	30.35	51.21	74	-22.79	PK
H	11490.00	57.70	39.73	18.19	27.31	63.47	74	-10.53	PK
H	11490.00	38.67	39.73	18.19	27.31	44.44	54	-9.56	AV
H	17235.00	53.44	38.59	18.92	28.41	62.18	74	-11.82	PK
H	17235.00	33.94	38.59	18.92	28.41	42.68	54	-11.32	AV
H	25450.00	37.01	37.23	20.36	30.35	50.49	74	-23.51	PK
802.11n(HT20) Band 4 Operation frequency:5785									
V	11570.00	57.52	39.76	18.25	27.39	63.40	74	-10.60	PK
V	11570.00	37.88	39.76	18.25	27.39	43.76	54	-10.24	AV
V	17355.00	53.64	38.62	19.16	28.48	62.66	74	-11.34	PK
V	17355.00	34.49	38.62	19.16	28.48	43.51	54	-10.49	AV
V	25450.00	37.52	37.23	20.36	30.35	51.00	74	-23.00	PK
H	11570.00	57.85	39.76	18.25	27.39	63.73	74	-10.27	PK
H	11570.00	38.76	39.76	18.25	27.39	44.64	54	-9.36	AV
H	17355.00	53.25	38.62	19.16	28.48	62.27	74	-11.73	PK
H	17355.00	34.05	38.62	19.16	28.48	43.07	54	-10.93	AV
H	25450.00	37.90	37.23	20.36	30.35	51.38	74	-22.62	PK
802.11n(HT20) Band 4 Operation frequency:5825									
V	11650.00	57.28	39.79	18.32	27.42	63.23	74	-10.77	PK
V	11650.00	37.99	39.79	18.32	27.42	43.94	54	-10.06	AV
V	17475.00	53.69	38.66	19.24	28.53	62.80	74	-11.20	PK
V	17475.00	34.58	38.66	19.24	28.53	43.69	54	-10.31	AV
V	25450.00	37.76	37.23	20.36	30.35	51.24	74	-22.76	PK
H	11650.00	57.17	39.79	18.32	27.42	63.12	74	-10.88	PK
H	11650.00	38.59	39.79	18.32	27.42	44.54	54	-9.46	AV
H	17475.00	53.60	38.66	19.24	28.53	62.71	74	-11.29	PK
H	17475.00	34.48	38.66	19.24	28.53	43.59	54	-10.41	AV
H	25450.00	38.67	37.23	20.36	30.35	52.15	74	-21.85	PK

Remark:

1. Emission Level = Meter Reading + Antenna Factor + Cable Loss – Pre-amplifier, Margin= Emission Level - Limit
2. If peak below the average limit, the average emission was no test.
3. The amplitude of spurious emissions which are attenuated by more than 20dB below the permissible value has no need to be reported.



5. BAND EDGE COMPLIANCE TEST

5.1. Limits

(1) For transmitters operating in the 5.15-5.25 GHz band: All emissions outside of the 5.15-5.35 GHz band shall not exceed an e.i.r.p. of -27 dBm/MHz.

(4) For transmitters operating in the 5.725-5.85 GHz band: All emissions shall be limited to a level of -27 dBm/MHz at 75 MHz or more above or below the band edge increasing linearly to 10 dBm/MHz at 25 MHz above or below the band edge, and from 25 MHz above or below the band edge increasing linearly to a level of 15.6 dBm/MHz at 5 MHz above or below the band edge, and from 5 MHz above or below the band edge increasing linearly to a level of 27 dBm/MHz at the band edge.

5.2. TEST PROCEDURE

1. Check the calibration of the measuring instrument using either an internal calibrator or a known signal from an external generator.
2. Position the EUT without connection to measurement instrument. Turn on the EUT and connect its antenna terminal to measurement instrument via a low loss cable. Then set it to any one measured frequency within its operating range, and make sure the instrument is operated in its linear range.
3. Set RBW of spectrum analyzer to 1 MHz with a convenient frequency span.
4. Measure the highest amplitude appearing on spectral display and set it as a reference level. Plot the graph with marking the highest point and edge frequency.
5. Repeat above procedures until all measured frequencies were complete.

5.3. Test Data

Please see data as below:



Ant1 Band 4
802.11a



802.11n20



802.11n40





Ant2 Band 4
802.11a



802.11n20





6. 26DB AND 99% BANDWIDTH TEST

6.1. Limits

The maximum power spectral density is measured as a conducted emission by direct connection of a calibrated test instrument to the equipment under test. If the device cannot be connected directly, alternative techniques acceptable to the Commission may be used. Measurements in the 5.725-5.85 GHz band are made over a reference bandwidth of 500 kHz or the 26 dB emission bandwidth of the device, whichever is less. Measurements in the 5.15-5.25 GHz, 5.25-5.35 GHz, and the 5.47-5.725 GHz bands are made over a bandwidth of 1 MHz or the 26 dB emission bandwidth of the device, whichever is less. A narrower resolution bandwidth can be used, provided that the measured power is integrated over the full reference bandwidth.

- a) Set RBW = approximately 1% of the emission bandwidth.
- b) Set the VBW > RBW.
- c) Detector = Peak.
- d) Trace mode = max hold.
- e) Measure the maximum width of the emission that is 26 dB down from the maximum of the emission. Compare this with the RBW setting of the analyzer. Readjust RBW and repeat measurement as needed until the RBW/EBW ratio is approximately 1%.
The following procedure shall be used for measuring (99 %) power bandwidth:
 1. Set center frequency to the nominal EUT channel center frequency.
 2. Set span = 1.5 times to 5.0 times the OBW.
 3. Set RBW = 1 % to 5 % of the OBW
 4. Set VBW \geq 3*RBW
 5. Video averaging is not permitted. Where practical, a sample detection and single sweep mode shall be used. Otherwise, peak detection and max hold mode (until the trace stabilizes) shall be used.
 6. Use the 99 % power bandwidth function of the instrument (if available).
 7. If the instrument does not have a 99 % power bandwidth function, the trace data points are recovered and directly summed in power units. The recovered amplitude data points, beginning at the lowest frequency, are placed in a running sum until 0.5 % of the total is reached; that frequency is recorded as the lower frequency. The process is repeated until 99.5 % of the total is reached; that frequency is recorded as the upper frequency. The 99% occupied bandwidth is the difference between these two frequencies.

we test all antennas, the antenna 1 was worst mode and the data recording in the report.



	Frequency (MHz)	-6dB Bandwidth (MHz)		99% Bandwidth (MHz)		Limit (MHz)
		Ant 1	Ant 2	Ant 1	Ant 2	
802.11a	5745	16.775	16.755	21.22	21.19	>0.5
	5785	16.776	16.762	21.10	21.04	>0.5
	5825	16.758	17.746	21.03	21.00	>0.5
802.11n (HT20)	5745	17.808	17.798	21.69	21.59	>0.5
	5785	17.810	17.803	21.60	21.75	>0.5
	5825	17.820	17.816	21.81	21.72	>0.5



802.11a 5745MHz



802.11a 5785MHz

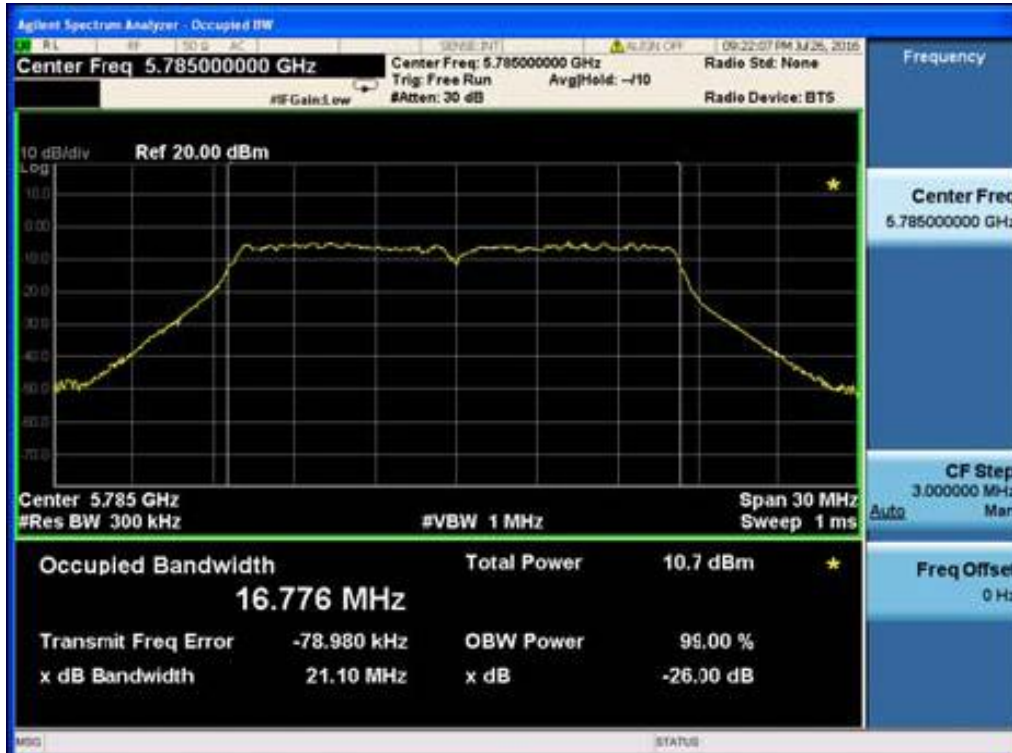



802.11a 5825MHz



802.11n(HT20) 5745MHz





802.11n(HT20) 5785MHz

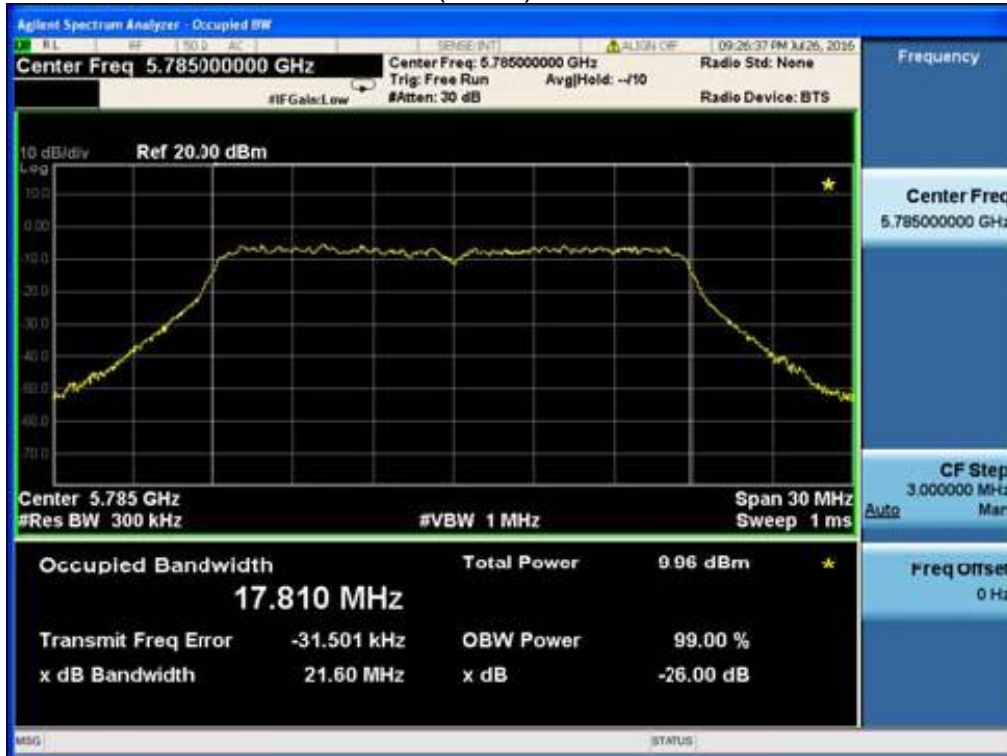

802.11n(HT20) 5825MHz

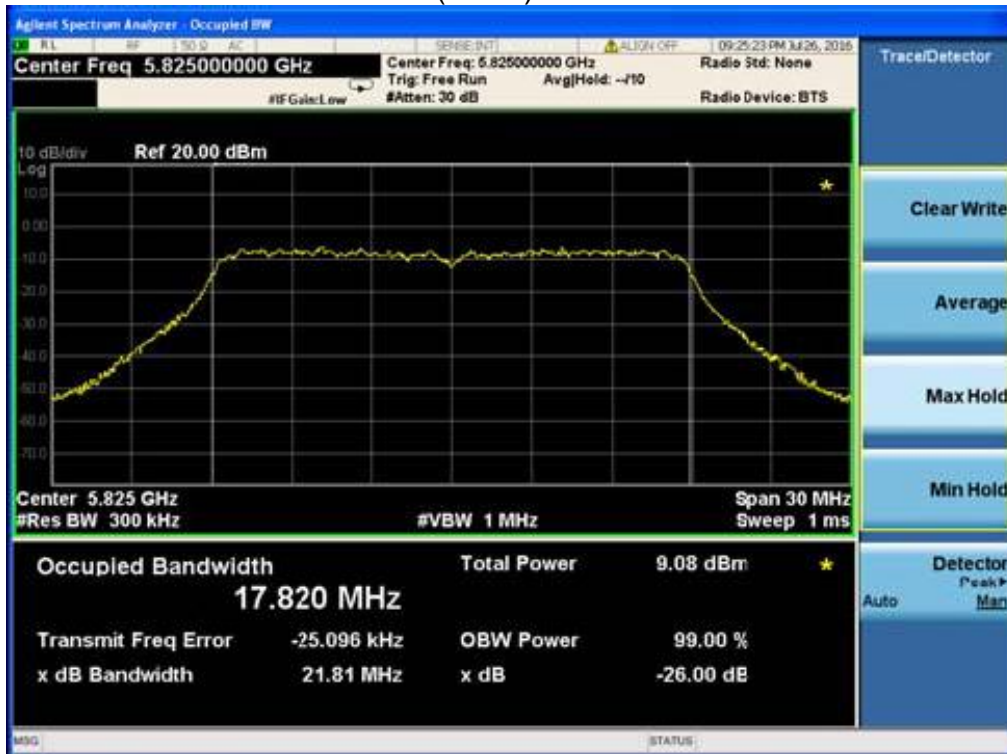



7. OUTPUT POWER TEST

7.1. Limits

For mobile and portable client devices in the 5.15-5.25 GHz band, the maximum conducted output power over the frequency band of operation shall not exceed 250 mW provided the maximum antenna gain does not exceed 6 dBi.

For the band 5.725-5.85 GHz, the maximum conducted output power over the frequency band of operation shall not exceed 1 W.

7.2. Test setup

1. The maximum average conducted output power can be measured using Method PM-G (Measurement using a gated RF average power meter):
2. Measurements may be performed using a wideband gated RF power meter provided that the gate parameters are adjusted such that the power is measured only when the EUT is transmitting at its maximum power control level. Since the measurement is made only during the ON time of the transmitter, no duty cycle correction factor is required.
 - a. The Transmitter output (antenna port) was connected to the power meter.
 - b. Turn on the EUT and power meter and then record the power value.
 - c. Repeat above procedures on all channels needed to be tested.



3.

7.3. Test result

	Frequency (MHz)	Average Output Power(dBm)		Total Power (mW)	Total Power (dBm)	FCC Limit (dBm)	Result
		Ant.1	Ant.2				
802.11a	5745	20.75	20.66	235.26	23.72	30.00	Pass
	5785	20.67	20.58	230.97	23.64	30.00	Pass
	5825	20.62	20.53	228.32	23.59	30.00	Pass
802.11n (HT20)	5745	20.26	20.36	214.81	23.32	30.00	Pass
	5785	20.24	20.27	212.10	23.27	30.00	Pass
	5825	20.31	20.27	213.81	23.30	30.00	Pass



8. PEAK POWER SPECTRAL DENSITY TEST

8.1. Limits

In addition, the maximum power spectral density shall not exceed 11 dBm in any 1 megahertz band.

In addition, the maximum power spectral density shall not exceed 30 dBm in any 500 kHz band.

8.2. Test setup

1. Place the EUT on the table and set it in transmitting mode.
2. The testing follows FCC KDB 789033 D02.
3. Remove the antenna from the EUT and then connect a low loss RF cable from the antenna port to

Spectrum.

4. For U-NII1, U-NII-2A, U-NII-2C Band:

Set RBW=1MHz, VBW=3MHz, where span is enough to capture the entire bandwidth, Sweep time = Auto (601 pts), detector = sample, traces 100 sweeps of video averaging. (SA-2 with the omission of procedure x, the integration with 26dB EBW bandwidth)

For U-NII-3 Band:

Set RBW=510 kHz, VBW=3*RBW, where span is enough to capture the entire bandwidth, Sweep time = Auto (601 pts), detector = sample, traces 100 sweeps of video averaging. (SA-2 with the omission of procedure x, the integration with 26dB EBW bandwidth)

5. Use the cursor on spectrum to peak search the highest level of trace
6. Record the max. reading and add $10 \log(1/\text{duty cycle})$.

we test all antennas, the antenna 1 was worst mode and the data recording in the report.

8.3. Test data

Test data as below

	Frequency (MHz)	Reading Level (dBm)		Duty factor (dB)	Duty factor 10 log (1MHz/RBW)	PPSD (dBm)	FCC Limit (dBm)	Result
		ANT1	ANT2					
802.11a	5745	1.662	1.562	0.21	0.0	4.83	30.00	Pass
	5785	0.727	1.250	0.21	0.0	4.22	30.00	Pass
	5825	-0.121	-0.226	0.21	0.0	3.05	30.00	Pass
802.11n (HT20)	5745	1.568	1.316	0.44	0.0	4.89	30.00	Pass
	5785	1.029	1.006	0.44	0.0	4.47	30.00	Pass
	5825	0.071	1.032	0.44	0.0	4.03	30.00	Pass



802.11a 5745MHz



802.11a 5785MHz



802.11a 5825MHz





802.11n(HT20) 5745MHz

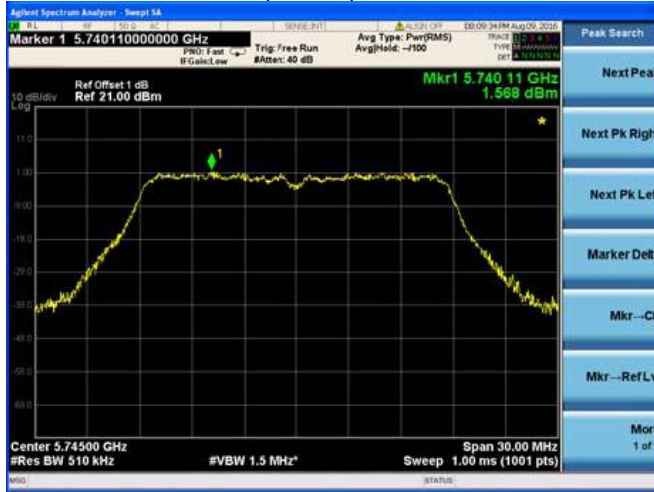

802.11n(HT20) 5785MHz



802.11n(HT20) 5825MHz

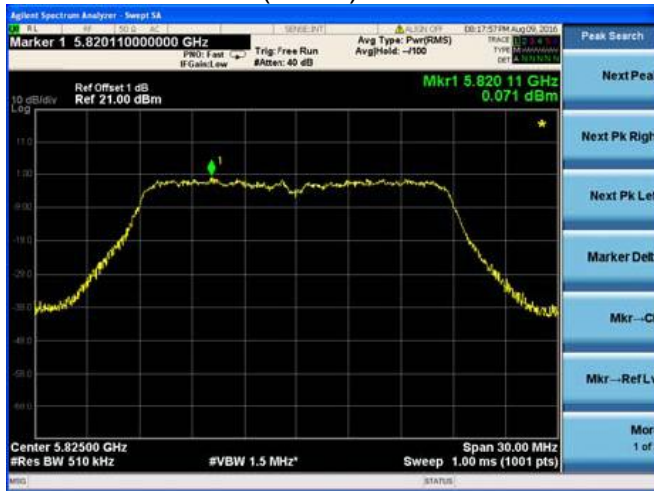



9. DUTY CYCLE TEST SIGNAL

Pre-analysis Check: While conducting average power measurement, duty cycle of each mode shall be checked to ensure its duty cycle in order to compensate for the loss due to insufficient ratio of duty cycle.

All duty cycle is pre-scanned, and result as obtained below shows only the most representative ones where duty cycle is conducted as the given transmission with given virtual operation that expresses the percentage.

Formula:

$$\text{Duty Cycle} = T_{\text{on}} / (T_{\text{on}} + T_{\text{off}})$$

Measurement Procedure:

1. Set span = Zero
2. RBW = 8MHz
3. VBW = 8MHz,
4. Detector = Peak

Duty Cycle:

Operation Mode	Duty Cycle	Duty Fator (dB) $10 * \log (1/ \text{Duty cycle})$
802.11a	95.35%	0.21
802.11n(HT20)	90.78%	0.42



802.11a

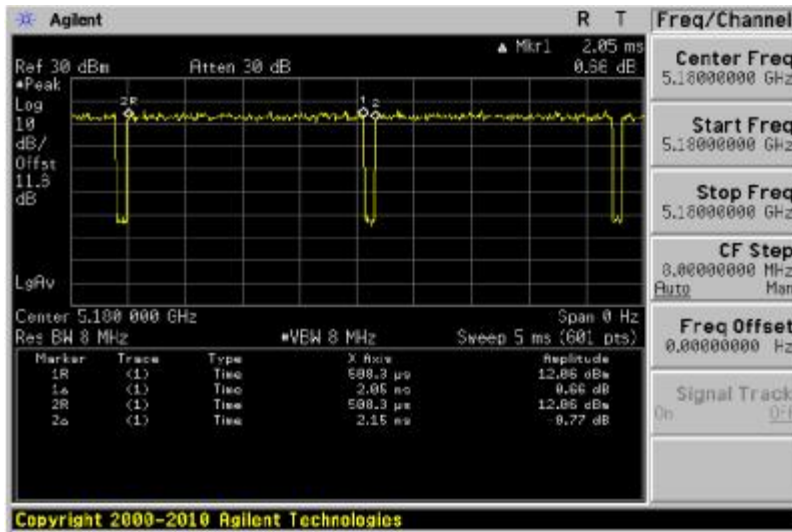

802.11n(HT20)

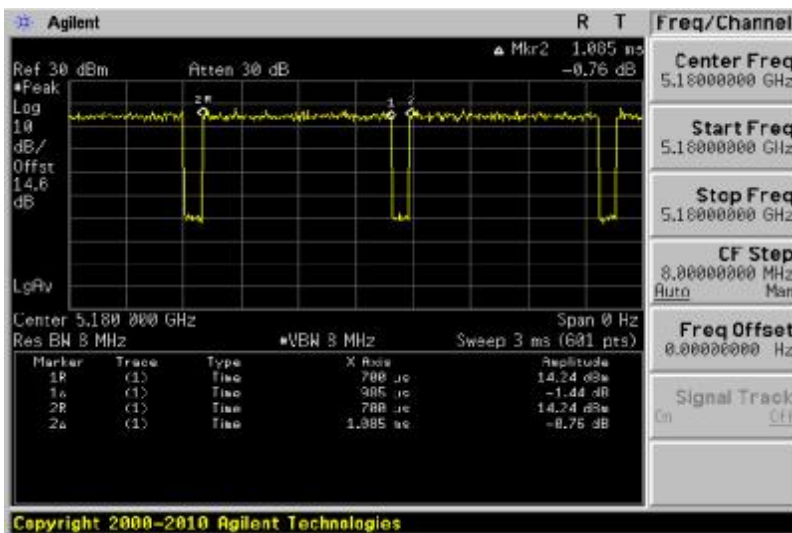



10. FREQUENCY STABILITY

10.1. Limits

Manufactures of U-NII devices are responsible for ensuring frequency stability such that an emission is maintained within the band of operation under all conditions of normal operation as specified in the user's manual. The transmitter center frequency tolerance shall be ± 20 ppm maximum for the 5 GHz band (IEEE 802.11n specification).

10.2. Test setup

1. The transmitter output (antenna port) was connected to the spectrum analyzer.
 2. EUT have transmitted absence of modulation signal and fixed channelize.
 3. Set the spectrum analyzer span to view the entire absence of modulation emissions bandwidth.
 4. Set RBW = 10 kHz, VBW = 10 kHz with peak detector and max hold settings.
 5. f_c is declaring of channel frequency. Then the frequency error formula is $(f_c - f) / f_c \times 10^6$ ppm and the limit is less than ± 20 ppm (IEEE 802.11n specification).
 6. The test extreme voltage is to change the primary supply voltage from 85 to 115 percent of the nominal value
 7. Extreme temperature is $-20^\circ\text{C} \sim 70^\circ\text{C}$.
- we test all antennas, the antenna 1 was worst mode and the data recording in the report.



10.3. Test data

Test data as below

Ref. Freq. (MHz)	Test Voltage (V)	Test Temp. (°C)	Measured Frequency (MHz)	Spectrum Frequency (MHz)	Δ Frequency (MHz)	Deviation (ppm)	Limit (ppm)	Result	
5745	11.40	25	5745	5745.0102	-0.0102	-1.7696	±20	Pass	
	13.11		5745	5745.0088	-0.0088	-1.5329		Pass	
	9.69		5745	5745.0096	-0.0096	-1.6791		Pass	
	11.40		-20	5745	5745.0095	-0.0095		-1.6565	Pass
			-10	5745	5745.0107	-0.0107		-1.8671	Pass
			0	5745	5745.0128	-0.0128		-2.2361	Pass
			10	5745	5745.0137	-0.0137		-2.3823	Pass
			20	5745	5745.0109	-0.0109		-1.8897	Pass
			30	5745	5745.0145	-0.0145		-2.5268	Pass
			40	5745	5745.0107	-0.0107		-1.8671	Pass
			50	5745	5745.0117	-0.0117		-2.0412	Pass
			60	5745	5745.0107	-0.0107		-1.8706	Pass
			70	5745	5745.0114	-0.0114		-1.9907	Pass

Ref. Freq. (MHz)	Test Voltage (V)	Test Temp. (°C)	Measured Frequency (MHz)	Spectrum Frequency (MHz)	Δ Frequency (MHz)	Deviation (ppm)	Limit (ppm)	Result	
5775	11.40	25	5775	5775.0107	-0.0107	-1.8576	±20	Pass	
	13.11		5775	5775.0114	-0.0114	-1.9719		Pass	
	9.69		5775	5775.0110	-0.0110	-1.9130		Pass	
	11.40		-20	5775	5775.0134	-0.0134		-2.3251	Pass
			-10	5775	5775.0125	-0.0125		-2.1693	Pass
			0	5775	5775.0120	-0.0120		-2.0861	Pass
			10	5775	5775.0109	-0.0109		-1.8887	Pass
			20	5775	5775.0118	-0.0118		-2.0515	Pass
			30	5775	5775.0129	-0.0129		-2.2316	Pass
			40	5775	5775.0115	-0.0115		-1.9961	Pass
			50	5775	5775.0110	-0.0110		-1.9078	Pass
			60	5775	5775.0147	-0.0147		-2.5416	Pass
			70	5775	5775.0117	-0.0117		-2.0238	Pass



Ref. Freq. (MHz)	Test Voltage (V)	Test Temp. (°C)	Measured Frequency (MHz)	Spectrum Frequency (MHz)	Δ Frequency (MHz)	Deviation (ppm)	Limit (ppm)	Result	
5785	11.40	25	5785	5785.0104	-0.0104	-1.8003	±20	Pass	
	13.11		5785	5785.0119	-0.0119	-2.0544		Pass	
	9.69		5785	5785.0107	-0.0107	-1.8573		Pass	
	11.40		-20	5785	5785.0117	-0.0117		-2.0198	Pass
			-10	5785	5785.0109	-0.0109		-1.8901	Pass
			0	5785	5785.0125	-0.0125		-2.1650	Pass
			10	5785	5785.0115	-0.0115		-1.9939	Pass
			20	5785	5785.0110	-0.0110		-1.9040	Pass
			30	5785	5785.0114	-0.0114		-1.9748	Pass
			40	5785	5785.0109	-0.0109		-1.8901	Pass
			50	5785	5785.0134	-0.0134		-2.3137	Pass
			60	5785	5785.0137	-0.0137		-2.3742	Pass
			70	5785	5785.0120	-0.0120		-2.0820	Pass



11. TRANSMISSION IN THE ABSENCE OF DATA

11.1. Limits

According to §15.407(c)

The device shall automatically discontinue transmission in case of either absence of information to transmit or operational failure. These provisions are not intended to preclude the transmission of control or signaling information or the use of repetitive codes used by certain digital technologies to complete frame or burst intervals. Applicants shall include in their application for equipment authorization a description of how this requirement is met.

11.2. Test result

No non-compliance noted:

Refer to the theory of operation.



12. ANTENNA REQUIREMENT

12.1. STANDARD REQUIREMENT

15.203 requirement: For intentional device, according to 15.203: an intentional radiator shall be designed to ensure that no antenna other than that furnished by the responsible party shall be used with the device.

12.2. EUT ANTENNA

The EUT antenna is external antenna, and used permanently connected antenna, It comply with the standard requirement.

13. PHOTOGRAPHS OF TEST SET-UP

Radiated Emission Test

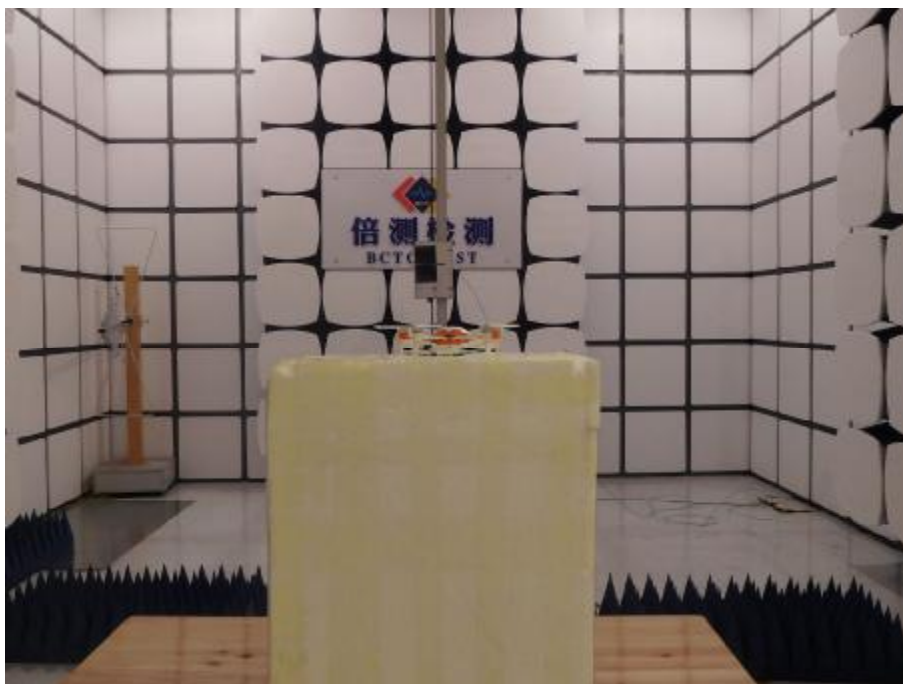

14. PHOTOGRAPHS OF THE EUT



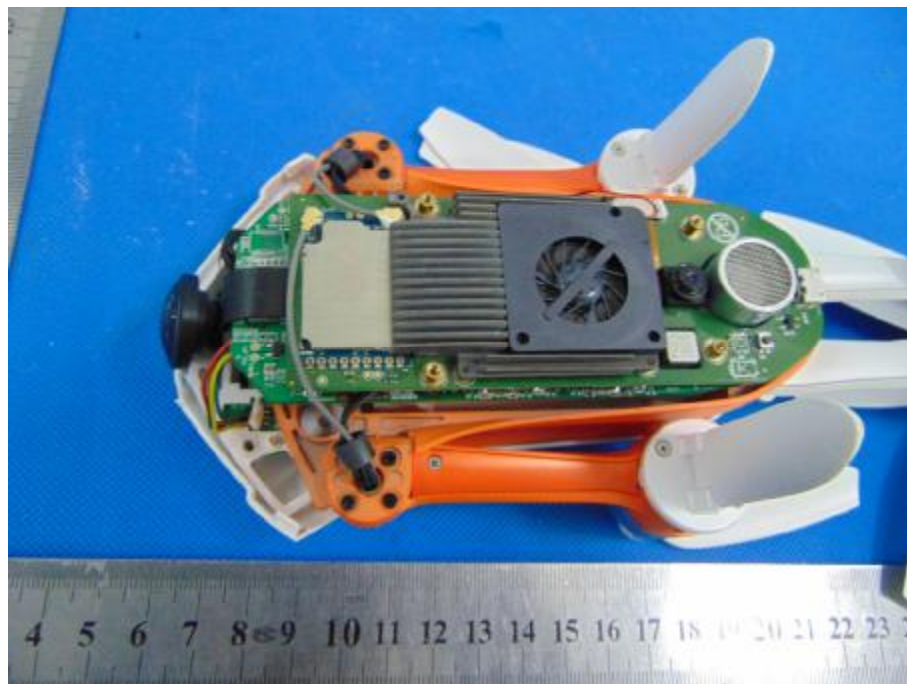

-----END-----