



FCC Part 15C Test Report

FCC ID: 2ALYRHG-C01B

| | |
|------------------|---|
| Product Name: | Amigo Wireless Remote Control |
| Trademark: |  高巨创新 HIGH GREAT |
| Model Name : | HG-C01B |
| Prepared For : | Shenzhen HighGreat Innovation Technology Development Co., Ltd. |
| Address : | NO.6 Yuanlingzai Park, Henggang Town, Longgang District, Shenzhen City, Guangdong Province, China |
| Prepared By : | Shenzhen BCTC Technology Co., Ltd. |
| Address : | No.101, Yousong Road, Longhua New District, Shenzhen,China |
| Test Date: | Jun. 22 – Jul. 03, 2017 |
| Date of Report : | Jul. 03, 2017 |
| Report No.: | BCTC-LH170602435-2E |



VERIFICATION OF COMPLIANCE

Applicant's name.....: **Shenzhen HighGreat Innovation Technology Development Co., Ltd.**

Address: NO.6 Yuanlingzai Park, Henggang Town, Longgang District, Shenzhen City, Guangdong Province, China

Manufacture's Name: **Shenzhen HighGreat Innovation Technology Development Co., Ltd.**

Address: NO.6 Yuanlingzai Park, Henggang Town, Longgang District, Shenzhen City, Guangdong Province, China

Product description

Product name: Amigo Wireless Remote Control

Trademark:  **高巨创新**
HIGH GREAT

Model Name: HG-C01B

Standards: FCC Part15.249
ANSI C63.10-2013

This device described above has been tested by BCTC, and the test results show that the equipment under test (EUT) is in compliance with the FCC requirements. And it is applicable only to the tested sample identified in the report.

This report shall not be reproduced except in full, without the written approval of BCTC, this document may be altered or revised by BCTC, personal only, and shall be noted in the revision of the document.

Test Result: **Pass**

Prepared by(Engineer): Eric Yang

Reviewer(Supervisor): Jade Yang

Approved(Manager): Carson Zhang





| Table of Contents | Page |
|---|-------------|
| 1 . SUMMARY OF TEST RESULTS | 5 |
| 1.1 TEST FACILITY | 5 |
| 1.2 MEASUREMENT UNCERTAINTY | 5 |
| 2 . GENERAL INFORMATION | 6 |
| 2.1 GENERAL DESCRIPTION OF EUT | 6 |
| 2.2 DESCRIPTION OF TEST MODES | 8 |
| 2.3 TABLE OF PARAMETERS OF TEXT SOFTWARE SETTING | 8 |
| 2.4 BLOCK DIGRAM SHOWING THE CONFIGURATION OF SYSTEM TESTED | 8 |
| 2.5 DESCRIPTION OF SUPPORT UNITS(CONDUCTED MODE) | 9 |
| 2.6 EQUIPMENTS LIST FOR ALL TEST ITEMS | 10 |
| 3 . EMC EMISSION TEST | 11 |
| 3.1 CONDUCTED EMISSION MEASUREMENT | 11 |
| 3.1.1 POWER LINE CONDUCTED EMISSION LIMITS | 11 |
| 3.1.2 TEST PROCEDURE | 11 |
| 3.1.3 DEVIATION FROM TEST STANDARD | 11 |
| 3.1.4 TEST SETUP | 12 |
| 3.1.5 EUT OPERATING CONDITIONS | 12 |
| 3.1.6 TEST RESULTS | 13 |
| 3.2 RADIATED EMISSION MEASUREMENT | 15 |
| 3.2.1 RADIATED EMISSION LIMITS | 15 |
| 3.2.2 TEST PROCEDURE | 16 |
| 3.2.3 DEVIATION FROM TEST STANDARD | 16 |
| 3.2.4 TEST SETUP | 17 |
| 3.2.5 EUT OPERATING CONDITIONS | 18 |
| 3.2.6 TEST RESULTS | 19 |
| 4 . BANDWIDTH TEST | 33 |
| 4.1 APPLIED PROCEDURES / LIMIT | 33 |
| 4.1.1 TEST PROCEDURE | 33 |
| 4.1.2 DEVIATION FROM STANDARD | 33 |
| 4.1.3 TEST SETUP | 33 |
| 4.1.4 EUT OPERATION CONDITIONS | 33 |
| 4.1.5 TEST RESULTS | 34 |
| 5 . 100 KHZ BANDWIDTH OF FREQUENCY BAND EDGE | 38 |
| 5.1 DEVIATION FROM STANDARD | 39 |
| 5.2 EUT OPERATION CONDITIONS | 39 |
| 5.3 TEST RESULTS | 39 |

错误！未定义书签。



Table of Contents

Page

| | |
|---------------------------------|-----------|
| 6 . ANTENNA REQUIREMENT | 42 |
| 6.1 STANDARD REQUIREMENT | 42 |
| 6.2 EUT ANTENNA | 42 |
| 7 . EUT TEST PHOTO | 43 |
| 8 . EUT PHOTO | 45 |



1. SUMMARY OF TEST RESULTS

Test procedures according to the technical standards:

| FCC Part15 (15.249) , Subpart C | | | |
|--|---|----------|--------|
| Standard Section | Test Item | Judgment | Remark |
| 15.207(a) | Conducted Emission | PASS | |
| 15.209(a)&&15.249(a) &15.249(c)&15.205(a) | Fundamental &Radiated Spurious Emission Measurement | PASS | |
| 15.215(c) | Bandwidth | PASS | |
| 15.249(d) | Band Edge Emission | PASS | |
| 15.203 | Antenna Requirement | PASS | |

1.1 TEST FACILITY

Shenzhen BCTC Technology Co., Ltd.
Add.:No.101,Yousong Road,Longhua New District, Shenzhen,China
FCC Registration No.:187086

1.2 MEASUREMENT UNCERTAINTY

The reported uncertainty of measurement $y \pm U$, where expended uncertainty U is based on a standard uncertainty multiplied by a coverage factor of $k=2$, providing a level of confidence of approximately 95 % .

| No. | Item | Uncertainty |
|-----|------------------------------|---------------------------|
| 1 | Conducted Emission Test | $\pm 1.38\text{dB}$ |
| 2 | RF power,conducted | $\pm 0.16\text{dB}$ |
| 3 | Spurious emissions,conducted | $\pm 0.21\text{dB}$ |
| 4 | All emissions,radiated(<1G) | $\pm 4.68\text{dB}$ |
| 5 | All emissions,radiated(>1G) | $\pm 4.89\text{dB}$ |
| 6 | Temperature | $\pm 0.5^{\circ}\text{C}$ |
| 7 | Humidity | $\pm 2\%$ |



2. GENERAL INFORMATION

2.1 GENERAL DESCRIPTION OF EUT

| | | | | | | | | | |
|------------------------|---|----------------------|--------------|------------------|------|-------------------|------|----------------------|--------------------|
| Equipment | Amigo Wireless Remote Control | | | | | | | | |
| Trade Name |  高巨创新 HIGH GREAT | | | | | | | | |
| Model Name | HG-C01B | | | | | | | | |
| Serial Model | N/A | | | | | | | | |
| Model Difference | N/A | | | | | | | | |
| Product Description | <table border="1"><tr><td>Operation Frequency:</td><td>5745-5810MHz</td></tr><tr><td>Modulation Type:</td><td>GFSK</td></tr><tr><td>Number Of Channel</td><td>3 CH</td></tr><tr><td>Antenna Designation:</td><td>Please see Note 3.</td></tr></table> | Operation Frequency: | 5745-5810MHz | Modulation Type: | GFSK | Number Of Channel | 3 CH | Antenna Designation: | Please see Note 3. |
| | Operation Frequency: | 5745-5810MHz | | | | | | | |
| | Modulation Type: | GFSK | | | | | | | |
| | Number Of Channel | 3 CH | | | | | | | |
| | Antenna Designation: | Please see Note 3. | | | | | | | |
| | Based on the application, features, or specification exhibited in User's Manual, the EUT is considered as an ITE/Computing Device. More details of EUT technical specification, please refer to the User's Manual. | | | | | | | | |
| Channel List | Please refer to the Note 2. | | | | | | | | |
| Battery | DC 11.4V | | | | | | | | |
| Connecting I/O Port(s) | Please refer to the User's Manual | | | | | | | | |
| hardware version | - | | | | | | | | |
| Software version | - | | | | | | | | |

Note:

1. For a more detailed features description, please refer to the manufacturer's specifications or the User's Manual.

2.

| Channel | Frequency (MHz) |
|---------|-----------------|
| 01 | 5745 |
| 02 | 5777 |
| 03 | 5810 |

3.

Table for Filed Antenna

| Ant | Brand | Model Name | Antenna Type | Connector | Gain (dBi) | NOTE |
|-----|-------|------------|---------------------|-----------|------------|------|
| 1 | N/A | N/A | Integrated antenna1 | N/A | 3dBi | |
| 2 | N/A | N/A | Integrated antenna2 | N/A | 3dBi | |

4.

Note1: Directional Gain=3.0dBi+10log(2)=6dBi

Note2: The EUT is support MIMO mode

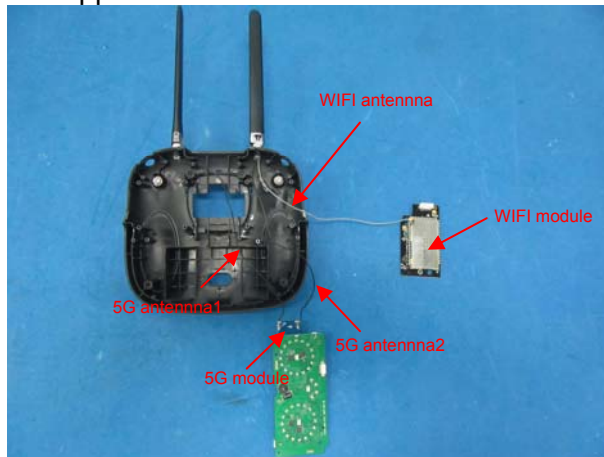



2.2 DESCRIPTION OF TEST MODES

To investigate the maximum EMI emission characteristics generated from EUT, the test system was pre-scanning tested based on the consideration of following EUT operation mode or test configuration mode which possibly have effect on EMI emission level. Each of these EUT operation mode(s) or test configuration mode(s) mentioned above was evaluated respectively.

| For All Mode | Description | Modulation Type |
|--------------|-------------|-----------------|
| Mode 1 | CH01 | GFSK |
| Mode 2 | CH02 | |
| Mode 3 | CH03 | |
| Mode 4 | Link mode | |

Note:

- (1) The measurements are performed at the highest, middle, lowest available channels.
- (2) Fully-charged battery is used during the test

2.3 TABLE OF PARAMETERS OF TEST SOFTWARE SETTING

During testing channel & power controlling software provided by the customer was used to control the operating channel as well as the output power level. The RF output power selection is for the setting of RF output power expected by the customer and is going to be fixed on the firmware of the final end product power parameters

| | | | |
|-----------|----------|----------|----------|
| Frequency | 5745 MHz | 5777 MHz | 5810 MHz |
| Channel | Low | Middle | High |

2.4 BLOCK DIAGRAM SHOWING THE CONFIGURATION OF SYSTEM TESTED

Radiated Spurious Emission Test

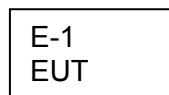

Conducted Emission

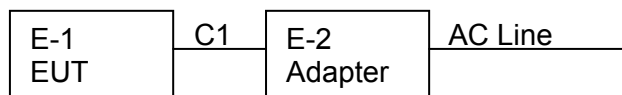



2.5 DESCRIPTION OF SUPPORT UNITS(CONDUCTED MODE)

The EUT has been tested as an independent unit together with other necessary accessories or support units. The following support units or accessories were used to form a representative test configuration during the tests.

| Item | Equipment | Mfr/Brand | Model/Type No. | Series No. | Note |
|------|-------------------------------|--|----------------|------------|-------------|
| E-1 | Amigo Wireless Remote Control |  高巨创新 HIGH GREAT | HG-C01B | N/A | EUT |
| E-2 | Adapter | N/A | KA25-0501000CN | N/A | Lab Provide |
| | | | | | |

| Item | Shielded Type | Ferrite Core | Length | Note |
|------|---------------|--------------|--------|----------------------|
| C-1 | NO | NO | 0.8M | USB cable unshielded |
| | | | | |

Note:

- (1) The support equipment was authorized by Declaration of Confirmation.
- (2) For detachable type I/O cable should be specified the length in cm in 『Length』 column.
- (3) “YES” is means “shielded” “with core”; “NO” is means “unshielded” “without core”.



2.6 EQUIPMENTS LIST FOR ALL TEST ITEMS

Conduction test equipment

| Item | Equipment | Manufacturer | Type No. | Serial No. | Last calibration | Calibrated until |
|------|---------------|--------------|----------|----------------------------|------------------|------------------|
| 1 | Test Receiver | R&S | ESCI | 1166.5950K03-1 01165-ha | 2016.08.27 | 2017.08.26 |
| 2 | LISN | SCHWARZBECK | NSLK8127 | 8127739 | 2016.08.27 | 2017.08.26 |
| 3 | LISN | R&S | NSLK8126 | 8126487 | 2016.08.27 | 2017.08.26 |
| 4 | RF cables | R&S | R204 | R20X | 2016.08.27 | 2017.08.26 |
| 5 | Attenuator | R&S | ESH3-Z2 | 143206 | 2016.08.27 | 2017.08.26 |

Radiation test, Band-edge test and 20db bandwidth test equipment

| Item | Equipment | Manufacturer | Type No. | Serial No. | Last calibration | Calibrated until |
|------|-------------------------------------|-----------------|--------------|------------------|------------------|------------------|
| 1 | Spectrum Analyzer (9kHz-26.5GHz) | Agilent | E4407B | MY45108040 | 2016.08.27 | 2017.08.26 |
| 2 | Test Receiver (9kHz-7GHz) | R&S | ESPI | 101318 | 2016.08.27 | 2017.08.26 |
| 3 | Bilog Antenna (30MHz-1GHz) | R&S | VULB 9168 | VULB91 68-438 | 2016.08.27 | 2017.08.26 |
| 4 | Horn Antenna (1GHz-18GHz) | SCHWARZBECK | BBHA9120D | 1201 | 2016.09.03 | 2017.09.03 |
| 5 | Horn Antenna (14GHz-40GHz) | SCHWARZBECK | BBHA 9170 | 9170-181 | 2016.09.03 | 2017.09.03 |
| 6 | Amplifier (9KHz-6GHz) | SCHWARZBECK | BBV9744 | 9744-0037 | 2016.08.27 | 2017.08.26 |
| 7 | Amplifier (1GHz-18GHz) | SCHWARZBECK | BBV9718 | 9718-309 | 2016.08.27 | 2017.08.26 |
| 8 | Amplifier (18GHz-40GHz) | SCHWARZBECK | BBV 9721 | 9721-205 | 2016.08.27 | 2017.08.26 |
| 9 | Loop Antenna (9KHz-30MHz) | SCHWARZBECK | FMZB1519B | 00014 | 2016.09.03 | 2017.09.03 |
| 10 | RF cables1 (9kHz-1GHz) | R&S | R203 | R20X | 2016.08.27 | 2017.08.26 |
| 11 | RF cables2 (1GHz-40GHz) | R&S | R204 | R21X | 2016.08.27 | 2017.08.26 |
| 12 | Antenna connector | Florida RF Labs | N/A | RF 01# | 2016.08.27 | 2017.08.26 |
| 13 | Power Metter | ANRITSU | ML2487A | 6K00001568 | 2016.08.27 | 2017.08.26 |
| 14 | Power Sensor (AV) | ANRITSU | ML2491A | 030989 | 2016.08.27 | 2017.08.26 |
| 15 | Signal Analyzer 9kHz-26.5GHz | Agilent | N9010A | MY48030494 | 2016.08.27 | 2017.08.26 |
| 16 | Test Receiver 20kHz-40GHz | R&S | ESU 40 | 100376 | 2016.08.27 | 2017.08.26 |
| 17 | D.C. Power Supply | LongWei | PS-305D | 010964729 | 2016.08.27 | 2017.08.26 |



3. EMC EMISSION TEST

3.1 CONDUCTED EMISSION MEASUREMENT

3.1.1 POWER LINE CONDUCTED EMISSION Limits (Frequency Range 150KHz-30MHz)

| FREQUENCY (MHz) | Limit (dBuV) | | Standard |
|-----------------|--------------|-----------|----------|
| | Quasi-peak | Average | |
| 0.15 -0.5 | 66 - 56 * | 56 - 46 * | FCC |
| 0.50 -5.0 | 56.00 | 46.00 | FCC |
| 5.0 -30.0 | 60.00 | 50.00 | FCC |

Note:

- (1) The tighter limit applies at the band edges.
- (2) The limit of " * " marked band means the limitation decreases linearly with the logarithm of the frequency in the range.

The following table is the setting of the receiver

| Receiver Parameters | Setting |
|---------------------|----------|
| Attenuation | 10 dB |
| Start Frequency | 0.15 MHz |
| Stop Frequency | 30 MHz |
| IF Bandwidth | 9 kHz |

3.1.2 TEST PROCEDURE

- a. The EUT was placed 0.8 meters from the horizontal ground plane with EUT being connected to the power mains through a line impedance stabilization network (LISN). All other support equipments powered from additional LISN(s). The LISN provide 50 Ohm/ 50uH of coupling impedance for the measuring instrument.
- b. Interconnecting cables that hang closer than 40 cm to the ground plane shall be folded back and forth in the center forming a bundle 30 to 40 cm long.
- c. I/O cables that are not connected to a peripheral shall be bundled in the center. The end of the cable may be terminated, if required, using the correct terminating impedance. The overall length shall not exceed 1 m.
- d. LISN at least 80 cm from nearest part of EUT chassis.
- e. For the actual test configuration, please refer to the related Item –EUT Test Photos.

3.1.3 DEVIATION FROM TEST STANDARD

No deviation

3.1.4 TEST SETUP

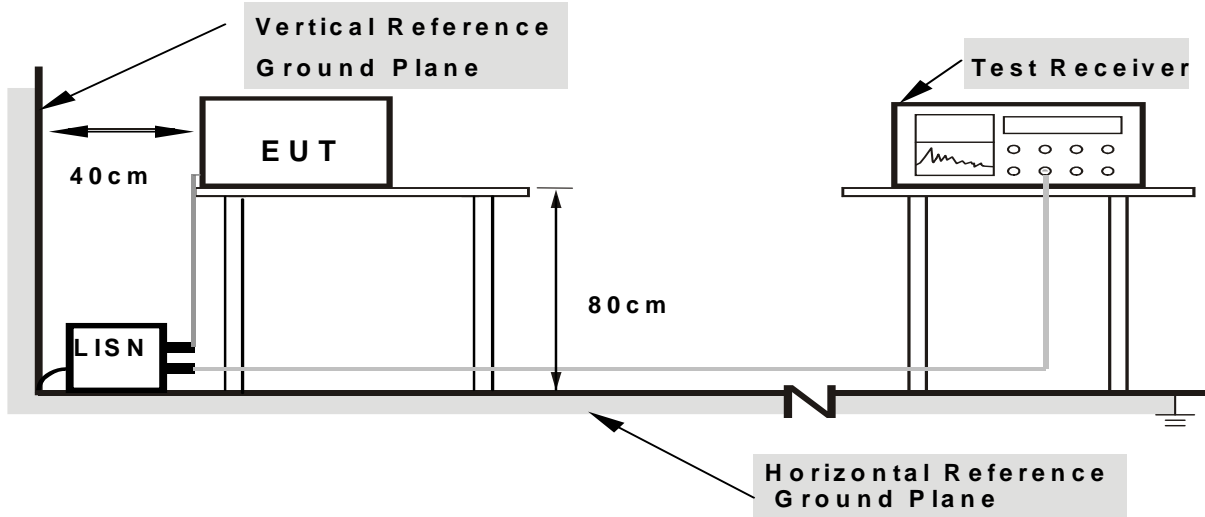

Note: 1.Support units were connected to second LISN.

2.Both of LISNs (AMN) are 80 cm from EUT and at least 80 cm from other units and other metal planes

3.1.5 EUT OPERATING CONDITIONS

The EUT was configured for testing in a typical fashion (as a customer would normally use it). The EUT has been programmed to continuously transmit during test. This operating condition was tested and used to collect the included data.



3.1.6 TEST RESULTS

| | | | |
|----------------|-------------|---------------------|--------|
| Temperature : | 26°C | Relative Humidity : | 54% |
| Pressure : | 1010hPa | Phase : | L |
| Test Voltage : | AC120V/60Hz | Test Mode : | Mode 4 |

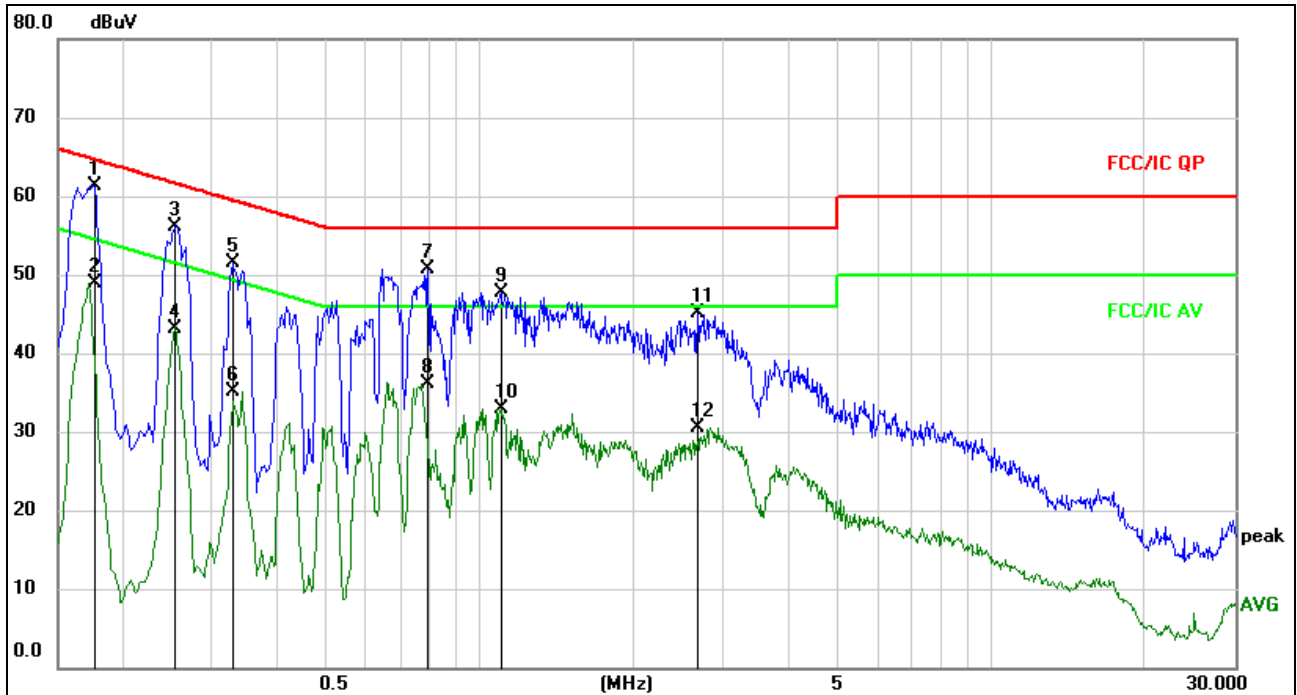

Remark:

1. All readings are Quasi-Peak and Average values.
2. Factor = Insertion Loss + Cable Loss.

| No. Mk. | Freq. MHz | Reading Level dBuV | Correct Factor dB | Measure- ment dBuV | Limit dBuV | Over dB | Detector | Comment |
|---------|--------------|--------------------------|-------------------------|--------------------------|---------------|------------|----------|---------|
| 1 * | 0.1770 | 51.67 | 9.66 | 61.33 | 64.63 | -3.30 | QP | |
| 2 | 0.1770 | 39.20 | 9.66 | 48.86 | 54.63 | -5.77 | AVG | |
| 3 | 0.2535 | 46.47 | 9.66 | 56.13 | 61.64 | -5.51 | QP | |
| 4 | 0.2535 | 33.54 | 9.66 | 43.20 | 51.64 | -8.44 | AVG | |
| 5 | 0.3300 | 41.82 | 9.66 | 51.48 | 59.45 | -7.97 | QP | |
| 6 | 0.3300 | 25.42 | 9.66 | 35.08 | 49.45 | -14.37 | AVG | |
| 7 | 0.7935 | 41.05 | 9.68 | 50.73 | 56.00 | -5.27 | QP | |
| 8 | 0.7935 | 26.41 | 9.68 | 36.09 | 46.00 | -9.91 | AVG | |
| 9 | 1.1040 | 38.08 | 9.69 | 47.77 | 56.00 | -8.23 | QP | |
| 10 | 1.1040 | 23.22 | 9.69 | 32.91 | 46.00 | -13.09 | AVG | |
| 11 | 2.6655 | 35.41 | 9.72 | 45.13 | 56.00 | -10.87 | QP | |
| 12 | 2.6655 | 20.83 | 9.72 | 30.55 | 46.00 | -15.45 | AVG | |



| | | | |
|----------------|-------------|---------------------|--------|
| Temperature : | 26°C | Relative Humidity : | 54% |
| Pressure : | 1010hPa | Phase : | N |
| Test Voltage : | AC120V/60Hz | Test Mode : | Mode 4 |

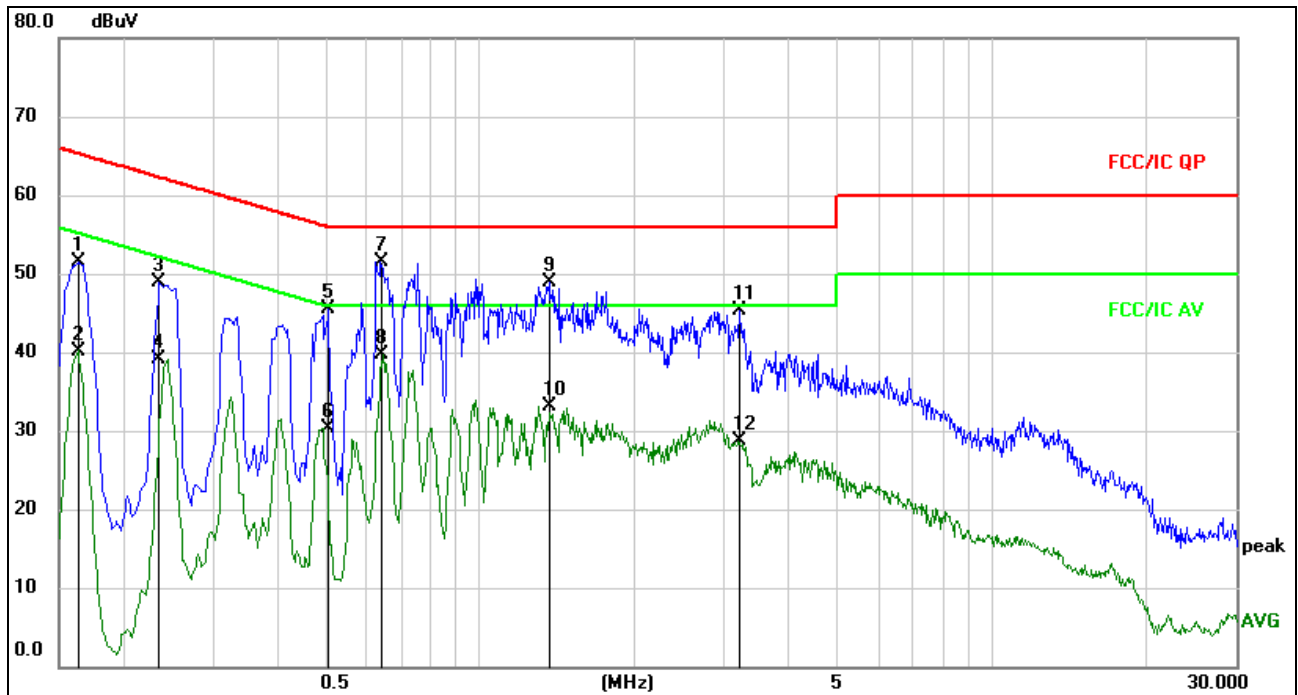

Remark:

1. All readings are Quasi-Peak and Average values.
2. Factor = Insertion Loss + Cable Loss.

| No. Mk. | Freq. MHz | Reading Level dBuV | Correct Factor dB | Measure- ment dBuV | Limit dBuV | Over dB | Detector | Comment |
|---------|--------------|--------------------------|-------------------------|--------------------------|---------------|------------|----------|---------|
| 1 | 0.1635 | 41.75 | 9.66 | 51.41 | 65.28 | -13.87 | QP | |
| 2 | 0.1635 | 30.54 | 9.66 | 40.20 | 55.28 | -15.08 | AVG | |
| 3 | 0.2355 | 39.17 | 9.65 | 48.82 | 62.25 | -13.43 | QP | |
| 4 | 0.2355 | 29.45 | 9.65 | 39.10 | 52.25 | -13.15 | AVG | |
| 5 | 0.5055 | 35.74 | 9.68 | 45.42 | 56.00 | -10.58 | QP | |
| 6 | 0.5055 | 20.72 | 9.68 | 30.40 | 46.00 | -15.60 | AVG | |
| 7 * | 0.6405 | 41.88 | 9.68 | 51.56 | 56.00 | -4.44 | QP | |
| 8 | 0.6405 | 29.93 | 9.68 | 39.61 | 46.00 | -6.39 | AVG | |
| 9 | 1.3650 | 39.14 | 9.70 | 48.84 | 56.00 | -7.16 | QP | |
| 10 | 1.3650 | 23.35 | 9.70 | 33.05 | 46.00 | -12.95 | AVG | |
| 11 | 3.2190 | 35.58 | 9.72 | 45.30 | 56.00 | -10.70 | QP | |
| 12 | 3.2190 | 18.90 | 9.72 | 28.62 | 46.00 | -17.38 | AVG | |



3.2 RADIATED EMISSION MEASUREMENT

3.2.1 RADIATED EMISSION LIMITS (Frequency Range 9kHz-1000MHz)

20dBc in any 100 kHz bandwidth outside the operating frequency band. In case the emission fall within the restricted band specified on 15.205(a), then the 15.209(a) limit in the table below has to be followed.

| Frequencies (MHz) | Field Strength (microrvolts/meter) | Measurement Distance (meters) |
|-------------------|------------------------------------|-------------------------------|
| 0.009~0.490 | 2400/F(KHz) | 300 |
| 0.490~1.705 | 24000/F(KHz) | 30 |
| 1.705~30.0 | 30 | 30 |
| 30~88 | 100 | 3 |
| 88~216 | 150 | 3 |
| 216~960 | 200 | 3 |
| Above 960 | 500 | 3 |

LIMITS OF RADIATED EMISSION MEASUREMENT (Above 1000MHz)

| FREQUENCY (MHz) | Limit (dBuV/m) (at 3M) | |
|-----------------|------------------------|---------|
| | PEAK | AVERAGE |
| Above 1000 | 74 | 54 |

Notes:

- (1) The limit for radiated test was performed according to FCC PART 15C.
- (2) The tighter limit applies at the band edges.
- (3) Emission level (dBuV/m)=20log Emission level (uV/m).

FREQUENCY RANGE OF RADIATED MEASUREMENT (For unintentional radiators)

| Highest frequency generated or Upper frequency of measurement used in the device or on which the device operates or tunes (MHz) | Range (MHz) |
|---|---|
| Below 1.705 | 30 |
| 1.705 – 108 | 1000 |
| 108 – 500 | 2000 |
| 500 – 1000 | 5000 |
| Above 1000 | 5 th harmonic of the highest frequency or 40 GHz, whichever is lower |



| Spectrum Parameter | Setting |
|---------------------------------------|--|
| Attenuation | Auto |
| Start Frequency | 1000 MHz |
| Stop Frequency | 10th carrier harmonic |
| RB / VB (emission in restricted band) | 1 MHz / 1 MHz for Peak, 1 MHz / 10Hz for Average |

| Receiver Parameter | Setting |
|------------------------|----------------------------------|
| Attenuation | Auto |
| Start ~ Stop Frequency | 9kHz~150kHz / RB 200Hz for QP |
| Start ~ Stop Frequency | 150kHz~30MHz / RB 9kHz for QP |
| Start ~ Stop Frequency | 30MHz~1000MHz / RB 120kHz for QP |

3.2.2 TEST PROCEDURE

- a. The measuring distance of at 3 m shall be used for measurements at frequency up to 25GHz. For frequencies above 1GHz, any suitable measuring distance may be used.
- b. The EUT was placed on the top of a rotating table 0.8 and 1.5 meters above the ground at a 3 meter semi-chamber test. The table was rotated 360 degrees to determine the position of the highest radiation.
- c. The height of the equipment or of the substitution antenna shall be 0.8 m; above 1GHz, the height was 1.5m, the height of the test antenna shall vary between 1 m to 4 m. Both horizontal and vertical polarizations of the antenna are set to make the measurement.
- d. The initial step in collecting conducted emission data is a spectrum analyzer peak detector mode pre-scanning the measurement frequency range. Significant peaks are then marked and then Quasi Peak detector mode re-measured.
- e. If the Peak Mode measured value compliance with and lower than Quasi Peak Mode Limit, the EUT shall be deemed to meet QP Limits and then no additional QP Mode measurement performed.
- f. For the actual test configuration, please refer to the related Item –EUT Test Photos.
- g. For the radiated emission test above 1GHz:
Place the measurement antenna away from each area of the EUT determined to be a source of emissions at the specified measurement distance, while keeping the measurement antenna aimed at the source of emissions at each frequency of significant emissions, with polarization oriented for maximum response.
The measurement antenna may have to be higher or lower than the EUT, depending on the radiation pattern of the emission and staying aimed at the emission source for receiving the maximum signal. The final measurement antenna elevation shall be that which maximizes the emissions. The measurement antenna elevation for maximum emissions shall be restricted to a range of heights of from 1 m to 4 m above the ground or reference ground plane.

Note:

Both horizontal and vertical antenna polarities were tested and performed pretest to three orthogonal axis. The worst case emissions were reported

3.2.3 DEVIATION FROM TEST STANDARD

No deviation

3.2.4 TEST SETUP

(A) Radiated Emission Test-Up Frequency Below 30MHz

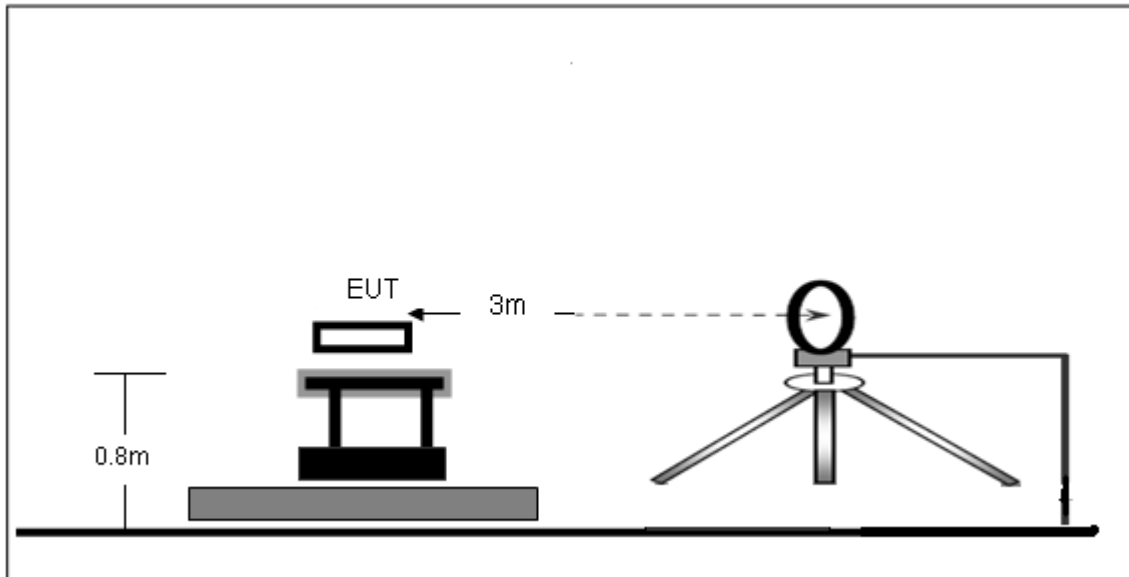

(B) Radiated Emission Test-Up Frequency 30MHz~1GHz

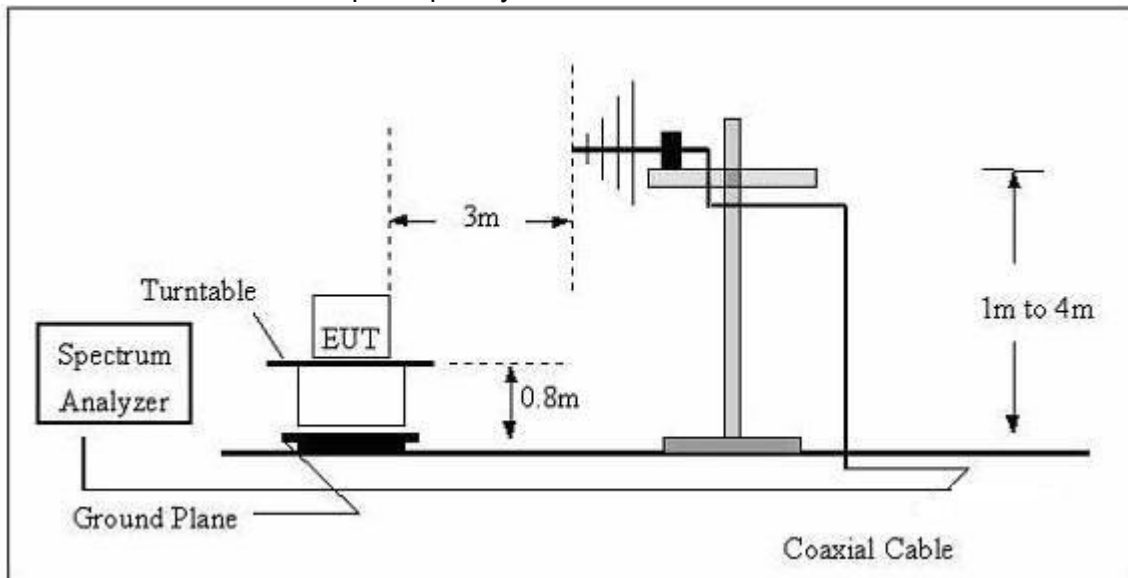

(C) Radiated Emission Test-Up Frequency Above 1GHz

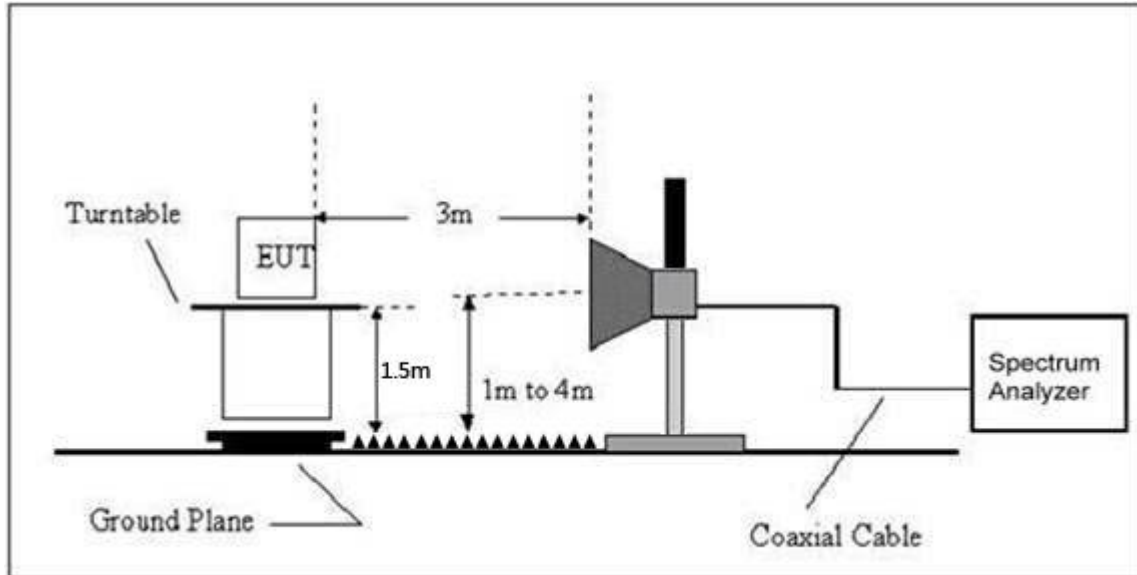

3.2.5 EUT OPERATING CONDITIONS

The EUT tested system was configured as the statements of 2.4 Unless otherwise a special operating condition is specified in the follows during the testing.



3.2.6 TEST RESULTS

Radiated Spurious Emission (Below 30MHz)

| | | | |
|----------------|----------|---------------------|-----|
| Temperature : | 25 °C | Relative Humidity : | 55% |
| Pressure : | 1010 hPa | Polarization : | --- |
| Test Voltage : | DC 11.4V | | |
| Test Mode : | Mode 4 | | |

| Freq. | Reading | Limit | Margin | State |
|-------|----------|----------|--------|-------|
| (MHz) | (dBuV/m) | (dBuV/m) | (dB) | P/F |
| -- | -- | -- | -- | PASS |
| -- | -- | -- | -- | PASS |

NOTE:

The amplitude of spurious emissions which are attenuated by more than 20dB below the permissible value has no need to be reported.

Distance extrapolation factor = $40 \log(\text{specific distance}/\text{test distance})$ (dB);

Limit line = specific limits(dBuv) + distance extrapolation factor.



Radiated Spurious Emission (Between 30MHz – 1GHz)

| | | | |
|------------------------|----------|---------------------|------------|
| Temperature : | 25 °C | Relative Humidity : | 55% |
| Pressure : | 1010 hPa | Polarization : | Horizontal |
| Test Voltage : | DC 11.4V | | |
| Test Mode : (Worst) | Mode 4 | | |

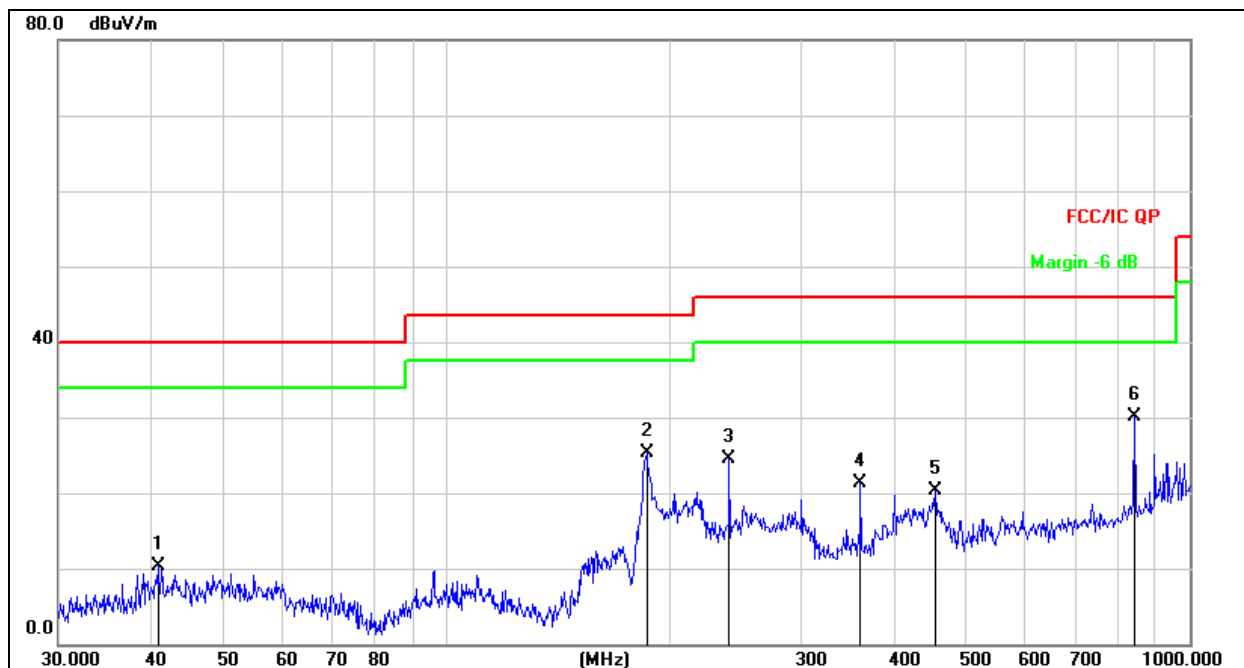

Remark:
Factor = Antenna Factor + Cable Loss – Pre-amplifier.

| No. | Mk. | Freq. | Reading Level | Correct Factor | Measurement | Limit | Over | Detector |
|-----|-----|----------|---------------|----------------|-------------|-------|--------|----------|
| | | MHz | dBuV | dB | dBuV/m | dB/m | dB | |
| 1 | | 40.8446 | 24.89 | -14.61 | 10.28 | 40.00 | -29.72 | QP |
| 2 | | 185.7882 | 42.87 | -17.50 | 25.37 | 43.50 | -18.13 | QP |
| 3 | | 239.9874 | 40.09 | -15.52 | 24.57 | 46.00 | -21.43 | QP |
| 4 | | 360.4476 | 33.48 | -12.18 | 21.30 | 46.00 | -24.70 | QP |
| 5 | | 454.3100 | 30.92 | -10.59 | 20.33 | 46.00 | -25.67 | QP |
| 6 | * | 842.1296 | 33.65 | -3.54 | 30.11 | 46.00 | -15.89 | QP |



| | | | |
|------------------------|----------|---------------------|----------|
| Temperature : | 25 °C | Relative Humidity : | 55% |
| Pressure : | 1010 hPa | Polarization : | Vertical |
| Test Voltage : | DC 11.4V | | |
| Test Mode : (Worst) | Mode 4 | | |

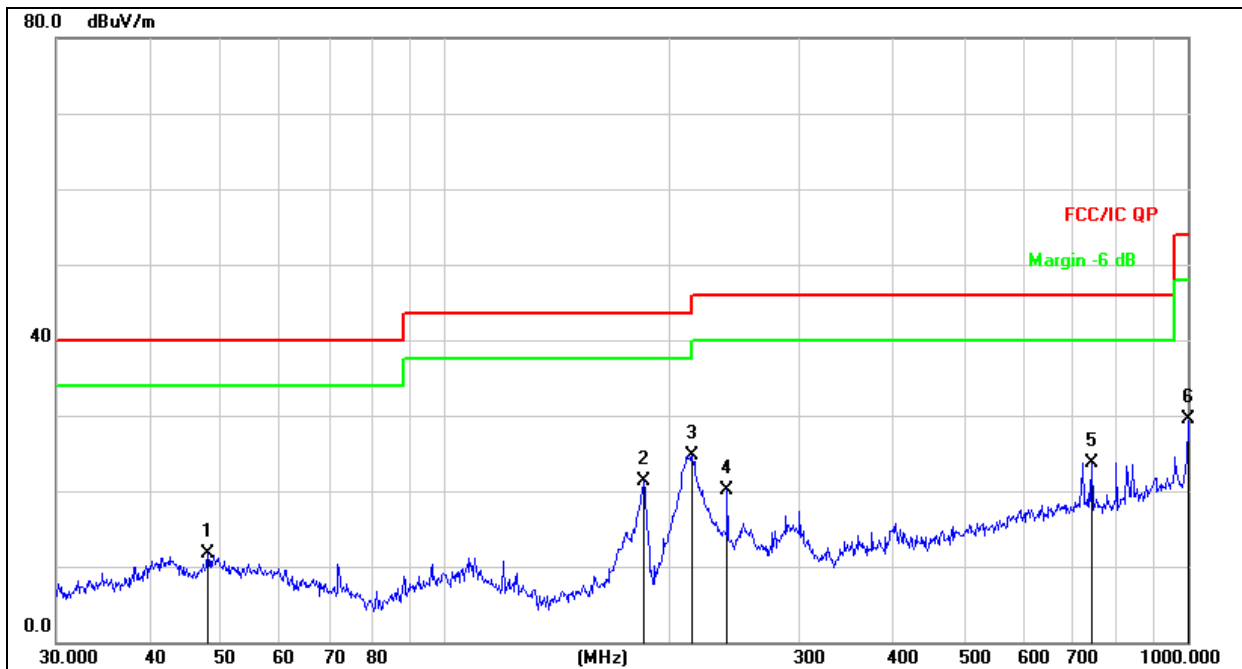

Remark:
Factor = Antenna Factor + Cable Loss – Pre-amplifier.

| No. | Mk. | Freq. MHz | Reading Level dBuV | Correct Factor dB | Measure- ment dBuV/m | Limit dB/m | Over dB | Detector |
|-----|-----|--------------|--------------------------|-------------------------|----------------------------|---------------|------------|----------|
| 1 | | 47.9940 | 25.60 | -13.98 | 11.62 | 40.00 | -28.38 | QP |
| 2 | | 185.1379 | 38.89 | -17.57 | 21.32 | 43.50 | -22.18 | QP |
| 3 | * | 215.2678 | 40.82 | -16.19 | 24.63 | 43.50 | -18.87 | QP |
| 4 | | 239.9874 | 35.54 | -15.52 | 20.02 | 46.00 | -25.98 | QP |
| 5 | | 742.2587 | 28.79 | -5.03 | 23.76 | 46.00 | -22.24 | QP |
| 6 | | 1000.000 | 30.95 | -1.54 | 29.41 | 54.00 | -24.59 | QP |



Radiated Spurious Emission (1GHz to 10th harmonics)

| | Freq. | Receiver Reading | Detector | Polar | Pre-amplifier | Cable Loss | Antenna Factor | Emission Level | Limit | Margin | Result | |
|--------------------------|---------------------------|------------------|-------------|-------|---------------|------------|----------------|----------------|----------|--------|--------|------|
| | (MHz) | (dBμV) | (PK/QP/Ave) | (H/V) | (dB) | (dB) | (dB) | (dBμV/m) | (dBμV/m) | | | |
| Lower Channel 5745MHz | 5745.00 | 111.55 | PK | H | 38.11 | 7.44 | 20.36 | 101.24 | 114 | -12.76 | Pass | |
| | 5745.00 | 96.72 | Ave | H | 38.11 | 7.44 | 20.36 | 86.41 | 94 | -7.59 | Pass | |
| | 11490.00 | 41.60 | PK | H | 34.25 | 6.48 | 29.46 | 43.29 | 74.00 | -30.71 | Pass | |
| | 11490.00 | 32.61 | Ave | H | 33.25 | 6.48 | 29.46 | 35.30 | 54.00 | -18.70 | Pass | |
| | 17235.00 | 43.32 | PK | H | 34.83 | 6.96 | 26.88 | 42.33 | 74.00 | -31.67 | Pass | |
| | 17235.00 | 32.65 | Ave | H | 34.83 | 6.96 | 26.88 | 31.66 | 54.00 | -22.34 | Pass | |
| | 5745.00 | 114.03 | PK | V | 38.11 | 7.44 | 20.36 | 103.72 | 114 | -10.28 | Pass | |
| | 5745.00 | 94.43 | Ave | V | 38.11 | 7.44 | 20.36 | 84.12 | 94 | -9.88 | Pass | |
| | 11490.00 | 41.30 | PK | V | 34.25 | 6.48 | 29.46 | 42.99 | 74.00 | -31.01 | Pass | |
| | 11490.00 | 32.44 | Ave | V | 33.25 | 6.48 | 29.46 | 35.13 | 54.00 | -18.87 | Pass | |
| | 17235.00 | 43.57 | PK | V | 34.83 | 6.96 | 26.88 | 42.58 | 74.00 | -31.42 | Pass | |
| | 17235.00 | 32.45 | Ave | V | 34.83 | 6.96 | 26.88 | 31.46 | 54.00 | -22.54 | Pass | |
| | Middle Channel 5777MHz | 5777.00 | 109.95 | PK | H | 38.11 | 7.44 | 20.36 | 99.64 | 114 | -14.36 | Pass |
| | | 5777.00 | 93.21 | Ave | H | 38.11 | 7.44 | 20.36 | 82.90 | 94 | -11.10 | Pass |
| 11554.00 | | 42.31 | PK | H | 33.95 | 6.89 | 29.36 | 44.61 | 74.00 | -29.39 | Pass | |
| 11554.00 | | 32.85 | Ave | H | 33.95 | 6.89 | 29.36 | 35.15 | 54.00 | -18.85 | Pass | |
| 17331.00 | | 42.92 | PK | H | 35.25 | 7.10 | 27.22 | 41.99 | 74.00 | -32.01 | Pass | |
| 17331.00 | | 33.32 | Ave | H | 35.25 | 7.10 | 27.22 | 32.39 | 54.00 | -21.61 | Pass | |
| 5777.00 | | 112.07 | PK | V | 38.11 | 7.44 | 20.36 | 101.76 | 114 | -12.24 | Pass | |
| 5777.00 | | 91.20 | Ave | V | 38.11 | 7.44 | 20.36 | 80.89 | 94 | -13.11 | Pass | |
| 11554.00 | | 42.24 | PK | V | 33.95 | 6.89 | 29.36 | 44.54 | 74.00 | -29.46 | Pass | |
| 11554.00 | | 32.63 | Ave | V | 33.95 | 6.89 | 29.36 | 34.93 | 54.00 | -19.07 | Pass | |
| 17331.00 | | 43.81 | PK | V | 35.25 | 7.10 | 27.22 | 42.88 | 74.00 | -31.12 | Pass | |
| 17331.00 | 32.37 | Ave | V | 35.25 | 7.10 | 27.22 | 31.44 | 54.00 | -22.56 | Pass | | |
| Upper Channel 5810MHz | 5810.00 | 111.71 | PK | H | 38.17 | 7.47 | 20.51 | 101.52 | 114 | -12.48 | Pass | |
| | 5810.00 | 95.02 | Ave | H | 38.17 | 7.47 | 20.51 | 84.83 | 94 | -9.17 | Pass | |
| | 11620.00 | 41.92 | PK | H | 34.35 | 7.15 | 30.15 | 44.87 | 74.00 | -29.13 | Pass | |



| | | | | | | | | | | | |
|--|----------|--------|-----|---|-------|------|-------|--------|-------|--------|------|
| | 11620.00 | 30.84 | Ave | H | 34.35 | 7.15 | 30.15 | 33.79 | 54.00 | -20.21 | Pass |
| | 17430.00 | 44.55 | PK | H | 35.75 | 7.45 | 28.54 | 44.79 | 74.00 | -29.21 | Pass |
| | 17430.00 | 32.92 | Ave | H | 35.75 | 7.45 | 28.54 | 33.16 | 54.00 | -20.84 | Pass |
| | 5810.00 | 114.75 | PK | V | 38.17 | 7.47 | 20.51 | 104.56 | 114 | -9.44 | Pass |
| | 5810.00 | 93.06 | Ave | V | 38.17 | 7.47 | 20.51 | 82.87 | 94 | -11.13 | Pass |
| | 11620.00 | 43.23 | PK | V | 34.35 | 7.15 | 30.15 | 46.18 | 74.00 | -27.82 | Pass |
| | 11620.00 | 31.91 | Ave | V | 34.35 | 7.15 | 30.15 | 34.86 | 54.00 | -19.14 | Pass |
| | 17430.00 | 44.01 | PK | V | 35.75 | 7.45 | 28.54 | 44.25 | 74.00 | -29.75 | Pass |
| | 17430.00 | 33.04 | Ave | V | 35.75 | 7.45 | 28.54 | 33.28 | 54.00 | -20.72 | Pass |

Remark:

Factor = Antenna Factor + Cable Loss – Pre-amplifier.

Emission Level = Meter Reading + Factor

Margin = Emission Level - Limit

Other harmonics emissions are lower than 20dB below the allowable limit.



5745MHz Horizontal

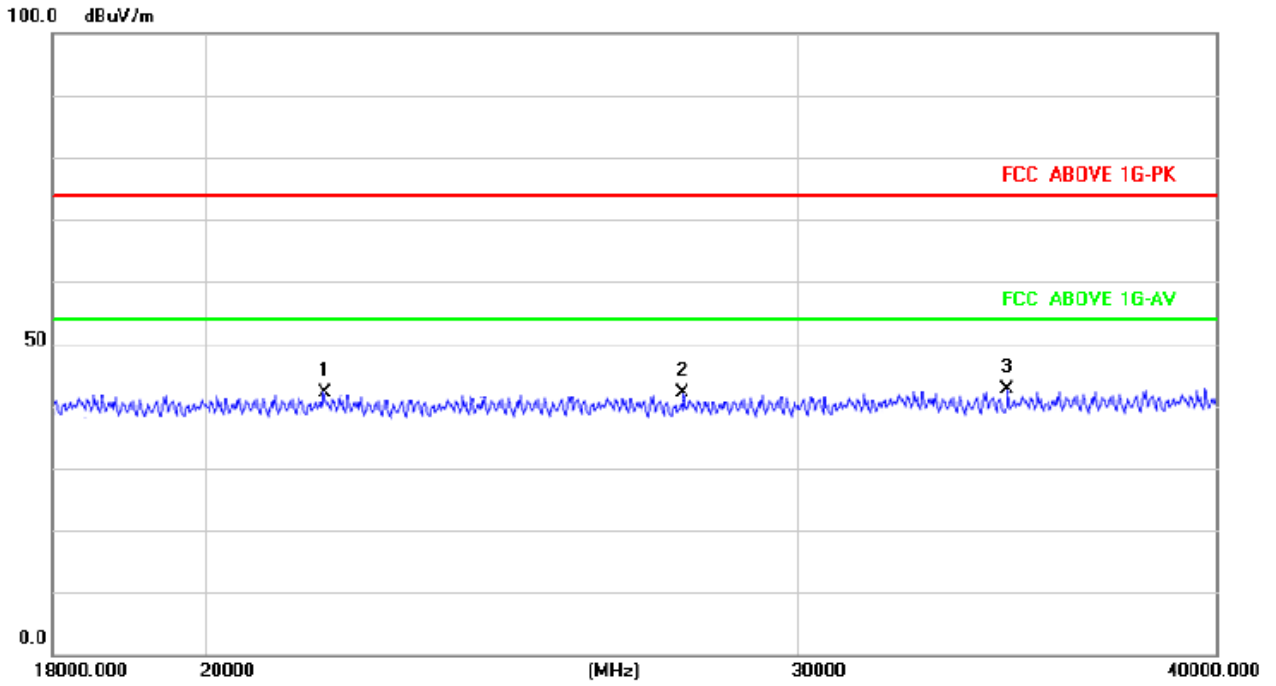

5745MHz Vertical

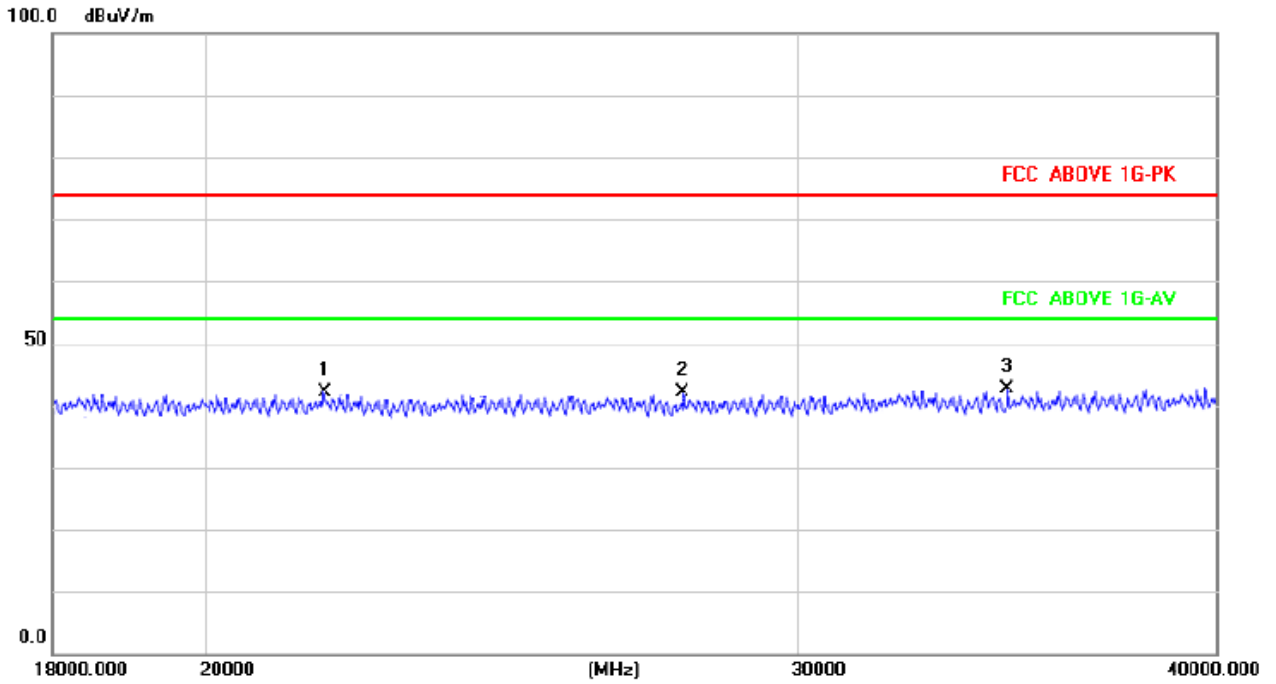



5777MHz Horizontal

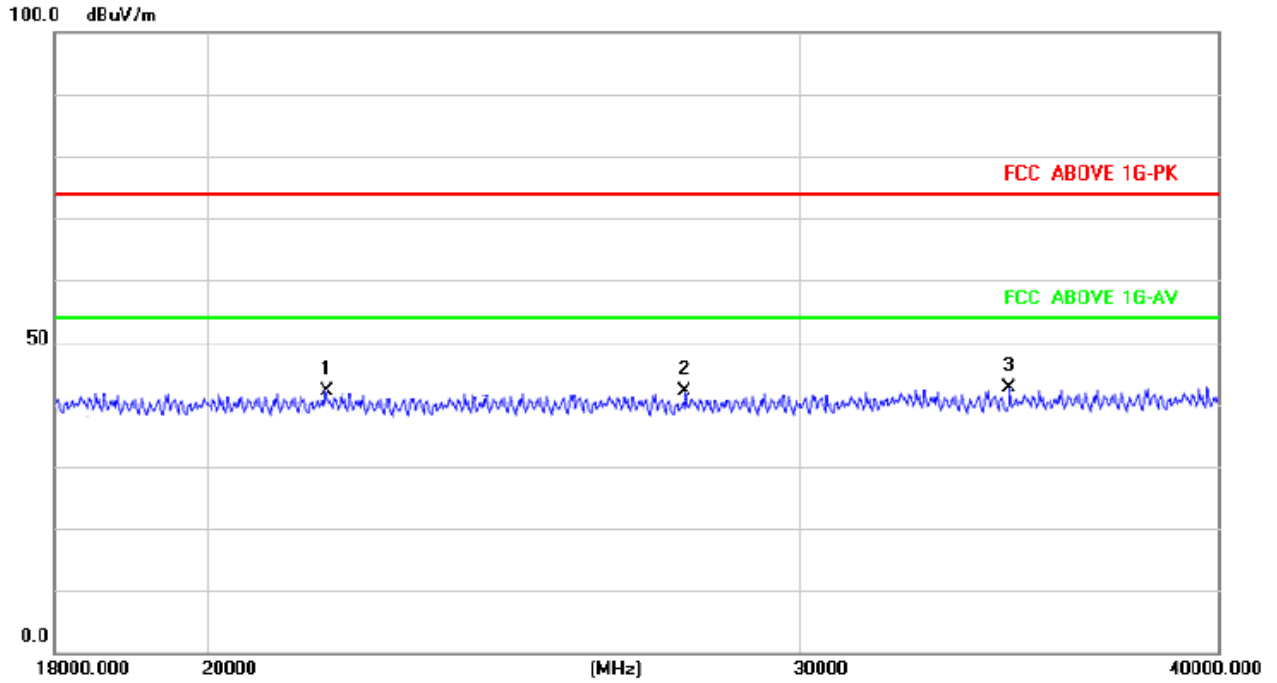

5777MHz Vertical

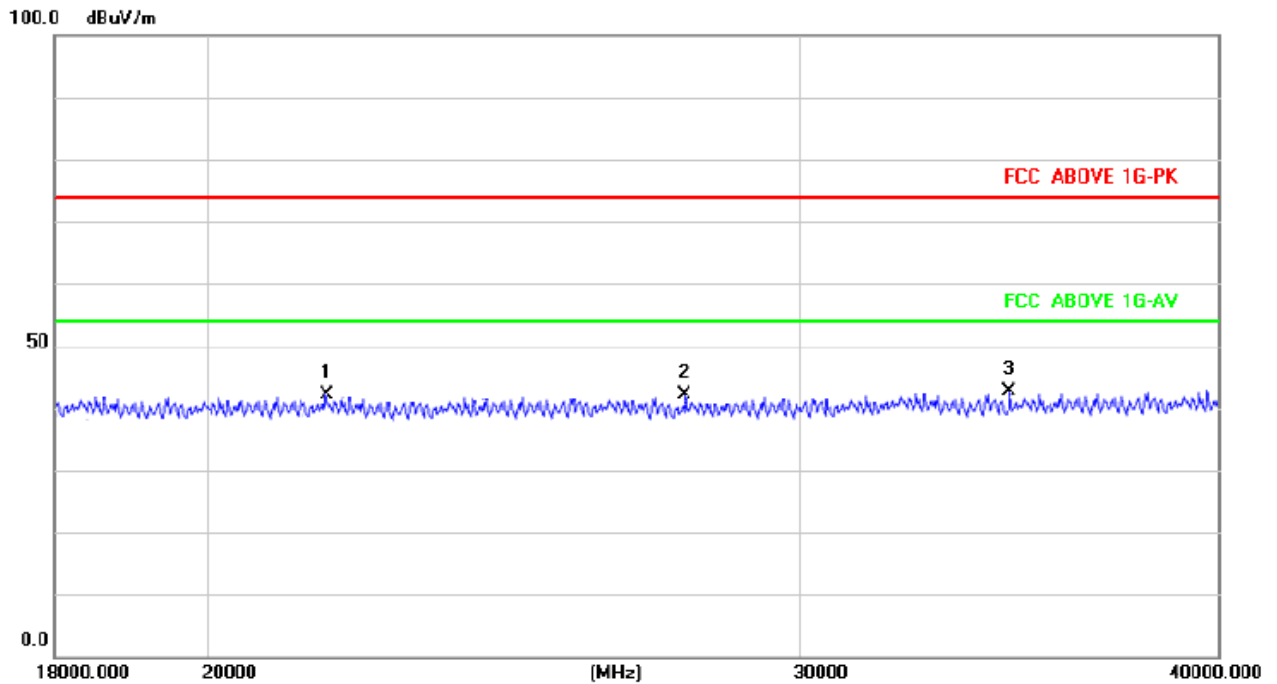



5810MHz Horizontal

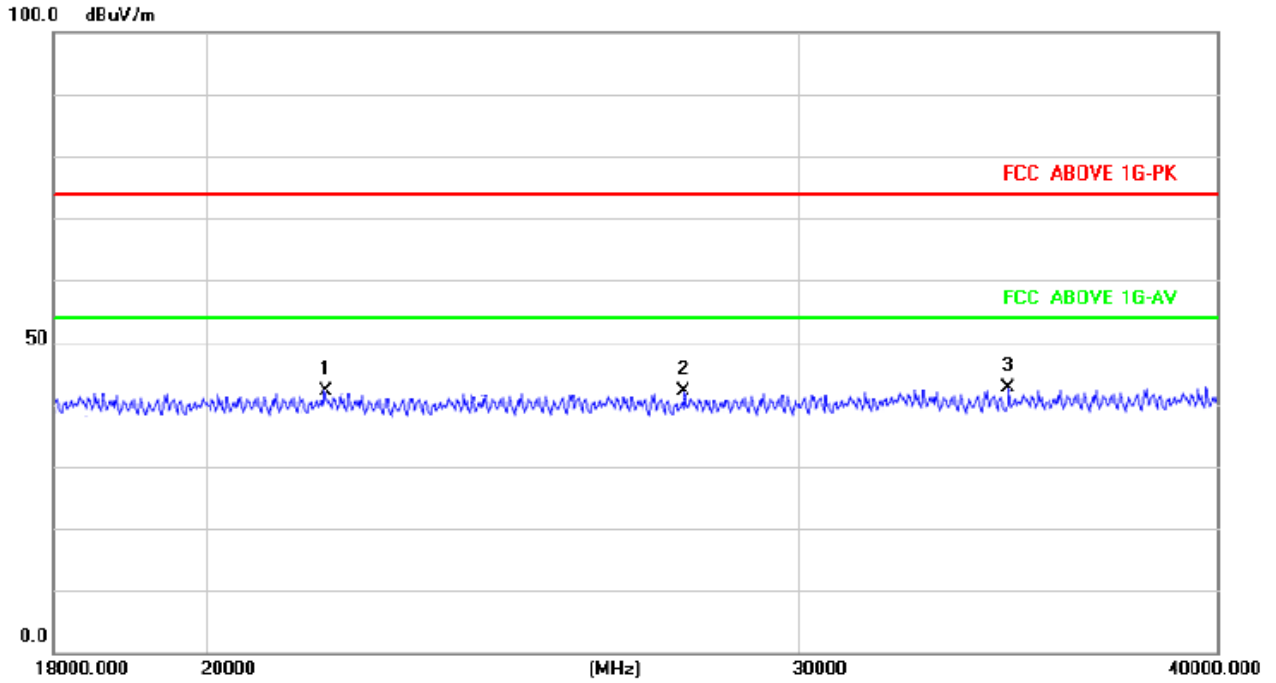

5810MHz Vertical

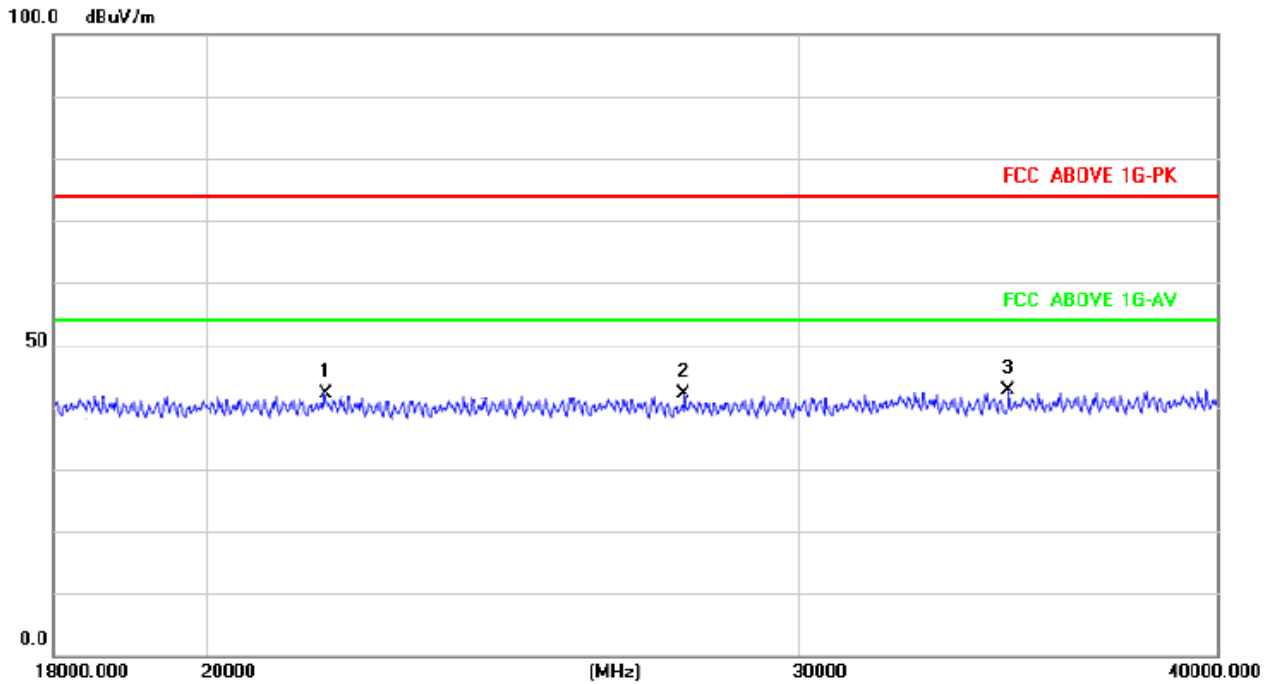



3.3 RADIATED BAND EMISSION MEASUREMENT

3.3.1 TEST REQUIREMENT:

FCC Part15 C Section 15.209 and 15.205

LIMITS OF RADIATED EMISSION MEASUREMENT (Above 1000MHz)

| FREQUENCY (MHz) | Limit (dBuV/m) (at 3M) | |
|-----------------|------------------------|---------|
| | PEAK | AVERAGE |
| Above 1000 | 74 | 54 |

Notes:

- (1) The limit for radiated test was performed according to FCC PART 15C.
- (2) The tighter limit applies at the band edges.
- (3) Emission level (dBuV/m)=20log Emission level (uV/m).

| Spectrum Parameter | Setting |
|---------------------------------------|--|
| Attenuation | Auto |
| Start Frequency | 5375 MHz |
| Stop Frequency | 5820 MHz |
| RB / VB (emission in restricted band) | 1 MHz / 1 MHz for Peak, 1 MHz / 10Hz for Average |

3.3.2 TEST PROCEDURE

Above 1GHz test procedure as below:

- a. 1. The EUT was placed on the top of a rotating table 1.5 meters above the ground at a 3 meter camber. The table was rotated 360 degrees to determine the position of the highest radiation.
- b. The EUT was set 3 meters away from the interference-receiving antenna, which was mounted on the top of a variable-height antenna tower.
- c. The antenna height is varied from one meter to four meters above the ground to determine the maximum value of the field strength. Both horizontal and vertical polarizations of the antenna are set to make the measurement.
- d. For each suspected emission, the EUT was arranged to its worst case and then the antenna was tuned to heights from 1 meter to 4 meters and the rota table was turned from 0 degrees to 360 degrees to find the maximum reading.
- e. The test-receiver system was set to Peak Detect Function and Specified Bandwidth with Maximum Hold Mode.
- f. If the emission level of the EUT in peak mode was 10dB lower than the limit specified, then testing could be stopped and the peak values of the EUT would be reported. Otherwise the emissions that did not have 10dB margin would be re-tested one by one using peak, quasi-peak or average method as specified and then reported in a data sheet.
- g. Test the EUT in the lowest channel,the Highest channel

Note:

Both horizontal and vertical antenna polarities were tested and performed pretest to three orthogonal axis. The worst case emissions were reported

3.3.3 DEVIATION FROM TEST STANDARD

No deviation

3.3.4 TEST SETUP

Radiated Emission Test-Up Frequency Above 1GHz

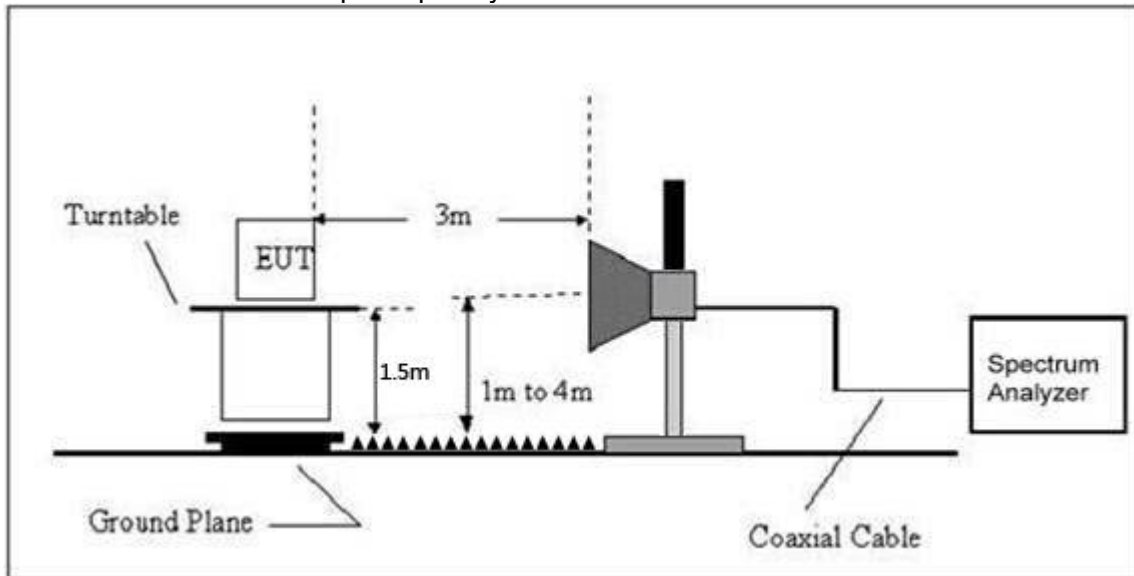

3.3.5 EUT OPERATING CONDITIONS

The EUT tested system was configured as the statements of 2.3 Unless otherwise a special operating condition is specified in the follows during the testing.



Antenna 1

| Polar (H/V) | Frequency (MHz) | Meter Reading (dBuV) | Pre-amplifier (dB) | Cable Loss (dB) | Antenna Factor (dB/m) | Emission level (dBuV/m) | Limits (dBuV/m) | | Result |
|----------------------------|-----------------|----------------------|--------------------|-----------------|-----------------------|-------------------------|-----------------|-------|--------|
| | | | | | | PK | PK | AV | |
| Low Channel 5745MHz | | | | | | | | | |
| H | 5740.00 | 55.52 | 38.06 | 7.42 | 20.15 | 45.03 | 74.00 | 54.00 | PASS |
| H | 5742.89 | 59.77 | 38.06 | 7.42 | 20.15 | 49.28 | 74.00 | 54.00 | PASS |
| V | 5740.00 | 54.23 | 38.06 | 7.42 | 20.15 | 43.74 | 74.00 | 54.00 | PASS |
| V | 5742.89 | 58.06 | 38.06 | 7.42 | 20.15 | 47.57 | 74.00 | 54.00 | PASS |

Remark:

1. Emission Level = Meter Reading + Factor, Margin= Emission Level - Limit
2. If peak below the average limit, the average emission was no test.
3. The amplitude of spurious emissions which are attenuated by more than 20dB below the permissible value has no need to be reported.

Horizontal

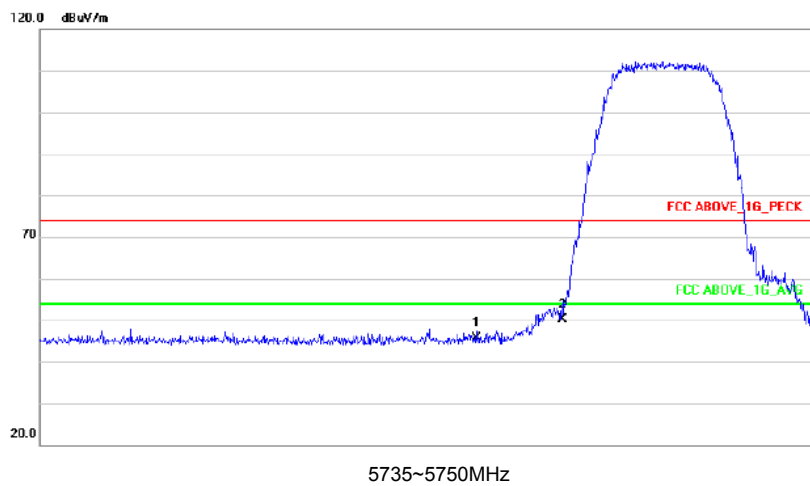

Vertical

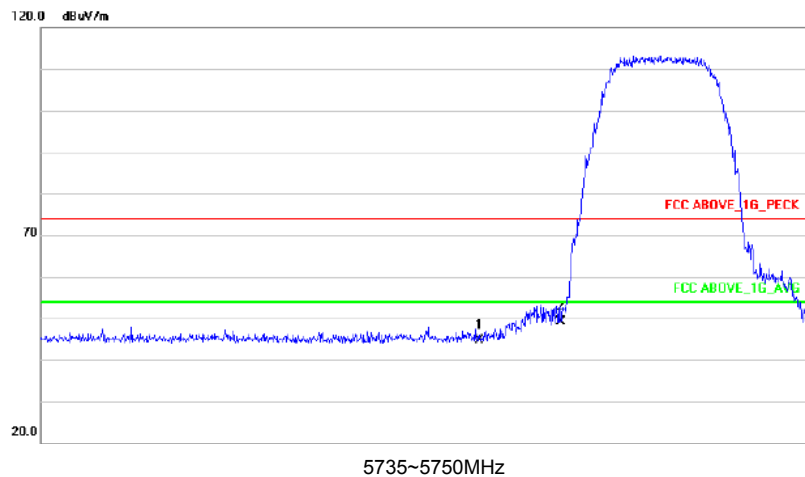



Antenna 1

| Polar (H/V) | Frequency (MHz) | Meter Reading (dBuV) | Pre-amplifier (dB) | Cable Loss (dB) | Antenna Factor (dB/m) | Emission level (dBuV/m) | Limits (dBuV/m) | | Result |
|-----------------------------|-----------------|----------------------|--------------------|-----------------|-----------------------|-------------------------|-----------------|-------|--------|
| | | | | | | PK | PK | AV | |
| High Channel 5810MHz | | | | | | | | | |
| H | 5813.50 | 55.22 | 38.17 | 7.42 | 20.51 | 44.98 | 74.00 | 54.00 | PASS |
| H | 5814.50 | 58.73 | 38.17 | 7.42 | 20.51 | 48.49 | 74.00 | 54.00 | PASS |
| V | 5813.50 | 53.34 | 38.2 | 7.45 | 20.54 | 43.13 | 74.00 | 54.00 | PASS |
| V | 5814.50 | 56.08 | 38.2 | 7.45 | 20.54 | 45.87 | 74.00 | 54.00 | PASS |

Horizontal

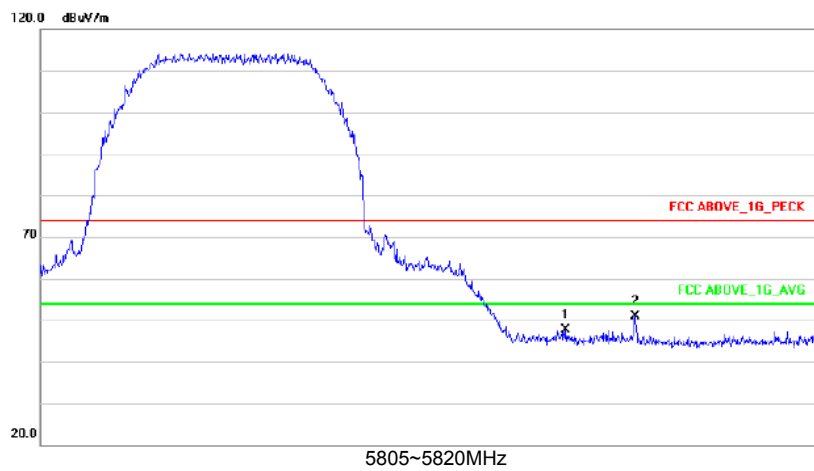

Vertical

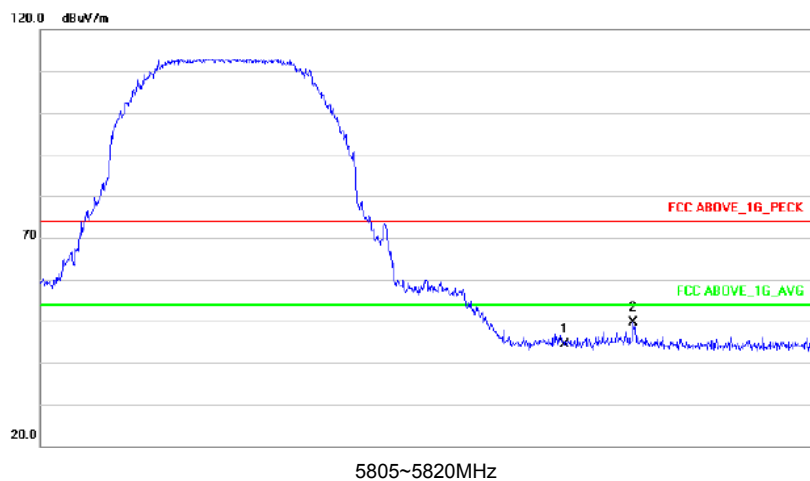



Antenna 2

| Polar (H/V) | Frequency (MHz) | Meter Reading (dBuV) | Pre-amplifier (dB) | Cable Loss (dB) | Antenna Factor (dB/m) | Emission level (dBuV/m) | Limits (dBuV/m) | | Result |
|----------------------------|-----------------|----------------------|--------------------|-----------------|-----------------------|-------------------------|-----------------|-------|--------|
| | | | | | | PK | PK | AV | |
| Low Channel 5745MHz | | | | | | | | | |
| H | 5740.00 | 55.68 | 38.06 | 7.42 | 20.15 | 45.19 | 74.00 | 54.00 | PASS |
| H | 5742.89 | 59.93 | 38.06 | 7.42 | 20.15 | 49.44 | 74.00 | 54.00 | PASS |
| V | 5740.00 | 54.39 | 38.06 | 7.42 | 20.15 | 43.90 | 74.00 | 54.00 | PASS |
| V | 5742.89 | 58.22 | 38.06 | 7.42 | 20.15 | 47.73 | 74.00 | 54.00 | PASS |

Remark:

1. Emission Level = Meter Reading + Factor, Margin= Emission Level - Limit
2. If peak below the average limit, the average emission was no test.
3. The amplitude of spurious emissions which are attenuated by more than 20dB below the permissible value has no need to be reported.

Horizontal

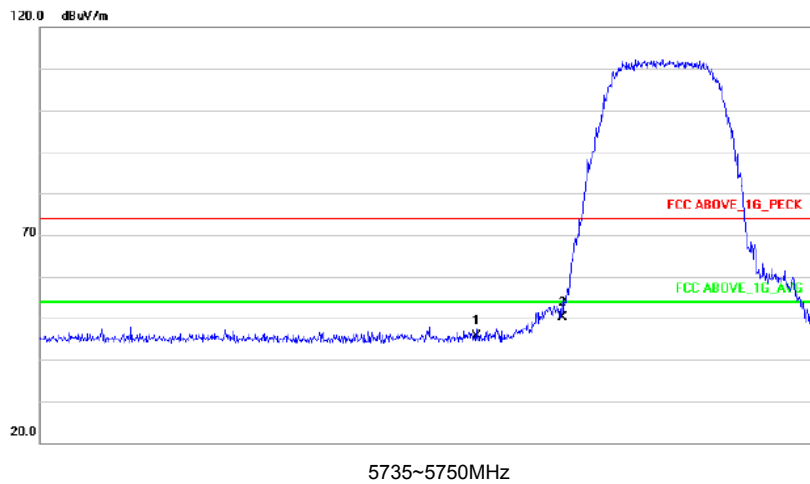

Vertical

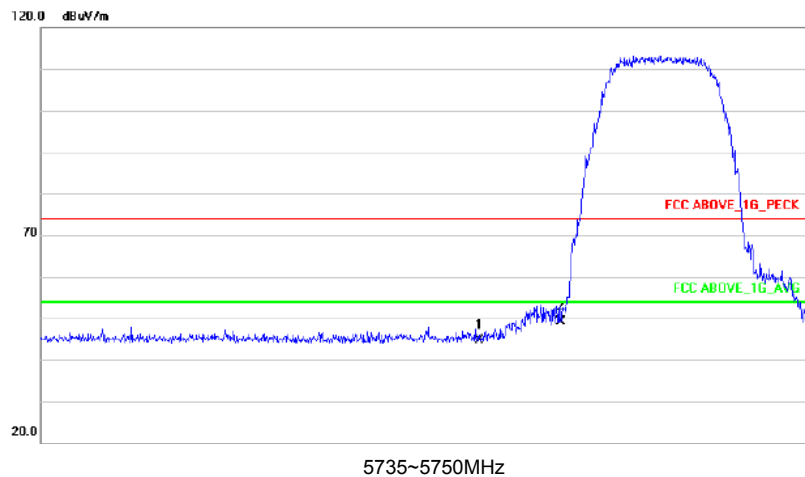



Antenna 2

| Polar (H/V) | Frequency (MHz) | Meter Reading (dBuV) | Pre-amplifier (dB) | Cable Loss (dB) | Antenna Factor (dB/m) | Emission level (dBuV/m) | Limits (dBuV/m) | | Result |
|-----------------------------|-----------------|----------------------|--------------------|-----------------|-----------------------|-------------------------|-----------------|-------|--------|
| | | | | | | PK | PK | AV | |
| High Channel 5810MHz | | | | | | | | | |
| H | 5813.50 | 55.04 | 38.17 | 7.42 | 20.51 | 44.80 | 74.00 | 54.00 | PASS |
| H | 5814.50 | 58.55 | 38.17 | 7.42 | 20.51 | 48.31 | 74.00 | 54.00 | PASS |
| V | 5813.50 | 53.16 | 38.2 | 7.45 | 20.54 | 42.95 | 74.00 | 54.00 | PASS |
| V | 5814.50 | 55.90 | 38.2 | 7.45 | 20.54 | 45.69 | 74.00 | 54.00 | PASS |

Horizontal

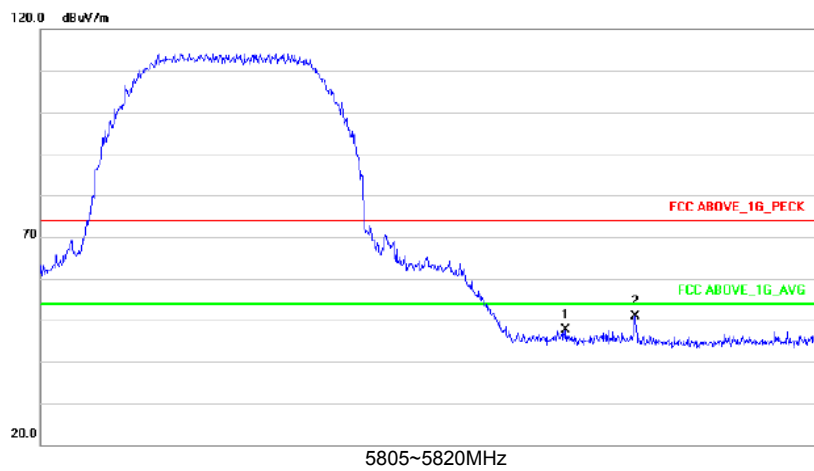

Vertical

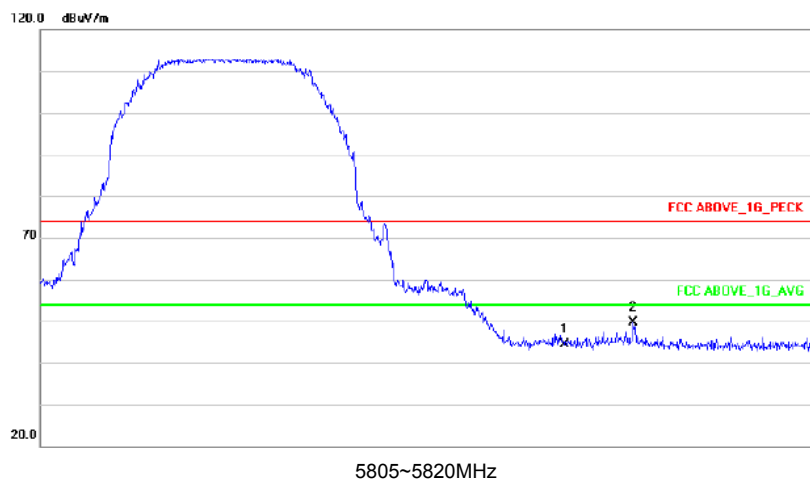



4. BANDWIDTH TEST

4.1 APPLIED PROCEDURES / LIMIT

| FCC Part15 (15.249) , Subpart C | | | | |
|---------------------------------|-----------|------------------|-----------------------|--------|
| Section | Test Item | Limit | Frequency Range (MHz) | Result |
| 15.249 | Bandwidth | (20dB bandwidth) | 5745-5810 | PASS |

| Spectrum Parameter | Setting |
|--------------------|---|
| Attenuation | Auto |
| Span Frequency | > Measurement Bandwidth or Channel Separation |
| RB | 100KHz |
| VB | \geq RBW |
| Detector | Peak |
| Trace | Max Hold |
| Sweep Time | Auto |

4.1.1 TEST PROCEDURE

- a. The EUT was directly connected to the spectrum analyzer and antenna output port as show in the block diagram below,
- b. Spectrum Setting : RBW= 100KHz, VBW \geq RBW, Sweep time = Auto.

4.1.2 DEVIATION FROM STANDARD

No deviation.

4.1.3 TEST SETUP



4.1.4 EUT OPERATION CONDITIONS

The EUT tested system was configured as the statements of 2.4 Unless otherwise a special operating condition is specified in the follows during the testing.



4.1.5 TEST RESULTS

| | | | |
|---------------|-------------------------------|---------------------|----------|
| EUT : | Amigo Wireless Remote Control | Model Name : | HG-C01B |
| Temperature : | 25 °C | Relative Humidity : | 55% |
| Pressure : | 1012 hPa | Test Voltage : | DC 11.4V |
| Test Mode : | CH01 / CH02 /C03 | | |

Antenna1

| | Frequency | 20dB Bandwidth (MHz) | Result |
|------|-----------|----------------------|-------------|
| GFSK | 5745 MHz | 2.118 | PASS |
| | 5777 MHz | 2.126 | PASS |
| | 5810 MHz | 2.100 | PASS |

Antenna2

| | Frequency | 20dB Bandwidth (MHz) | Result |
|------|-----------|----------------------|-------------|
| GFSK | 5745 MHz | 2.112 | PASS |
| | 5777 MHz | 2.228 | PASS |
| | 5810 MHz | 2.003 | PASS |

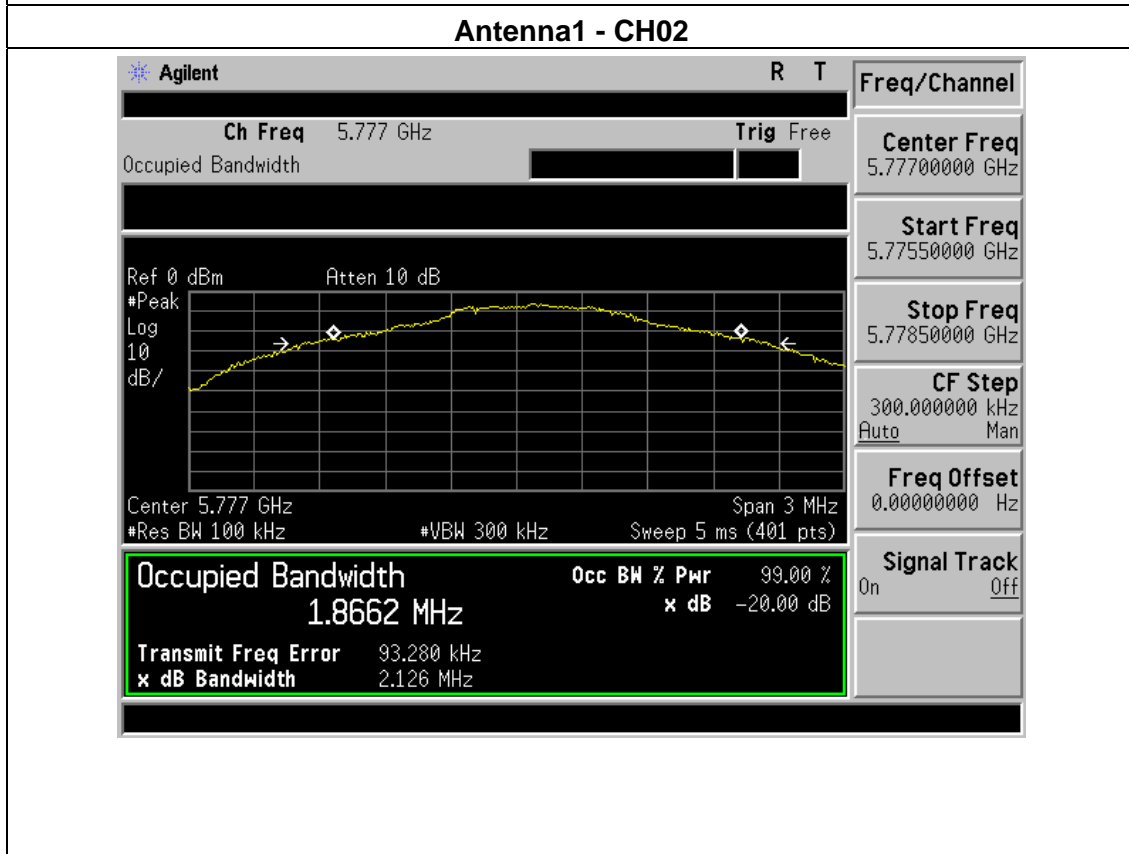
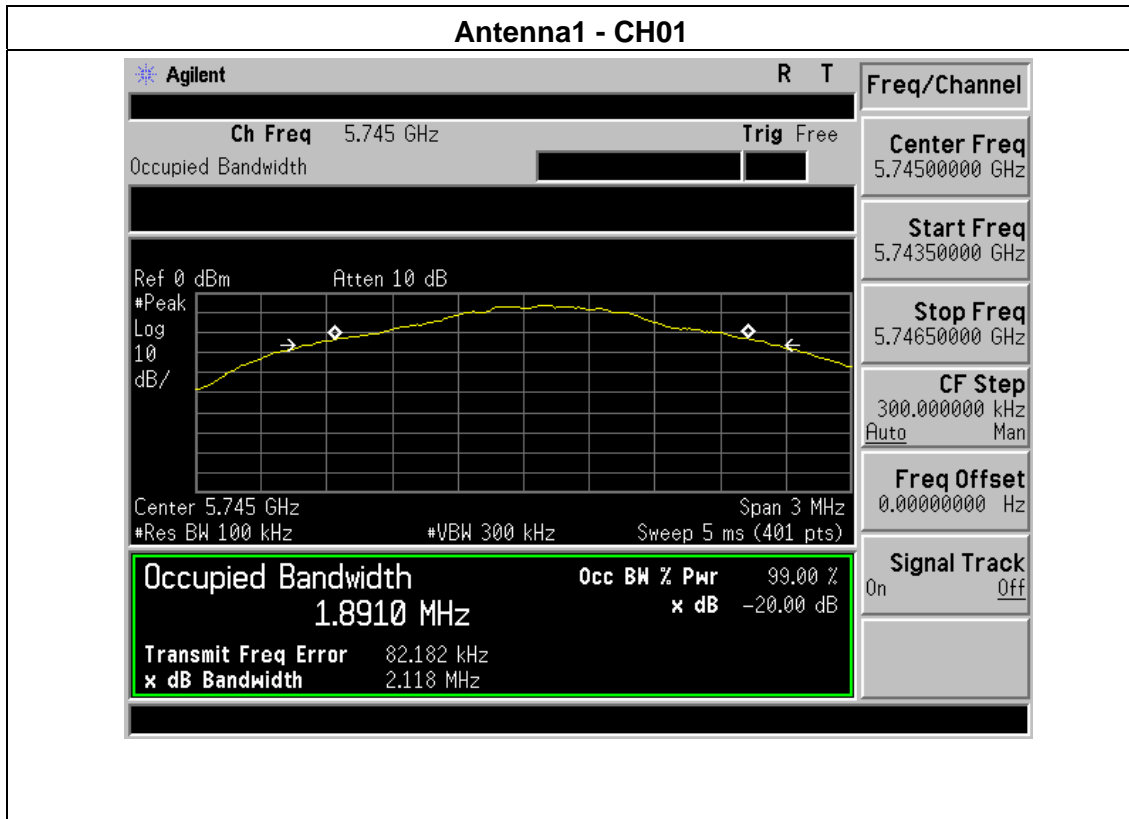

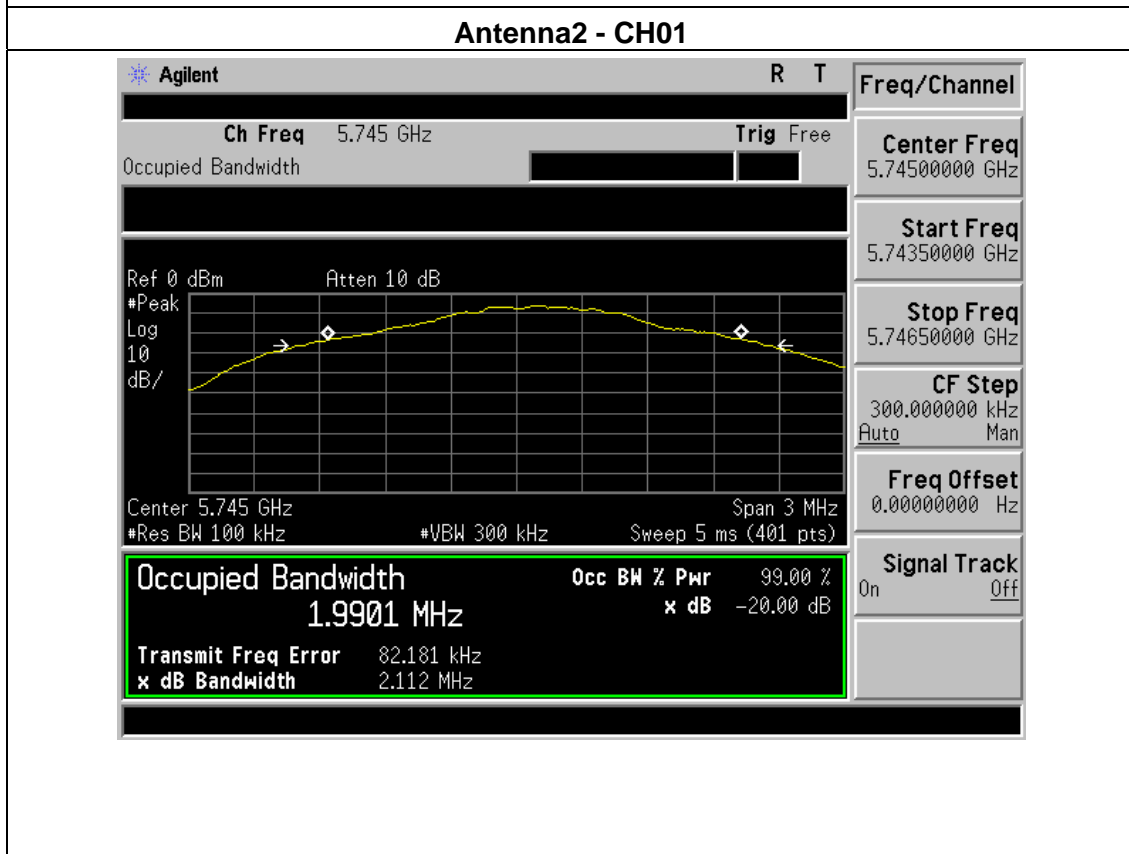
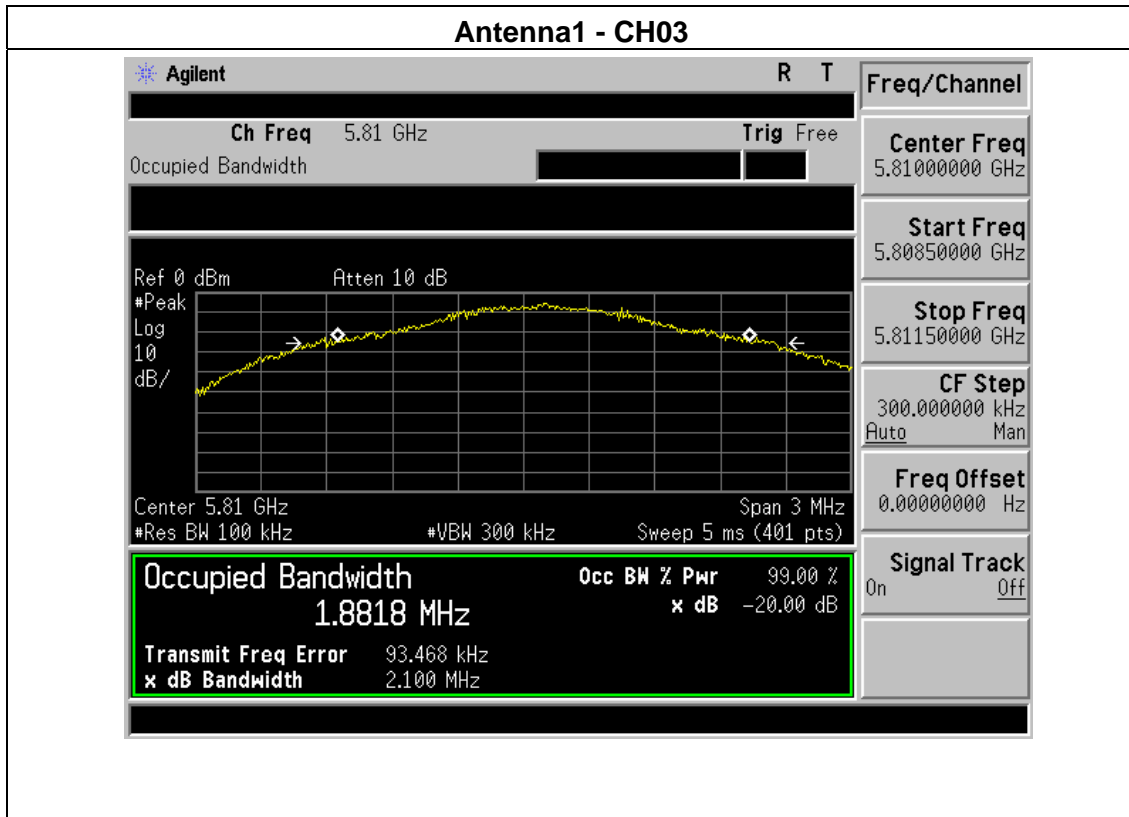

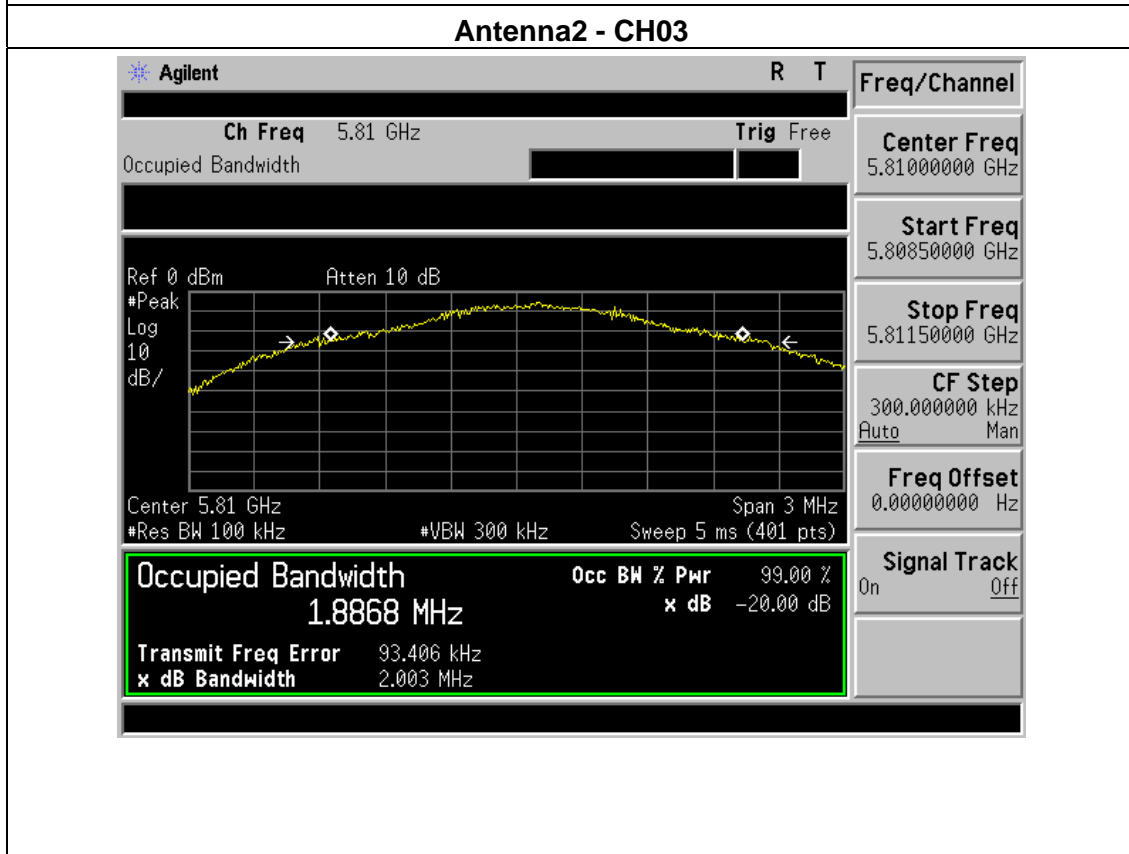
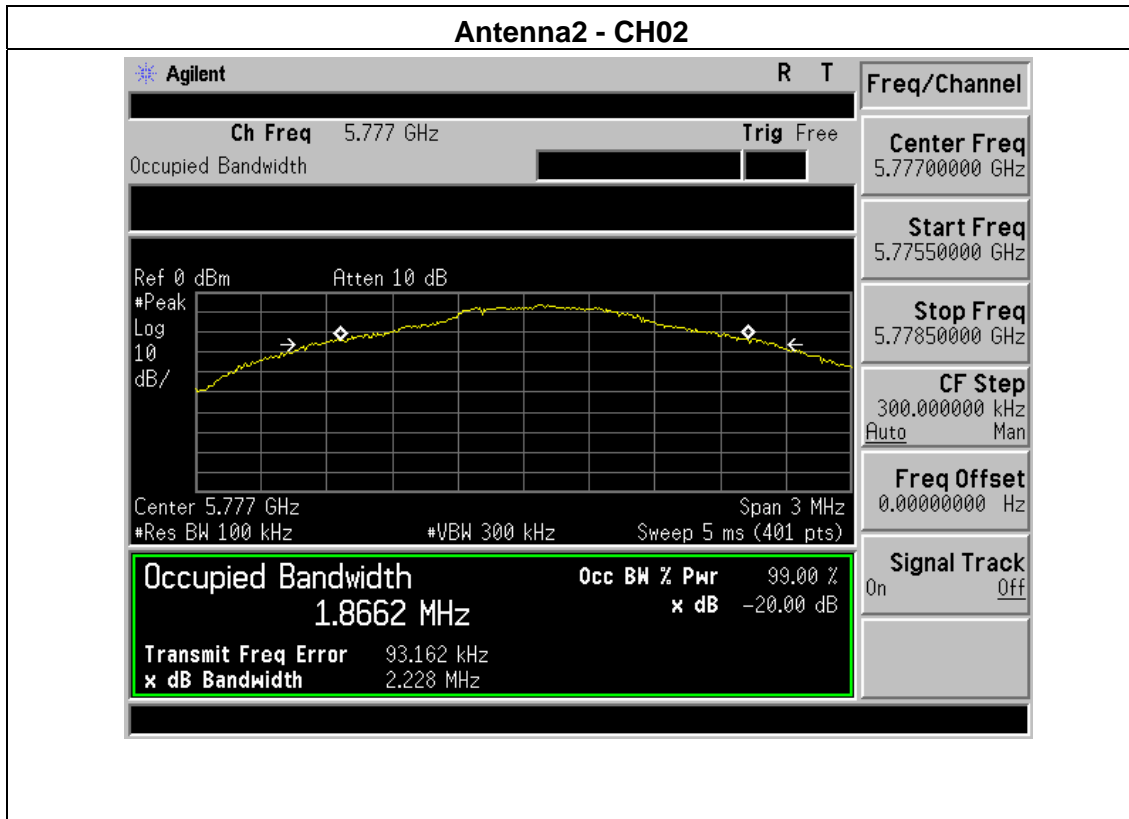



5. 100 KHZ BANDWIDTH OF FREQUENCY BAND EDGE

APPLICABLE STANDARD

In any 100 kHz bandwidth outside the frequency band in which the spread spectrum or digitally modulated intentional radiator is operating, the radio frequency power that is produced by the intentional radiator shall be at least 20 dB below that in the 100 kHz bandwidth within the band that contains the highest level of the desired power, based on either an RF conducted or a radiated measurement, provided the transmitter demonstrates compliance with the peak conducted power limits. If the transmitter complies with the conducted power limits based on the use of RMS averaging over a time interval, as permitted under paragraph (b)(3) of this section, the attenuation required under this paragraph shall be 30 dB instead of 20 dB. Attenuation below the general limits specified in §15.209(a) is not required. In addition, radiated emissions which fall in the restricted bands, as defined in §15.205(a), must also comply with the radiated emission limits specified in §15.209(a)(c)

TEST PROCEDURE

- a) Check the calibration of the measuring instrument using either an internal calibrator or a known signal from an external generator.
- b) Position the EUT without connection to measurement instrument. Turn on the EUT and connect its antenna terminal to measurement instrument via a low loss cable. Then set it to any one measured frequency within its operating range, and make sure the instrument is operated in its linear range.
- c) Set RBW to 1 MHz and VBW of spectrum analyzer to 3 MHz with a convenient frequency span including 100 kHz bandwidth from band edge.
- d) Measure the highest amplitude appearing on spectral display and set it as a reference level. Plot the graph with marking the highest point and edge frequency.
- e) Repeat above procedures until all measured frequencies were complete.

Note:

Both horizontal and vertical antenna polarities were tested and performed pretest to three orthogonal axis. The worst case emissions were reported



5.1 DEVIATION FROM STANDARD

No deviation.

5.2 TEST SETUP



5.3 EUT OPERATION CONDITIONS

The EUT tested system was configured as the statements of 2.4 Unless otherwise a special operating condition is specified in the follows during the testing.

5.4 TEST RESULTS

| | | | |
|---------------|------------|---------------------|----------|
| Temperature : | 25 °C | Relative Humidity : | 54% |
| Pressure : | 1012 hPa | Test Voltage : | DC 11.4V |
| Test Mode : | CH01/ CH03 | | |

Antenna1 - CH01

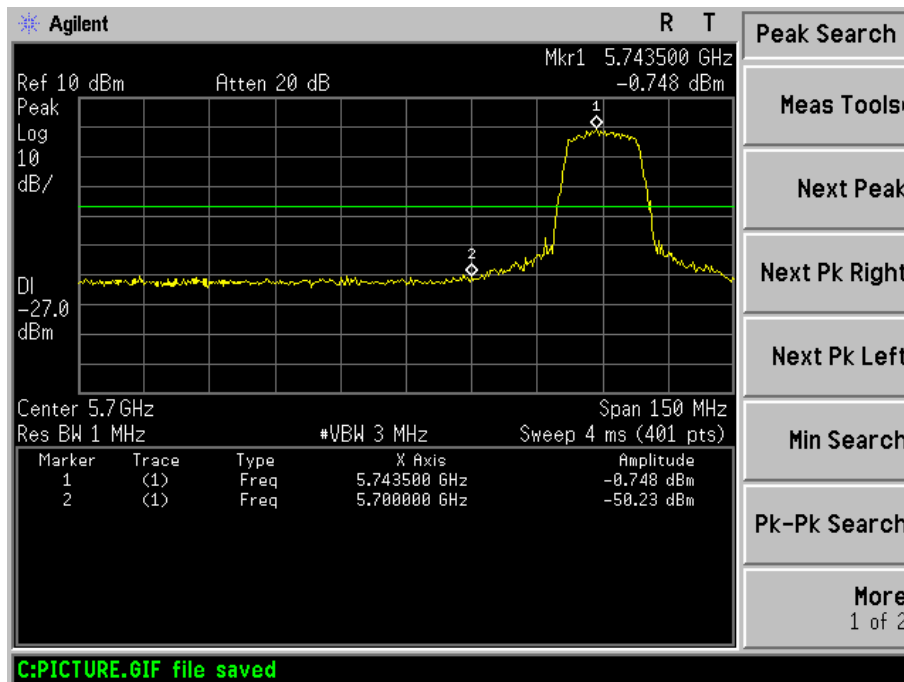



Antenna1 - CH03

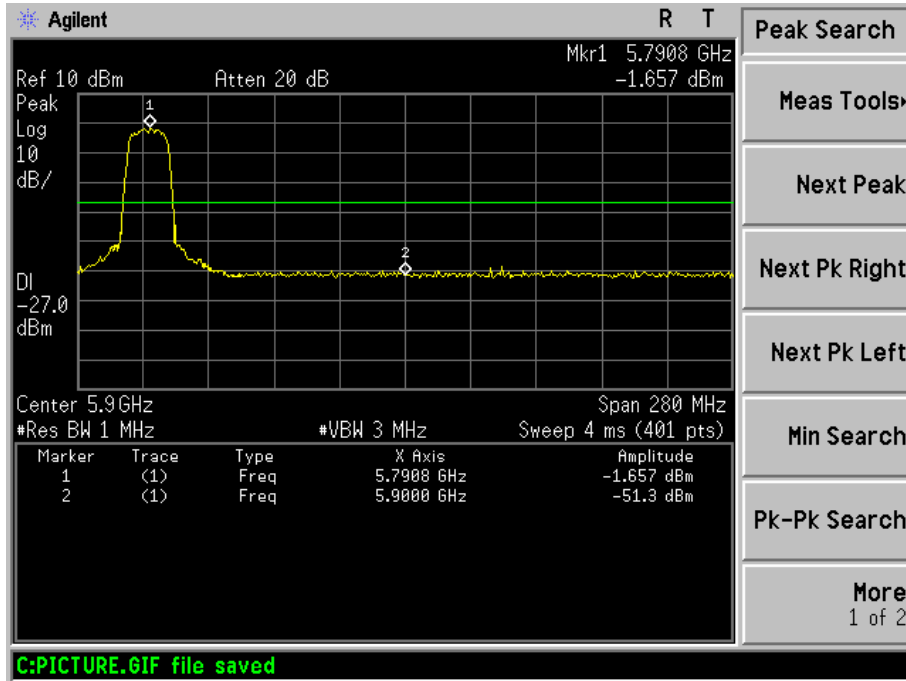

Antenna2 - CH01

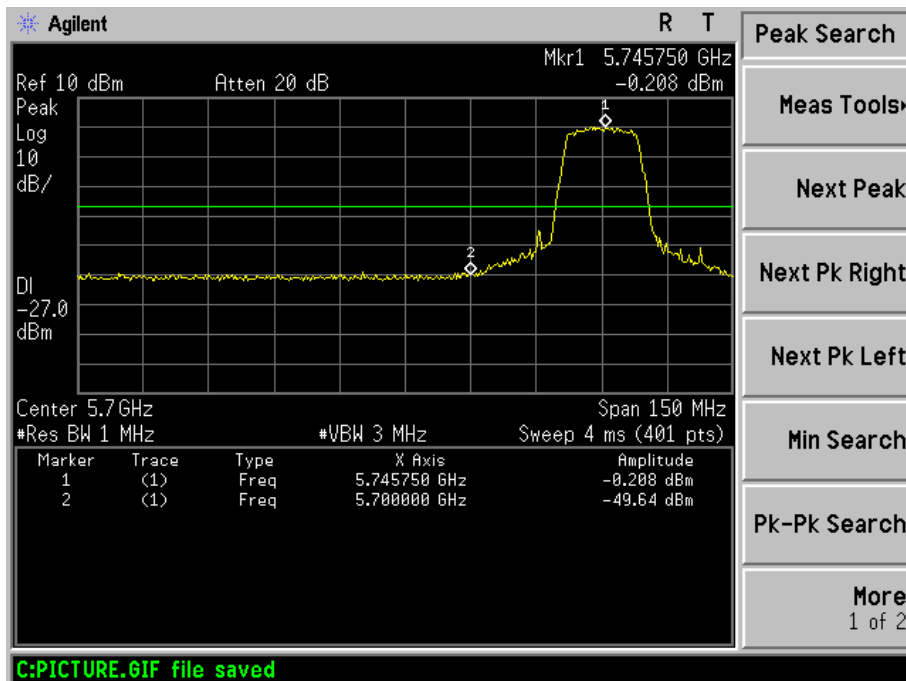



Antenna2 - CH03

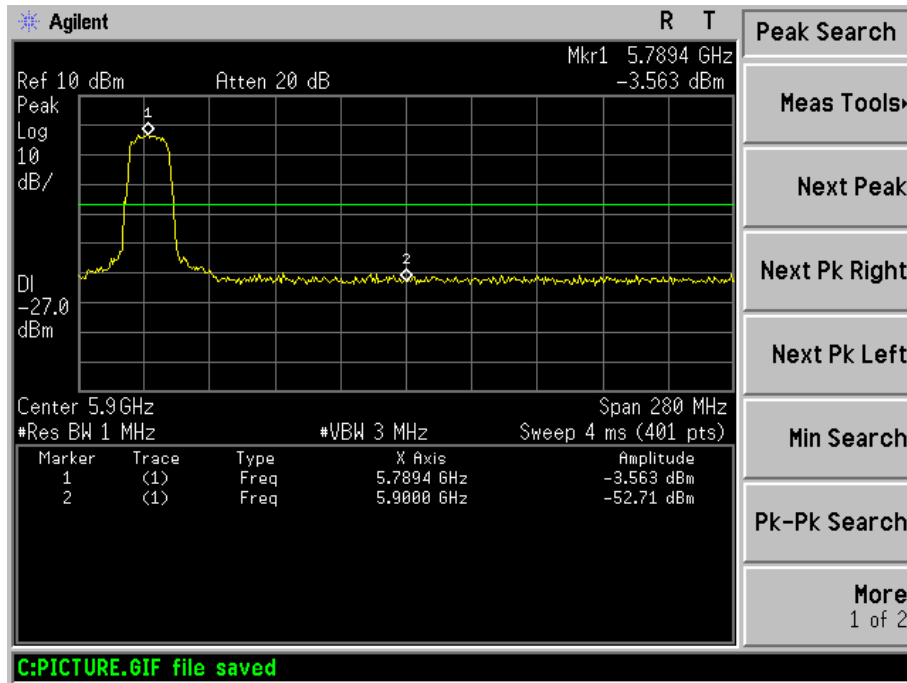



6. ANTENNA REQUIREMENT

6.1 STANDARD REQUIREMENT

15.203 requirement: For intentional device, according to 15.203: an intentional radiator shall be designed to ensure that no antenna other than that furnished by the responsible party shall be used with the device.

6.2 EUT ANTENNA

The EUT antenna is Integrated antenna. It complies with the standard requirement.



7. EUT TEST PHOTO

Conducted Measurement Photos





Radiated Measurement Photos

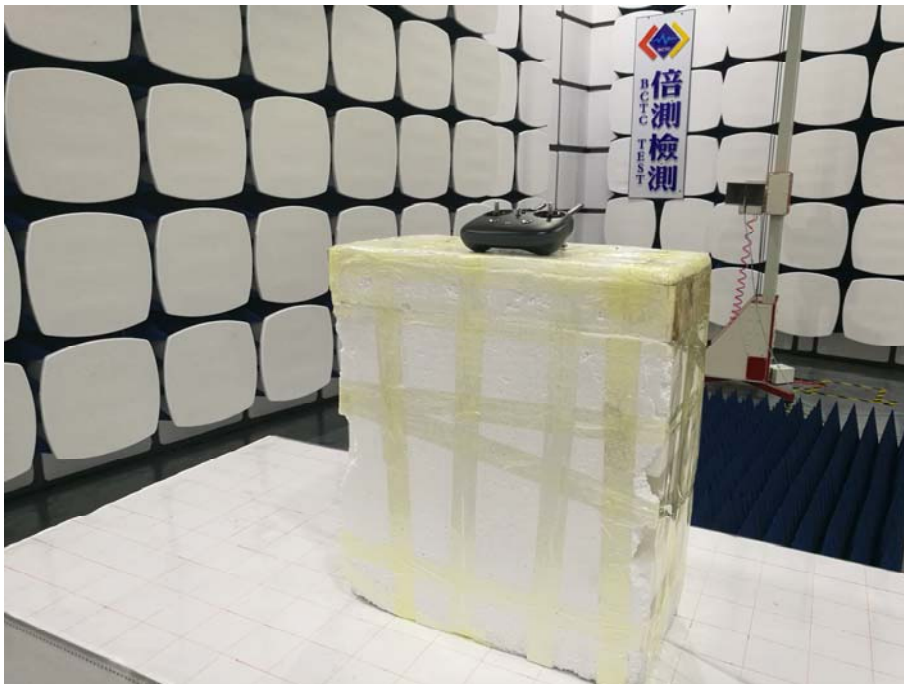



8. EUT PHOTO



***** END OF REPORT *****