

# TEST REPORT

Report No.: BCTC2104043914E

---

Applicant: Shenzhen HighGreat Innovation Technology Development Co., Ltd.

---

Product Name: EMO

---

Model/Type reference: HG-B03

---

Tested Date: 2021-05-06 to 2021-05-17

---

Issued Date: 2021-05-17

---

**Shenzhen BCTC Testing Co., Ltd.**



# FCC ID: 2ALYRHG-B03

Product Name: EMO  
Trademark: N/A  
Model/Type reference: HG-B03  
Prepared For: Shenzhen HighGreat Innovation Technology Development Co., Ltd.  
Address: 2/F, Building 6, Yuanlingzi Industrial Zone, Hengping Road, Yuanshan Street, Longgang District, Shenzhen, China  
Manufacturer: Shenzhen HighGreat Innovation Technology Development Co., Ltd.  
Address: 2/F, Building 6, Yuanlingzi Industrial Zone, Hengping Road, Yuanshan Street, Longgang District, Shenzhen, China  
Prepared By: Shenzhen BCTC Testing Co., Ltd.  
Address: 1-2F, East of B Building, Pengzhou Industrial, Fuyuan 1st Road, Qiaotou Community, Fuyong Street, Bao'an District, Shenzhen, China  
Sample Received Date: 2021-05-06  
Sample tested Date: 2021-05-06 to 2021-05-17  
Issue Date: 2021-05-17  
Report No.: BCTC2104043914E  
Test Standards: FCC Part15 15.407  
ANSI C63.10-2013  
KDB 662911 D01 v02r01  
KDB 789033 D02 v02r01  
Test Results: PASS

Tested by:



Sam zeng/Project Handler

Approved by:



Zero Zhou/Reviewer

*The test report is effective only with both signature and specialized stamp. This result(s) shown in this report refer only to the sample(s) tested. Without written approval of Shenzhen BCTC Testing Co., Ltd, this report can't be reproduced except in full. The tested sample(s) and the sample information are provided by the client.*

## TABLE OF CONTENT

Test Report Declaration	Page
<b>1. VERSION</b> .....	5
<b>2. TEST SUMMARY</b> .....	6
<b>3. MEASUREMENT UNCERTAINTY</b> .....	7
<b>4. PRODUCT INFORMATION AND TEST SETUP</b> .....	8
4.1 Product Information .....	8
4.2 Test Setup Configuration .....	9
4.3 Support Equipment .....	9
4.4 Channel List .....	10
4.5 Test Mode .....	10
4.6 table of parameters of text software setting .....	10
4.7 Antenna .....	11
<b>5. TEST FACILITY AND TEST INSTRUMENT USED</b> .....	12
5.1 Test Facility .....	12
5.2 Test Instrument Used .....	13
<b>6. CONDUCTED EMISSIONS</b> .....	15
6.1 Block Diagram Of Test Setup .....	15
6.2 Limit .....	15
6.3 Test procedure .....	15
6.4 EUT operating Conditions .....	15
6.5 Test Result .....	15
<b>7. RADIATED EMISSIONS</b> .....	16
7.1 Block Diagram Of Test Setup .....	16
7.2 Limit .....	17
7.3 Test procedure .....	18
7.4 EUT operating Conditions .....	19
7.5 Test Result .....	20
<b>8. POWER SPECTRAL DENSITY TEST</b> .....	25
8.1 Block Diagram Of Test Setup .....	25
8.2 Limit .....	25
8.3 Test procedure .....	26
8.4 EUT operating Conditions .....	26
8.5 Test Result .....	27
<b>9. 26DB &amp; 6DB &amp; 99% EMISSION BANDWIDTH</b> .....	29
9.1 Block Diagram Of Test Setup .....	29
9.2 Limit .....	29
9.3 Test procedure .....	29
9.4 EUT operating Conditions .....	30
9.5 Test Result .....	30
<b>10. MAXIMUM CONDUCTED OUTPUT POWER</b> .....	36

10.1	Block Diagram Of Test Setup	36
10.2	Limit	36
10.3	Test procedure	36
10.4	EUT operating Conditions	37
10.5	Test Result	38
<b>11.</b>	<b>OUT OF BAND EMISSIONS</b>	<b>39</b>
11.1	Block Diagram Of Test Setup	39
11.2	Limit	39
11.3	Test procedure	39
11.4	EUT operating Conditions	39
11.5	Test Result	40
<b>12.</b>	<b>SPURIOUS RF CONDUCTED EMISSIONS</b>	<b>41</b>
12.1	Block Diagram Of Test Setup	41
12.2	Limit	41
12.3	Test procedure	41
12.4	Test Result	42
<b>13.</b>	<b>FREQUENCY STABILITY MEASUREMENT</b>	<b>46</b>
13.1	Block Diagram Of Test Setup	46
13.2	Limit	46
13.3	Test procedure	46
13.4	Test Result	47
<b>14.</b>	<b>ANTENNA REQUIREMENT</b>	<b>50</b>
14.1	Limit	50
14.2	Test Result	50
<b>15.</b>	<b>EUT PHOTOGRAPHS</b>	<b>51</b>
<b>16.</b>	<b>EUT TEST SETUP PHOTOGRAPHS</b>	<b>52</b>

(Note: N/A means not applicable)

## 1. VERSION

Report No.	Issue Date	Description	Approved
BCTC2104043914E	2021-05-17	Original	Valid

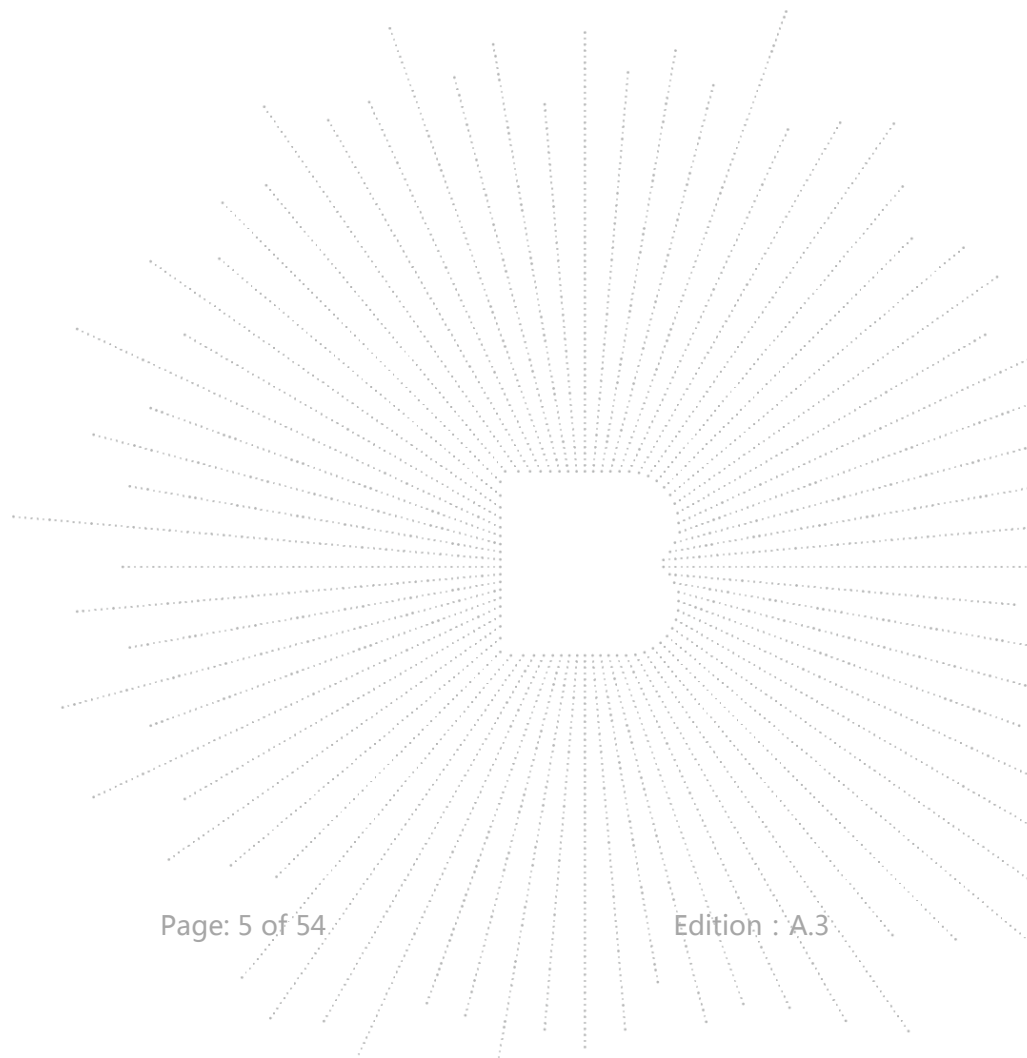

## 2. TEST SUMMARY

The Product has been tested according to the following specifications:

No.	Test Parameter	Clause No	Results
1	Spurious Radiated Emissions	15.209(a), 15.407 (b)(4)	PASS
2	Conducted Emission	15.207	N/A
3	Minimum 6 dB bandwidth	15.407(e)	PASS
4	Maximum Conducted Output Power	15.407 (a)(3)	PASS
5	Band Edge	2.1051, 15.407(b)(4)	PASS
6	Power Spectral Density	15.407 (a)(3)	PASS
7	Spurious Emissions at Antenna Terminals	2.1051, 15.407(b)	PASS
8	Antenna Requirement	15.203	PASS

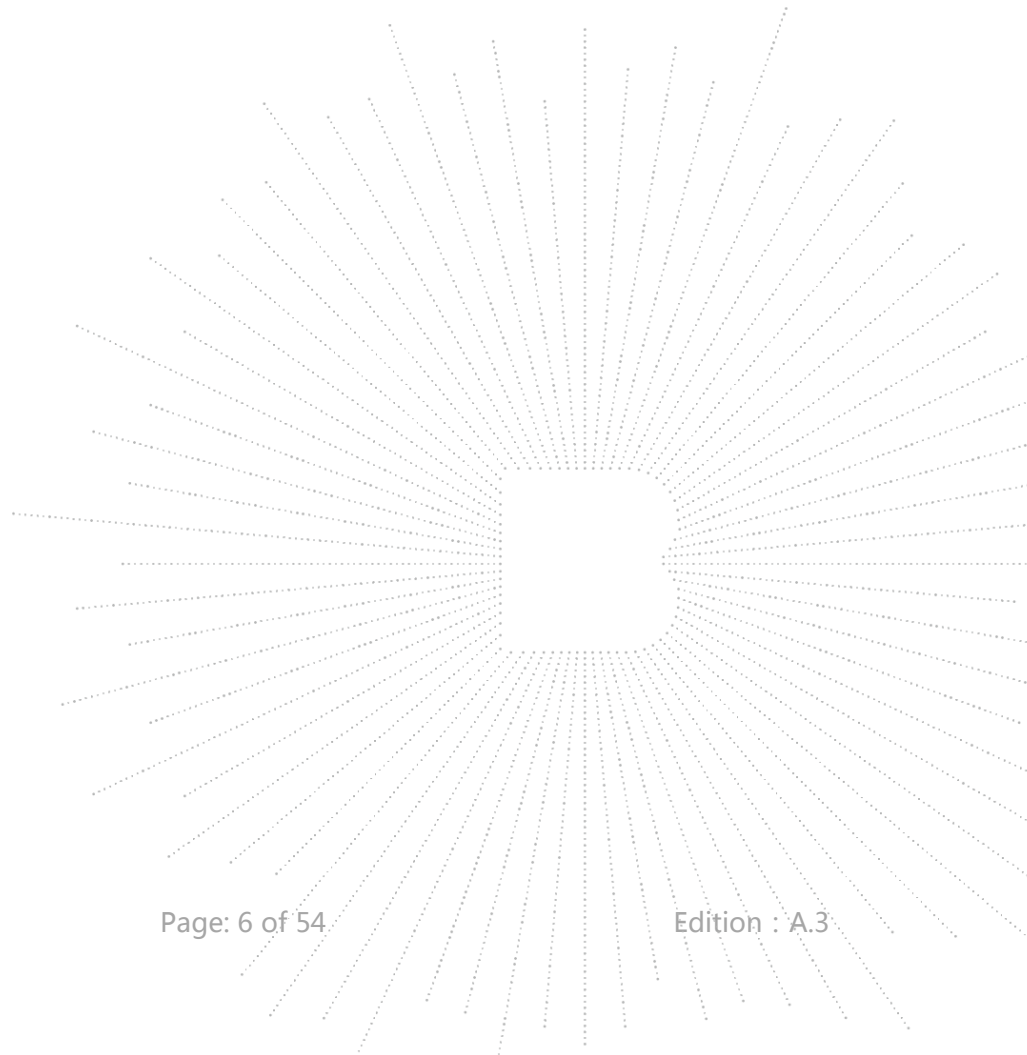

### 3. MEASUREMENT UNCERTAINTY

Where relevant, the following measurement uncertainty levels have been estimated for tests performed on the Product as specified in CISPR 16-4-2. This uncertainty represents an expanded uncertainty expressed at approximately the 95% confidence level using a coverage factor of  $k=2$ .

No.	Item	Uncertainty
1	3m chamber Radiated spurious emission(30MHz-1GHz)	U=4.3dB
2	3m chamber Radiated spurious emission(1GHz-18GHz)	U=4.5dB
3	3m chamber Radiated spurious emission(18GHz-40GHz)	U=3.34dB
4	Conducted Adjacent channel power	U=1.38dB
5	Conducted output power uncertainty Above 1G	U=1.576dB
6	Conducted output power uncertainty below 1G	U=1.28dB
7	humidity uncertainty	U=5.3%
8	Temperature uncertainty	U=0.59°C

## 4. PRODUCT INFORMATION AND TEST SETUP

### 4.1 Product Information

Model/Type reference:	HG-B03
Model differences:	N/A
Hardware Version:	N/A
Software Version:	N/A
IEEE 802.11 WLAN Mode Supported	802.11a/n(20MHz channel bandwidth)
Operation Frequency:	5745-5825 MHz for 802.11a/n(HT20);
Data Rate	802.11a: 6,9,12,18,24,36,48,54Mbps; 802.11n(HT20):MCS0-MCS15;
Type of Modulation:	OFDM with BPSK/QPSK/16QAM/64QAM/256QAM for 802.11a/n
Number Of Channel	3 channels for 802.11a/n20 in the 5745-5825MHz band ;
Antenna installation:	Internal antenna
Antenna Gain:	Antenna A:1dBi Antenna B:1dBi
Ratings:	DC 14.5V from Battery



## 4.2 Test Setup Configuration

See test photographs attached in *EUT TEST SETUP PHOTOGRAPHS* for the actual connections between Product and support equipment.

Radiated Spurious Emission:

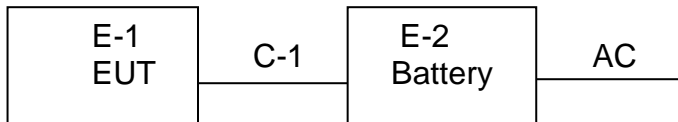

## 4.3 Support Equipment

No.	Device Type	Brand	Model	Series No.	Data Cable	Power Cord
E-1	EMO	N/A	HG-B03	N/A	EUT	E-1
E-2	Adapter	N/A	BCTC001	N/A	Auxiliary	E-2

Item	Shielded Type	Ferrite Core	Length	Note
C-1	NO	NO	0.6M	DC cable unshielded

### Notes:

1. All the equipment/cables were placed in the worst-case configuration to maximize the emission during the test.
2. Grounding was established in accordance with the manufacturer's requirements and conditions for the intended use.

#### 4.4 Channel List

Frequency and Channel list for 802.11a/n/ac(20 MHz) band IV (5745-5825MHz):

802.11a/n( 20 MHz) Carrier Frequency Channel							
Channel	Frequency (MHz)	Channel	Frequency (MHz)	Channel	Frequency (MHz)	Channel	Frequency (MHz)
149	5745	153	5765	157	5785	161	5805
165	5825	-	-	-	-	-	-

#### 4.5 Test Mode

To investigate the maximum EMI emission characteristics generates from EUT, the test system was pre-scanning tested base on the consideration of following EUT operation mode or test configuration mode which possible have effect on EMI emission level. Each of these EUT operation mode(s) or test configuration mode(s) mentioned above was evaluated respectively.

Pretest Mode	Description
Mode 1	802.11a / n/ CH149/ CH157/ CH165
Mode 2	Link Mode

Conducted Emission	
Final Test Mode	Description
Mode 2	Link Mode

For Radiated Emission	
Final Test Mode	Description
Mode 1	802.11a / n/ CH149/ CH157/ CH165
Mode 2	Link Mode

Note:

(1) The measurements are performed at all Bit Rate of Transmitter, the worst data was reported.

#### 4.6 table of parameters of text software setting

During testing channel & power controlling software provided by the customer was used to control the operating channel as well as the output power level. The RF output power selection is for the setting of RF output power expected by the customer and is going to be fixed on the firmware of the final end product power parameters

Test software Version	FCC_TOOL		
Parameters	DEF	DEF	DEF

## 4.7 Antenna

**Table for External antenna**

Ant.	Brand	Model Name	Antenna Type	Gain (dBi)	NOTE
A	N/A	N/A	External antenna	1	
B	N/A	N/A	External antenna	1	

EUT has two External antennas with Max gain GANT 1dBi on every antenna, CDD device with two spatial streams, also can operat with one spatial streams according to KDB662911 D01 v02r01,

Directional gain= GANT + Array Gain, where Array Gain is as follows.

1)For power spectral density(PSD) measurements,  
 Array Gain= $10\log(NANT/NSS)$ dB= $10\log(2/1)$ =3.01dB,

So the directional gain for PSD is 4.01dBi

2)For power measurements,

The Array gain=0 dB for  $NANT \leq 4$ ,

So the directional gain for Power measurements is 1dBi

## 5. TEST FACILITY AND TEST INSTRUMENT USED

### 5.1 Test Facility

All measurement facilities used to collect the measurement data are located at Shenzhen BCTC Testing Co., Ltd. Address:1-2/F., Building B, Pengzhou Industrial Park, No.158, Fuyuan 1st Road, Tangwei, Fuhai Subdistrict, Bao'an District, Shenzhen, Guangdong, China. The site and apparatus are constructed in conformance with the requirements of ANSI C63.4 and CISPR 16-1-1 other equivalent standards.

FCC Test Firm Registration Number: 712850

IC Registered No.: 23583

## 5.2 Test Instrument Used

Radiated emissions Test (966 chamber)					
Equipment	Manufacturer	Model#	Serial#	Last Cal.	Next Cal.
966 chamber	ChengYu	966 Room	966	Jun. 06. 2020	Jun. 05, 2023
Receiver	R&S	ESR3	102075	Jun. 08, 2020	Jun. 07, 2021
Receiver	R&S	ESRP	101154	Jun. 08, 2020	Jun. 07, 2021
Amplifier	Schwarzbeck	BBV9718	9718-309	Jun. 04, 2020	Jun. 03, 2021
Amplifier	Schwarzbeck	BBV9744	9744-0037	Jun. 04, 2020	Jun. 03, 2021
TRILOG Broadband Antenna	schwarzbeck	VULB 9163	VULB9163-942	Jun. 08, 2020	Jun. 07, 2021
Horn Antenna	SCHWARZBECK	BBHA9120D	1201	Jun. 10, 2020	Jun. 09, 2021
Horn Antenna (18GHz-40GHz)	SCHWARZBECK	BBHA9170	822	Jun. 10, 2020	Jun. 09, 2021
Amplifier (18GHz-40GHz)	MITEQ	TTA1840-35-HG	2034381	Jun. 08, 2020	Jun. 07, 2021
Loop Antenna (9KHz-30MHz)	SCHWARZBECK	FMZB1519B	014	Jun. 08, 2020	Jun. 07, 2021
RF cables1 (9kHz-30MHz)	Huber+Suhnar	9kHz-30MHz	B1702988-0008	Jun. 08, 2020	Jun. 07, 2021
RF cables2 (30MHz-1GHz)	Huber+Suhnar	30MHz-1GHz	1486150	Jun. 08, 2020	Jun. 07, 2021
RF cables3 (1GHz-40GHz)	Huber+Suhnar	1GHz-40GHz	1607106	Jun. 08, 2020	Jun. 07, 2021
Power Metter	Keysight	E4419B	\	Jun. 08, 2020	Jun. 07, 2021
Power Sensor (AV)	Keysight	E9 300A	\	Jun. 08, 2020	Jun. 07, 2021
Signal Analyzer 20kHz-26.5GHz	KEYSIGHT	N9020A	MY49100060	Jun. 04, 2020	Jun. 03, 2021
Spectrum Analyzer 9kHz-40GHz	Agilent	FSP40	100363	Jun. 13, 2020	Jun. 12, 2021
Software	Frad	EZ-EMC	FA-03A2RE	\	\

Conducted emissions Test					
Equipment	Manufacturer	Model#	Serial#	Last Cal.	Next Cal.
Receiver	R&S	ESR3	102075	Jun. 08, 2020	Jun. 07, 2021
LISN	R&S	ENV216	101375	Jun. 04, 2020	Jun. 03, 2021
ISN	HPX	ISN T800	S1509001	Jun. 04, 2020	Jun. 03, 2021
Software	Frad	EZ-EMC	EMC-CON 3A1	\	\

RF conducted test					
Equipment	Manufacturer	Model#	Serial#	Last Cal.	Next Cal.
Power Metter	Keysight	E4419B	\	Jun. 08, 2020	Jun. 07, 2021
Power Sensor (AV)	Keysight	E9 300A	\	Jun. 08, 2020	Jun. 07, 2021
Signal Analyzer 20kHz-26.5GHz	KEYSIGHT	N9020A	MY4910006 0	Jun. 04, 2020	Jun. 03, 2021
Spectrum Analyzer 9kHz-40GHz	Agilent	FSP40	100363	Jun. 13, 2020	Jun. 12, 2021

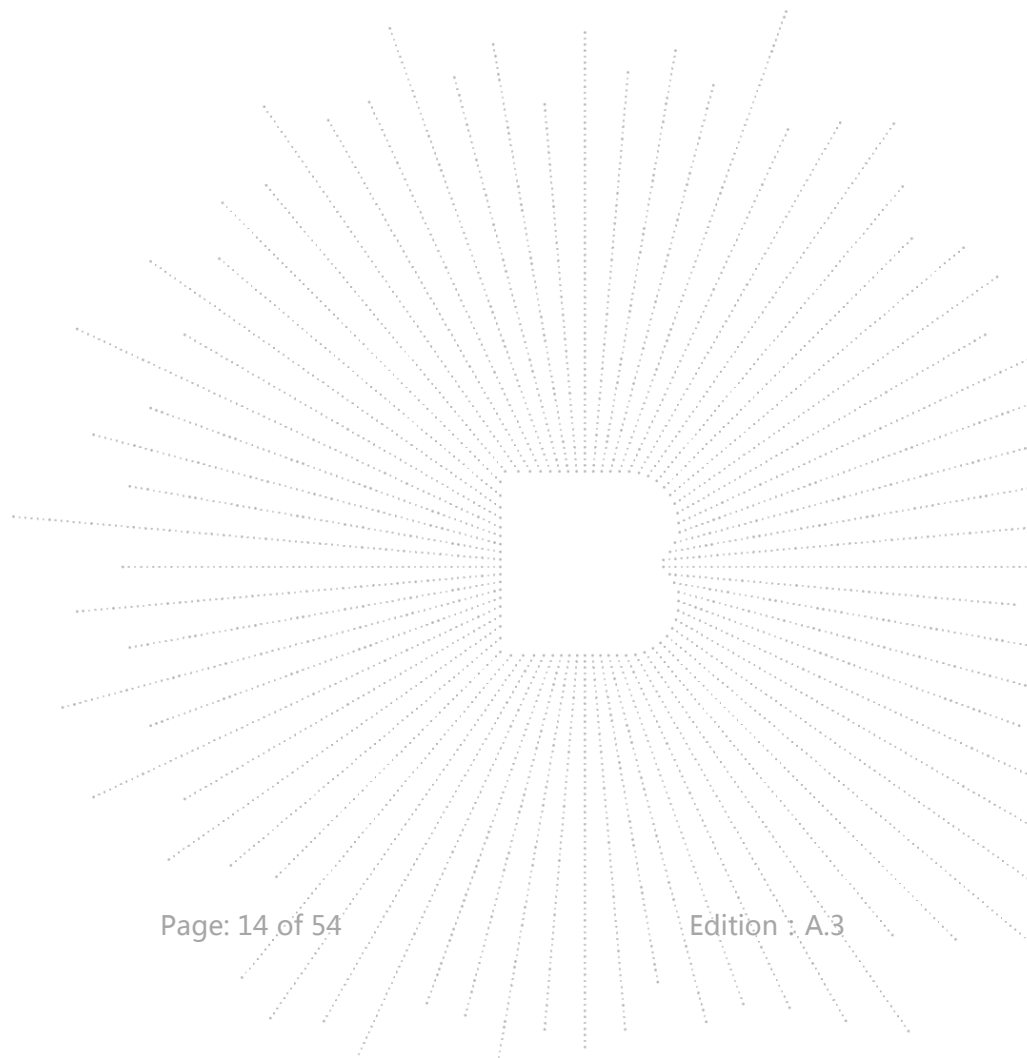

## 6. CONDUCTED EMISSIONS

### 6.1 Block Diagram Of Test Setup

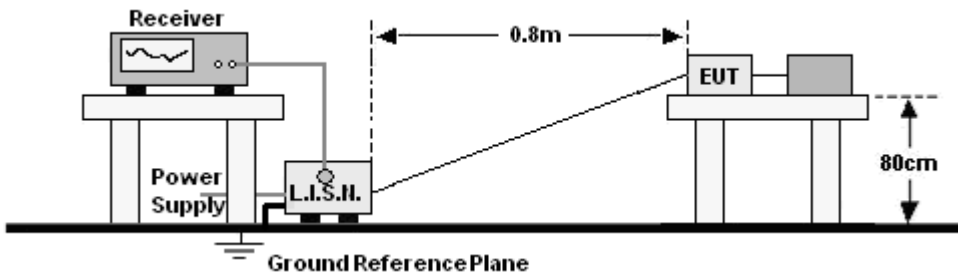

### 6.2 Limit

FREQUENCY (MHz)	Limit (dBuV)	
	Quas-peak	Average
0.15 -0.5	66 - 56 *	56 - 46 *
0.50 -5.0	56.00	46.00
5.0 -30.0	60.00	50.00

Notes:  
 1. \*Decreasing linearly with logarithm of frequency.  
 2. The lower limit shall apply at the transition frequencies.

### 6.3 Test procedure

Receiver Parameters	Setting
Attenuation	10 dB
Start Frequency	0.15 MHz
Stop Frequency	30 MHz
IF Bandwidth	9 kHz

- The Product was placed on a nonconductive table 0.8 m above the horizontal ground reference plane, and 0.4 m from the vertical ground reference plane, and connected to the main through Line Impedance Stability Network (L.I.S.N).
- The RBW of the receiver was set at 9 kHz in 150 kHz ~ 30MHz with Peak and AVG detector in Max Hold mode. Run the receiver's pre-scan to record the maximum disturbance generated from Product in all power lines in the full band.
- For each frequency whose maximum record was higher or close to limit, measure its QP and AVG values and record.

### 6.4 EUT operating Conditions

The EUT was configured for testing in a typical fashion (as a customer would normally use it). The EUT has been programmed to continuously transmit during test. This operating condition was tested and used to collect the included data.

We pretest AC 120V and AC 240V, the worst voltage was AC 120V and the data recording in the report.

### 6.5 Test Result

The EUT is powered by the DC only, the test item is not applicable.

## 7. RADIATED EMISSIONS

### 7.1 Block Diagram Of Test Setup

(A) Radiated Emission Test-Up Frequency Below 30MHz

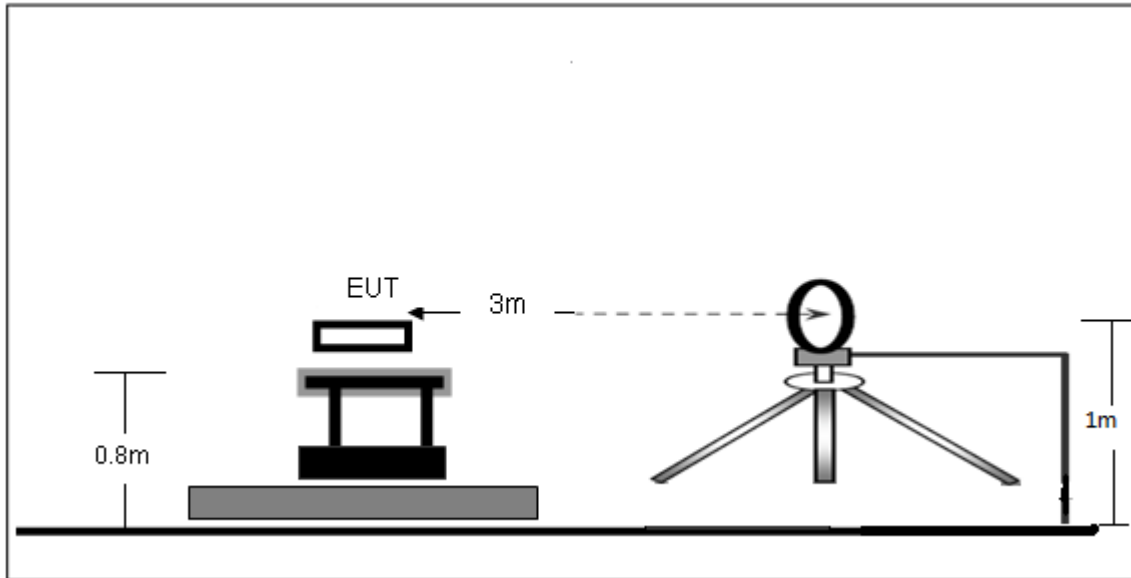

(B) Radiated Emission Test-Up Frequency 30MHz~1GHz

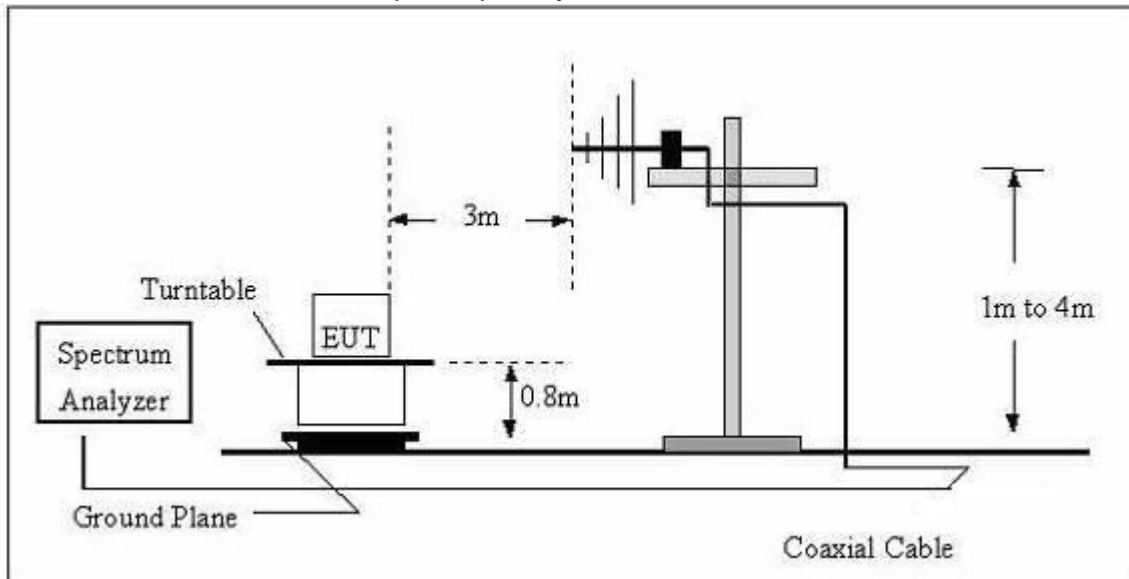



## (C) Radiated Emission Test-Up Frequency Above 1GHz

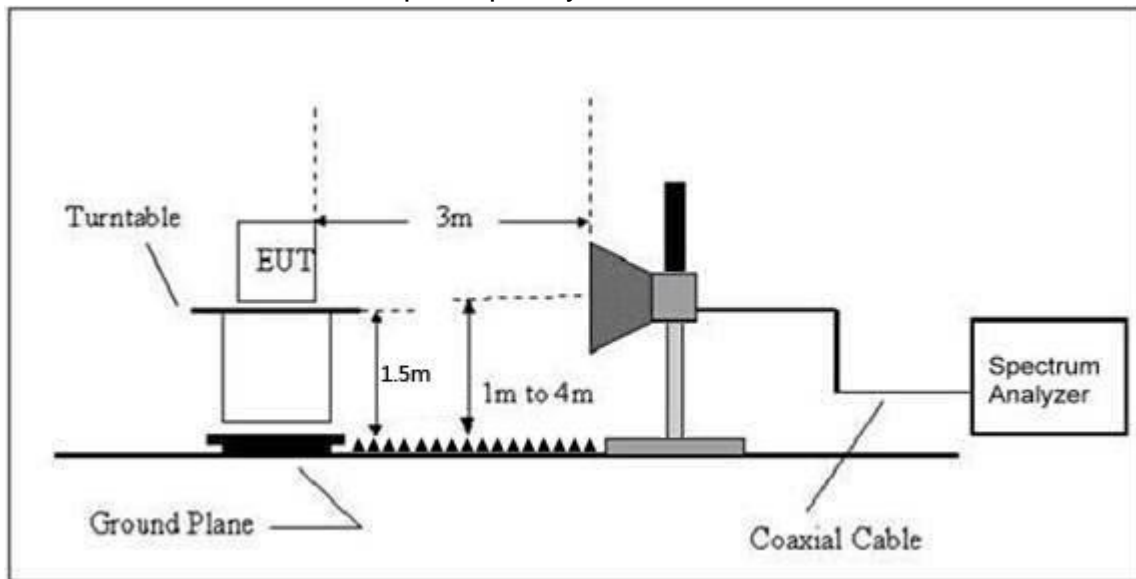

## 7.2 Limit

20dBc in any 100 kHz bandwidth outside the operating frequency band. In case the emission fall within the restricted band specified on 15.205(a), then the 15.209(a) limit in the table below has to be followed.

Frequency (MHz)	Field Strength (uV/m)	Distance (m)	Field Strength Limit at 3m Distance	
			uV/m	dBuV/m
0.009 ~ 0.490	2400/F(kHz)	300	$10000 * 2400/F(\text{kHz})$	$20\log^{(2400/F(\text{kHz}))} + 80$
0.490 ~ 1.705	24000/F(kHz)	30	$100 * 24000/F(\text{kHz})$	$20\log^{(24000/F(\text{kHz}))} + 40$
1.705 ~ 30	30	30	$100 * 30$	$20\log^{(30)} + 40$
30 ~ 88	100	3	100	$20\log^{(100)}$
88 ~ 216	150	3	150	$20\log^{(150)}$
216 ~ 960	200	3	200	$20\log^{(200)}$
Above 960	500	3	500	$20\log^{(500)}$

### LIMITS OF RADIATED EMISSION MEASUREMENT (Above 1000MHz)

FREQUENCY (MHz)	Limit (dBuV/m) (at 3M)	
	PEAK	AVERAGE
Above 1000	74	54

Notes:

- (1) The limit for radiated test was performed according to FCC PART 15C.
- (2) The tighter limit applies at the band edges.
- (3) Emission level (dBuV/m) =  $20\log$  Emission level (uV/m).

### 7.3 Test procedure

The test site semi-anechoic chamber has met the requirement of NSA tolerance 4 dB according to the standards: ANSI C63.10-2013. The test distance is 3m. The setup is according to the requirements in Section 13.1.4.1 of ANSI C63.10-2013 and CAN/CSA-CEI/IEC CISPR 22.

This test is required for any spurious emission that falls in a Restricted Band, as defined in Section 15.205.

It must be performed with the highest gain of each type of antenna proposed for use with the EUT.

Use the following spectrum analyzer settings:

Spectrum Parameter	Setting
Attenuation	Auto
Start Frequency	1000 MHz
Stop Frequency	10th carrier harmonic
RB / VB (emission in restricted band)	1 MHz / 1 MHz for Peak, 1 MHz / 10Hz for Average

Receiver Parameter	Setting
Attenuation	Auto
Start ~ Stop Frequency	9kHz~150kHz / RB 200Hz for QP
Start ~ Stop Frequency	150kHz~30MHz / RB 9kHz for QP
Start ~ Stop Frequency	30MHz~1000MHz / RB 120kHz for QP

- a. The measuring distance of at 3 m shall be used for measurements at frequency up to 1GHz. For frequencies above 1GHz, any suitable measuring distance may be used.
- b. The EUT was placed on the top of a rotating table 0.8 m for below 1GHz and 1.5m for above 1GHz the ground at a 3 meter. The table was rotated 360 degrees to determine the position of the highest radiation.
- c. The height of the equipment or of the substitution antenna shall be 0.8 m for below 1GHz and 1.5m for above 1GHz; the height of the test antenna shall vary between 1 m to 4 m. Both horizontal and vertical polarizations of the antenna are set to make the measurement.
- d. The initial step in collecting conducted emission data is a spectrum analyzer peak detector mode pre-scanning the measurement frequency range. Significant peaks are then marked and then Quasi Peak detector mode re-measured.
- e. If the Peak Mode measured value compliance with and lower than Quasi Peak Mode Limit, the EUT shall be deemed to meet QP Limits and then no additional QP Mode measurement performed.
- f. For the actual test configuration, please refer to the related Item –EUT Test Photos.

Note:

Both horizontal and vertical antenna polarities were tested and performed pretest to three orthogonal axis. The worst case emissions were reported

During the radiated emission test, the Spectrum Analyzer was set with the following configurations:

Frequency Band (MHz)	Function	Resolution bandwidth	Video Bandwidth
30 to 1000	QP	120 kHz	300 kHz
Above 1000	Peak	1 MHz	1 MHz
	Average	1 MHz	10 Hz

Note: for the frequency ranges below 30 MHz, a narrower RBW is used for these ranges but the measured value should add a RBW correction factor (RBWCF) where  $RBWCF [dB] = 10 \cdot \lg(100 [kHz] / \text{narrower RBW [kHz]})$ . , the narrower RBW is 1 kHz and RBWCF is 20 dB for the frequency 9 kHz to 150 kHz, and the narrower RBW is 10 kHz and RBWCF is 10 dB for the frequency 150 kHz to 30 MHz.

#### 7.4 EUT operating Conditions

The EUT was configured for testing in a typical fashion (as a customer would normally use it). The EUT has been programmed to continuously transmit during test. This operating condition was tested and used to collect the included data.

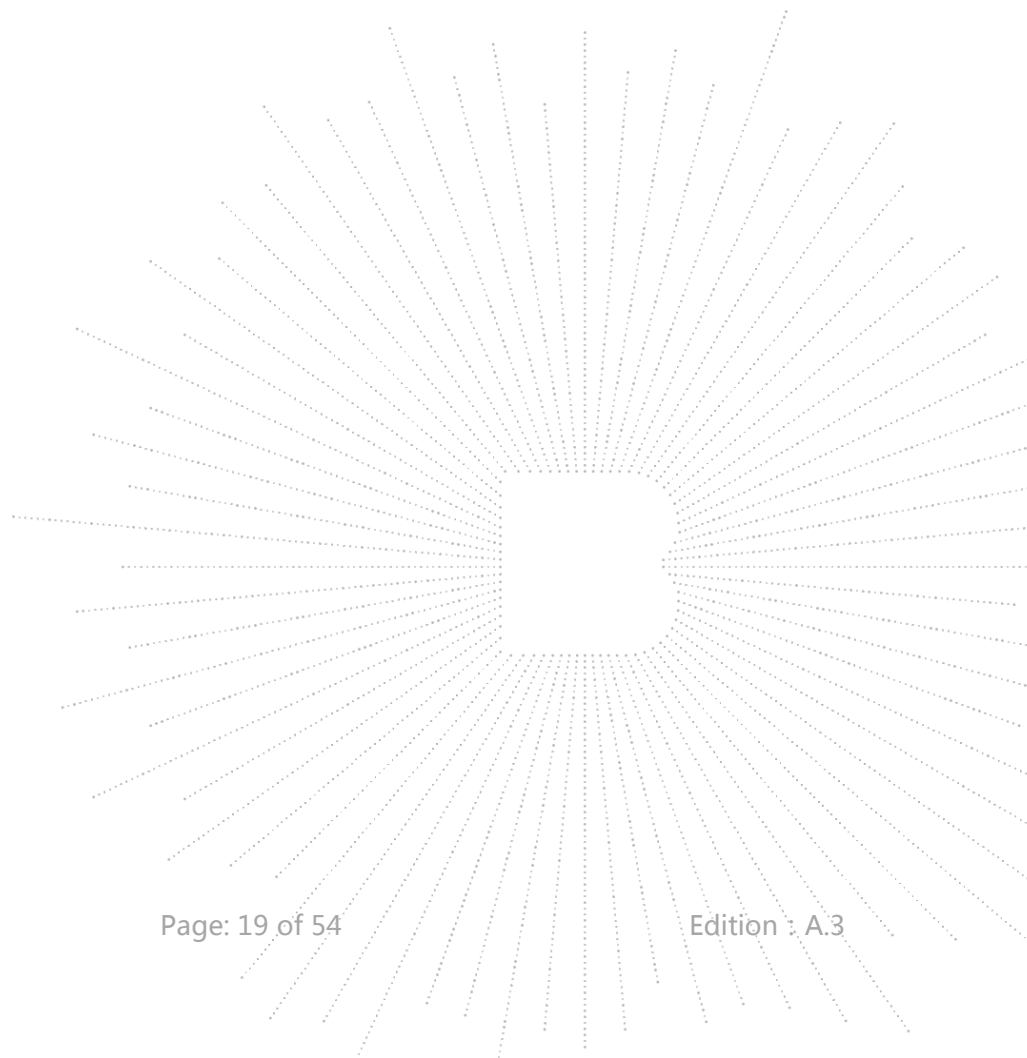

## 7.5 Test Result

Below 30MHz

Temperature:	26°C	Relative Humidity:	24%
Pressure:	101 kPa	Test Voltage :	AC120V/60Hz
Test Mode :	Mode 2	Polarization :	--

Freq. (MHz)	Reading (dBuV/m)	Limit (dBuV/m)	Margin (dB)	State P/F
--	--	--	--	PASS
--	--	--	--	PASS

**Note:**

The amplitude of spurious emissions which are attenuated by more than 20dB below the permissible value has no need to be reported.

Distance extrapolation factor =  $40 \log(\text{specific distance}/\text{test distance})(\text{dB})$ ;

Limit line = specific limits(dBuv) + distance extrapolation factor.

## Between 30MHz – 1GHz

Temperature:	26°C	Relative Humidity:	54%
Pressure:	101 kPa	Test Voltage :	AC120V/60Hz
Test Mode :	Mode 2	Polarization :	Horizontal

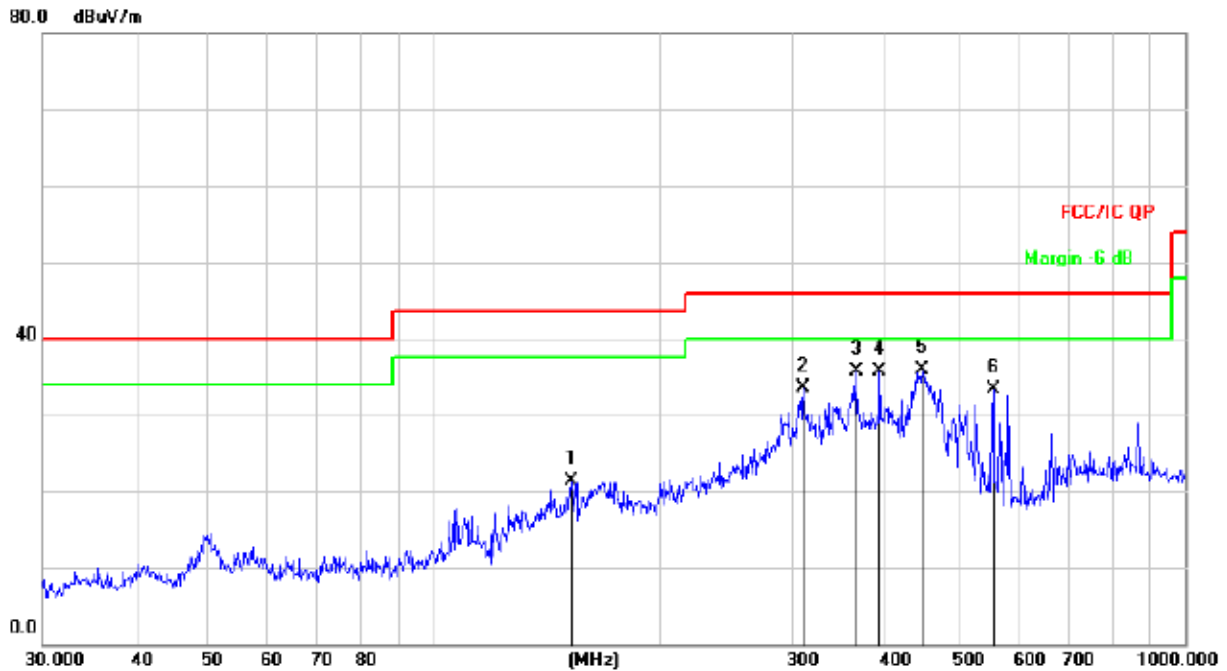

Remark:

Factor = Antenna Factor + Cable Loss – Pre-amplifier.

No.	Mk.	Freq. MHz	Reading Level dBuV	Correct Factor dB	Measure- ment dBuV/m	Limit dB/m	Over dB	Detector
1		152.1297	39.88	-18.56	21.32	43.50	-22.18	QP
2		309.9977	45.65	-12.13	33.52	46.00	-12.48	QP
3		364.2595	46.42	-10.67	35.75	46.00	-10.25	QP
4		392.0951	45.69	-9.90	35.79	46.00	-10.21	QP
5	*	446.4141	44.66	-8.70	35.96	46.00	-10.04	QP
6		554.8254	39.56	-6.19	33.37	46.00	-12.63	QP

Temperature:	26°C	Relative Humidity:	54%
Pressure:	101 kpa	Test Voltage :	AC120V/60Hz
Test Mode :	Mode 2	Polarization :	Vertical

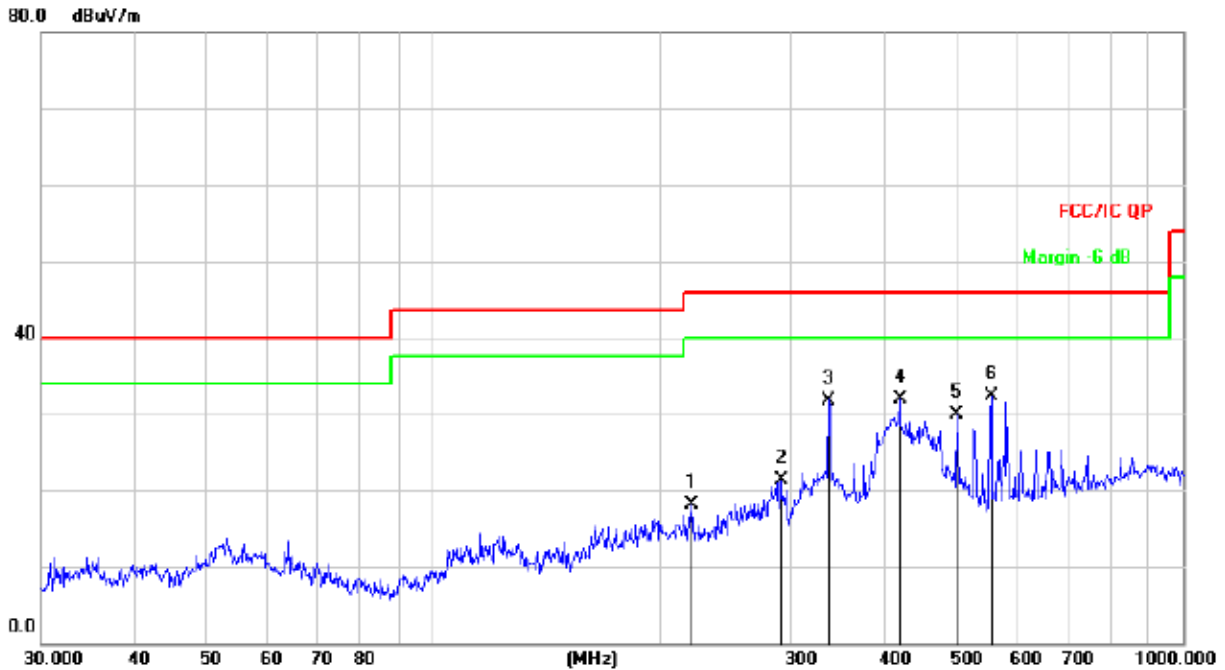

Remark:

Factor = Antenna Factor + Cable Loss – Pre-amplifier.

No.	Mk.	Freq. MHz	Reading Level dBuV	Correct Factor dB	Measure- ment dBuV/m	Limit dB/m	Over dB	Detector
1		221.3921	32.97	-14.82	18.15	46.00	-27.85	QP
2		291.0360	33.96	-12.73	21.23	46.00	-24.77	QP
3		337.2155	43.21	-11.41	31.80	46.00	-14.20	QP
4		419.1081	41.15	-9.27	31.88	46.00	-14.12	QP
5		499.4247	37.49	-7.58	29.91	46.00	-16.09	QP
6	*	554.8254	38.59	-6.19	32.40	46.00	-13.60	QP

## Between 1GHz – 40GHz

Test Mode :	TX (5.8G) -- 802.11a
-------------	----------------------

Polar (H/V)	Frequency	Meter Reading	Cable loss	Antenna Factor	Preamp Factor	Emission Level	Limits	Margin	Detector Type
	(MHz)	(dBuV)	(dB)	dB/m	(dB)	(dBuV/m)	(dBuV/m)	(dB)	
<b>Low Channel (5745 MHz)-Above 1G</b>									
V	4679.142	62.92	5.94	35.40	44.00	60.26	74.00	-13.74	PK
V	4679.142	43.21	5.94	35.40	44.00	40.55	54.00	-13.45	AV
V	11490.148	61.47	8.46	39.75	44.50	65.18	68.20	-3.02	PK
V	11490.148	43.73	8.46	39.75	44.50	47.44	54.00	-6.56	AV
V	17235.094	61.76	10.12	38.80	44.10	66.58	68.20	-1.62	PK
H	4679.157	61.38	5.94	35.18	44.00	58.50	74.00	-15.50	PK
H	4679.157	43.32	5.94	35.18	44.00	40.44	54.00	-13.56	AV
H	11490.188	54.03	8.46	38.71	44.50	56.70	68.20	-11.50	PK
H	11490.188	44.78	8.46	38.71	44.50	47.45	54.00	-6.55	AV
H	17235.008	52.64	10.12	38.38	44.10	57.04	68.20	-11.16	PK
<b>middle Channel (5785 MHz)-Above 1G</b>									
V	4592.084	64.85	6.48	36.35	44.05	63.63	74.00	-10.37	PK
V	4592.084	43.71	6.48	36.35	44.05	42.49	54.00	-11.51	AV
V	11570.081	60.22	8.47	37.88	44.51	62.06	68.20	-6.14	PK
V	11570.081	43.33	8.47	37.88	44.51	45.17	54.00	-8.83	AV
V	17355.007	61.64	10.12	38.80	44.10	66.46	68.20	-1.74	PK
H	4592.019	60.26	6.48	36.37	44.05	59.06	74.00	-14.94	PK
H	4592.019	43.37	6.48	36.37	44.05	42.17	54.00	-11.83	AV
H	11570.076	53.32	8.47	38.64	44.50	55.93	68.20	-12.27	PK
H	11570.076	44.01	8.47	38.64	44.50	46.62	54.00	-7.38	AV
H	17355.138	50.60	10.12	38.38	44.10	55.00	68.20	-13.20	PK
<b>High Channel (5825 MHz)-Above 1G</b>									
V	6039.190	61.38	7.10	37.24	43.50	62.22	68.20	-5.98	PK
V	6039.190	43.94	7.10	37.24	43.50	44.78	54.00	-9.22	AV
V	11650.138	61.89	8.46	37.68	44.50	63.53	74.00	-10.47	PK
V	11650.138	43.71	8.46	37.68	44.50	45.35	54.00	-8.65	AV
V	17475.092	60.93	10.12	38.80	44.10	65.75	68.20	-2.45	PK
H	6039.006	63.70	7.10	37.24	43.50	64.54	68.20	-3.66	PK
H	6039.006	43.36	7.10	37.24	43.50	44.20	54.00	-9.80	AV
H	11650.128	51.34	8.46	38.57	44.50	53.87	74.00	-20.13	PK
H	11650.128	42.35	8.46	38.57	44.50	44.88	54.00	-9.12	AV
H	17475.065	50.38	10.12	38.38	44.10	54.78	68.20	-13.42	PK

Note: PK value is lower than the Average value limit, So average didn't record.

The 26.5-40G amplitude of spurious emissions that are attenuated by more than 20dB below the permissible value has no need to be reported.

Emission level (dBuV/m) = 20 log Emission level (uV/m).

Corrected Reading: Antenna Factor + Cable Loss + Read Level - Preamp Factor = Level.

The Worst mode is Antenna A.

Test Mode :	TX (5.8G) --802.11n-HT20
-------------	--------------------------

Polar (H/V)	Frequency	Meter Reading	Cable loss	Antenna Factor	Preamp Factor	Emission Level	Limits	Margin	Detector Type
	(MHz)	(dBuV)	(dB)	dB/m	(dB)	(dBuV/m)	(dBuV/m)	(dB)	
<b>Low Channel (5745 MHz)-Above 1G</b>									
V	4679.148	62.90	5.94	35.40	44.00	60.24	74.00	-13.76	PK
V	4679.148	43.19	5.94	35.40	44.00	40.53	54.00	-13.47	AV
V	11490.037	61.29	8.46	39.75	44.50	65.00	68.20	-3.20	PK
V	11490.037	43.64	8.46	39.75	44.50	47.35	54.00	-6.65	AV
V	17235.076	60.88	10.12	38.80	44.10	65.70	68.20	-2.5	PK
H	4679.020	64.62	5.94	35.18	44.00	61.74	74.00	-12.26	PK
H	4679.020	43.26	5.94	35.18	44.00	40.38	54.00	-13.62	AV
H	11490.153	52.94	8.46	38.71	44.50	55.61	68.20	-12.59	PK
H	11490.153	42.91	8.46	38.71	44.50	45.58	54.00	-8.42	AV
H	17235.016	53.51	10.12	38.38	44.10	57.91	68.20	-10.29	PK
<b>middle Channel (5785 MHz)-Above 1G</b>									
V	4592.164	63.06	6.48	36.35	44.05	61.84	74.00	-12.16	PK
V	4592.164	43.24	6.48	36.35	44.05	42.02	54.00	-11.98	AV
V	11570.172	63.20	8.47	37.88	44.51	65.04	68.20	-3.16	PK
V	11570.172	43.89	8.47	37.88	44.51	45.73	54.00	-8.27	AV
V	17355.001	61.70	10.12	38.80	44.10	66.52	68.20	-1.68	PK
H	4592.197	62.62	6.48	36.37	44.05	61.42	74.00	-12.58	PK
H	4592.197	43.20	6.48	36.37	44.05	42.00	54.00	-12.00	AV
H	11570.189	51.89	8.47	38.64	44.50	54.50	68.20	-13.70	PK
H	11570.189	43.63	8.47	38.64	44.50	46.24	54.00	-7.76	AV
H	17355.128	52.35	10.12	38.38	44.10	56.75	68.20	-11.45	PK
<b>High Channel (5825 MHz)-Above 1G</b>									
V	6039.137	62.46	7.10	37.24	43.50	63.30	68.20	-4.90	PK
V	6039.137	43.99	7.10	37.24	43.50	44.83	54.00	-9.17	AV
V	11650.050	60.58	8.46	37.68	44.50	62.22	74.00	-11.78	PK
V	11650.050	43.15	8.46	37.68	44.50	44.79	54.00	-9.21	AV
V	17475.173	60.56	10.12	38.80	44.10	65.38	68.20	-2.82	PK
H	6039.094	63.99	7.10	37.24	43.50	64.83	68.20	-3.37	PK
H	6039.094	43.81	7.10	37.24	43.50	44.65	54.00	-9.35	AV
H	11650.068	51.81	8.46	38.57	44.50	54.34	74.00	-19.66	PK
H	11650.068	40.31	8.46	38.57	44.50	42.84	54.00	-11.16	AV
H	17475.027	50.27	10.12	38.38	44.10	54.67	68.20	-13.53	PK

Note: PK value is lower than the Average value limit, So average didn't record.

The 26.5-40G amplitude of spurious emissions that are attenuated by more than 20dB below the permissible value has no need to be reported.

Emission level (dBuV/m) = 20 log Emission level (uV/m).

Corrected Reading: Antenna Factor + Cable Loss + Read Level - Preamp Factor = Level.

Test Mode is MIMO Mode.



## 8. POWER SPECTRAL DENSITY TEST

### 8.1 Block Diagram Of Test Setup



### 8.2 Limit

For the band 5.15-5.25 GHz,

(i) For an outdoor access point operating in the band 5.15-5.25 GHz, the maximum power spectral density shall not exceed 17 dBm in any 1 megahertz band. If transmitting antennas of directional

gain greater than 6 dBi are used, both the maximum conducted output power and the maximum

power spectral density shall be reduced by the amount in dB that the directional gain of the antenna exceeds 6 dBi. The maximum e.i.r.p. at any elevation angle above 30 degrees as measured from the horizon must not exceed 125 mW (21 dBm).

(ii) For an indoor access point operating in the band 5.15-5.25 GHz, the maximum power spectral density shall not exceed 17 dBm in any 1 megahertz band. If transmitting antennas of directional

gain greater than 6 dBi are used, both the maximum conducted output power and the maximum power spectral density shall be reduced by the amount in dB that the directional gain of

the antenna exceeds 6 dBi.

(iii) For fixed point-to-point access points operating in the band 5.15-5.25 GHz, the maximum power spectral density shall not exceed 17 dBm in any 1 megahertz band. Fixed point-to-point U-NII devices may employ antennas with directional gain up to 23 dBi without any corresponding reduction in the maximum conducted output power or maximum power spectral density. For fixed point-to-point transmitters that employ a directional antenna gain greater than 23 dBi, a 1 dB reduction in

maximum conducted output power and maximum power spectral density is required for each 1 dB of antenna gain in excess of 23 dBi. Fixed, point-to-point operations exclude the use of point-to-multipoint systems, omnidirectional applications, and multiple collocated transmitters transmitting the same information. The operator of the U-NII device, or if the equipment is professionally installed, the installer, is responsible for ensuring that systems employing high gain directional antennas are used exclusively for fixed, point-to-point operations.

(iv) For client devices in the 5.15-5.25 GHz band, the maximum power spectral density shall not exceed 11 dBm in any 1 megahertz band. If transmitting antennas of directional gain greater than 6 dBi are used, both the maximum conducted output power and the maximum power spectral density shall be reduced by the amount in dB that the directional gain of the antenna exceeds 6 dBi.

For the band 5.725-5.85 GHz

(3) For the band 5.725-5.85 GHz, the maximum power spectral density shall not exceed 30 dBm in any 500-kHz band. If transmitting antennas of directional gain greater than 6 dBi are used, both the maximum conducted output power and the maximum power spectral density shall be reduced by the amount in dB that the directional gain of the antenna exceeds 6 dBi.

### 8.3 Test procedure

For devices operating in the bands 5.15-5.25 GHz, 5.25-5.35 GHz, and 5.47-5.725 GHz, the above procedures make use of 1 MHz RBW to satisfy directly the 1 MHz reference bandwidth specified in § 15.407(a)(5). For devices operating in the band 5.725-5.85 GHz, the rules specify a measurement bandwidth of 500 kHz. Many spectrum analyzers do not have 500 kHz RBW, thus a narrower RBW may need to be used. The rules permit the use of a RBWs less than 1 MHz, or 500 kHz, “provided that the measured power is integrated over the full reference bandwidth” to show the total power over the specified measurement bandwidth (i.e., 1 MHz, or 500 kHz). If measurements are performed using a reduced resolution bandwidth (< 1 MHz, or < 500 kHz) and integrated over 1 MHz, or 500 KHz bandwidth, the following adjustments to the procedures apply:

a) Set  $RBW \geq 1/T$ , where T is defined in section II.B.I.a).

b) Set  $VBW \geq 3 RBW$ .

c) If measurement bandwidth of Maximum PSD is specified in 500 kHz, add  $10\log(500\text{kHz}/RBW)$  to the measured result, whereas  $RBW (< 500 \text{ KHz})$  is the reduced resolution bandwidth of the spectrum analyzer set during measurement.

d) If measurement bandwidth of Maximum PSD is specified in 1 MHz, add  $10\log(1\text{MHz}/RBW)$  to the measured result, whereas  $RBW (< 1 \text{ MHz})$  is the reduced resolution bandwidth of spectrum analyzer set during measurement.

e) Care must be taken to ensure that the measurements are performed during a period of continuous transmission or are corrected upward for duty cycle.

Note: As a practical matter, it is recommended to use reduced RBW of 100 KHz for the sections 5.c) and 5.d) above, since  $RBW=100 \text{ KHz}$  is available on nearly all spectrum analyzers.

### 8.4 EUT operating Conditions

The EUT was configured for testing in a typical fashion (as a customer would normally use it). The EUT has been programmed to continuously transmit during test. This operating condition was tested and used to collect the included data.

## 8.5 Test Result

Temperature :	26 °C	Relative Humidity :	54%
Pressure :	101kPa	Test Voltage :	DC 14.5V from Battery
Test Mode :	TX Frequency U-NII-3 (5745-5825MHz)		

Note: A(B) Represent the value of antenna A and B, The worst data is Antenna A ,only shown Antenna A Plot.

Mode	Frequency	Measured Power Density (dBm/500KHz)			Limit (dBm/500kHz)	Result
		ANT A	ANT B	Total		
802.11 a	5745 MHz	-3.220	-3.488	/	30	PASS
	5785 MHz	-1.887	-4.103	/	30	PASS
	5825 MHz	-3.991	-5.098	/	30	PASS
802.11 n20	5745 MHz	-3.102	-4.317	-0.657	30	PASS
	5785 MHz	-2.704	-4.314	-0.425	30	PASS
	5825 MHz	-4.970	-5.836	-2.371	30	PASS

(802.11a) PSD plot on channel 149

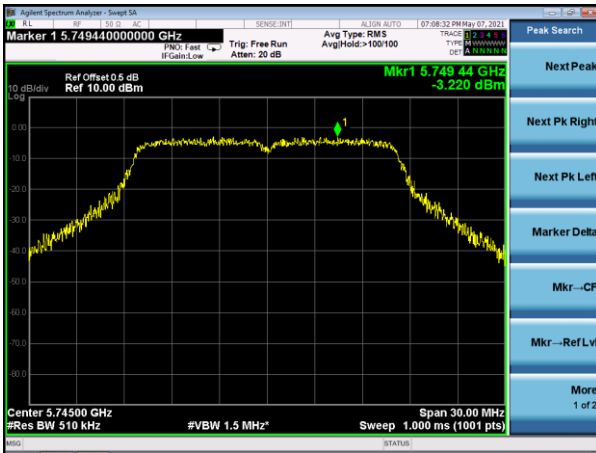

(802.11n20) PSD plot on channel 149



(802.11a) PSD plot on channel 157



(802.11n20) PSD plot on channel 157



(802.11a) PSD plot on channel 165

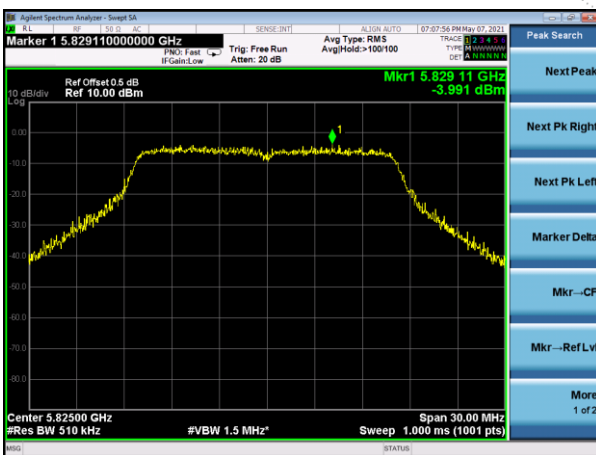

(802.11n20) PSD plot on channel 165

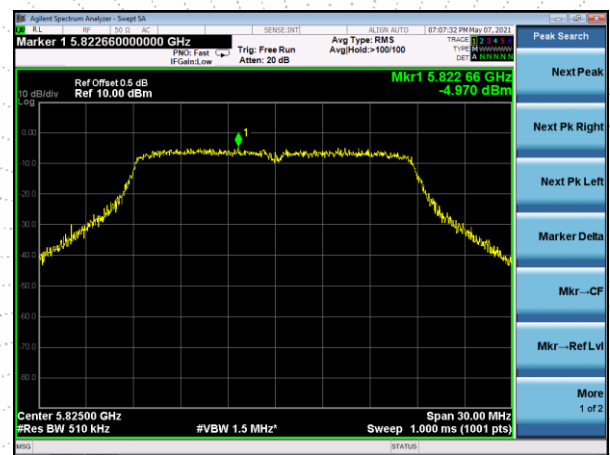

## 9. 26DB & 6DB & 99% EMISSION BANDWIDTH

### 9.1 Block Diagram Of Test Setup

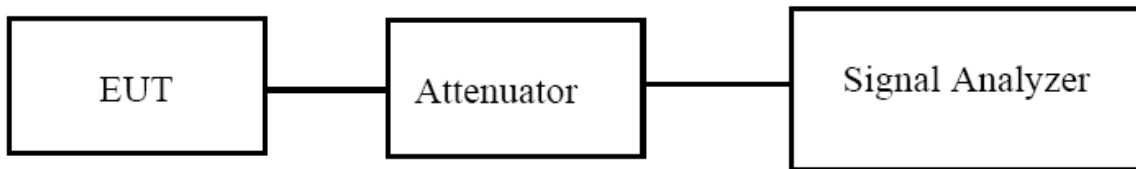

### 9.2 Limit

The maximum power spectral density is measured as a conducted emission by direct connection of a calibrated test instrument to the equipment under test. If the device cannot be connected directly, alternative techniques acceptable to the Commission may be used. Measurements in the 5.725-5.85 GHz band are made over a reference bandwidth of 500 kHz or the 26 dB emission bandwidth of the device, whichever is less. Measurements in the 5.15-5.25 GHz, 5.25-5.35 GHz, and the 5.47-5.725 GHz bands are made over a bandwidth of 1 MHz or the 26 dB emission bandwidth of the device, whichever is less. A narrower resolution bandwidth can be used, provided that the measured power is integrated over the full reference bandwidth.

### 9.3 Test procedure

- a) Set RBW = approximately 1% of the emission bandwidth.
- b) Set the VBW > RBW.
- c) Detector = Peak.
- d) Trace mode = max hold.
- e) Measure the maximum width of the emission that is 26 dB down from the maximum of the emission. Compare this with the RBW setting of the analyzer. Readjust RBW and repeat measurement as needed until the RBW/EBW ratio is approximately 1%.

The following procedure shall be used for measuring (99 %) power bandwidth:

1. Set center frequency to the nominal EUT channel center frequency.
2. Set span = 1.5 times to 5.0 times the OBW.
3. Set RBW = 1 % to 5 % of the OBW
4. Set VBW  $\geq 3 \cdot$  RBW
5. Video averaging is not permitted. Where practical, a sample detection and single sweep mode shall be used. Otherwise, peak detection and max hold mode (until the trace stabilizes) shall be used.
6. Use the 99 % power bandwidth function of the instrument (if available).
7. If the instrument does not have a 99 % power bandwidth function, the trace data points are recovered and directly summed in power units. The recovered amplitude data points, beginning at the lowest frequency, are placed in a running sum until 0.5 % of the total is reached; that frequency is recorded as the lower frequency. The process is repeated until 99.5 % of the total is reached; that frequency is recorded as the upper frequency. The 99% occupied bandwidth is the difference between these two frequencies.

## 9.4 EUT operating Conditions

The EUT was configured for testing in a typical fashion (as a customer would normally use it). The EUT has been programmed to continuously transmit during test. This operating condition was tested and used to collect the included data.

## 9.5 Test Result

Temperature :	26 °C	Relative Humidity :	54%
Pressure :	101kPa	Test Voltage :	DC 14.5V from Battery
Test Mode :	TX Frequency U-NII-3(5745-5825MHz)		

Note: A(B) Represent the value of antenna A and B, The worst data is Antenna A ,only shown Antenna A Plot.

Mode	Channel	Frequency (MHz)	99% bandwidth (MHz)	6dB bandwidth (MHz)	Limit MHz	Result
			ANT A	ANT A		
802.11a	CH149	5745	16.828	16.53	≥500	Pass
	CH157	5785	16.787	16.50	≥500	Pass
	CH165	5825	16.790	16.54	≥500	Pass
802.11 n20	CH149	5745	17.872	17.72	≥500	Pass
	CH157	5785	17.837	17.74	≥500	Pass
	CH165	5825	17.889	17.72	≥500	Pass

Mode	Channel	Frequency (MHz)	99% bandwidth (MHz)	6dB bandwidth (MHz)	Limit MHz	Result
			ANT B	ANT B		
802.11a	CH149	5745	16.819	16.56	≥500	Pass
	CH157	5785	16.758	16.52	≥500	Pass
	CH165	5825	16.837	16.54	≥500	Pass
802.11 n20	CH149	5745	17.856	17.71	≥500	Pass
	CH157	5785	17.816	17.70	≥500	Pass
	CH165	5825	17.836	17.78	≥500	Pass

Antenna B: 5725-5850MHz

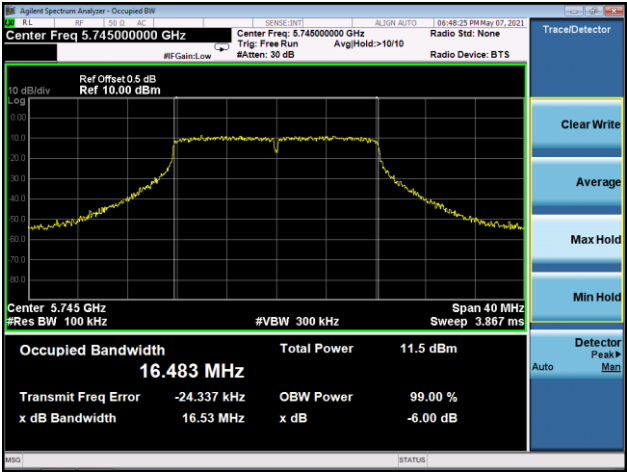
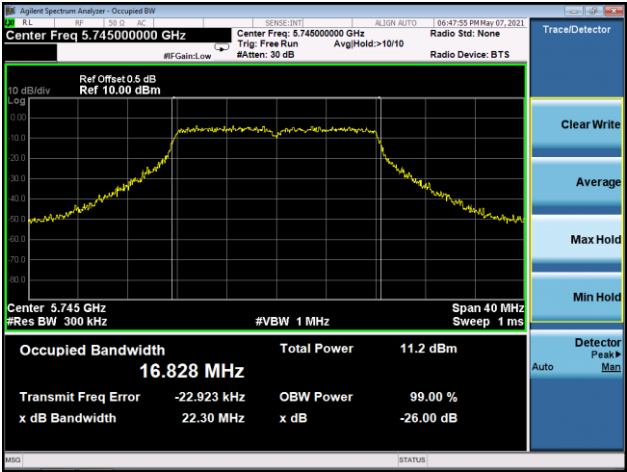
Mode:	802.11a
5745MHz 6dB bandwidth	 <p>                         Center Freq: 5.745 GHz                          Span: 40 MHz                          Res BW: 100 kHz                          VBW: 300 kHz                          Sweep: 3.867 ms  <b>Occupied Bandwidth: 16.483 MHz</b>                          Total Power: 11.5 dBm                          Transmit Freq Error: -24.337 kHz                          OBW Power: 99.00 %                          x dB Bandwidth: 16.53 MHz                          x dB: -6.00 dB                     </p>
5745MHz 99% bandwidth	 <p>                         Center Freq: 5.745 GHz                          Span: 40 MHz                          Res BW: 300 kHz                          VBW: 1 MHz                          Sweep: 1 ms  <b>Occupied Bandwidth: 16.828 MHz</b>                          Total Power: 11.2 dBm                          Transmit Freq Error: -22.923 kHz                          OBW Power: 99.00 %                          x dB Bandwidth: 22.30 MHz                          x dB: -26.00 dB                     </p>

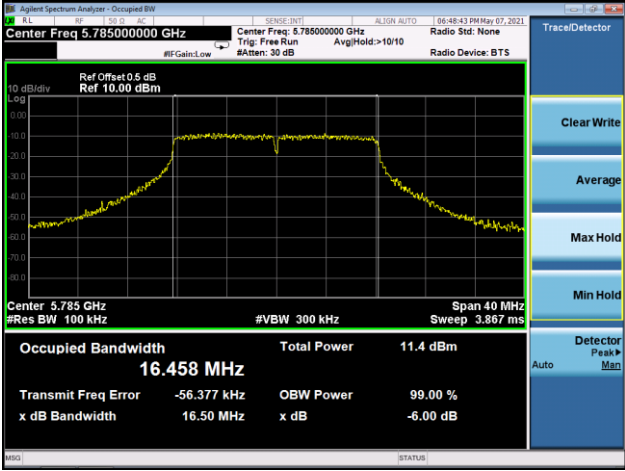
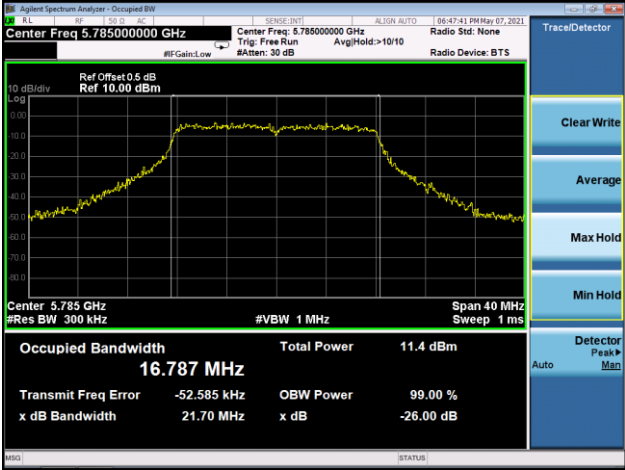
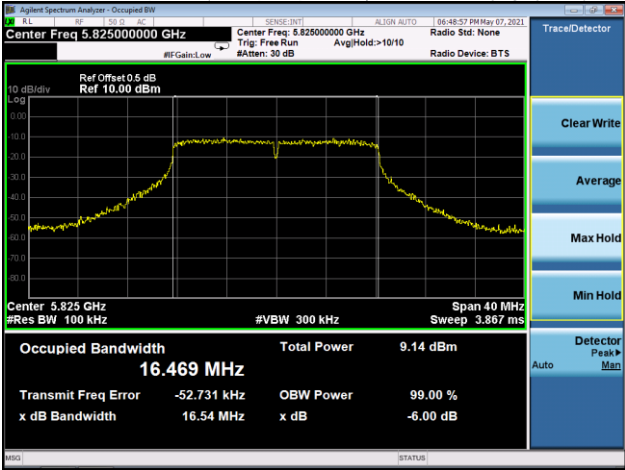
<p>5785MHz 6dB bandwidth</p>	 <table border="1"> <tr> <td>Center Freq</td> <td>5.785 GHz</td> <td>#Res BW</td> <td>100 kHz</td> <td>#VBW</td> <td>300 kHz</td> <td>Span</td> <td>40 MHz</td> <td>Sweep</td> <td>3.867 ms</td> </tr> <tr> <td>Occupied Bandwidth</td> <td colspan="2">16.458 MHz</td> <td>Total Power</td> <td colspan="2">11.4 dBm</td> <td colspan="4"></td> </tr> <tr> <td>Transmit Freq Error</td> <td colspan="2">-56.377 kHz</td> <td>OBW Power</td> <td colspan="2">99.00 %</td> <td colspan="4"></td> </tr> <tr> <td>x dB Bandwidth</td> <td colspan="2">16.50 MHz</td> <td>x dB</td> <td colspan="2">-6.00 dB</td> <td colspan="4"></td> </tr> </table>	Center Freq	5.785 GHz	#Res BW	100 kHz	#VBW	300 kHz	Span	40 MHz	Sweep	3.867 ms	Occupied Bandwidth	16.458 MHz		Total Power	11.4 dBm						Transmit Freq Error	-56.377 kHz		OBW Power	99.00 %						x dB Bandwidth	16.50 MHz		x dB	-6.00 dB					
Center Freq	5.785 GHz	#Res BW	100 kHz	#VBW	300 kHz	Span	40 MHz	Sweep	3.867 ms																																
Occupied Bandwidth	16.458 MHz		Total Power	11.4 dBm																																					
Transmit Freq Error	-56.377 kHz		OBW Power	99.00 %																																					
x dB Bandwidth	16.50 MHz		x dB	-6.00 dB																																					
<p>5785MHz 99% bandwidth</p>	 <table border="1"> <tr> <td>Center Freq</td> <td>5.785 GHz</td> <td>#Res BW</td> <td>300 kHz</td> <td>#VBW</td> <td>1 MHz</td> <td>Span</td> <td>40 MHz</td> <td>Sweep</td> <td>1 ms</td> </tr> <tr> <td>Occupied Bandwidth</td> <td colspan="2">16.787 MHz</td> <td>Total Power</td> <td colspan="2">11.4 dBm</td> <td colspan="4"></td> </tr> <tr> <td>Transmit Freq Error</td> <td colspan="2">-52.585 kHz</td> <td>OBW Power</td> <td colspan="2">99.00 %</td> <td colspan="4"></td> </tr> <tr> <td>x dB Bandwidth</td> <td colspan="2">21.70 MHz</td> <td>x dB</td> <td colspan="2">-26.00 dB</td> <td colspan="4"></td> </tr> </table>	Center Freq	5.785 GHz	#Res BW	300 kHz	#VBW	1 MHz	Span	40 MHz	Sweep	1 ms	Occupied Bandwidth	16.787 MHz		Total Power	11.4 dBm						Transmit Freq Error	-52.585 kHz		OBW Power	99.00 %						x dB Bandwidth	21.70 MHz		x dB	-26.00 dB					
Center Freq	5.785 GHz	#Res BW	300 kHz	#VBW	1 MHz	Span	40 MHz	Sweep	1 ms																																
Occupied Bandwidth	16.787 MHz		Total Power	11.4 dBm																																					
Transmit Freq Error	-52.585 kHz		OBW Power	99.00 %																																					
x dB Bandwidth	21.70 MHz		x dB	-26.00 dB																																					
<p>5825MHz 6dB bandwidth</p>	 <table border="1"> <tr> <td>Center Freq</td> <td>5.825 GHz</td> <td>#Res BW</td> <td>100 kHz</td> <td>#VBW</td> <td>300 kHz</td> <td>Span</td> <td>40 MHz</td> <td>Sweep</td> <td>3.867 ms</td> </tr> <tr> <td>Occupied Bandwidth</td> <td colspan="2">16.469 MHz</td> <td>Total Power</td> <td colspan="2">9.14 dBm</td> <td colspan="4"></td> </tr> <tr> <td>Transmit Freq Error</td> <td colspan="2">-52.731 kHz</td> <td>OBW Power</td> <td colspan="2">99.00 %</td> <td colspan="4"></td> </tr> <tr> <td>x dB Bandwidth</td> <td colspan="2">16.54 MHz</td> <td>x dB</td> <td colspan="2">-6.00 dB</td> <td colspan="4"></td> </tr> </table>	Center Freq	5.825 GHz	#Res BW	100 kHz	#VBW	300 kHz	Span	40 MHz	Sweep	3.867 ms	Occupied Bandwidth	16.469 MHz		Total Power	9.14 dBm						Transmit Freq Error	-52.731 kHz		OBW Power	99.00 %						x dB Bandwidth	16.54 MHz		x dB	-6.00 dB					
Center Freq	5.825 GHz	#Res BW	100 kHz	#VBW	300 kHz	Span	40 MHz	Sweep	3.867 ms																																
Occupied Bandwidth	16.469 MHz		Total Power	9.14 dBm																																					
Transmit Freq Error	-52.731 kHz		OBW Power	99.00 %																																					
x dB Bandwidth	16.54 MHz		x dB	-6.00 dB																																					



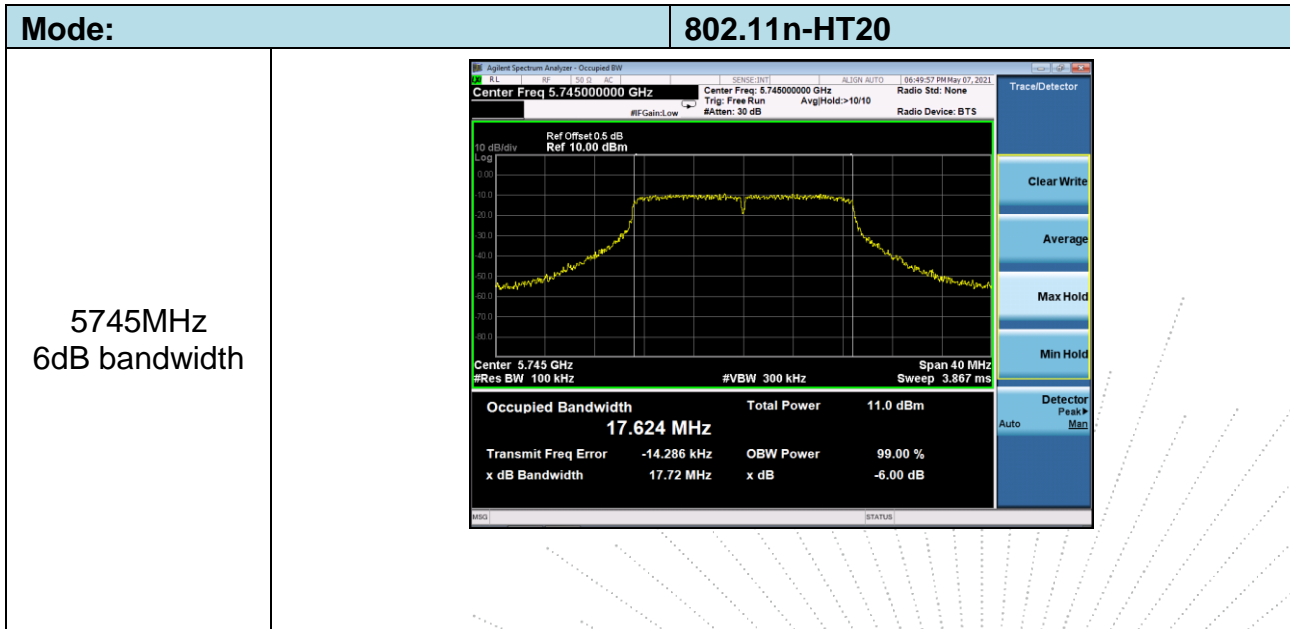
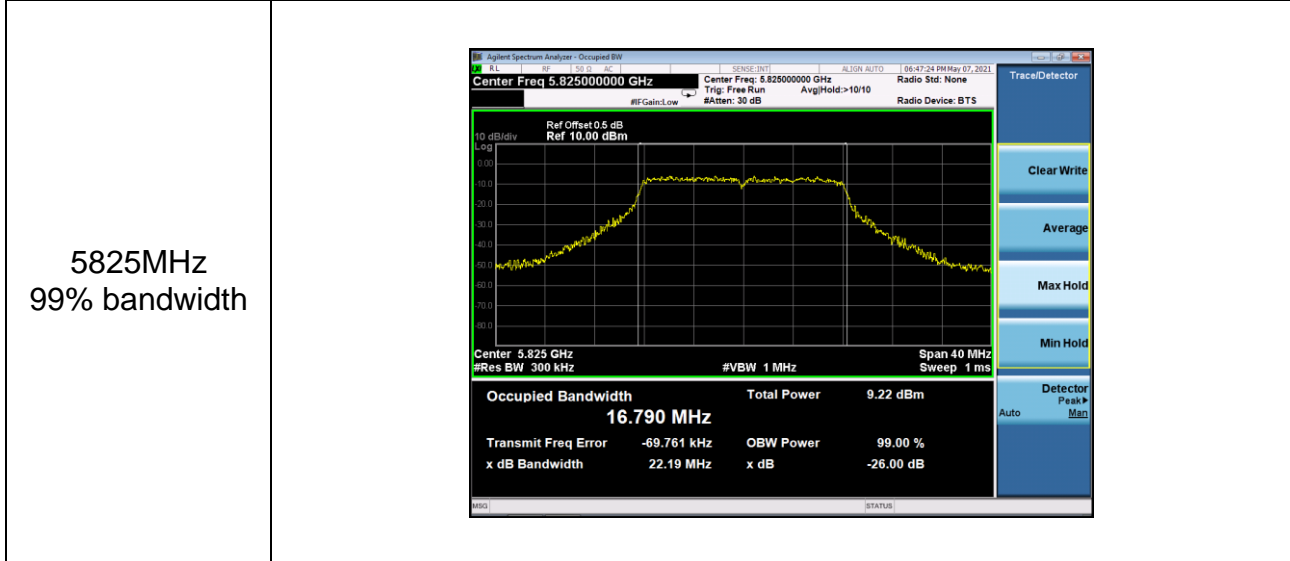

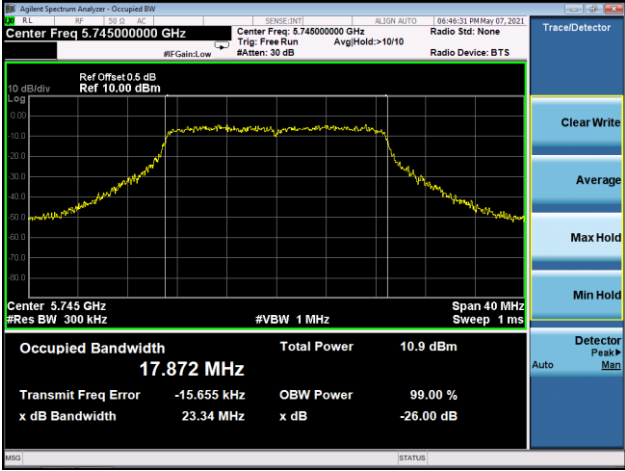
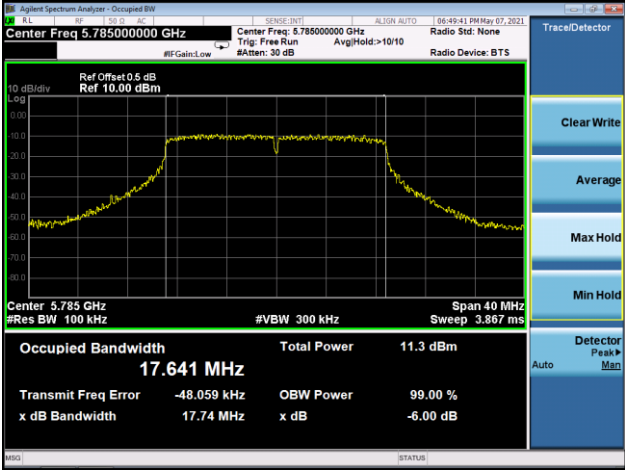
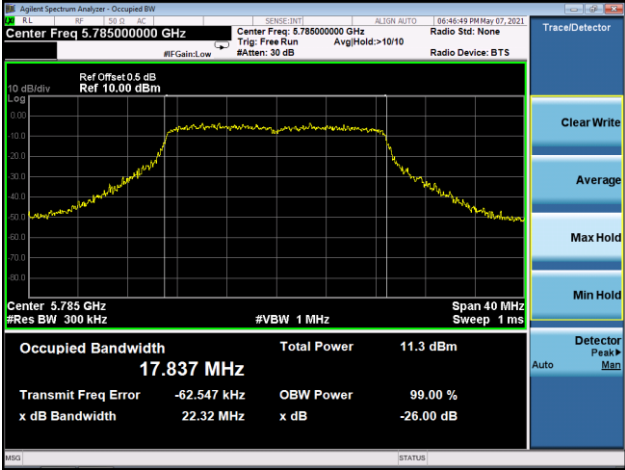
<p>5745MHz 99% bandwidth</p>	 <p>Agilent Spectrum Analyzer - Occupied BW</p> <p>Center Freq 5.745000000 GHz</p> <p>Center Freq: 5.745000000 GHz</p> <p>Trig: Free Run #Atten: 30 dB Avg/Hold: &gt;10/10</p> <p>Radio Std: None</p> <p>Radio Device: BTS</p> <p>Ref Offset 0.5 dB</p> <p>Ref 10.00 dBm</p> <p>10 dB/div</p> <p>Log</p> <p>Center 5.745 GHz</p> <p>#Res BW 300 kHz #VBW 1 MHz Span 40 MHz Sweep 1 ms</p> <table border="1"> <tr> <td>Occupied Bandwidth</td> <td>Total Power</td> <td>10.9 dBm</td> </tr> <tr> <td><b>17.872 MHz</b></td> <td></td> <td></td> </tr> <tr> <td>Transmit Freq Error</td> <td>OBW Power</td> <td>99.00 %</td> </tr> <tr> <td>-15.655 kHz</td> <td>x dB</td> <td>-26.00 dB</td> </tr> <tr> <td>x dB Bandwidth</td> <td></td> <td></td> </tr> <tr> <td>23.34 MHz</td> <td></td> <td></td> </tr> </table>	Occupied Bandwidth	Total Power	10.9 dBm	<b>17.872 MHz</b>			Transmit Freq Error	OBW Power	99.00 %	-15.655 kHz	x dB	-26.00 dB	x dB Bandwidth			23.34 MHz		
Occupied Bandwidth	Total Power	10.9 dBm																	
<b>17.872 MHz</b>																			
Transmit Freq Error	OBW Power	99.00 %																	
-15.655 kHz	x dB	-26.00 dB																	
x dB Bandwidth																			
23.34 MHz																			
<p>5785MHz 6dB bandwidth</p>	 <p>Agilent Spectrum Analyzer - Occupied BW</p> <p>Center Freq 5.785000000 GHz</p> <p>Center Freq: 5.785000000 GHz</p> <p>Trig: Free Run #Atten: 30 dB Avg/Hold: &gt;10/10</p> <p>Radio Std: None</p> <p>Radio Device: BTS</p> <p>Ref Offset 0.5 dB</p> <p>Ref 10.00 dBm</p> <p>10 dB/div</p> <p>Log</p> <p>Center 5.785 GHz</p> <p>#Res BW 100 kHz #VBW 300 kHz Span 40 MHz Sweep 3.867 ms</p> <table border="1"> <tr> <td>Occupied Bandwidth</td> <td>Total Power</td> <td>11.3 dBm</td> </tr> <tr> <td><b>17.641 MHz</b></td> <td></td> <td></td> </tr> <tr> <td>Transmit Freq Error</td> <td>OBW Power</td> <td>99.00 %</td> </tr> <tr> <td>-48.059 kHz</td> <td>x dB</td> <td>-6.00 dB</td> </tr> <tr> <td>x dB Bandwidth</td> <td></td> <td></td> </tr> <tr> <td>17.74 MHz</td> <td></td> <td></td> </tr> </table>	Occupied Bandwidth	Total Power	11.3 dBm	<b>17.641 MHz</b>			Transmit Freq Error	OBW Power	99.00 %	-48.059 kHz	x dB	-6.00 dB	x dB Bandwidth			17.74 MHz		
Occupied Bandwidth	Total Power	11.3 dBm																	
<b>17.641 MHz</b>																			
Transmit Freq Error	OBW Power	99.00 %																	
-48.059 kHz	x dB	-6.00 dB																	
x dB Bandwidth																			
17.74 MHz																			
<p>5785MHz 99% bandwidth</p>	 <p>Agilent Spectrum Analyzer - Occupied BW</p> <p>Center Freq 5.785000000 GHz</p> <p>Center Freq: 5.785000000 GHz</p> <p>Trig: Free Run #Atten: 30 dB Avg/Hold: &gt;10/10</p> <p>Radio Std: None</p> <p>Radio Device: BTS</p> <p>Ref Offset 0.5 dB</p> <p>Ref 10.00 dBm</p> <p>10 dB/div</p> <p>Log</p> <p>Center 5.785 GHz</p> <p>#Res BW 300 kHz #VBW 1 MHz Span 40 MHz Sweep 1 ms</p> <table border="1"> <tr> <td>Occupied Bandwidth</td> <td>Total Power</td> <td>11.3 dBm</td> </tr> <tr> <td><b>17.837 MHz</b></td> <td></td> <td></td> </tr> <tr> <td>Transmit Freq Error</td> <td>OBW Power</td> <td>99.00 %</td> </tr> <tr> <td>-62.547 kHz</td> <td>x dB</td> <td>-26.00 dB</td> </tr> <tr> <td>x dB Bandwidth</td> <td></td> <td></td> </tr> <tr> <td>22.32 MHz</td> <td></td> <td></td> </tr> </table>	Occupied Bandwidth	Total Power	11.3 dBm	<b>17.837 MHz</b>			Transmit Freq Error	OBW Power	99.00 %	-62.547 kHz	x dB	-26.00 dB	x dB Bandwidth			22.32 MHz		
Occupied Bandwidth	Total Power	11.3 dBm																	
<b>17.837 MHz</b>																			
Transmit Freq Error	OBW Power	99.00 %																	
-62.547 kHz	x dB	-26.00 dB																	
x dB Bandwidth																			
22.32 MHz																			

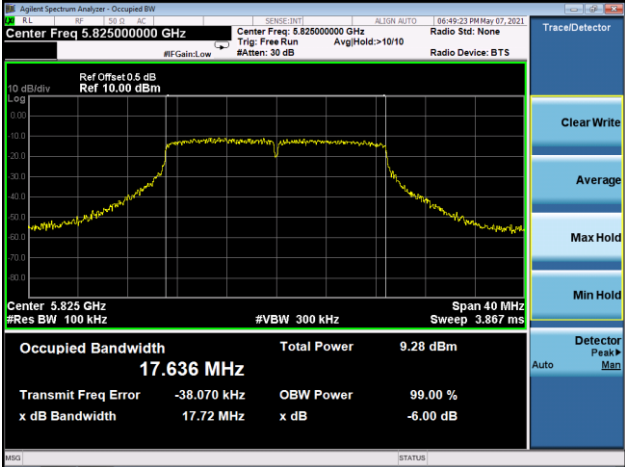
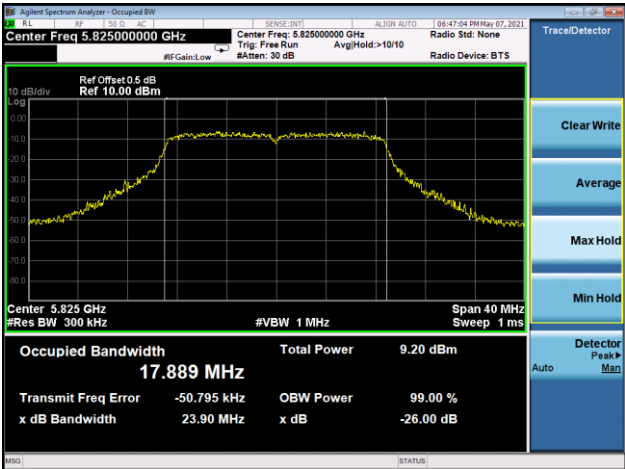
<p>5825MHz 6dB bandwidth</p>	
<p>5825MHz 99% bandwidth</p>	

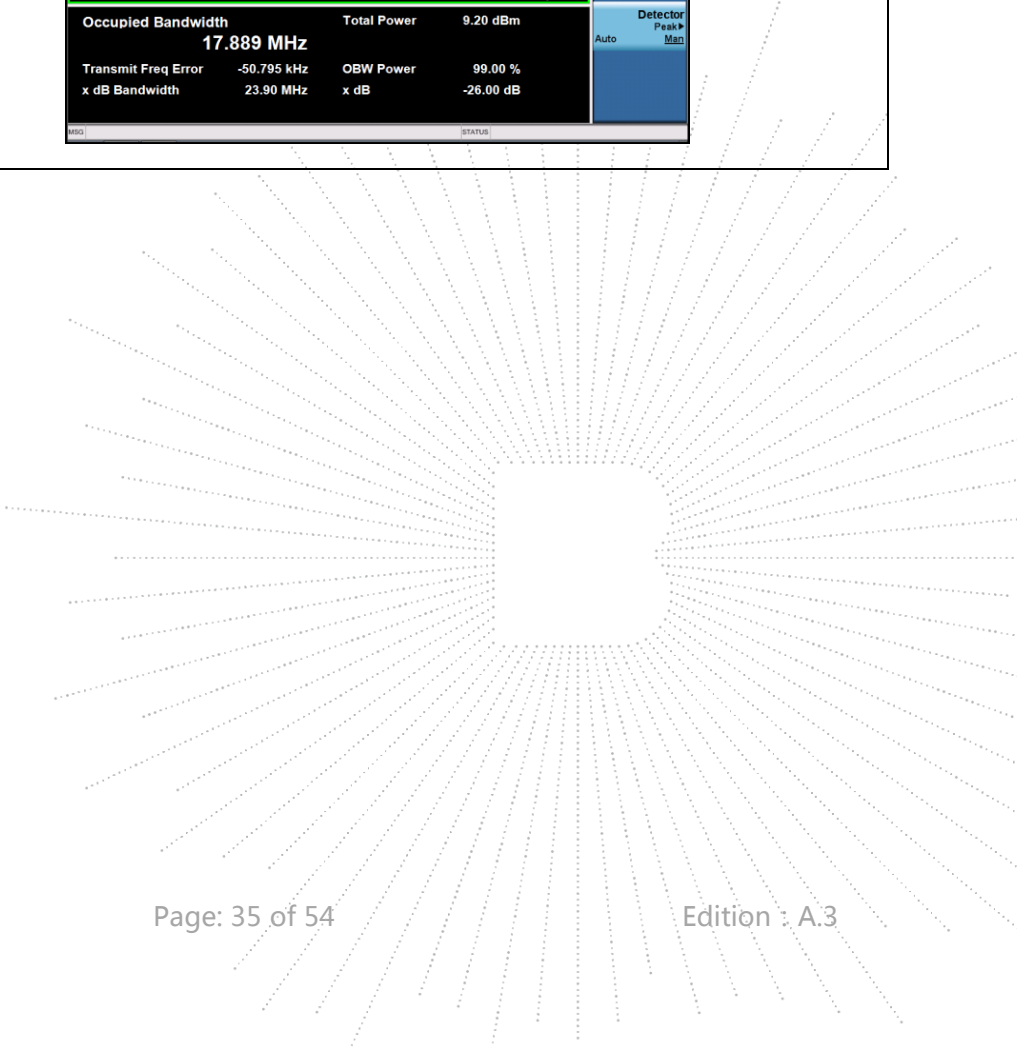

## 10. MAXIMUM CONDUCTED OUTPUT POWER

### 10.1 Block Diagram Of Test Setup



### 10.2 Limit

#### According to FCC §15.407

The maximum conducted output power should not exceed:

Frequency Band(MHz)	Limit
5725~5850	1W

### 10.3 Test procedure

Maximum conducted output power may be measured using a spectrum analyzer/EMI receiver or an RF power meter.

#### 1. Device Configuration

If possible, configure or modify the operation of the EUT so that it transmits continuously at its maximum power control level (see section II.B.).

a) The intent is to test at 100 percent duty cycle; however a small reduction in duty cycle (to no lower than 98 percent) is permitted if required by the EUT for amplitude control purposes. Manufacturers are expected to provide software to the test lab to permit such continuous operation.

b) If continuous transmission (or at least 98 percent duty cycle) cannot be achieved due to hardware limitations (e.g., overheating), the EUT shall be operated at its maximum power control level with the transmit duration as long as possible and the duty cycle as high as possible.

#### 2. Measurement using a Spectrum Analyzer or EMI Receiver (SA)

Measurement of maximum conducted output power using a spectrum analyzer requires integrating the spectrum across a frequency span that encompasses, at a minimum, either the EBW or the 99-percent occupied bandwidth of the signal.<sup>1</sup> However, the EBW must be used to determine bandwidth dependent limits on maximum conducted output power in accordance with § 15.407(a).

a) The test method shall be selected as follows: (i) Method SA-1 or SA-1 Alternative (averaging with the EUT transmitting at full power throughout each sweep) shall be applied if either of the following conditions can be satisfied:

- The EUT transmits continuously (or with a duty cycle  $\geq$  98 percent).
- Sweep triggering or gating can be implemented in a way that the device transmits at the

maximum power control level throughout the duration of each of the instrument sweeps to be averaged. This condition can generally be achieved by triggering the instrument's sweep if the duration of the sweep (with the analyzer configured as in Method SA-1, below) is equal to or shorter than the duration T of each transmission from the EUT and if those transmissions exhibit full power throughout their durations.

(ii) Method SA-2 or SA-2 Alternative (averaging across on and off times of the EUT transmissions, followed by duty cycle correction) shall be applied if the conditions of (i) cannot be achieved and the transmissions exhibit a constant duty cycle during the measurement duration. Duty cycle will be considered to be constant if variations are less than  $\pm 2$  percent.

(iii) Method SA-3 (RMS detection with max hold) or SA-3 Alternative (reduced VBW with max hold) shall be applied if the conditions of (i) and (ii) cannot be achieved.

b) Method SA-1 (trace averaging with the EUT transmitting at full power throughout each sweep): (i) Set span to encompass the entire emission bandwidth (EBW) (or, alternatively, the entire 99% occupied bandwidth) of the signal.

(ii) Set RBW = 1 MHz.

(iii) Set VBW  $\geq$  3 MHz.

(iv) Number of points in sweep  $\geq 2$  Span / RBW. (This ensures that bin-to-bin spacing is  $\leq$  RBW/2, so that narrowband signals are not lost between frequency bins.)

(v) Sweep time = auto.

(vi) Detector = RMS (i.e., power averaging), if available. Otherwise, use sample detector mode.

(vii) If transmit duty cycle  $<$  98 percent, use a video trigger with the trigger level set to enable triggering only on full power pulses. Transmitter must operate at maximum power control level for the entire duration of every sweep. If the EUT transmits continuously (i.e., with no off intervals) or at duty cycle  $\geq$  98 percent, and if each transmission is entirely at the maximum power control level, then the trigger shall be set to "free run".

(viii) Trace average at least 100 traces in power averaging (i.e., RMS) mode.

(ix) Compute power by integrating the spectrum across the EBW (or, alternatively, the entire 99% occupied bandwidth) of the signal using the instrument's band power measurement function with band limits set equal to the EBW (or occupied bandwidth) band edges. If the instrument does not have a band power function, sum the spectrum

## 10.4 EUT operating Conditions

The EUT was configured for testing in a typical fashion (as a customer would normally use it). The EUT has been programmed to continuously transmit during test. This operating condition was tested and used to collect the included data.

## 10.5 Test Result

Temperature :	26 °C	Relative Humidity :	54%
Pressure :	101kPa	Test Voltage :	DC 14.5V from Battery
Test Mode :	TX (5.8G) Mode Frequency U-NII-3 (5745-5825MHz)		

Test Channel	Frequency	Maximum output power. Antenna port (AV)			LIMIT	Result
	(MHz)	ANT A(dBm)	ANT B(dBm)	Total(dBm)	dBm	
<b>TX 802.11a Mode</b>						
CH 149	5745	8.533	10.626	/	30	Pass
CH 157	5785	9.720	9.520	/	30	Pass
CH 165	5825	6.968	8.289	/	30	Pass
<b>TX 802.11 n20M Mode</b>						
CH 149	5745	8.531	9.081	11.825	30	Pass
CH 157	5785	8.692	8.645	11.679	30	Pass
CH 165	5825	6.692	7.335	10.036	30	Pass

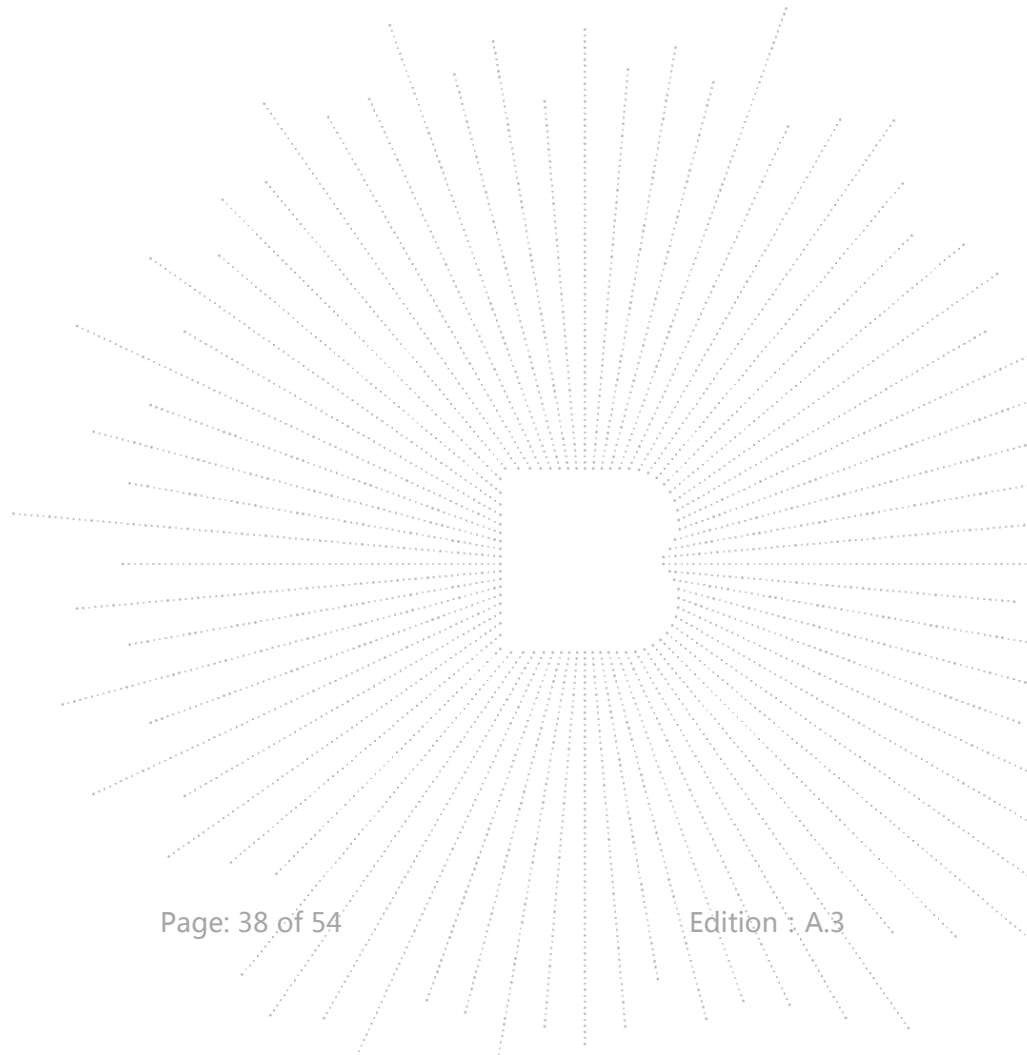

## 11. OUT OF BAND EMISSIONS

### 11.1 Block Diagram Of Test Setup



### 11.2 Limit

According to FCC §15.407(b)

Undesirable emission limits. Except as shown in paragraph (b)(7) of this section, the maximum emissions outside of the frequency bands of operation shall be attenuated in accordance with the following limits:

(1) For transmitters operating in the 5.15-5.25 GHz band: All emissions outside of the 5.15-5.35 GHz band shall not exceed an e.i.r.p. of  $-27$  dBm/MHz.

(2) All emissions shall be limited to a level of  $-27$  dBm/MHz at 75 MHz or more above or below the band edge increasing linearly to 10 dBm/MHz at 25 MHz above or below the band edge, and from 25 MHz above or below the band edge increasing linearly to a level of 15.6 dBm/MHz at 5 MHz above or below the band edge, and from 5 MHz above or below the band edge increasing linearly to a level of 27 dBm/MHz at the band edge.

### 11.3 Test procedure

1. Check the calibration of the measuring instrument using either an internal calibrator or a known signal from an external generator.
2. Position the EUT without connection to measurement instrument. Turn on the EUT and connect its antenna terminal to measurement instrument via a low loss cable. Then set it to any one measured frequency within its operating range, and make sure the instrument is operated in its linear range.
3. Set RBW of spectrum analyzer to 1 MHz with a convenient frequency span.
4. Measure the highest amplitude appearing on spectral display and set it as a reference level. Plot the graph with marking the highest point and edge frequency.
5. Repeat above procedures until all measured frequencies were complete.

### 11.4 EUT operating Conditions

The EUT was configured for testing in a typical fashion (as a customer would normally use it). The EUT has been programmed to continuously transmit during test. This operating condition was tested and used to collect the included data

## 11.5 Test Result

Temperature :	26 °C	Relative Humidity :	54%
Pressure :	101kPa	Test Voltage :	DC 14.5V from Battery

Note: A(B) Represent the value of antenna A and B, The worst data is Antenna A ,only shown Antenna A. Plot.Antenna A: 5745-5825 MHz

5.8G

5.745~5.825 GHz

(802.11a) Band Edge, Left Side

(802.11n20) Band Edge, Left Side

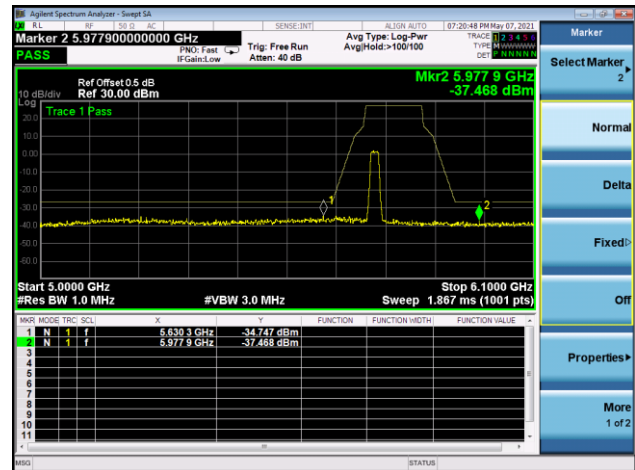
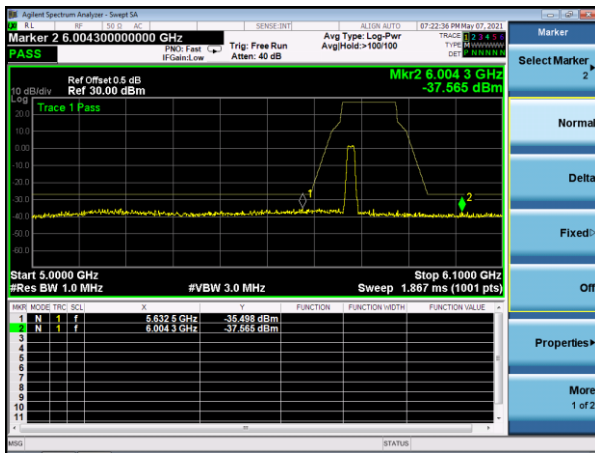

(802.11a) Band Edge, Right Side

(802.11n20) Band Edge, Right Side

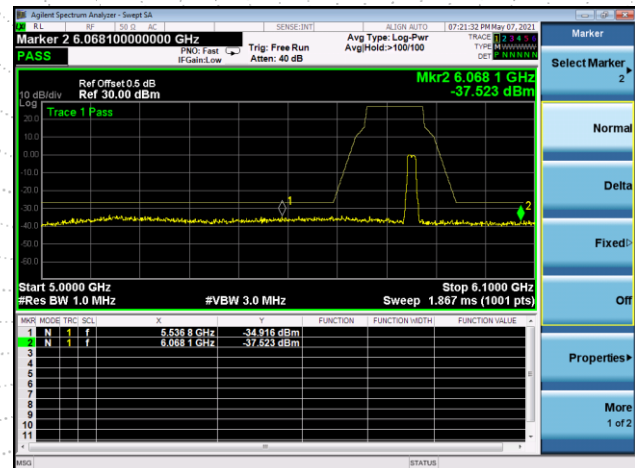
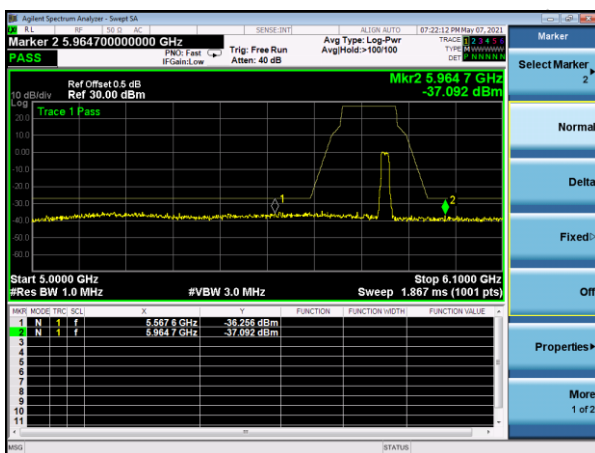



## 12. SPURIOUS RF CONDUCTED EMISSIONS

### 12.1 Block Diagram Of Test Setup



### 12.2 Limit

Undesirable emission limits. Except as shown in paragraph (b)(7) of this section, the maximum emissions outside of the frequency bands of operation shall be attenuated in accordance with the following limits:

(1) For transmitters operating in the 5.15-5.25 GHz band: All emissions outside of the 5.15-5.35 GHz band shall not exceed an e.i.r.p. of  $-27$  dBm/MHz.

(2) For transmitters operating in the 5.725-5.85 GHz band(i) All emissions shall be limited to a level of  $-27$  dBm/MHz at 75 MHz or more above or below the band edge increasing linearly to 10 dBm/MHz at 25 MHz above or below the band edge, and from 25 MHz above or below the band edge increasing linearly to a level of 15.6 dBm/MHz at 5 MHz above or below the band edge, and from 5 MHz above or below the band edge increasing linearly to a level of 27 dBm/MHz at the band edge..

### 12.3 Test procedure

1. Check the calibration of the measuring instrument using either an internal calibrator or a known signal from an external generator.
2. Position the EUT without connection to measurement instrument. Turn on the EUT and connect its antenna terminal to measurement instrument via a low loss cable. Then set it to any one measured frequency within its operating range, and make sure the instrument is operated in its linear range.
3. Set RBW of spectrum analyzer to 1 MHz with a convenient frequency span.
4. Measure the highest amplitude appearing on spectral display and set it as a reference level. Plot the graph with marking the highest point and edge frequency.
5. Repeat above procedures until all measured frequencies were complete.

## 12.4 Test Result

Remark: The measurement frequency range is from 9KHz to the 10th harmonic of the fundamental frequency. The lowest, middle and highest channels are tested to verify the spurious emissions and bandedge measurement data.

About:26.5GHz-40GHz, The amplitude of spurious emissions which are attenuated by more than 20dB below the permissible value has no need to be reported.

Note: A(B) Represent the value of antenna A and B, The worst data is Antenna A ,only shown Antenna A Plot.

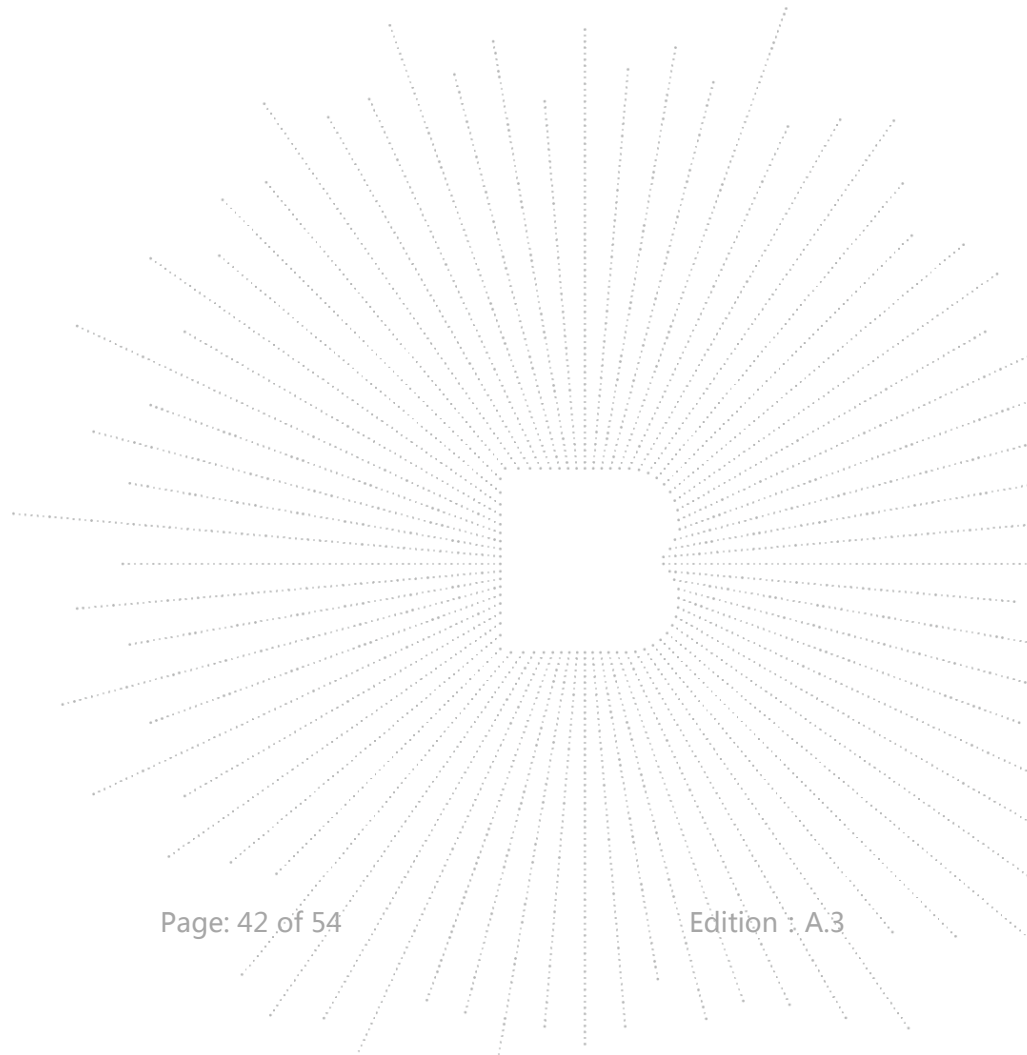

## 5.8G Test Plot

802.11a on channel 149

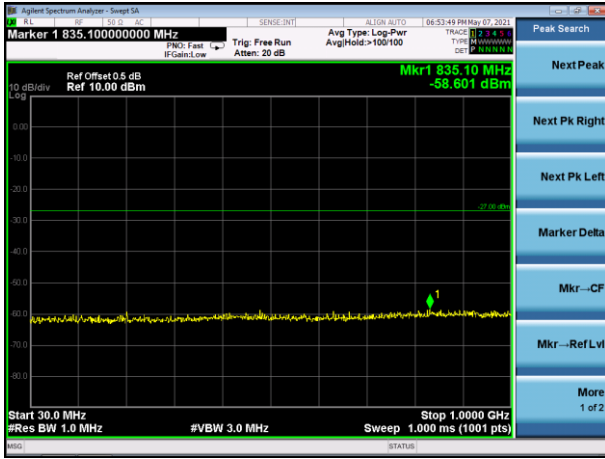

802.11a on channel 157

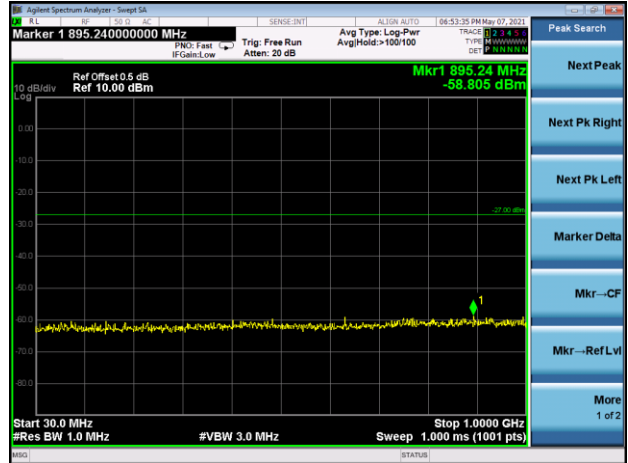

802.11a on channel 149



802.11a on channel 157

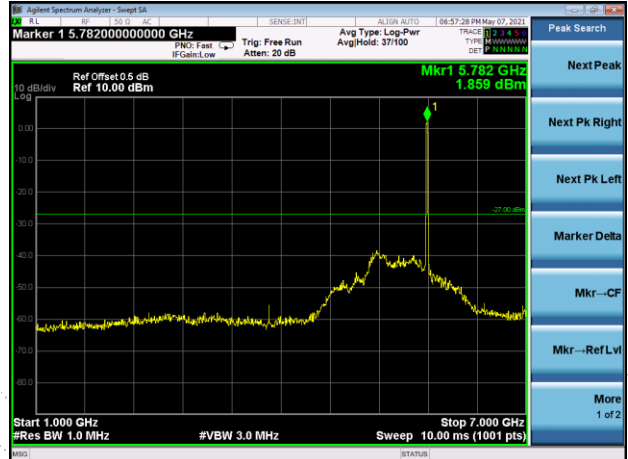

802.11a on channel 149



802.11a on channel 157



**Test Plot**

802.11a on channel 165

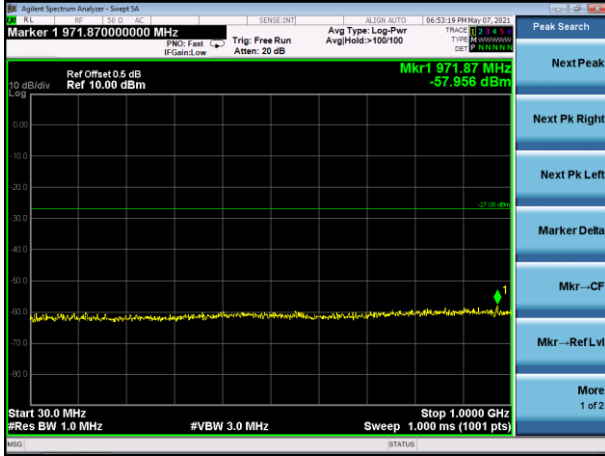

802.11n20 on channel 149

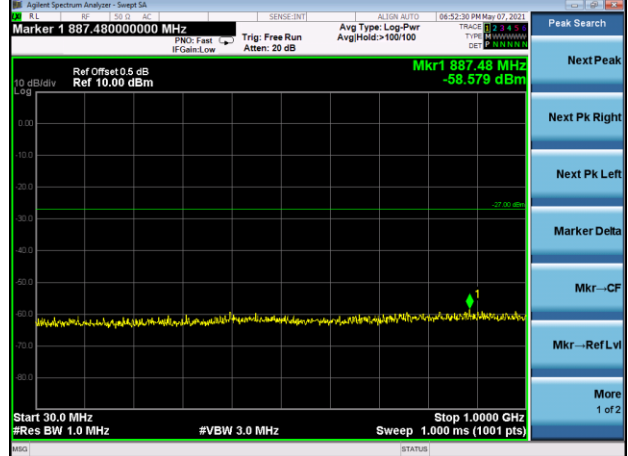

802.11a on channel 165



802.11n20 on channel 149



802.11a on channel 165



802.11n20 on channel 149



**Test Plot**

802.11n20 on channel 157

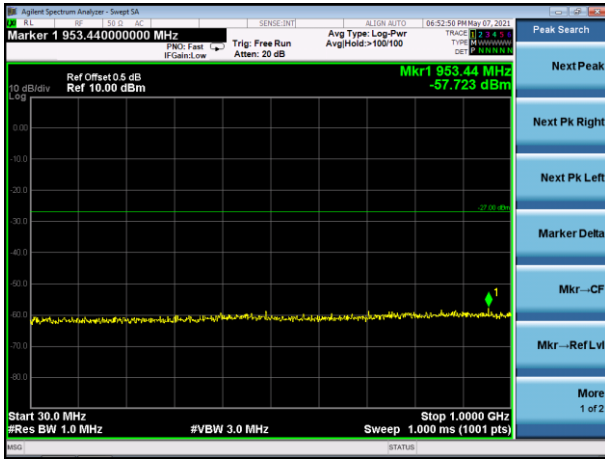

802.11n20 on channel 165

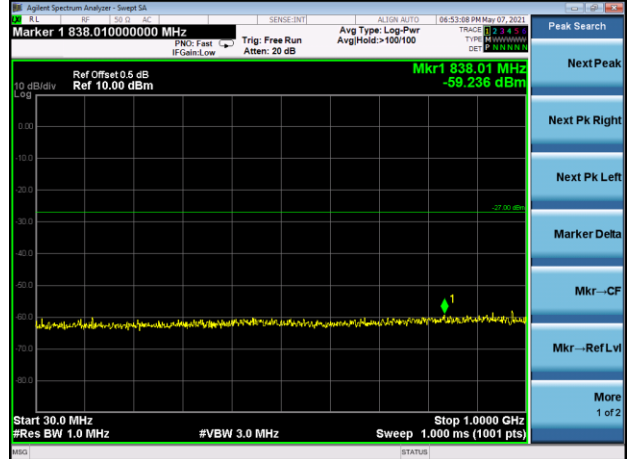

802.11n20 on channel 157

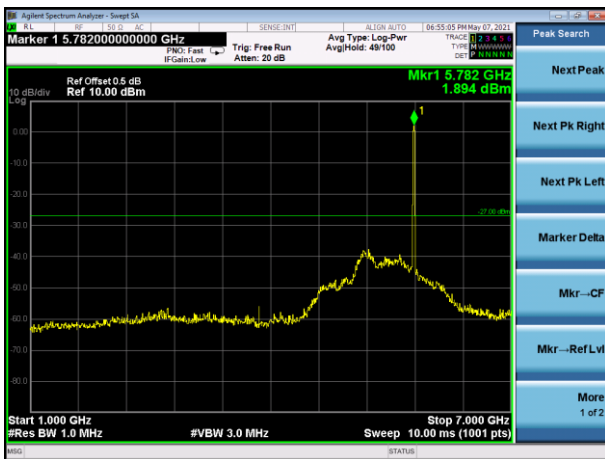

802.11n20 on channel 165



802.11n20 on channel 157



802.11n20 on channel 165



## 13. FREQUENCY STABILITY MEASUREMENT

### 13.1 Block Diagram Of Test Setup



### 13.2 Limit

Manufactures of U-NII devices are responsible for ensuring frequency stability such that an emission is maintained within the band of operation under all conditions of normal operation as specified in the user's manual.

The transmitter center frequency tolerance shall be  $\pm 20$  ppm maximum for the 5 GHz band (IEEE 802.11n specification)..

### 13.3 Test procedure

1. The transmitter output (antenna port) was connected to the spectrum analyzer.
2. EUT have transmitted absence of modulation signal and fixed channelize.
3. Set the spectrum analyzer span to view the entire absence of modulation emissions bandwidth.
4. Set RBW = 10 kHz, VBW = 10 kHz with peak detector and maxhold settings.
5.  $f_c$  is declaring of channel frequency. Then the frequency error formula is  $(f_c - f) / f_c \times 10^6$  ppm and he limit is less than  $\pm 20$  ppm (IEEE 802.11n specification).
6. The test extreme voltage is to change the primary supply voltage from 85 to 115 percent of the nominal value
7. Extreme temperature is  $-20^\circ\text{C} \sim 70^\circ\text{C}$ .

### 13.4 Test Result

Temperature :	26 °C	Relative Humidity :	54%
Pressure :	101kPa	Test Voltage :	DC 14.5V from Battery
Hzst Mode :	TX Frequency(5745-5825MHz)		

#### Voltage vs. Frequency Stabilit

TEST CONDITIONS				Reference Frequency: 5745MHz			
				f	fc	Max. Deviation (MHz)	Max. Deviation (ppm)
T nom (°C)	20	V nom (V)	12.00	5745.00068	5745	0.00068	0.1179
		V max (V)	13.80	5745.00509	5745	0.00509	0.8853
		V min (V)	10.20	5745.01010	5745	0.01010	1.7578
Limits				5725-5850 MHz			
Result				Complies			

#### Temperature vs. Frequency Stability

TEST CONDITIONS				Reference Frequency: 5745MHz			
				f	fc	Max. Deviation (MHz)	Max. Deviation (ppm)
V nom (V)	120	T (°C)	-20	5745.00776	5745	0.00776	1.3500
		T (°C)	-10	5745.01195	5745	0.01195	2.0803
		T (°C)	0	5745.00721	5745	0.00721	1.2548
		T (°C)	10	5745.01196	5745	0.01196	2.0819
		T (°C)	20	5745.00690	5745	0.00690	1.2017
		T (°C)	30	5745.01311	5745	0.01311	2.2822
		T (°C)	40	5745.00830	5745	0.00830	1.4445
		T (°C)	50	5745.01186	5745	0.01186	2.0642
		T (°C)	60	5745.00162	5745	0.00162	0.2824
		T (°C)	70	5745.00562	5745	0.00562	0.9780
Limits				5725-5850 MHz			
Result				Complies			

**Voltage vs. Frequency Stability**

TEST CONDITIONS				Reference Frequency: 5785MHz			
				f	fc	Max. Deviation (MHz)	Max. Deviation (ppm)
T nom (°C)	20	V nom (V)	12.00	5785.00755	5785	0.00755	1.3051
		V max (V)	13.80	5785.00002	5785	0.00002	0.0037
		V min (V)	10.20	5785.01297	5785	0.01297	2.2422
Limits				5725-5850 MHz			
Result				Complies			

**Temperature vs. Frequency Stability**

TEST CONDITIONS				Reference Frequency: 5785MHz			
				f	fc	Max. Deviation (MHz)	Max. Deviation (ppm)
V nom (V)	120	T (°C)	-20	5785.00340	5785	0.00340	0.5872
		T (°C)	-10	5785.00732	5785	0.00732	1.2648
		T (°C)	0	5785.00850	5785	0.00850	1.4701
		T (°C)	10	5785.00607	5785	0.00607	1.0493
		T (°C)	20	5785.01232	5785	0.01232	2.1292
		T (°C)	30	5785.00616	5785	0.00616	1.0653
		T (°C)	40	5785.00512	5785	0.00512	0.8844
		T (°C)	50	5785.00079	5785	0.00079	0.1360
		T (°C)	60	5785.00566	5785	0.00566	0.9778
		T (°C)	70	5785.00416	5785	0.00416	0.7191
Limits				5725-5850 MHz			
Result				Complies			

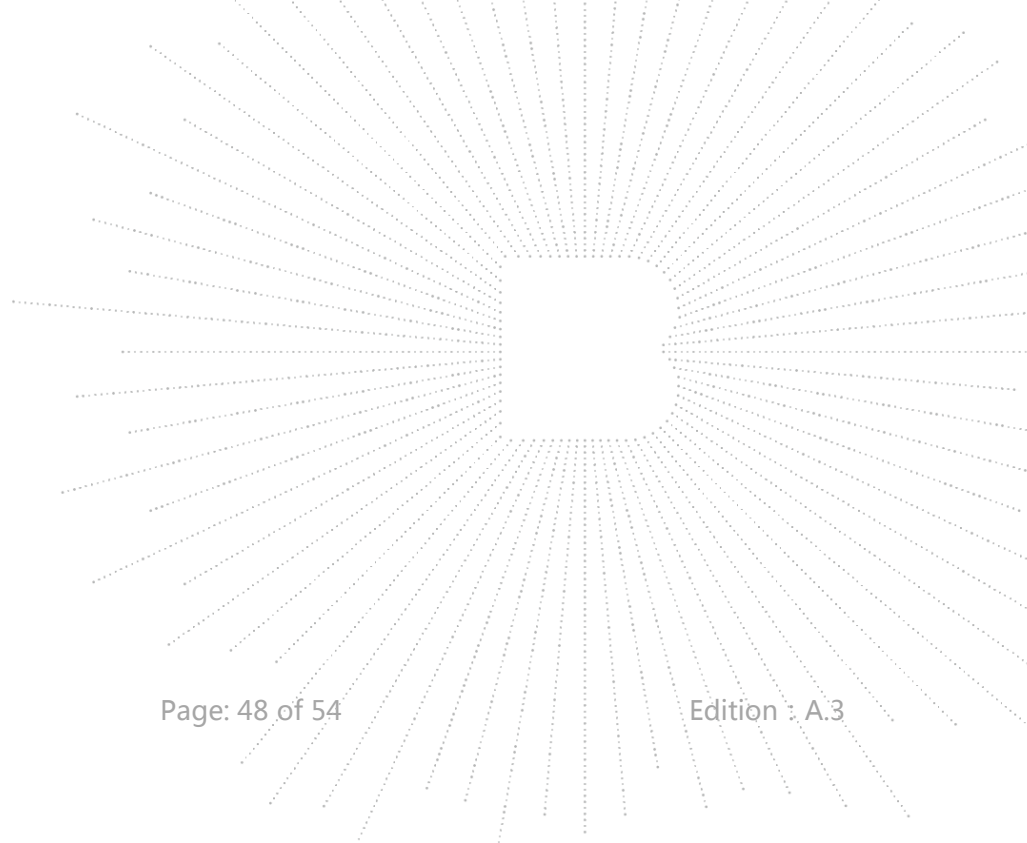



**Voltage vs. Frequency Stability**

TEST CONDITIONS				Reference Frequency: 5825MHz			
				f	fc	Max. Deviation (MHz)	Max. Deviation (ppm)
T nom (°C)	20	V nom (V)	12.00	5825.00810	5825	0.00810	1.3900
		V max (V)	13.80	5825.01104	5825	0.01104	1.8957
		V min (V)	10.20	5825.00131	5825	0.00131	0.2244
Limits				5725-5850 MHz			
Result				Complies			

**Temperature vs. Frequency Stability**

TEST CONDITIONS				Reference Frequency: 5825MHz			
				f	fc	Max. Deviation (MHz)	Max. Deviation (ppm)
V nom (V)	120	T (°C)	-20	5825.01308	5825	0.01308	2.2449
		T (°C)	-10	5825.01312	5825	0.01312	2.2530
		T (°C)	0	5825.01070	5825	0.01070	1.8376
		T (°C)	10	5825.00600	5825	0.00600	1.0301
		T (°C)	20	5825.01181	5825	0.01181	2.0269
		T (°C)	30	5825.01238	5825	0.01238	2.1247
		T (°C)	40	5825.00786	5825	0.00786	1.3487
		T (°C)	50	5825.01150	5825	0.01150	1.9742
		T (°C)	60	5825.01112	5825	0.01112	1.9082
		T (°C)	70	5825.01339	5825	0.01339	2.2981
Limits				5725-5850 MHz			
Result				Complies			

## 14. ANTENNA REQUIREMENT

### 14.1 Limit

15.203 requirement: For intentional device, according to 15.203: an intentional radiator shall be designed to ensure that no antenna other than that furnished by the responsible party shall be used with the device.

### 14.2 Test Result

The EUT antenna is Internal antenna (antenna gain (A): 1dBi; antenna gain (B) : 1dBi). It comply with the standard requirement.



# 15. EUT PHOTOGRAPHS

**EUT Photo 1**



**EUT Photo 2**



## 16. EUT TEST SETUP PHOTOGRAPHS

Radiated Measurement Photos



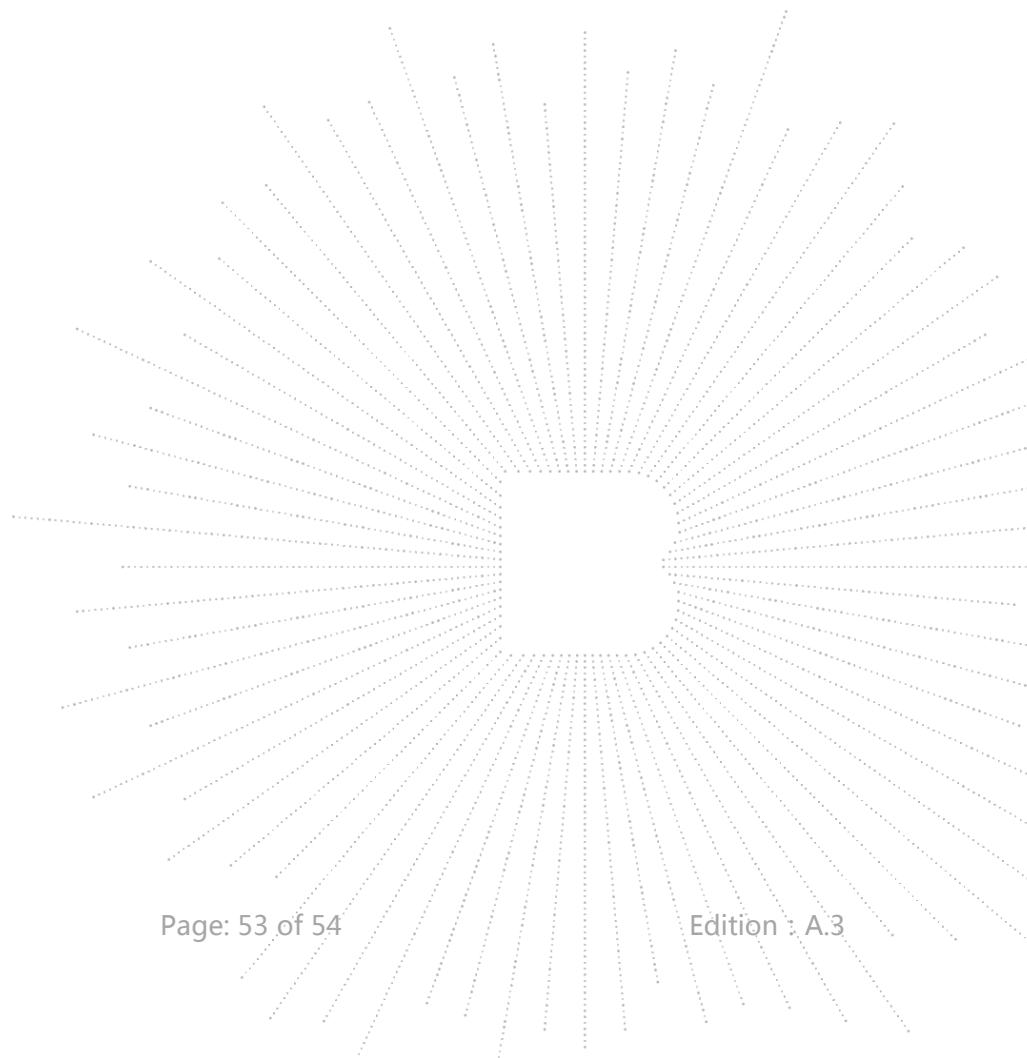

## STATEMENT

- 1.The equipment lists are traceable to the national reference standards.
- 2.The test report can not be partially copied unless prior written approval is issued from our lab.
- 3.The test report is invalid without stamp of laboratory.
- 4.The test report is invalid without signature of person(s) testing and authorizing.
- 5.The test process and test result is only related to the Unit Under Test.
- 6.The quality system of our laboratory is in accordance with ISO/IEC17025.
- 7.If there is any objection to report, the client should inform issuing laboratory within 15 days from the date of receiving test report.

Address:

1-2/F., Building B, Pengzhou Industrial Park, No.158, Fuyuan 1st Road, Tangwei, Fuhai Subdistrict, Bao'an District, Shenzhen, Guangdong, China

TEL : 400-788-9558

P.C.: 518103

FAX : 0755-33229357

Website : <http://www.chnbctc.com>

E-Mail : [bctc@bctc-lab.com.cn](mailto:bctc@bctc-lab.com.cn)

\*\*\*\*\* END \*\*\*\*\*