



# FCC CFR 47 Part 90 Test Report

<b>APPLICANT</b>	FLORIDA, STATE OF
<b>ADDRESS</b>	DEPARTMENT OF TRANSPORTATION 605 SUWANNEE St MS 90 TALLAHASSEE FLORIDA 32399-0450 USA
<b>FCC ID</b>	2ALYPDR-06T
<b>MODEL NUMBER</b>	DR-06T
<b>PRODUCT DESCRIPTION</b>	VHF MOBILE TRANSCEIVER
<b>DATE SAMPLE RECEIVED</b>	05/17/2017
<b>FINAL TEST DATE</b>	04/23/2019
<b>TESTED BY</b>	Franklin Rose
<b>APPROVED BY</b>	Tim Royer
<b>TEST RESULTS</b>	<input checked="" type="checkbox"/> PASS <input type="checkbox"/> FAIL

Report Number	Report Version	Description	Issue Date
858AUT19_TestReport_	Rev1	Initial Issue	05/02/2019
858AUT19_TestReport_	Rev2	Clerical Updates	08/13/2019
858AUT19_TestReport_	Rev3	Updated High Power	09/13/2019

**THE ATTACHED REPORT SHALL NOT BE REPRODUCED EXCEPT IN FULL WITHOUT THE WRITTEN APPROVAL OF TIMCO ENGINEERING, INC.**

## TABLE OF CONTENTS

<b>GENERAL REMARKS</b> .....	<b>2</b>
<b>GENERAL INFORMATION</b> .....	<b>3</b>
<b>RESULTS SUMMARY</b> .....	<b>4</b>
<b>RF POWER OUTPUT</b> .....	<b>5</b>
TEST DATA: POWER MEASUREMENT TABLE .....	5
PART 2.1033 (c)(8) DC INPUT INTO FINAL AMPLIFIER.....	5
<b>MODULATION CHARACTERISTICS</b> .....	<b>6</b>
<b>AUDIO FREQUENCY RESPONSE</b> .....	<b>7</b>
<i>Test Data: Wideband - Audio Frequency Response</i> .....	7
<b>LOW PASS FILTER RESPONSE</b> .....	<b>8</b>
<i>Test Data: Wideband - Low Pass Filter Response</i> .....	8
<b>MODULATION LIMITING</b> .....	<b>9</b>
<i>Test Data: Wideband - Modulation Limiting</i> .....	9
<b>OCCUPIED BANDWIDTH &amp; EMISSION MASK</b> .....	<b>10</b>
TEST DATA: 44.96 MHZ, LOW POWER, WIDEBAND.....	11
TEST DATA: 44.96 MHZ, HIGH POWER, WIDEBAND.....	12
TEST DATA: 47.62 MHZ, LOW POWER, WIDEBAND.....	13
TEST DATA: 47.62 MHZ, HIGH POWER, WIDEBAND.....	14
<b>SPURIOUS EMISSIONS AT ANTENNA TERMINALS (CONDUCTED)</b> .....	<b>15</b>
SPURIOUS EMISSIONS – ANTENNA FACTORS .....	16
SPURIOUS EMISSIONS – LOW END OF BAND .....	17
44.96 MHZ, LOW POWER, WIDEBAND .....	17
44.96 MHZ, HIGH POWER, WIDEBAND .....	17
SPURIOUS EMISSIONS – HIGH END OF BAND .....	18
47.62 MHZ, LOW POWER, WIDEBAND .....	18
47.62 MHZ, HIGH POWER, WIDEBAND .....	18
<b>FIELD STRENGTH OF SPURIOUS EMISSIONS</b> .....	<b>19</b>
TEST DATA: 44.96 MHZ, WIDEBAND, HIGH POWER.....	20
TEST DATA: 47.62 MHZ, WIDEBAND, HIGH POWER.....	20
<b>FREQUENCY STABILITY</b> .....	<b>21</b>
TEST DATA: FREQUENCY ERROR MEASUREMENT TABLE.....	21
TEST DATA: FREQUENCY ERROR MEASUREMENT PLOT .....	22
<b>STATEMENT OF MEASUREMENT UNCERTAINTY</b> .....	<b>23</b>
<b>EMC EQUIPMENT LIST</b> .....	<b>24</b>

## GENERAL REMARKS

### Summary

The device under test does:

- Fulfill the general approval requirements as identified in this test report and was selected by the customer.
- Not fulfill the general approval requirements as identified in this test report

### Attestations

This equipment has been tested in accordance with the standards identified in this test report. To the best of my knowledge and belief, these tests were performed using the measurement procedures described in this report.

All instrumentation and accessories used to test products for compliance to the indicated standards are calibrated regularly in accordance with ISO 17025 requirements.

I attest that the necessary measurements were made at:

**Timco Engineering Inc.**  
**849 NW State Road 45**  
**Newberry, FL 32669**  
**Designation #: US1070**

### Tested by:



**Name and Title** Franklin Rose, Project Manager / EMC Specialist

**Date** 04/24/2019

### Reviewed and Approved by:



**Name and Title** Tim Royer, Project Manager / EMC Testing Engineer

**Date** 05/02/2019

## GENERAL INFORMATION

<b>EUT Description</b>	VHF MOBILE TRANSCEIVER
<b>FCC ID</b>	2ALYPDR-06T
<b>Model Number</b>	DR-06T
<b>Operating Frequency Band</b>	44.95-47.63 MHz
<b>Test Frequencies</b>	44.96, 47.62 MHz
<b>Type of Emission</b>	16KOF3E (Wideband Analog FM Voice)
<b>Modulation</b>	FM
<b>EUT Power Source</b>	<input type="checkbox"/> 110–120Vac/50– 60Hz
	<input checked="" type="checkbox"/> DC Power (13.8 V)
	<input type="checkbox"/> Battery Operated Exclusively
<b>Test Item</b>	<input type="checkbox"/> Prototype
	<input type="checkbox"/> Pre-Production
	<input checked="" type="checkbox"/> Production
<b>Type of Equipment</b>	<input type="checkbox"/> Fixed
	<input checked="" type="checkbox"/> Mobile
	<input type="checkbox"/> Portable
<b>Antenna Connector</b>	UHF Connector
<b>Test Conditions</b>	The temperature was 26°C Relative humidity of 50%.
<b>Modification to the EUT</b>	An audio input BNC connector was installed in the microphone of the EUT.
<b>Test Exercise</b>	The EUT was operated normally
<b>Applicable Standards</b>	ANSI/TIA 603-E:2016, ANSI C63.26, FCC CFR 47 Part 2, Part 90
<b>Test Facility</b>	Timco Engineering Inc. at 849 NW State Road 45 Newberry, FL 32669 USA. Designation #: US1070

## RESULTS SUMMARY

Rule Part	Test Item	Results
2.1046(a), 90.205(b)	RF Power Output	<b>PASS</b>
2.1033(c)(4), 90.207(c), 90.209(a), (b)	Modulation Characteristics	<b>PASS</b>
2.1047(a)	Audio Frequency Response and Low Pass Filter Response	<b>PASS</b>
2.1047(b)	Modulation Limiting	<b>PASS</b>
2.1049 (c), 90.210(b)	Occupied Bandwidth & Emission Masks	<b>PASS</b>
2.1051(a), 90.210(b)(3)	Spurious Emissions at Antenna Terminals	<b>PASS<sup>1</sup></b>
2.1053(a), 90.210(b)(3)	Field Strength of Spurious Emissions	<b>PASS</b>
2.1055(a)(2), 90.213	Frequency Stability < 20 ppm	<b>PASS<sup>2</sup></b>

1. Spurious Emissions at the Antenna Terminals has, using written guidance from the FCC, been shown to pass using a specific whip antenna which is to be installed with each device.
2. Frequency Stability data shows the device ceases below 10° C. Using guidance from the FCC, the EUT has been determined to pass the requirement since while transmitting, frequency drift was not in excess of the allowed limit.

## RF POWER OUTPUT

**Rule Part:** FCC Part 2.1046(a), 90.205(b)

(b) 25-50 MHz. The maximum transmitter output power is 300 watts.

**Method of Measurement:** TIA-603-E, 2.2.1

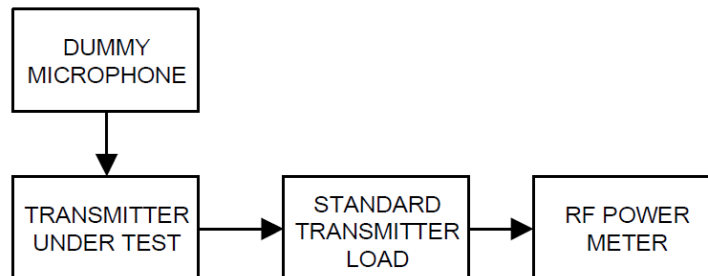

**Test Data: Power Measurement Table**

Tuned Frequency (MHz)	Power Mode	Measurement (dBm)	Antenna Gain (dB)	Antenna Loss (dB)	ERP (dBm)	Power Output (W)
44.96	Low	29.29	0.00	0.59	28.70	0.74
44.96	High	47.30	0.00	0.59	46.71	46.91
47.62	Low	29.83	0.63	0.00	30.46	1.11
47.62	High	46.37	0.63	0.00	47.00	50.08

Updated 09/15/2019

**Note:** The EUT is to be installed with a specific transmit antenna (monopole whip antenna), designed to mitigate harmonic emissions. The gains & losses were measured, and used to ascertain the Effective Radiated Power Output (dBm) of the EUT. For more details, please see Spurious Emissions at the Antenna Terminal (Conducted) for antenna testing data.

### Part 2.1033 (c)(8) DC Input into Final Amplifier

INPUT POWER: (13.8 V) (10.0 A) = **138.0 Watts**

## MODULATION CHARACTERISTICS

**Rule Part:** Part 2.1033(c)(4), 90.207(c), 90.209(a), (b)

### §90.207 Types of emissions.

(c) The use of F3E or G3E emission in these services will be authorized only on frequencies above 25 MHz.

### §90.209 Bandwidth limitations.

(a) Each authorization issued to a station licensed under this part will show an emission designator representing the class of emission authorized. The designator will be prefixed by a specified necessary bandwidth. This number does not necessarily indicate the bandwidth occupied by the emission at any instant. In those cases where §2.202 of this chapter does not provide a formula for the computation of necessary bandwidth, the occupied bandwidth, as defined in part 2 of this chapter, may be used in lieu of the necessary bandwidth.

(b) The maximum authorized single channel bandwidth of emission corresponding to the type of emission specified in §90.207 is as follows:

#### STANDARD CHANNEL SPACING/BANDWIDTH

Frequency band (MHz)	Channel spacing (kHz)	Authorized bandwidth (kHz)
25-50	20	20

Emission Designator	Description	Modulation Type	M (modulation Freq., kHz)	R (rate, baud)	D (deviation, kHz)	K (numeric constant)	S (symbols)	Bandwidth Calculation	Necessary Bandwidth
16K0F3E	Wideband Analog FM Voice	FM	3.0	-	5.0	1.0	-		16.00

## AUDIO FREQUENCY RESPONSE

Rule Part: 2.1047(a)

### Requirements:

(a) *Voice modulated communication equipment.* A curve or equivalent data showing the frequency response of the audio modulating circuit over a range of 100 to 5000 Hz shall be submitted. For equipment required to have an audio low-pass filter, a curve showing the frequency response of the filter, or of all circuitry installed between the modulation limiter and the modulated stage shall be submitted.

Test Procedure: TIA 603-E, 2.2.6

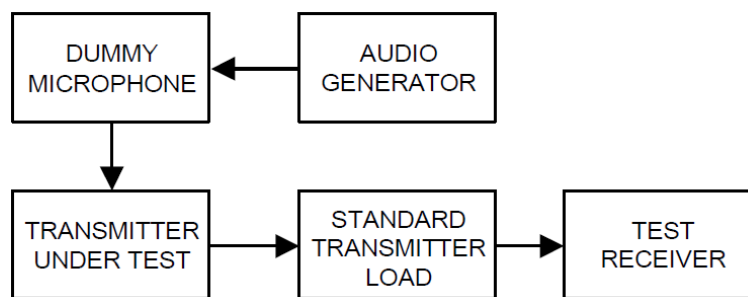

### Test Data: Wideband - Audio Frequency Response

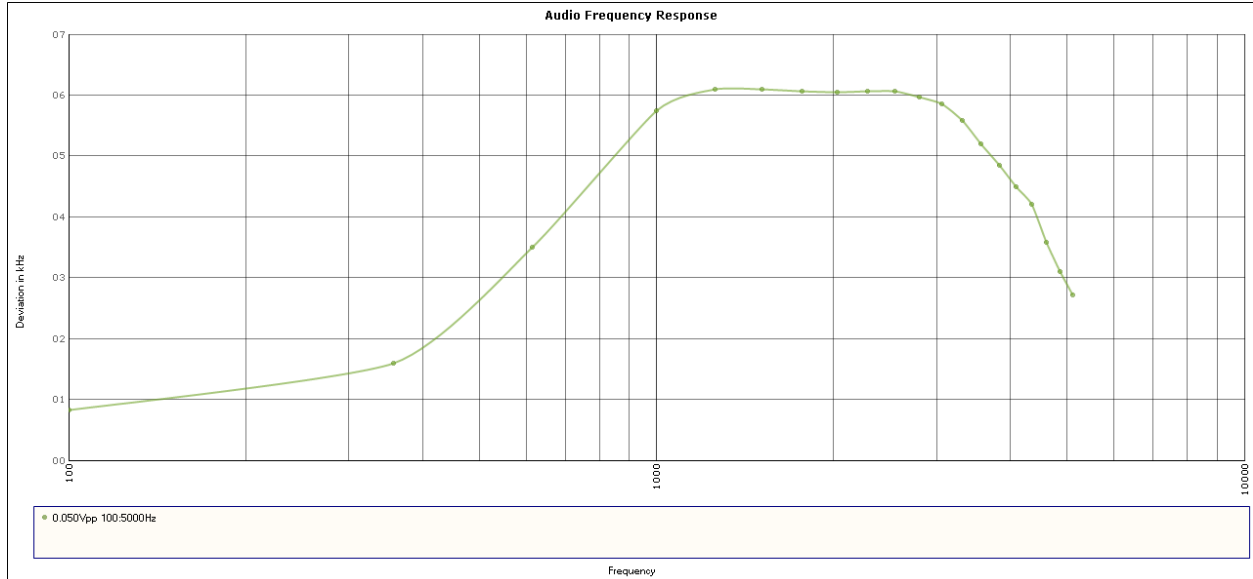



## LOW PASS FILTER RESPONSE

**Rule Part:** 2.1047(a)

### Requirements:

(a) *Voice modulated communication equipment.* A curve or equivalent data showing the frequency response of the audio modulating circuit over a range of 100 to 5000 Hz shall be submitted. For equipment required to have an audio low-pass filter, a curve showing the frequency response of the filter, or of all circuitry installed between the modulation limiter and the modulated stage shall be submitted.

**Test Procedure:** TIA 603-E, 2.2.6.2.2, 2.2.15 (Using the Test Setup from section 2.2.6).

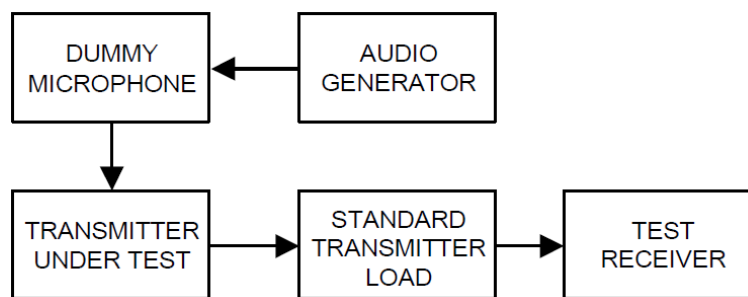

### Test Data: Wideband - Low Pass Filter Response

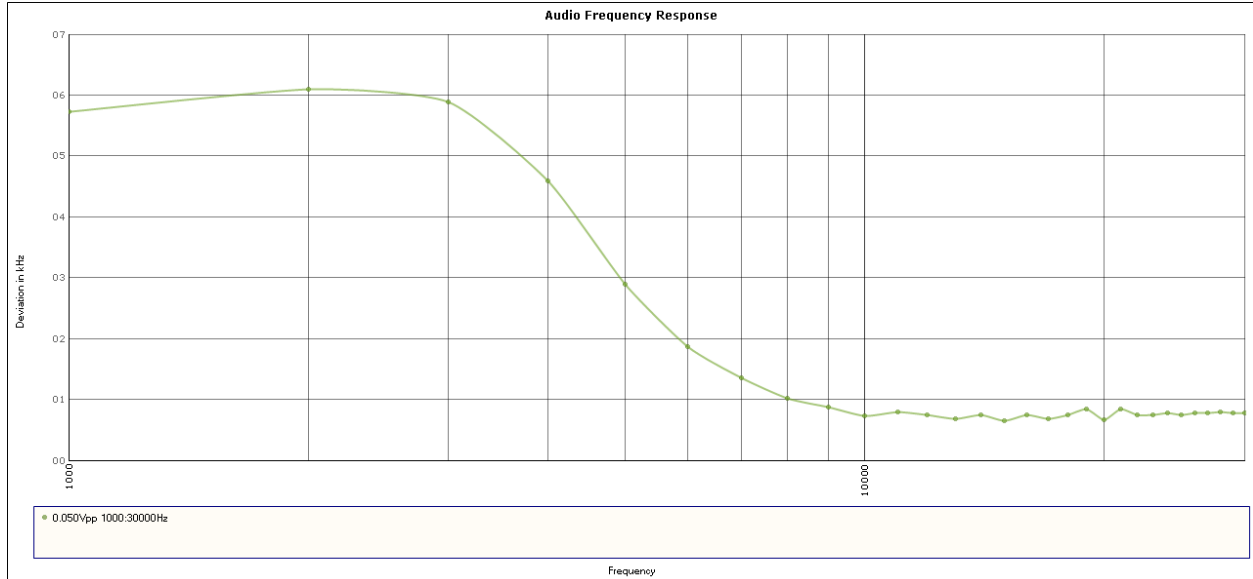

## MODULATION LIMITING

Rule Part: 2.1047(b)

### Requirements:

(b) *Equipment which employs modulation limiting.* A curve or family of curves showing the percentage of modulation versus the modulation input voltage shall be supplied. The information submitted shall be sufficient to show modulation limiting capability throughout the range of modulating frequencies and input modulating signal levels employed.

Test Procedure: TIA 603-E, 2.2.3

**Note:** The test method is not sufficient to meet the standard of FCC Pt. 2.1047 alone. Deviation (kHz), as recorded from test equipment, has been converted into percentage as required above.

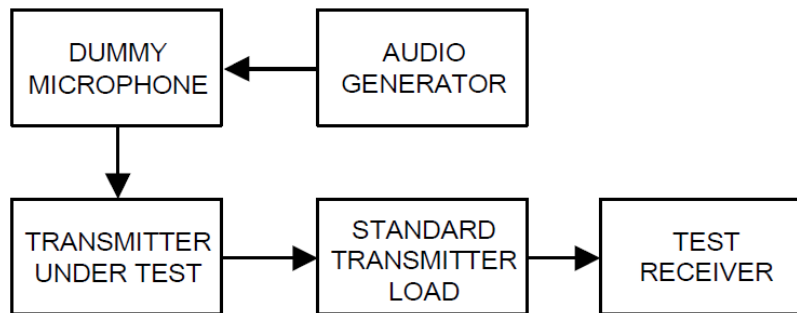

### Test Data: Wideband - Modulation Limiting

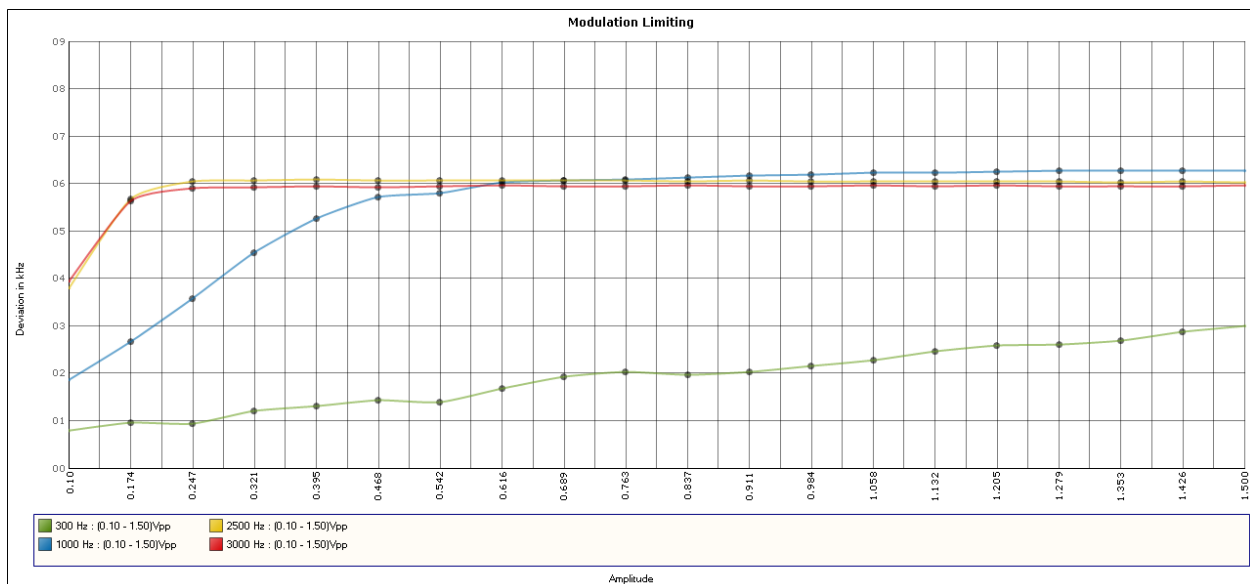

## OCCUPIED BANDWIDTH & EMISSION MASK

**Rule Part:** 2.1049 (c), 90.210(b)

(c) Radiotelephone transmitters equipped with a device to limit modulation or peak envelope power shall be modulated as follows. For single sideband and independent sideband transmitters, the input level of the modulating signal shall be 10 dB greater than that necessary to produce rated peak envelope power.

(1) Other than single sideband or independent sideband transmitters—when modulated by a 2500 Hz tone at an input level 16 dB greater than that necessary to produce 50 percent modulation. The input level shall be established at the frequency of maximum response of the audio modulating circuit.

### §90.210 Emission masks.

Except as indicated elsewhere in this part, transmitters used in the radio services governed by this part must comply with the emission masks outlined in this section. Unless otherwise stated, per paragraphs (d)(4), (e)(4), and (o) of this section, measurements of emission power can be expressed in either peak or average values provided that emission powers are expressed with the same parameters used to specify the unmodulated transmitter carrier power. For transmitters that do not produce a full power unmodulated carrier, reference to the unmodulated transmitter carrier power refers to the total power contained in the channel bandwidth. Unless indicated elsewhere in this part, the table in this section specifies the emission masks for equipment operating under this part.

#### APPLICABLE EMISSION MASKS

Frequency band (MHz)	Mask for equipment with audio low pass filter	Mask for equipment without audio low pass filter
25-50	B	C

(b) *Emission Mask B.* For transmitters that are equipped with an audio low-pass filter, the power of any emission must be attenuated below the unmodulated carrier power (P) as follows:

(1) On any frequency removed from the assigned frequency by more than 50 percent, but not more than 100 percent of the authorized bandwidth: At least 25 dB.

(2) On any frequency removed from the assigned frequency by more than 100 percent, but not more than 250 percent of the authorized bandwidth: At least 35 dB.

(3) On any frequency removed from the assigned frequency by more than 250 percent of the authorized bandwidth: At least  $43 + 10 \log (P)$  dB.

**Method of Measurement:** TIA 603-E 2.2.11

**Note:** The receiver's automatic 99% Occupied Bandwidth function was used. The function is identical in operation to ANSI C63.26, 5.4.4, Step e).

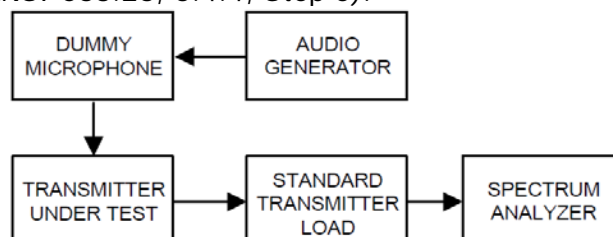

Applicant: FLORIDA, STATE OF  
 FCC ID: 2ALYPDR-06T  
 Report: 858AUT19\_TestReport\_Rev3

### 99% OCCUPIED BANDWIDTH & EMISSION MASK

Test Data: 44.96 MHz, Low Power, Wideband

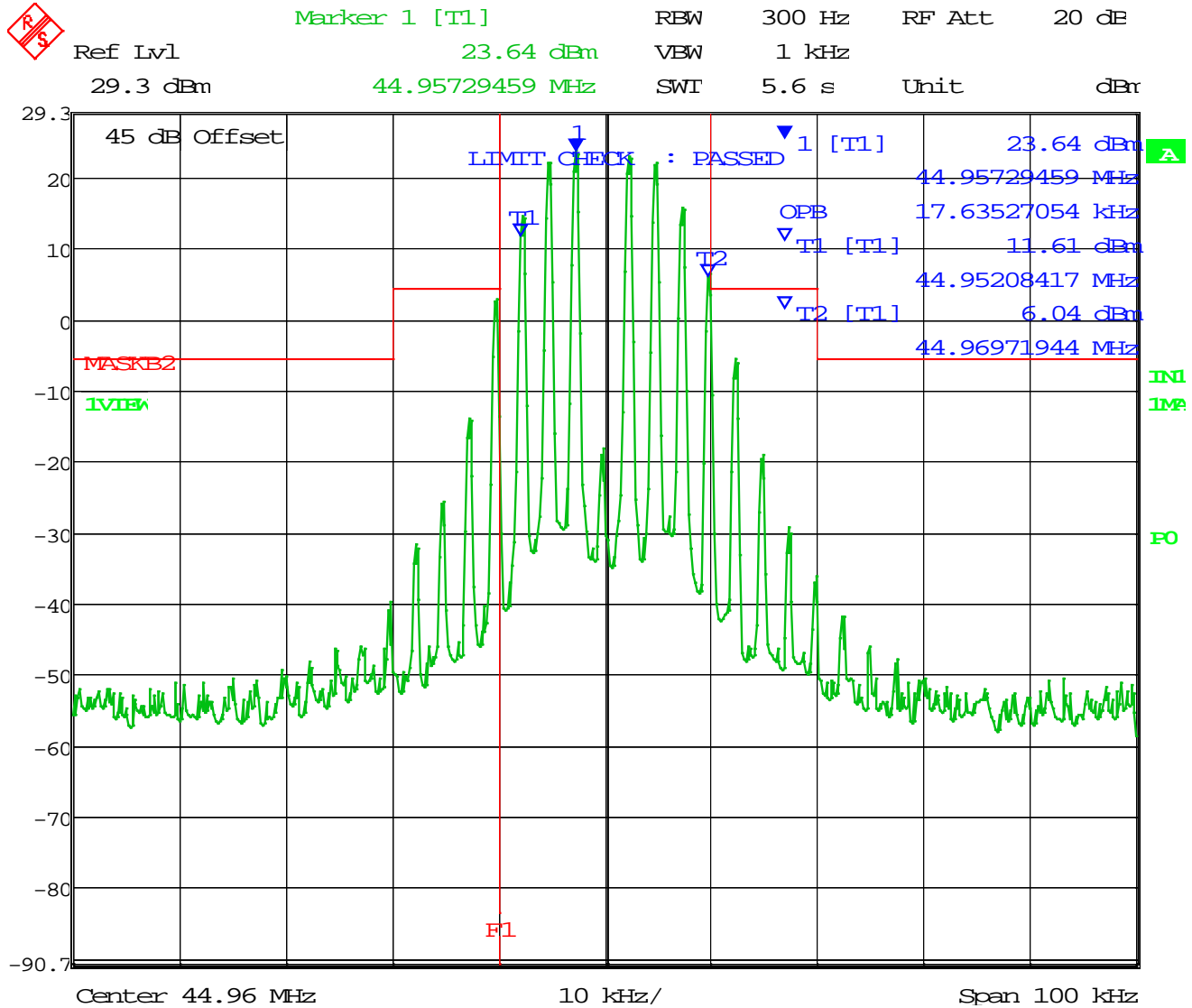

99% OBW = 17.64 kHz



# 99% OCCUPIED BANDWIDTH & EMISSION MASK

Test Data: 47.62 MHz, Low Power, Wideband

	Marker 1 [T1]	RBW	300 Hz	RF Att	20 dB
	Ref Lvl	24.77 dBm	VBW	1 kHz	
	29.8 dBm	47.61729459 MHz	SWT	5.6 s	Unit dBm

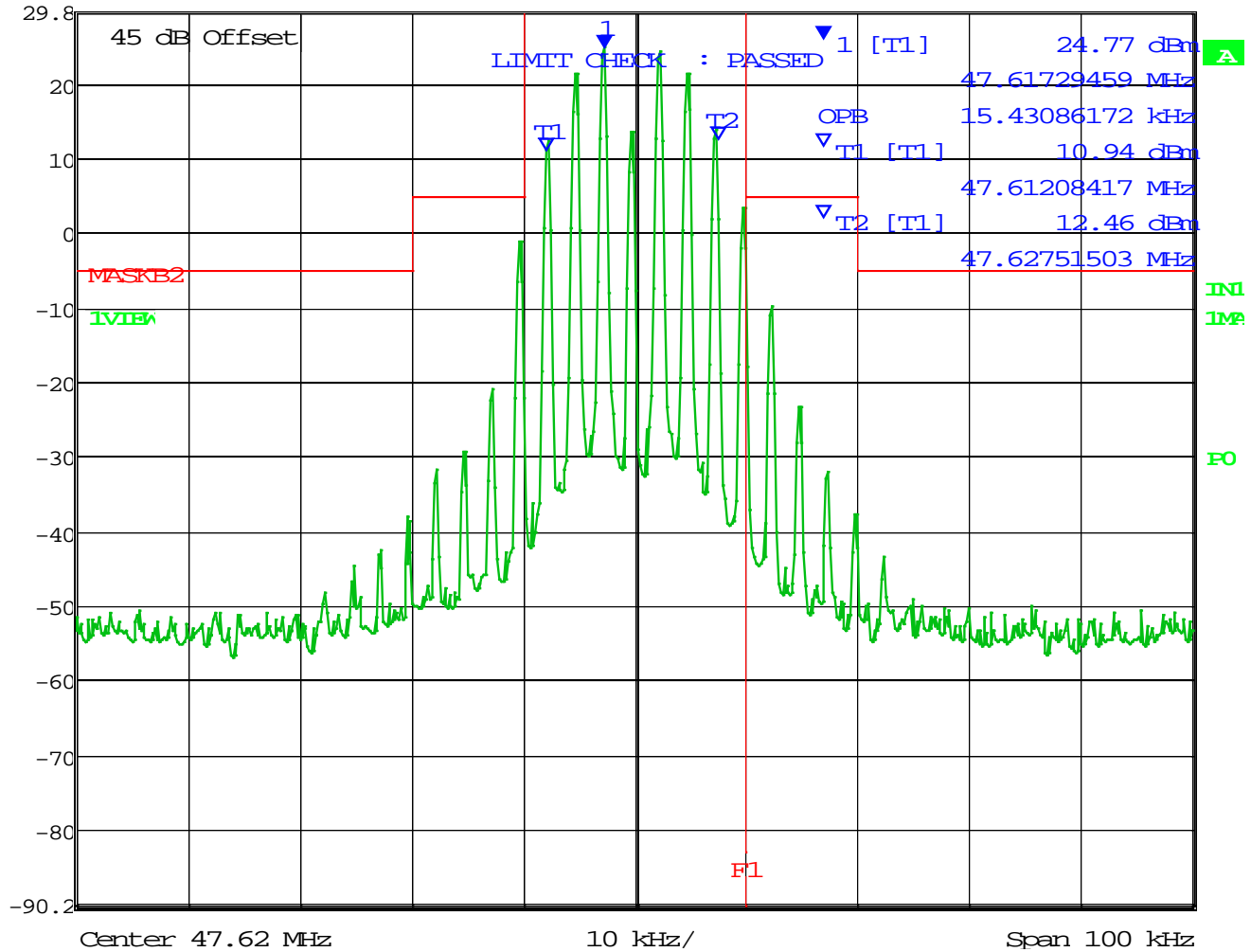

Date: 1.JAN.1997 02:03:13

**99% OBW = 15.43 kHz**

### 99% OCCUPIED BANDWIDTH & EMISSION MASK

Test Data: 47.62 MHz, High Power, Wideband

	Marker 1 [T1]	RBW	300 Hz	RF Att	10 dB
	Ref Lvl	36.64 dBm	VBW	1 kHz	
	47 dBm	47.61729459 MHz	SWT	5.6 s	Unit dBm

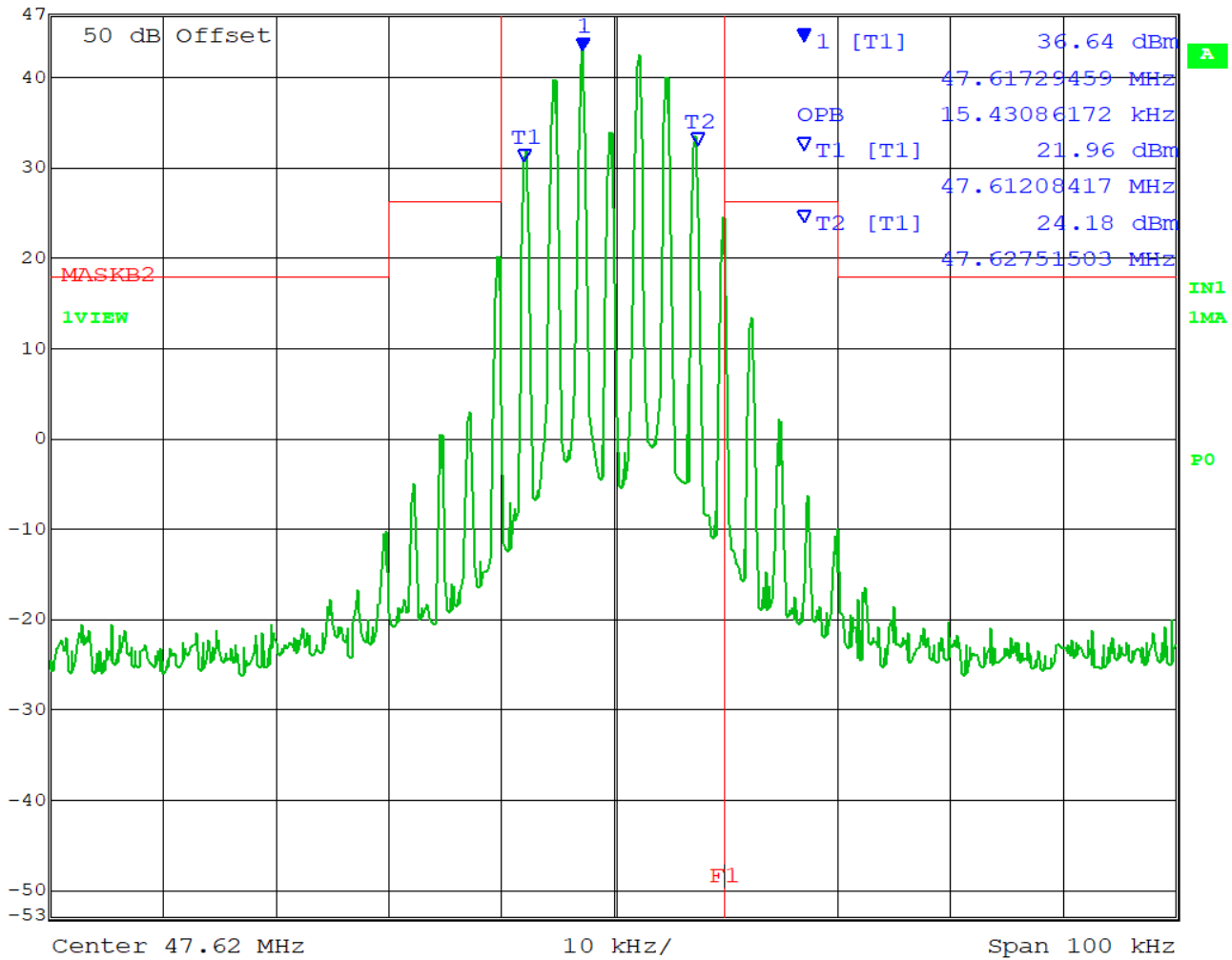

Updated 09/15/2019

**99% OBW = 15.43 kHz**

## SPURIOUS EMISSIONS AT ANTENNA TERMINALS (CONDUCTED)

**Rule Part:** FCC Part 2.1051(a), 90.210(b)(3)

### Requirements:

#### §90.210 Emission masks.

Except as indicated elsewhere in this part, transmitters used in the radio services governed by this part must comply with the emission masks outlined in this section. Unless otherwise stated, per paragraphs (d)(4), (e)(4), and (o) of this section, measurements of emission power can be expressed in either peak or average values provided that emission powers are expressed with the same parameters used to specify the unmodulated transmitter carrier power. For transmitters that do not produce a full power unmodulated carrier, reference to the unmodulated transmitter carrier power refers to the total power contained in the channel bandwidth. Unless indicated elsewhere in this part, the table in this section specifies the emission masks for equipment operating under this part.

#### APPLICABLE EMISSION MASKS

Frequency band (MHz)	Mask for equipment with audio low pass filter	Mask for equipment without audio low pass filter
25-50	B	C

(b) *Emission Mask B.* For transmitters that are equipped with an audio low-pass filter, the power of any emission must be attenuated below the unmodulated carrier power (P) as follows:

(1) On any frequency removed from the assigned frequency by more than 50 percent, but not more than 100 percent of the authorized bandwidth: At least 25 dB.

(2) On any frequency removed from the assigned frequency by more than 100 percent, but not more than 250 percent of the authorized bandwidth: At least 35 dB.

(3) On any frequency removed from the assigned frequency by more than 250 percent of the authorized bandwidth: At least  $43 + 10 \log (P)$  dB.

**Test Procedure:** TIA 603-E, 2.2.13

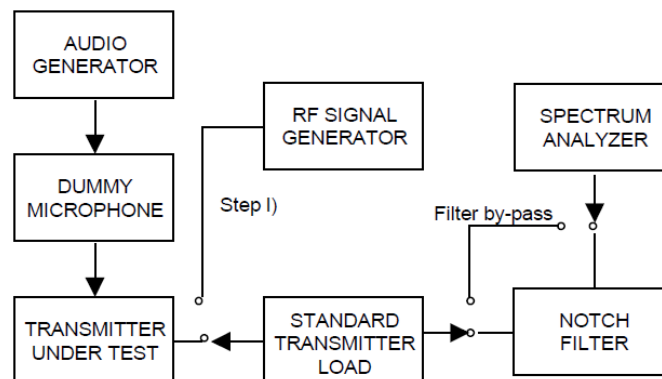



## SPURIOUS EMISSIONS AT ANTENNA TERMINALS

### Spurious Emissions – Antenna Factors

**Note:** The EUT is to be installed with a specific transmit antenna (monopole whip antenna), designed to mitigate harmonic emissions. Testing was done to collect data for the specific transmit antenna which will be employed.

The transmit antenna was connected using the same coaxial cable which will be installed in the vehicular mobile setup, attached to a calibrated signal generator set to transmit a 0.00 dBm CW signal at both of the test frequencies, and each of their harmonics up to and including the 10<sup>th</sup>.

Field strength measurements were taken after the transmit antenna's position and the receive antenna's position were maximized to ascertain the worst-case orientations. The field strength measurement was converted into Effective Radiated Power (dBm) in order to remove free space path loss and to correct the results, in relation to Spurious Conducted Emissions testing.

Tuned Frequency (MHz)	Emission Frequency (MHz)	Meter Reading (dBµV)	Antenna Polarity	Coax Loss (dB)	Correction Factor (dB/m)	Distance (m)	Field Strength (dBµV/m)	ERP (dBm)	Input Signal Power (dBm)	Antenna Gain (dB)	Antenna Loss (dB)
44.96	44.96	83.43	V	0.76	12.60	3.00	96.79	-0.59	0.00	0.00	0.59
44.96	89.92	32.88	V	1.14	10.50	3.00	44.52	-52.86	0.00	0.00	52.86
44.96	134.88	39.37	V	1.32	14.30	3.00	54.99	-42.39	0.00	0.00	42.39
44.96	179.84	36.16	V	1.56	13.90	3.00	51.62	-45.76	0.00	0.00	45.76
44.96	224.80	32.20	V	1.72	10.30	3.00	44.22	-53.16	0.00	0.00	53.16
44.96	269.76	41.52	V	2.07	12.10	3.00	55.69	-41.69	0.00	0.00	41.69
44.96	314.72	37.34	V	2.09	14.60	3.00	54.03	-43.35	0.00	0.00	43.35
44.96	359.68	50.06	V	2.16	14.50	3.00	66.72	-30.66	0.00	0.00	30.66
44.96	404.64	49.15	V	2.30	14.70	3.00	66.15	-31.23	0.00	0.00	31.23
44.96	449.60	61.01	V	2.46	16.00	3.00	79.47	-17.91	0.00	0.00	17.91
47.62	47.62	85.84	V	0.81	11.35	3.00	98.00	0.63	0.00	0.63	0.00
47.62	95.24	30.90	V	1.16	10.90	3.00	42.96	-54.42	0.00	0.00	54.42
47.62	142.86	35.54	V	1.39	16.35	3.00	53.28	-44.10	0.00	0.00	44.10
47.62	190.48	38.00	V	1.61	16.00	3.00	55.61	-41.76	0.00	0.00	41.76
47.62	238.10	35.05	V	1.86	11.00	3.00	47.91	-49.47	0.00	0.00	49.47
47.62	285.72	50.00	V	2.08	13.22	3.00	65.30	-32.08	0.00	0.00	32.08
47.62	333.34	45.85	V	2.11	13.79	3.00	61.75	-35.62	0.00	0.00	35.62
47.62	380.96	50.75	V	2.28	14.62	3.00	67.65	-29.73	0.00	0.00	29.73
47.62	428.58	60.73	V	2.43	15.82	3.00	78.98	-18.39	0.00	0.00	18.39
47.62	476.20	62.74	V	2.63	17.20	3.00	82.58	-14.80	0.00	0.00	14.80

**Note:** Blue highlighted rows indicate the fundamental transmit test frequencies of the EUT.

## SPURIOUS EMISSIONS AT ANTENNA TERMINALS

### Spurious Emissions – Low End of Band

#### 44.96 MHZ, LOW POWER, WIDEBAND

Power Mode	Transmit Mode	Emission Frequency (MHz)	Power Output (dBm)	Antenna Gain (dB)	Antenna Loss (dB)	ERP (dBm)	Limit (dBc)	Limit (dBm)	Margin (dB)
Low	Wideband	44.96	37.00	0.00	0.59	36.41	n/a	n/a	n/a
Low	Wideband	89.92	5.86	0.00	52.86	-47.00	50.00	-13.00	34.00
Low	Wideband	134.88	-24.64	0.00	42.39	-67.03	50.00	-13.00	54.03
Low	Wideband	179.84	-31.17	0.00	45.76	-76.93	50.00	-13.00	63.93
Low	Wideband	224.80	-31.45	0.00	53.16	-84.61	50.00	-13.00	71.61
Low	Wideband	269.76	-31.24	0.00	41.69	-72.93	50.00	-13.00	59.93
Low	Wideband	314.72	-28.69	0.00	43.35	-72.04	50.00	-13.00	59.04
Low	Wideband	359.68	-30.44	0.00	30.66	-61.10	50.00	-13.00	48.10
Low	Wideband	404.64	-30.66	0.00	31.23	-61.89	50.00	-13.00	48.89
Low	Wideband	449.60	-33.43	0.00	17.91	-51.34	50.00	-13.00	38.34

#### 44.96 MHZ, HIGH POWER, WIDEBAND

Power Mode	Transmit Mode	Emission Frequency (MHz)	Power Output (dBm)	Antenna Gain (dB)	Antenna Loss (dB)	ERP (dBm)	Limit (dBc)	Limit (dBm)	Margin (dB)
High	Wideband	44.96	48.95	0.00	0.59	48.36	n/a	n/a	n/a
High	Wideband	89.92	3.63	0.00	52.86	-49.23	61.95	-13.00	36.23
High	Wideband	134.88	-25.24	0.00	42.39	-67.63	61.95	-13.00	54.63
High	Wideband	179.84	-31.85	0.00	45.76	-77.61	61.95	-13.00	64.61
High	Wideband	224.80	-29.93	0.00	53.16	-83.09	61.95	-13.00	70.09
High	Wideband	269.76	-30.05	0.00	41.69	-71.74	61.95	-13.00	58.74
High	Wideband	314.72	-26.58	0.00	43.35	-69.93	61.95	-13.00	56.93
High	Wideband	359.68	-29.40	0.00	30.66	-60.06	61.95	-13.00	47.06
High	Wideband	404.64	-30.92	0.00	31.23	-62.15	61.95	-13.00	49.15
High	Wideband	449.60	-32.50	0.00	17.91	-50.41	61.95	-13.00	37.41

## SPURIOUS EMISSIONS AT ANTENNA TERMINALS

### Spurious Emissions – High End of Band

#### 47.62 MHZ, LOW POWER, WIDEBAND

Power Mode	Transmit Mode	Emission Frequency (MHz)	Power Output (dBm)	Antenna Gain (dB)	Antenna Loss (dB)	ERP (dBm)	Limit (dBc)	Limit (dBm)	Margin (dB)
Low	Wideband	47.62	37.49	0.63	0.00	38.12	n/a	n/a	n/a
Low	Wideband	95.24	0.74	0.00	54.42	-53.68	50.49	-13.00	40.68
Low	Wideband	142.86	-30.26	0.00	44.10	-74.36	50.49	-13.00	61.36
Low	Wideband	190.48	-31.31	0.00	41.76	-73.07	50.49	-13.00	60.07
Low	Wideband	238.10	-30.74	0.00	49.47	-80.21	50.49	-13.00	67.21
Low	Wideband	285.72	-31.25	0.00	32.08	-63.33	50.49	-13.00	50.33
Low	Wideband	333.34	-28.15	0.00	35.62	-63.77	50.49	-13.00	50.77
Low	Wideband	380.96	-31.25	0.00	29.73	-60.98	50.49	-13.00	47.98
Low	Wideband	428.58	-29.97	0.00	18.39	-48.36	50.49	-13.00	35.36
Low	Wideband	476.20	-30.40	0.00	14.80	-45.20	50.49	-13.00	32.20

#### 47.62 MHZ, HIGH POWER, WIDEBAND

Power Mode	Transmit Mode	Emission Frequency (MHz)	Power Output (dBm)	Antenna Gain (dB)	Antenna Loss (dB)	ERP (dBm)	Limit (dBc)	Limit (dBm)	Margin (dB)
High	Wideband	47.62	49.31	0.63	0.00	49.94	n/a	n/a	n/a
High	Wideband	95.24	-4.80	0.00	54.42	-59.22	62.31	-13.00	46.22
High	Wideband	142.86	-26.90	0.00	44.10	-71.00	62.31	-13.00	58.00
High	Wideband	190.48	-31.50	0.00	41.76	-73.26	62.31	-13.00	60.26
High	Wideband	238.10	-30.56	0.00	49.47	-80.03	62.31	-13.00	67.03
High	Wideband	285.72	-29.47	0.00	32.08	-61.55	62.31	-13.00	48.55
High	Wideband	333.34	-31.14	0.00	35.62	-66.76	62.31	-13.00	53.76
High	Wideband	380.96	-29.68	0.00	29.73	-59.41	62.31	-13.00	46.41
High	Wideband	428.58	-30.64	0.00	18.39	-49.03	62.31	-13.00	36.03
High	Wideband	476.20	-29.60	0.00	14.80	-44.40	62.31	-13.00	31.40

## FIELD STRENGTH OF SPURIOUS EMISSIONS

**Rule Part:** FCC Part 2.1053(a), 90.210(d)(3)

**Method of Measurement:** ANSI C63.26, 5.5.4

**Test Site Setup:**

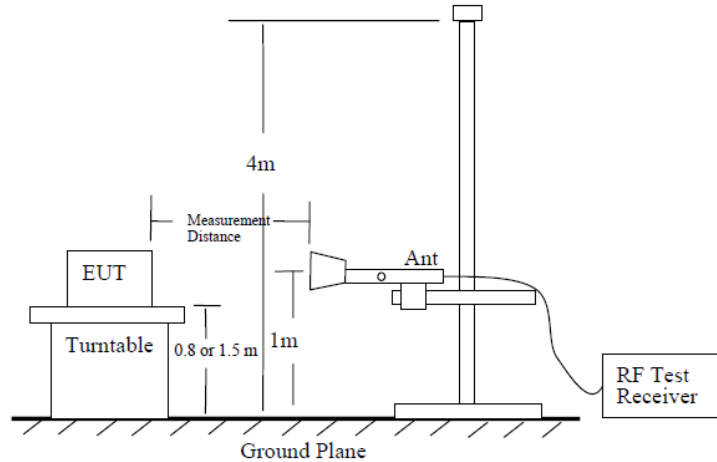

**EUT Orientation(s):**

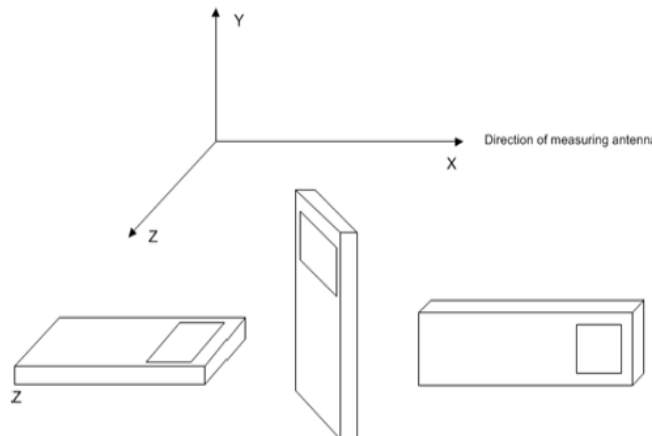

**Note:** The tabulated data shows the results of the radiated field strength emissions test. The spectrum was scanned from the lowest frequency generated internally to at least the tenth harmonic of the fundamental. This test was conducted in accordance with the standard listed above using the substitution method. Measurements were made at the test site of TIMCO ENGINEERING, INC. located at 849 NW State Road 45, Newberry, FL 32669. The measurements below represent the worst case of all the frequencies tested.

**Note:** The six (6) highest emissions or more of each worst-case operational modes of the EUT are represented below. Emissions 20 dB below the limit are not required to be reported.

## FIELD STRENGTH OF SPURIOUS EMISSIONS

Test Data: 44.96 MHz, Wideband, High Power

Tuned Frequency (MHz)	Emission Frequency (MHz)	Meter Reading (dBµV)	Antenna Polarity	Coax Loss (dB)	Correction Factor (dB/m)	Distance (m)	Field Strength (dBµV/m)	ERP (dBm)	Limit (dBm)	Margin (dBm)
44.96	89.92	49.24	V	1.12	10.60	3.00	60.96	-36.42	-13.00	23.42
44.96	89.92	48.02	H	1.12	10.60	3.00	59.74	-37.64	-13.00	24.64
44.96	134.88	50.65	V	1.34	14.20	3.00	66.19	-31.19	-13.00	18.19
44.96	134.88	45.71	H	1.34	14.20	3.00	61.25	-36.13	-13.00	23.13
44.96	179.84	40.49	H	1.52	14.10	3.00	56.11	-41.26	-13.00	28.26
44.96	179.84	38.07	V	1.52	14.10	3.00	53.69	-43.68	-13.00	30.68
44.96	224.80	43.19	H	1.73	10.60	3.00	55.51	-41.86	-13.00	28.86
44.96	224.80	30.19	V	1.73	10.60	3.00	42.51	-54.86	-13.00	41.86
44.96	269.76	29.77	H	1.92	13.70	3.00	45.39	-51.99	-13.00	38.99
44.96	269.76	28.44	V	1.92	13.70	3.00	44.06	-53.32	-13.00	40.32
44.96	314.72	47.80	H	2.07	13.50	3.00	63.37	-34.01	-13.00	21.01
44.96	314.72	43.51	V	2.07	13.50	3.00	59.08	-38.30	-13.00	25.30
44.96	359.68	32.46	H	2.18	14.80	3.00	49.44	-47.94	-13.00	34.94
44.96	359.68	25.14	V	2.18	14.80	3.00	42.12	-55.26	-13.00	42.26
44.96	404.64	35.09	H	2.30	15.30	3.00	52.69	-44.69	-13.00	31.69
44.96	404.64	33.64	V	2.30	15.30	3.00	51.24	-46.14	-13.00	33.14
44.96	449.60	30.37	H	2.43	16.40	3.00	49.21	-48.17	-13.00	35.17
44.96	449.60	30.04	V	2.43	16.40	3.00	48.88	-48.50	-13.00	35.50

Test Data: 47.62 MHz, Wideband, High Power

Tuned Frequency (MHz)	Emission Frequency (MHz)	Meter Reading (dBµV)	Antenna Polarity	Coax Loss (dB)	Correction Factor (dB/m)	Distance (m)	Field Strength (dBµV/m)	ERP (dBm)	Limit (dBm)	Margin (dBm)
47.62	95.24	49.26	V	1.16	10.90	3.00	61.32	-36.06	-13.00	23.06
47.62	95.24	48.05	H	1.16	10.90	3.00	60.11	-37.27	-13.00	24.27
47.62	142.86	50.81	H	1.39	16.35	3.00	68.55	-28.83	-13.00	15.83
47.62	142.86	46.08	V	1.39	16.35	3.00	63.82	-33.56	-13.00	20.56
47.62	190.48	40.55	H	1.61	16.00	3.00	58.16	-39.22	-13.00	26.22
47.62	190.48	38.38	V	1.61	16.00	3.00	55.99	-41.39	-13.00	28.39
47.62	238.10	43.55	H	1.86	11.00	3.00	56.41	-40.97	-13.00	27.97
47.62	238.10	30.37	V	1.86	11.00	3.00	43.23	-54.15	-13.00	41.15
47.62	285.72	30.01	V	2.08	13.22	3.00	45.31	-52.07	-13.00	39.07
47.62	285.72	28.65	H	2.08	13.22	3.00	43.95	-53.43	-13.00	40.43
47.62	333.34	47.86	H	2.11	13.79	3.00	63.76	-33.62	-13.00	20.62
47.62	333.34	43.82	V	2.11	13.79	3.00	59.72	-37.66	-13.00	24.66
47.62	380.96	32.59	V	2.28	14.62	3.00	49.49	-47.89	-13.00	34.89
47.62	380.96	25.29	H	2.28	14.62	3.00	42.19	-55.19	-13.00	42.19
47.62	428.58	35.11	H	2.43	15.82	3.00	53.36	-44.02	-13.00	31.02
47.62	428.58	33.67	V	2.43	15.82	3.00	51.92	-45.46	-13.00	32.46
47.62	476.20	30.41	V	2.64	17.20	3.00	50.25	-47.13	-13.00	34.13
47.62	476.20	30.31	H	2.64	17.20	3.00	50.15	-47.23	-13.00	34.23

## FREQUENCY STABILITY

**Rule Part:** FCC Part 2.1055(a)(2), 90.213

### §90.213 Frequency stability.

(a) Unless noted elsewhere, transmitters used in the services governed by this part must have a minimum frequency stability as specified in the following table.

#### MINIMUM FREQUENCY STABILITY

[Parts per million (ppm)]

Frequency range (MHz)	Fixed and base stations	Mobile stations	
		Over 2 watts output power	2 watts or less output power
25-50	20	20	50

**Method of Measurements:** TIA 603-E, 2.2.2

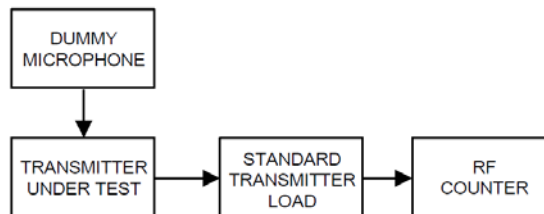

### Test Data: Frequency Error Measurement Table

FCC Part 90 Limit	20.0	ppm	
FCC Part 90 Limit, as ppb	20000	ppb (Parts per Billion)	
FCC Part 90 Limit, as %	0.00200	%	
Strictest Combined Limit, as Hz	899.997	Hz	
Combined Lower Limit	44.998973	MHz	
Combined Upper Limit	45.000773	MHz	
Rated Supply Voltage	13.8	<input type="radio"/> AC <input checked="" type="radio"/> DC	
Temperature / Voltage Variation			
Temperature (°C)	Supplied Voltage (V)	Frequency (MHz)	Deviation (kHz)
-30	13.8	Did not Transmit	
-20	13.8	Did not Transmit	
-10	13.8	Did not Transmit	
0	13.8	Did not Transmit	
+10	13.8	44.999945	-0.072
+20 (reference)	13.8	44.999873	0.000
+20	11.7	44.999873	0.000
+20	15.9	44.999865	0.008
+30	13.8	44.999843	0.030
+40	13.8	44.999751	0.122
+50	13.8	44.999753	0.120

Applicant: FLORIDA, STATE OF  
 FCC ID: 2ALYPDR-06T  
 Report: 858AUT19\_TestReport\_Rev3

## FREQUENCY STABILITY

Test Data: Frequency Error Measurement Plot

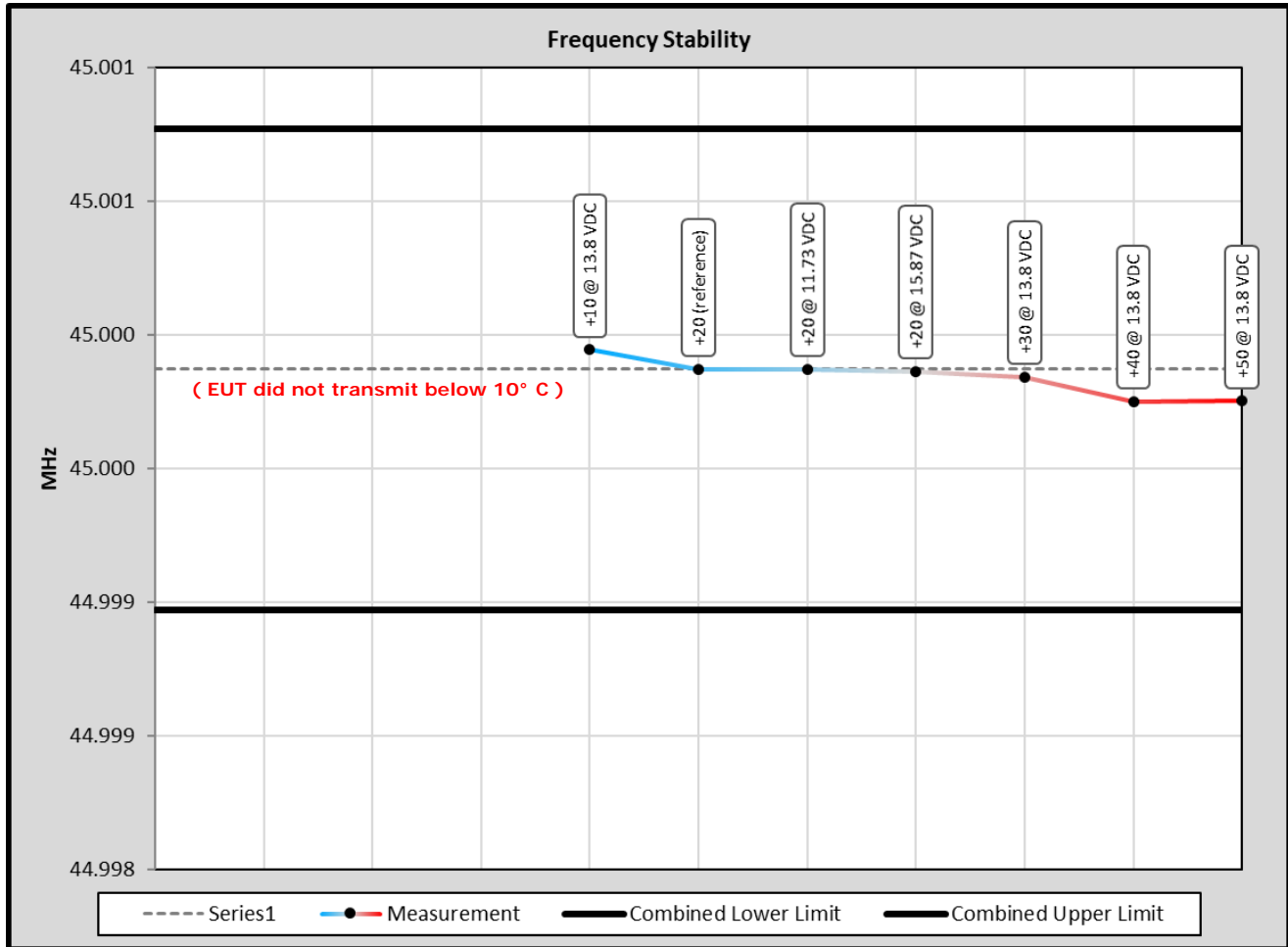

**Note:** The EUT stops operating at temperatures below 10° C. An FCC Inquiry was filed to address this failure to operate, and the FCC instructed that this was acceptable. The EUT, in no case, violates the frequency deviation limit of 20 ppm for this band.

## STATEMENT OF MEASUREMENT UNCERTAINTY

The data and results referenced in this document are true and accurate. The measurement uncertainty was calculated for all measurements listed in this test report according To CISPR 16-4 or ENTR 100-028 Specification for radio disturbance and immunity measuring apparatus and methods – Part 4: “Uncertainty in EMC Measurements” and is documented in the Timco Engineering, Inc. quality system according to DIN EN ISO/IEC 17025. Furthermore, component and process variability of devices similar to that tested may result in additional deviation. The manufacturer has the sole responsibility of continued compliance of the device.

Hereafter the best measurement capability for Timco Engineering, Inc. is reported:

Test Items	Measurement Uncertainty	Notes
RF Frequency Accuracy	± 49.5 Hz	(1)
RF Conducted Power	±0.93dB	(1)
Conducted spurious emission of transmitter valid up to 40GHz	±1.86dB	
Occupied Bandwidth	±2.65%	
Audio Frequency Response	±1.86dB	
Modulation limiting	±1.88%	
Radiated RF Power	±1.4dB	
Maximum frequency deviation: Within 300 Hz and 6kHz of audio freq.	±1.88%	
Within 6kHz and 25kHz of audio Freq.	±2.04%	
Rad Emissions Sub Meth up to 26.5GHz	±2.14dB	
Adjacent channel power	±1.47dB	(1)
Transient Frequency Response	±1.88%	
Temperature	±1.0°C	(1)
Humidity	±5.0%	

Notes: (1) This uncertainty represents an expanded uncertainty expressed at approximately the 95% confidence level using a coverage factor of k=1.96.



## EMC EQUIPMENT LIST

Device	Manufacturer	Model	Serial Number	Cal/Char Date	Due Date
CHAMBER	Panashield	3M	N/A	03/15/19	03/15/21
Antenna: Active Loop	ETS-Lindgren	6502	00062529	12/11/17	12/11/19
Antenna: Biconical 1057	Eaton	94455-1	1057	12/13/17	12/13/19
Antenna: Log-Periodic 1243	Eaton	96005	1243	04/20/18	04/20/21
Coaxial Cable - Chamber 3 cable set (backup)	Micro-Coax	Chamber 3 cable set (backup)	KMKM-0244-02 KMKM-0670-01 KFKF-0197-00	02/27/19	02/27/21
Software: Field Strength Program	Timco	N/A	Version 4.10.7.0	N/A	N/A
EMI Test Receiver R & S ESU 40	Rohde & Schwarz	ESU 40	100320	08/28/18	08/28/20
Comb Generator	Com-Power Corp	CGO-515	291728	NA	NA
Function Generator	Standford	DS340	25200	02/21/18	02/21/20
Modulation Analyzer	HP	8901A	3050A05856	04/13/17	04/13/20
Audio Analyzer	HP	8903B	3011A13084	02/20/18	02/20/20
Audio Load	Heathkit	ID-5252	00714	NA	NA
DC Power Supply	HP	6286A	1744A03842	NA	NA
Digital Multimeter	Fluke	77	35053830	11/06/17	11/06/19
Temperature Chamber LARGE	Tenney Engineering	TTRC	11717-7	NA	NA
Type K J Thermometer	Martel	303	080504494	11/06/17	11/06/19
Frequency Counter Small Chamber	HP	5385A	3242A07460	08/22/17	08/22/19
DC Power Supply	HP	6264B	2032A04119	NA	NA
Attenuator N 30dB 100W DC-6G	Pasternack	PE7214-30	#109	05/24/17	05/23/19
Attenuator N 20dB 20W DC-12G	Narda	768-20-SP	155	07/10/17	07/10/19
Tunable Notch Filter 30-75 MHz	Eagle	TNF-200	30-75 MHz (#18)	11/19/17	11/19/19
Coaxial Cable - BMBM-0122-01 RG400	Pasternack	PE3582LF-48	BMBM-0122-01	04/15/19	04/15/21
Coaxial Cable - BMBM-0122-02 RG400	Pasternack	PE3582LF-48	BMBM-0122-02	04/15/19	04/15/21
Coaxial Cable - BMBM-0122-03 RG400	Pasternack	PE3582LF-48	BMBM-0122-03	04/15/19	04/15/21
Coaxial Cable - BMBM-0122-04 RG400	Pasternack	PE3582LF-48	BMBM-0122-04	04/15/19	04/15/21
Power Sensor	Boonton	51072A	34647	01/12/21	01/12/23

### \*EMI RECEIVER SOFTWARE VERSION

The receiver firmware used was version 4.43 Service Pack 3

**END OF TEST REPORT**