

# FCC Part 15C Test Report

## FCC ID: 2ALXN-BP3

Product Name: Bluetooth Speaker

Trademark: N/A  
BP3  
BP1, BP2, BP4, BP5, BP6, BP7, BP8, BP9, BP10, BP11, BP12, BP13, BP14, BP15, BP16, BP17, BP18, BP19, BP20, BP21, BP22, BP23, BP24, BP25, BP26, BP27, BP28, BP29, BP30, BP31, BP32, BP33, BP34, BP35, BP36, BP37, BP38, BP39, BP40, BP41, BP42, BP43, BP44, BP45, BP46, BP47, BP48, BP49, BP50, BP51, BP52, BP53, BP54, BP55, BP56, BP57, BP58, BP59, BP60, BP61, BP62, BP63, BP64, BP65, BP66, BP67, BP68, BP69, BP70

Model Number:

Prepared For: Borofone Technology Co.,Ltd

Address: Room 205, Block B, Weidonglong Business Building Meilong Road, Longhua New District Shenzhen, China

Manufacturer: Borofone Technology Co.,Ltd

Address: Room 205, Block B, Weidonglong Business Building Meilong Road, Longhua New District Shenzhen, China

Prepared By: Shenzhen BCTC Testing Co., Ltd.

Address: BCTC Building & 1-2F, East of B Building, Pengzhou Industrial, Fuyuan 1st Road, Qiaotou Community, Fuyong Street, Bao'an District, Shenzhen, China

Sample tested Date: Dec. 29, 2018 - Jan. 11, 2019

Issue Date: Jan. 11, 2019

Report No.: BCTC-FY181207072E

Test Standards: FCC Part15.249  
ANSI C63.10-2013

Prepared by(Engineer): Amou Zhang

Amou Zhang

Reviewer(Supervisor): Eric Yang

Eric

Approved(Manager): Carson Zhang

Carson



*The test report is effective only with both signature and specialized stamp. This result(s) shown in this report refer only to the sample(s) tested. Without written approval of Shenzhen BCTC Testing Co., Ltd, this report can't be reproduced except in full. The tested sample(s) and the sample information are provided by the client.*

<b>Table of Contents</b>	<b>Page</b>
<b>1 . VERSION</b>	<b>4</b>
<b>2 . SUMMARY OF TEST RESULTS</b>	<b>4</b>
2.1 TEST FACILITY	4
2.2 MEASUREMENT UNCERTAINTY	5
<b>3 . GENERAL INFORMATION</b>	<b>6</b>
3.1 GENERAL DESCRIPTION OF EUT	6
3.2 DESCRIPTION OF TEST MODES	7
3.3 TABLE OF PARAMETERS OF TEXT SOFTWARE SETTING	7
3.4 BLOCK DIGRAM SHOWING THE CONFIGURATION OF SYSTEM TESTED	8
3.5 DESCRIPTION OF SUPPORT UNITS(CONDUCTED MODE)	8
3.6 EQUIPMENTS LIST FOR ALL TEST ITEMS	9
<b>4 . EMC EMISSION TEST</b>	<b>10</b>
4.1 CONDUCTED EMISSION MEASUREMENT	10
4.1.1 POWER LINE CONDUCTED EMISSION LIMITS	10
4.1.2 TEST PROCEDURE	11
4.1.3 DEVIATION FROM TEST STANDARD	11
4.1.4 TEST SETUP	11
4.1.5 EUT OPERATING CONDITIONS	11
4.2 RADIATED EMISSION MEASUREMENT	14
4.2.1 RADIATED EMISSION LIMITS	14
4.2.2 TEST PROCEDURE	15
4.2.3 DEVIATION FROM TEST STANDARD	15
4.2.4 TEST SETUP	16
4.2.5 EUT OPERATING CONDITIONS	17
4.2.6 TEST RESULTS	18
<b>5 . BANDWIDTH TEST</b>	<b>25</b>
5.1 APPLIED PROCEDURES / LIMIT	25
5.1.1 TEST PROCEDURE	25
5.1.2 DEVIATION FROM STANDARD	25
5.1.3 TEST SETUP	25
5.1.4 EUT OPERATION CONDITIONS	25
5.1.5 TEST RESULTS	26
<b>6 . 100 KHZ BANDWIDTH OF FREQUENCY BAND EDGE</b>	<b>31</b>
6.1 DEVIATION FROM STANDARD	31
6.2 TEST SETUP	31
6.3 EUT OPERATION CONDITIONS	31
6.4 TEST RESULTS	32

<b>Table of Contents</b>	<b>Page</b>
<b>7 . ANTENNA REQUIREMENT</b>	<b>37</b>
<b>7.1 STANDARD REQUIREMENT</b>	<b>37</b>
<b>7.2 EUT ANTENNA</b>	<b>37</b>
<b>8 . EUT TEST PHOTO</b>	<b>38</b>
<b>9 . EUT PHOTO</b>	<b>40</b>

## 1. VERSION

Report No.	Issue Date	Description	Approved
BCTC-FY181207072E	Jan. 11, 2019	Original	Valid

## 2. SUMMARY OF TEST RESULTS

Test procedures according to the technical standards:

FCC Part15 (15.249) , Subpart C			
Standard Section	Test Item	Judgment	Remark
15.207	Conducted Emission	PASS	
15.249	Fundamental & Radiated Spurious Emission Measurement	PASS	
15.249	Bandwidth	PASS	
15.205	Band Edge Emission	PASS	
15.203	Antenna Requirement	PASS	

### NOTE:

(1) "N/A" denotes test is not applicable in this Test Report

### 2.1 TEST FACILITY

Shenzhen BCTC Testing Co., Ltd.

Add.: BCTC Building & 1-2F, East of B Building, Pengzhou Industrial, Fuyuan 1st Road, Qiaotou Community, Fuyong Street, Bao'an District, Shenzhen, China

FCC Test Firm Registration Number: 712850

IC Registered No.: 23583

## 2.2 MEASUREMENT UNCERTAINTY

The reported uncertainty of measurement  $y \pm U$ , where expanded uncertainty  $U$  is based on a standard uncertainty multiplied by a coverage factor of  $k=2$ , providing a level of confidence of approximately **95 %**.

No.	Item	Uncertainty
1	3m chamber Radiated spurious emission(30MHz-1GHz)	U=4.3dB
2	3m chamber Radiated spurious emission(1GHz-18GHz)	U=4.5dB
3	3m chamber Radiated spurious emission(18GHz-40GHz)	U=3.34dB
4	Conducted Adjacent channel power	U=1.38dB
5	Conducted output power uncertainty Above 1G	U=1.576dB
6	Conducted output power uncertainty below 1G	U=1.28dB
7	humidity uncertainty	U=5.3%
8	Temperature uncertainty	U=0.59°C
9	Radiated disturbance(30MHz-1000MHz)	U=4.8dB
10	Radiated disturbance(1GHz-6GHz)	U=4.9dB
11	Radiated disturbance(1GHz-18GHz)	U=5.0dB

### 3. GENERAL INFORMATION

#### 3.1 GENERAL DESCRIPTION OF EUT

Equipment	Bluetooth Speaker										
Trade Name	N/A										
Model Name	BP3										
Serial Model	BP1, BP2, BP4, BP5, BP6, BP7, BP8, BP9, BP10, BP11, BP12, BP13, BP14, BP15, BP16, BP17, BP18, BP19, BP20, BP21, BP22, BP23, BP24, BP25, BP26, BP27, BP28, BP29, BP30, BP31, BP32, BP33, BP34, BP35, BP36, BP37, BP38, BP39, BP40, BP41, BP42, BP43, BP44, BP45, BP46, BP47, BP48, BP49, BP50, BP51, BP52, BP53, BP54, BP55, BP56, BP57, BP58, BP59, BP60, BP61, BP62, BP63, BP64, BP65, BP66, BP67, BP68, BP69, BP70										
Model Difference	All the model are the same circuit and RF module, Only for different Model name and color.										
Product Description	<table border="1"> <tr> <td>Operation Frequency:</td> <td>2402~2480 MHz</td> </tr> <tr> <td>Modulation Type:</td> <td>GFSK,PI/4 DPSK</td> </tr> <tr> <td>Bit Rate of Transmitter</td> <td>1M/2Mbps</td> </tr> <tr> <td>Number Of Channel</td> <td>79 CH</td> </tr> <tr> <td>Antenna Designation:</td> <td>Please see Note 3.</td> </tr> </table> <p>Based on the application, features, or specification exhibited in User's Manual, the EUT is considered as an ITE/Computing Device. More details of EUT technical specification, please refer to the User's Manual.</p>	Operation Frequency:	2402~2480 MHz	Modulation Type:	GFSK,PI/4 DPSK	Bit Rate of Transmitter	1M/2Mbps	Number Of Channel	79 CH	Antenna Designation:	Please see Note 3.
Operation Frequency:	2402~2480 MHz										
Modulation Type:	GFSK,PI/4 DPSK										
Bit Rate of Transmitter	1M/2Mbps										
Number Of Channel	79 CH										
Antenna Designation:	Please see Note 3.										
Channel List	Please refer to the Note 2.										
Power supply	Battery DC 3.85V DC 5.0V USB charging from adapter										
Connecting I/O Port(s)	Please refer to the User's Manual										

Note:

- For a more detailed features description, please refer to the manufacturer's specifications or the User's Manual.
- 

Channel List					
Channel	Frequency (MHz)	Channel	Frequency (MHz)	Channel	Frequency (MHz)
00	2402	27	2429	54	2456
01	2403	28	2430	55	2457
02	2404	29	2431	56	2458
03	2405	30	2432	57	2459
04	2406	31	2433	58	2460
05	2407	32	2434	59	2461
06	2408	33	2435	60	2462
07	2409	34	2436	61	2463

08	2410	35	2437	62	2464
09	2411	36	2438	63	2465
10	2412	37	2439	64	2466
11	2413	38	2440	65	2467
12	2414	39	2441	66	2468
13	2415	40	2442	67	2469
14	2416	41	2443	68	2470
15	2417	42	2444	69	2471
16	2418	43	2445	70	2472
17	2419	44	2446	71	2473
18	2420	45	2447	72	2474
19	2421	46	2448	73	2475
20	2422	47	2449	74	2476
21	2423	48	2450	75	2477
22	2424	49	2451	76	2478
23	2425	50	2452	77	2479
24	2426	51	2453	78	2480
25	2427	52	2454		
26	2428	53	2455		

3.

Table for Filed Antenna

Ant.	Brand	Model Name	Antenna Type	Gain (dBi)	NOTE
1	N/A	N/A	PCB antenna	-0.58	

### 3.2 DESCRIPTION OF TEST MODES

To investigate the maximum EMI emission characteristics generates from EUT, the test system was pre-scanning tested base on the consideration of following EUT operation mode or test configuration mode which possible have effect on EMI emission level. Each of these EUT operation mode(s) or test configuration mode(s) mentioned above was evaluated respectively.

Test Mode	Test mode	Low channel	Middle channel	High channel
1	Transmitting(GFSK)	2402MHz	2441MHz	2480MHz
2	Transmitting(Pi/4DQPSK)	2402MHz	2441MHz	2480MHz
3	Transmitting (conducted emission and Radiated emission)			

Note:

- (1) The measurements are performed at the highest, middle, lowest available channels.
- (2) Fully-charged battery is used during the test

### 3.3 TABLE OF PARAMETERS OF TEXT SOFTWARE SETTING

During testing channel & power controlling software provided by the customer was used to control the operating channel as well as the output power level. The RF output power selection is for the setting of RF output power expected by the customer and is going to be fixed on the firmware of the final end product power parameters of FHSS

Frequency	2402 MHz	2441 MHz	2480 MHz
Channel	Low	Middle	High

### 3.4 BLOCK DIGRAM SHOWING THE CONFIGURATION OF SYSTEM TESTED

Conducted Emission Test

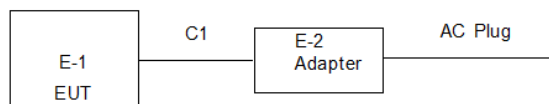

Radiated Spurious Emission

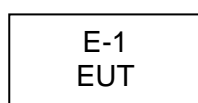

### 3.5 DESCRIPTION OF SUPPORT UNITS(CONDUCTED MODE)

The EUT has been tested as an independent unit together with other necessary accessories or support units. The following support units or accessories were used to form a representative test configuration during the tests.

No.	Device Type	Brand	Model	Series No.	Data Cable
E-1	Bluetooth Speaker	N/A	BP3	N/A	EUT
E-2	Adapter	---	BCTC005	---	Auxiliary

Item	Shielded Type	Ferrite Core	Length	Note
C1	NO	NO	0.8M	DC cable unshielded

Note:

- (1) The support equipment was authorized by Declaration of Confirmation.
- (2) For detachable type I/O cable should be specified the length in cm in 『Length』 column.
- (3) “YES” is means “shielded” “with core”; “NO” is means “unshielded” “without core”.



### 3.6 EQUIPMENTS LIST FOR ALL TEST ITEMS

#### Radiation Test equipment

Item	Equipment	Manufacturer	Type No.	Serial No.	Last calibration	Calibrated until
1	Spectrum Analyzer (9kHz-26.5GHz)	Agilent	E4407B	MY45109572	2018.06.20	2019.06.20
2	Test Receiver (9kHz-7GHz)	R&S	ESRP	101154	2018.06.20	2019.06.20
3	Bilog Antenna (30MHz-3GHz)	SCHWARZBEC K	VULB9163	VULB9163-942	2018.06.23	2019.06.23
4	Horn Antenna (1GHz-18GHz)	SCHWARZBEC K	BBHA9120D	1541	2018.06.23	2019.06.22
5	Horn Antenna (18GHz-40GHz)	SCHWARZBEC K	BBHA9170	822	2018.08.06	2019.08.06
6	Amplifier (9KHz-6GHz)	SCHWARZBEC K	BBV9744	9744-0037	2018.06.20	2019.06.20
7	Amplifier (0.5GHz-18GHz)	SCHWARZBEC K	BBV9718	9718-309	2018.06.20	2019.06.20
8	Amplifier (18GHz-40GHz)	MITEQ	TTA1840-35-H G	2034381	2018.08.06	2019.08.06
9	Loop Antenna (9KHz-30MHz)	SCHWARZBEC K	FMZB1519B	014	2018.06.23	2019.06.23
10	RF cables1 (9kHz-30MHz)	Huber+Suhnar	9kHz-30MHz	B1702988-0008	2018.02.12	2019.02.12
11	RF cables2 (30MHz-1GHz)	Huber+Suhnar	30MHz-1GHz	1486150	2018.03.27	2019.03.27
12	RF cables3 (1GHz-40GHz)	Huber+Suhnar	1GHz-40GHz	1607106	2018.06.19	2019.06.19
13	Power Metter	Keysight	E4419	\	2018.04.15	2019.04.15
14	Power Sensor (AV)	Keysight	E9300A	\	2018.04.15	2019.04.15
15	Signal Analyzer 20kHz-26.5GHz	KEYSIGHT	N9020A	MY49100060	2018.07.11	2019.07.11
16	Test Receiver 9kHz-40GHz	R&S	FSP40	100550	2018.06.13	2019.06.12
17	D.C. Power Supply	LongWei	TPR-6405D	\	\	\
18	Software	Frad	EZ-EMC	FA-03A2 RE	\	\

#### Conduction Test equipment

Item	Equipment	Manufacturer	Type No.	Serial No.	Last calibration	Calibrated until
1	Test Receiver	R&S	ESR3	102075	2018.06.20	2019.06.20
2	LISN	SCHWARZBECK	NSLK8127	8127739	2018.06.19	2019.06.19
3	LISN	R&S	ENV216	101375	2018.06.20	2019.06.20
4	RF cables	Huber+Suhnar	9kHz-30MHz	B1702988-0008	2018.02.12	2019.02.12
5	Software	Frad	EZ-EMC	EMC-CON 3A1	\	\

## 4. EMC EMISSION TEST

### 4.1 CONDUCTED EMISSION MEASUREMENT

#### 4.1.1 POWER LINE CONDUCTED EMISSION Limits (Frequency Range 150KHz-30MHz)

FREQUENCY (MHz)	Limit (dBuV)		Standard
	Quas -peak	Average	
0.15 -0.5	66 - 56 *	56 - 46 *	FCC
0.50 -5.0	56.00	46.00	FCC
5.0 -30.0	60.00	50.00	FCC

Note:

- (1) The tighter limit applies at the band edges.
- (2) The limit of " \* " marked band means the limitation decreases linearly with the logarithm of the frequency in the range.

The following table is the setting of the receiver

Receiver Parameters	Setting
Attenuation	10 dB
Start Frequency	0.15 MHz
Stop Frequency	30 MHz
IF Bandwidth	9 kHz

#### 4.1.2 TEST PROCEDURE

- a. The EUT was placed 0.8 meters from the horizontal ground plane with EUT being connected to the power mains through a line impedance stabilization network (LISN). All other support equipments powered from additional LISN(s). The LISN provide 50 Ohm/ 50uH of coupling impedance for the measuring instrument.
- b. Interconnecting cables that hang closer than 40 cm to the ground plane shall be folded back and forth in the center forming a bundle 30 to 40 cm long.
- c. I/O cables that are not connected to a peripheral shall be bundled in the center. The end of the cable may be terminated, if required, using the correct terminating impedance. The overall length shall not exceed 1 m.
- d. LISN at least 80 cm from nearest part of EUT chassis.
- e. For the actual test configuration, please refer to the related Item –EUT Test Photos.

#### 4.1.3 DEVIATION FROM TEST STANDARD

No deviation

#### 4.1.4 TEST SETUP

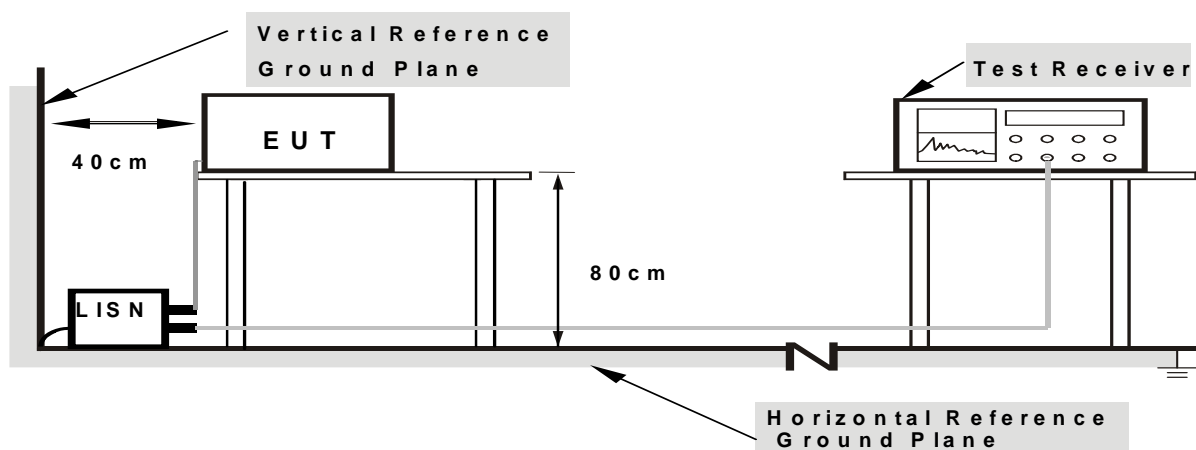

- Note:**
1. Support units were connected to second LISN.
  2. Both of LISNs (AMN) are 80 cm from EUT and at least 80 cm from other units and other metal planes

#### 4.1.5 EUT OPERATING CONDITIONS

The EUT was configured for testing in a typical fashion (as a customer would normally use it). The EUT has been programmed to continuously transmit during test. This operating condition was tested and used to collect the included data.

We pretest AC 120V and AC 240V, the worst voltage was AC 120V and the data recording in the report.

#### 4.1.6 TEST RESULTS

Temperature :	26°C	Relative Humidity :	54%
Pressure :	101kPa	Phase :	L
Test Voltage :	AC 120V/60Hz	Test Mode :	Mode 3

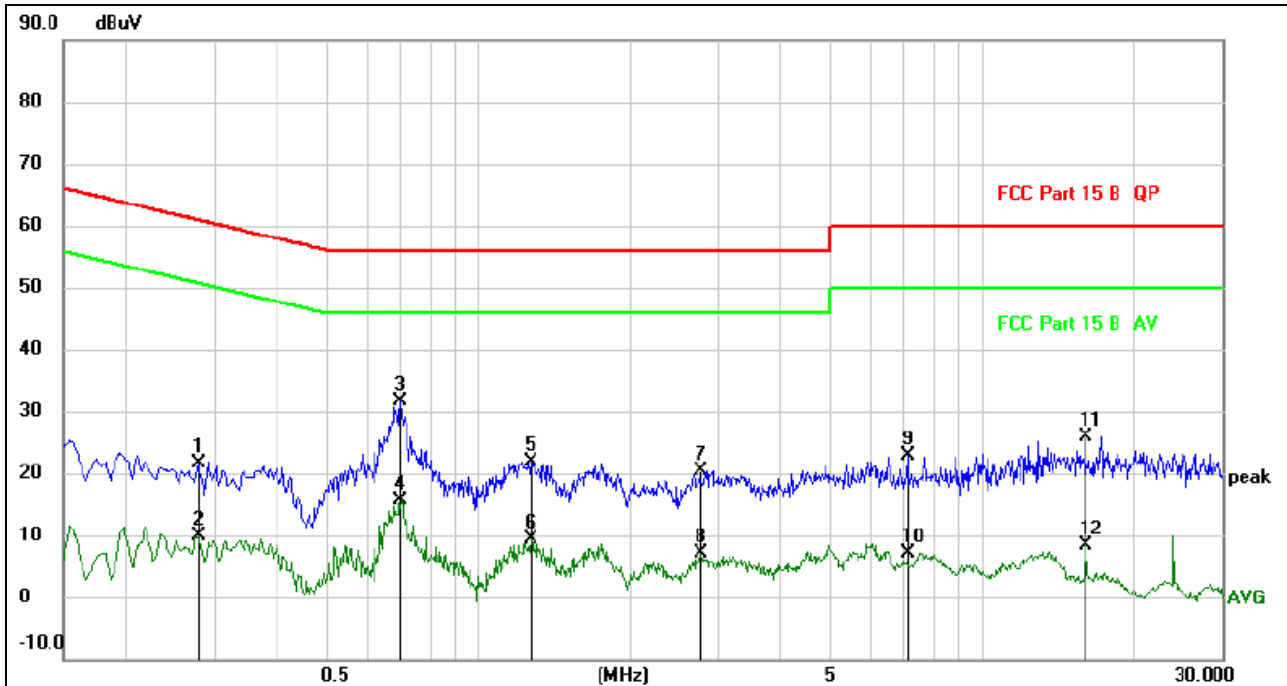
**Remark:**

1. All readings are Quasi-Peak and Average values.
2. Factor = Insertion Loss + Cable Loss.

No.	Mk.	Freq. MHz	Reading Level dBuV	Correct Factor	Measure- ment dBuV	Limit dBuV	Over dB	Detector	Comment
1		0.2779	11.98	9.55	21.53	60.88	-39.35	QP	
2		0.2779	0.27	9.55	9.82	50.88	-41.06	AVG	
3	*	0.6980	22.05	9.66	31.71	56.00	-24.29	QP	
4		0.6980	5.88	9.66	15.54	46.00	-30.46	AVG	
5		1.2700	12.27	9.58	21.85	56.00	-34.15	QP	
6		1.2700	-0.30	9.58	9.28	46.00	-36.72	AVG	
7		2.7700	10.79	9.64	20.43	56.00	-35.57	QP	
8		2.7700	-2.59	9.64	7.05	46.00	-38.95	AVG	
9		7.1300	13.10	9.72	22.82	60.00	-37.18	QP	
10		7.1300	-2.59	9.72	7.13	50.00	-42.87	AVG	
11		16.1380	16.23	9.72	25.95	60.00	-34.05	QP	
12		16.1380	-1.31	9.72	8.41	50.00	-41.59	AVG	

Temperature :	26℃	Relative Humidity :	54%
Pressure :	101kPa	Phase :	N
Test Voltage :	AC 120V/60Hz	Test Mode :	Mode 3

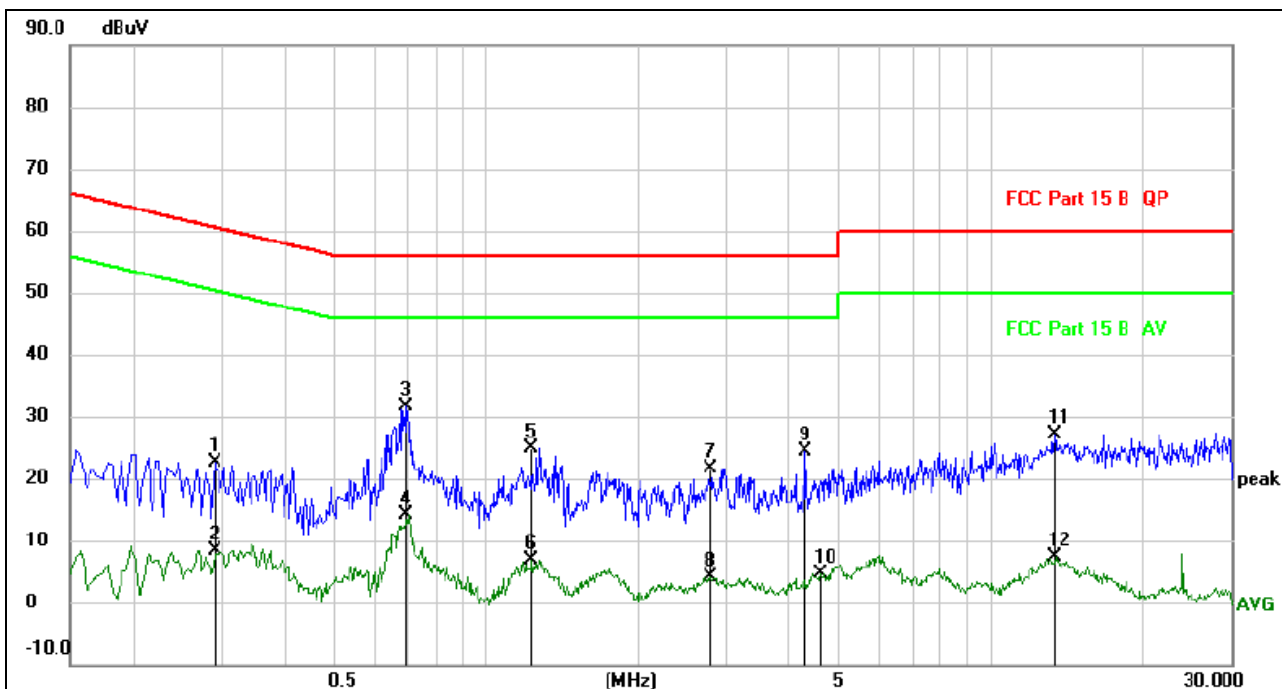
**Remark:**

1. All readings are Quasi-Peak and Average values.
2. Factor = Insertion Loss + Cable Loss.

No.	Mk.	Freq. MHz	Reading Level dBuV	Correct Factor	Measure- ment dBuV	Limit dBuV	Over dB	Detector	Comment
1		0.2900	13.09	9.57	22.66	60.52	-37.86	QP	
2		0.2900	-1.13	9.57	8.44	50.52	-42.08	AVG	
3	*	0.6940	22.00	9.67	31.67	56.00	-24.33	QP	
4		0.6940	4.36	9.67	14.03	46.00	-31.97	AVG	
5		1.2300	15.21	9.57	24.78	56.00	-31.22	QP	
6		1.2300	-2.57	9.57	7.00	46.00	-39.00	AVG	
7		2.7940	12.08	9.65	21.73	56.00	-34.27	QP	
8		2.7940	-5.56	9.65	4.09	46.00	-41.91	AVG	
9		4.2940	14.57	9.75	24.32	56.00	-31.68	QP	
10		4.6220	-5.03	9.77	4.74	46.00	-41.26	AVG	
11		13.3700	17.39	9.70	27.09	60.00	-32.91	QP	
12		13.3700	-2.37	9.70	7.33	50.00	-42.67	AVG	

## 4.2 RADIATED EMISSION MEASUREMENT

### 4.2.1 RADIATED EMISSION LIMITS (Frequency Range 9kHz-1000MHz)

20dBc in any 100 kHz bandwidth outside the operating frequency band. In case the emission fall within the restricted band specified on 15.205(a), then the 15.209(a) limit in the table below has to be followed.

Frequencies (MHz)	Field Strength (micorvolts/meter)	Measurement Distance (meters)
0.009~0.490	2400/F(KHz)	300
0.490~1.705	24000/F(KHz)	30
1.705~30.0	30	30
30~88	100	3
88~216	150	3
216~960	200	3
Above 960	500	3

### LIMITS OF RADIATED EMISSION MEASUREMENT (Above 1000MHz)

FREQUENCY (MHz)	Limit (dBuV/m) (at 3M)	
	PEAK	AVERAGE
Above 1000	74	54

Notes:

- (1) The limit for radiated test was performed according to FCC PART 15C.
- (2) The tighter limit applies at the band edges.
- (3) Emission level (dBuV/m)=20log Emission level (uV/m).

### FREQUENCY RANGE OF RADIATED MEASUREMENT (For unintentional radiators)

Highest frequency generated or Upper frequency of measurement used in the device or on which the device operates or tunes (MHz)	Range (MHz)
Below 1.705	30
1.705 – 108	1000
108 – 500	2000
500 – 1000	5000
Above 1000	5 <sup>th</sup> harmonic of the highest frequency or 40 GHz, whichever is lower

Spectrum Parameter	Setting
Attenuation	Auto
Start Frequency	1000 MHz
Stop Frequency	10th carrier harmonic
RB / VB (emission in restricted band)	1 MHz / 1 MHz for Peak, 1 MHz / 10Hz for Average

Receiver Parameter	Setting
Attenuation	Auto
Start ~ Stop Frequency	9kHz~150kHz / RB 200Hz for QP
Start ~ Stop Frequency	150kHz~30MHz / RB 9kHz for QP
Start ~ Stop Frequency	30MHz~1000MHz / RB 120kHz for QP

#### 4.2.2 TEST PROCEDURE

- a. The measuring distance of at 3 m shall be used for measurements at frequency up to 25GHz. For frequencies above 1GHz, any suitable measuring distance may be used.
- b. The EUT was placed on the top of a rotating table 0.8 and 1.5 meters above the ground at a 3 meter semi-chamber test. The table was rotated 360 degrees to determine the position of the highest radiation.
- c. The height of the equipment or of the substitution antenna shall be 0.8 m; above 1GHz, the height was 1.5m, the height of the test antenna shall vary between 1 m to 4 m. Both horizontal and vertical polarizations of the antenna are set to make the measurement.
- d. The initial step in collecting conducted emission data is a spectrum analyzer peak detector mode pre-scanning the measurement frequency range. Significant peaks are then marked and then Quasi Peak detector mode re-measured.
- e. If the Peak Mode measured value compliance with and lower than Quasi Peak Mode Limit, the EUT shall be deemed to meet QP Limits and then no additional QP Mode measurement performed.
- f. For the actual test configuration, please refer to the related Item –EUT Test Photos.
- g. For the radiated emission test above 1GHz:  
Place the measurement antenna away from each area of the EUT determined to be a source of emissions at the specified measurement distance, while keeping the measurement antenna aimed at the source of emissions at each frequency of significant emissions, with polarization oriented for maximum response.  
The measurement antenna may have to be higher or lower than the EUT, depending on the radiation pattern of the emission and staying aimed at the emission source for receiving the maximum signal. The final measurement antenna elevation shall be that which maximizes the emissions. The measurement antenna elevation for maximum emissions shall be restricted to a range of heights of from 1 m to 4 m above the ground or reference ground plane.  
Note:  
Both horizontal and vertical antenna polarities were tested and performed pretest to three orthogonal axis. The worst case emissions were reported

#### 4.2.3 DEVIATION FROM TEST STANDARD

No deviation

#### 4.2.4 TEST SETUP

(A) Radiated Emission Test-Up Frequency Below 30MHz

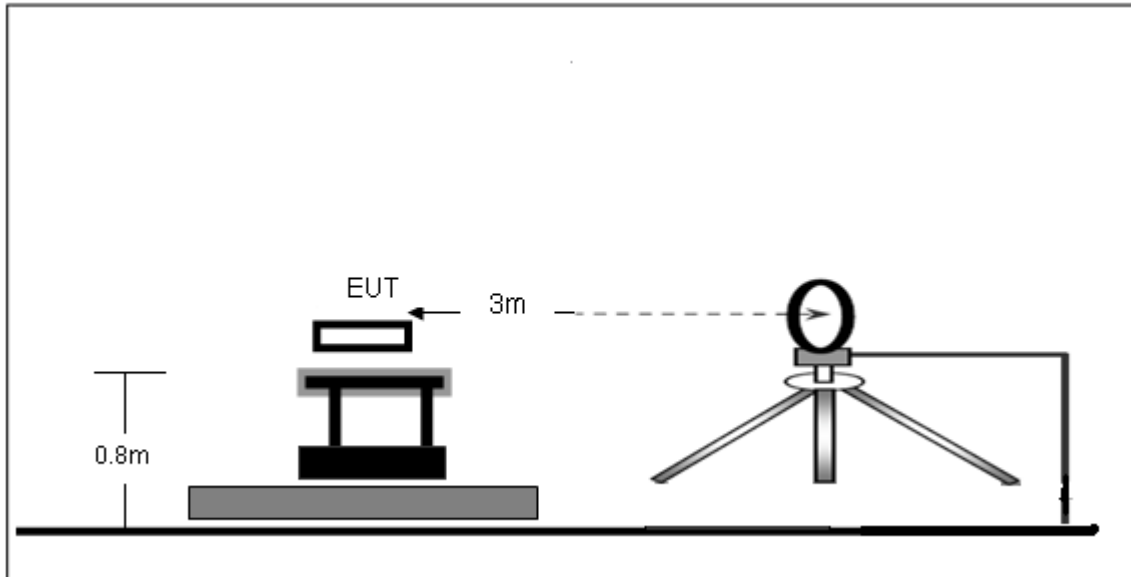

(B) Radiated Emission Test-Up Frequency 30MHz~1GHz

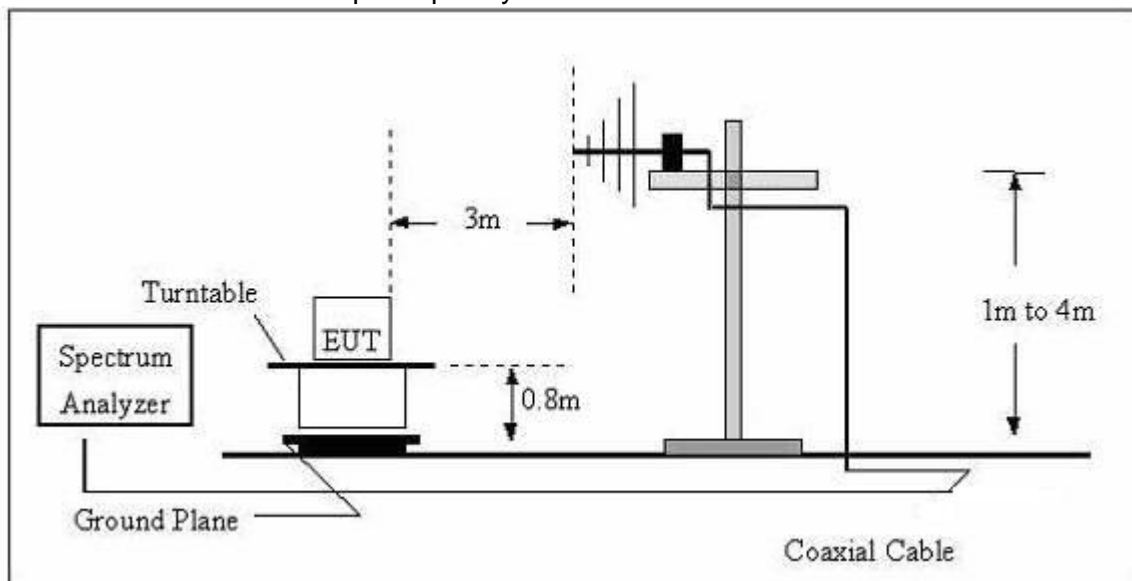



(C) Radiated Emission Test-Up Frequency Above 1GHz

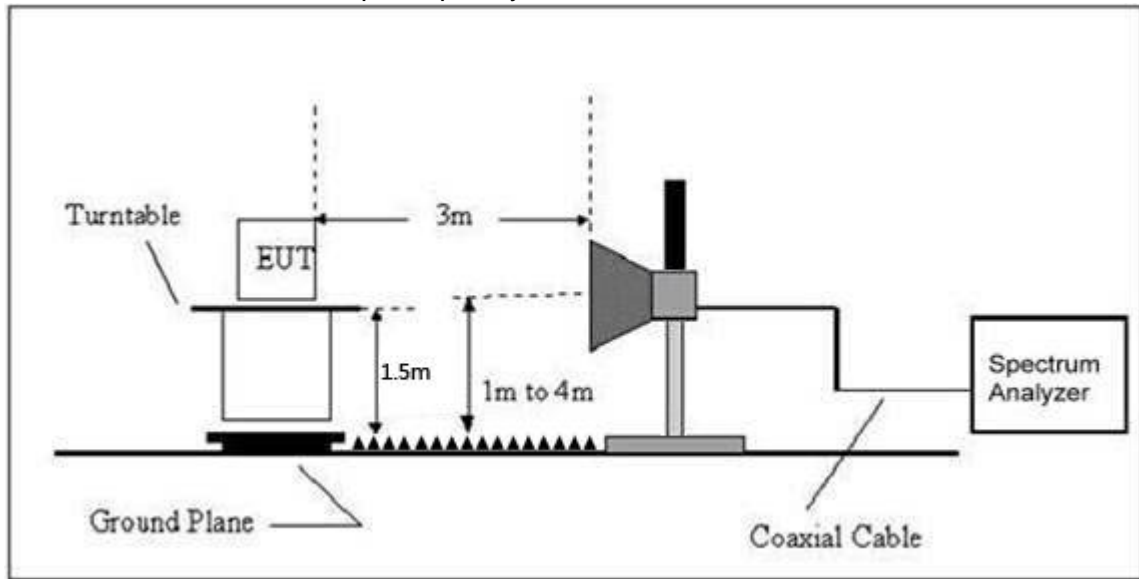

**4.2.5 EUT OPERATING CONDITIONS**

The EUT tested system was configured as the statements of 2.4 Unless otherwise a special operating condition is specified in the follows during the testing.

#### 4.2.6 TEST RESULTS

Radiated Spurious Emission (Below 30MHz )

Temperature :	26 °C	Relative Humidity :	54%
Pressure :	101 kPa	Polarization :	---
Test Voltage :	DC 3.85V		
Test Mode :	Mode 3		

Freq.	Reading	Limit	Margin	State
(MHz)	(dBuV/m)	(dBuV/m)	(dB)	P/F
--	--	--	--	PASS
--	--	--	--	PASS

**NOTE:**

The amplitude of spurious emissions which are attenuated by more than 20dB below the permissible value has no need to be reported.

Distance extrapolation factor =  $40 \log(\text{specific distance}/\text{test distance})$ (dB);

Limit line = specific limits(dBuv) + distance extrapolation factor.

## Radiated Spurious Emission (Between 30MHz – 1GHz)

Temperature :	26 °C	Relative Humidity :	54%
Pressure :	101 kPa	Polarization :	Horizontal
Test Voltage :	DC 3.85V		
Test Mode : (Worst)	Mode 3		

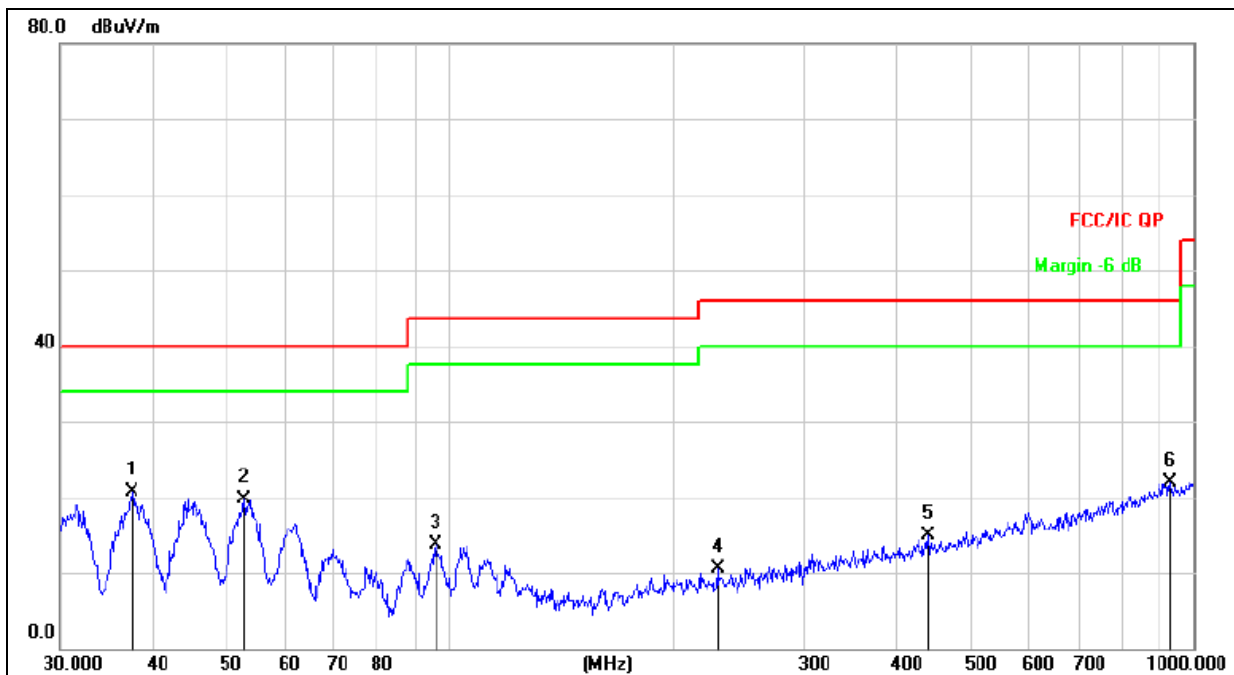

Remark:

Factor = Antenna Factor + Cable Loss – Pre-amplifier.

No.	Mk.	Freq. MHz	Reading Level dBuV	Correct Factor dB	Measure- ment dBuV/m	Limit dB/m	Over dB	Detector
1	*	37.4165	36.55	-15.89	20.66	40.00	-19.34	QP
2		52.9453	34.80	-15.16	19.64	40.00	-20.36	QP
3		95.7622	30.73	-17.05	13.68	43.50	-29.82	QP
4		229.2931	26.14	-15.63	10.51	46.00	-35.49	QP
5		440.1963	25.12	-10.19	14.93	46.00	-31.07	QP
6		929.0082	23.10	-1.27	21.83	46.00	-24.17	QP

Temperature :	26 °C	Relative Humidity :	54%
Pressure :	101 kPa	Polarization :	Vertical
Test Voltage :	DC 3.85V		
Test Mode : (Worst)	Mode 3		

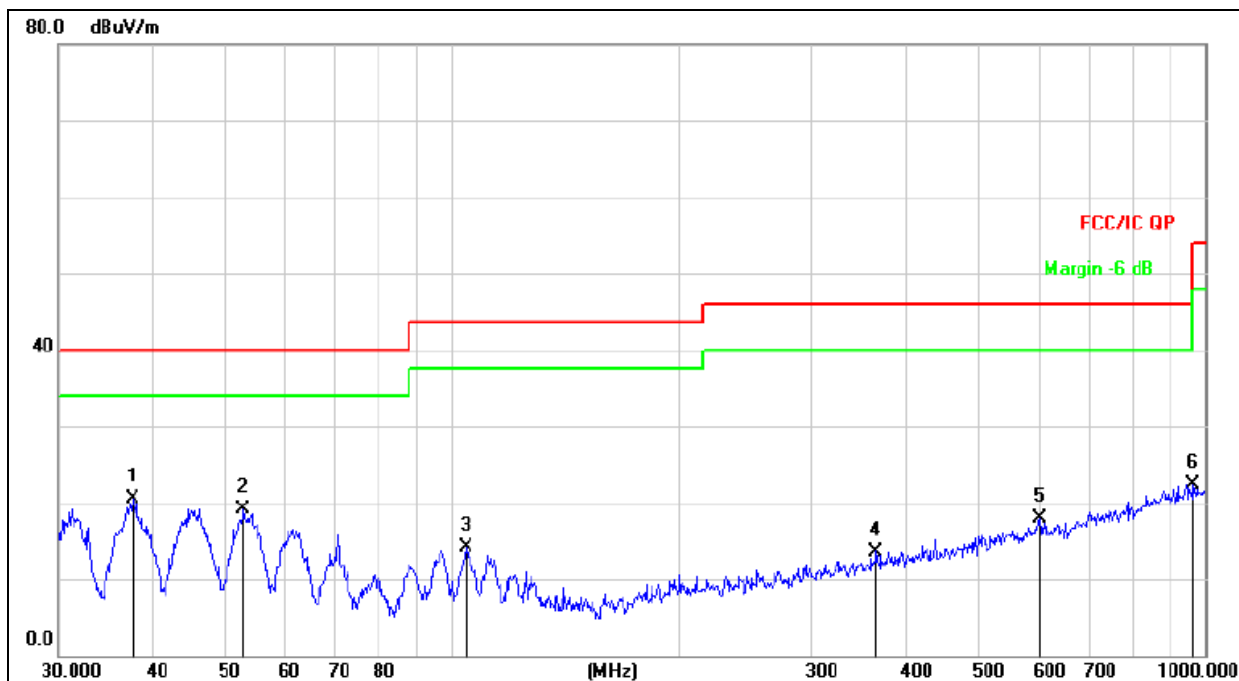

Remark:

Factor = Antenna Factor + Cable Loss – Pre-amplifier.

No.	Mk.	Freq.	Reading Level	Correct Factor	Measurement	Limit	Over	
		MHz	dBuV	dB	dBuV/m	dB/m	dB	Detector
1	*	37.6798	36.33	-15.84	20.49	40.00	-19.51	QP
2		52.7600	34.21	-15.14	19.07	40.00	-20.93	QP
3		104.1701	30.62	-16.55	14.07	43.50	-29.43	QP
4		365.5391	25.48	-11.88	13.60	46.00	-32.40	QP
5		601.4265	24.50	-6.53	17.97	46.00	-28.03	QP
6		962.1623	23.40	-1.04	22.36	54.00	-31.64	QP

Radiated Spurious Emission ( 1GHz to 10<sup>th</sup> harmonics)

## GFSK

Polar (H/V)	Frequency	Meter Reading	Pre-amplifier	Cable Loss	Antenna Factor	Emission Level	Limits	Margin	Detector Type
	(MHz)	(dBuV)	(dB)	(dB)	(dB/m)	(dBuV/m)	(dBuV/m)	(dB)	
Low Channel 2402MHz									
V	2402.00	106.21	38.06	7.42	20.15	95.72	114.00	-18.28	PK
V	2402.00	90.63	38.06	7.42	20.15	80.14	94.00	-13.86	AV
V	4804.00	51.25	38.53	7.78	23.25	43.75	74.00	-30.25	PK
V	4804.00	43.22	38.53	7.78	23.25	35.72	54.00	-18.28	AV
V	16132.00	44.35	38.75	10.36	26.57	42.53	74.00	-31.47	PK
H	2402.00	106.10	38.06	7.42	20.15	95.61	114.00	-18.39	PK
H	2402.00	91.28	38.06	7.42	20.15	80.79	94.00	-13.21	AV
H	4804.00	51.46	38.53	7.78	23.25	43.96	74.00	-30.04	PK
H	4804.00	42.20	38.53	7.78	23.25	34.70	54.00	-19.30	AV
H	16132.00	45.84	38.75	10.36	26.57	44.02	74.00	-29.98	PK
Middle Channel 2441MHz									
V	2441.00	107.37	38.11	7.44	20.36	97.06	114.00	-16.94	PK
V	2441.00	91.62	38.11	7.44	20.36	81.31	94.00	-12.69	AV
V	4882.00	51.96	38.65	7.80	23.61	44.72	74.00	-29.28	PK
V	4882.00	41.58	38.65	7.80	23.61	34.34	54.00	-19.66	AV
V	16132.00	46.24	38.75	10.36	26.57	44.42	74.00	-29.58	PK
H	2441.00	107.92	38.11	7.44	20.36	97.61	114.00	-16.39	PK
H	2441.00	92.82	38.11	7.44	20.36	82.51	94.00	-11.49	AV
H	4882.00	50.79	38.65	7.80	23.61	43.55	74.00	-30.45	PK
H	4882.00	40.88	38.65	7.80	23.61	33.64	54.00	-20.36	AV
H	16132.00	46.29	38.75	10.36	26.57	44.47	74.00	-29.53	PK
High Channel 2480MHz									
V	2480.00	105.14	38.17	7.47	20.51	94.95	114.00	-19.05	PK
V	2480.00	88.06	38.17	7.47	20.51	77.87	94.00	-16.13	AV
V	4960.00	52.76	38.69	7.83	23.83	45.73	74.00	-28.27	PK
V	4960.00	45.33	38.69	7.83	23.83	38.30	54.00	-15.70	AV
V	16132.00	42.43	38.75	10.36	26.57	40.61	74.00	-33.39	PK
H	2480.00	105.11	38.17	7.47	20.51	94.92	114.00	-19.08	PK
H	2480.00	87.24	38.17	7.47	20.51	77.05	94.00	-16.95	AV
H	4960.00	53.65	38.69	7.83	23.83	46.62	74.00	-27.38	PK
H	4960.00	45.83	38.69	7.83	23.83	38.80	54.00	-15.20	AV
H	16132.00	41.78	38.75	10.36	26.57	39.96	74.00	-34.04	PK

## Remark:

1. Emission Level = Meter Reading + Antenna Factor + Cable Loss – Pre-amplifier,  
Margin= Emission Level - Limit
2. If peak below the average limit, the average emission was no test.
3. The amplitude of spurious emissions which are attenuated by more than 20dB below the permissible value has no need to be reported.

**PI/4 DPSK**

Polar (H/V)	Frequency (MHz)	Meter Reading (dBuV)	Pre-amplifier (dB)	Cable Loss (dB)	Antenna Factor (dB/m)	Emission Level (dBuV/m)	Limits (dBuV/m)	Margin (dB)	Detector Type
<b>Low Channel 2402MHz</b>									
V	2402.00	106.27	38.06	7.42	20.15	95.78	114.00	-18.22	PK
V	2402.00	90.65	38.06	7.42	20.15	80.16	94.00	-13.84	AV
V	4804.00	51.23	38.53	7.78	23.25	43.73	74.00	-30.27	PK
V	4804.00	43.21	38.53	7.78	23.25	35.71	54.00	-18.29	AV
V	16132.00	44.37	38.75	10.36	26.57	42.55	74.00	-31.45	PK
H	2402.00	106.42	38.06	7.42	20.15	95.93	114.00	-18.07	PK
H	2402.00	89.33	38.06	7.42	20.15	78.84	94.00	-15.16	AV
H	4804.00	50.33	38.53	7.78	23.25	42.83	74.00	-31.17	PK
H	4804.00	44.01	38.53	7.78	23.25	36.51	54.00	-17.49	AV
H	16132.00	43.47	38.75	10.36	26.57	41.65	74.00	-32.35	PK
<b>Middle Channel 2441MHz</b>									
V	2441.00	107.37	38.11	7.44	20.36	97.06	114.00	-16.94	PK
V	2441.00	90.79	38.11	7.44	20.36	80.48	94.00	-13.52	AV
V	4882.00	49.40	38.65	7.80	23.61	42.16	74.00	-31.84	PK
V	4882.00	45.71	38.65	7.80	23.61	38.47	54.00	-15.53	AV
V	16132.00	43.37	38.75	10.36	26.57	41.55	74.00	-32.45	PK
H	2441.00	108.24	38.11	7.44	20.36	97.93	114.00	-16.07	PK
H	2441.00	89.33	38.11	7.44	20.36	79.02	94.00	-14.98	AV
H	4882.00	50.76	38.65	7.80	23.61	43.52	74.00	-30.48	PK
H	4882.00	44.99	38.65	7.80	23.61	37.75	54.00	-16.25	AV
H	16132.00	42.03	38.75	10.36	26.57	40.21	74.00	-33.79	PK
<b>High Channel 2480MHz</b>									
V	2480.00	107.66	38.17	7.47	20.51	97.47	114.00	-16.53	PK
V	2480.00	89.77	38.17	7.47	20.51	79.58	94.00	-14.42	AV
V	4960.00	48.27	38.69	7.83	23.83	41.24	74.00	-32.76	PK
V	4960.00	46.53	38.69	7.83	23.83	39.50	54.00	-14.50	AV
V	16132.00	44.45	38.75	10.36	26.57	42.63	74.00	-31.37	PK
H	2480.00	106.62	38.17	7.47	20.51	96.43	114.00	-17.57	PK
H	2480.00	88.82	38.17	7.47	20.51	78.63	94.00	-15.37	AV
H	4960.00	49.21	38.69	7.83	23.83	42.18	74.00	-31.82	PK
H	4960.00	47.13	38.69	7.83	23.83	40.10	54.00	-13.90	AV
H	16132.00	43.29	38.75	10.36	26.57	41.47	74.00	-32.53	PK

**Remark:**

1. Emission Level = Meter Reading + Antenna Factor + Cable Loss – Pre-amplifier,  
Margin= Emission Level - Limit
2. If peak below the average limit, the average emission was no test.
3. The amplitude of spurious emissions which are attenuated by more than 20dB below the permissible value has no need to be reported.

**CONDUCTED EMISSION MEASUREMENT**

GFSK

Low Channel 2402MHz

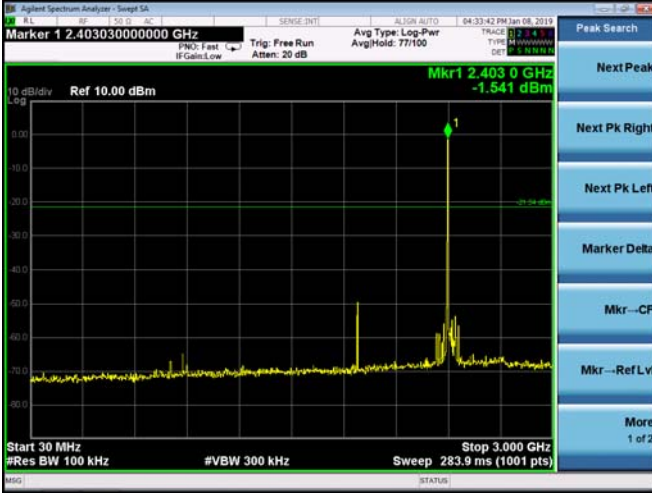

Middle Channel 2441MHz

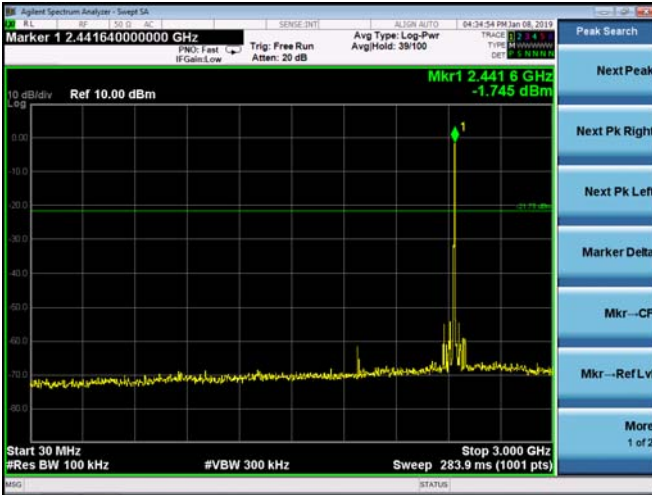

High Channel 2480MHz

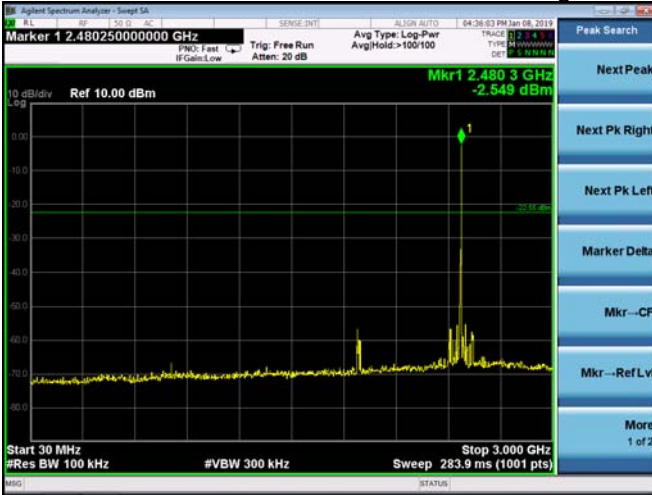

PI/4 DPSK

Low Channel 2402MHz

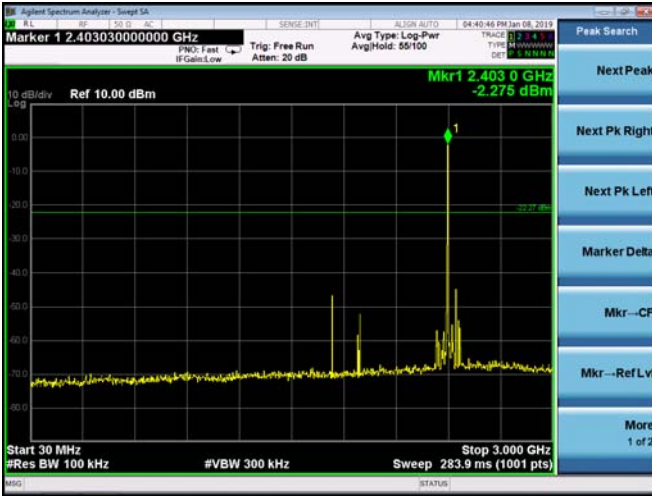

Middle Channel 2441MHz

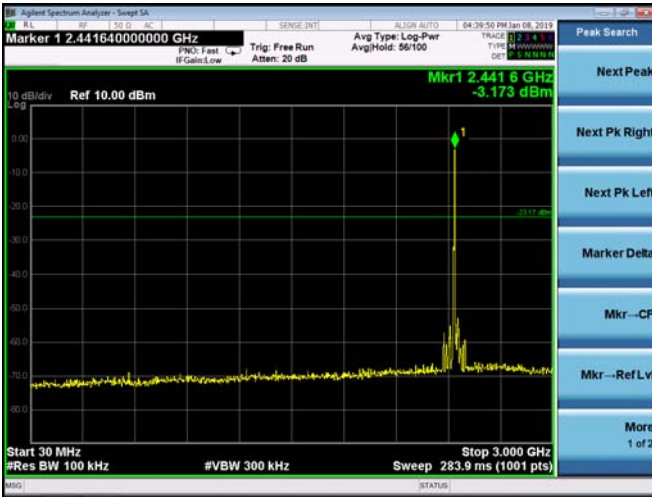

High Channel 2480MHz

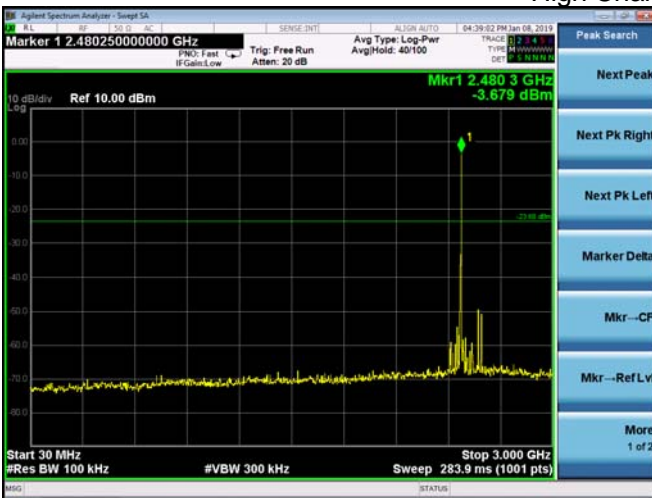



## 5. BANDWIDTH TEST

### 5.1 APPLIED PROCEDURES / LIMIT

FCC Part15 (15.249) , Subpart C				
Section	Test Item	Limit	Frequency Range (MHz)	Result
15.249	Bandwidth	(20dB bandwidth)	2400-2483.5	PASS

Spectrum Parameter	Setting
Attenuation	Auto
Span Frequency	> Measurement Bandwidth or Channel Separation
RB	100KHz
VB	$\geq$ RBW
Detector	Peak
Trace	Max Hold
Sweep Time	Auto

#### 5.1.1 TEST PROCEDURE

- a. The EUT was directly connected to the spectrum analyzer and antenna output port as show in the block diagram below,
- b. Spectrum Setting : RBW= 100KHz, VBW $\geq$  RBW, Sweep time = Auto.

#### 5.1.2 DEVIATION FROM STANDARD

No deviation.

#### 5.1.3 TEST SETUP



#### 5.1.4 EUT OPERATION CONDITIONS

The EUT tested system was configured as the statements of 2.4 Unless otherwise a special operating condition is specified in the follows during the testing.

**5.1.5 TEST RESULTS**

Temperature :	26 °C	Relative Humidity :	54%
Pressure :	101 kPa	Test Voltage :	DC 3.85V
Test Mode :	CH00/CH39/C78		

	Frequency	20dB Bandwidth (kHz)	Result
GFSK	2402 MHz	1063	<b>PASS</b>
	2441 MHz	1063	<b>PASS</b>
	2480 MHz	1064	<b>PASS</b>
PI/4 DPSK	2402 MHz	1345	<b>PASS</b>
	2441 MHz	1345	<b>PASS</b>
	2480 MHz	1340	<b>PASS</b>

GFSK

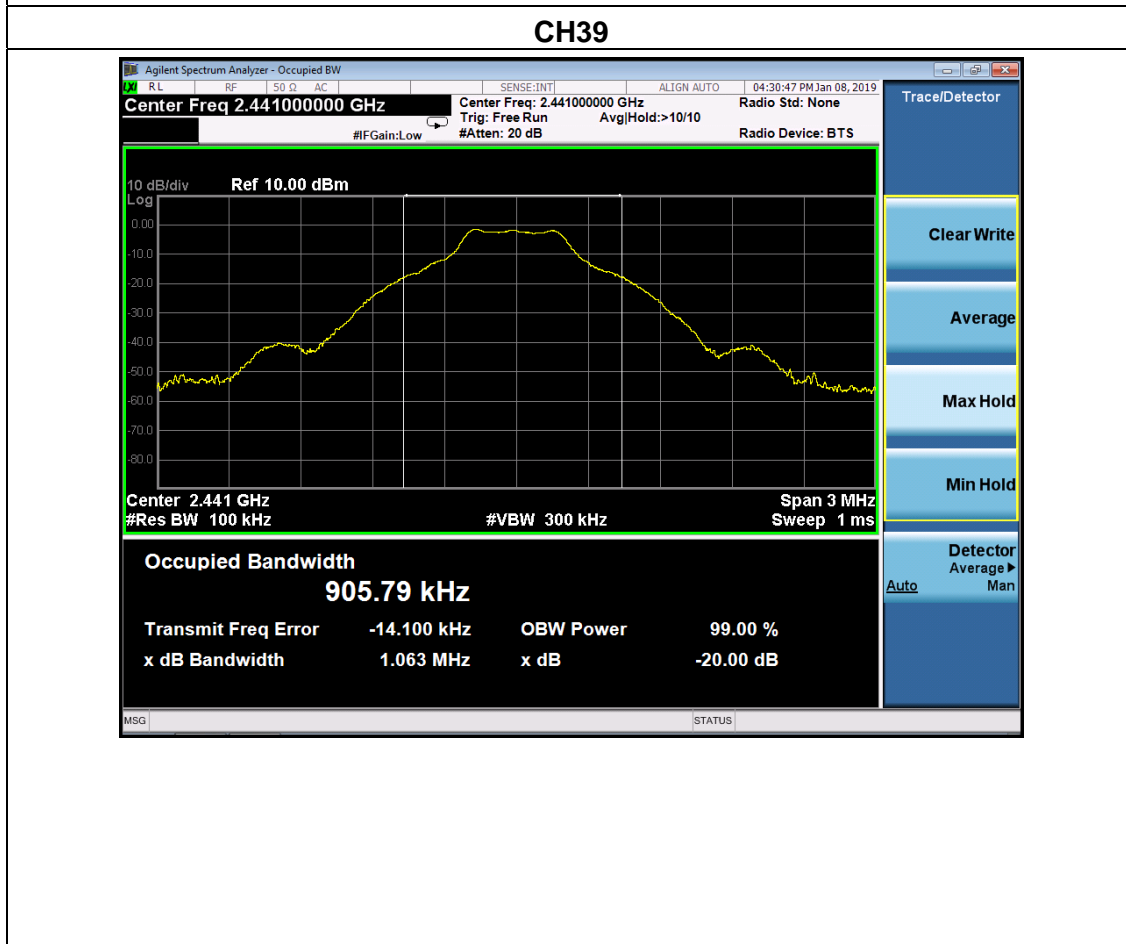
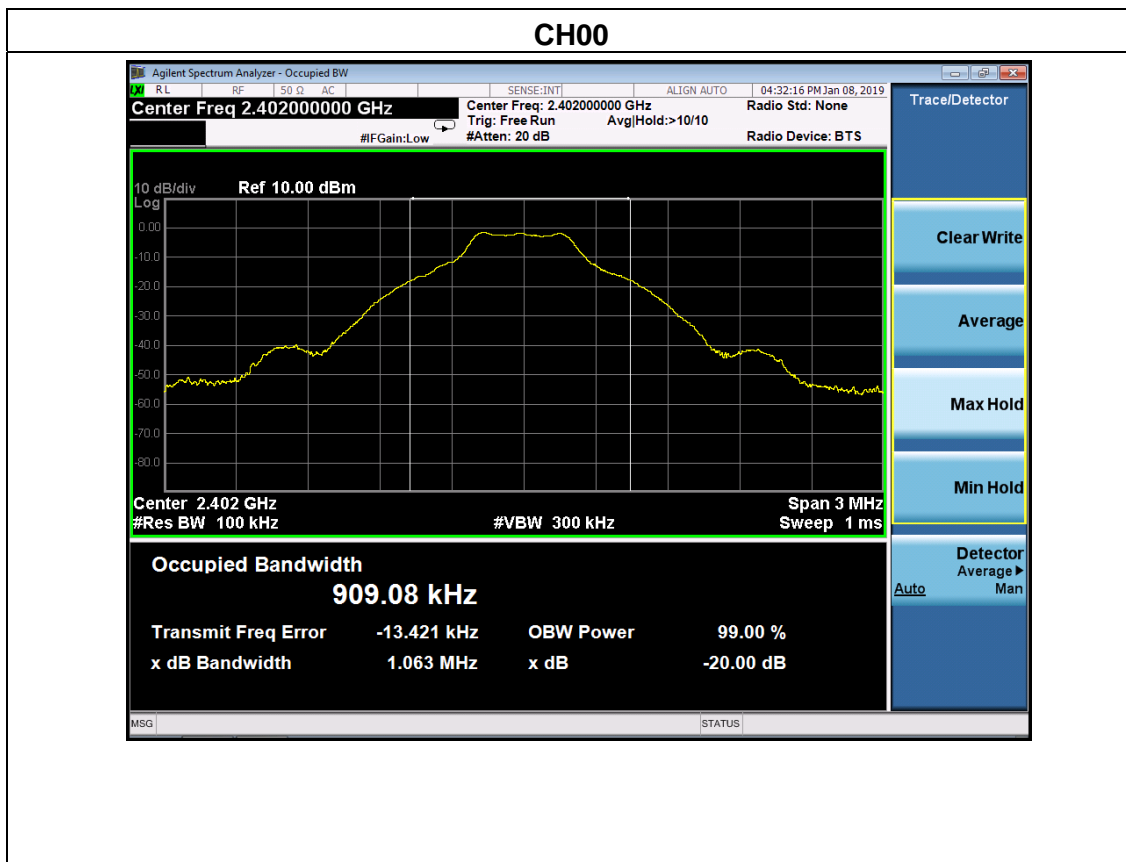

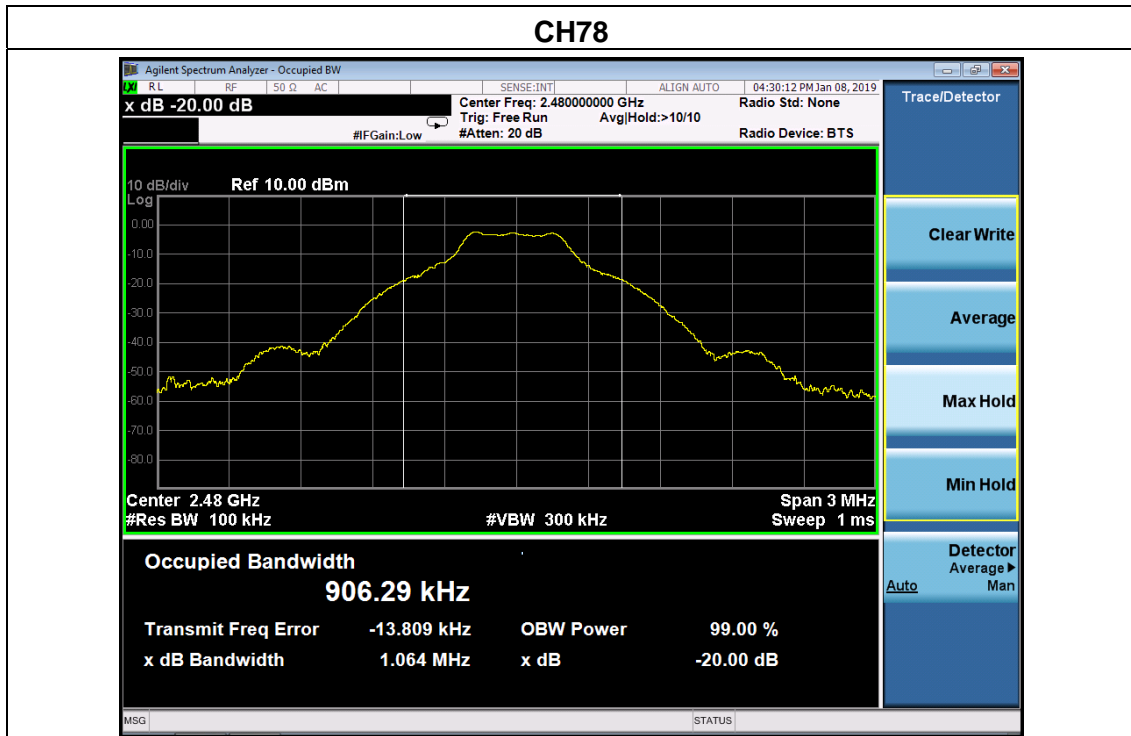

PI/4 DPSK

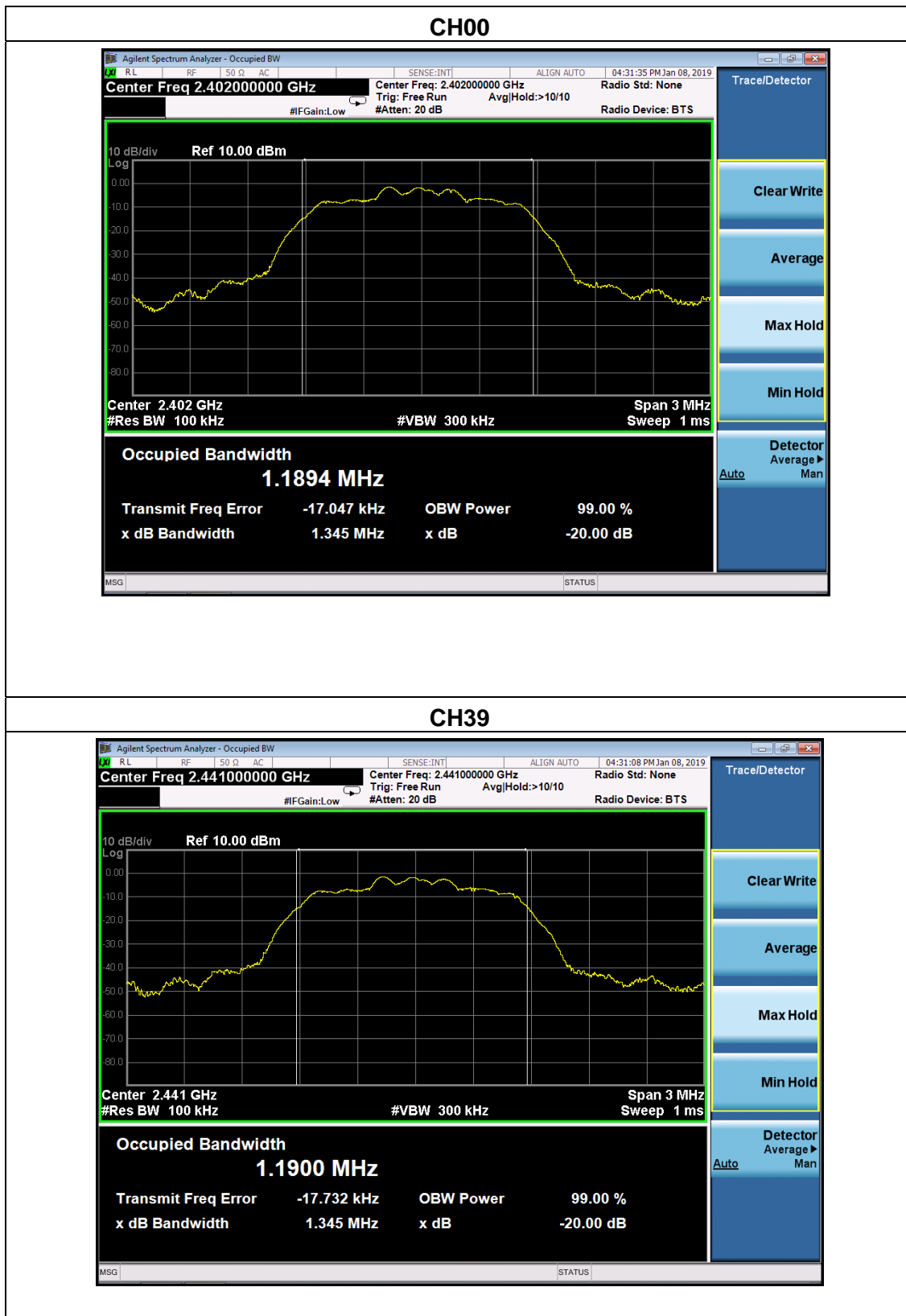
**CH39**

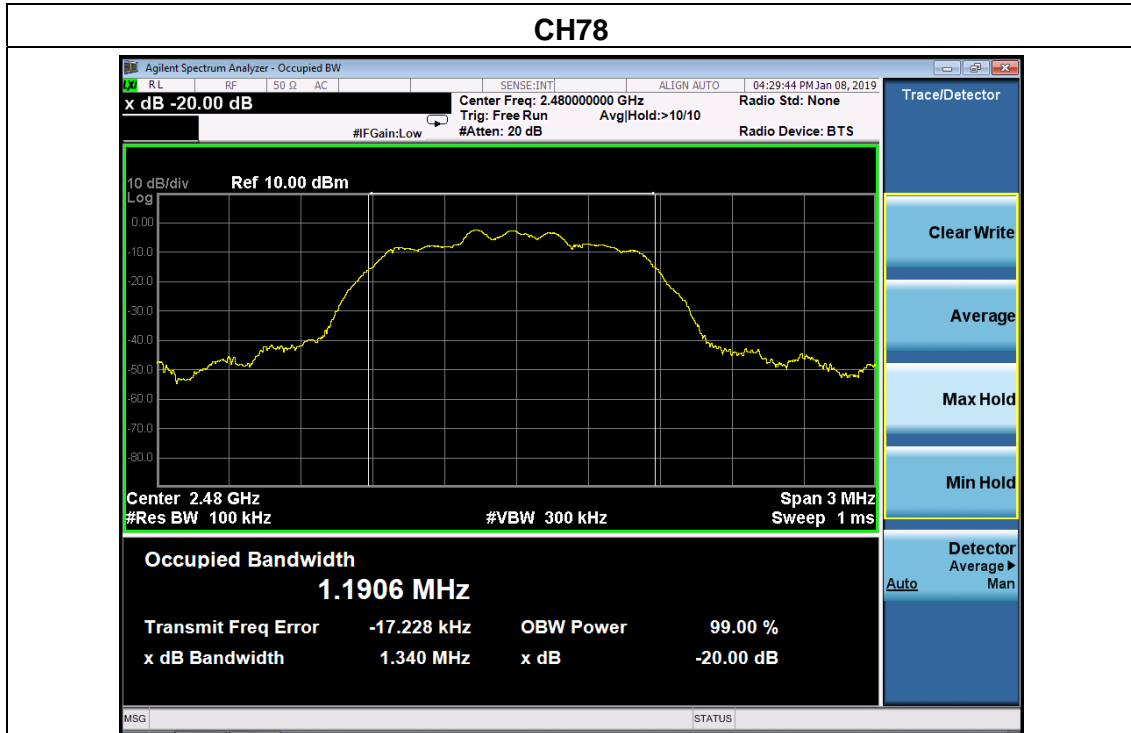

## **6. 100 KHZ BANDWIDTH OF FREQUENCY BAND EDGE APPLICABLE STANDARD**

Emissions radiated outside of the specified frequency bands, except for harmonics, shall be attenuated by at least 50 dB below the level of the fundamental or to the general radiated emission limits in § 15.209, whichever is the lesser attenuation

### **TEST PROCEDURE**

- a) Check the calibration of the measuring instrument using either an internal calibrator or a known signal from an external generator.
- b) Position the EUT without connection to measurement instrument. Turn on the EUT and connect its antenna terminal to measurement instrument via a low loss cable. Then set it to any one measured frequency within its operating range, and make sure the instrument is operated in its linear range.
- c) i) VBW for Peak, Quasi-peak, or Average Detector Function:  $3 \times \text{RBW}$
- d) Repeat above procedures until all measured frequencies were complete.

Note:

Both horizontal and vertical antenna polarities were tested and performed pretest to three orthogonal axis. The worst case emissions were reported

### **6.1 DEVIATION FROM STANDARD**

No deviation.

### **6.2 TEST SETUP**

### **6.3 EUT OPERATION CONDITIONS**

The EUT tested system was configured as the statements of 2.4 Unless otherwise a special operating condition is specified in the follows during the testing.

### 6.4 TEST RESULTS

Temperature :	26 °C	Relative Humidity :	54%
Pressure :	101 kPa	Test Voltage :	DC 3.85V
Test Mode :	CH00/CH78		

	Polar (H/V)	Frequency (MHz)	Meter Reading (dBuV)	Pre-amplifier (dB)	Cable Loss (dB)	Antenna Factor (dB/m)	Emission level (dBuV/m)	Limits (dBuV/m)		Result
							PK	PK	AV	
GFSK	Low Channel 2402MHz									
	H	2390.00	61.84	38.06	7.42	20.15	51.35	74.00	54.00	PASS
	H	2400.00	54.61	38.06	7.42	20.15	44.12	74.00	54.00	PASS
	V	2390.00	62.73	38.06	7.42	20.15	52.24	74.00	54.00	PASS
	V	2400.00	55.34	38.06	7.42	20.15	44.85	74.00	54.00	PASS
	High Channel 2480MHz									
	H	2483.50	61.72	38.17	7.45	20.54	51.54	74.00	54.00	PASS
	H	2485.50	55.61	38.17	7.45	20.54	45.43	74.00	54.00	PASS
	V	2483.50	63.23	38.2	7.45	20.54	53.02	74.00	54.00	PASS
	V	2485.50	53.39	38.2	7.45	20.54	43.18	74.00	54.00	PASS
PI/4 DPSK	Low Channel 2402MHz									
	H	2390.00	60.56	38.06	7.42	20.15	50.07	74.00	54.00	PASS
	H	2400.00	52.83	38.06	7.42	20.15	42.34	74.00	54.00	PASS
	V	2390.00	63.11	38.06	7.42	20.15	52.62	74.00	54.00	PASS
	V	2400.00	54.99	38.06	7.42	20.15	44.50	74.00	54.00	PASS
	High Channel 2480MHz									
	H	2483.50	63.26	38.17	7.45	20.54	53.08	74.00	54.00	PASS
	H	2485.50	52.59	38.17	7.45	20.54	42.41	74.00	54.00	PASS
	V	2483.50	62.96	38.2	7.45	20.54	52.75	74.00	54.00	PASS
	V	2485.50	54.09	38.2	7.45	20.54	43.88	74.00	54.00	PASS

**Remark:**

1. Emission Level = Meter Reading + Antenna Factor + Cable Loss – Pre-amplifier, Margin= Emission Level - Limit
2. If the PK measured levels comply with average limit, then the average level were deemed to comply with average limit.



GFSK

2402MHz Horizontal

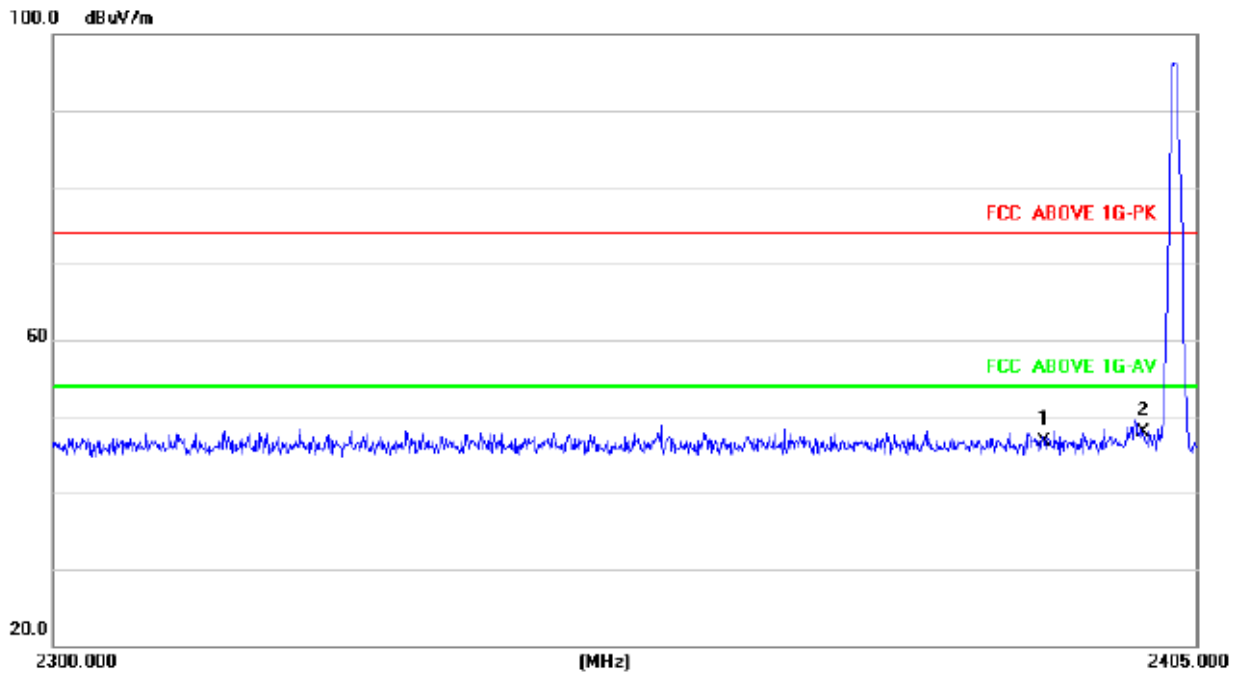

2402MHz Vertical

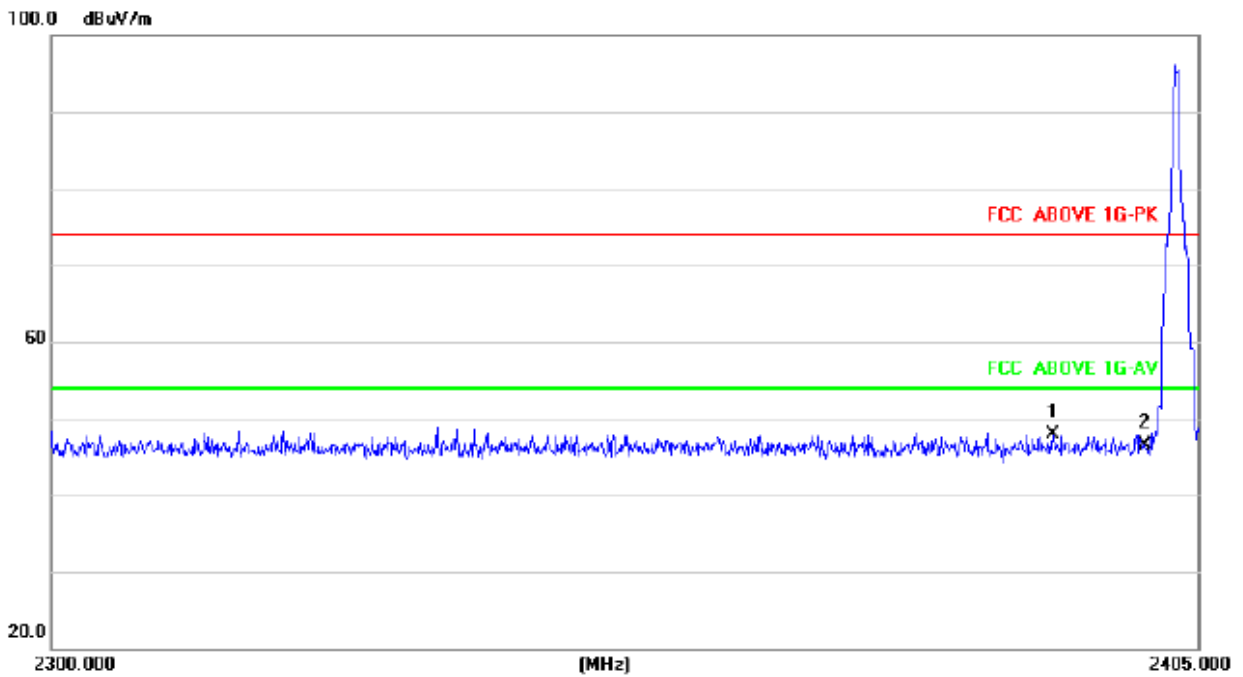

2480MHz Horizontal

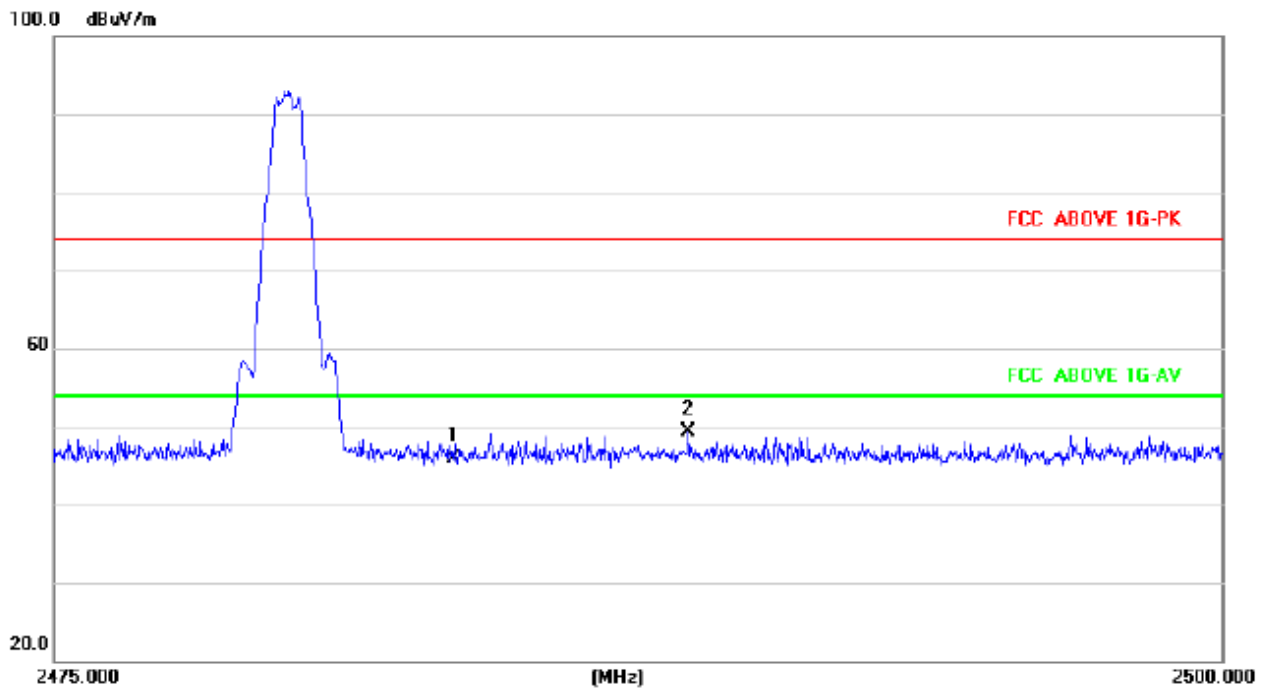

2480MHz Vertical

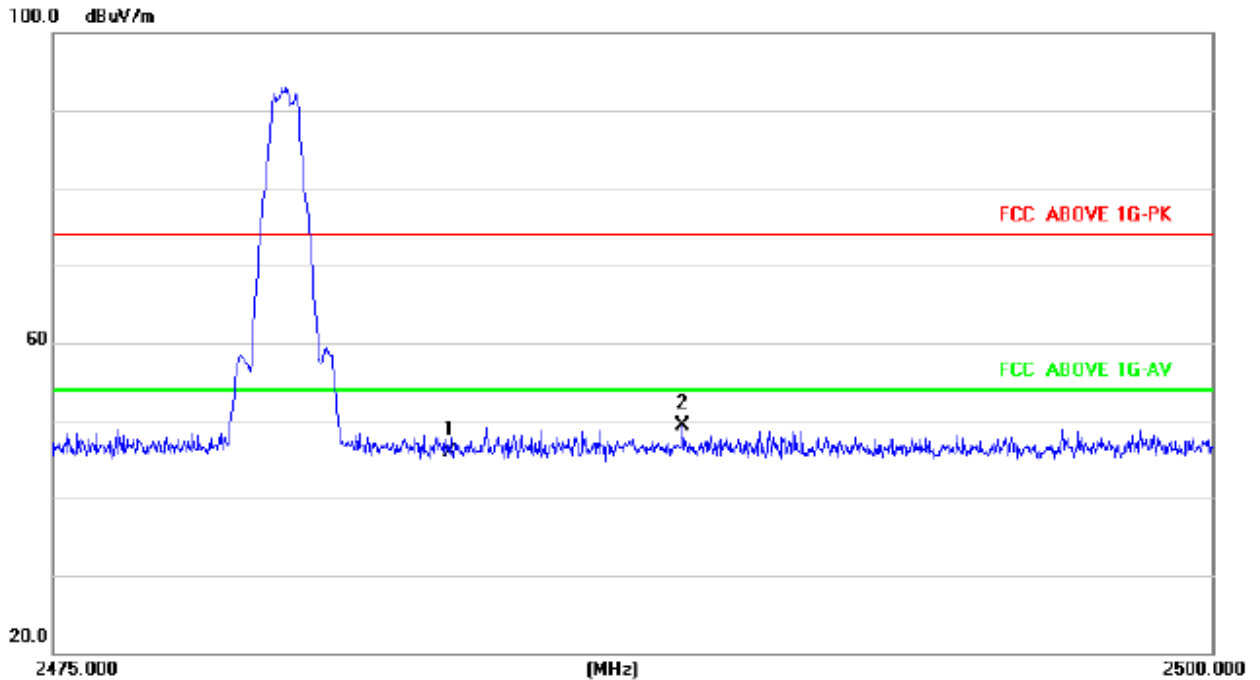

PI/4 DPSK

2402MHz Horizontal

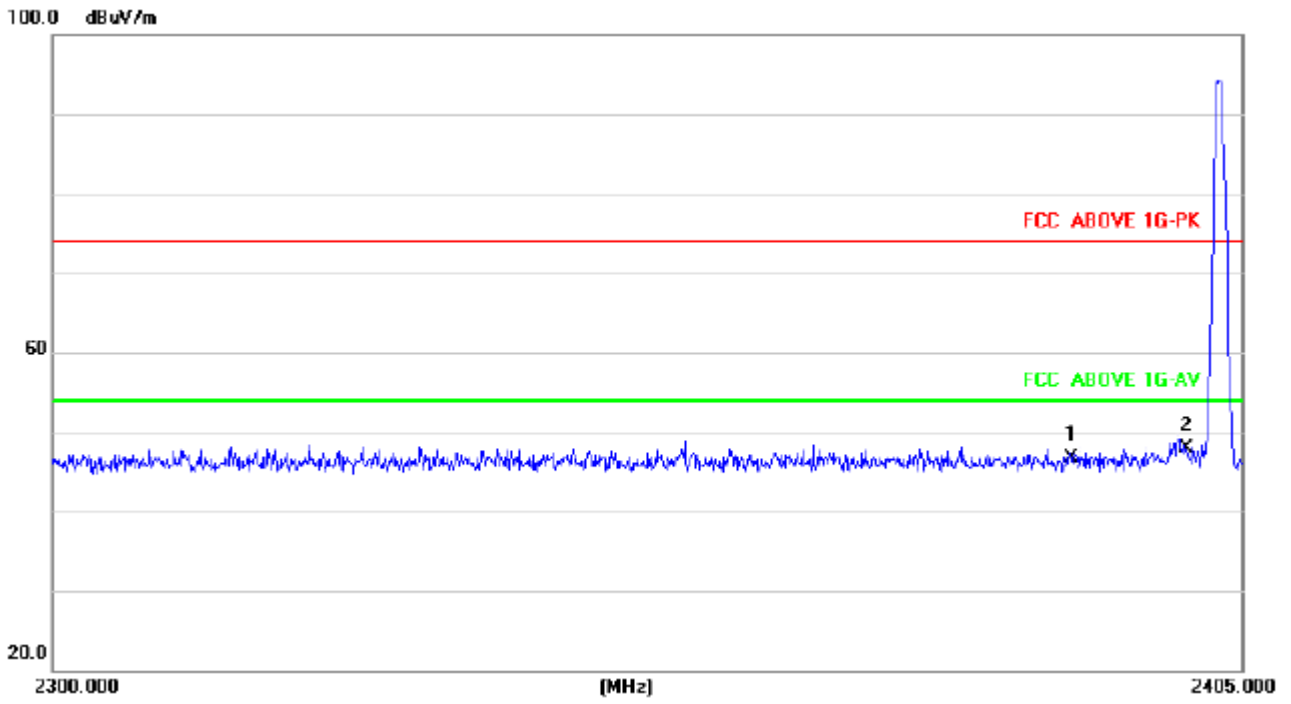

2402MHz Vertical

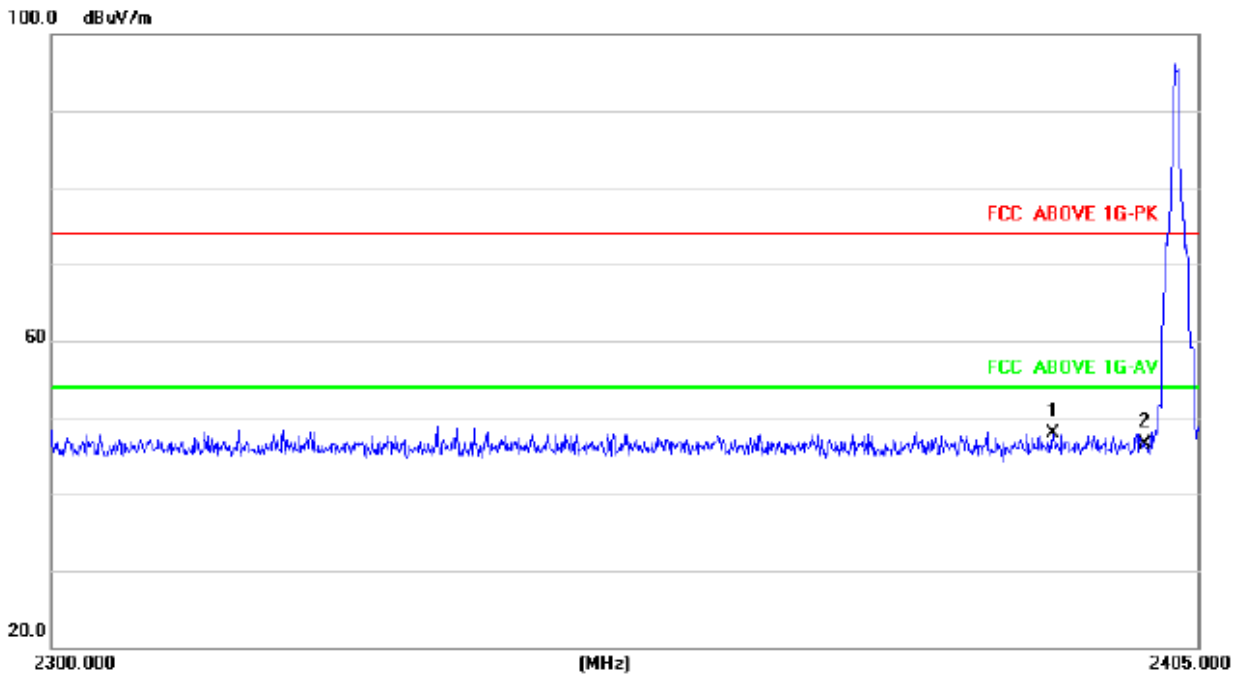

2480MHz Horizontal

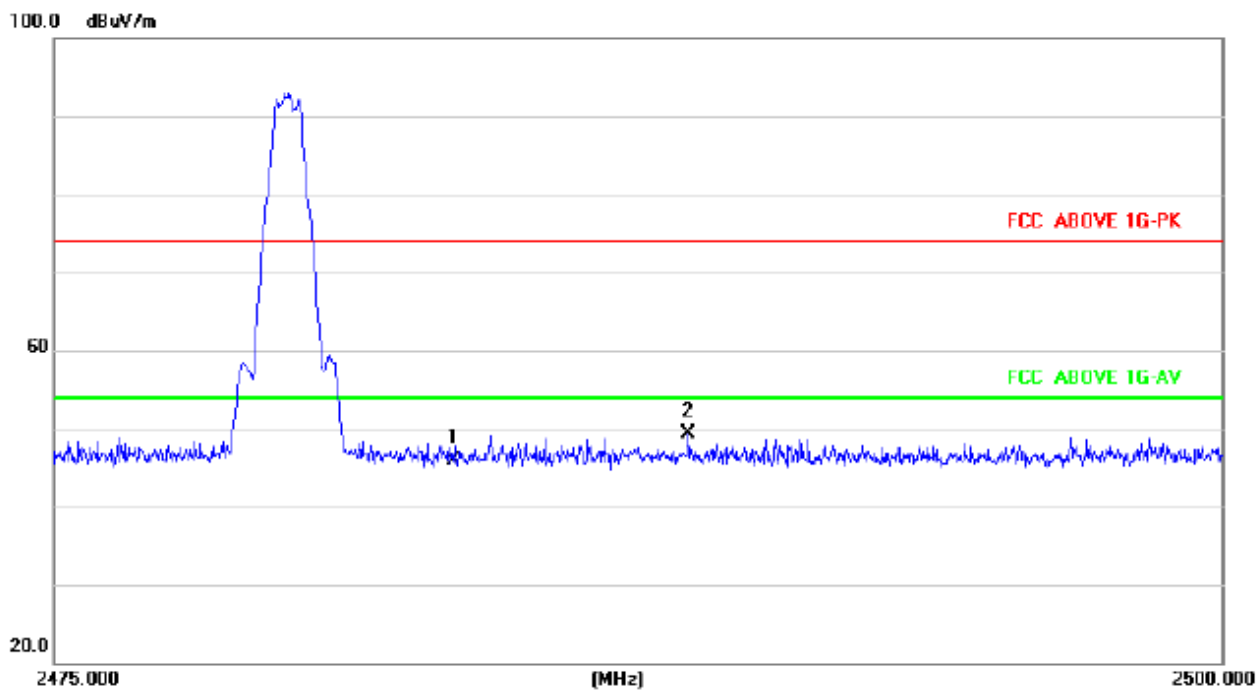

2480MHz Vertical

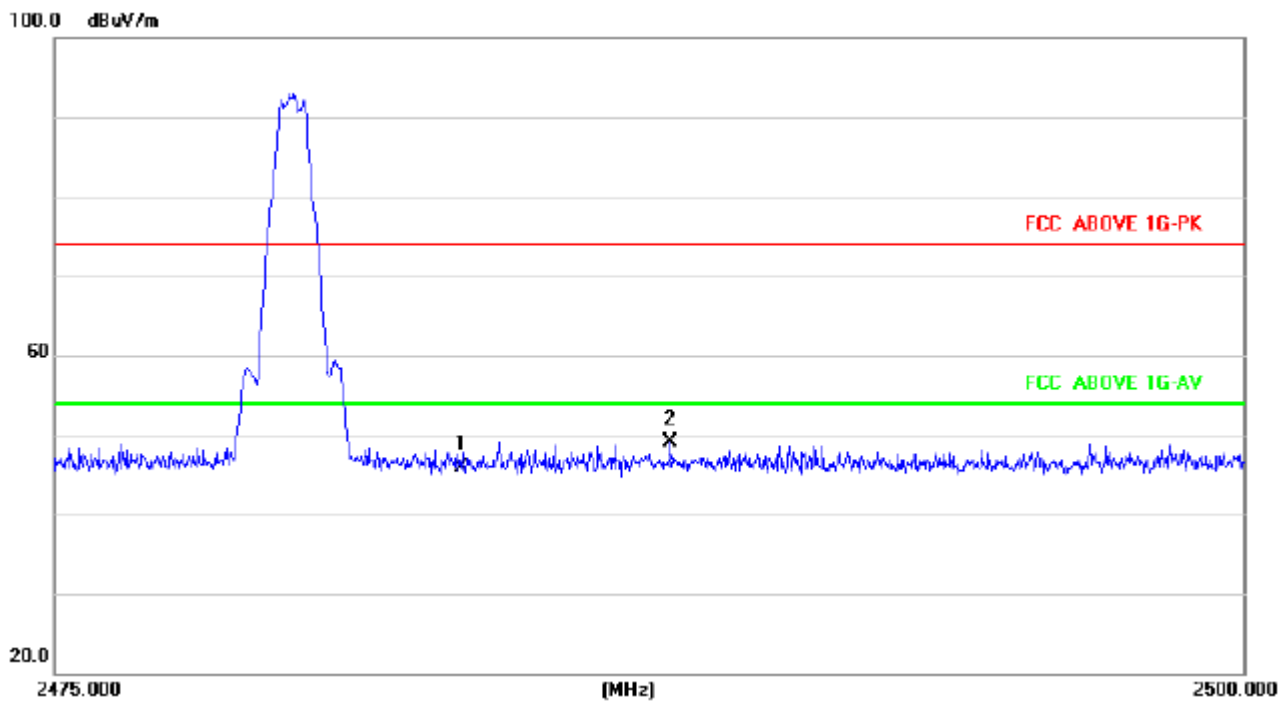

## **7. ANTENNA REQUIREMENT**

### **7.1 STANDARD REQUIREMENT**

15.203 requirement: For intentional device, according to 15.203: an intentional radiator shall be designed to ensure that no antenna other than that furnished by the responsible party shall be used with the device.

### **7.2 EUT ANTENNA**

The EUT antenna is permanent PCB antenna, It complies with the standard requirement.

## 8. EUT TEST PHOTO

### Radiated Measurement Photos

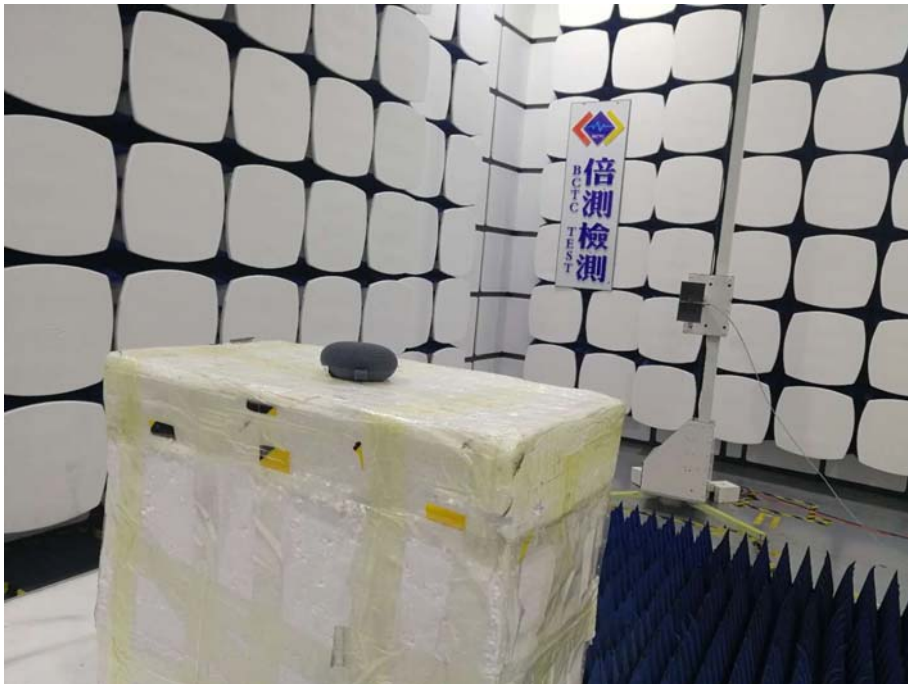

### Conducted emissions



### 9. EUT PHOTO

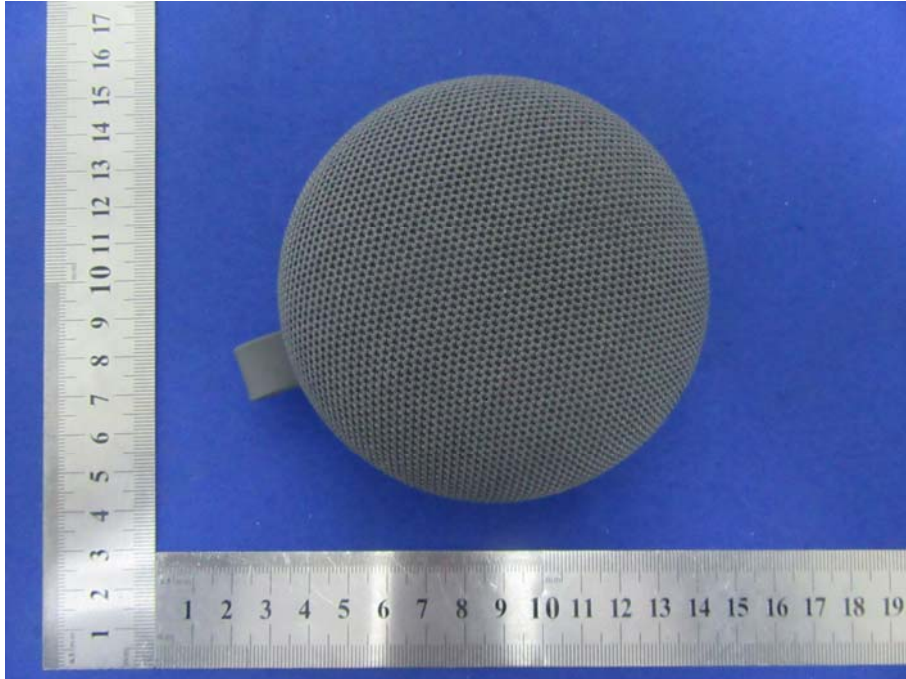

\*\*\*\*\* END OF REPORT \*\*\*\*\*