

FCC C2PC Test Report

FCC ID : 2ALXJ-WBC100
Equipment : Whiteboard Owl
Model No. : WBC100
Brand Name : OWLLabs™
Applicant : Owl Labs Inc
Address : 33-1/2 Union Sq
Somerville US 02143 United States Of America
Standard : 47 CFR FCC Part 15.247
Received Date : Sep. 17, 2021
Tested Date : Sep. 18 ~ Oct. 07, 2021

We, International Certification Corporation, would like to declare that the tested sample has been evaluated and in compliance with the requirement of the above standards. The test results contained in this report refer exclusively to the product. It may be duplicated completely for legal use with the approval of the applicant. It shall not be reproduced except in full without the written approval of our laboratory.

Reviewed by:

Approved by:

Along Chen / Assistant Manager

Gary Chang / Manager



Table of Contents

1	GENERAL DESCRIPTION	5
1.1	Information.....	5
1.2	Local Support Equipment List	7
1.3	Test Setup Chart	7
1.4	The Equipment List	8
1.5	Test Standards	9
1.6	Reference Guidance	9
1.7	Deviation from Test Standard and Measurement Procedure.....	9
1.8	Measurement Uncertainty	9
2	TEST CONFIGURATION.....	10
2.1	Testing Facility	10
2.2	The Worst Test Modes and Channel Details	10
3	TRANSMITTER TEST RESULTS	11
3.1	Conducted Emissions.....	11
3.2	Unwanted Emissions into Restricted Frequency Bands	14
3.3	Conducted Output Power	23
4	TEST LABORATORY INFORMATION	26

Release Record

Report No.	Version	Description	Issued Date
FR0D1401-02AD	Rev. 01	Initial issue	Oct. 08, 2021

Summary of Test Results

FCC Rules	Test Items	Measured	Result
15.207	Conducted Emissions	[dBuV]: 0.484MHz 38.66 (Margin -7.61dB) - AV	Pass
15.247(d) 15.209	Radiated Emissions	[dBuV]: 30.00MHz 31.03 (Margin -8.97dB) - PK	Pass
15.247(b)(1)	Conducted Output Power	Power [dBm]: 10.84	Pass

Declaration of Conformity:

The test results with all measurement uncertainty excluded are presented in accordance with the regulation limits or requirements declared by manufacturers.

Comments and Explanations:

The declared of product specification for EUT presented in the report are provided by the manufacturer, and the manufacturer takes all the responsibilities for the accuracy of product specification.

1 General Description

1.1 Information

This is a Class II Permissive Change report (C2PC).

This report is issued as a supplementary report to original report no. FR0D1401AD. The modification is concerned with following item:

- Add two DC brushless fans (at the top) and the power connection to the main PCB.
- Add small holes to top enclosure for thermal dissipations.

1.1.1 Specification of the Equipment under Test (EUT)

RF General Information				
Frequency Range (MHz)	Bluetooth Mode	Ch. Frequency (MHz)	Channel Number	Data Rate
2400-2483.5	BR	2402-2480	0-78 [79]	1 Mbps
2400-2483.5	EDR	2402-2480	0-78 [79]	2 Mbps
2400-2483.5	EDR	2402-2480	0-78 [79]	3 Mbps

Note 1: RF output power specifies that Maximum Peak Conducted Output Power.
 Note 2: Bluetooth BR uses a GFSK.
 Note 3: Bluetooth EDR uses a combination of $\pi/4$ -DQPSK and 8DPSK.

1.1.2 Antenna Details

Ant. No.	Model	Type	Connector	Gain (dBi)	Remarks
1	WPANT101 40-S1 A	Metal	IPX/MHF	1.8	---

1.1.3 Power Supply Type of Equipment under Test (EUT)

Power Supply Type	12Vdc from adapter
--------------------------	--------------------

1.1.4 Accessories

Accessories		
No.	Equipment	Description
1	Adapter	Brand: APX Model: PS12011000 Power Rating: I/P: 100-240Vac, 50/60Hz, 0.5A Max O/P: 12Vdc, 1.0A, 12W Power Line: 6.06m non-shielded without core
2	Meeting Owl Pro	Brand: OWLLabs™ Model: MTW200

1.1.5 Channel List

Frequency band (MHz)				2400~2483.5			
Channel	Frequency (MHz)	Channel	Frequency (MHz)	Channel	Frequency (MHz)	Channel	Frequency (MHz)
0	2402	20	2422	40	2442	60	2462
1	2403	21	2423	41	2443	61	2463
2	2404	22	2424	42	2444	62	2464
3	2405	23	2425	43	2445	63	2465
4	2406	24	2426	44	2446	64	2466
5	2407	25	2427	45	2447	65	2467
6	2408	26	2428	46	2448	66	2468
7	2409	27	2429	47	2449	67	2469
8	2410	28	2430	48	2450	68	2470
9	2411	29	2431	49	2451	69	2471
10	2412	30	2432	50	2452	70	2472
11	2413	31	2433	51	2453	71	2473
12	2414	32	2434	52	2454	72	2474
13	2415	33	2435	53	2455	73	2475
14	2416	34	2436	54	2456	74	2476
15	2417	35	2437	55	2457	75	2477
16	2418	36	2438	56	2458	76	2478
17	2419	37	2439	57	2459	77	2479
18	2420	38	2440	58	2460	78	2480
19	2421	39	2441	59	2461	---	---

1.1.6 Test Tool and Duty Cycle

Test Tool	Qualcomm Radio Control Tool, Version: 4.0.00134.0 Bluetooth Simulator: CMW270	
Modulation Mode	Duty Cycle Of Test Signal (%)	Duty Factor (dB)
DH5	79.07%	1.02
2DH5	79.07%	1.02
3DH5	79.07%	1.02

1.1.7 Power Index of Test Tool

Modulation Mode	Test Frequency (MHz)		
	2402	2441	2480
GFSK/1Mbps	Default	Default	Default
$\pi/4$ -DQPSK /2Mbps	Default	Default	Default
8DPSK/3Mbps	Default	Default	Default

1.2 Local Support Equipment List

Support Equipment List					
No.	Equipment	Brand	Model	FCC ID	Remarks
1	Notebook	DELL	Latitude 5400	DoC	---

1.3 Test Setup Chart

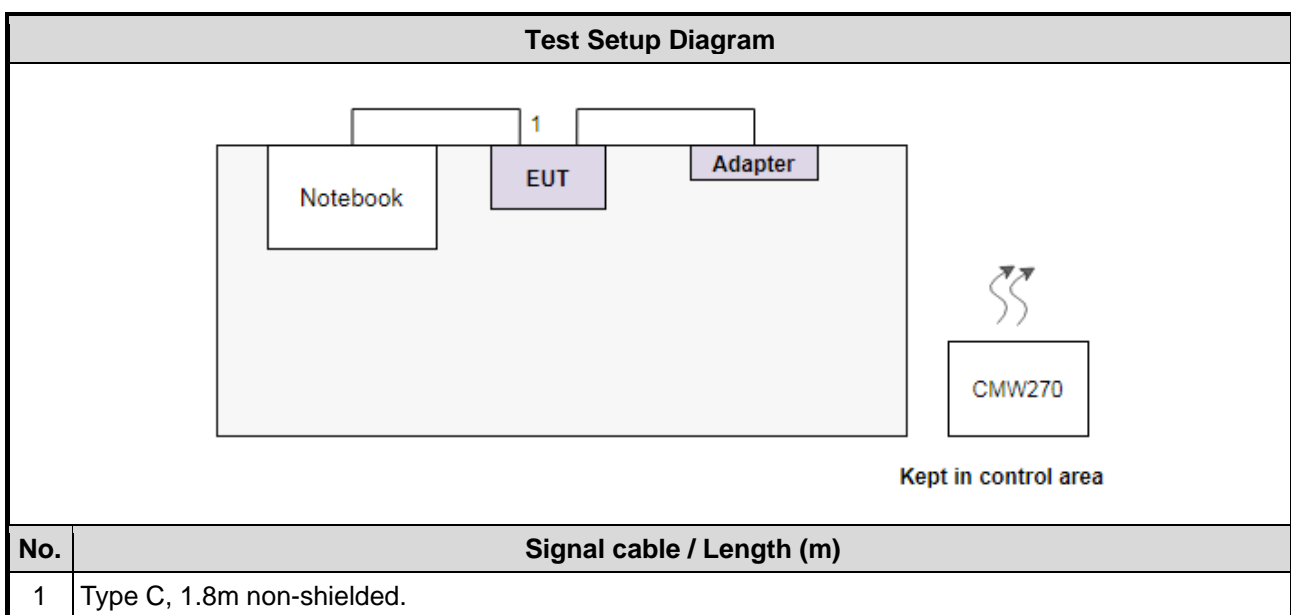

1.4 The Equipment List

Test Item	Conducted Emission				
Test Site	Conduction room 1 / (CO01-WS)				
Tested Date	Sep. 23, 2021				
Instrument	Brand	Model No.	Serial No.	Calibration Date	Calibration Until
Receiver	R&S	ESR3	101658	Feb. 08, 2021	Feb. 07, 2022
LISN	R&S	ENV216	101579	Mar. 17, 2021	Mar. 16, 2022
LISN (Support Unit)	SCHWARZBECK	Schwarzbeck 8127	8127-666	Dec. 29, 2020	Dec. 28, 2021
RF Cable-CON	Woken	CFD200-NL	CFD200-NL-001	Oct. 21, 2020	Oct. 20, 2021
50 ohm terminal (Support Unit)	NA	50	04	May 25, 2021	May 24, 2022
Measurement Software	AUDIX	e3	6.120210k	NA	NA

Note: Calibration Interval of instruments listed above is one year.

Test Item	Radiated Emission				
Test Site	966 chamber 1 / (03CH01-WS)				
Tested Date	Sep. 18, 2021				
Instrument	Brand	Model No.	Serial No.	Calibration Date	Calibration Until
Wireless connectivity tester	R&S	CMW270	100856	Nov. 02, 2020	Nov. 01, 2021
Receiver	R&S	ESR3	101657	Mar. 12, 2021	Mar. 11, 2022
Spectrum Analyzer	R&S	FSV40	101498	Dec. 04, 2020	Dec. 03, 2021
Loop Antenna	R&S	HFH2-Z2	100330	Nov. 17, 2020	Nov. 16, 2021
Bilog Antenna	SCHWARZBECK	VULB9168	VULB9168-522	Jun. 30, 2021	Jun. 29, 2022
Horn Antenna 1G-18G	SCHWARZBECK	BBHA 9120 D	BBHA 9120 D 1096	Dec. 11, 2020	Dec. 10, 2021
Horn Antenna 18G-40G	SCHWARZBECK	BBHA 9170	BBHA 9170508	Dec. 31, 2020	Dec. 30, 2021
Preamplifier	EMC	EMC02325	980225	Jun. 29, 2021	Jun. 28, 2022
Preamplifier	Agilent	83017A	MY39501308	Sep. 26, 2020	Sep. 25, 2021
Preamplifier	EMC	EMC184045B	980192	Jul. 14, 2021	Jul. 13, 2022
Loop Antenna Cable	KOAX KABEL	101354-BW	101354-BW	Oct. 06, 2020	Oct. 05, 2021
LF cable 3M	Woken	CFD400NL-LW	CFD400NL-001	Oct. 06, 2020	Oct. 05, 2021
LF cable 11M	EMC	EMCCFD400-NW-N W-11000	200801	Oct. 06, 2020	Oct. 05, 2021
LF cable 1M	EMC	EMCCFD400-NM-N M-1000	160502	Oct. 06, 2020	Oct. 05, 2021
RF Cable	HUBER+SUHNER	SUCOFLEX104	MY16019/4	Oct. 06, 2020	Oct. 05, 2021
RF Cable	HUBER+SUHNER	SUCOFLEX104	MY16014/4	Oct. 06, 2020	Oct. 05, 2021
Measurement Software	AUDIX	e3	6.120210g	NA	NA

Note: Calibration Interval of instruments listed above is one year.

Test Item	RF Conducted				
Test Site	(TH01-WS)				
Tested Date	Oct. 07, 2021				
Instrument	Brand	Model No.	Serial No.	Calibration Date	Calibration Until
Wireless connectivity tester	R&S	CMW270	100856	Nov .02, 2020	Nov. 01, 2021
Spectrum Analyzer	R&S	FSV40	101498	Dec. 04, 2020	Dec. 03, 2021
Power Meter	Anritsu	ML2495A	1241002	Nov. 04, 2020	Nov. 03, 2021
Power Sensor	Anritsu	MA2411B	1207366	Nov. 04, 2020	Nov. 03, 2021
Measurement Software	Sporton	SENSE-15247_FS	V5.10.7.11	NA	NA

Note: Calibration Interval of instruments listed above is one year.

1.5 Test Standards

47 CFR FCC Part 15.247
ANSI C63.10-2013

1.6 Reference Guidance

FCC KDB 558074 D01 15.247 Meas Guidance v05r02

1.7 Deviation from Test Standard and Measurement Procedure

None

1.8 Measurement Uncertainty

The measurement uncertainties given below are based on a 95% confidence level (based on a coverage factor ($k=2$)).

Measurement Uncertainty	
Parameters	Uncertainty
Conducted power	± 0.808 dB
AC conducted emission	± 2.92 dB
Radiated emission ≤ 1 GHz	± 3.41 dB
Radiated emission > 1 GHz	± 4.59 dB

2 Test Configuration

2.1 Testing Facility

Test Laboratory	International Certification Corporation
Test Site	CO01-WS, 03CH01-WS, TH01-WS
Address of Test Site	No.3-1, Lane 6, Wen San 3rd St., Kwei Shan Dist., Tao Yuan City 33381, Taiwan (R.O.C.)

- FCC Designation No.: TW2732
- FCC site registration No.: 181692
- ISED#: 10807A
- CAB identifier: TW2732

2.2 The Worst Test Modes and Channel Details

Test item	Mode	Test Frequency (MHz)	Data Rate (Mbps)	Test Configuration
Conducted Emissions Radiated Emissions ≤ 1GHz	GFSK	2402	1Mbps	---
Radiated Emissions > 1GHz	GFSK 8DPSK	2402 2480	1Mbps 3Mbps	---
Conducted Output Power	GFSK π/4 DQPSK 8DPSK	2402, 2441, 2480 2402, 2441, 2480 2402, 2441, 2480	1Mbps 2Mbps 3Mbps	---

NOTE:

1. The EUT was pretested with 3 orientations placed on the table for the radiated emission measurement – X, Y, and Z-plane. The **Y-plane** results were found as the worst case and were shown in this report.

3 Transmitter Test Results

3.1 Conducted Emissions

3.1.1 Limit of Conducted Emissions

Conducted Emissions Limit		
Frequency Emission (MHz)	Quasi-Peak	Average
0.15-0.5	66 - 56 *	56 - 46 *
0.5-5	56	46
5-30	60	50

Note 1: * Decreases with the logarithm of the frequency.

3.1.2 Test Procedures

1. The device is placed on a test table, raised 80 cm above the reference ground plane. The vertical conducting plane is located 40 cm to the rear of the device.
2. The device is connected to line impedance stabilization network (LISN) and other accessories are connected to other LISN. Measured levels of AC power line conducted emission are across the 50 Ω LISN port.
3. AC conducted emission measurements is made over frequency range from 150 kHz to 30 MHz.
4. This measurement was performed with AC 120V/60Hz

3.1.3 Test Setup

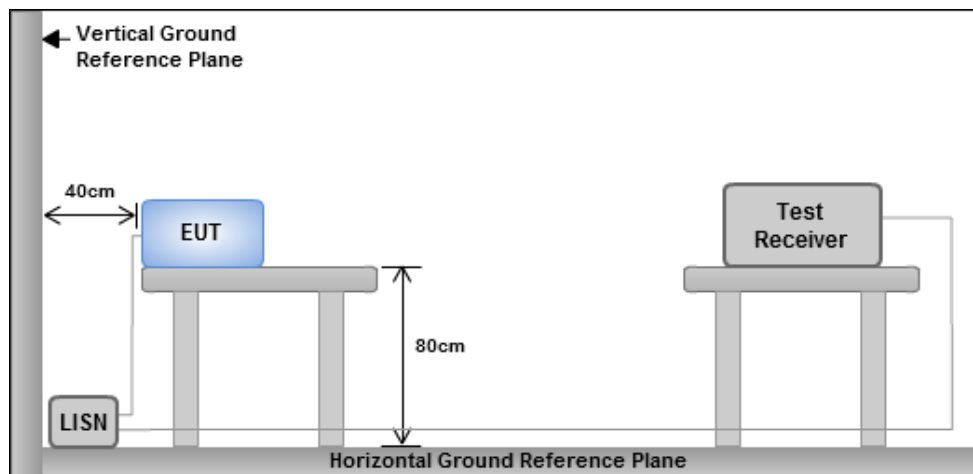

- Note: 1. Support units were connected to second LISN.
 2. Both of LISNs (AMN) are 80 cm from EUT and at least 80 cm from other units and other metal planes

3.1.4 Test Result of Conducted Emissions

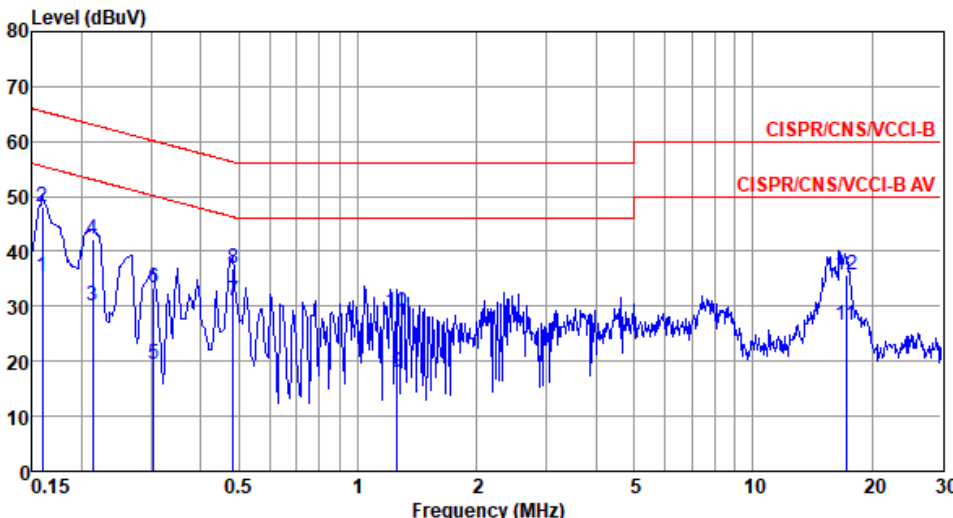
Modulation Mode	GFSK	Test Freq. (MHz)	2402																																																																																																																																					
Power Phase	Line																																																																																																																																							
Test by : Joe Liao Temperature: 22°C Humidity: 63%																																																																																																																																								
																																																																																																																																								
	<table border="1"> <thead> <tr> <th>Freq</th> <th>Level</th> <th>Limit</th> <th>Over</th> <th>Read</th> <th>Factor</th> <th>Cable</th> <th>Remark</th> </tr> <tr> <th>MHz</th> <th>dBuV</th> <th>Line</th> <th>Limit</th> <th>Level</th> <th>dB</th> <th>loss</th> <th></th> </tr> <tr> <th></th> <th></th> <th>dBuV</th> <th>dB</th> <th>dBuV</th> <th></th> <th>dB</th> <th></th> </tr> </thead> <tbody> <tr><td>1</td><td>0.159</td><td>35.29</td><td>55.52</td><td>-20.23</td><td>25.41</td><td>9.83</td><td>0.05</td><td>Average</td></tr> <tr><td>2</td><td>0.159</td><td>48.16</td><td>65.52</td><td>-17.36</td><td>38.28</td><td>9.83</td><td>0.05</td><td>QP</td></tr> <tr><td>3</td><td>0.213</td><td>30.00</td><td>53.10</td><td>-23.10</td><td>20.10</td><td>9.84</td><td>0.06</td><td>Average</td></tr> <tr><td>4</td><td>0.213</td><td>42.15</td><td>63.10</td><td>-20.95</td><td>32.25</td><td>9.84</td><td>0.06</td><td>QP</td></tr> <tr><td>5</td><td>0.303</td><td>19.46</td><td>50.15</td><td>-30.69</td><td>9.52</td><td>9.87</td><td>0.07</td><td>Average</td></tr> <tr><td>6</td><td>0.303</td><td>33.33</td><td>60.15</td><td>-26.82</td><td>23.39</td><td>9.87</td><td>0.07</td><td>QP</td></tr> <tr><td>7*</td><td>0.484</td><td>30.91</td><td>46.27</td><td>-15.36</td><td>20.91</td><td>9.91</td><td>0.09</td><td>Average</td></tr> <tr><td>8</td><td>0.484</td><td>36.88</td><td>56.27</td><td>-19.39</td><td>26.88</td><td>9.91</td><td>0.09</td><td>QP</td></tr> <tr><td>9</td><td>1.255</td><td>17.93</td><td>46.00</td><td>-28.07</td><td>7.80</td><td>9.99</td><td>0.14</td><td>Average</td></tr> <tr><td>10</td><td>1.255</td><td>29.06</td><td>56.00</td><td>-26.94</td><td>18.93</td><td>9.99</td><td>0.14</td><td>QP</td></tr> <tr><td>11</td><td>17.199</td><td>26.50</td><td>50.00</td><td>-23.50</td><td>15.64</td><td>10.23</td><td>0.63</td><td>Average</td></tr> <tr><td>12</td><td>17.199</td><td>35.73</td><td>60.00</td><td>-24.27</td><td>24.87</td><td>10.23</td><td>0.63</td><td>QP</td></tr> </tbody> </table>	Freq	Level	Limit	Over	Read	Factor	Cable	Remark	MHz	dBuV	Line	Limit	Level	dB	loss				dBuV	dB	dBuV		dB		1	0.159	35.29	55.52	-20.23	25.41	9.83	0.05	Average	2	0.159	48.16	65.52	-17.36	38.28	9.83	0.05	QP	3	0.213	30.00	53.10	-23.10	20.10	9.84	0.06	Average	4	0.213	42.15	63.10	-20.95	32.25	9.84	0.06	QP	5	0.303	19.46	50.15	-30.69	9.52	9.87	0.07	Average	6	0.303	33.33	60.15	-26.82	23.39	9.87	0.07	QP	7*	0.484	30.91	46.27	-15.36	20.91	9.91	0.09	Average	8	0.484	36.88	56.27	-19.39	26.88	9.91	0.09	QP	9	1.255	17.93	46.00	-28.07	7.80	9.99	0.14	Average	10	1.255	29.06	56.00	-26.94	18.93	9.99	0.14	QP	11	17.199	26.50	50.00	-23.50	15.64	10.23	0.63	Average	12	17.199	35.73	60.00	-24.27	24.87	10.23	0.63	QP			
Freq	Level	Limit	Over	Read	Factor	Cable	Remark																																																																																																																																	
MHz	dBuV	Line	Limit	Level	dB	loss																																																																																																																																		
		dBuV	dB	dBuV		dB																																																																																																																																		
1	0.159	35.29	55.52	-20.23	25.41	9.83	0.05	Average																																																																																																																																
2	0.159	48.16	65.52	-17.36	38.28	9.83	0.05	QP																																																																																																																																
3	0.213	30.00	53.10	-23.10	20.10	9.84	0.06	Average																																																																																																																																
4	0.213	42.15	63.10	-20.95	32.25	9.84	0.06	QP																																																																																																																																
5	0.303	19.46	50.15	-30.69	9.52	9.87	0.07	Average																																																																																																																																
6	0.303	33.33	60.15	-26.82	23.39	9.87	0.07	QP																																																																																																																																
7*	0.484	30.91	46.27	-15.36	20.91	9.91	0.09	Average																																																																																																																																
8	0.484	36.88	56.27	-19.39	26.88	9.91	0.09	QP																																																																																																																																
9	1.255	17.93	46.00	-28.07	7.80	9.99	0.14	Average																																																																																																																																
10	1.255	29.06	56.00	-26.94	18.93	9.99	0.14	QP																																																																																																																																
11	17.199	26.50	50.00	-23.50	15.64	10.23	0.63	Average																																																																																																																																
12	17.199	35.73	60.00	-24.27	24.87	10.23	0.63	QP																																																																																																																																
Note 1: Level (dBuV) = Read Level (dBuV) + LISN Factor (dB) + Cable Loss (dB). 2: Over Limit (dB) = Level (dBuV) – Limit Line (dBuV).																																																																																																																																								

Modulation Mode	GFSK	Test Freq. (MHz)	2402
Power Phase	Neutral		

Test by : Joe Liao Temperature: 22°C Humidity: 63%

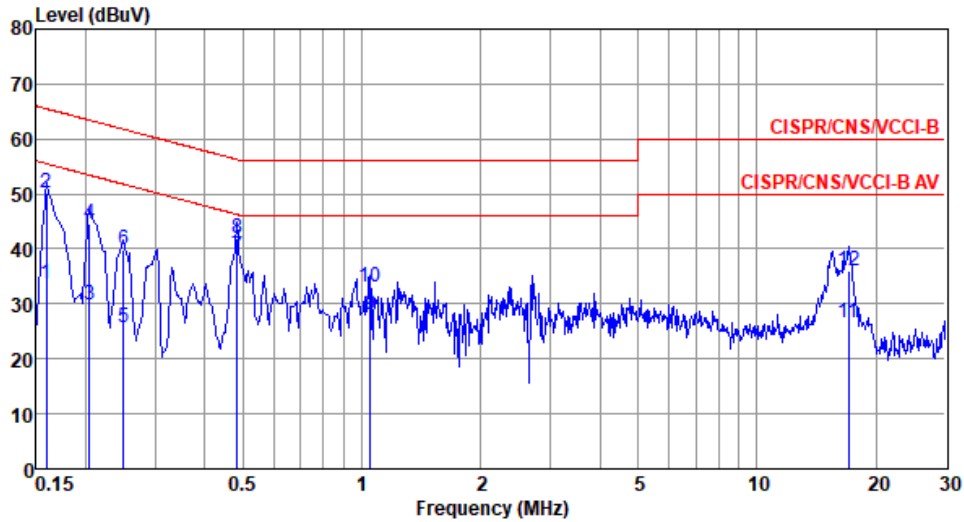

	Freq MHz	Level dBuV	Limit Line dBuV	Over Limit dB	Read Level dBuV	Factor dB	Cable loss dB	Remark
1	0.159	33.68	55.52	-21.84	23.81	9.82	0.05	Average
2	0.159	50.23	65.52	-15.29	40.36	9.82	0.05	QP
3	0.204	29.86	53.45	-23.59	19.97	9.83	0.06	Average
4	0.204	44.62	63.45	-18.83	34.73	9.83	0.06	QP
5	0.249	25.60	51.78	-26.18	15.69	9.84	0.07	Average
6	0.249	39.76	61.78	-22.02	29.85	9.84	0.07	QP
7*	0.484	38.66	46.27	-7.61	28.71	9.86	0.09	Average
8	0.484	41.82	56.27	-14.45	31.87	9.86	0.09	QP
9	1.049	28.11	46.00	-17.89	18.11	9.88	0.12	Average
10	1.049	33.16	56.00	-22.84	23.16	9.88	0.12	QP
11	17.018	26.59	50.00	-23.41	15.69	10.27	0.63	Average
12	17.018	36.07	60.00	-23.93	25.17	10.27	0.63	QP

Note 1: Level (dBuV) = Read Level (dBuV) + LISN Factor (dB) + Cable Loss (dB).
 2: Over Limit (dB) = Level (dBuV) – Limit Line (dBuV).

3.2 Unwanted Emissions into Restricted Frequency Bands

3.2.1 Limit of Unwanted Emissions into Restricted Frequency Bands

Restricted Band Emissions Limit			
Frequency Range (MHz)	Field Strength (uV/m)	Field Strength (dBuV/m)	Measure Distance (m)
0.009~0.490	2400/F(kHz)	48.5 - 13.8	300
0.490~1.705	24000/F(kHz)	33.8 - 23	30
1.705~30.0	30	29	30
30~88	100	40	3
88~216	150	43.5	3
216~960	200	46	3
Above 960	500	54	3

Note 1:
Qusai-Peak value is measured for frequency below 1GHz except for 9–90 kHz, 110–490 kHz frequency band. Peak and average value are measured for frequency above 1GHz. The limit on average radio frequency emission is as above table. The limit on peak radio frequency emissions is 20 dB above the maximum permitted average emission limit

Note 2:
Measurements may be performed at a distance other than what is specified provided. When performing measurements at a distance other than that specified, the results shall be extrapolated to the specified distance using an extrapolation factor as below, Frequency at or above 30 MHz: 20 dB/decade Frequency below 30 MHz: 40 dB/decade.

3.2.2 Test Procedures

1. Measurement is made at a semi-anechoic chamber that incorporates a turntable allowing a EUT rotation of 360°. A continuously-rotating, remotely-controlled turntable is installed at the test site to support the EUT and facilitate determination of the direction of maximum radiation for each EUT emission frequency. The EUT is placed at test table. For emissions testing at or below 1 GHz, the table height is 80 cm above the reference ground plane. For emission measurements above 1 GHz, the table height is 1.5 m
2. Measurement is made with the antenna positioned in both the horizontal and vertical planes of polarization. The measurement antenna is varied in height (1m ~ 4m) above the reference ground plane to obtain the maximum signal strength. Distance between EUT and antenna is 3 m.
3. This investigation is performed with the EUT rotated 360°, the antenna height scanned between 1 m and 4 m, and the antenna rotated to repeat the measurements for both the horizontal and vertical antenna polarizations.

Note:

1. 120kHz measurement bandwidth of test receiver and Quasi-peak detector is for radiated emission below 1GHz.
2. Radiated emission above 1GHz / Peak value
RBW=1MHz, VBW=3MHz and Peak detector
Radiated emission above 1GHz / Average value for harmonics
The average value is: Average = Peak value + 20log(Duty cycle) Where the duty factor is calculated from following formula for DH5 packet type which has worst duty factor:
3.
$$20\log(\text{Duty cycle}) = 20\log \frac{1\text{s} / 1600 * 5}{100\text{ ms}} = -30.1\text{dB}$$
4. Radiated emission above 1GHz / Average value for other emissions
RBW=1MHz, VBW=1/T and Peak detector

3.2.3 Test Setup

Radiated Emissions below 1 GHz

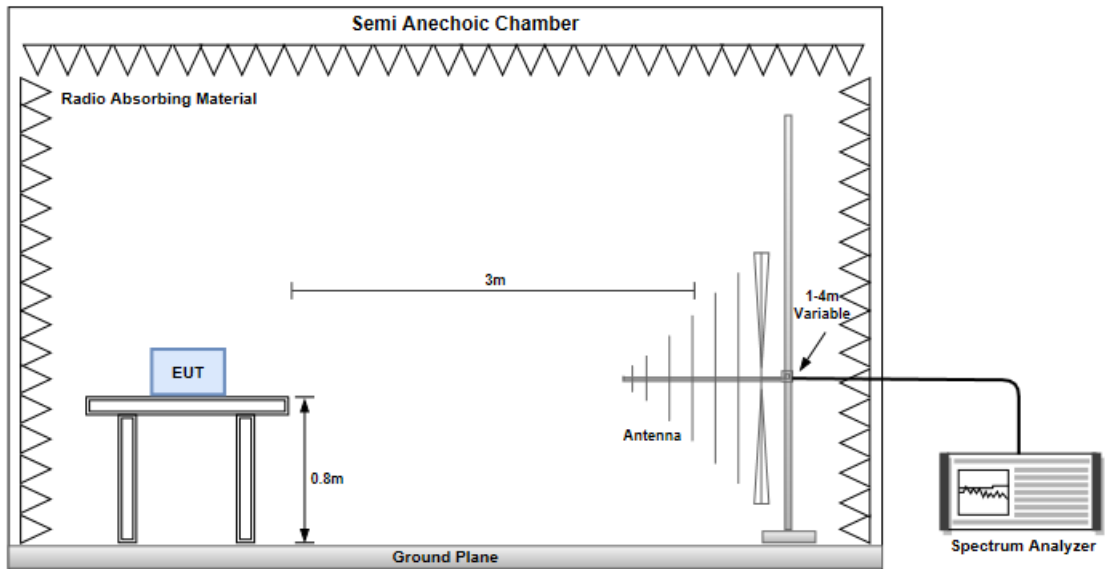

Radiated Emissions above 1 GHz

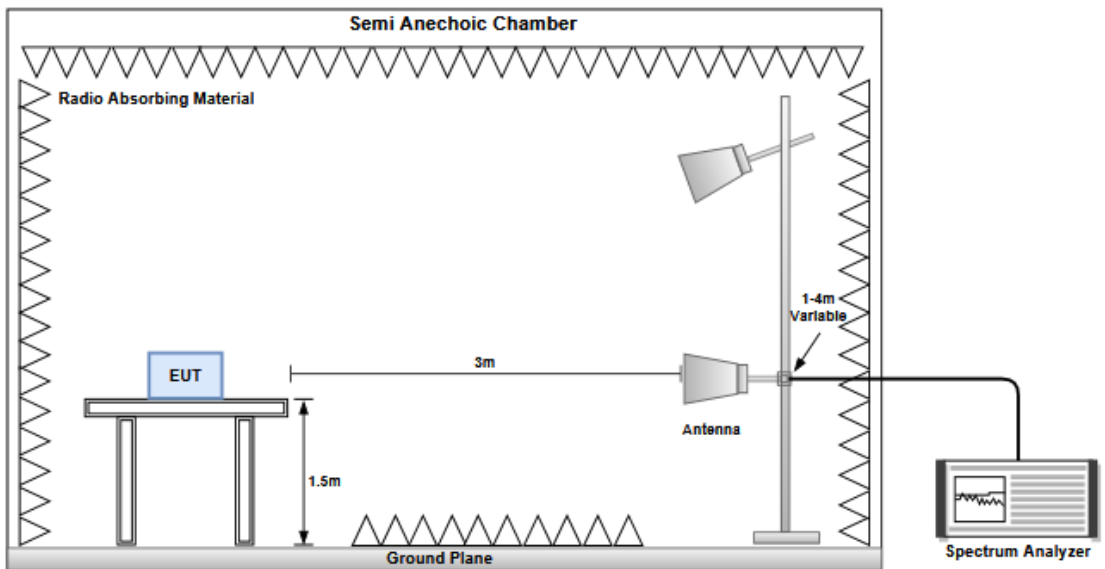

3.2.4 Transmitter Radiated Unwanted Emissions (Below 1GHz)

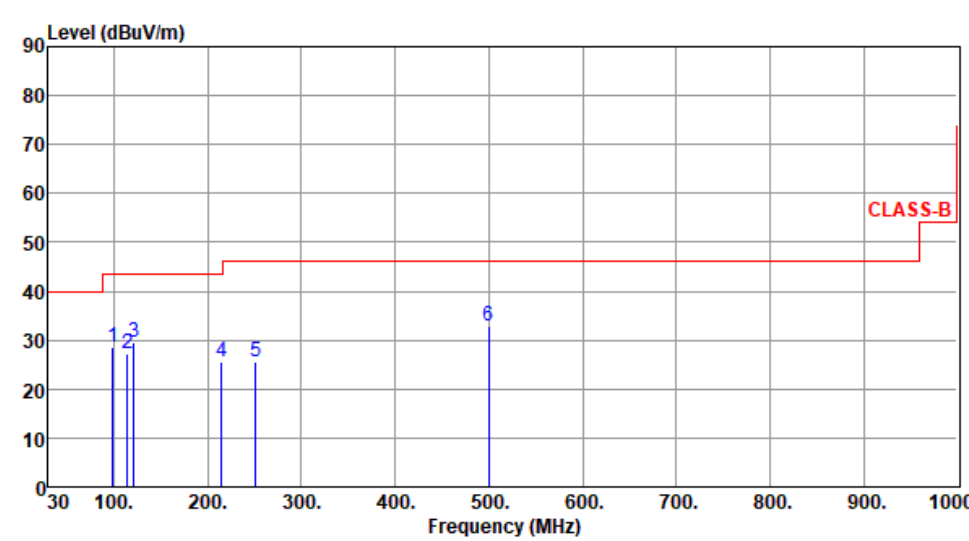
Modulation	GFSK	Test Freq. (MHz)	2402						
Polarization	Horizontal								
Test By : Akun Chung Temperature(°C):24 Humidity(%):67									
									
	Freq.	Emission level	Limit	Margin	SA reading	Factor	Remark	ANT High	Turn Table
	MHz	dBuV/m	dBuV/m	dB	dBuV	dB/m		cm	deg
1	98.87	28.41	43.50	-15.09	42.07	-13.66	Peak	---	---
2	114.39	27.24	43.50	-16.26	38.50	-11.26	Peak	---	---
3	121.18	29.70	43.50	-13.80	40.34	-10.64	Peak	---	---
4	215.27	25.42	43.50	-18.08	37.42	-12.00	Peak	---	---
5	251.16	25.45	46.00	-20.55	35.55	-10.10	Peak	---	---
6	499.48	32.85	46.00	-13.15	36.22	-3.37	Peak	---	---

Note 1: Emission Level (dBuV/m) = SA Reading (dBuV) + Factor* (dB/m)
 *Factor includes antenna factor , cable loss and amplifier gain
 Note 2: Margin (dB) = Emission level (dBuV/m) – Limit (dBuV/m).
 Note 3: All spurious emissions below 30MHz are more than 20 dB below the limit.

Modulation	GFSK	Test Freq. (MHz)	2402
Polarization	Vertical		

Test By : Akun Chung Temperature(°C): 24 Humidity(%): 67

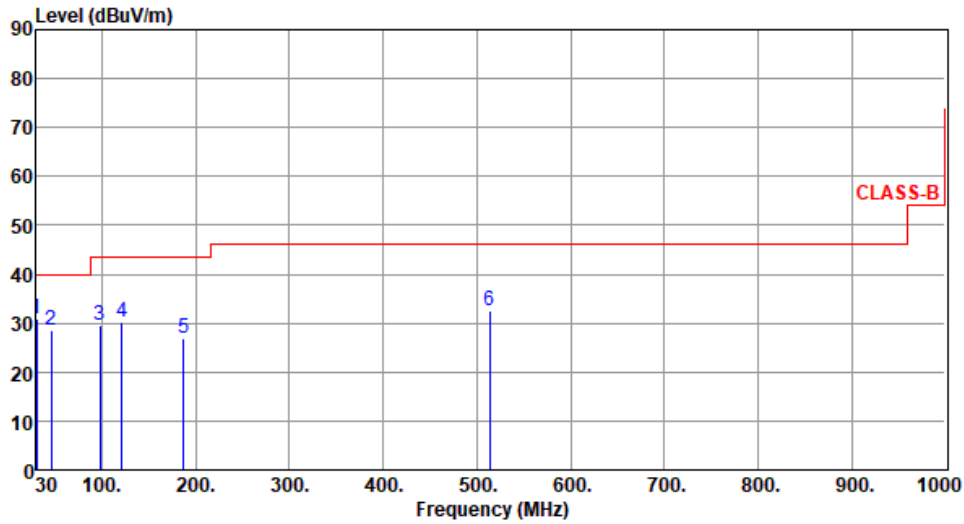

	Freq. MHz	Emission level dBuV/m	Limit dBuV/m	Margin dB	SA reading dBuV	Factor dB/m	Remark	ANT High cm	Turn Table deg
1	30.00	31.03	40.00	-8.97	41.04	-10.01	Peak	---	---
2	45.52	28.71	40.00	-11.29	37.23	-8.52	Peak	---	---
3	97.90	29.40	43.50	-14.10	43.16	-13.76	Peak	---	---
4	121.18	30.26	43.50	-13.24	40.90	-10.64	Peak	---	---
5	187.14	26.84	43.50	-16.66	37.93	-11.09	Peak	---	---
6	514.03	32.43	46.00	-13.57	35.47	-3.04	Peak	---	---

Note 1: Emission Level (dBuV/m) = SA Reading (dBuV) + Factor* (dB/m)

*Factor includes antenna factor, cable loss and amplifier gain

Note 2: Margin (dB) = Emission level (dBuV/m) – Limit (dBuV/m).

Note 3: All spurious emissions below 30MHz are more than 20 dB below the limit.

3.2.5 Transmitter Radiated Unwanted Emissions (Above 1GHz)

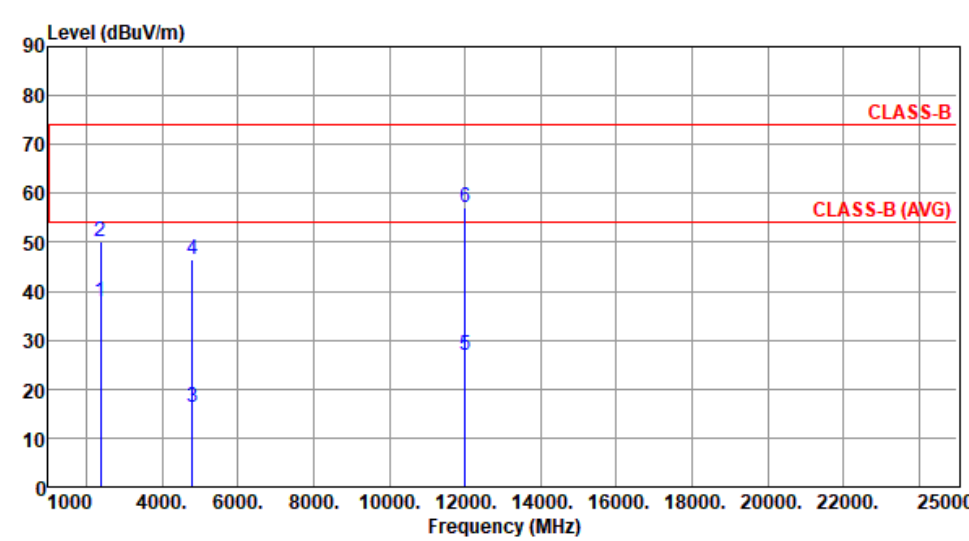
Modulation	GFSK	Test Freq. (MHz)	2402						
Polarization	Horizontal								
Test By : Akun Chung Temperature(°C): 24 Humidity(%): 67									
									
	Freq. MHz	Emission level dBuV/m	Limit dBuV/m	Margin dB	SA reading dBuV	Factor dB/m	Remark	ANT High cm	Turn Table deg
1	2390.00	37.79	54.00	-16.21	40.58	-2.79	Average	323	286
2	2390.00	49.98	74.00	-24.02	52.77	-2.79	Peak	323	286
3	4804.00	16.25	54.00	-37.75	12.75	3.50	Average	100	111
4	4804.00	46.35	74.00	-27.65	42.85	3.50	Peak	100	111
5	12010.00	26.92	54.00	-27.08	12.65	14.27	Average	100	113
6	12010.00	57.02	74.00	-16.98	42.75	14.27	Peak	100	113

Note 1: Emission Level (dBuV/m) = SA Reading (dBuV) + Factor* (dB/m)
*Factor includes antenna factor , cable loss and amplifier gain
Note 2: Margin (dB) = Emission level (dBuV/m) – Limit (dBuV/m).

Modulation	GFSK	Test Freq. (MHz)	2402
Polarization	Vertical		

Test By : Akun Chung Temperature(°C): 24 Humidity(%): 67

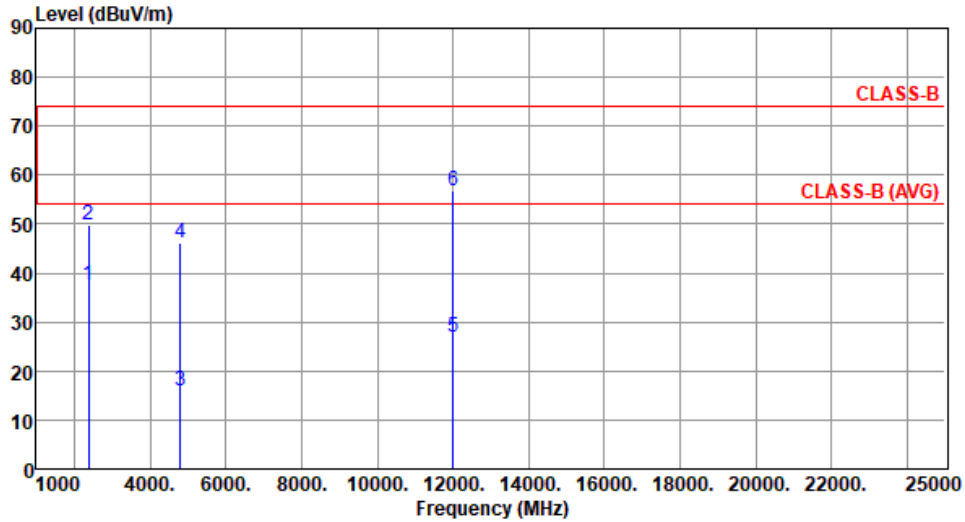

	Freq. MHz	Emission level dBuV/m	Limit dBuV/m	Margin dB	SA reading dBuV	Factor dB/m	Remark	ANT High cm	Turn Table deg
1	2390.00	37.53	54.00	-16.47	40.32	-2.79	Average	155	233
2	2390.00	49.68	74.00	-24.32	52.47	-2.79	Peak	155	233
3	4804.00	16.00	54.00	-38.00	12.50	3.50	Average	100	221
4	4804.00	46.10	74.00	-27.90	42.60	3.50	Peak	100	221
5	12010.00	26.83	54.00	-27.17	12.56	14.27	Average	100	225
6	12010.00	56.93	74.00	-17.07	42.66	14.27	Peak	100	225

Note 1: Emission Level (dBuV/m) = SA Reading (dBuV) + Factor* (dB/m)

*Factor includes antenna factor , cable loss and amplifier gain

Note 2: Margin (dB) = Emission level (dBuV/m) – Limit (dBuV/m).

Modulation	8DPSK	Test Freq. (MHz)	2480
Polarization	Horizontal		

Test By :Akun Chung Temperature(°C):24 Humidity(%):67

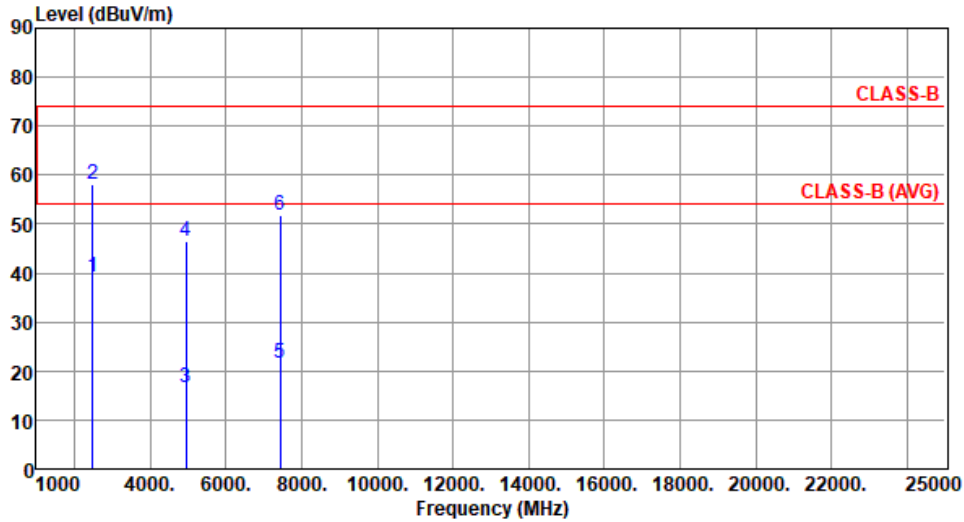

	Freq. MHz	Emission level dBuV/m	Limit dBuV/m	Margin dB	SA reading dBuV	Factor dB/m	Remark	ANT High cm	Turn Table deg
1	2483.50	39.35	54.00	-14.65	42.09	-2.74	Average	358	289
2	2483.50	58.15	74.00	-15.85	60.89	-2.74	Peak	358	289
3	4960.00	16.46	54.00	-37.54	12.78	3.68	Average	100	118
4	4960.00	46.56	74.00	-27.44	42.88	3.68	Peak	100	118
5	7440.00	21.63	54.00	-32.37	12.65	8.98	Average	100	123
6	7440.00	51.73	74.00	-22.27	42.75	8.98	Peak	100	123

Note 1: Emission Level (dBuV/m) = SA Reading (dBuV) + Factor* (dB/m)

*Factor includes antenna factor , cable loss and amplifier gain

Note 2: Margin (dB) = Emission level (dBuV/m) – Limit (dBuV/m).

Modulation	8DPSK	Test Freq. (MHz)	2480
Polarization	Vertical		

Test By :Akun Chung Temperature(°C):24 Humidity(%):67

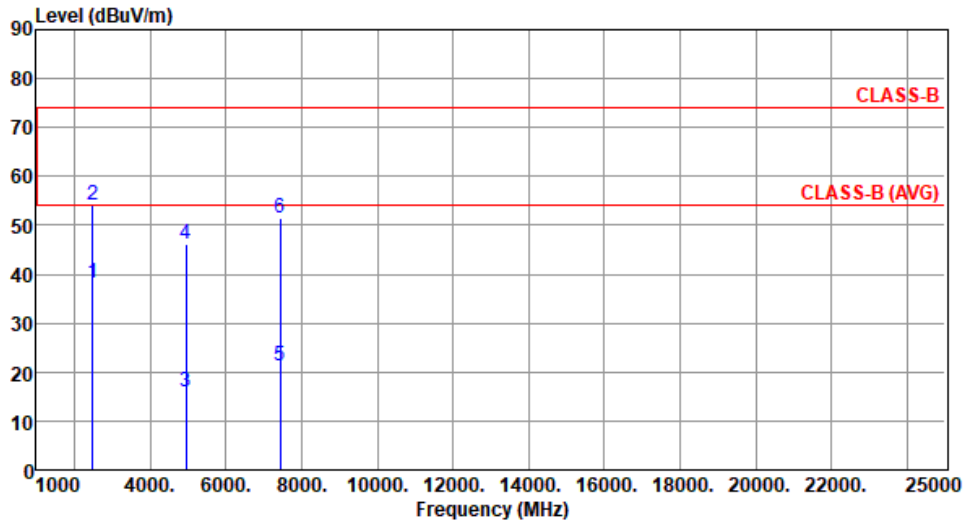

	Freq. MHz	Emission level dBUV/m	Limit dBUV/m	Margin dB	SA reading dBUV	Factor dB/m	Remark	ANT High cm	Turn Table deg
1	2483.50	38.26	54.00	-15.74	41.00	-2.74	Average	158	236
2	2483.50	54.11	74.00	-19.89	56.85	-2.74	Peak	158	236
3	4960.00	15.91	54.00	-38.09	12.23	3.68	Average	100	220
4	4960.00	46.01	74.00	-27.99	42.33	3.68	Peak	100	220
5	7440.00	21.28	54.00	-32.72	12.30	8.98	Average	100	214
6	7440.00	51.38	74.00	-22.62	42.40	8.98	Peak	100	214

Note 1: Emission Level (dBUV/m) = SA Reading (dBUV) + Factor* (dB/m)

*Factor includes antenna factor , cable loss and amplifier gain

Note 2: Margin (dB) = Emission level (dBUV/m) – Limit (dBUV/m).

3.3 Conducted Output Power

3.3.1 Limit of Conducted Output Power

- 1 Watt
For frequency hopping systems operating in the 2400–2483.5 MHz band employing at least 75 non overlapping hopping channels, and all frequency hopping systems in the 5725–5850 MHz band.
- 0.125 Watt
For all other frequency hopping systems in the 2400–2483.5 MHz band.
- 0.125 Watt
For Frequency hopping systems operating in the 2400–2483.5 MHz band have hopping channel carrier frequencies that are separated by two-thirds of the 20 dB bandwidth of the hopping channel.

3.3.2 Test Procedures

1. A wideband power meter is used for power measurement. Bandwidth of power sensor and meter is 50MHz
2. If duty cycle of test signal is not 100 %, trigger and gating function of power meter will be enabled to capture transmission burst for measuring output power

3.3.3 Test Setup

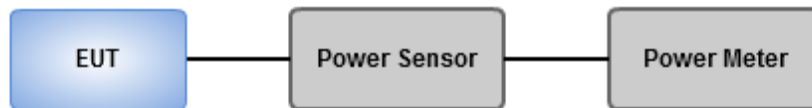

3.3.4 Test Result of Conducted Output Power

Ambient Condition	23°C / 60%	Tested By	Brad Wu
--------------------------	------------	------------------	---------

Summary of Peak Conducted Output Power

Mode	Power (dBm)	Power (W)
2.4-2.4835GHz	-	-
BT-BR(1Mbps)	10.84	0.01213
BT-EDR(2Mbps)	10.37	0.01089
BT-EDR(3Mbps)	10.57	0.01140

Result

Mode	Result	Gain (dBi)	Power (dBm)	Power Limit (dBm)
BT-BR(1Mbps)	-	-	-	-
2402MHz	Pass	1.80	10.84	21.00
2441MHz	Pass	1.80	9.96	21.00
2480MHz	Pass	1.80	10.37	21.00
BT-EDR(2Mbps)	-	-	-	-
2402MHz	Pass	1.80	10.37	21.00
2441MHz	Pass	1.80	9.46	21.00
2480MHz	Pass	1.80	10.09	21.00
BT-EDR(3Mbps)	-	-	-	-
2402MHz	Pass	1.80	10.57	21.00
2441MHz	Pass	1.80	9.69	21.00
2480MHz	Pass	1.80	10.23	21.00

DG = Directional Gain; Port X = Port X output power

Summary of Conducted (Average) Output Power

Mode	Power (dBm)	Power (W)
2.4-2.4835GHz	-	-
BT-BR(1Mbps)	10.71	0.01178
BT-EDR(2Mbps)	8.74	0.00748
BT-EDR(3Mbps)	8.74	0.00748

Result

Mode	Result	Gain (dBi)	Power (dBm)	Power Limit (dBm)
BT-BR(1Mbps)	-	-	-	-
2402MHz	Pass	1.80	10.71	-
2441MHz	Pass	1.80	9.84	-
2480MHz	Pass	1.80	10.29	-
BT-EDR(2Mbps)	-	-	-	-
2402MHz	Pass	1.80	8.39	-
2441MHz	Pass	1.80	7.49	-
2480MHz	Pass	1.80	8.74	-
BT-EDR(3Mbps)	-	-	-	-
2402MHz	Pass	1.80	8.39	-
2441MHz	Pass	1.80	7.49	-
2480MHz	Pass	1.80	8.74	-

Note: Average power is for reference only.

4 Test laboratory information

Established in 2012, ICC provides foremost EMC & RF Testing and advisory consultation services by our skilled engineers and technicians. Our services employ a wide variety of advanced edge test equipment and one of the widest certification extents in the business.

International Certification Corporation (EMC and Wireless Communication Laboratory), it is our definitive objective is to institute long term, trust-based associations with our clients. The expectation we set up with our clients is based on outstanding service, practical expertise and devotion to a certified value structure. Our passion is to grant our clients with best EMC / RF services by oriented knowledgeable and accommodating staff.

Our Test sites are located at Linkou District and Kwei Shan District. Location map can be found on our website <http://www.icertifi.com.tw>.

Linkou

Tel: 886-2-2601-1640

No.30-2, Ding Fwu Tsuen, Lin Kou
District, New Taipei City, Taiwan
(R.O.C.)

Kwei Shan

Tel: 886-3-271-8666

No.3-1, Lane 6, Wen San 3rd
St., Kwei Shan Dist., Tao Yuan
City 33381, Taiwan (R.O.C.)
No.2-1, Lane 6, Wen San 3rd
St., Kwei Shan Dist., Tao Yuan
City 33381, Taiwan (R.O.C.)

Kwei Shan Site II

Tel: 886-3-271-8640

No.14-1, Lane 19, Wen San 3rd
St., Kwei Shan Dist., Tao Yuan
City 333, Taiwan (R.O.C.)

If you have any suggestion, please feel free to contact us as below information.

Tel: 886-3-271-8666

Fax: 886-3-318-0345

Email: ICC_Service@icertifi.com.tw

==END==