

TEST REPORT

CERTIFICATE OF CONFORMITY

Standard: 47 CFR FCC Part 15, Subpart C (Section 15.247)

Report No.: RFBEIU-WTW-P23030111

FCC ID: 2ALXJ-FRS100

Product: Owl Bar

Brand: OWL LABS

Model No.: FRS100

Series Model: FRS100*****(* can be 0-9, A-Z, a-z ,-, dot or blank or any alphanumeric)

Received Date: 2023/3/3

Test Date: 2023/4/7 ~ 2023/4/11

Issued Date: 2023/4/22

Applicant: Owl Labs Inc.

Address: 33-1/2 Union Sq. Somerville, MA 02143-0214, U.S.A.

Issued By: Bureau Veritas Consumer Products Services (H.K.) Ltd., Taoyuan Branch
Lin Kou Laboratories

Lab Address: No. 47-2, 14th Ling, Chia Pau Vil., Lin Kou Dist., New Taipei City, Taiwan

Test Location: No. 47-2, 14th Ling, Chia Pau Vil., Lin Kou Dist., New Taipei City, Taiwan

FCC Registration / 198487 / TW2021

Designation Number:

Approved by: Jeremy Lin , **Date:** 2023/4/22
Jeremy Lin / Project Engineer

This test report consists of 63 pages in total. It may be duplicated completely for legal use with the approval of the applicant. It should not be reproduced except in full, without the written approval of our laboratory. The test results in the report only apply to the tested sample. The test results in this report are traceable to the national or international standards.



Prepared by : Annie Chang / Senior Specialist

This report is governed by, and incorporates by reference, the Conditions of Testing as posted at the date of issuance of this report at <http://www.bureauveritas.com/home/about-us/our-business/cps/about-us/terms-conditions/> and is intended for your exclusive use. Any copying or replication of this report to or for any other person or entity, or use of our name or trademark, is permitted only with our prior written permission. This report sets forth our findings solely with respect to the test samples identified herein. The results set forth in this report are not indicative or representative of the quality or characteristics of the lot from which a test sample was taken or any similar or identical product unless specifically and expressly noted. Our report includes all of the tests requested by you and the results thereof based upon the information that you provided to us. Measurement uncertainty is only provided upon request for accredited tests. Statements of conformity are based on simple acceptance criteria without taking measurement uncertainty into account, unless otherwise requested in writing. You have 60 days from date of issuance of this report to notify us of any material error or omission caused by our negligence or if you require measurement uncertainty; provided, however, that such notice shall be in writing and shall specifically address the issue you wish to raise. A failure to raise such issue within the prescribed time shall constitute your unqualified acceptance of the completeness of this report, the tests conducted and the correctness of the report contents.

Table of Contents

Release Control Record	4
1 Certificate	5
2 Summary of Test Results	6
2.1 Measurement Uncertainty	6
2.2 Supplementary Information	6
3 General Information	7
3.1 General Description	7
3.2 Antenna Description of EUT	8
3.3 Channel List	9
3.4 Test Mode Applicability and Tested Channel Detail	10
3.5 Duty Cycle of Test Signal	11
3.6 Test Program Used and Operation Descriptions	13
3.7 Connection Diagram of EUT and Peripheral Devices	13
3.8 Configuration of Peripheral Devices and Cable Connections	13
4 Test Instruments	14
4.1 RF Output Power	14
4.2 Power Spectral Density	14
4.3 6 dB Bandwidth	14
4.4 Conducted Out of Band Emissions	14
4.5 AC Power Conducted Emissions	15
4.6 Unwanted Emissions below 1 GHz	16
4.7 Unwanted Emissions above 1 GHz	17
5 Limits of Test Items	18
5.1 RF Output Power	18
5.2 Power Spectral Density	18
5.3 6 dB Bandwidth	18
5.4 Conducted Out of Band Emissions	18
5.5 AC Power Conducted Emissions	18
5.6 Unwanted Emissions below 1 GHz	19
5.7 Unwanted Emissions above 1 GHz	19
6 Test Arrangements	20
6.1 RF Output Power	20
6.1.1 Test Setup	20
6.1.2 Test Procedure	20
6.2 Power Spectral Density	20
6.2.1 Test Setup	20
6.2.2 Test Procedure	20
6.3 6 dB Bandwidth	21
6.3.1 Test Setup	21
6.3.2 Test Procedure	21
6.4 Conducted Out of Band Emissions	21
6.4.1 Test Setup	21
6.4.2 Test Procedure	21
6.5 AC Power Conducted Emissions	22
6.5.1 Test Setup	22
6.5.2 Test Procedure	22
6.6 Unwanted Emissions below 1 GHz	23
6.6.1 Test Setup	23
6.6.2 Test Procedure	24
6.7 Unwanted Emissions above 1 GHz	25
6.7.1 Test Setup	25
6.7.2 Test Procedure	25
7 Test Results of Test Item	26



7.1	RF Output Power.....	26
7.2	Power Spectral Density	29
7.3	6 dB Bandwidth	32
7.4	Conducted Out of Band Emissions	34
7.5	AC Power Conducted Emissions	42
7.6	Unwanted Emissions below 1 GHz	44
7.7	Unwanted Emissions above 1 GHz.....	46
8	Pictures of Test Arrangements	62
9	Information of the Testing Laboratories	63



Release Control Record

Issue No.	Description	Date Issued
RFBEIU-WTW-P23030111	Original release.	2023/4/22

1 Certificate

Product: Owl Bar

Brand: OWL LABS

Test Model: FRS100

Series Model: FRS100****(* can be 0-9, A-Z, a-z, -, dot or blank or any alphanumeric)

Sample Status: Engineering sample

Applicant: Owl Labs Inc.

Test Date: 2023/4/7 ~ 2023/4/11

Standard: 47 CFR FCC Part 15, Subpart C (Section 15.247)

Measurement ANSI C63.10-2013

procedure:

KDB 558074 D01 15.247 Meas Guidance v05r02

KDB 662911 D01 Multiple Transmitter Output v02r01

The above equipment has been tested by **Bureau Veritas Consumer Products Services (H.K.) Ltd., Taoyuan Branch**, and found compliance with the requirement of the above standards. The test record, data evaluation & Equipment Under Test (EUT) configurations represented herein are true and accurate accounts of the measurements of the sample's RF characteristics under the conditions specified in this report.

2 Summary of Test Results

47 CFR FCC Part 15, Subpart C (Section 15.247)			
Standard / Clause	Test Item	Result	Remark
15.247(b)	RF Output Power	Pass	Meet the requirement of limit.
15.247(e)	Power Spectral Density	Pass	Meet the requirement of limit.
15.247(a)(2)	6 dB Bandwidth	Pass	Meet the requirement of limit.
15.247(d)	Conducted Out of Band Emissions	Pass	Meet the requirement of limit.
15.207	AC Power Conducted Emissions	Pass	Minimum passing margin is -16.92 dB at 0.16600 MHz
15.205 / 15.209 / 15.247(d)	Unwanted Emissions below 1 GHz	Pass	Minimum passing margin is -3.7 dB at 31.50 MHz
15.205 / 15.209 / 15.247(d)	Unwanted Emissions above 1 GHz	Pass	Minimum passing margin is -2.6 dB at 2483.50 MHz
15.203	Antenna Requirement	Pass	Antenna connector is IPEX not a standard connector.

Note: Determining compliance based on the results of the compliance measurement, not taking into account measurement instrumentation uncertainty.

2.1 Measurement Uncertainty

Where relevant, the following measurement uncertainty levels have been estimated for tests performed on the EUT as specified in CISPR 16-4-2:

Measurement	Specification	Expanded Uncertainty (k=2) (±)
Conducted Out of Band Emissions	9 kHz ~ 40 GHz	2.63 dB
AC Power Conducted Emissions	150 kHz ~ 30 MHz	3.00 dB
Unwanted Emissions below 1 GHz	9 kHz ~ 30 MHz	2.38 dB
	30 MHz ~ 1 GHz	5.7 dB
Unwanted Emissions above 1 GHz	1 GHz ~ 6 GHz	4.83 dB
	6 GHz ~ 18 GHz	5.37 dB
	18 GHz ~ 40 GHz	5.24 dB

The other instruments specified are routine verified to remain within the calibrated levels, no measurement uncertainty is required to be calculated.

2.2 Supplementary Information

There is not any deviation from the test standards for the test method, and no modifications required for compliance.

3 General Information

3.1 General Description

Product	Owl Bar
Brand	OWL LABS
Test Model	FRS100
Series Model	FRS100*****(* can be 0-9, A-Z, a-z ,-, dot or blank or any alphanumeric)
Model Difference	Marketing Differentiation
Status of EUT	Engineering sample
Power Supply Rating	19.5Vdc from Adapter
Modulation Type	CCK, DQPSK, DBPSK for DSSS 64QAM, 16QAM, QPSK, BPSK for OFDM 256QAM for OFDM in VHT mode 1024QAM for OFDMA in 11ax mode only
Modulation Technology	DSSS, OFDM, OFDMA
Transfer Rate	Up to 573.5 Mbps
Operating Frequency	2.412 GHz ~ 2.462 GHz
Number of Channel	802.11b, 802.11g, 802.11n (HT20), VHT20, 802.11ax (HE20):11 802.11n (HT40), VHT40, 802.11ax (HE40):7
Output Power	456.668 mW (26.6 dBm)

Note:

1. The EUT uses following accessories.

Item	Brand	Model	Specification
AC Adapter	APD	DA-65C19	AC Input : 100-240Vac, 50-60Hz, 1.6A Max DC Output : 19.5Vdc, 3.42A, 64.98W AC Cable : non-shielded without core, 1.5m DC Cable : non-shielded with a core, 1.5m
Type C cable (Optional)	-	-	Signal Line : shielded without core, 1.5m Signal Line : shielded without core, 2m
HDMI Cable (Optional)	-	-	Signal Line : shielded without core, 1.5m

2. There are Bluetooth and WLAN (2.4 GHz & 5 GHz) technology used for the EUT.

3. WLAN 2.4 GHz & WLAN 5 GHz & Bluetooth technology cannot transmit at same time.

4. The above EUT information is declared by manufacturer and for more detailed features description, please refer to the manufacturer's specifications or User's Manual.

3.2 Antenna Description of EUT

1. The antenna information is listed as below.

Antenna No.	Gain (dBi)	Antenna Type	Connector Type
1	4.56	FPCB Dipole	IPEX
2	3.02	FPCB Dipole	IPEX

* Detail antenna specification please refer to antenna datasheet and/or antenna measurement report.

2. The EUT incorporates a MIMO function:

Modulation Mode	TX & RX Configuration	
802.11b	2TX	2RX
802.11g	2TX	2RX
802.11n (HT20)	2TX	2RX
802.11n (HT40)	2TX	2RX
VHT20	2TX	2RX
VHT40	2TX	2RX
802.11ax (HE20)	2TX	2RX
802.11ax (HE40)	2TX	2RX

Note: The modulation and bandwidth are similar for 802.11n mode for 20 MHz (40 MHz), VHT mode for 20 MHz (40 MHz) and 802.11ax mode for 20 MHz (40 MHz) therefore the manufacturer will control the power for 802.11n/VHT mode is same as the 802.11ax mode or more lower than it and investigated worst case to representative mode in test report.

3.3 Channel List

11 channels are provided for 802.11b, 802.11g, 802.11n (HT20), VHT20, 802.11ax (HE20):

Channel	Frequency	Channel	Frequency
1	2412 MHz	7	2442 MHz
2	2417 MHz	8	2447 MHz
3	2422 MHz	9	2452 MHz
4	2427 MHz	10	2457 MHz
5	2432 MHz	11	2462 MHz
6	2437 MHz		

7 channels are provided for 802.11n (HT40), VHT40, 802.11ax (HE40):

Channel	Frequency	Channel	Frequency
3	2422 MHz	7	2442 MHz
4	2427 MHz	8	2447 MHz
5	2432 MHz	9	2452 MHz
6	2437 MHz		

3.4 Test Mode Applicability and Tested Channel Detail

Pre-Scan:	1. EUT can be used in the following ways: XYZ 3-axis. Pre-scan in these ways and find the worst case as a representative test condition.
Worst Case:	1. X/ Y/ Z Worst Condition: X Axis for Unwanted Emission above 1GHz and Unwanted Emission below 1GHz.

Following channel(s) was (were) selected for the final test as listed below:

Test Item	Mode	Signal Mode	Tested Channel	Modulation	Data Rate Parameter
RF Output Power	802.11b	CDD	1, 6, 11	DBPSK	1Mb/s
	802.11g	CDD	1, 6, 11	BPSK	6Mb/s
	VHT20	CDD	1, 6, 11	BPSK	MCS0
	VHT40	CDD	3, 6, 9	BPSK	MCS0
	802.11ax (HE20)	CDD	1, 6, 11	BPSK	MCS0
	802.11ax (HE40)	CDD	3, 6, 9	BPSK	MCS0
6 dB Bandwidth / Conducted Out of Band Emissions / Power Spectral Density	802.11b	CDD	1, 6, 11	DBPSK	1Mb/s
	802.11g	CDD	1, 6, 11	BPSK	6Mb/s
	802.11ax (HE20)	CDD	1, 6, 11	BPSK	MCS0
	802.11ax (HE40)	CDD	3, 6, 9	BPSK	MCS0
AC Power Conducted Emissions	802.11ax (HE40)	CDD	6	BPSK	MCS0
Unwanted Emissions below 1 GHz	802.11ax (HE40)	CDD	6	BPSK	MCS0
Unwanted Emissions above 1 GHz	802.11b	CDD	1, 6, 11	DBPSK	1Mb/s
	802.11g	CDD	1, 6, 11	BPSK	6Mb/s
	802.11ax (HE20)	CDD	1, 6, 11	BPSK	MCS0
	802.11ax (HE40)	CDD	3, 6, 9	BPSK	MCS0

3.5 Duty Cycle of Test Signal

802.11b: Duty cycle = 0.664 ms / 0.677 ms x 100% = 98.1%

802.11g: Duty cycle = 1.976 ms / 1.992 ms x 100% = 99.2%

802.11ax (HE20): Duty cycle = 5.446 ms / 5.46 ms x 100% = 99.7%

802.11ax (HE40): Duty cycle = 5.445 ms / 5.459 ms x 100% = 99.7%

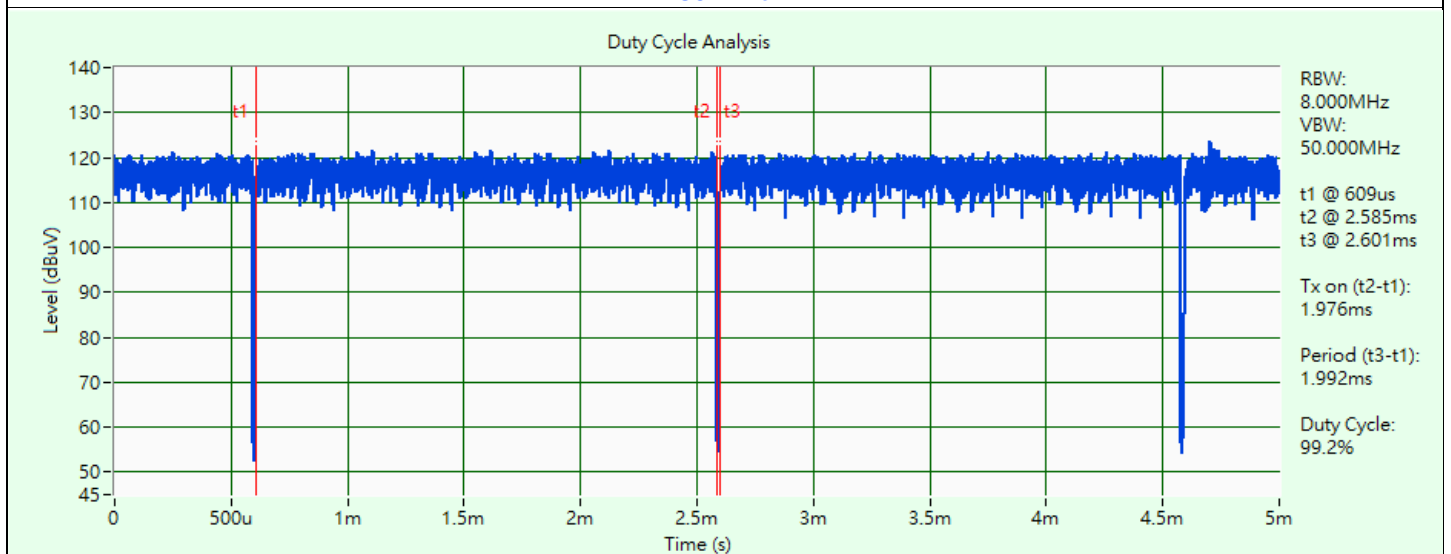
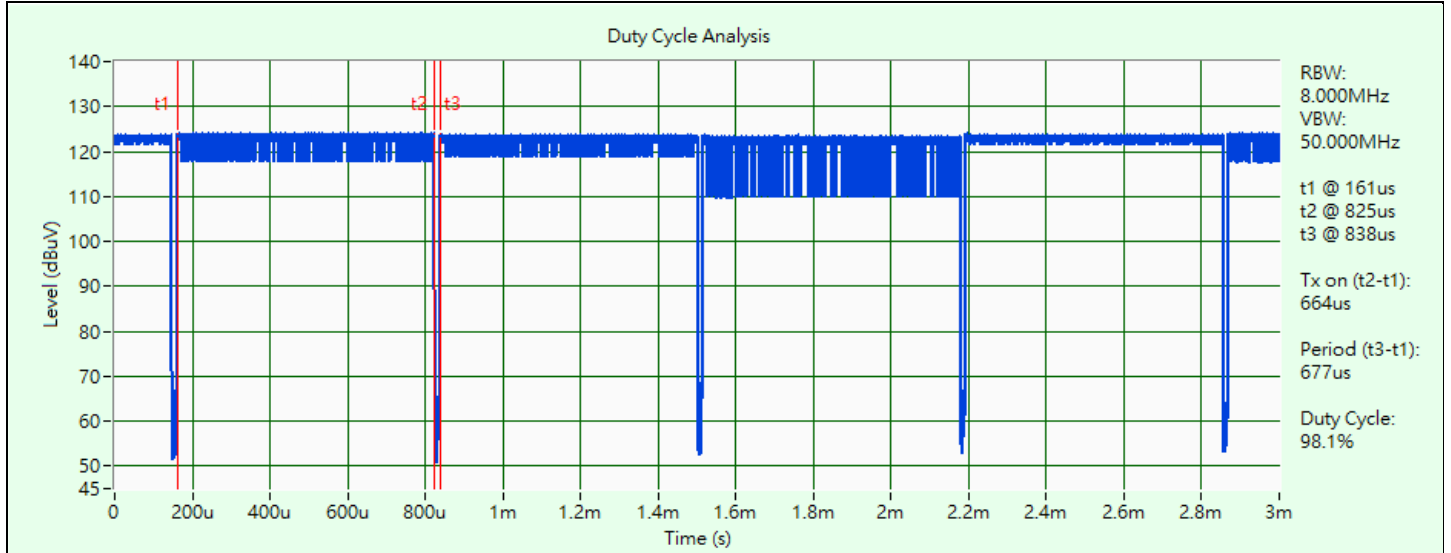

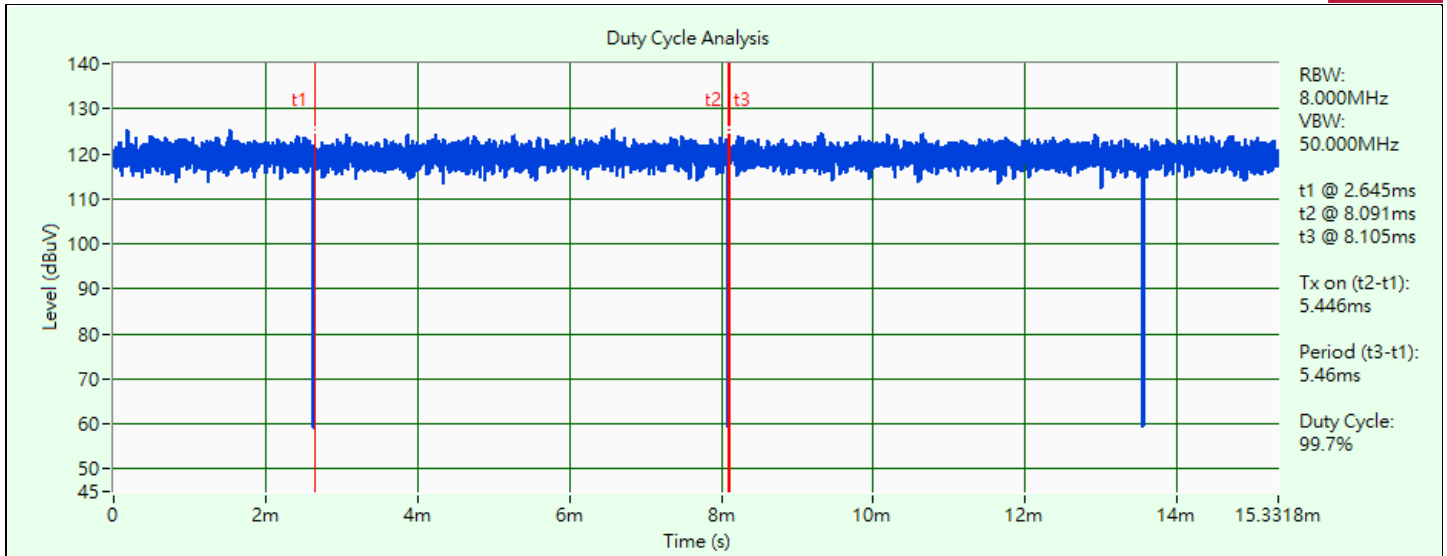

802.11ax (HE20)

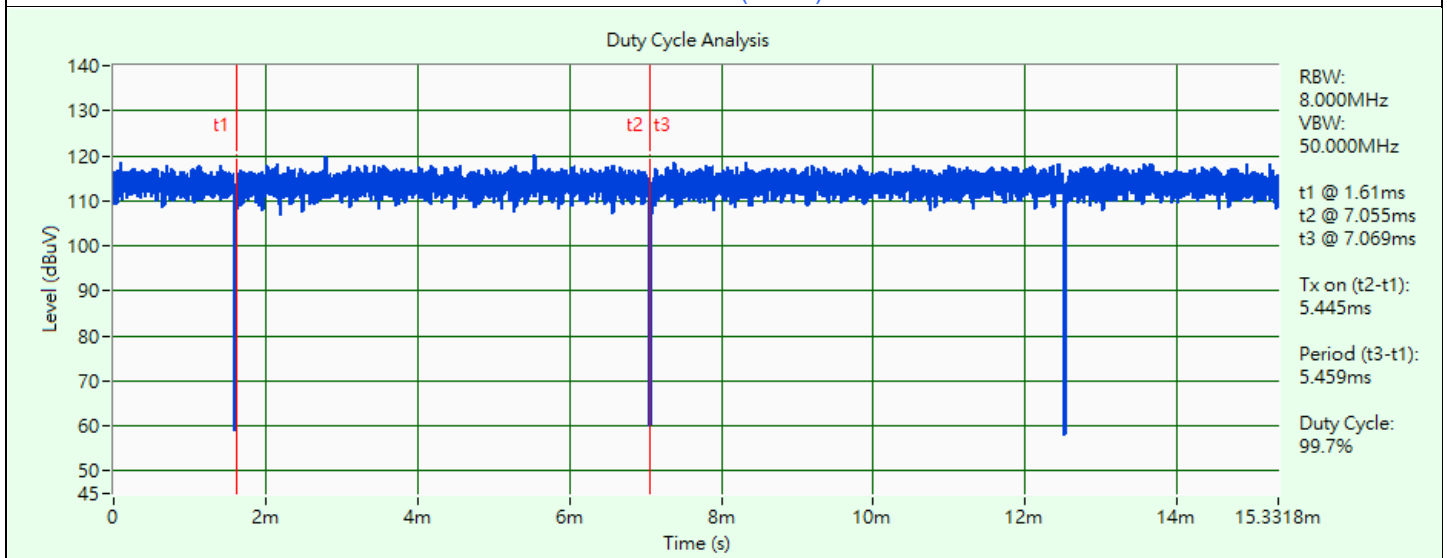

802.11ax (HE40)

3.6 Test Program Used and Operation Descriptions

Controlling software (QRCT v4.0.00204.0) has been activated to set the EUT under transmission condition continuously at specific channel frequency.

3.7 Connection Diagram of EUT and Peripheral Devices

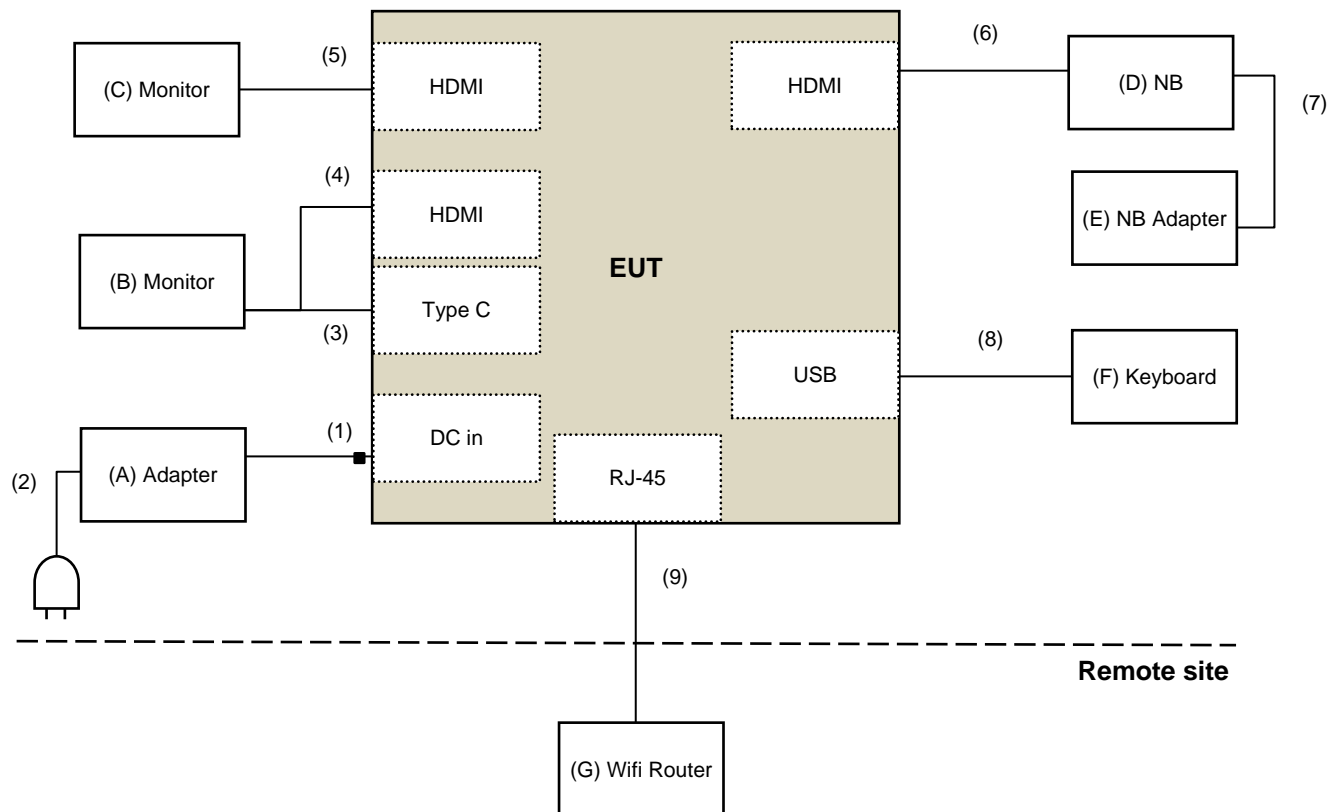

3.8 Configuration of Peripheral Devices and Cable Connections

ID	Product	Brand	Model No.	Serial No.	FCC ID	Remarks
A	Adapter	APD	DA-65C19	N/A	N/A	Supplied by applicant
B	Monitor	ASUS	PA279CV	M7LMTF235959	DoC	Provided by Lab
C	Monitor	ASUS	PA279CV	M7LMTF235956	DoC	Provided by Lab
D	NB	Lenovo	N/A	N/A	N/A	Provided by Lab
E	NB Adapter	Lenovo	ADLX65CGU2A	N/A	N/A	Provided by Lab
F	Keyboard	BTC	N/A	N/A	N/A	Provided by Lab
G	Wifi Router	NETGEAR	R6350	58E798BW001B3	DoC	Provided by Lab

ID	Cable Descriptions	Qty.	Length (m)	Shielding (Yes/No)	Cores (Qty.)	Remarks
1	DC cable	1	1.5	N	1	Supplied by applicant
2	AC cable	1	1.5	N	0	Supplied by applicant
3	Type C cable	1	2	Y	0	Supplied by applicant
4	HDMI cable	1	1.5	Y	0	Supplied by applicant
5	HDMI cable	1	1.5	Y	0	Supplied by applicant
6	HDMI cable	1	2	Y	0	Provided by Lab
7	DC cable	1	1.8	Y	0	Provided by Lab
8	USB cable	1	1.6	Y	0	Provided by Lab
9	RJ-45 cable	1	10	N	0	Provided by Lab

4 Test Instruments

The calibration interval of the all test instruments are 12 months and the calibrations are traceable to NML/ROC and NIST/USA.

4.1 RF Output Power

Description Manufacturer	Model No.	Serial No.	Calibrated Date	Calibrated Until
MIMO Power measurement Test set (4X4) KEYSIGHT	U2021XA	U2021XA_001	2022/6/13	2023/6/12
MXG Vector Signal Generator KEYSIGHT	N5182B	MY53052658	2022/5/9	2023/5/8
Peak Power meter Anritsu	ML2495A	0842014	2022/4/27	2023/4/26
Pulse Power Sensor Anritsu	MA2411B	0738404	2022/4/27	2023/4/26
Spectrum Analyzer KEYSIGHT	N9030A	MY54490260	2022/7/14	2023/7/13
Spectrum Analyzer R&S	FSV40	101042	2022/9/5	2023/9/4
		101544	2022/5/9	2023/5/8
Temperature & Humidity Chamber TERCHY	MHU-225AU	920409	2022/6/27	2023/6/26
Voltage Meter FLUKE	179	89610322	2022/10/3	2023/10/2

Notes:

1. The test was performed in LK - Oven
2. Tested Date: 2023/4/10 ~ 2023/4/11

4.2 Power Spectral Density

Refer to section 4.1 to get information of the instruments.

4.3 6 dB Bandwidth

Refer to section 4.1 to get information of the instruments.

4.4 Conducted Out of Band Emissions

Refer to section 4.1 to get information of the instruments.

4.5 AC Power Conducted Emissions

Description Manufacturer	Model No.	Serial No.	Calibrated Date	Calibrated Until
50 ohm terminal LYNICS	0900510	E1-011285	2022/9/19	2023/9/18
		E1-011286	2022/9/19	2023/9/18
50 Ohms Terminator LYNICS	0900510	E1-01-305	2023/2/13	2024/2/12
Attenuator STI	STI02-2200-10	NO.4	2022/9/2	2023/9/1
DC LISN R&S	ESH3-Z6	100219	2022/8/2	2023/8/1
		844950/018	2022/8/2	2023/8/1
DC LISN Schwarzbeck	NNLK 8121	8121-808	2022/4/29	2023/4/28
High Voltage Probe Schwarzbeck	TK9420	00982	2022/12/14	2023/12/13
Isolation Transformer Erika Fiedler	D-65396	017	2022/9/8	2023/9/7
LISN R&S	ENV216	101196	2022/5/24	2023/5/23
LISN Schwarzbeck	NNLK 8121	8121-731	2022/5/26	2023/5/25
		8121-00759	2022/8/18	2023/8/17
	NNLK8129	8129229	2022/6/8	2023/6/7
	NSLK 8128	8128-244	2022/11/8	2023/11/7
RF Coaxial Cable Commate	5D-FB	Cable-CO5-01	2023/1/19	2024/1/18
Software BVADT	Cond_V7.3.7.4	N/A	N/A	N/A
Test Receiver R&S	ESR3	102412	2022/12/21	2023/12/20

Notes:

1. The test was performed in Linkou Conduction 5.
2. Tested Date: 2023/4/7

4.6 Unwanted Emissions below 1 GHz

Description Manufacturer	Model No.	Serial No.	Calibrated Date	Calibrated Until
* LOOP ANTENNA EMCI	LPA600	270	2021/9/2	2023/9/1
Bi_Log Antenna Schwarzbeck	VULB 9168	137	2022/10/21	2023/10/20
Coupling/Dcoupling Network Schwarzbeck	CDNE-M2	00097	2022/6/1	2023/5/31
	CDNE-M3	00091	2022/6/1	2023/5/31
Pre_Amplifier EMCI	EMC001340	980269	2022/6/28	2023/6/27
Pre_Amplifier HP	8447D	2432A03504	2023/2/16	2024/2/15
RF Coaxial Cable Pacific	8D-FB	Cable-CH6-02	2022/6/30	2023/6/29
Software BVADT	Radiated_V7.7.1.1.1	N/A	N/A	N/A
	Radiated_V8.7.08	N/A	N/A	N/A
Spectrum Analyzer R&S	FSV40	101544	2022/5/9	2023/5/8
Test Receiver Agilent	N9038A	MY51210129	2023/3/24	2024/3/23
		MY51210137	2022/6/9	2023/6/8
Tower ADT	AT100	0306	N/A	N/A
Turn Table ADT	TT100	0306	N/A	N/A

Notes:

1. * The calibration interval of the above test instruments is 24 months and the calibrations are traceable to NML/ROC and NIST/USA
2. The test was performed in Linkou 966 Chamber 6 (CH 6).
3. Tested Date: 2023/4/8

4.7 Unwanted Emissions above 1 GHz

Description Manufacturer	Model No.	Serial No.	Calibrated Date	Calibrated Until
Band Pass Filter MICRO-TRONICS	BRM17690	005	2022/5/26	2023/5/25
Boresight antenna tower fixture BV	BAF-02	6	N/A	N/A
High Pass Filter Wainwright Instruments	WHK 3.1/18G-10SS	SN 8	2022/5/26	2023/5/25
Horn Antenna EMCO	3115	00028257	2022/11/13	2023/11/12
Horn Antenna ETS-Lindgren	3117-PA	00215857	2023/2/3	2024/2/2
Horn Antenna Schwarzbeck	BBHA 9170	212	2022/10/20	2023/10/19
Notch Filter MICRO-TRONICS	BRC50703-01	010	2022/5/26	2023/5/25
Pre-amplifier HP	8449B	3008A01201	2023/2/16	2024/2/15
Pre-amplifier (18GHz-40GHz) EMCI	EMC184045B	980175	2022/9/3	2023/9/2
Pre_Amplifier EMCI	EMC0126545	980076	2023/2/16	2024/2/15
	EMC184045B	980235	2023/2/16	2024/2/15
RF Coaxial Cable EM	EM102-KMKM-3.5+1M	EM102-KMKM-3.5+1M-01	2022/7/7	2023/7/6
RF Coaxial Cable EMCI	EMC104	190801	2022/9/20	2023/9/19
		190804	2022/9/20	2023/9/19
RF Coaxial Cable HUBER SUHNER	SF-104	Cable-CH6-01	2022/9/20	2023/9/19
Software BVADT	Radiated_V7.7.1.1.1	N/A	N/A	N/A
	Radiated_V8.7.08	N/A	N/A	N/A
Spectrum Analyzer R&S	FSV40	101042	2022/9/5	2023/9/4
		101544	2022/5/9	2023/5/8
Test Receiver Agilent	N9038A	MY51210129	2023/3/24	2024/3/23
Tower ADT	AT100	0306	N/A	N/A
Turn Table ADT	TT100	0306	N/A	N/A

Notes:

1. The test was performed in Linkou 966 Chamber 6 (CH 6).
2. Tested Date: 2023/4/10 ~ 2023/4/11

5 Limits of Test Items

5.1 RF Output Power

For systems using digital modulation in the 2400–2483.5 MHz bands: 1 Watt (30 dBm)

Per KDB 662911 D01 Multiple Transmitter Output Method of conducted output power measurement on IEEE 802.11 devices,

Array Gain = 0 dB (i.e., no array gain) for $N_{ANT} \leq 4$;

Array Gain = 0 dB (i.e., no array gain) for channel widths ≥ 40 MHz for any N_{ANT} ;

Array Gain = $5 \log(N_{ANT}/N_{SS})$ dB or 3 dB, whichever is less, for 20-MHz channel widths with $N_{ANT} \geq 5$.

For power measurements on all other devices: Array Gain = $10 \log(N_{ANT}/N_{SS})$ dB.

5.2 Power Spectral Density

The Maximum of Power Spectral Density Measurement is 8 dBm in any 3 kHz.

5.3 6 dB Bandwidth

The minimum of 6 dB Bandwidth Measurement is 0.5 MHz.

5.4 Conducted Out of Band Emissions

Below 20 dB of the highest emission level of operating band (in 100 kHz Resolution Bandwidth).

5.5 AC Power Conducted Emissions

Frequency (MHz)	Conducted Limit (dBuV)	
	Quasi-peak	Average
0.15 - 0.5	66 - 56	56 - 46
0.50 - 5.0	56	46
5.0 - 30.0	60	50

Notes:

1. The lower limit shall apply at the transition frequencies.
2. The limit decreases in line with the logarithm of the frequency in the range of 0.15 to 0.50 MHz.

5.6 Unwanted Emissions below 1 GHz

Radiated emissions up to 1 GHz which fall in the restricted bands must comply with the radiated emission limits specified as below table. Other emissions shall be at least 20 dB below the highest level of the desired power:

Frequencies (MHz)	Field Strength (microvolts/meter)	Measurement Distance (meters)
0.009 ~ 0.490	2400/F(kHz)	300
0.490 ~ 1.705	24000/F(kHz)	30
1.705 ~ 30.0	30	30
30 ~ 88	100	3
88 ~ 216	150	3
216 ~ 960	200	3
Above 960	500	3

Notes:

1. The lower limit shall apply at the transition frequencies.
2. Emission level (dBuV/m) = 20 log Emission level (uV/m).

5.7 Unwanted Emissions above 1 GHz

Radiated emissions above 1 GHz which fall in the restricted bands must comply with the radiated emission limits specified as below table. Other emissions shall be at least 20 dB below the highest level of the desired power:

Frequencies (MHz)	Field Strength (microvolts/meter)	Measurement Distance (meters)
Above 960	500	3

Notes:

1. The lower limit shall apply at the transition frequencies.
2. Emission level (dBuV/m) = 20 log Emission level (uV/m).
3. For frequencies above 1000 MHz, the field strength limits are based on average detector, however, the peak field strength of any emission shall not exceed the maximum permitted average limits, specified above by more than 20 dB under any condition of modulation.

6 Test Arrangements

6.1 RF Output Power

6.1.1 Test Setup

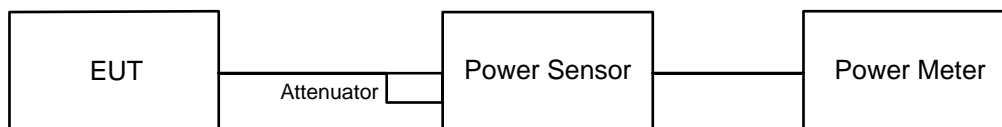

6.1.2 Test Procedure

Peak Power:

A peak power sensor was used on the output port of the EUT. A power meter was used to read the response of the peak power sensor. Record the power level.

Average Power:

Average power sensor was used to perform output power measurement, trigger and gating function of wide band power meter is enabled to measure max output power of TX on burst. Duty factor is not added to measured value.

6.2 Power Spectral Density

6.2.1 Test Setup

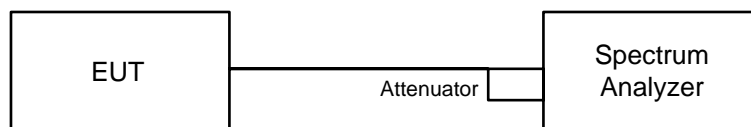

6.2.2 Test Procedure

- a. Set analyzer center frequency to DTS channel center frequency.
- b. Set the span to 1.5 times the DTS bandwidth.
- c. Set the RBW to: 3 kHz.
- d. Set the VBW $\geq 3 \times$ RBW.
- e. Detector = peak.
- f. Sweep time = auto couple.
- g. Trace mode = max hold.
- h. Allow trace to fully stabilize.
- i. Use the peak marker function to determine the maximum amplitude level within the RBW.

6.3 6 dB Bandwidth

6.3.1 Test Setup

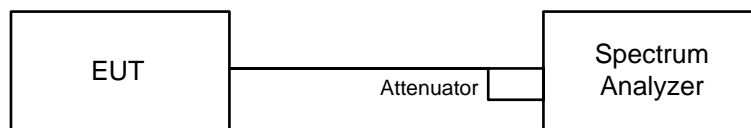

6.3.2 Test Procedure

- Set resolution bandwidth (RBW) = 100 kHz.
- Set the video bandwidth (VBW) $\geq 3 \times$ RBW, Detector = Peak.
- Trace mode = max hold.
- Sweep = auto couple.
- Measure the maximum width of the emission that is constrained by the frequencies associated with the two amplitude points (upper and lower) that are attenuated by 6 dB relative to the maximum level measured in the fundamental emission.

6.4 Conducted Out of Band Emissions

6.4.1 Test Setup

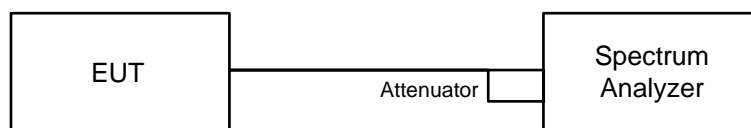

6.4.2 Test Procedure

MEASUREMENT PROCEDURE REF

- Set the RBW = 100 kHz.
- Set the VBW ≥ 300 kHz.
- Detector = peak.
- Sweep time = auto couple.
- Trace mode = max hold.
- Allow trace to fully stabilize.
- Use the peak marker function to determine the maximum power level in any 100 kHz band segment within the fundamental EBW.

MEASUREMENT PROCEDURE OOB

- Set RBW = 100 kHz.
- Set VBW ≥ 300 kHz.
- Detector = peak.
- Sweep = auto couple.
- Trace Mode = max hold.
- Allow trace to fully stabilize.
- Use the peak marker function to determine the maximum amplitude level.

6.5 AC Power Conducted Emissions

6.5.1 Test Setup

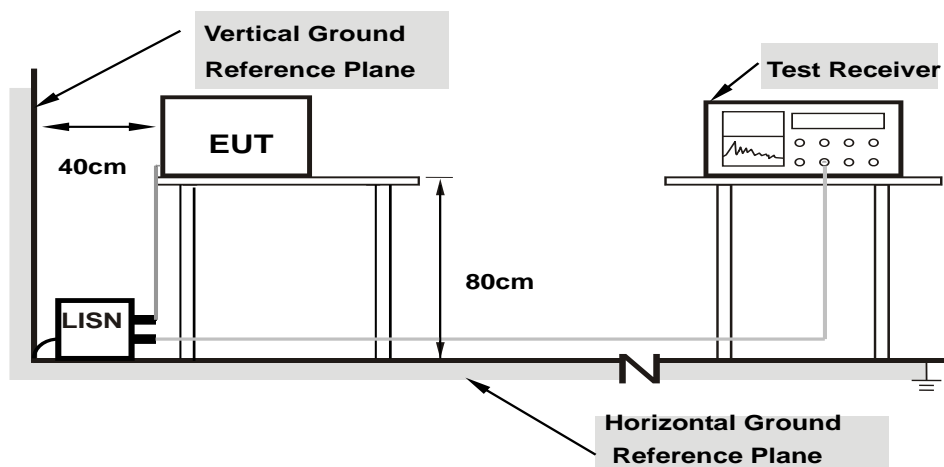

Note: 1.Support units were connected to second LISN.

For the actual test configuration, please refer to the attached file (Test Setup Photo).

6.5.2 Test Procedure

- The EUT was placed on a 0.8 meter to the top of table and placed 0.4 meters from the conducting wall of the shielded room with EUT being connected to the power mains through a line impedance stabilization network (LISN). Other support units were connected to the power mains through another LISN. The two LISNs provide 50 ohm/ 50 uH of coupling impedance for the measuring instrument.
- Both lines of the power mains connected to the EUT were checked for maximum conducted interference.
- The frequency range from 150 kHz to 30 MHz was searched. Emission levels under (Limit – 20 dB) was not recorded.

Note: The resolution bandwidth and video bandwidth of test receiver is 9 kHz for quasi-peak detection (QP) and average detection (AV) at frequency 0.15 MHz-30 MHz.

6.6 Unwanted Emissions below 1 GHz

6.6.1 Test Setup

For Radiated emission below 30 MHz

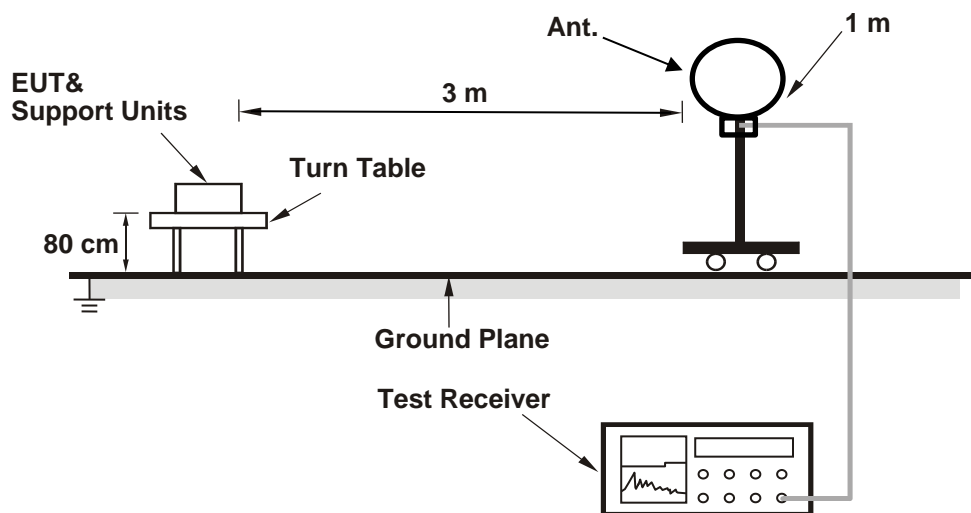

For Radiated emission above 30 MHz

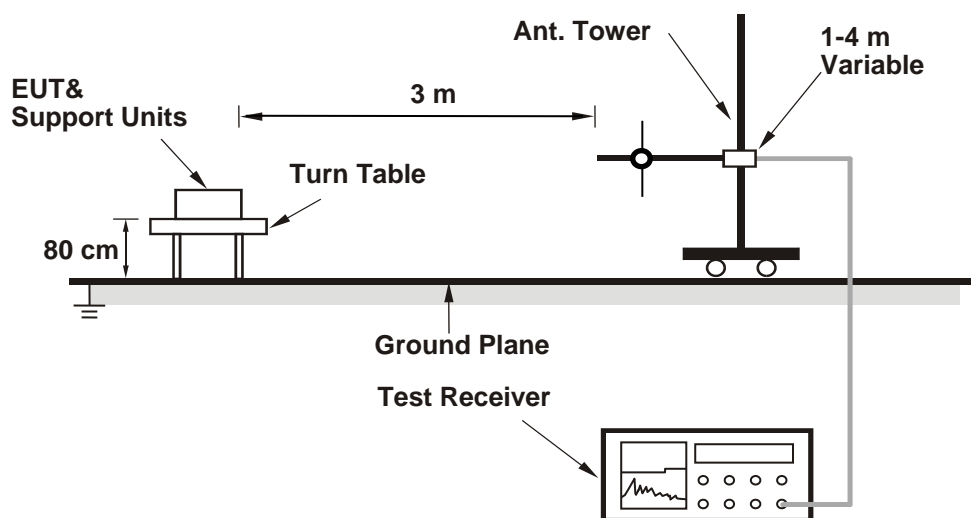

For the actual test configuration, please refer to the attached file (Test Setup Photo).

6.6.2 Test Procedure

For Radiated emission below 30 MHz

- a. The EUT was placed on the top of a rotating table 0.8 meters above the ground at 3 meter chamber room for test. The table was rotated 360 degrees to determine the position of the highest radiation.
- b. The EUT was set 3 meters away from the interference-receiving antenna, which was mounted on the top of a variable-height antenna tower.
- c. Parallel, perpendicular, and ground-parallel orientations of the antenna are set to make the measurement.
- d. For each suspected emission, the EUT was arranged to its worst case and the rotatable table was turned from 0 degrees to 360 degrees to find the maximum reading.
- e. The test-receiver system was set to Quasi-Peak Detect Function and Specified Bandwidth with Maximum Hold Mode, except for the frequency band (9 kHz to 90 kHz and 110 kHz to 490 kHz) set to average detect function and peak detect function.

Notes:

1. The resolution bandwidth and video bandwidth of test receiver/spectrum analyzer is 200 Hz at frequency below 150 kHz.
2. The resolution bandwidth and video bandwidth of test receiver/spectrum analyzer is 9 kHz or 10 kHz at frequency (150 kHz to 30 MHz).
3. All modes of operation were investigated and the worst-case emissions are reported.

For Radiated emission above 30 MHz

- a. The EUT was placed on the top of a rotating table 0.8 meters above the ground at 3 meter chamber room for test. The table was rotated 360 degrees to determine the position of the highest radiation.
- b. The EUT was set 3 meters away from the interference-receiving antenna, which was mounted on the top of a variable-height antenna tower.
- c. The height of antenna is varied from one meter to four meters above the ground to determine the maximum value of the field strength. Both horizontal and vertical polarizations of the antenna are set to make the measurement.
- d. For each suspected emission, the EUT was arranged to its worst case and then the antenna was tuned to heights from 1 meter to 4 meters and the rotatable table was turned from 0 degrees to 360 degrees to find the maximum reading.
- e. The test-receiver system was set to quasi-peak detect function and specified bandwidth with maximum hold mode when the test frequency is below 1 GHz.

Notes:

1. The resolution bandwidth and video bandwidth of test receiver/spectrum analyzer is 120 kHz for Quasi-peak detection (QP) at frequency below 1 GHz.
2. All modes of operation were investigated and the worst-case emissions are reported.

6.7 Unwanted Emissions above 1 GHz

6.7.1 Test Setup

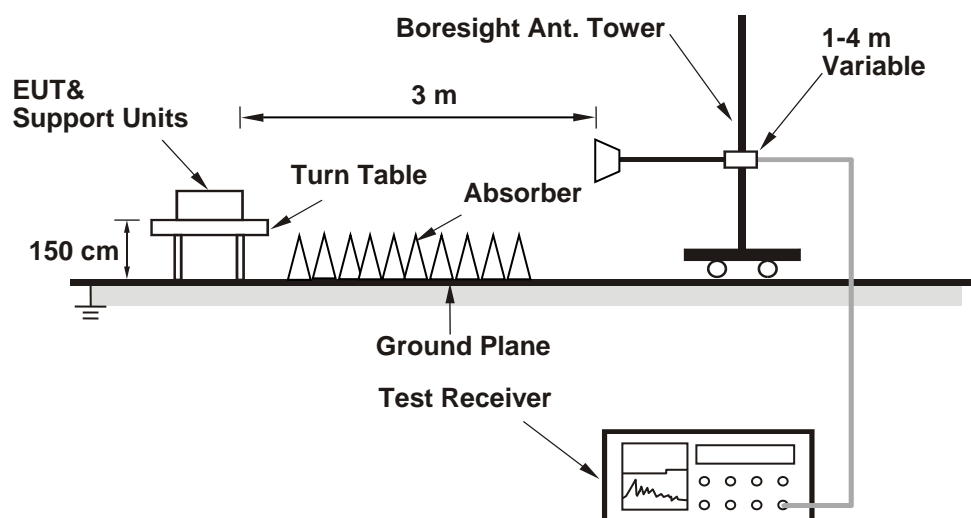

For the actual test configuration, please refer to the attached file (Test Setup Photo).

6.7.2 Test Procedure

- The EUT was placed on the top of a rotating table 1.5 meters above the ground at 3 meter chamber room for test. The table was rotated 360 degrees to determine the position of the highest radiation.
- The EUT was set 3 meters away from the interference-receiving antenna, which was mounted on the top of a variable-height antenna tower.
- The height of antenna is varied from one meter to four meters above the ground to determine the maximum value of the field strength. Both horizontal and vertical polarizations of the antenna are set to make the measurement.
- For each suspected emission, the EUT was arranged to its worst case and then the antenna was tuned to heights from 1 meter to 4 meters and the rotatable table was turned from 0 degrees to 360 degrees to find the maximum reading.
- The test-receiver system was set to peak and average detects function and specified bandwidth with maximum hold mode when the test frequency is above 1 GHz. If the peak reading value also meets average limit, measurement with the average detector is unnecessary.

Notes:

- The resolution bandwidth of test receiver/spectrum analyzer is 1 MHz and the video bandwidth is 3 MHz for Peak detection (PK) and Average detection (AV) at frequency above 1 GHz.
- For fundamental and harmonic signal measurement, the resolution bandwidth of test receiver/spectrum analyzer is 1 MHz and the video bandwidth is $\geq 1/T$ (Duty cycle $< 98\%$) or 10 Hz (Duty cycle $\geq 98\%$) for Average detection (AV) at frequency above 1 GHz.
- All modes of operation were investigated and the worst-case emissions are reported.

7 Test Results of Test Item

7.1 RF Output Power

Input Power:	120 Vac, 60 Hz	Environmental Conditions:	25°C, 76% RH	Tested By:	Dalen Dai
--------------	----------------	---------------------------	--------------	------------	-----------

For Peak Power

802.11b

Chan.	Chan. Freq. (MHz)	Peak Power (dBm)		Total Power (mW)	Total Power (dBm)	Power Limit (dBm)	Test Result
		Chain 0	Chain 1				
1	2412	19.13	19.75	176.253	22.46	30	Pass
6	2437	19.16	20.04	183.339	22.63	30	Pass
11	2462	19.01	20.20	184.329	22.66	30	Pass

Notes:

1. Directional gain is the maximum gain of antennas.
2. The maximum gain is 4.56 dBi < 6 dBi, so the output power limit shall not be reduced.

802.11g

Chan.	Chan. Freq. (MHz)	Peak Power (dBm)		Total Power (mW)	Total Power (dBm)	Power Limit (dBm)	Test Result
		Chain 0	Chain 1				
1	2412	22.72	23.19	395.517	25.97	30	Pass
6	2437	22.87	23.51	418.03	26.21	30	Pass
11	2462	22.58	23.35	397.406	25.99	30	Pass

Notes:

1. Directional gain is the maximum gain of antennas.
2. The maximum gain is 4.56 dBi < 6 dBi, so the output power limit shall not be reduced.

VHT20

Chan.	Chan. Freq. (MHz)	Peak Power (dBm)		Total Power (mW)	Total Power (dBm)	Power Limit (dBm)	Test Result
		Chain 0	Chain 1				
1	2412	22.56	23.16	387.316	25.88	30	Pass
6	2437	22.28	23.36	385.815	25.86	30	Pass
11	2462	22.68	23.60	414.44	26.17	30	Pass

Notes:

1. Directional gain is the maximum gain of antennas.
2. The maximum gain is 4.56 dBi < 6 dBi, so the output power limit shall not be reduced.

VHT40

Chan.	Chan. Freq. (MHz)	Peak Power (dBm)		Total Power (mW)	Total Power (dBm)	Power Limit (dBm)	Test Result
		Chain 0	Chain 1				
3	2422	21.38	22.04	297.36	24.73	30	Pass
6	2437	23.11	23.72	440.149	26.44	30	Pass
9	2452	21.52	22.38	314.887	24.98	30	Pass

Notes:

1. Directional gain is the maximum gain of antennas.
2. The maximum gain is 4.56 dBi < 6 dBi, so the output power limit shall not be reduced.

802.11ax (HE20)

Chan.	Chan. Freq. (MHz)	Peak Power (dBm)		Total Power (mW)	Total Power (dBm)	Power Limit (dBm)	Test Result
		Chain 0	Chain 1				
1	2412	22.69	23.30	399.577	26.02	30	Pass
6	2437	22.44	23.51	399.776	26.02	30	Pass
11	2462	22.82	23.75	428.563	26.32	30	Pass

Notes:

1. Directional gain is the maximum gain of antennas.
2. The maximum gain is 4.56 dBi < 6 dBi, so the output power limit shall not be reduced.

802.11ax (HE40)

Chan.	Chan. Freq. (MHz)	Peak Power (dBm)		Total Power (mW)	Total Power (dBm)	Power Limit (dBm)	Test Result
		Chain 0	Chain 1				
3	2422	21.53	22.19	307.81	24.88	30	Pass
6	2437	23.27	23.88	456.668	26.60	30	Pass
9	2452	21.68	22.54	326.705	25.14	30	Pass

Notes:

1. Directional gain is the maximum gain of antennas.
2. The maximum gain is 4.56 dBi < 6 dBi, so the output power limit shall not be reduced.

For Average Power

802.11b

Chan.	Chan. Freq. (MHz)	Average Power (dBm)		Total Average Power (mW)	Total Average Power (dBm)
		Chain 0	Chain 1		
1	2412	16.68	17.39	101.386	20.06
6	2437	16.52	17.57	102.022	20.09
11	2462	16.47	17.70	103.245	20.14

802.11g

Chan.	Chan. Freq. (MHz)	Average Power (dBm)		Total Average Power (mW)	Total Average Power (dBm)
		Chain 0	Chain 1		
1	2412	15.44	16.22	76.874	18.86
6	2437	15.64	16.73	83.741	19.23
11	2462	15.27	16.56	78.941	18.97

VHT20

Chan.	Chan. Freq. (MHz)	Average Power (dBm)		Total Average Power (mW)	Total Average Power (dBm)
		Chain 0	Chain 1		
1	2412	15.60	16.24	78.38	18.94
6	2437	15.38	16.53	79.492	19.00
11	2462	15.49	16.74	82.606	19.17

VHT40

Chan.	Chan. Freq. (MHz)	Average Power (dBm)		Total Average Power (mW)	Total Average Power (dBm)
		Chain 0	Chain 1		
3	2422	13.88	14.35	51.661	17.13
6	2437	15.91	16.81	86.968	19.39
9	2452	13.68	14.87	54.025	17.33

802.11ax (HE20)

Chan.	Chan. Freq. (MHz)	Average Power (dBm)		Total Average Power (mW)	Total Average Power (dBm)
		Chain 0	Chain 1		
1	2412	15.76	16.37	81.021	19.09
6	2437	15.53	16.66	82.072	19.14
11	2462	15.64	16.88	85.397	19.31

802.11ax (HE40)

Chan.	Chan. Freq. (MHz)	Average Power (dBm)		Total Average Power (mW)	Total Average Power (dBm)
		Chain 0	Chain 1		
3	2422	14.03	14.48	53.347	17.27
6	2437	16.05	16.96	89.931	19.54
9	2452	13.81	15.02	55.812	17.47

7.2 Power Spectral Density

Input Power:	120 Vac, 60 Hz	Environmental Conditions:	25°C, 76% RH	Tested By:	Dalen Dai
--------------	----------------	---------------------------	--------------	------------	-----------

802.11b

TX chain	Channel	Freq. (MHz)	PSD (dBm/3kHz)	10 log (N=2) dB	Total PSD (dBm/3kHz)	PSD Limit (dBm/3kHz)	Pass / Fail
Chain 0	1	2412	-7.13	3.01	-4.12	7.17	Pass
	6	2437	-7.46	3.01	-4.45	7.17	Pass
	11	2462	-7.35	3.01	-4.34	7.17	Pass
Chain 1	1	2412	-6.15	3.01	-3.14	7.17	Pass
	6	2437	-5.68	3.01	-2.67	7.17	Pass
	11	2462	-5.78	3.01	-2.77	7.17	Pass

Notes:

- Method E) 2) c) Measure and add 10 log(NANT) dB of KDB 662911 is using for calculating total power density.
- Directional gain = $10 \log[(10^{\text{Chain0}/20} + 10^{\text{Chain1}/20})^2 / 2]$
- The directional gain is 6.83 dBi > 6 dBi, so the power density limit shall be reduced to $8 - (6.83 - 6) = 7.17$ dBm/3kHz.

802.11g

TX chain	Channel	Freq. (MHz)	PSD (dBm/3kHz)	10 log (N=2) dB	Total PSD (dBm/3kHz)	PSD Limit (dBm/3kHz)	Pass / Fail
Chain 0	1	2412	-10.11	3.01	-7.1	7.17	Pass
	6	2437	-9.95	3.01	-6.94	7.17	Pass
	11	2462	-10.3	3.01	-7.29	7.17	Pass
Chain 1	1	2412	-9.35	3.01	-6.34	7.17	Pass
	6	2437	-8.9	3.01	-5.89	7.17	Pass
	11	2462	-9.27	3.01	-6.26	7.17	Pass

Notes:

- Method E) 2) c) Measure and add 10 log(NANT) dB of KDB 662911 is using for calculating total power density.
- Directional gain = $10 \log[(10^{\text{Chain0}/20} + 10^{\text{Chain1}/20})^2 / 2]$
- The directional gain is 6.83 dBi > 6 dBi, so the power density limit shall be reduced to $8 - (6.83 - 6) = 7.17$ dBm/3kHz.

802.11ax (HE20)

TX chain	Channel	Freq. (MHz)	PSD (dBm/3kHz)	10 log (N=2) dB	Total PSD (dBm/3kHz)	PSD Limit (dBm/3kHz)	Pass / Fail
Chain 0	1	2412	-9.8	3.01	-6.79	7.17	Pass
	6	2437	-10.07	3.01	-7.06	7.17	Pass
	11	2462	-10.21	3.01	-7.2	7.17	Pass
Chain 1	1	2412	-9.66	3.01	-6.65	7.17	Pass
	6	2437	-9.61	3.01	-6.6	7.17	Pass
	11	2462	-8.88	3.01	-5.87	7.17	Pass

Notes:

1. Method E) 2) c) Measure and add 10 log(NANT) dB of KDB 662911 is using for calculating total power density.
2. Directional gain = $10 \log[(10^{\text{Chain0}/20} + 10^{\text{Chain1}/20})^2 / 2]$
3. The directional gain is 6.83 dBi > 6 dBi, so the power density limit shall be reduced to $8 - (6.83 - 6) = 7.17$ dBm/3kHz.

802.11ax (HE40)

TX chain	Channel	Freq. (MHz)	PSD (dBm/3kHz)	10 log (N=2) dB	Total PSD (dBm/3kHz)	PSD Limit (dBm/3kHz)	Pass / Fail
Chain 0	3	2422	-15.54	3.01	-12.53	7.17	Pass
	6	2437	-12.61	3.01	-9.6	7.17	Pass
	9	2452	-14.37	3.01	-11.36	7.17	Pass
Chain 1	3	2422	-13.46	3.01	-10.45	7.17	Pass
	6	2437	-11.9	3.01	-8.89	7.17	Pass
	9	2452	-13.22	3.01	-10.21	7.17	Pass

Notes:

1. Method E) 2) c) Measure and add 10 log(NANT) dB of KDB 662911 is using for calculating total power density.
2. Directional gain = $10 \log[(10^{\text{Chain0}/20} + 10^{\text{Chain1}/20})^2 / 2]$
3. The directional gain is 6.83 dBi > 6 dBi, so the power density limit shall be reduced to $8 - (6.83 - 6) = 7.17$ dBm/3kHz.



Spectrum Plot of Maximum Value

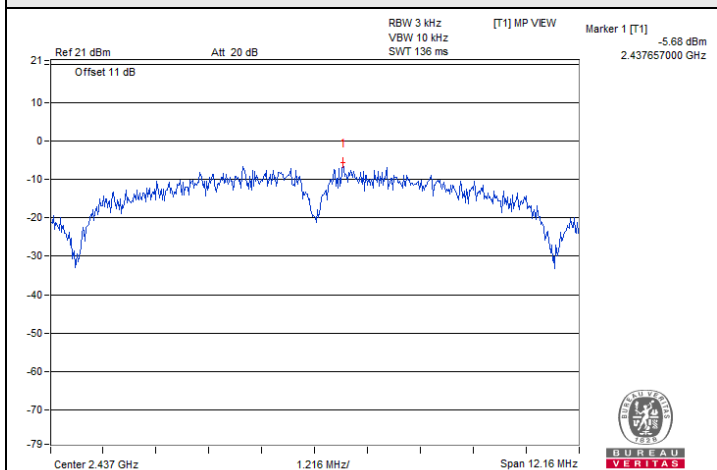

802.11b / Chain 1 : CH 6

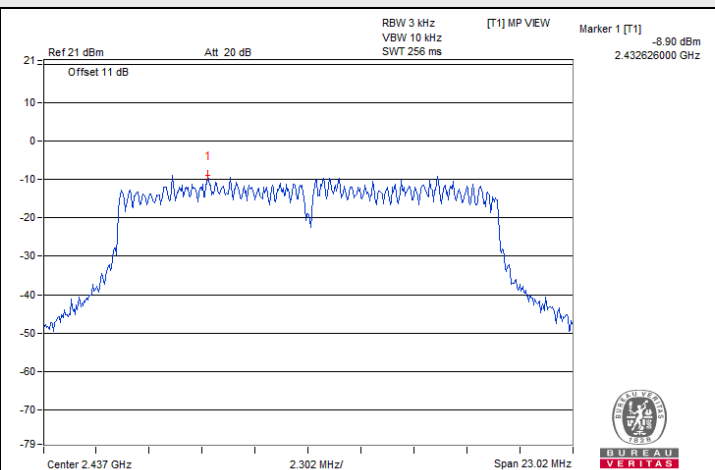

802.11g / Chain 1 : CH 6

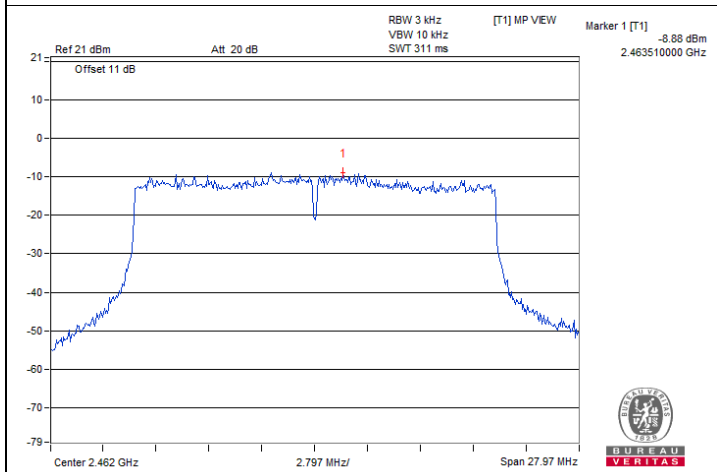

802.11ax (HE20) / Chain 1 : CH 11

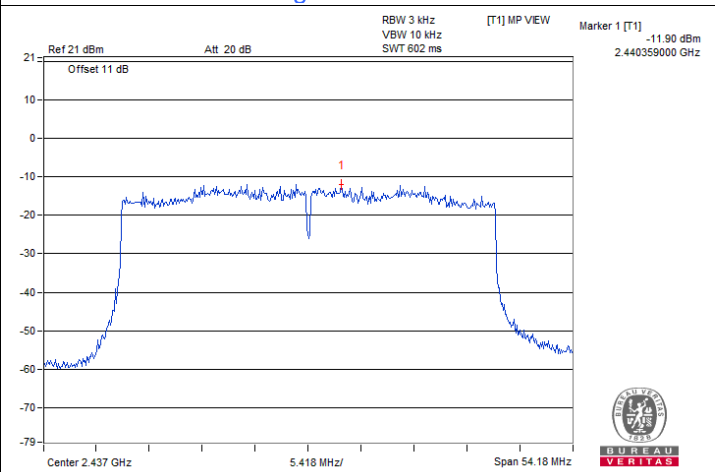

802.11ax (HE40) / Chain 1 : CH 6

7.3 6 dB Bandwidth

Input Power:	120 Vac, 60 Hz	Environmental Conditions:	25°C, 76% RH	Tested By:	Dalen Dai
--------------	----------------	---------------------------	--------------	------------	-----------

802.11b

Channel	Frequency (MHz)	6 dB Bandwidth (MHz)		Minimum Limit (MHz)	Test Result
		Chain 0	Chain 1		
1	2412	8.13	8.14	0.5	Pass
6	2437	8.61	8.11	0.5	Pass
11	2462	8.10	8.12	0.5	Pass

802.11g

Channel	Frequency (MHz)	6 dB Bandwidth (MHz)		Minimum Limit (MHz)	Test Result
		Chain 0	Chain 1		
1	2412	16.04	15.19	0.5	Pass
6	2437	16.13	15.35	0.5	Pass
11	2462	16.34	15.34	0.5	Pass

802.11ax (HE20)

Channel	Frequency (MHz)	6 dB Bandwidth (MHz)		Minimum Limit (MHz)	Test Result
		Chain 0	Chain 1		
1	2412	18.62	18.59	0.5	Pass
6	2437	18.70	18.85	0.5	Pass
11	2462	18.57	18.65	0.5	Pass

802.11ax (HE40)

Channel	Frequency (MHz)	6 dB Bandwidth (MHz)		Minimum Limit (MHz)	Test Result
		Chain 0	Chain 1		
3	2422	36.50	37.05	0.5	Pass
6	2437	37.47	36.12	0.5	Pass
9	2452	37.64	36.50	0.5	Pass

Spectrum Plot of Minimum Value

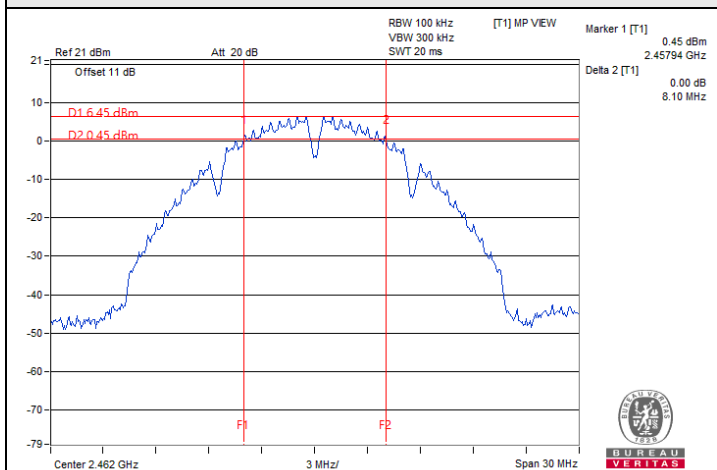

802.11b / Chain 0 : CH 11

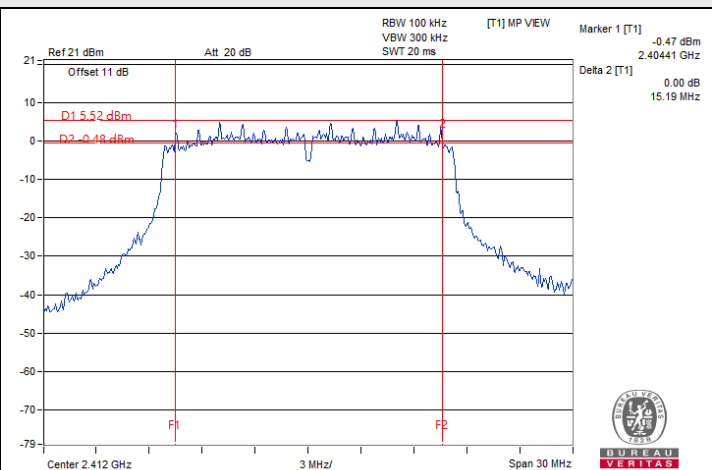

802.11g / Chain 1 : CH 1

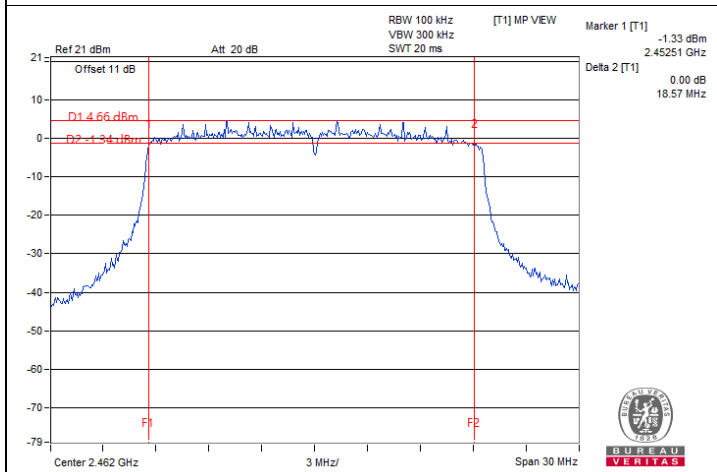

802.11ax (HE20) / Chain 0 : CH 11

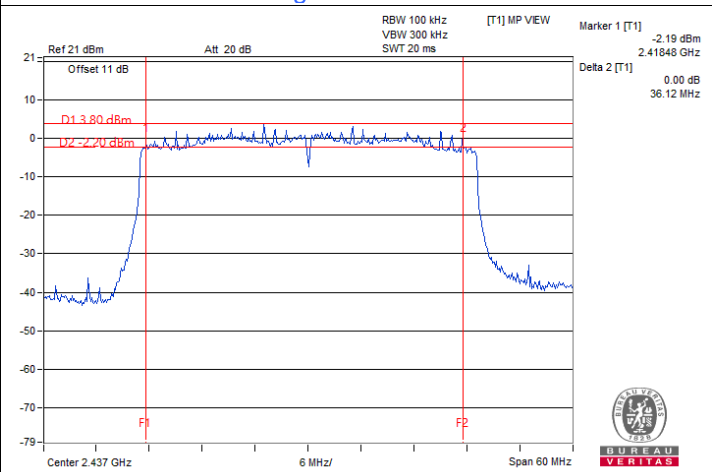

802.11ax (HE40) / Chain 1 : CH 6



BUREAU VERITAS

7.4 Conducted Out of Band Emissions

Input Power:	120 Vac, 60 Hz	Environmental Conditions:	25°C, 76% RH	Tested By:	Dalen Dai
--------------	----------------	---------------------------	--------------	------------	-----------

802.11b

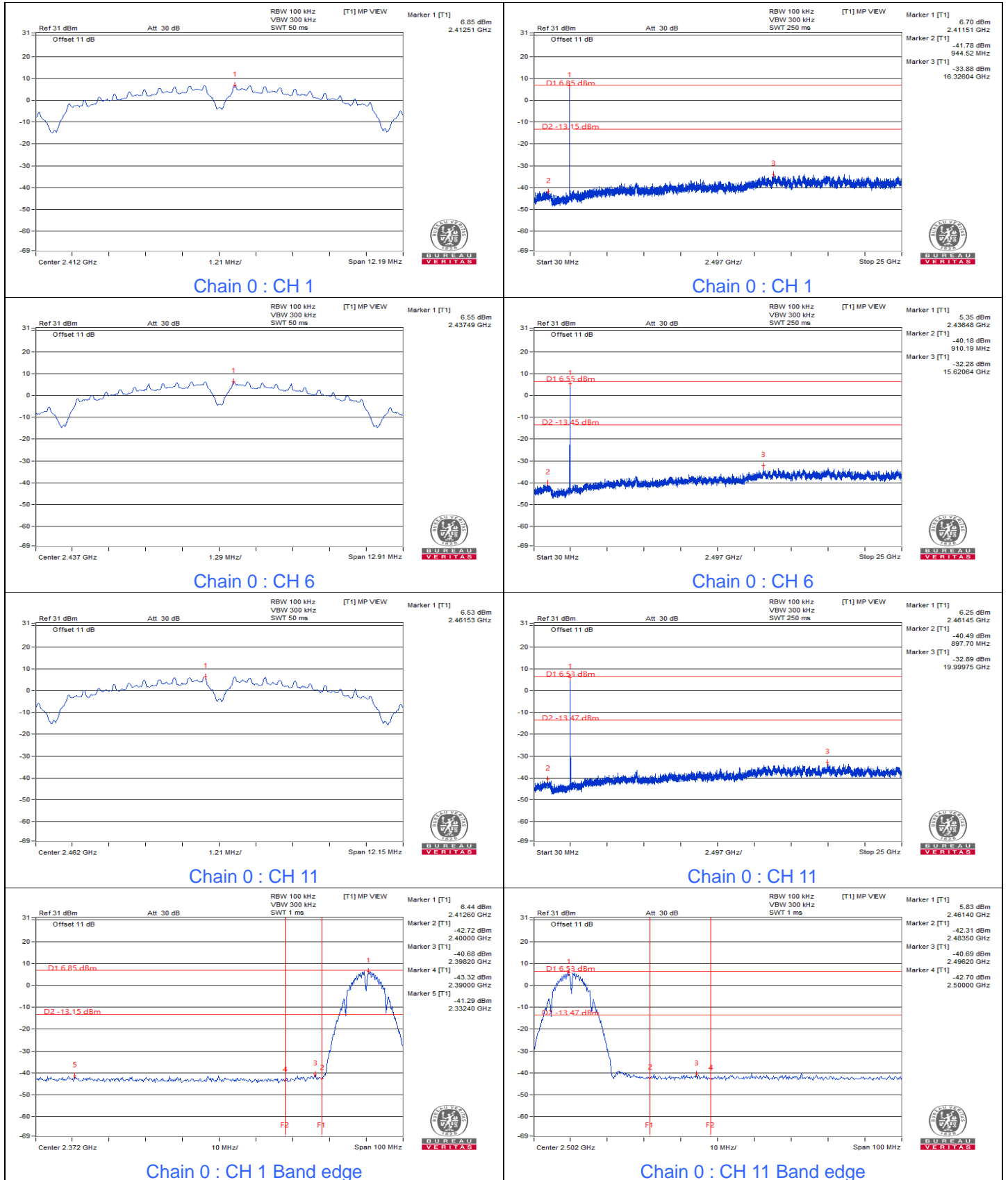

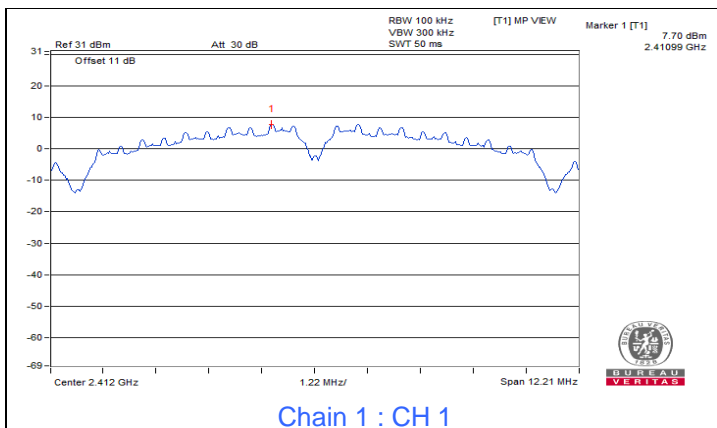

Chain 1 : CH 1

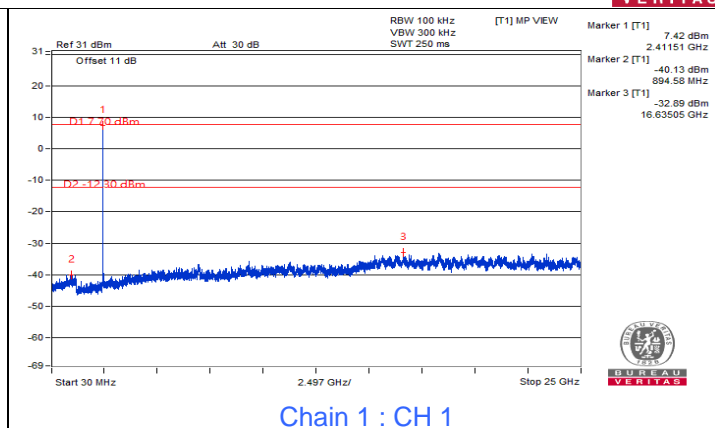

Chain 1 : CH 1

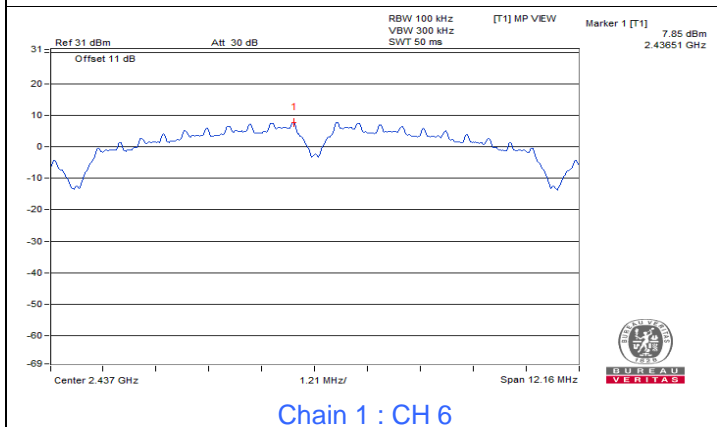

Chain 1 : CH 6

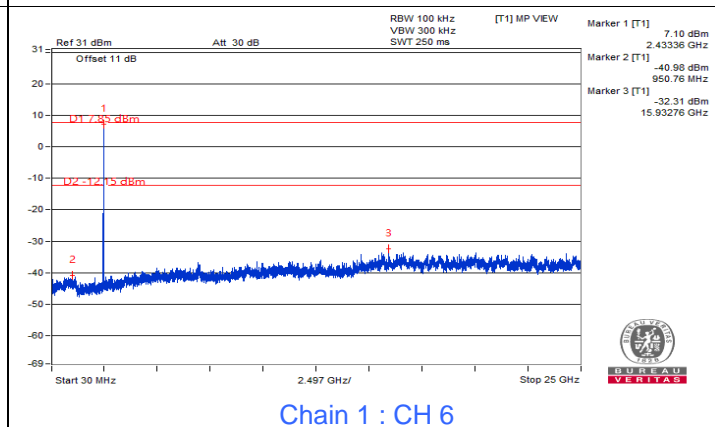

Chain 1 : CH 6

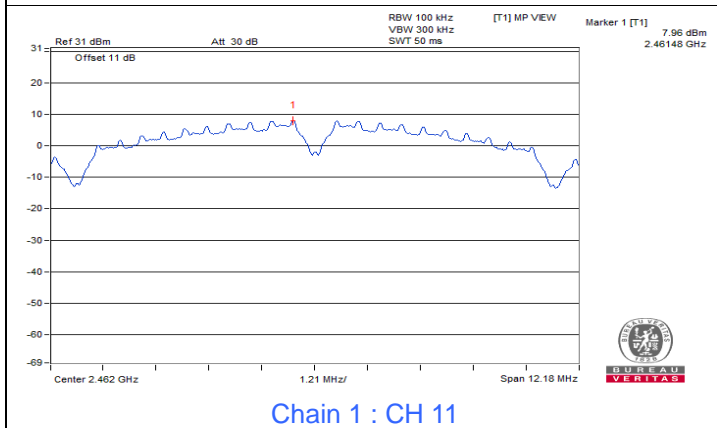

Chain 1 : CH 11

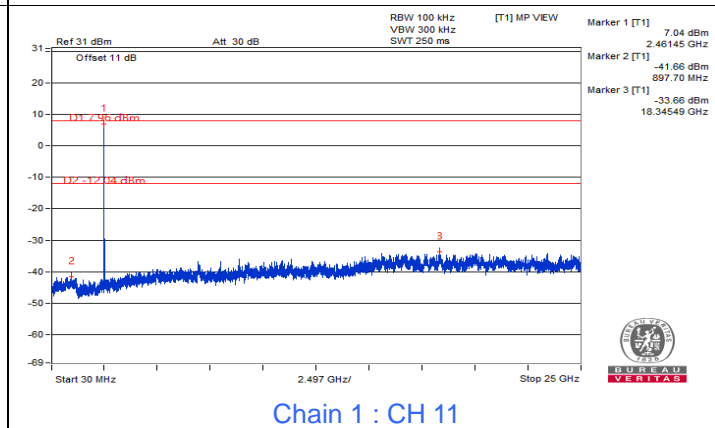

Chain 1 : CH 11

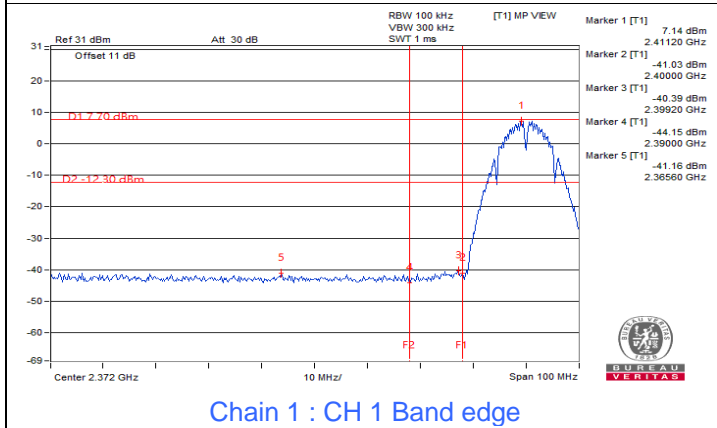

Chain 1 : CH 1 Band edge

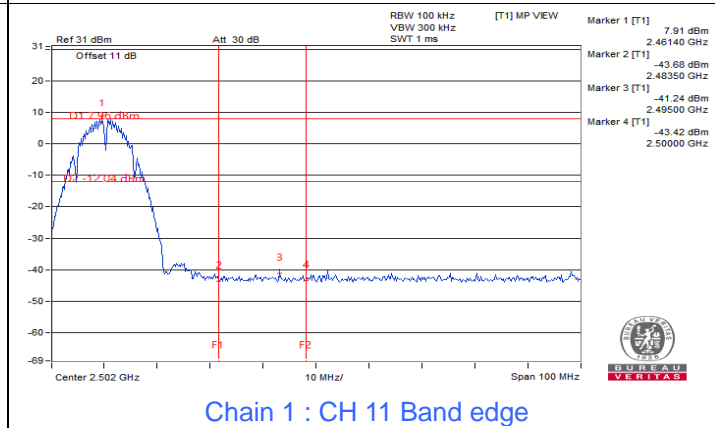

Chain 1 : CH 11 Band edge



802.11g

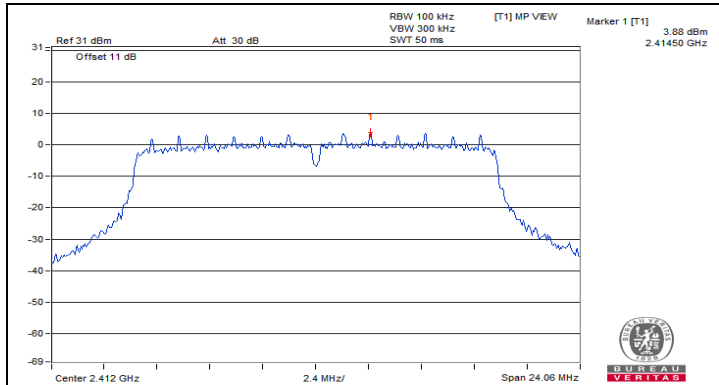

Chain 0 : CH 1

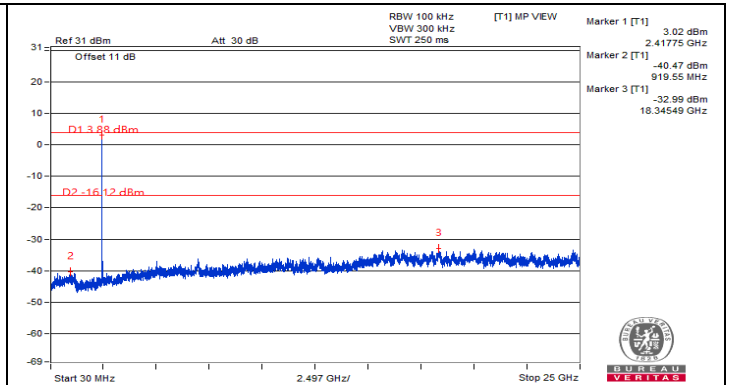

Chain 0 : CH 1

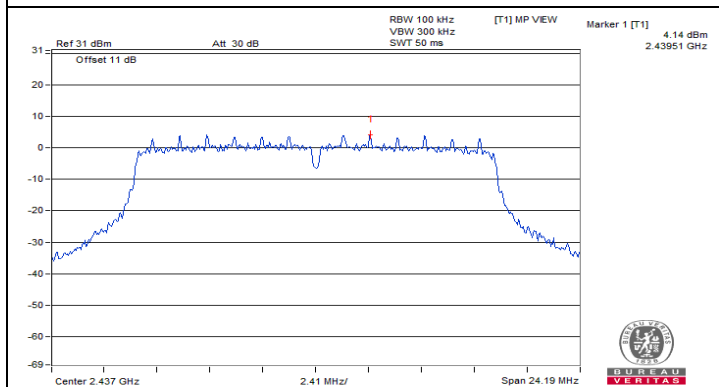

Chain 0 : CH 6

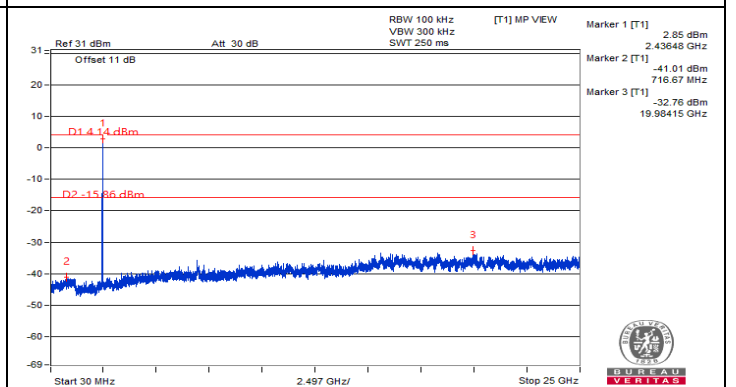

Chain 0 : CH 6

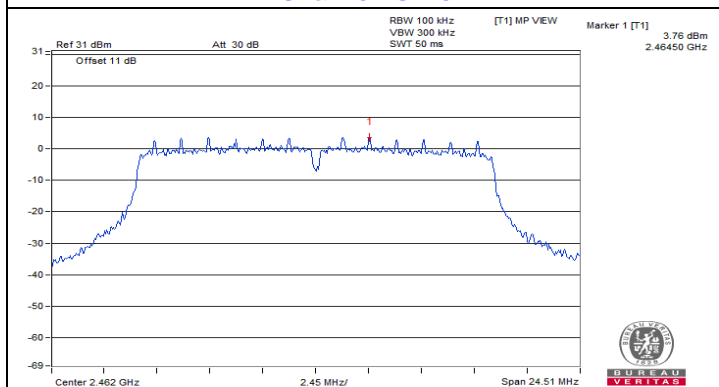

Chain 0 : CH 11

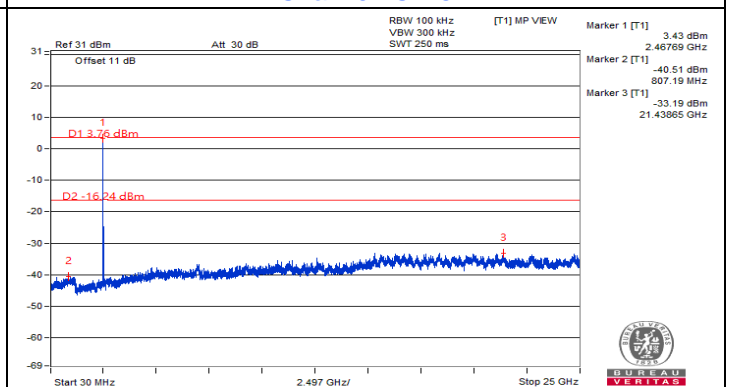

Chain 0 : CH 11

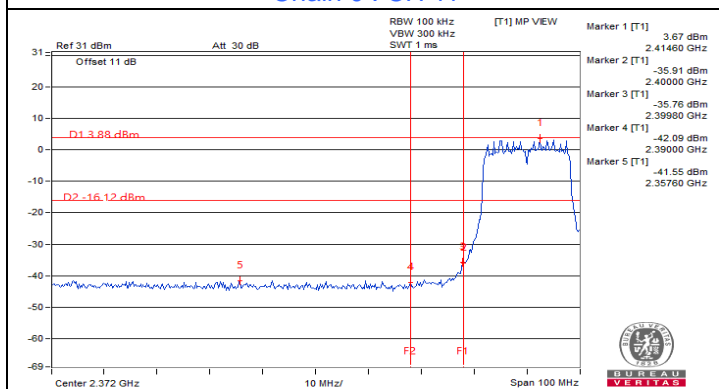

Chain 0 : CH 1 Band edge

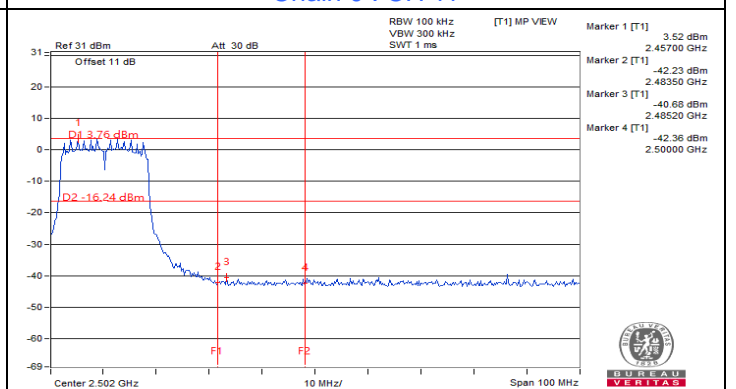

Chain 0 : CH 11 Band edge

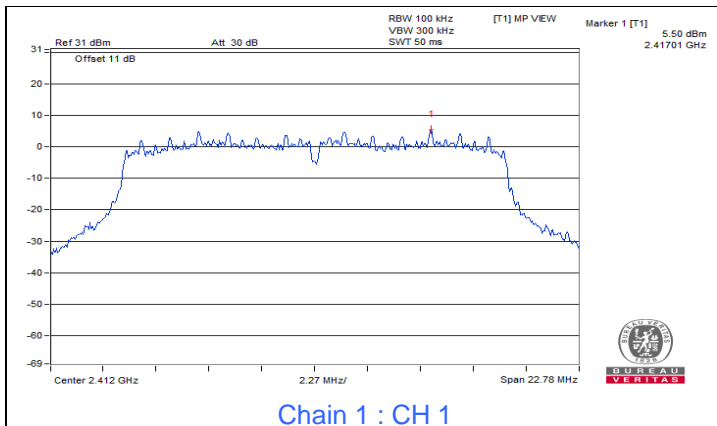

Chain 1 : CH 1

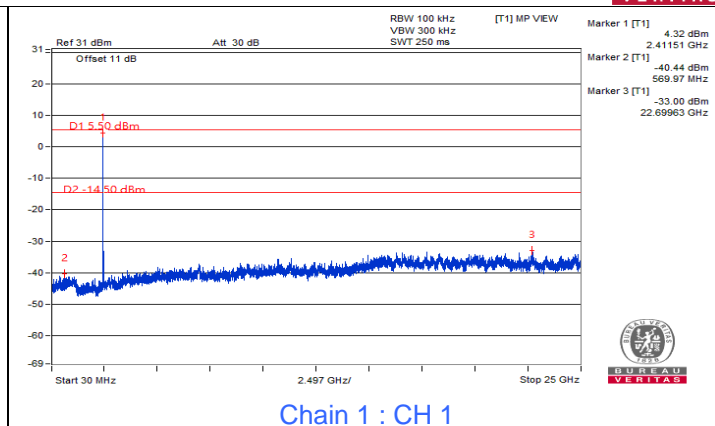

Chain 1 : CH 1

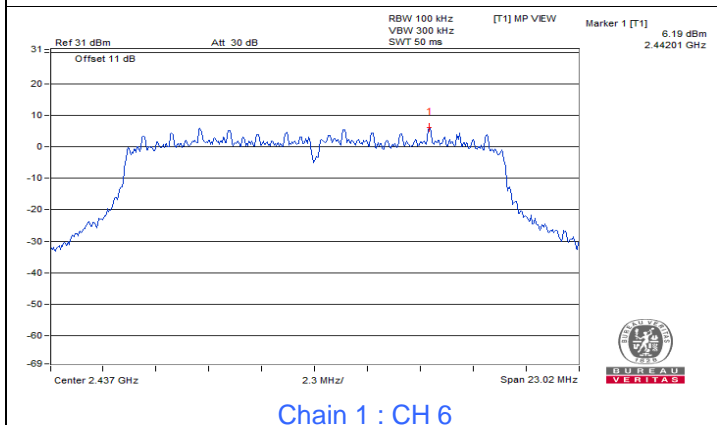

Chain 1 : CH 6

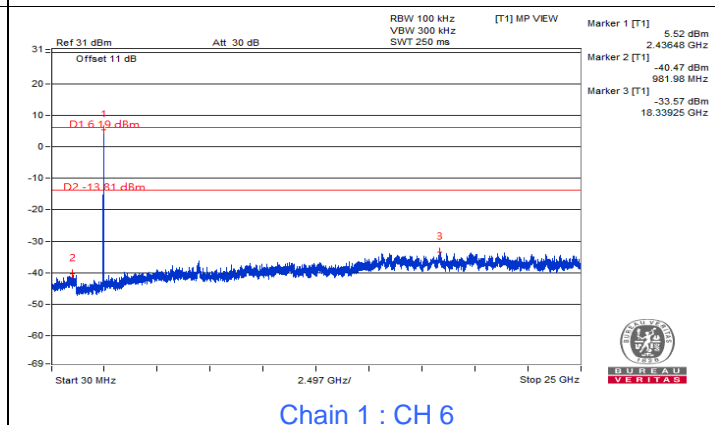

Chain 1 : CH 6

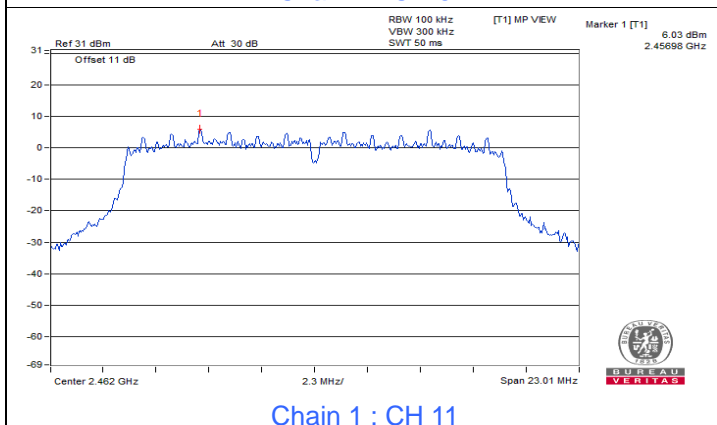

Chain 1 : CH 11

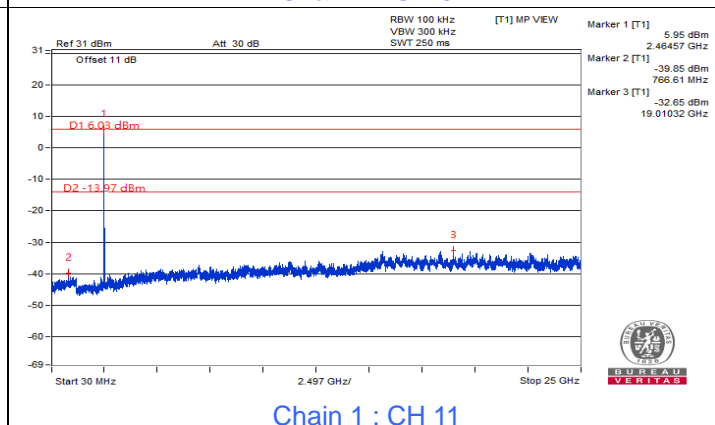

Chain 1 : CH 11

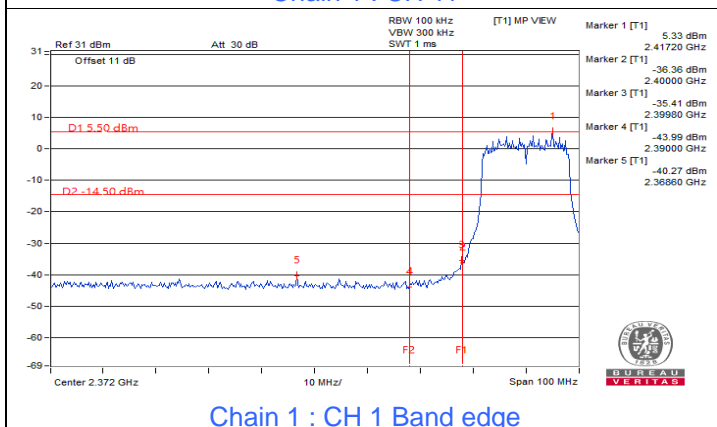

Chain 1 : CH 1 Band edge

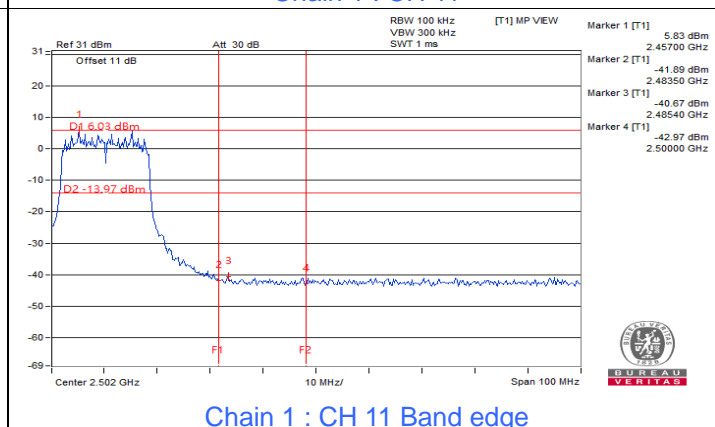

Chain 1 : CH 11 Band edge



802.11ax (HE20)

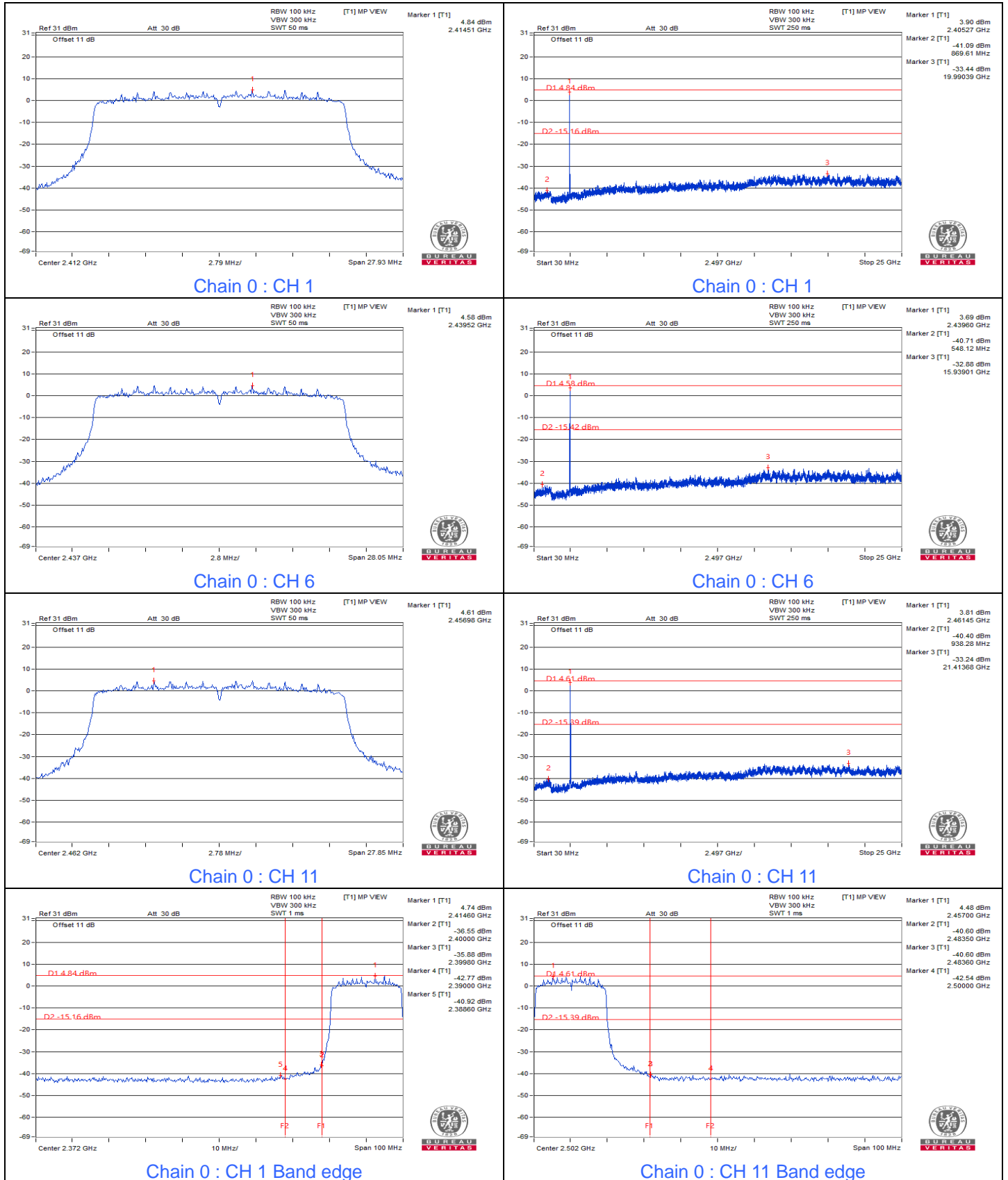

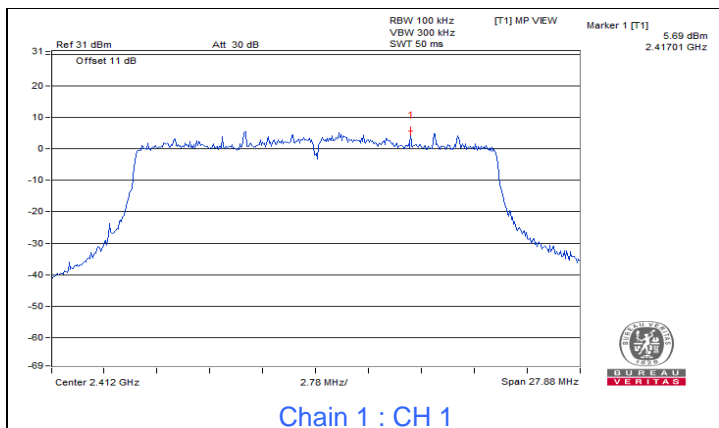

Chain 1 : CH 1

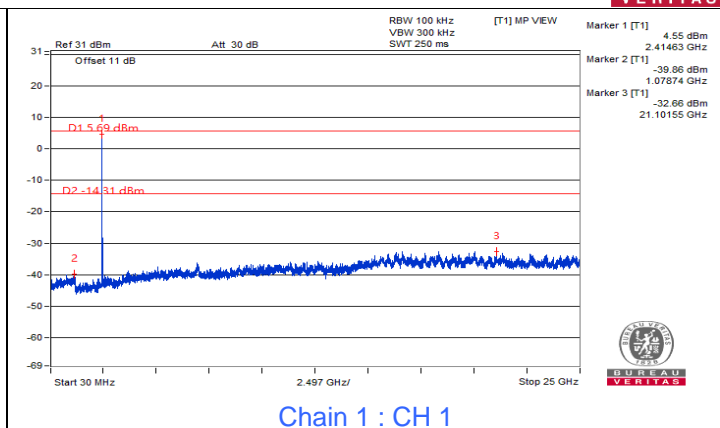

Chain 1 : CH 1

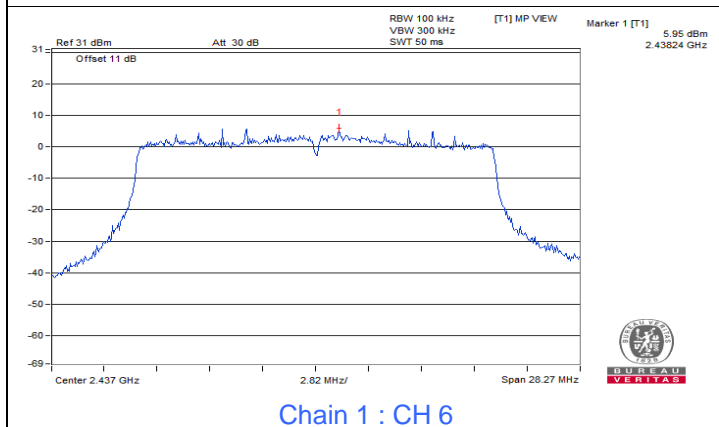

Chain 1 : CH 6

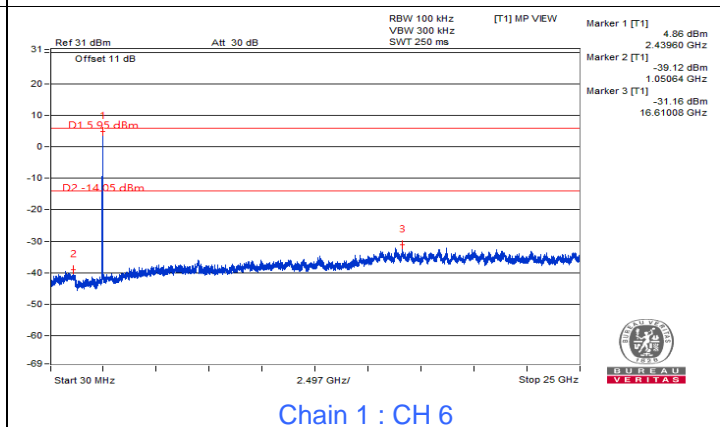

Chain 1 : CH 6

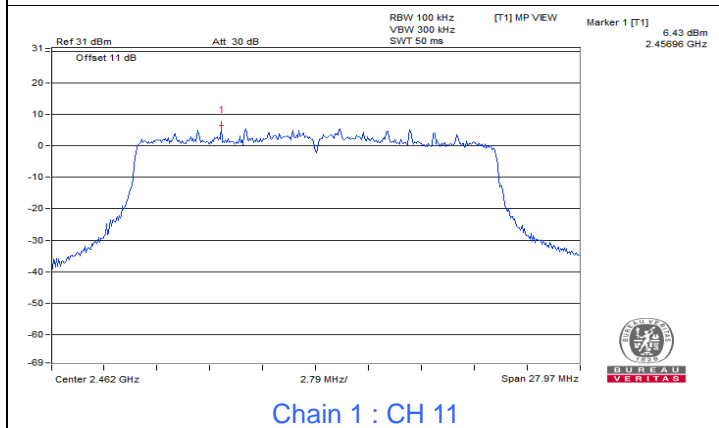

Chain 1 : CH 11

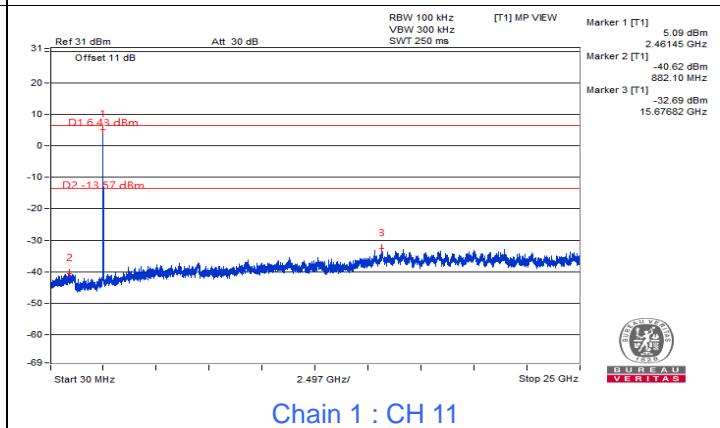

Chain 1 : CH 11

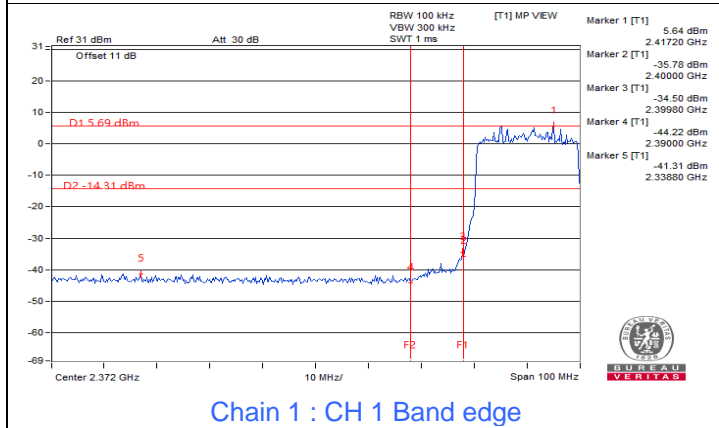

Chain 1 : CH 1 Band edge

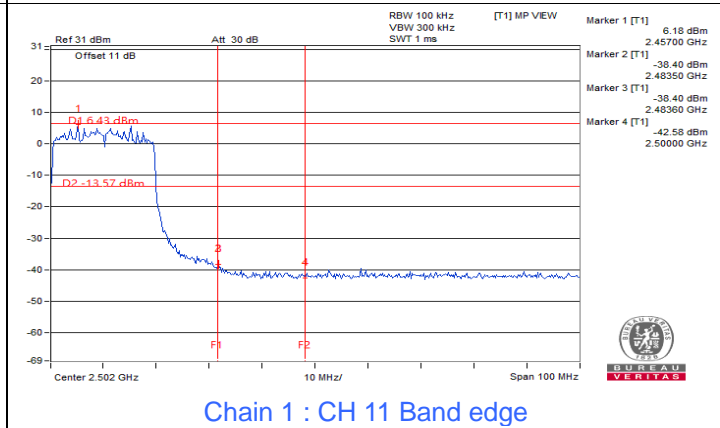

Chain 1 : CH 11 Band edge



802.11ax (HE40)

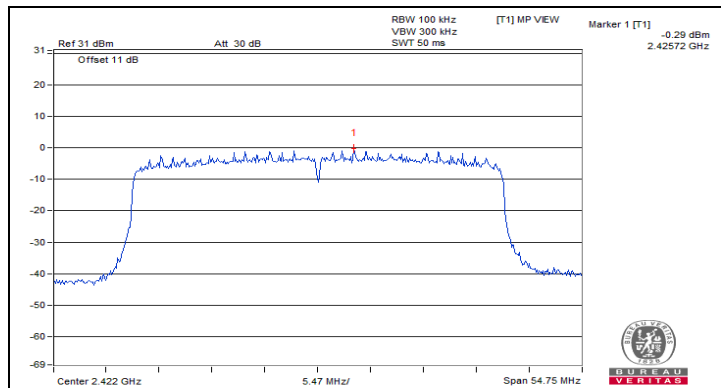

Chain 0 : CH 3

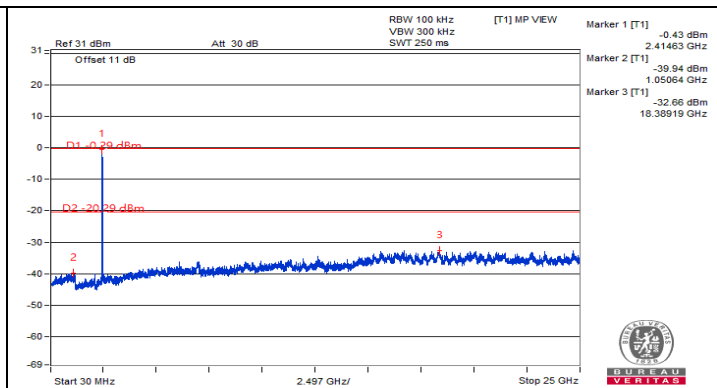

Chain 0 : CH 3

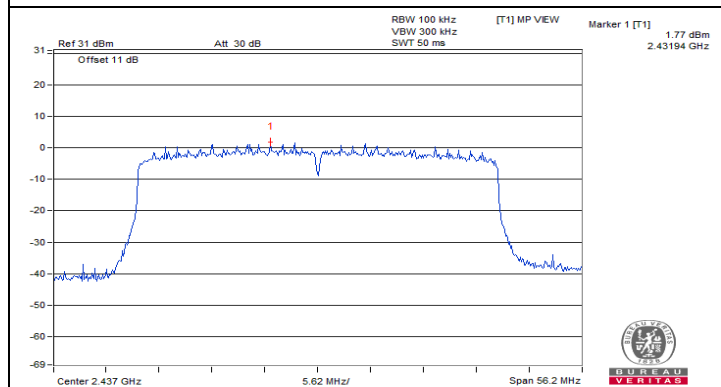

Chain 0 : CH 6

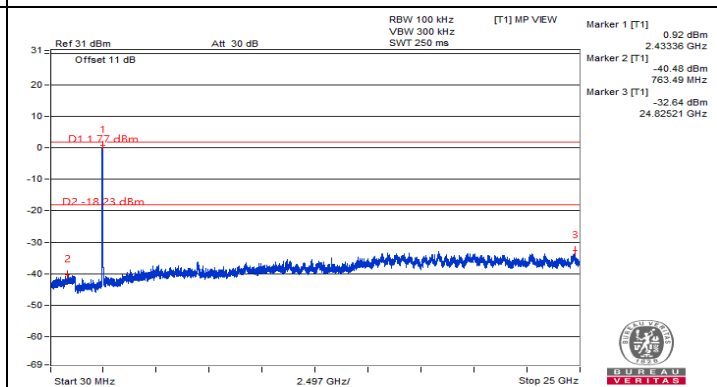

Chain 0 : CH 6

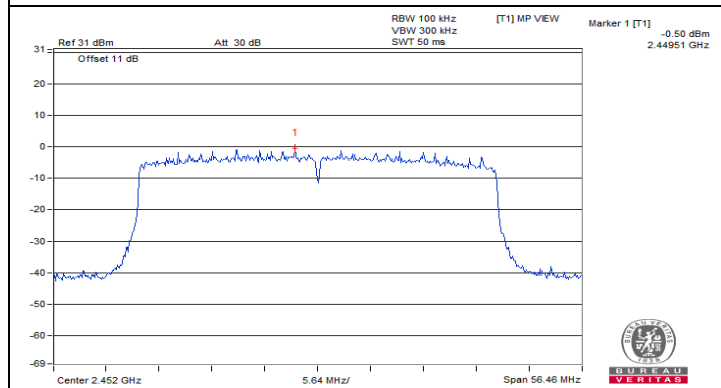

Chain 0 : CH 9

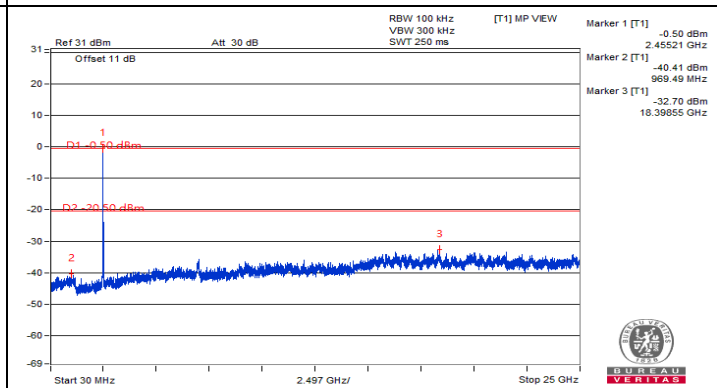

Chain 0 : CH 9

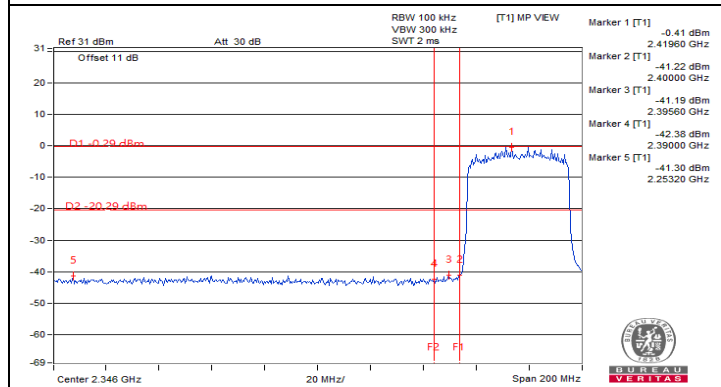

Chain 0 : CH 3 Band edge

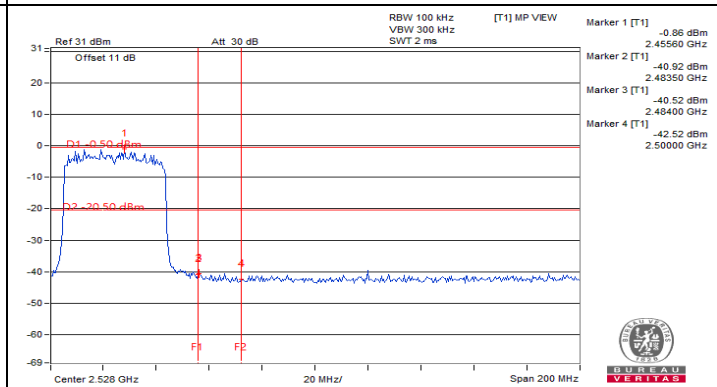

Chain 0 : CH 9 Band edge

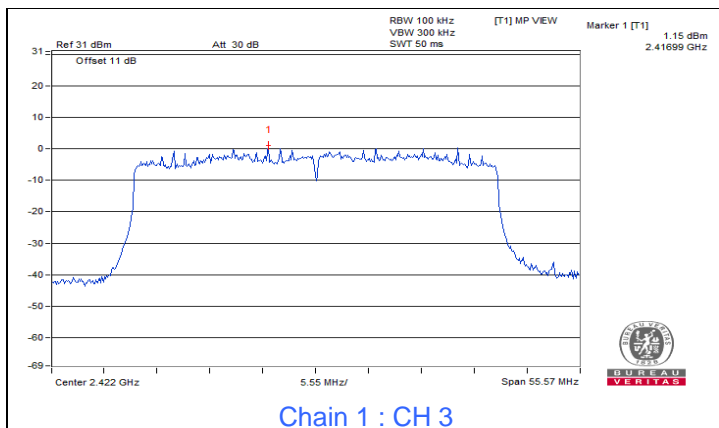

Chain 1 : CH 3

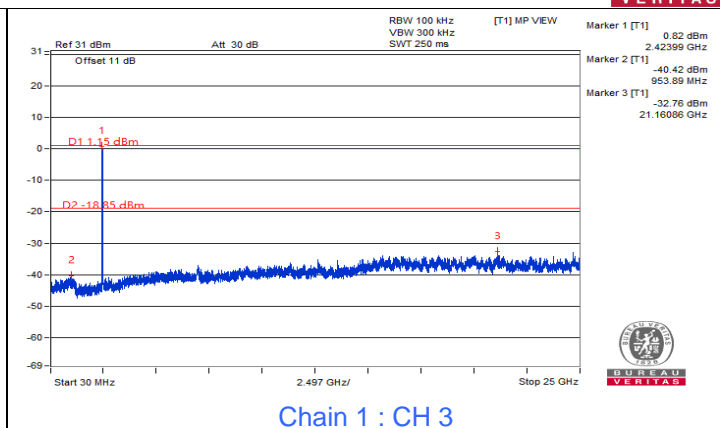

Chain 1 : CH 3

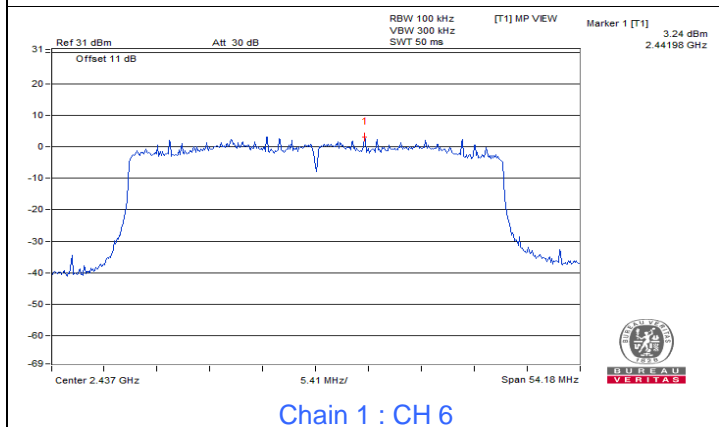

Chain 1 : CH 6

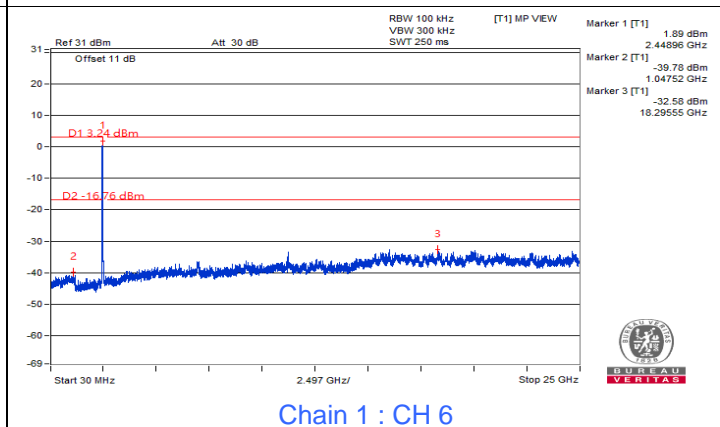

Chain 1 : CH 6

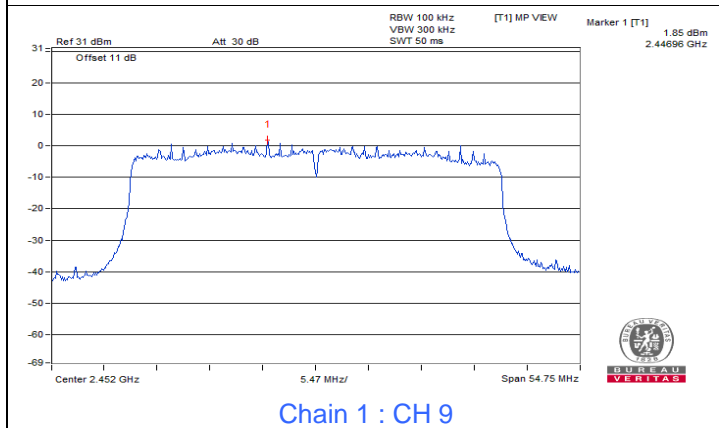

Chain 1 : CH 9

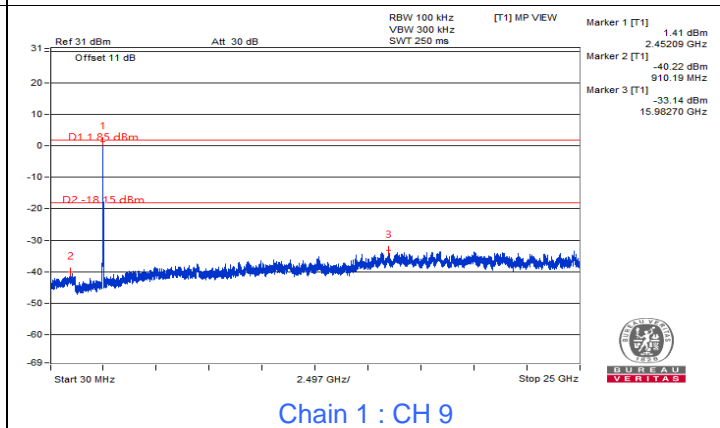

Chain 1 : CH 9

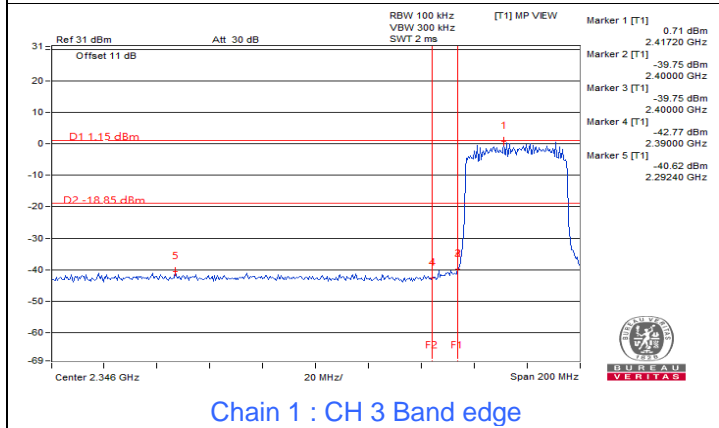

Chain 1 : CH 3 Band edge

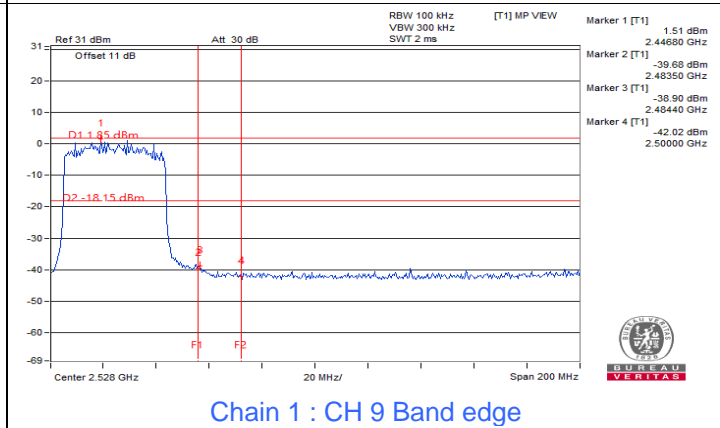

Chain 1 : CH 9 Band edge

7.5 AC Power Conducted Emissions

RF Mode	802.11ax (HE40)	Channel	CH 6 : 2437 MHz
Frequency Range	150kHz ~ 30MHz	Detector Function & Resolution Bandwidth	Quasi-Peak (QP) / Average (AV), 9 kHz
Input Power	120 Vac, 60 Hz	Environmental Conditions	25°C, 75% RH
Tested By	Jed Wu		

Phase Of Power : Line (L)										
No	Frequency (MHz)	Correction Factor (dB)	Reading Value (dBuV)		Emission Level (dBuV)		Limit (dBuV)		Margin (dB)	
			Q.P.	AV.	Q.P.	AV.	Q.P.	AV.	Q.P.	AV.
1	0.17384	10.08	37.52	16.48	47.60	26.56	64.77	54.77	-17.17	-28.21
2	0.39400	10.21	18.88	3.84	29.09	14.05	57.98	47.98	-28.89	-33.93
3	0.71800	10.29	19.53	14.93	29.82	25.22	56.00	46.00	-26.18	-20.78
4	4.76200	10.52	14.18	9.01	24.70	19.53	56.00	46.00	-31.30	-26.47
5	6.94200	10.58	16.63	11.57	27.21	22.15	60.00	50.00	-32.79	-27.85
6	8.89800	10.63	16.94	13.19	27.57	23.82	60.00	50.00	-32.43	-26.18

Remarks:

1. Q.P. and AV. are abbreviations of quasi-peak and average individually.
2. The emission levels of other frequencies were very low against the limit.
3. Margin value = Emission level – Limit value
4. Correction factor = Insertion loss + Cable loss
5. Emission Level = Correction Factor + Reading Value

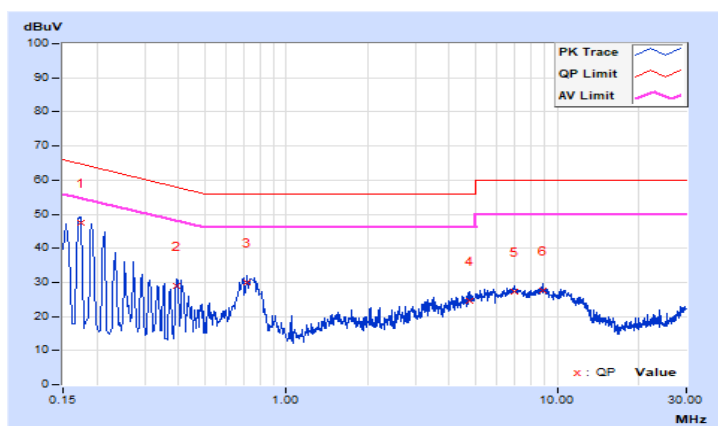

RF Mode	802.11ax (HE40)	Channel	CH 6 : 2437 MHz
Frequency Range	150kHz ~ 30MHz	Detector Function & Resolution Bandwidth	Quasi-Peak (QP) / Average (AV), 9 kHz
Input Power	120 Vac, 60 Hz	Environmental Conditions	25°C, 75% RH
Tested By	Jed Wu		

Phase Of Power : Neutral (N)										
No	Frequency (MHz)	Correction Factor (dB)	Reading Value (dBuV)		Emission Level (dBuV)		Limit (dBuV)		Margin (dB)	
			Q.P.	AV.	Q.P.	AV.	Q.P.	AV.	Q.P.	AV.
1	0.16600	10.10	38.14	17.77	48.24	27.87	65.16	55.16	-16.92	-27.29
2	0.40600	10.19	19.44	5.39	29.63	15.58	57.73	47.73	-28.10	-32.15
3	0.73800	10.24	22.26	17.52	32.50	27.76	56.00	46.00	-23.50	-18.24
4	4.74200	10.46	13.15	8.12	23.61	18.58	56.00	46.00	-32.39	-27.42
5	7.06186	10.55	14.39	8.69	24.94	19.24	60.00	50.00	-35.06	-30.76
6	10.39800	10.67	14.32	8.76	24.99	19.43	60.00	50.00	-35.01	-30.57

Remarks:

1. Q.P. and AV. are abbreviations of quasi-peak and average individually.
2. The emission levels of other frequencies were very low against the limit.
3. Margin value = Emission level – Limit value
4. Correction factor = Insertion loss + Cable loss
5. Emission Level = Correction Factor + Reading Value

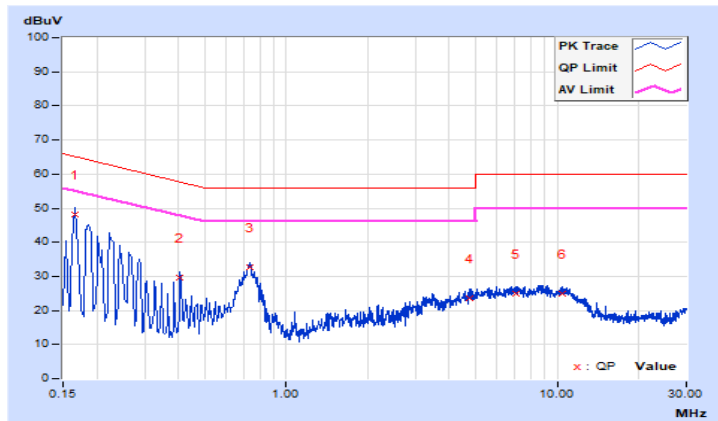

7.6 Unwanted Emissions below 1 GHz

RF Mode	802.11ax (HE40)	Channel	CH 6 : 2437 MHz
Frequency Range	30 MHz ~ 1 GHz	Detector Function & Bandwidth	(QP) RB = 120kHz
Input Power	120 Vac, 60 Hz	Environmental Conditions	23°C, 53% RH
Tested By	Jed Wu		

Antenna Polarity & Test Distance : Horizontal at 3 m								
No	Frequency (MHz)	Emission Level (dBuV/m)	Limit (dBuV/m)	Margin (dB)	Antenna Height (m)	Table Angle (Degree)	Raw Value (dBuV)	Correction Factor (dB/m)
1	31.50	36.3 QP	40.0	-3.7	1.05 H	18	47.1	-10.8
2	151.49	39.5 QP	43.5	-4.0	1.18 H	219	47.8	-8.3
3	210.03	38.2 QP	43.5	-5.3	1.75 H	309	49.0	-10.8
4	400.10	38.6 QP	46.0	-7.4	1.86 H	40	42.6	-4.0
5	593.96	35.6 QP	46.0	-10.4	1.94 H	140	35.0	0.6
6	656.04	37.0 QP	46.0	-9.0	1.30 H	128	35.1	1.9

Remarks:

1. Emission Level(dBuV/m) = Raw Value(dBuV) + Correction Factor(dB/m)
2. Correction Factor(dB/m) = Antenna Factor(dB/m) + Cable Factor(dB) – Pre-Amplifier Factor(dB)
3. Margin value = Emission Level – Limit value
4. The other emission levels were very low against the limit of frequency range 30 MHz ~ 1 GHz.
5. The emission levels were very low against the limit of frequency range 9 kHz ~ 30 MHz: the amplitude of spurious emissions attenuated more than 20 dB below the permissible value to be report.

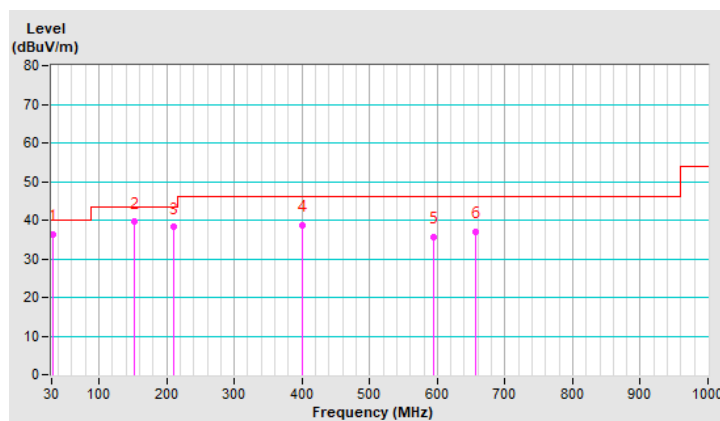

RF Mode	802.11ax (HE40)	Channel	CH 6 : 2437 MHz
Frequency Range	30 MHz ~ 1 GHz	Detector Function & Bandwidth	(QP) RB = 120kHz
Input Power	120 Vac, 60 Hz	Environmental Conditions	23°C, 53% RH
Tested By	Jed Wu		

Antenna Polarity & Test Distance : Vertical at 3 m								
No	Frequency (MHz)	Emission Level (dBuV/m)	Limit (dBuV/m)	Margin (dB)	Antenna Height (m)	Table Angle (Degree)	Raw Value (dBuV)	Correction Factor (dB/m)
1	94.50	37.7 QP	43.5	-5.8	1.31 V	117	51.6	-13.9
2	213.04	34.5 QP	43.5	-9.0	1.59 V	263	45.2	-10.7
3	398.41	31.3 QP	46.0	-14.7	1.47 V	360	35.2	-3.9
4	479.98	34.1 QP	46.0	-11.9	1.28 V	87	36.2	-2.1
5	587.51	36.4 QP	46.0	-9.6	1.63 V	192	35.9	0.5
6	644.25	35.7 QP	46.0	-10.3	1.08 V	203	33.9	1.8

Remarks:

1. Emission Level(dBuV/m) = Raw Value(dBuV) + Correction Factor(dB/m)
2. Correction Factor(dB/m) = Antenna Factor(dB/m) + Cable Factor(dB) – Pre-Amplifier Factor(dB)
3. Margin value = Emission Level – Limit value
4. The other emission levels were very low against the limit of frequency range 30 MHz ~ 1 GHz.
5. The emission levels were very low against the limit of frequency range 9 kHz ~ 30 MHz: the amplitude of spurious emissions attenuated more than 20 dB below the permissible value to be report.

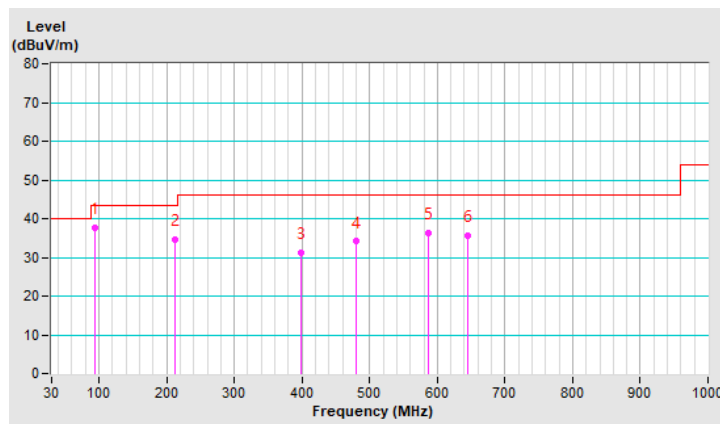

7.7 Unwanted Emissions above 1 GHz

RF Mode	802.11b	Channel	CH 1 : 2412 MHz
Frequency Range	1 GHz ~ 25 GHz	Detector Function & Bandwidth	(PK) RB = 1 MHz, VB = 3 MHz (AV) RB = 1 MHz, VB = 10 Hz
Input Power	120 Vac, 60 Hz	Environmental Conditions	14°C, 58% RH
Tested By	Jed Wu		

Antenna Polarity & Test Distance : Horizontal at 3 m								
No	Frequency (MHz)	Emission Level (dBuV/m)	Limit (dBuV/m)	Margin (dB)	Antenna Height (m)	Table Angle (Degree)	Raw Value (dBuV)	Correction Factor (dB/m)
1	2390.00	56.3 PK	74.0	-17.7	1.06 H	237	57.4	-1.1
2	2390.00	44.0 AV	54.0	-10.0	1.06 H	237	45.1	-1.1
3	*2412.00	114.1 PK			1.06 H	237	115.2	-1.1
4	*2412.00	110.7 AV			1.06 H	237	111.8	-1.1
5	4824.00	49.0 PK	74.0	-25.0	1.37 H	204	41.3	7.7
6	4824.00	36.4 AV	54.0	-17.6	1.37 H	204	28.7	7.7
Antenna Polarity & Test Distance : Vertical at 3 m								
No	Frequency (MHz)	Emission Level (dBuV/m)	Limit (dBuV/m)	Margin (dB)	Antenna Height (m)	Table Angle (Degree)	Raw Value (dBuV)	Correction Factor (dB/m)
1	2390.00	55.9 PK	74.0	-18.1	2.40 V	210	57.0	-1.1
2	2390.00	43.7 AV	54.0	-10.3	2.40 V	210	44.8	-1.1
3	*2412.00	111.6 PK			2.40 V	210	112.7	-1.1
4	*2412.00	108.3 AV			2.40 V	210	109.4	-1.1
5	4824.00	48.7 PK	74.0	-25.3	2.15 V	177	41.0	7.7
6	4824.00	36.1 AV	54.0	-17.9	2.15 V	177	28.4	7.7

Remarks:

1. Emission Level(dBuV/m) = Raw Value(dBuV) + Correction Factor(dB/m)
2. Correction Factor(dB/m) = Antenna Factor(dB/m) + Cable Factor(dB) – Pre-Amplifier Factor(dB)
3. Margin value = Emission Level – Limit value
4. The other emission levels were very low against the limit.
5. " * " : Fundamental frequency, the limit was restricted at the RF Output Power.



RF Mode	802.11b	Channel	CH 6 : 2437 MHz
Frequency Range	1 GHz ~ 25 GHz	Detector Function & Bandwidth	(PK) RB = 1 MHz, VB = 3 MHz (AV) RB = 1 MHz, VB = 10 Hz
Input Power	120 Vac, 60 Hz	Environmental Conditions	14°C, 58% RH
Tested By	Jed Wu		

Antenna Polarity & Test Distance : Horizontal at 3 m								
No	Frequency (MHz)	Emission Level (dBuV/m)	Limit (dBuV/m)	Margin (dB)	Antenna Height (m)	Table Angle (Degree)	Raw Value (dBuV)	Correction Factor (dB/m)
1	*2437.00	114.4 PK			1.03 H	233	115.4	-1.0
2	*2437.00	111.0 AV			1.03 H	233	112.0	-1.0
3	4874.00	49.3 PK	74.0	-24.7	1.40 H	208	41.5	7.8
4	4874.00	36.7 AV	54.0	-17.3	1.40 H	208	28.9	7.8

Antenna Polarity & Test Distance : Vertical at 3 m								
No	Frequency (MHz)	Emission Level (dBuV/m)	Limit (dBuV/m)	Margin (dB)	Antenna Height (m)	Table Angle (Degree)	Raw Value (dBuV)	Correction Factor (dB/m)
1	*2437.00	111.9 PK			2.37 V	206	112.9	-1.0
2	*2437.00	108.6 AV			2.37 V	206	109.6	-1.0
3	4874.00	49.0 PK	74.0	-25.0	2.12 V	173	41.2	7.8
4	4874.00	36.4 AV	54.0	-17.6	2.12 V	173	28.6	7.8

Remarks:

1. Emission Level(dBuV/m) = Raw Value(dBuV) + Correction Factor(dB/m)
2. Correction Factor(dB/m) = Antenna Factor(dB/m) + Cable Factor(dB) – Pre-Amplifier Factor(dB)
3. Margin value = Emission Level – Limit value
4. The other emission levels were very low against the limit.
5. " * " : Fundamental frequency, the limit was restricted at the RF Output Power.



RF Mode	802.11b	Channel	CH 11 : 2462 MHz
Frequency Range	1 GHz ~ 25 GHz	Detector Function & Bandwidth	(PK) RB = 1 MHz, VB = 3 MHz (AV) RB = 1 MHz, VB = 10 Hz
Input Power	120 Vac, 60 Hz	Environmental Conditions	14°C, 58% RH
Tested By	Jed Wu		

Antenna Polarity & Test Distance : Horizontal at 3 m

No	Frequency (MHz)	Emission Level (dBuV/m)	Limit (dBuV/m)	Margin (dB)	Antenna Height (m)	Table Angle (Degree)	Raw Value (dBuV)	Correction Factor (dB/m)
1	*2462.00	113.9 PK			2.39 H	177	114.8	-0.9
2	*2462.00	110.5 AV			2.39 H	177	111.4	-0.9
3	2483.50	56.2 PK	74.0	-17.8	2.39 H	177	57.0	-0.8
4	2483.50	43.6 AV	54.0	-10.4	2.39 H	177	44.4	-0.8
5	4924.00	48.9 PK	74.0	-25.1	2.70 H	144	41.1	7.8
6	4924.00	36.3 AV	54.0	-17.7	2.70 H	144	28.5	7.8

Antenna Polarity & Test Distance : Vertical at 3 m

No	Frequency (MHz)	Emission Level (dBuV/m)	Limit (dBuV/m)	Margin (dB)	Antenna Height (m)	Table Angle (Degree)	Raw Value (dBuV)	Correction Factor (dB/m)
1	*2462.00	111.5 PK			3.73 V	150	112.4	-0.9
2	*2462.00	108.4 AV			3.73 V	150	109.3	-0.9
3	2483.50	56.0 PK	74.0	-18.0	3.73 V	150	56.8	-0.8
4	2483.50	43.4 AV	54.0	-10.6	3.73 V	150	44.2	-0.8
5	4924.00	48.6 PK	74.0	-25.4	3.48 V	117	40.8	7.8
6	4924.00	36.0 AV	54.0	-18.0	3.48 V	117	28.2	7.8

Remarks:

1. Emission Level(dBuV/m) = Raw Value(dBuV) + Correction Factor(dB/m)
2. Correction Factor(dB/m) = Antenna Factor(dB/m) + Cable Factor(dB) – Pre-Amplifier Factor(dB)
3. Margin value = Emission Level – Limit value
4. The other emission levels were very low against the limit.
5. " * " : Fundamental frequency, the limit was restricted at the RF Output Power.



RF Mode	802.11g	Channel	CH 1 : 2412 MHz
Frequency Range	1 GHz ~ 25 GHz	Detector Function & Bandwidth	(PK) RB = 1 MHz, VB = 3 MHz (AV) RB = 1 MHz, VB = 10 Hz
Input Power	120 Vac, 60 Hz	Environmental Conditions	14°C, 58% RH
Tested By	Jed Wu		

Antenna Polarity & Test Distance : Horizontal at 3 m

No	Frequency (MHz)	Emission Level (dBuV/m)	Limit (dBuV/m)	Margin (dB)	Antenna Height (m)	Table Angle (Degree)	Raw Value (dBuV)	Correction Factor (dB/m)
1	2390.00	58.9 PK	74.0	-15.1	1.05 H	235	60.0	-1.1
2	2390.00	45.7 AV	54.0	-8.3	1.05 H	235	46.8	-1.1
3	*2412.00	113.8 PK			1.05 H	235	114.9	-1.1
4	*2412.00	104.1 AV			1.05 H	235	105.2	-1.1
5	4824.00	48.7 PK	74.0	-25.3	1.38 H	206	41.0	7.7
6	4824.00	36.1 AV	54.0	-17.9	1.38 H	206	28.4	7.7

Antenna Polarity & Test Distance : Vertical at 3 m

No	Frequency (MHz)	Emission Level (dBuV/m)	Limit (dBuV/m)	Margin (dB)	Antenna Height (m)	Table Angle (Degree)	Raw Value (dBuV)	Correction Factor (dB/m)
1	2390.00	57.3 PK	74.0	-16.7	2.39 V	208	58.4	-1.1
2	2390.00	44.8 AV	54.0	-9.2	2.39 V	208	45.9	-1.1
3	*2412.00	111.2 PK			2.39 V	208	112.3	-1.1
4	*2412.00	101.9 AV			2.39 V	208	103.0	-1.1
5	4824.00	48.4 PK	74.0	-25.6	2.14 V	179	40.7	7.7
6	4824.00	35.8 AV	54.0	-18.2	2.14 V	179	28.1	7.7

Remarks:

1. Emission Level(dBuV/m) = Raw Value(dBuV) + Correction Factor(dB/m)
2. Correction Factor(dB/m) = Antenna Factor(dB/m) + Cable Factor(dB) – Pre-Amplifier Factor(dB)
3. Margin value = Emission Level – Limit value
4. The other emission levels were very low against the limit.
5. " * ": Fundamental frequency, the limit was restricted at the RF Output Power.



RF Mode	802.11g	Channel	CH 6 : 2437 MHz
Frequency Range	1 GHz ~ 25 GHz	Detector Function & Bandwidth	(PK) RB = 1 MHz, VB = 3 MHz (AV) RB = 1 MHz, VB = 10 Hz
Input Power	120 Vac, 60 Hz	Environmental Conditions	14°C, 58% RH
Tested By	Jed Wu		

Antenna Polarity & Test Distance : Horizontal at 3 m								
No	Frequency (MHz)	Emission Level (dBuV/m)	Limit (dBuV/m)	Margin (dB)	Antenna Height (m)	Table Angle (Degree)	Raw Value (dBuV)	Correction Factor (dB/m)
1	*2437.00	114.1 PK			1.03 H	233	115.1	-1.0
2	*2437.00	104.4 AV			1.03 H	233	105.4	-1.0
3	4874.00	49.0 PK	74.0	-25.0	1.36 H	208	41.2	7.8
4	4874.00	36.4 AV	54.0	-17.6	1.36 H	208	28.6	7.8
Antenna Polarity & Test Distance : Vertical at 3 m								
No	Frequency (MHz)	Emission Level (dBuV/m)	Limit (dBuV/m)	Margin (dB)	Antenna Height (m)	Table Angle (Degree)	Raw Value (dBuV)	Correction Factor (dB/m)
1	*2437.00	111.6 PK			2.37 V	214	112.6	-1.0
2	*2437.00	101.9 AV			2.37 V	214	102.9	-1.0
3	4874.00	48.7 PK	74.0	-25.3	2.18 V	173	40.9	7.8
4	4874.00	36.1 AV	54.0	-17.9	2.18 V	173	28.3	7.8

Remarks:

1. Emission Level(dBuV/m) = Raw Value(dBuV) + Correction Factor(dB/m)
2. Correction Factor(dB/m) = Antenna Factor(dB/m) + Cable Factor(dB) – Pre-Amplifier Factor(dB)
3. Margin value = Emission Level – Limit value
4. The other emission levels were very low against the limit.
5. " * " : Fundamental frequency, the limit was restricted at the RF Output Power.



RF Mode	802.11g	Channel	CH 11 : 2462 MHz
Frequency Range	1 GHz ~ 25 GHz	Detector Function & Bandwidth	(PK) RB = 1 MHz, VB = 3 MHz (AV) RB = 1 MHz, VB = 10 Hz
Input Power	120 Vac, 60 Hz	Environmental Conditions	14°C, 58% RH
Tested By	Jed Wu		

Antenna Polarity & Test Distance : Horizontal at 3 m

No	Frequency (MHz)	Emission Level (dBuV/m)	Limit (dBuV/m)	Margin (dB)	Antenna Height (m)	Table Angle (Degree)	Raw Value (dBuV)	Correction Factor (dB/m)
1	*2462.00	114.9 PK			2.39 H	178	115.8	-0.9
2	*2462.00	105.5 AV			2.39 H	178	106.4	-0.9
3	2483.50	62.8 PK	74.0	-11.2	2.39 H	178	63.6	-0.8
4	2483.50	47.7 AV	54.0	-6.3	2.39 H	178	48.5	-0.8
5	4924.00	49.7 PK	74.0	-24.3	2.72 H	149	41.9	7.8
6	4924.00	35.1 AV	54.0	-18.9	2.72 H	149	27.3	7.8

Antenna Polarity & Test Distance : Vertical at 3 m

No	Frequency (MHz)	Emission Level (dBuV/m)	Limit (dBuV/m)	Margin (dB)	Antenna Height (m)	Table Angle (Degree)	Raw Value (dBuV)	Correction Factor (dB/m)
1	*2462.00	112.5 PK			3.73 V	151	113.4	-0.9
2	*2462.00	102.8 AV			3.73 V	151	103.7	-0.9
3	2483.50	61.7 PK	74.0	-12.3	3.73 V	151	62.5	-0.8
4	2483.50	47.1 AV	54.0	-6.9	3.73 V	151	47.9	-0.8
5	4924.00	49.4 PK	74.0	-24.6	3.48 V	118	41.6	7.8
6	4924.00	34.8 AV	54.0	-19.2	3.48 V	118	27.0	7.8

Remarks:

1. Emission Level(dBuV/m) = Raw Value(dBuV) + Correction Factor(dB/m)
2. Correction Factor(dB/m) = Antenna Factor(dB/m) + Cable Factor(dB) – Pre-Amplifier Factor(dB)
3. Margin value = Emission Level – Limit value
4. The other emission levels were very low against the limit.
5. " * " : Fundamental frequency, the limit was restricted at the RF Output Power.



RF Mode	802.11ax (HE20)	Channel	CH 1 : 2412 MHz
Frequency Range	1 GHz ~ 25 GHz	Detector Function & Bandwidth	(PK) RB = 1 MHz, VB = 3 MHz (AV) RB = 1 MHz, VB = 10 Hz
Input Power	120 Vac, 60 Hz	Environmental Conditions	14°C, 58% RH
Tested By	Jed Wu		

Antenna Polarity & Test Distance : Horizontal at 3 m

No	Frequency (MHz)	Emission Level (dBuV/m)	Limit (dBuV/m)	Margin (dB)	Antenna Height (m)	Table Angle (Degree)	Raw Value (dBuV)	Correction Factor (dB/m)
1	2390.00	64.0 PK	74.0	-10.0	1.05 H	235	65.1	-1.1
2	2390.00	50.9 AV	54.0	-3.1	1.05 H	235	52.0	-1.1
3	*2412.00	117.6 PK			1.05 H	235	118.7	-1.1
4	*2412.00	105.0 AV			1.05 H	235	106.1	-1.1
5	4824.00	49.5 PK	74.0	-24.5	1.36 H	202	41.8	7.7
6	4824.00	36.9 AV	54.0	-17.1	1.36 H	202	29.2	7.7

Antenna Polarity & Test Distance : Vertical at 3 m

No	Frequency (MHz)	Emission Level (dBuV/m)	Limit (dBuV/m)	Margin (dB)	Antenna Height (m)	Table Angle (Degree)	Raw Value (dBuV)	Correction Factor (dB/m)
1	2390.00	59.9 PK	74.0	-14.1	2.41 V	212	61.0	-1.1
2	2390.00	46.3 AV	54.0	-7.7	2.41 V	212	47.4	-1.1
3	*2412.00	115.2 PK			2.41 V	212	116.3	-1.1
4	*2412.00	102.2 AV			2.41 V	212	103.3	-1.1
5	4824.00	49.2 PK	74.0	-24.8	2.16 V	175	41.5	7.7
6	4824.00	36.6 AV	54.0	-17.4	2.16 V	175	28.9	7.7

Remarks:

1. Emission Level(dBuV/m) = Raw Value(dBuV) + Correction Factor(dB/m)
2. Correction Factor(dB/m) = Antenna Factor(dB/m) + Cable Factor(dB) – Pre-Amplifier Factor(dB)
3. Margin value = Emission Level – Limit value
4. The other emission levels were very low against the limit.
5. " * ": Fundamental frequency, the limit was restricted at the RF Output Power.



RF Mode	802.11ax (HE20)	Channel	CH 6 : 2437 MHz
Frequency Range	1 GHz ~ 25 GHz	Detector Function & Bandwidth	(PK) RB = 1 MHz, VB = 3 MHz (AV) RB = 1 MHz, VB = 10 Hz
Input Power	120 Vac, 60 Hz	Environmental Conditions	14°C, 58% RH
Tested By	Jed Wu		

Antenna Polarity & Test Distance : Horizontal at 3 m

No	Frequency (MHz)	Emission Level (dBuV/m)	Limit (dBuV/m)	Margin (dB)	Antenna Height (m)	Table Angle (Degree)	Raw Value (dBuV)	Correction Factor (dB/m)
1	*2437.00	117.6 PK			1.07 H	231	118.6	-1.0
2	*2437.00	105.0 AV			1.07 H	231	106.0	-1.0
3	4874.00	49.5 PK	74.0	-24.5	1.38 H	206	41.7	7.8
4	4874.00	36.9 AV	54.0	-17.1	1.38 H	206	29.1	7.8

Antenna Polarity & Test Distance : Vertical at 3 m

No	Frequency (MHz)	Emission Level (dBuV/m)	Limit (dBuV/m)	Margin (dB)	Antenna Height (m)	Table Angle (Degree)	Raw Value (dBuV)	Correction Factor (dB/m)
1	*2437.00	115.1 PK			2.41 V	204	116.1	-1.0
2	*2437.00	102.6 AV			2.41 V	204	103.6	-1.0
3	4874.00	49.2 PK	74.0	-24.8	2.16 V	171	41.4	7.8
4	4874.00	36.6 AV	54.0	-17.4	2.16 V	171	28.8	7.8

Remarks:

1. Emission Level(dBuV/m) = Raw Value(dBuV) + Correction Factor(dB/m)
2. Correction Factor(dB/m) = Antenna Factor(dB/m) + Cable Factor(dB) – Pre-Amplifier Factor(dB)
3. Margin value = Emission Level – Limit value
4. The other emission levels were very low against the limit.
5. " * " : Fundamental frequency, the limit was restricted at the RF Output Power.



RF Mode	802.11ax (HE20)	Channel	CH 11 : 2462 MHz
Frequency Range	1 GHz ~ 25 GHz	Detector Function & Bandwidth	(PK) RB = 1 MHz, VB = 3 MHz (AV) RB = 1 MHz, VB = 10 Hz
Input Power	120 Vac, 60 Hz	Environmental Conditions	14°C, 58% RH
Tested By	Jed Wu		

Antenna Polarity & Test Distance : Horizontal at 3 m

No	Frequency (MHz)	Emission Level (dBuV/m)	Limit (dBuV/m)	Margin (dB)	Antenna Height (m)	Table Angle (Degree)	Raw Value (dBuV)	Correction Factor (dB/m)
1	*2462.00	119.0 PK			2.39 H	178	119.9	-0.9
2	*2462.00	106.1 AV			2.39 H	178	107.0	-0.9
3	2483.50	65.8 PK	74.0	-8.2	2.39 H	178	66.6	-0.8
4	2483.50	51.4 AV	54.0	-2.6	2.39 H	178	52.2	-0.8
5	4924.00	50.8 PK	74.0	-23.2	2.70 H	153	43.0	7.8
6	4924.00	38.2 AV	54.0	-15.8	2.70 H	153	30.4	7.8

Antenna Polarity & Test Distance : Vertical at 3 m

No	Frequency (MHz)	Emission Level (dBuV/m)	Limit (dBuV/m)	Margin (dB)	Antenna Height (m)	Table Angle (Degree)	Raw Value (dBuV)	Correction Factor (dB/m)
1	*2462.00	116.6 PK			3.73 V	152	117.5	-0.9
2	*2462.00	103.9 AV			3.73 V	152	104.8	-0.9
3	2483.50	65.3 PK	74.0	-8.7	3.73 V	152	66.1	-0.8
4	2483.50	50.9 AV	54.0	-3.1	3.73 V	152	51.7	-0.8
5	4924.00	50.5 PK	74.0	-23.5	3.48 V	119	42.7	7.8
6	4924.00	37.9 AV	54.0	-16.1	3.48 V	119	30.1	7.8

Remarks:

1. Emission Level(dBuV/m) = Raw Value(dBuV) + Correction Factor(dB/m)
2. Correction Factor(dB/m) = Antenna Factor(dB/m) + Cable Factor(dB) – Pre-Amplifier Factor(dB)
3. Margin value = Emission Level – Limit value
4. The other emission levels were very low against the limit.
5. " * ": Fundamental frequency, the limit was restricted at the RF Output Power.



RF Mode	802.11ax (HE40)	Channel	CH 3 : 2422 MHz
Frequency Range	1 GHz ~ 25 GHz	Detector Function & Bandwidth	(PK) RB = 1 MHz, VB = 3 MHz (AV) RB = 1 MHz, VB = 10 Hz
Input Power	120 Vac, 60 Hz	Environmental Conditions	14°C, 58% RH
Tested By	Jed Wu		

Antenna Polarity & Test Distance : Horizontal at 3 m

No	Frequency (MHz)	Emission Level (dBuV/m)	Limit (dBuV/m)	Margin (dB)	Antenna Height (m)	Table Angle (Degree)	Raw Value (dBuV)	Correction Factor (dB/m)
1	2390.00	61.4 PK	74.0	-12.6	1.05 H	236	62.5	-1.1
2	2390.00	49.3 AV	54.0	-4.7	1.05 H	236	50.4	-1.1
3	*2422.00	112.3 PK			1.05 H	236	113.3	-1.0
4	*2422.00	99.5 AV			1.05 H	236	100.5	-1.0
5	4844.00	49.9 PK	74.0	-24.1	1.36 H	205	42.2	7.7
6	4844.00	37.3 AV	54.0	-16.7	1.36 H	205	29.6	7.7

Antenna Polarity & Test Distance : Vertical at 3 m

No	Frequency (MHz)	Emission Level (dBuV/m)	Limit (dBuV/m)	Margin (dB)	Antenna Height (m)	Table Angle (Degree)	Raw Value (dBuV)	Correction Factor (dB/m)
1	2390.00	58.2 PK	74.0	-15.8	2.39 V	209	59.3	-1.1
2	2390.00	44.9 AV	54.0	-9.1	2.39 V	209	46.0	-1.1
3	*2422.00	109.8 PK			2.39 V	209	110.8	-1.0
4	*2422.00	97.3 AV			2.39 V	209	98.3	-1.0
5	4844.00	49.6 PK	74.0	-24.4	2.14 V	176	41.9	7.7
6	4844.00	37.0 AV	54.0	-17.0	2.14 V	176	29.3	7.7

Remarks:

1. Emission Level(dBuV/m) = Raw Value(dBuV) + Correction Factor(dB/m)
2. Correction Factor(dB/m) = Antenna Factor(dB/m) + Cable Factor(dB) – Pre-Amplifier Factor(dB)
3. Margin value = Emission Level – Limit value
4. The other emission levels were very low against the limit.
5. " * ": Fundamental frequency, the limit was restricted at the RF Output Power.



RF Mode	802.11ax (HE40)	Channel	CH 6 : 2437 MHz
Frequency Range	1 GHz ~ 25 GHz	Detector Function & Bandwidth	(PK) RB = 1 MHz, VB = 3 MHz (AV) RB = 1 MHz, VB = 10 Hz
Input Power	120 Vac, 60 Hz	Environmental Conditions	14°C, 58% RH
Tested By	Jed Wu		

Antenna Polarity & Test Distance : Horizontal at 3 m								
No	Frequency (MHz)	Emission Level (dBuV/m)	Limit (dBuV/m)	Margin (dB)	Antenna Height (m)	Table Angle (Degree)	Raw Value (dBuV)	Correction Factor (dB/m)
1	*2437.00	114.3 PK			1.05 H	234	115.3	-1.0
2	*2437.00	101.8 AV			1.05 H	234	102.8	-1.0
3	4874.00	50.1 PK	74.0	-23.9	1.35 H	207	42.3	7.8
4	4874.00	37.5 AV	54.0	-16.5	1.35 H	207	29.7	7.8

Antenna Polarity & Test Distance : Vertical at 3 m								
No	Frequency (MHz)	Emission Level (dBuV/m)	Limit (dBuV/m)	Margin (dB)	Antenna Height (m)	Table Angle (Degree)	Raw Value (dBuV)	Correction Factor (dB/m)
1	*2437.00	111.8 PK			2.41 V	213	112.8	-1.0
2	*2437.00	99.4 AV			2.41 V	213	100.4	-1.0
3	4874.00	49.8 PK	74.0	-24.2	2.16 V	180	42.0	7.8
4	4874.00	37.2 AV	54.0	-16.8	2.16 V	180	29.4	7.8

Remarks:

1. Emission Level(dBuV/m) = Raw Value(dBuV) + Correction Factor(dB/m)
2. Correction Factor(dB/m) = Antenna Factor(dB/m) + Cable Factor(dB) – Pre-Amplifier Factor(dB)
3. Margin value = Emission Level – Limit value
4. The other emission levels were very low against the limit.
5. " * " : Fundamental frequency, the limit was restricted at the RF Output Power.



RF Mode	802.11ax (HE40)	Channel	CH 9 : 2452 MHz
Frequency Range	1 GHz ~ 25 GHz	Detector Function & Bandwidth	(PK) RB = 1 MHz, VB = 3 MHz (AV) RB = 1 MHz, VB = 10 Hz
Input Power	120 Vac, 60 Hz	Environmental Conditions	14°C, 58% RH
Tested By	Jed Wu		

Antenna Polarity & Test Distance : Horizontal at 3 m

No	Frequency (MHz)	Emission Level (dBuV/m)	Limit (dBuV/m)	Margin (dB)	Antenna Height (m)	Table Angle (Degree)	Raw Value (dBuV)	Correction Factor (dB/m)
1	*2452.00	113.0 PK			2.64 H	178	113.9	-0.9
2	*2452.00	101.0 AV			2.64 H	178	101.9	-0.9
3	2483.50	62.2 PK	74.0	-11.8	2.64 H	178	63.0	-0.8
4	2483.50	49.1 AV	54.0	-4.9	2.64 H	178	49.9	-0.8
5	4904.00	50.6 PK	74.0	-23.4	2.95 H	147	42.8	7.8
6	4904.00	38.0 AV	54.0	-16.0	2.95 H	147	30.2	7.8

Antenna Polarity & Test Distance : Vertical at 3 m

No	Frequency (MHz)	Emission Level (dBuV/m)	Limit (dBuV/m)	Margin (dB)	Antenna Height (m)	Table Angle (Degree)	Raw Value (dBuV)	Correction Factor (dB/m)
1	*2452.00	109.6 PK			3.98 V	150	110.5	-0.9
2	*2452.00	96.5 AV			3.98 V	150	97.4	-0.9
3	2483.50	61.6 PK	74.0	-12.4	3.98 V	150	62.4	-0.8
4	2483.50	48.6 AV	54.0	-5.4	3.98 V	150	49.4	-0.8
5	4904.00	50.3 PK	74.0	-23.7	3.73 V	117	42.5	7.8
6	4904.00	37.7 AV	54.0	-16.3	3.73 V	117	29.9	7.8

Remarks:

1. Emission Level(dBuV/m) = Raw Value(dBuV) + Correction Factor(dB/m)
2. Correction Factor(dB/m) = Antenna Factor(dB/m) + Cable Factor(dB) – Pre-Amplifier Factor(dB)
3. Margin value = Emission Level – Limit value
4. The other emission levels were very low against the limit.
5. " * ": Fundamental frequency, the limit was restricted at the RF Output Power.



Plot of Band Edge

802.11b Channel 1

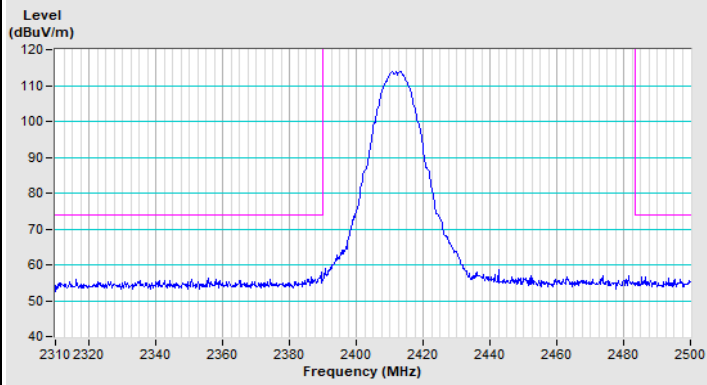

Horizontal (Peak)

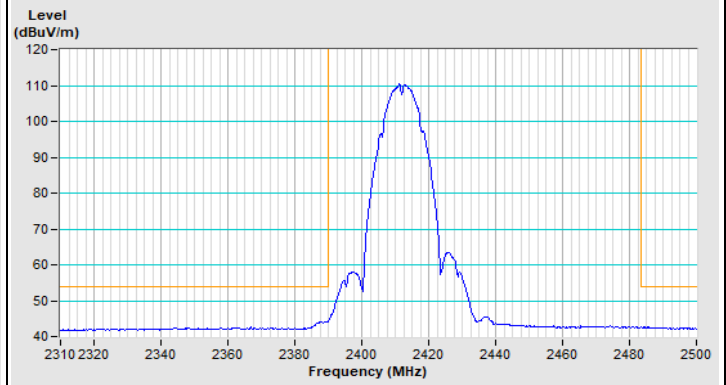

Horizontal (Average)

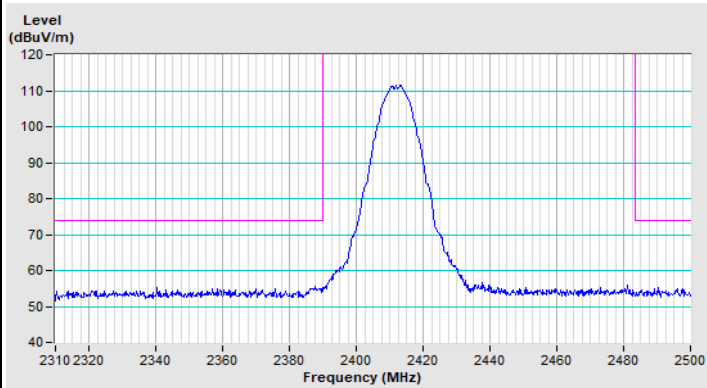

Vertical (Peak)

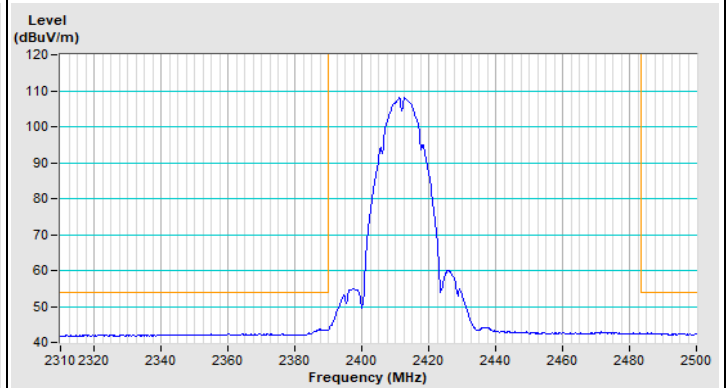

Vertical (Average)

802.11b Channel 11

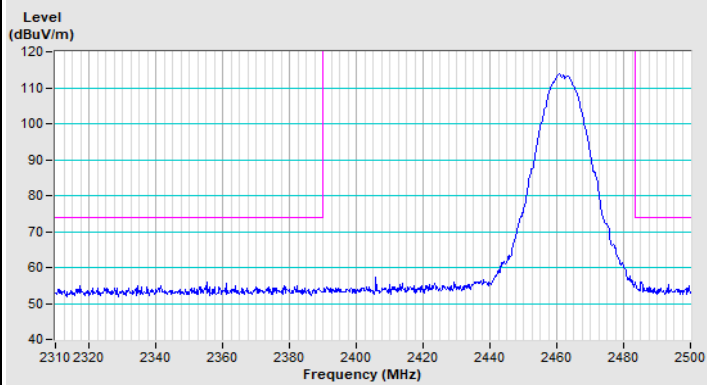

Horizontal (Peak)

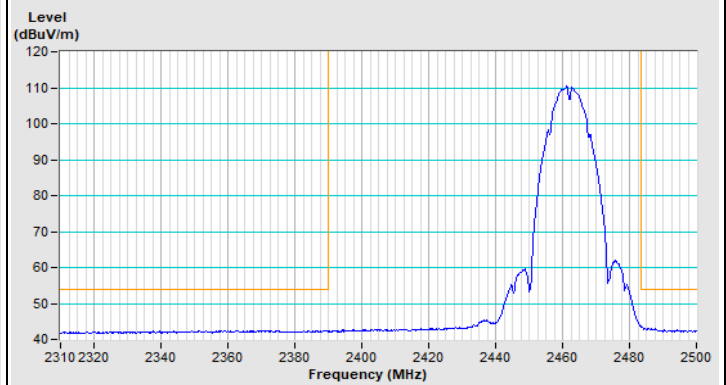

Horizontal (Average)

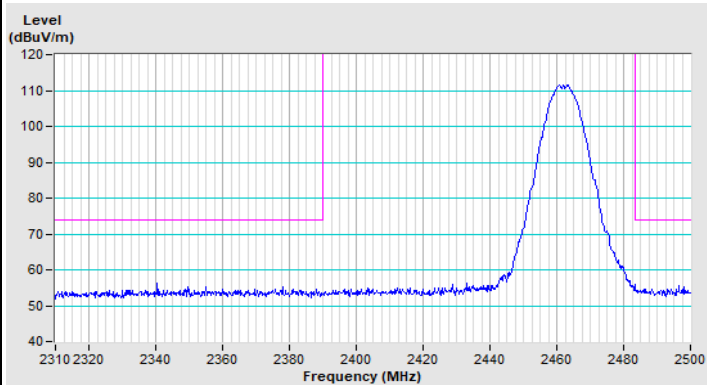

Vertical (Peak)

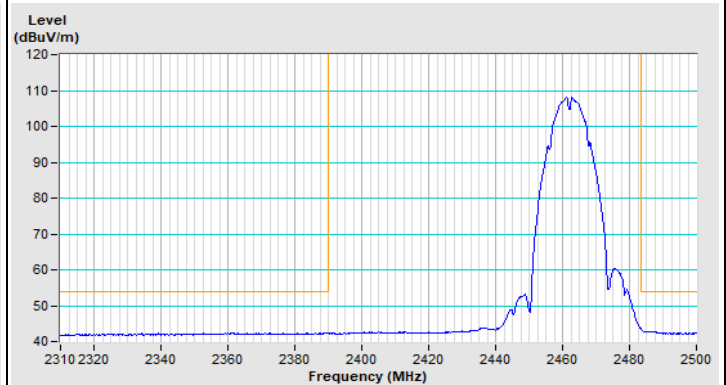

Vertical (Average)

802.11g Channel 1

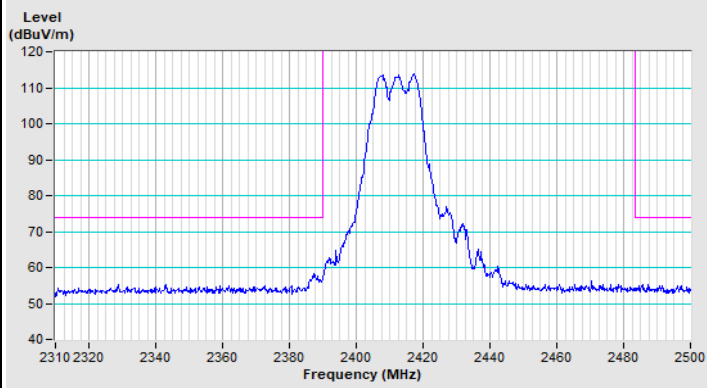

Horizontal (Peak)

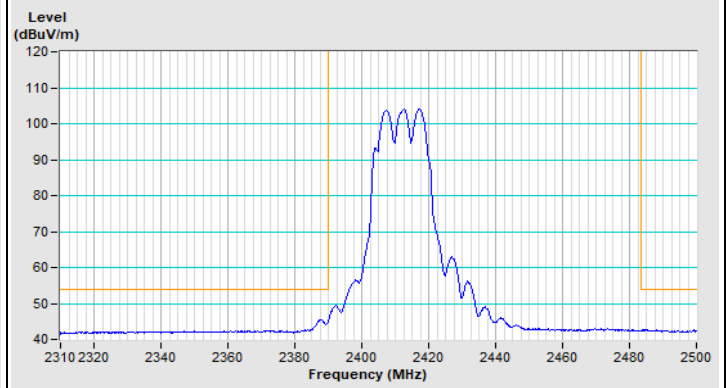

Horizontal (Average)

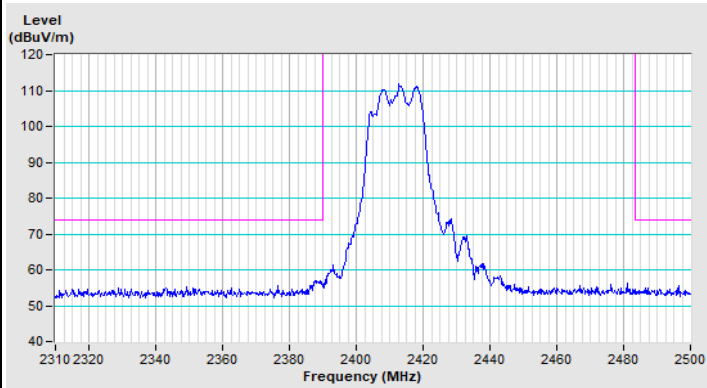

Vertical (Peak)

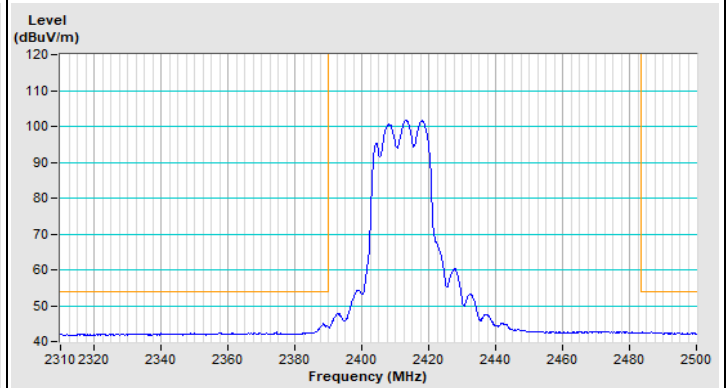

Vertical (Average)

802.11g Channel 11

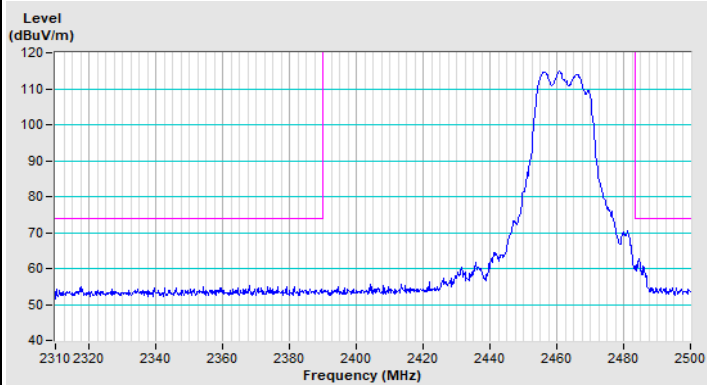

Horizontal (Peak)

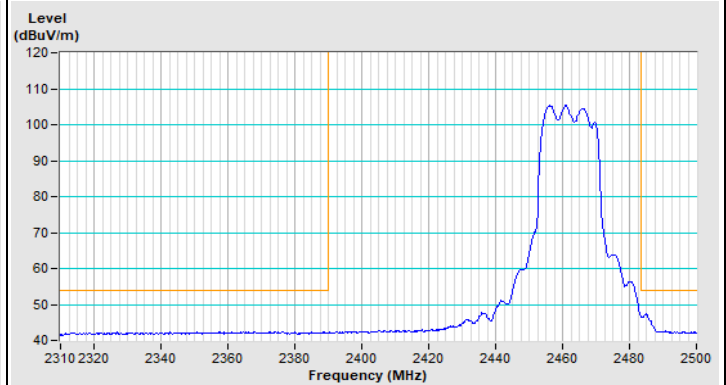

Horizontal (Average)

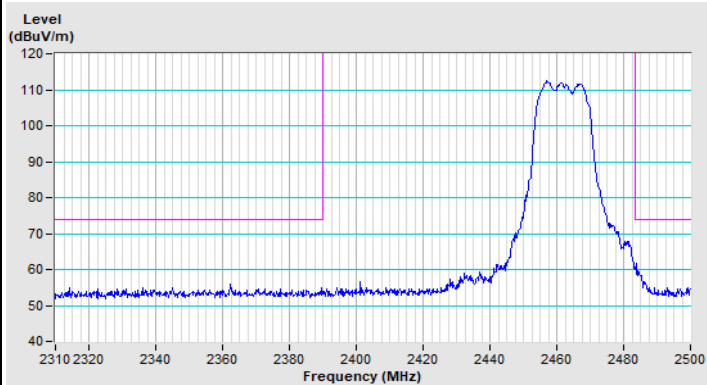

Vertical (Peak)

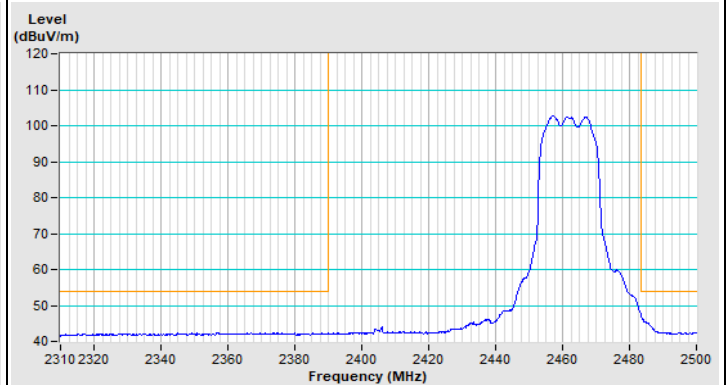

Vertical (Average)

802.11ax (HE20) Channel 1

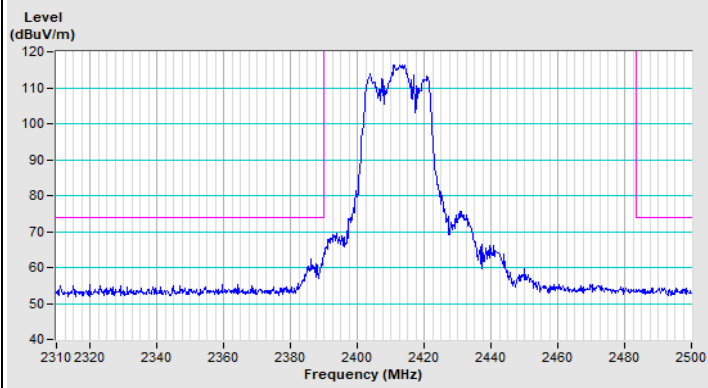

Horizontal (Peak)

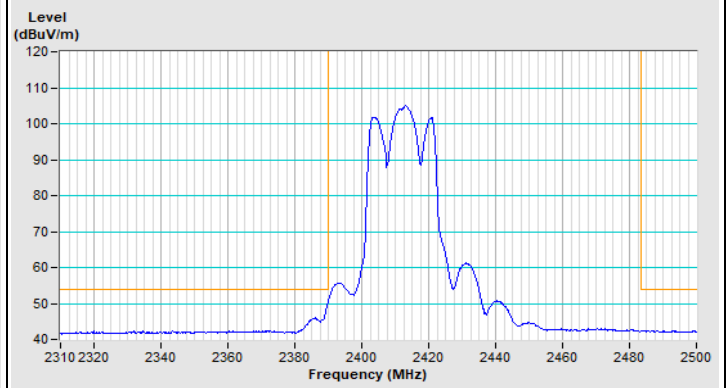

Horizontal (Average)

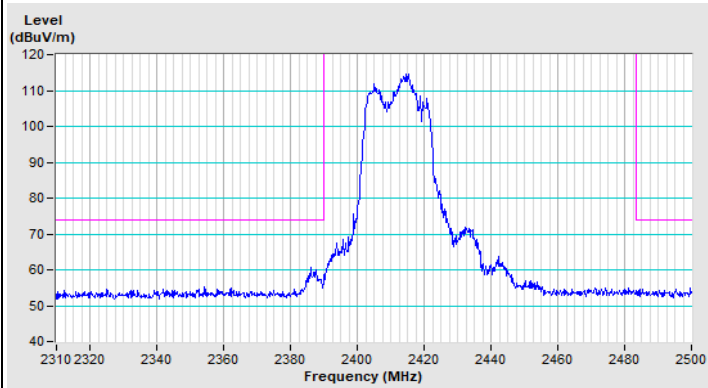

Vertical (Peak)

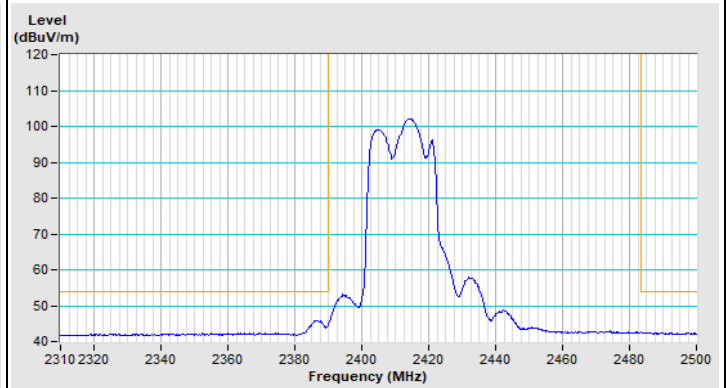

Vertical (Average)

802.11ax (HE20) Channel 11

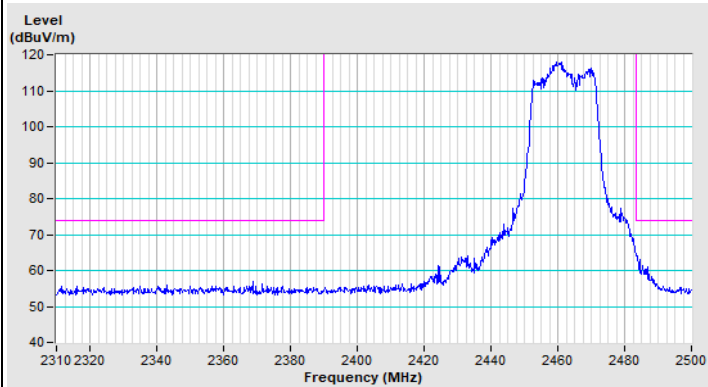

Horizontal (Peak)

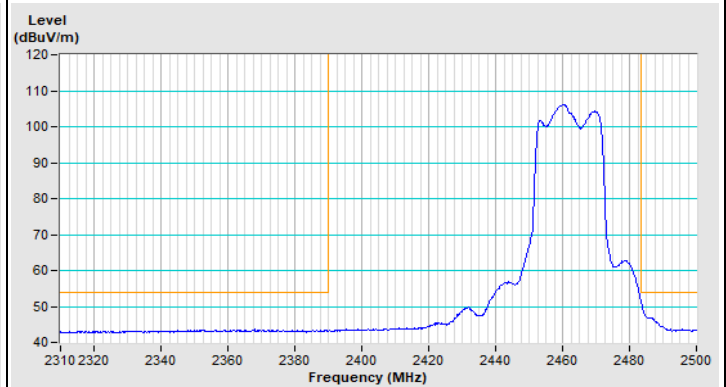

Horizontal (Average)

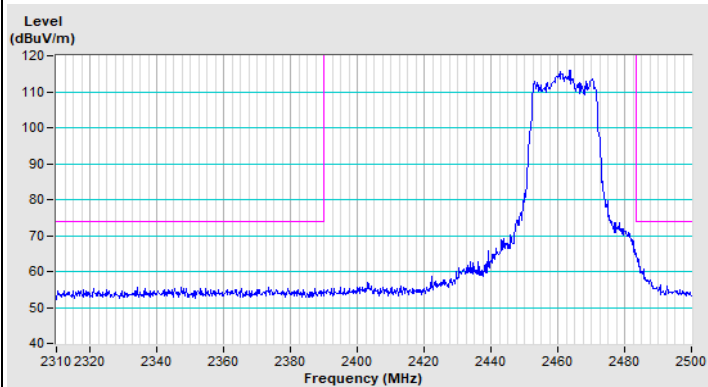

Vertical (Peak)

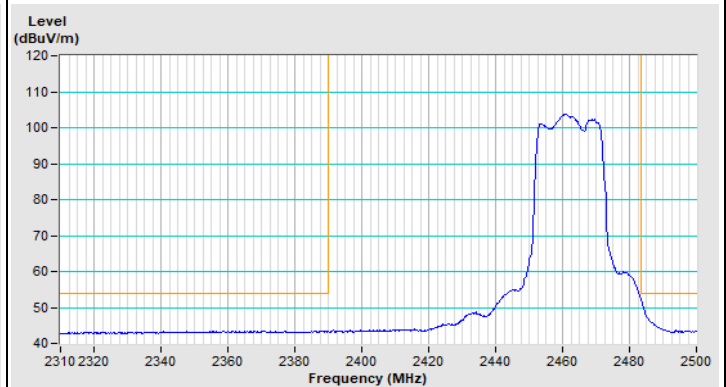

Vertical (Average)

802.11ax (HE40) Channel 3

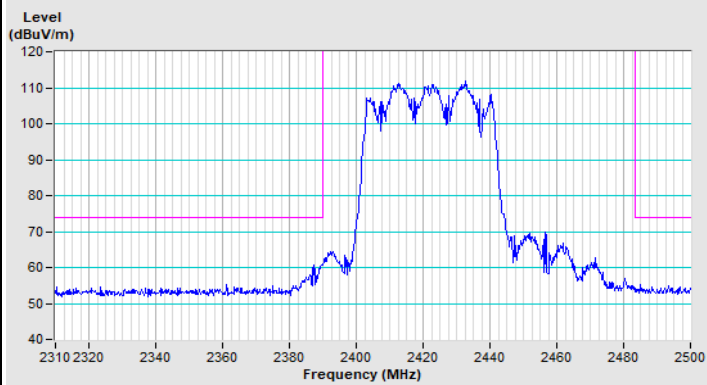

Horizontal (Peak)

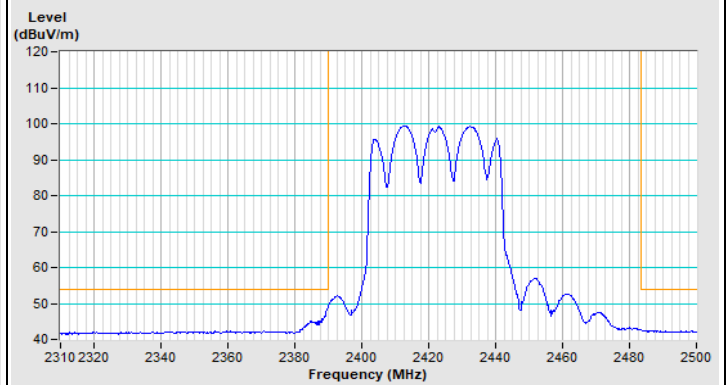

Horizontal (Average)

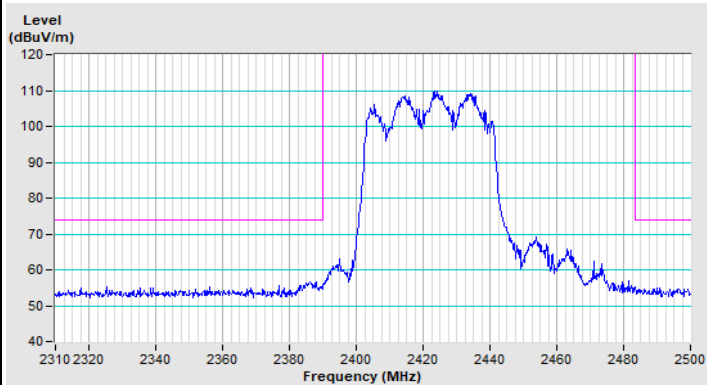

Vertical (Peak)

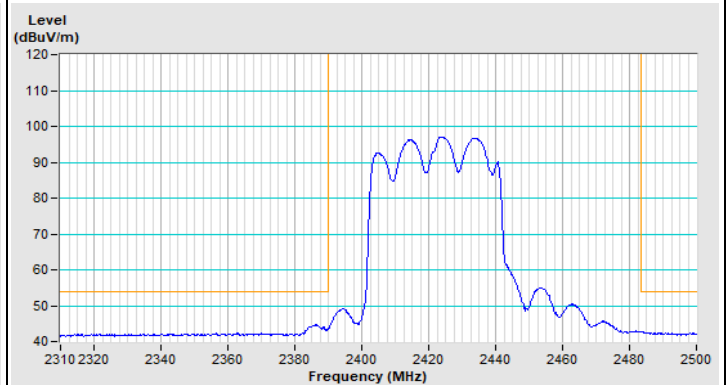

Vertical (Average)

802.11ax (HE40) Channel 9

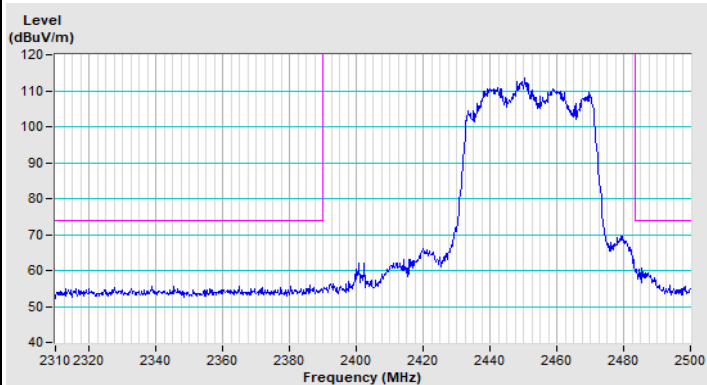

Horizontal (Peak)

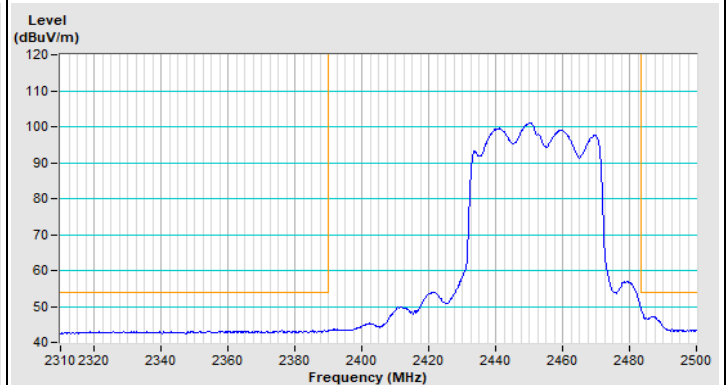

Horizontal (Average)

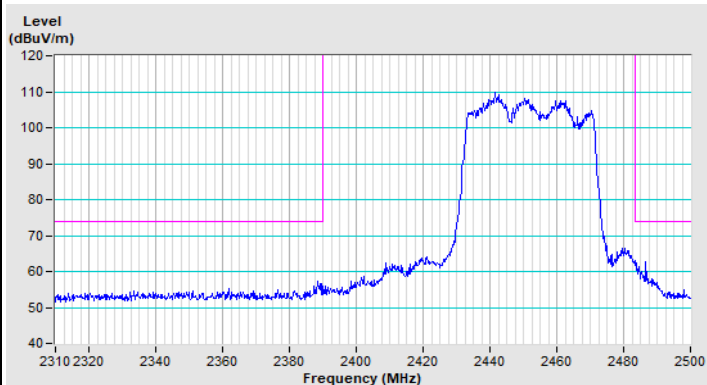

Vertical (Peak)

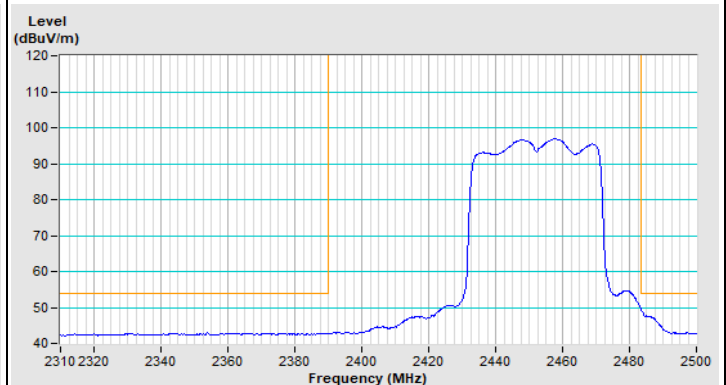

Vertical (Average)

8 Pictures of Test Arrangements

Please refer to the attached file (Test Setup Photo)

9 Information of the Testing Laboratories

We, Bureau Veritas Consumer Products Services (H.K.) Ltd., Taoyuan Branch, were founded in 1988 to provide our best service in EMC, Radio, Telecom and Safety consultation. Our laboratories are FCC recognized accredited test firms and accredited according to ISO/IEC 17025.

If you have any comments, please feel free to contact us at the following:

Lin Kou EMC/RF Lab

Tel: 886-2-26052180

Fax: 886-2-26051924

Hsin Chu EMC/RF/Telecom Lab

Tel: 886-3-6668565

Fax: 886-3-6668323

Hwa Ya EMC/RF/Safety Lab

Tel: 886-3-3183232

Fax: 886-3-3270892

Email: service.adt@bureauveritas.com

Web Site: <http://ee.bureauveritas.com.tw>

The address and road map of all our labs can be found in our web site also.

--- END ---