

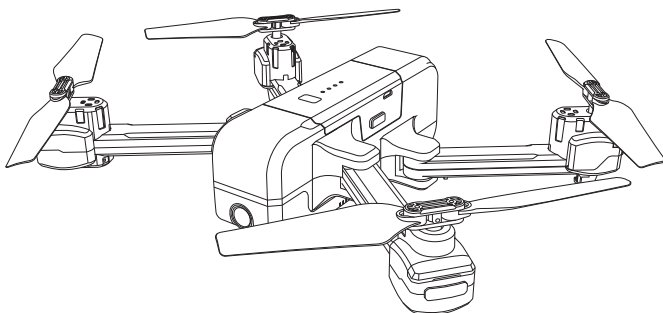

14+
for age

Z5 (GPS)



— ULTRAPORTABLE AND FOLDABLE —

In order to make sure that it meets the requirement of the electromagnetic environment of the aviation radio station, flying within the scope of 10 kilometers on each side by taking the airport runway center line as the middle line is **HIGHLY FORBIDDEN** or flying within the scope of 20 kilometers by taking both ends of the runway as the center is **HIGHLY FORBIDDEN**. Flying on the route of the airline is also **PROHIBITED**. Stop using all kinds of flying models or unmanned Quad-rotors in the AREA that prohibited by related authority or department of our country.

CONTENTS

PREFACE	1
WARNING	2
FLY SAFETY	5
TRANSMITTER FUNCTIONS	6
AIRCRAFT DIAGRAM	7
1.ASSEMBLE THE PROPELLER	7
2.INTELLIGENT FLIGHT BATTERY	7
3.CHARGING THE BATTERY	8
USING THE TRANSMITTER	9
FLIGHT	9 10 11
COMPASS CALIBRATION	10
WAY POINT FLIGHT	12
POINT OF INTEREST	12
PRODUCT FUNCTIONS PROFILE	13
1. TAKE OFF/LANDING/EMERGENCY STOP	13
2.FOLLOW ME	13
3.ACTIVE TRACK	14
4. HAND GESTURE	14
5.RETURN TO HOME	14
6.HEADLESS MODE	15
7.TRIM	16
COMMON PROBLEMS AND SOLUTIONS	21

PREFACE

Thank you for purchasing the SJ-Series GPS Drone. Please read all instructions and warnings carefully before operating. Please also keep this instruction manual for future reference and maintenance.

IMPORTANT:

1. This product is not a toy. It is a precision device; integrating machinery and electronics with air mechanics and high frequency transmission. It requires correct assembly and debugging to avoid any accident. The user should operate and control this product in a safe manner. In case of incorrect operation, it may cause serious injury or damage property. It can also be lost due to incorrect operation.
2. This product is suitable for experienced UAV pilots no less than 14 years of age.
3. In the event of a problem during using, operating, or maintenance, please contact the local sales agent or retailer or keep in touch with the responsible staff of our company.

SAFETY PRECAUTIONS:

This R/C drone can be dangerous when in use, please make sure you keep it far away from any persons or spectators when flying. In-correct installation, poor conditions, or users not familiar with operation may cause damage to the aircraft or injure people or may cause an unexpected accident. Please pay close attention to flying safety and learn to recognize more dangerous conditions which may cause an accident due to your own negligence.

1. Keep it far away from any structures or crowds.

This R/C drone may vary slightly in speed or sensitivity while flying and can cause potential danger. Therefore, please keep it far away from crowds, buildings, trees, structures, high-voltage wire, etc. Please also avoid flying in adverse weather conditions such as rain, electrical storms, and high winds to ensure safety of the user, any spectators, and surrounding property.

2. Keep it away from any moist environment.

The inside of the drone is composed of many precision electronic and mechanical parts. Therefore, please try to avoid any moisture or water content from entering the main body of the aircraft as it may cause a breakdown of the mechanical and electronic parts and thus cause an accident.

3. Only operate with included parts for intended use.

Please use the original parts made by SJ-Series for any re-equipping or maintenance to ensure flying safety. Please operate and use only under the scope of the product function permitted. Using un-approved parts will void warranty.

DO NOT use for any illegal purpose or use beyond the scope of which your local laws and regulations have stipulated.

4. Avoid controlling it independently.

New users may have certain difficulties during the early stages of learning to operate this aircraft. Please try to avoid operating the aircraft alone.

When available, always operate this aircraft under the guidance of a more experienced user.

5. Do not operate under the influence of drugs or alcohol.

Please operate this R/C drone according to your own state and flying skill.

Any fatigue, bad mental state, or incorrect operation may increase the probability of accidental risk.

6. Please keep a safe range from aircraft when using top speed.

When the operator is flying in high speed, please keep the aircraft far from the pilot and any surrounding persons or objects so as not to cause danger or damage.

7. Store it in a cool, dry place.

The R/C drone is composed of material such as metal, fiber, plastic, electronics, etc. Therefore, please keep it away from any heat source and avoid prolonged exposure to direct sunlight. Excessive heat exposure can cause distortion and damage.

- NOTE: This equipment has been tested and found to comply with the limits for a Class B digital device, pursuant to part 15 of the FCC Rules. These limits are designed to provide reasonable protection against harmful interference in a residential installation. This equipment generates, uses and can radiate radio frequency energy and, if not installed and used in accordance with the instructions, may cause harmful interference to radio communications.

- However, there is no guarantee that interference will not occur in a particular installation. If this equipment does cause harmful interference to radio or television reception, which can be determined by turning the equipment off and on, the user is encouraged to try to correct the interference by one or more of the following measures:
 - Reorient or relocate the receiving antenna.
 - Increase the separation between the equipment and receiver.
 - Connect the equipment into an outlet on a circuit different from that to which the receiver is connected.
 - Consult the dealer or an experienced radio/TV technician for help.

- Please note that changes or modifications not expressly approved by the party responsible for compliance could void the use's authority to operate the equipment.

WARNING

1. There is important information contained in this package and instruction manual, please keep it for future reference.
2. You have the responsibility to make sure that this model of aircraft won't cause injury to others' body or cause any damage to property.
3. Please operate strictly as shown on the instruction manual when debugging or assembling this drone. During the process of flying or landing, please pay more attention to keep 1-2 meters between the user and the aircraft to avoid colliding to the head or face or body, which may cause injury.
4. Our company and distributors won't be responsible for any incorrect operation, which may cause loss or damage or injury to the body.
5. Children ages 14 and up should use this product under the guidance of an adult. This product is FORBIDDEN to be used by children under 14 years old.
6. Please correctly assemble and use this product as shown on the instruction manual or packing instruction. Some parts should be assembled by an adult.
7. Small parts are included with this product. Please place it beyond the reach of the children to avoid a CHOKING HAZARD or parts being mistakenly swallowed.
8. Playing on the road or near high traffic areas is strictly FORBIDDEN so as not to cause an accident.
9. Please dispose of the packing material timely so as not to cause injury to children.
10. Please DO NOT disassemble or re-equip the aircraft as it may cause a breakdown of the aircraft during flying.
11. Batteries in the battery compartment of the charger should be inserted into the designated power source which has the same logo as the product.
12. Built-in rechargeable 3.7V lithium polymer battery included in the transmitter.
13. Only the original charger made from our factory can be used.
14. Charger is not a toy.
15. When charging the battery, please conduct it under the surveillance of an adult. Please also keep it far away from any combustible object when charging. Please keep this aircraft within eyesight when charging.
16. Please DO NOT make it short-circuited or squeeze the battery so as not to cause an explosion.
17. DO NOT mix the Li-ion battery with a different type of battery.
18. Intelligent lithium battery is loaded in the Quad-rotor. Both built-in or external can be used for charging.
19. Please DO NOT make the battery short-circuited or decompose the battery or throw the battery into the fire; DO NOT place the batteries near the high temperature or heated area (such as near the fire or near the electric heating device).

20. The drone should be kept far away from any other electric compliance or equipment as far as possible or kept far away from the place where having the magnetic object nearby as they may cause interference with each other.
21. Please keep the safe distance from the high-speed rotating rotor so as not to cause twisted or danger of being wounded or being cut.
22. Engine will heat up. Please DO NOT touch it to avoid being burned or injured.
23. Please DO NOT close this product to your ear as it may cause injury to your hearing.
24. Mini USB 5V wall charger recommended for charging. DO NOT use any charger stronger than 5V.
25. To comply with the command of the magnetic environment requirement formulated by the Aviation Radio Bureau and the related authority, during the regulated period in certain areas, please stop using the transmitter of this model when such regulation command is issued.
26. Keep your UAS within sight.
27. Never fly over groups of people.
28. Never fly over stadiums or sports events.
29. Understand airspace restrictions and requirements.



WARNING: Product should only be used by adults and children 14 years and older. Adult supervision required for children under 14 years of age.

WARNING: CHARGING OF THE DRONE BATTERY MUST BE SUPERVISED AT ALL TIMES BY AN ADULT. UNPLUG THE BATTERY WHEN FULLY CHARGED. DO NOT OVER-CHARGE THE BATTERY.

Hereby, [GUANGDONG SHIJI TECHNOLOGY CO., LTD.] declares that the radio equipment type [[Z5GPS1080P] is in compliance with the essential requirements and other relevant provisions of Directive 2014/53/EU. In accordance with Article 10(2) and Article 10(10), this product allowed to be used in all EU Member states.

FLY SAFETY



+



+



+



Fly in Open
Areas

Strong GPS
Signal

Maintain Line
of Sight

Fly Below
400 feet (120 m)



Avoid flying over or near obstacles, crowds, high voltage power lines, trees, airport or bodies of water.

DO NOT fly near strong electromagnetic sources such as power lines and base stations as it may affect the onboard compass.



DO NOT use the drone in adverse weather conditions such as rain, snow, fog and wind speeds exceeding 10 m/s or 22 mph.

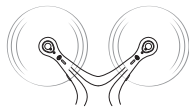

No Fly Zone

Stay away from the rotating
propellers and motors.



It's important to understand basic flight guidelines, for the safety of both you and those around you. Don't forget to read the Safety Guidelines before flight.

TRANSMITTER FUNCTIONS

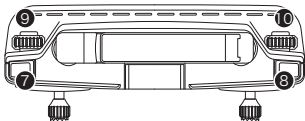
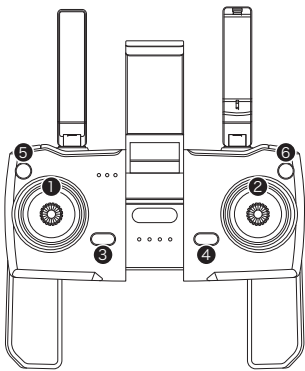

1. Throttle stick
2. Direction stick
3. Click one button Return home
4. Click-"DI" sound-Power on; Press once, then hold the button for 2 seconds –"DI" sound- Power off
5. Click Headless mode; Hold the button for 3 seconds to turn off GPS mode
6. One button take off with auto hover; One button landing; Hold the button for 3 seconds for Emergency stop
7. Click the button to take photo; Press the button to enter the trim mode (Note: No need to trim under the GPS MODE)
8. Click the button to take video
9. Speed+/Speed-
10. Adjust the angle of camear: Spin button down: Camera down; Spin button up: Camera up.

1. Full charging:Green light
2. Charging:Red light
3. Power light:White
4. Return home
5. Speed
6. Photo/Video
7. Headless mode/Trim

Remote control battery is not replaceable

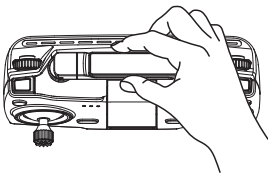
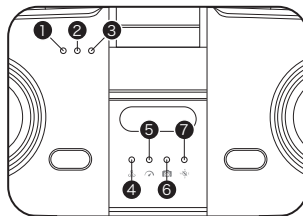

➔ PIC.1

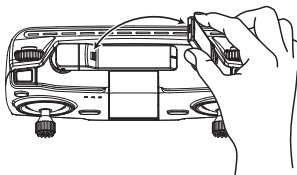

There is a buckle on the antenna, please follow the PIC.1 to open the antenna.

AIRCRAFT DIAGRAM

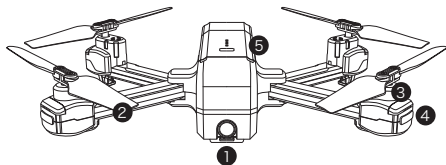

2. Propeller
3. Motor
4. LED indicator
5. Intelligent battery

1. ASSEMBLE THE PROPELLER

Please note that the letter "A" or "B" is printed on each propeller, and make sure all the propellers are attached in the correct motor position.

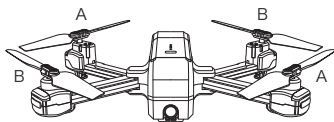

2. INTELLIGENT FLIGHT BATTERY

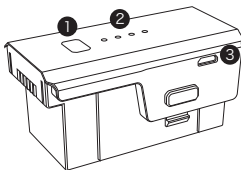

1. Battery switch
2. Battery power indicator
3. USB charging port

Low — Electricity — High



- Short press the power button at once and then long press the power button to turn on the quadcopter. Long press the power button for 3 seconds to turn off.
- Once the battery is in a low power state, the blue power indicator will start flashing. At this time, please fly back the quadcopter immediately and charge the battery to avoid unnecessary losses.

3. CHARGE THE BATTERY

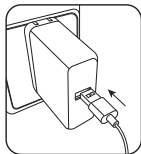
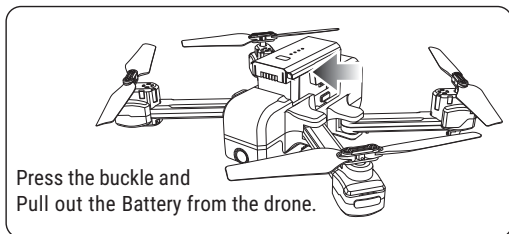

Phone adapter:
5V $\overline{\text{---}}$ 2A
(Not included)

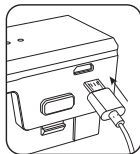

Charging time:
About 110 minutes
(Depending on
Charging Power)

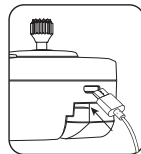

Charging time
of the transmitter:
About 50 minutes

Tip: When the transmitter is in low power, the power indicator light on the transmitter will keep flashing, you need to charge the transmitter this time.

4. LITHIUM BATTERY CHARGING INSTRUCTIONS

1. Balanced charging: If the power switch of the quad-copter is on the state ON / OFF, the Quad-copter can be charged. Insert the USB cable into the USB port of a computer, and then connect with the charging port of the drone, when charging, the indicator on the aircraft will become Blue blinking when in charging; when fully charged, the indicator on the aircraft will turn to solid blue.
2. Quad-copter can be charged by the mobile power or car-loaded power.
3. Full charging time takes about 110 minutes, Flight time about 15 minutes.
4. Remote lithium battery Full charging time takes about 50 minutes.

(When in charging, the indicator on the transmitter become Red; when fully charged, the indicator on the transmitter will turn to solid Green).

REMOTE CONTROL OPERATING METHOD

Throttle Joystick

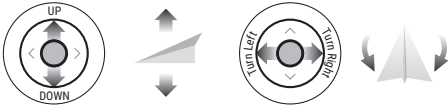

Direction Joystick

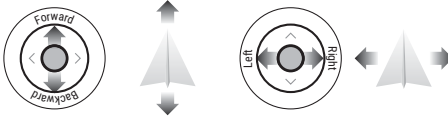

COMMON PROBLEMS AND SOLUTIONS

THE PROBLEM	REASON	COUNTERMEASURES
Drone lights flashing and no response from the drone when operating.	1. Remote is not synced to the drone. 2. Insufficient battery power.	1. Refer to the Quick Start guide and re-sync the drone. 2. Recharge the battery.
The blades spin, but the drone cannot takeoff.	1. Insufficient battery power. 2. The blades distorted.	1. Recharge the battery. 2. Replace the blades.
The quadcopter shakes heavily.	The blades distorted.	Replace the blades.
Drone cannot stay balanced in flight.	1. The blades distorted. 2. The motor doesn't work properly.	1. Replace the blades. 2. Replace the motor.
Drone is unstable after crashing.	Three-axis acceleration sensor loses it's balance after crashing.	Restart and re-calibrate the drone.

Step 4: Compass Calibration

1. Compass Calibration Part 1

- Push the joysticks into the 1 & 11 o'clock position.
- Lights rapid-blinking Blue/red (back) and White/red(front).
- App drone status: "Compass calibration".

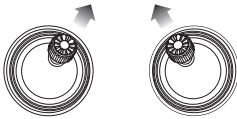

2. Compass Calibration Part 2

- Keeping the drone level, pick up the drone from the back and rotate your body in one full circle (360°).
- Back lights will turn to solid blue.

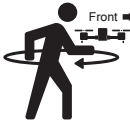

3. Compass Calibration Part 3

- From the bottom, hold the drone vertically and camera is facing to the ground, rotating your body in one full circle(360°).
- Front lights will turn to solid white.
- App drone status: "Compass calibration okay".



Step 5: Reset to factory Setting/Calibrate Gyroscope

- Push the joysticks into the 11 & 1 o'clock position.
- Lights rapid-blinking blue (back) and white (front).
- App Drone Status: "Gyroscope is being calibrated" "Gyroscope okay".

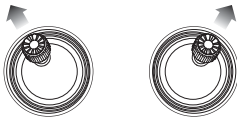

Step 6: GPS Searching (DO NOT use GPS Mode indoor)

- Set the drone back down to level surface.
- Lights return to rapid-blinking blue (back) and white (front) --This means the drone is searching the GPS signal.
- This process can take a few minutes.
- App Drone status: "Waiting for GPS signal".

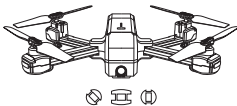

Starting/Stopping motors

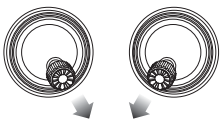

- Push the joysticks into 5 & 7 o'clock position.
- Motors are starting automatically, push the left joystick to take off; or short pressing to take off.

NOTE: Starting the motors should be set before the drone take off.

– Stopping Motors:



1. Pushing the joysticks into 5 & 7 o'clock position again, motors stop working.
2. The motors will stop working if the motors starting are not operated after 20 seconds.

Once the lights have switched to all solid, you are ready to fly!

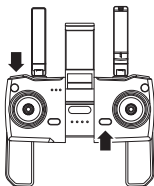
- Blue (back) and white (front) lights are all solid (no blinking).
- App Drone Status: "Ready to fly".



Dual Remote Controller Mode

– Firstly press  then pressing  at the same time --- "DI" "DI" sounds means now the Right Joystick change to the throttle stick. Turn off the transmitter and turn on again, Left Joystick is the throttle stick.



Left Stick

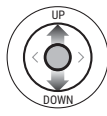

Right Stick

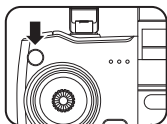
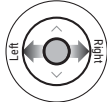

Note: When the aircraft in the indoor environment with weak GPS signal, lights rapid-blinking – Blue (back) + White (front); Press  to turn off GPS mode, and the aircraft can be operated under the normal mode, now all the GPS functions will be cancelled.

FCC Regulatory Compliance

This device complies with Part 15 of the FCC Rules. Operation is subject to the following two conditions: (1) this device may not cause harmful interference, and (2) this device must accept any interference received, including interference that may cause undesired operation.

changes or modifications not expressly approved by the party responsible for compliance could void the user's authority to operate the equipment.

This equipment has been tested and found to comply with the limits for a Class B digital device, pursuant to Part 15 of the FCC Rules. These limits are designed to provide reasonable protection against harmful interference in a residential installation. This equipment generates, uses and can radiate radio frequency energy and, if not installed and used in accordance with the instructions, may cause harmful interference to radio communications. However, there is no guarantee that interference will not occur in a particular installation.

If this equipment does cause harmful interference to radio or television reception, which can be determined by turning the equipment off and on, the user is encouraged to try to correct the interference by one or more of the following measures:

- Reorient or relocate the receiving antenna.
- Increase the separation between the equipment and receiver.
- Connect the equipment into an outlet on a circuit different from that to which the receiver is connected.
- Consult the dealer or an experienced radio/TV technician for help.

PRODUCT FUNCTION PROFILE

1. TAKE-OFF/LANDING/EMERGENCY STOP

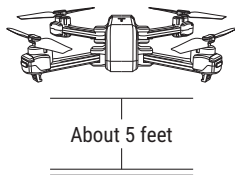
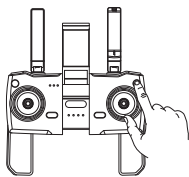

! Rotating propellers can be dangerous. **DO NOT** start the motors when there are people nearby.

Press , the propellers will spin and the drone will take off at an altitude of about 5 feet. (Always keep the head of drone facing forward).

! Press , the drone will land automatically. Remember to always keep your hands on the transmitter as long as the motor is still pinning.



! Hold  3 secs for EMERGENCY STOP.

Only stop motors mid-flight in emergency when doing so can reduce the risk of damage or injury.

2. FOLLOW-ME

When the Follow Me function activated, the drone will follow the GPS in your smart phone to follow you wherever you go.

(Make sure the smart phone connect with the aircraft successfully, turn on APP on your smart phone.)

1. Make sure the aircraft flies 3 meters away ,30 meters height position.
2. Click  on the APP interface.
3. Waiting for APP Drone Status to display "Follow Me ready"--- the aircraft will follow the phone's coordinates.
4. Click the  on the APP interface again to exit the Follow Me mode.

Common Issues:

Follow Me mode would be hardly activated If phone's GPS signal is too weak, This could be due to the signal loss from surrounding buildings, trees, or congestion from too many mobile phones in the area.

* Use in open area and be mindful of your surroundings. Drone is NOT equipped with obstacle avoidance.

4. HAND GESTURE

Click  on the APP, follow the TIP on the APP(PIC.1):
NOTE: Hand gesture should use the RIGHT HAND to start.

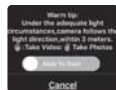

5. RETURN-TO-HOME (RTH)

The Return to Home (RTH) function bring the drones back to the Take Off Point. This function only can be achieved under GPS mode.

There are 3 types of RTH: Smart RTH/Low-battery RTH/Fail connection RTH

①. Smart Return To Home

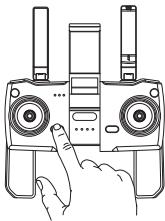

Press the Return to Home Button on your Transmitter or tap on the App of your smart phone, and the transmitter will start beeping. Your drone will return to the TAKE OFF Point. Press the button again to stop RTH procedure. Pull the throttle down to land the drone in a safe area.



RTH Button



The app's RTH Button

②. Low-Battery return to home

Low-Battery RTH is triggered when the Flight Battery level is low, When Low-Battery RTH is activated, the drone will fly back to where away from you about 100 feet, and you can still control your drone. Pull the throttle down to land the drone in a safe area. When the power of drone is completely empty, drone will return to the TAKE OFF point where you set.



③. Fail connection **RETURN-TO-HOME (RTH)**

Drone will enter Return to Home Mode if the signal to the transmitter is lost. Rebind the transmitter to the drone if dronr flies back into your view. Pull the throttle down to land the drone at safe area.

WARNING:

This drone is NOT equipped with obstacle-avoidance.

6. HEADLESS MODE

1. It defaults the Normal Mode when the quadcopter and remote control are matched successfully, click , enter into Headless mode; click  again, exit the Headless mode.
2. Normal mode: Before take-off, the white lights on the quadcopter where they are heading is the forward direction.
3. Headless mode: Before take-off, the white lights on the quadcopter where they are heading is the forward direction. (When the quadcopter rotates in flight, the flight direction will not be changed).

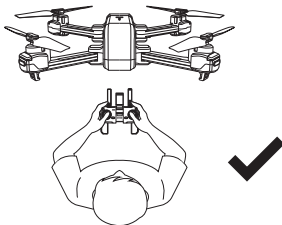

The direction of control when the drone is paired.





Don't turn your direction.



Don't turn your direction.

Under Headless Mode, the forward direction is the direction the pilot faces where the pilot pairs the drone with the transmitter. If the pilot pushes the direction joystick forward the drone will fly forward. If the pilot pushes the direction joystick backward, the drone will flight towards him/her. If the pilot moves the right stick left or right, then the drone will also move left or right relative to you. It is very important that the pilot does not change positions or the direction he or she is facing because this will cause confusion on the drone.

7. TRIM UNDER NO GPS MODE

If the drone flies under NO GPS Mode, you can trim the drone to obtain more balanced flight. Press  for 3 seconds, and you will enter the trim mode. Push the direction stick to the opposite side that the drone drifts to rebalance the drone. For example, if the drone drifts to the left, push the direction stick to the right to make the drone balanced. Press  again to exit the Trim Mode.

Product Description: RC Quadcopter

Manufacturer: GUANGDONG SHIJI TECHNOLOGY CO.,LTD

Address: NO.8, ROAD 5, DACHEWEI AREA,
YONGXIN INDUSTRIAL ZONE, LIANSHANG TOWN,
CHENGHAI DISTRICT, SHANTOU CITY, GUANGDONG PROVINCE, CHINA

Importer: JAMARA E. K.

Address: Am Lauerbühl 5 88317 Aichstetten Germany

Frequency bands: 2405MHz-2478MHz

EIRP: 4.5dBm

GPS: 1559MHz-1610MHz

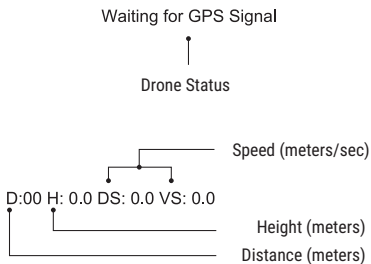
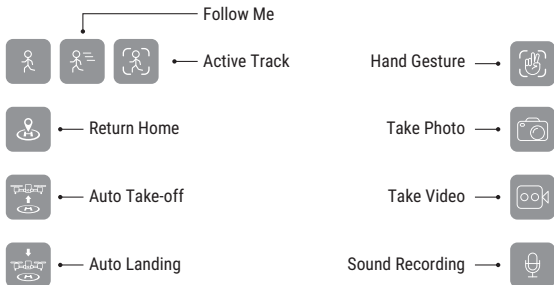
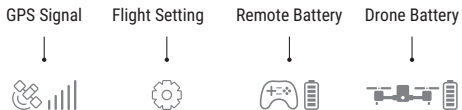
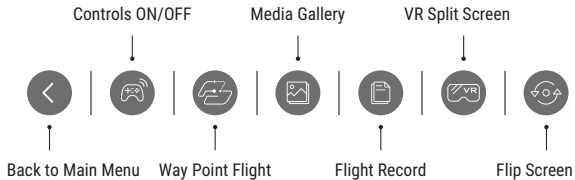

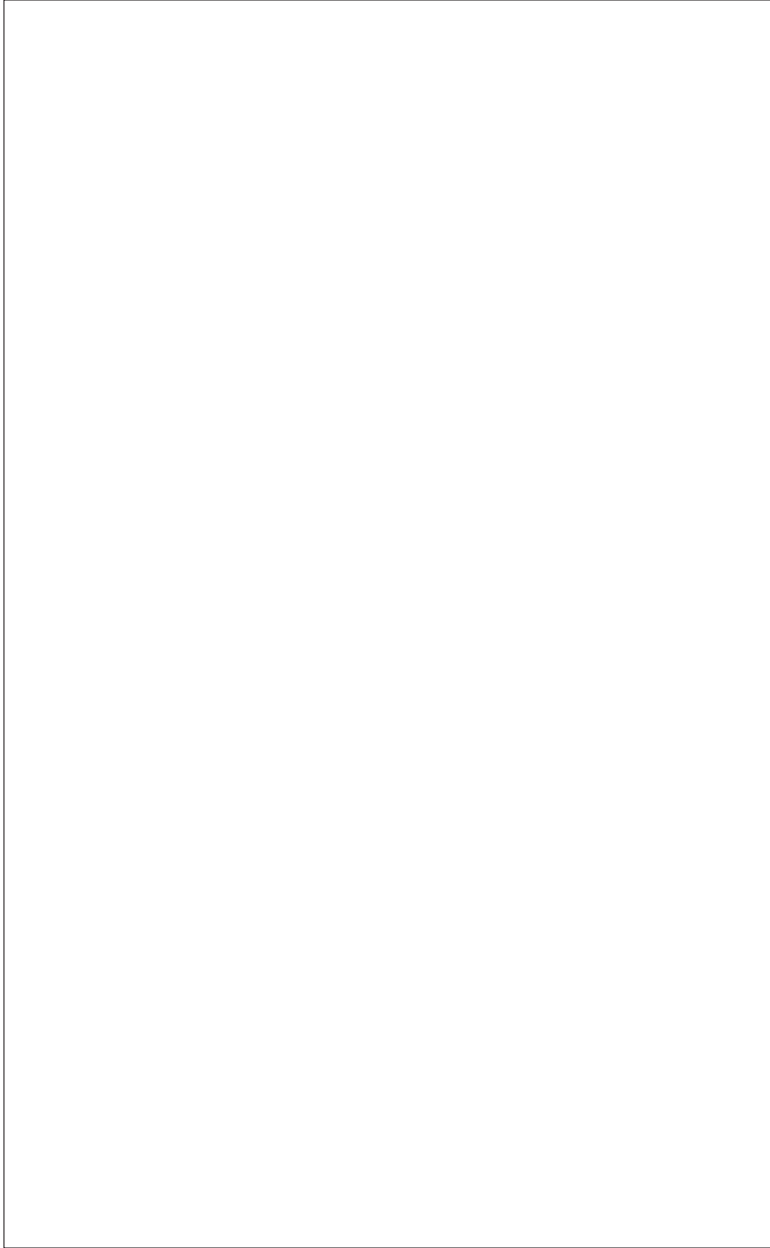

SPECIFICATIONS

- APP / Live View

Mobile App: SJ-GPS PRO

Live View Working Frequency: 2.4 GHz ISM

Live View Quality: 720P @ 25fps / 1080P @ 25fps

(Depend on conditions and mobile device)

Latency: Low Latency Video (depend on conditions and mobile device)

Required Operating Systems: iOS 8.0 or later / Android 4.4.4 or later

Recommended Devices: 4.7" to 5.5" Smart phones

- USB Cable

Voltage: 5V \pm 2A

Rated Power: \leq 10 W

● Transmitter

Operating Frequency: 2.4 GHz

Capacity: 300 mAh

Operating Voltage: 3.7V

Max transmission distance: About 600m (Outdoor and unobstructed)

Max Charging Time: About 50 minutes (Depending on Charging Power)

Flight Time: About 10 Hours

Mobile Device Holder: 4.7" to 5.5" Smart Phones

Operating Temperature: 32° to 104° F (0° to 40° C)

● Flight Battery

Capacity: 1500 mAh

Voltage: 7.4V

Battery Type: Lipo

Energy: 8.88Wh

Net Weight: 66 g / 2.3 oz

Max Charging Power: 5-7.5W

Max Charging Time: About 110 minutes (Depending on Charging Power)

Charging Temperature Range: 14° to 104° F (-10° to 40° C)

PARTS LIST (Included)



Blade X4



Instructions X1

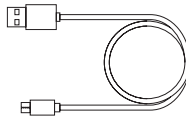

USB cable
Only for charging



Screw driver X1



Screw X8