



FCC TEST REPORT

**Test report
On Behalf of
Solaborate LLC
For
HELLO
Model No.: HELLO**

FCC ID: 2ALUI-HELLO

Prepared for : Solaborate LLC
8300 Utica Ave #283, Rancho Cucamonga, CA 91730

Prepared By : Laboratory of Shenzhen United Testing Technology Co., Ltd
Room 316-319, Block B, Honghualing Industrial Park of the Fifth Zone, Taoyuan
Street, Nanshan District, Shenzhen, Guangdong, China

Date of Test: Apr. 05, 2017 ~ Apr. 12, 2017
Date of Report: Apr. 12, 2017
Report Number: UNI170405085-E



TEST RESULT CERTIFICATION

Applicant's name : Solaborate LLC
 Address : 8300 Utica Ave #283, Rancho Cucamonga, CA 91730
Manufacture's Name..... : Shenzhen Jinjiutianshi Industry Co.,Ltd.
 Address : 4/F, Block B, Dexinchang Industrial Park, Qingxiang Rd., Longhua District, Shenzhen 519109, China

Product description

Trade Mark: /
 Product name : HELLO
 Model and/or type reference : HELLO

Standards : FCC Rules and Regulations Part 15 Subpart C Section 15.247
 ANSI C63.10: 2013

This publication may be reproduced in whole or in part for non-commercial purposes as long as the **Shenzhen United Testing Technology Co., Ltd.** is acknowledged as copyright owner and source of the material. **Shenzhen United Testing Technology Co., Ltd.** takes no responsibility for and will not assume liability for damages resulting from the reader's interpretation of the reproduced material due to its placement and context.

Date of Test :
 Date (s) of performance of tests : Apr. 05, 2017 ~ Apr. 12, 2017
 Date of Issue..... : Apr. 12, 2017
 Test Result..... : **Pass**

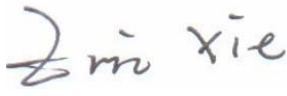
Testing Engineer : 

 (Eric Xie)

Technical Manager : 

 (Dora Qin)

Authorized Signatory : 

 (Kait Chen)

Table of Contents	Page
1 . TEST SUMMARY	5
2 . GENERAL INFORMATION	6
2.1 GENERAL DESCRIPTION OF EUT	6
Operation of EUT during testing	8
2.2 DESCRIPTION OF TEST SETUP	8
2.3 MEASUREMENT INSTRUMENTS LIST	9
3 . CONDUCTED EMISSIONS TEST	10
3.1 Conducted Power Line Emission Limit	10
3.2 Test Setup	10
3.3 Test Procedure	10
3.4 Test Result	10
4 RADIATED EMISSION TEST	13
4.1 Radiation Limit	13
4.2 Test Setup	13
4.3 Test Procedure	14
4.4 Test Result	14
5 BAND EDGE	29
5.1 Limits	29
5.2 Test Procedure	29
5.3 Test Result	29
6 OCCUPIED BANDWIDTH MEASUREMENT	38
6.1 Test Limit	38
6.2 Test Procedure	38
6.3 Measurement Equipment Used	38
6.4 Test Result	38
7 POWER SPECTRAL DENSITY TEST	47
7.1 Test Limit	47
7.2 Test Procedure	47
7.3 Measurement Equipment Used	47
7.4 Test Result	47
8 PEAK OUTPUT POWER TEST	56
8.1 Test Limit	56
8.2 Test Procedure	56
8.3 Measurement Equipment Used	56

Table of Contents	Page
8.4 Test Result	56
9 Out of Band Emissions	57
9.1 Test Limit	57
9.2 Test Procedure	57
9.3 Test Setup	57
7.4 Test Result	57
10 ANTENNA REQUIREMENT	70
11 PHOTOGRAPH OF TEST	71
11.1 Radiated Emission	71
11.2 Conducted Emission	72

1. TEST SUMMARY

1.1 TEST PROCEDURES AND RESULTS

DESCRIPTION OF TEST	RESULT
CONDUCTED EMISSIONS TEST	COMPLIANT
RADIATED EMISSION TEST	COMPLIANT
BAND EDGE	COMPLIANT
OCCUPIED BANDWIDTH MEASUREMENT	COMPLIANT
POWER SPECTRAL DENSITY	COMPLIANT
PEAK OUTPUT POWER _{Peak}	COMPLIANT
Out of Band Emissions	COMPLIANT
ANTENNA REQUIREMENT	COMPLIANT

1.2 TEST FACILITY

Test Firm : Dongguan Dongdian Testing Service Co., Ltd
 Certificated by FCC, Registration No.: 270092
 Address : No.17 Zongbu road 2, Songshan Lake Sci&Tech Park, DongGuan
 City, Guangdong province,523808 China

1.3 MEASUREMENT UNCERTAINTY

Measurement Uncertainty	
Conducted Emission Expanded Uncertainty	= 2.23dB, k=2
Radiated emission expanded uncertainty(9kHz-30MHz)	= 3.08dB, k=2
Radiated emission expanded uncertainty(30MHz-1000MHz)	= 4.42dB, k=2
Radiated emission expanded uncertainty(Above 1GHz)	= 4.06dB, k=2

2. GENERAL INFORMATION

2.1 GENERAL DESCRIPTION OF EUT

Equipment	HELLO
Model Name	HELLO
Serial No	/
Model Difference	/
FCC ID	2ALUI-HELLO
Antenna Type	Integral Antenna
Antenna Gain	2dBi
Operation frequency	802.11b/g/n 20:2412~2462 MHz 802.11n 40: 2422~2452MHz
Number of Channels	802.11b/g/n20: 11CH 802.11n 40: 7CH
Modulation Type	CCK/OFDM/DBPSK/DAPSK
Power Source	N/A
Power Rating	DC5V 2.5A from AC adapter with 100-240V~ 50/60Hz 0.3A

Equipment	HELLO
Model Name	HELLO
Serial No	/
Model Difference	/
FCC ID	2ALUI-HELLO
Antenna Type	Integral Antenna
Antenna Gain	2dBi
Operation frequency	2402-2480MHz
Number of Channels	40CH
Modulation Type	GFSK
Power Source	N/A
Power Rating	DC5V 2.5A from AC adapter with 100-240V~ 50/60Hz 0.3A

Equipment	HELLO
Model Name	HELLO
Serial No	/
Model Difference	/
FCC ID	2ALUI-HELLO
Antenna Type	Integral Antenna
Antenna Gain	2dBi
Operation frequency	2402-2480MHz
Number of Channels	79CH
Modulation Type	GFSK
Power Source	N/A
Power Rating	DC5V 2.5A from AC adapter with 100-240V~ 50/60Hz 0.3A

Equipment	HELLO
Model Name	HELLO
Serial No	/
Model Difference	/
FCC ID	2ALUI-HELLO
Antenna Type	Integral Antenna
Antenna Gain	2dBi
Operation frequency	802.11a/n 20:5180~5240 MHz; 802.11n 40: 5190~5230 MHz; 802.11ac:5210 MHz
Number of Channels	802.11a/n20: 4CH; 802.11n 40: 2CH; 802.11 ac: 1CH;
Modulation Type	CCK/OFDM/DBPSK/DAPSK
Power Source	N/A
Power Rating	DC5V 2.5A from AC adapter with 100-240V~ 50/60Hz 0.3A

Note: This report only 2.4G WIFI test report, 5G WIFI /BT(40CH) and BT(79CH) transmitters see the other test reports.

2.1.1 Carrier Frequency of Channels

Channel List for 802.11b/g/n(20MHz)							
Channel	Frequency (MHz)	Channel	Frequency (MHz)	Channel	Frequency (MHz)	Channel	Frequency (MHz)
01	2412	04	2427	07	2442	10	2457
02	2417	05	2432	08	2447	11	2462
03	2422	06	2437	09	2452		

Channel List for 802.11n(40MHz)							
Channel	Frequency (MHz)	Channel	Frequency (MHz)	Channel	Frequency (MHz)	Channel	Frequency (MHz)
03	2422	06	2437	09	2452		
04	2427	07	2442				
05	2432	08	2447				

Operation of EUT during testing

Operating Mode

The mode is used: **Transmitting mode for 802.11b/g/n(20MHz)**

- Low Channel: 2412MHz
- Middle Channel: 2437MHz
- High Channel: 2462MHz

Transmitting mode for 802.11n(40MHz)

- Low Channel: 2422MHz
- Middle Channel: 2437MHz
- High Channel: 2452MHz

2.2 DESCRIPTION OF TEST SETUP

Operation of EUT during conducted and below 1GHz Radiation testing:



Operation of EUT during Above1GHz Radiation testing:

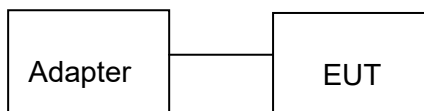

2.3 MEASUREMENT INSTRUMENTS LIST

Item	Equipment	Manufacturer	Model No.	Serial No.	Last Cal.	Cal. Interval
1.	EMI Receiver	Rohde & Schwarz	ESCI	100627	Feb. 19, 2017	1 Year
2.	LISN	SchwarzBeck	NSLK 8126	8126377	Feb. 19, 2017	1 Year
3.	RF Switching Unit	Compliance Direction	RSU-M2	38303	Feb. 19, 2017	1 Year
4.	EMI Test Software ES-K1	Rohde & Schwarz	N/A	N/A	N/A	N/A
5.	EMI Test Receiver	Rohde & Schwarz	ESCI	100627	Feb. 19, 2017	1 Year
6.	Trilog Broadband Antenna	Schwarzbeck	VULB9163	VULB 9163-289	Feb. 19, 2017	1 Year
7.	Pre-amplifier	Compliance Direction	PAP-0203	22008	Feb. 19, 2017	1 Year
8.	EMI Test Software EZ-EMC	SHURPLE	N/A	N/A	N/A	N/A
9.	EMI Receiver	Rohde & Schwarz	ESCI	100627	Feb. 19, 2017	1 Year
10.	LISN	SchwarzBeck	NSLK 8126	8126377	Feb. 19, 2017	1 Year
11.	RF Switching Unit	Compliance Direction	RSU-M2	38303	Feb. 19, 2017	1 Year
12.	EMI Test Software ES-K1	Rohde & Schwarz	N/A	N/A	N/A	N/A
13.	EMI Receiver	Rohde & Schwarz	ESCI	100627	Feb. 19, 2017	1 Year
14.	EMI Receiver	Rohde & Schwarz	ESCI	100627	Feb. 19, 2017	1 Year
15.	LISN	SchwarzBeck	NSLK 8126	8126377	Feb. 19, 2017	1 Year
16.	RF Switching Unit	Compliance Direction	RSU-M2	38303	Feb. 19, 2017	1 Year
17.	EMI Test Software ES-K1	Rohde & Schwarz	N/A	N/A	N/A	N/A
18.	Power Meter	R&S	NRVD	SEL0069	Feb. 19, 2017	1 Year
19.	Power Sensor	R&S	URV5-Z2	SEL0071	Feb. 19, 2017	1 Year
20.	Power Sensor	R&S	URV5-Z2	SEL0072	Feb. 19, 2017	1 Year
21.	Software EMC32	R&S	EMC32-S	SEL0082	N/A	N/A
22.	Log-periodic Antenna	Amplifier Reasearch	APT1.580	SEL0073	N/A	N/A
23.	Antenna Tripod	Amplifier Reasearch	TP1000A	SEL0074	N/A	N/A
24.	High Gain Horn Antenna(0.8-5GHz)	Amplifier Reasearch	AT4002A	SEL0075	N/A	N/A
25.	Spectrum analyzer	Agilent	N9020A	MY499110 048	Feb. 19, 2017	1 Year
26.	Spectrum analyzer	Agilent	E4407B	MY461843 26	Feb. 19, 2017	1 Year

3. CONDUCTED EMISSIONS TEST

3.1 Conducted Power Line Emission Limit

For unintentional device, according to § 15.107(a) Line Conducted Emission Limits is as following

Frequency (MHz)	Maximum RF Line Voltage (dBµV)			
	CLASS A		CLASS B	
	Q.P.	Ave.	Q.P.	Ave.
0.15 - 0.50	79	66	66-56*	56-46*
0.50 - 5.00	73	60	56	46
5.00 - 30.0	73	60	60	50

* Decreasing linearly with the logarithm of the frequency

For intentional device, according to §15.207(a) Line Conducted Emission Limit is same as above table.

3.2 Test Setup

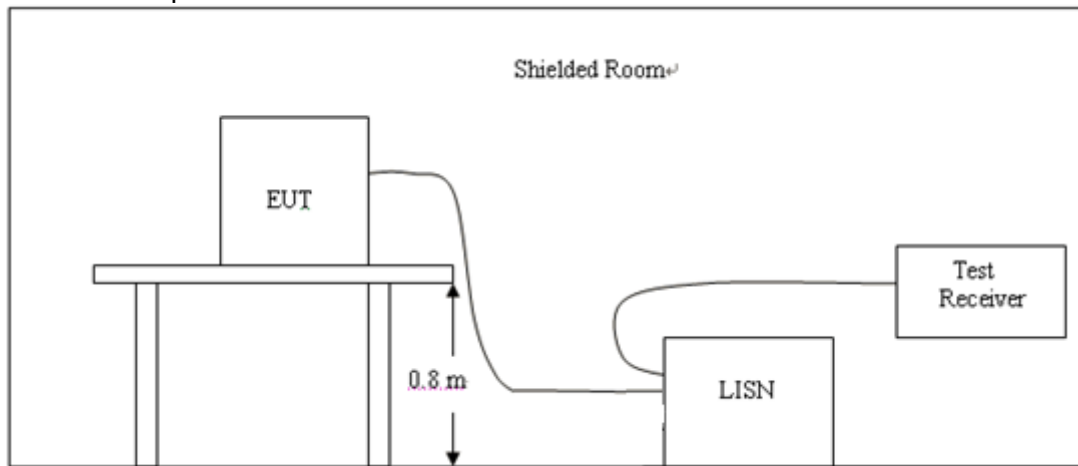

3.3 Test Procedure

- 1, The equipment was set up as per the test configuration to simulate typical actual usage per the user's manual. The EUT is a tabletop system, a wooden table with a height of 0.8 meters is used and is placed on the ground plane as per ANSI C63.10.
- 2, Support equipment, if needed, was placed as per ANSI C63.10.
- 3, All I/O cables were positioned to simulate typical actual usage as per ANSI C63.10.
- 4, If a EUT received DC power from the USB Port of Notebook PC, the PC's adapter received AC120V/60Hz power through a Line Impedance Stabilization Network (LISN) which supplied power source and was grounded to the ground plane.
- 5, All support equipments received AC power from a second LISN, if any.
- 6, The EUT test program was started. Emissions were measured on each current carrying line of the EUT using a spectrum Analyzer / Receiver connected to the LISN powering the EUT. The LISN has two monitoring points: Line 1 (Hot Side) and Line 2 (Neutral Side). Two scans were taken: one with Line 1 connected to Analyzer / Receiver and Line 2 connected to a 50 ohm load; the second scan had Line 1 connected to a 50 ohm load and Line 2 connected to the Analyzer / Receiver.
- 7, Analyzer / Receiver scanned from 150 KHz to 30MHz for emissions in each of the test modes.

3.4 Test Result

PASS

All the test modes completed for test.

Line

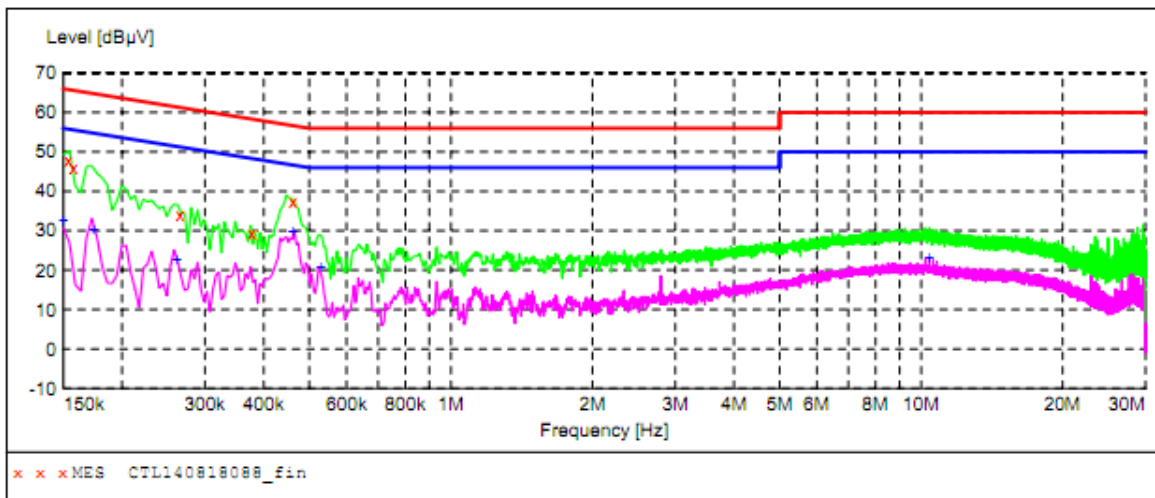

Frequency MHz	Level dBµV	Transd dB	Limit dBµV	Margin dB	Detector	Line	PE
0.154000	47.70	10.2	66	18.1	QP	L1	GND
0.158000	45.70	10.2	66	19.9	QP	L1	GND
0.266000	34.00	10.2	61	27.2	QP	L1	GND
0.378000	29.40	10.2	58	28.9	QP	L1	GND
0.462000	37.50	10.2	57	19.2	QP	L1	GND
Frequency MHz	Level dBµV	Transd dB	Limit dBµV	Margin dB	Detector	Line	PE
0.150000	32.50	10.2	56	23.5	AV	L1	GND
0.174000	30.30	10.2	55	24.5	AV	L1	GND
0.262000	22.70	10.2	51	28.7	AV	L1	GND
0.462000	29.90	10.2	47	16.8	AV	L1	GND
0.530000	20.70	10.2	46	25.3	AV	L1	GND
10.400000	23.00	10.6	50	27.0	AV	L1	GND

Neutral

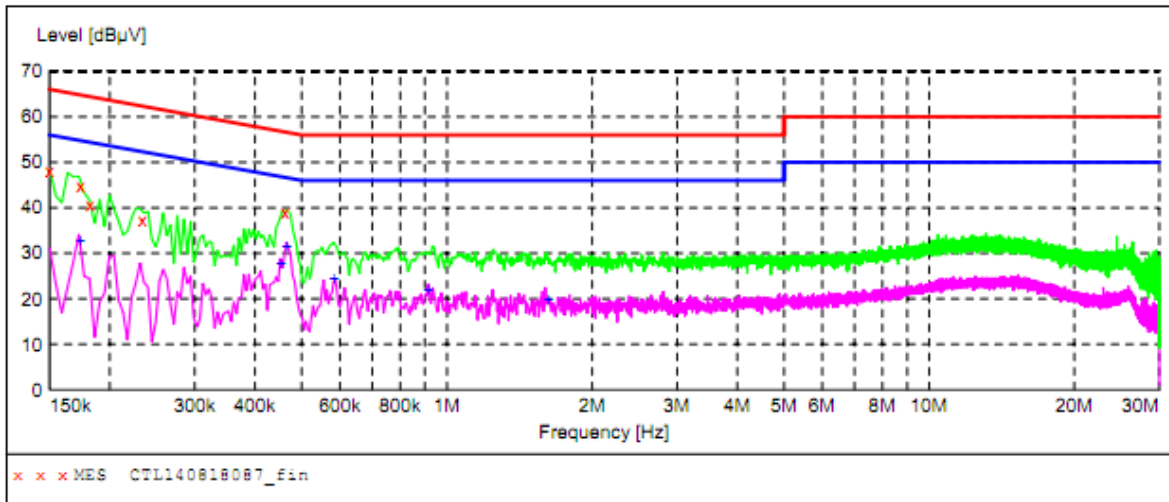

Frequency MHz	Level dBuV	Transd dB	Limit dBuV	Margin dB	Detector	Line	PE
0.150000	48.10	10.2	66	17.9	QP	N	GND
0.174000	44.80	10.2	65	20.0	QP	N	GND
0.182000	40.50	10.2	64	23.9	QP	N	GND
0.234000	37.10	10.2	62	25.2	QP	N	GND
0.462000	38.80	10.2	57	17.9	QP	N	GND

Frequency MHz	Level dBuV	Transd dB	Limit dBuV	Margin dB	Detector	Line	PE
0.174000	32.60	10.2	55	22.2	AV	N	GND
0.454000	27.60	10.2	47	19.2	AV	N	GND
0.466000	31.30	10.2	47	15.3	AV	N	GND
0.584000	24.20	10.2	46	21.8	AV	N	GND
0.914000	21.90	10.3	46	24.1	AV	N	GND
1.622000	19.70	10.3	46	26.3	AV	N	GND

4 RADIATED EMISSION TEST

4.1 Radiation Limit

For unintentional device, according to § 15.109(a), except for Class A digital devices, the field strength of radiated emissions from unintentional radiators at a distance of 3 meters shall not exceed the following values:

Frequency (MHz)	Distance (Meters)	Radiated (dB μ V/m)	Radiated (μ V/m)
30-88	3	40	100
88-216	3	43.5	150
216-960	3	46	200
Above 960	3	54	500

For intentional device, according to § 15.209(a), the general requirement of field strength of radiated emissions from intentional radiators at a distance of 3 meters shall not exceed the above table.

4.2 Test Setup

(1) Radiated Emission Test-Up Frequency Below 30MHz

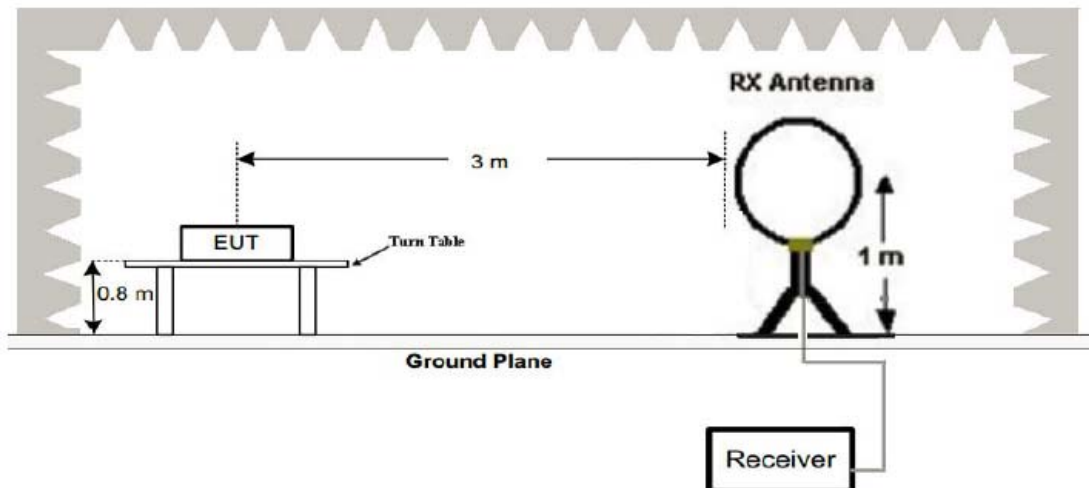

(2) Radiated Emission Test-Up Frequency 30MHz~1GHz

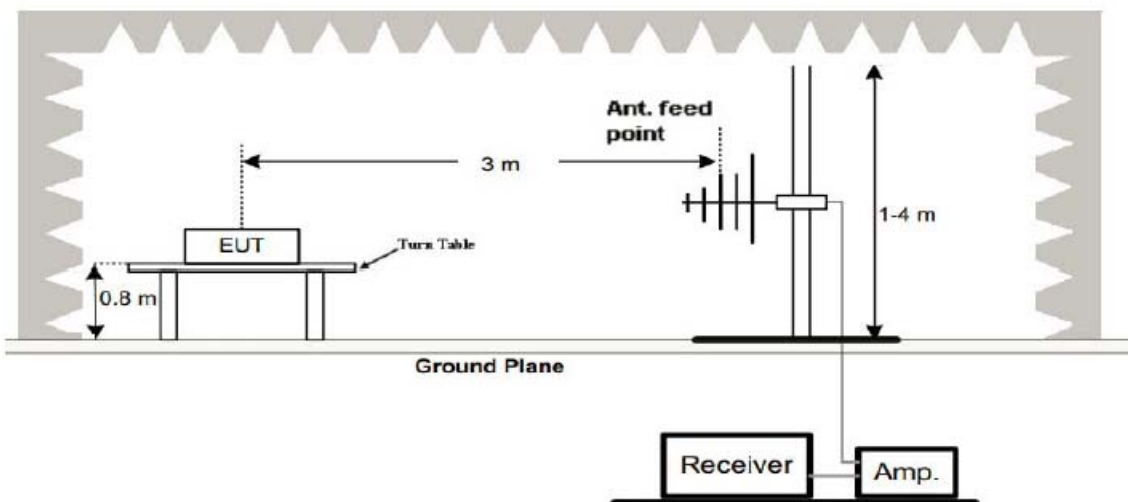

(3) Radiated Emission Test-Up Frequency Above 1GHz

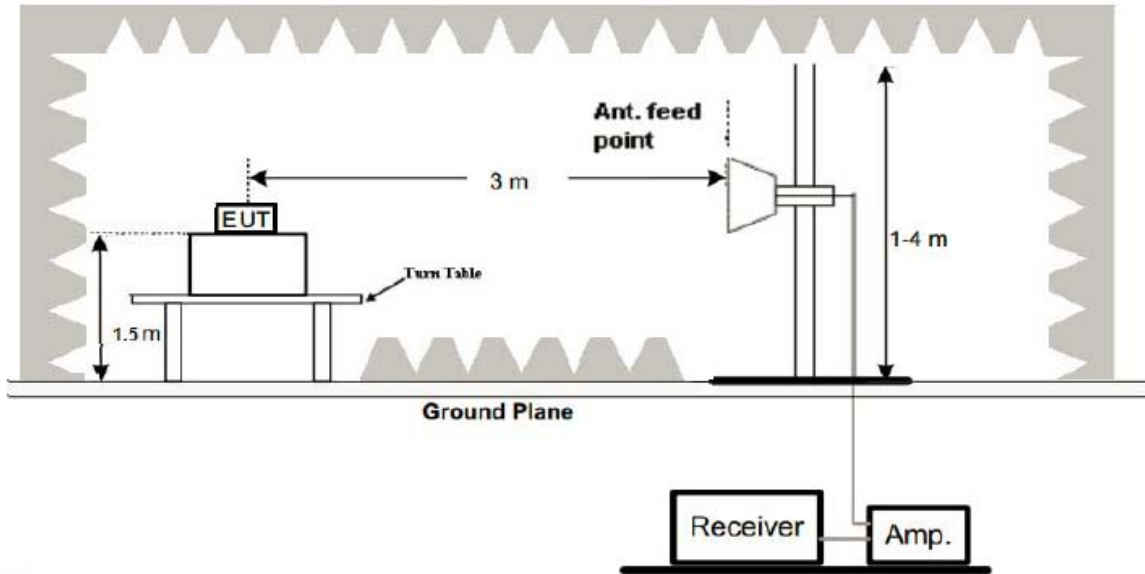

4.3 Test Procedure

1. Below 1GHz measurement the EUT is placed on turntable which is 0.8m above ground plane. And above 1GHz measurement EUT was placed on low permittivity and low tangent turn table which is 1.5m above ground plane.
2. The turntable shall be rotated for 360 degrees to determine the position of maximum emission level.
3. EUT is set 3m away from the receiving antenna, which is varied from 1m to 4m to find out the highest emissions.
4. Maximum procedure was performed on the six highest emissions to ensure EUT compliance.
5. And also, each emission was to be maximized by changing the polarization of receiving antenna both horizontal and vertical.
6. Repeat above procedures until the measurements for all frequencies are complete.
7. The test frequency range from 9KHz to 25GHz per FCC PART 15.33(a).

Note:

For battery operated equipment, the equipment tests shall be performed using a new battery.

4.4 Test Result

PASS

All the test modes completed for test. The worst case of Radiated Emission; the test data of this mode was reported.

Below 1GHz Test Results:
Antenna polarity: H

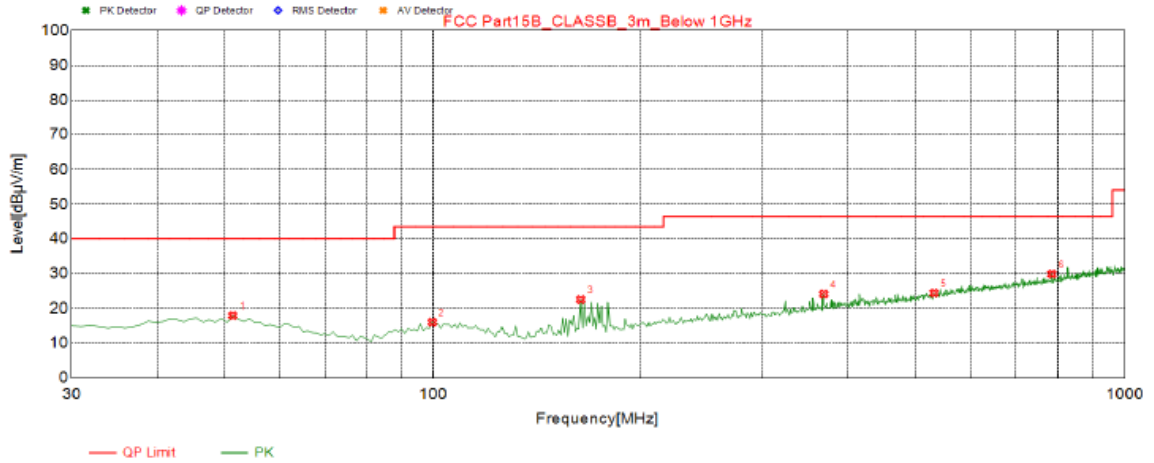

Suspected List								
NO.	Freq. [MHz]	Result Level [dBµV]	Factor [dB]	Limit [dBµV/m]	Margin [dB]	Height [cm]	Angle [°]	Polarity
1	51.340	17.99	-14.38	40.00	22.01	300	316	Horizontal
2	99.840	16.06	-16.01	43.50	27.44	300	203	Horizontal
3	163.86	22.45	-18.45	43.50	21.05	300	51	Horizontal
4	368.53	24.06	-10.92	46.50	22.44	100	237	Horizontal
5	532.46	24.35	-7.26	46.50	22.15	100	70	Horizontal
6	784.66	29.92	-3.12	46.50	16.58	300	302	Horizontal

Antenna polarity: V

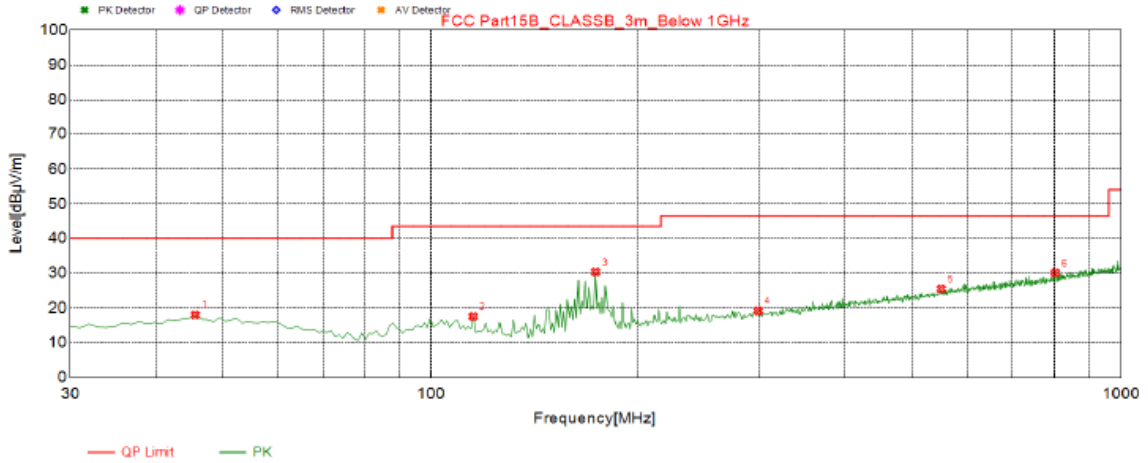

Suspected List								
NO.	Freq. [MHz]	Result Level [dBµV]	Factor [dB]	Limit [dBµV/m]	Margin [dB]	Height [cm]	Angle [°]	Polarity
1	45.520	18.05	-13.94	40.00	21.95	100	100	Vertical
2	115.36	17.6	-16.88	43.50	25.90	100	163	Vertical
3	173.56	30.4	-17.85	43.50	13.10	100	355	Vertical
4	298.69	19.27	-12.84	46.50	27.23	200	166	Vertical
5	550.89	25.44	-6.81	46.50	21.06	100	229	Vertical
6	803.09	30.14	-2.84	46.50	16.36	100	303	Vertical

Remark:

- (1) Measuring frequencies from 9 KHz to the 1 GHz, Radiated emission test from 9KHz to 30MHz was verified, and no any emission was found except system noise floor.
- (2) * denotes emission frequency which appearing within the Restricted Bands specified in provision of 15.205, then the general radiated emission limits in 15.209 apply.
- (3) The IF bandwidth of EMI Test Receiver between 30MHz to 1GHz was 120KHz, 1 MHz for measuring above 1 GHz, below 30MHz was 10KHz.

Above 1 GHz Test Results:

LOW CH1 (802.11b Mode)/2412

Horizontal:

Frequency	Meter Reading	Factor	Emission Level	Limits	Margin	Detector Type
(MHz)	(dBµV)	(dB)	(dBµV/m)	(dBµV/m)	(dB)	
4824	61.12	-3.64	57.48	74	-16.52	peak
4824	46.27	-3.64	42.63	54	-11.37	AVG
7236	53.16	-0.95	52.21	74	-21.79	peak
7236	43.37	-0.95	42.42	54	-11.58	AVG
---	---	---	---	---	---	---
---	---	---	---	---	---	---

Remark: Factor = Antenna Factor + Cable Loss – Pre-amplifier.

Vertical:

Frequency	Meter Reading	Factor	Emission Level	Limits	Margin	Detector Type
(MHz)	(dBµV)	(dB)	(dBµV/m)	(dBµV/m)	(dB)	
4824	61.07	-3.64	57.43	74	-16.57	peak
4824	44.26	-3.64	40.62	54	-13.38	AVG
7236	54.27	-0.95	53.32	74	-20.68	peak
7236	41.35	-0.95	40.4	54	-13.6	AVG
---	---	---	---	---	---	---
---	---	---	---	---	---	---

Remark: Factor = Antenna Factor + Cable Loss – Pre-amplifier.

MID CH6 (802.11b Mode)/2437

Horizontal:

Frequency	Meter Reading	Factor	Emission Level	Limits	Margin	Detector Type
(MHz)	(dBµV)	(dB)	(dBµV/m)	(dBµV/m)	(dB)	
4874	62.27	-3.51	58.76	74	-15.24	peak
4874	47.41	-3.51	43.9	54	-10.1	AVG
7311	56.96	-0.82	56.14	74	-17.86	peak
7311	43.25	-0.82	42.43	54	-11.57	AVG
---	---	---	---	---	---	---
---	---	---	---	---	---	---

Remark: Factor = Antenna Factor + Cable Loss – Pre-amplifier.

Vertical:

Frequency	Meter Reading	Factor	Emission Level	Limits	Margin	Detector Type
(MHz)	(dBµV)	(dB)	(dBµV/m)	(dBµV/m)	(dB)	
4874	60.08	-3.51	56.57	74	-17.43	peak
4874	45.22	-3.51	41.71	54	-12.29	AVG
7311	57.37	-0.82	56.55	74	-17.45	peak
7311	42.16	-0.82	41.34	54	-12.66	AVG
---	---	---	---	---	---	---
---	---	---	---	---	---	---

Remark: Factor = Antenna Factor + Cable Loss – Pre-amplifier.

HIGH CH11 (802.11b Mode)/2462

Horizontal:

Frequency	Meter Reading	Factor	Emission Level	Limits	Margin	Detector Type
(MHz)	(dBµV)	(dB)	(dBµV/m)	(dBµV/m)	(dB)	
4924	62.17	-3.43	58.74	74	-15.26	peak
4924	45.27	-3.43	41.84	54	-12.16	AVG
7386	56.53	-0.75	55.78	74	-18.22	peak
7386	41.56	-0.75	40.81	54	-13.19	AVG
---	---	---	---	---	---	---
---	---	---	---	---	---	---

Remark: Factor = Antenna Factor + Cable Loss – Pre-amplifier.

Vertical:

Frequency	Meter Reading	Factor	Emission Level	Limits	Margin	Detector Type
(MHz)	(dBµV)	(dB)	(dBµV/m)	(dBµV/m)	(dB)	
4924	60.65	-3.43	57.22	74	-16.78	peak
4924	43.28	-3.43	39.85	54	-14.15	AVG
7386	55.19	-0.75	54.44	74	-19.56	peak
7386	41.07	-0.75	40.32	54	-13.68	AVG
---	---	---	---	---	---	---
---	---	---	---	---	---	---

Remark: Factor = Antenna Factor + Cable Loss – Pre-amplifier.

Remark:

- (1) Measuring frequencies from 1 GHz to the 25 GHz.
- (2) "F" denotes fundamental frequency; "H" denotes spurious frequency. "E" denotes band edge frequency.
- (3) * denotes emission frequency which appearing within the Restricted Bands specified in provision of 15.205, then the general radiated emission limits in 15.209 apply.
- (4) Data of measurement within this frequency range shown "----" in the table above means the reading of emissions are attenuated more than 20dB below the permissible limits or the field strength is too small to be measured.
- (5) The IF bandwidth of EMI Test Receiver between 30MHz to 1GHz was 120KHz, 1 MHz for measuring above 1 GHz, below 30MHz was 10KHz.
- (6) When the test results of Peak Detected below the limits of Average Detected, the Average Detected is not need completed. For example: Top Channel at Fundamental 73.16dBuV/m(PK Value) <93.98(AV Limit), at harmonic 53.20 dBuV/m(PK Value) <54 dBuV/m(AV Limit), the Average Detected not need to completed.

LOW CH1 (802.11g Mode)/2412

Horizontal:

Frequency	Meter Reading	Factor	Emission Level	Limits	Margin	Detector Type
(MHz)	(dBµV)	(dB)	(dBµV/m)	(dBµV/m)	(dB)	
4824	63.17	-3.64	59.53	74	-14.47	peak
4824	43.35	-3.64	39.71	54	-14.29	AVG
7236	53.13	-0.95	52.18	74	-21.82	peak
7236	42.64	-0.95	41.69	54	-12.31	AVG
---	---	---	---	---	---	---
---	---	---	---	---	---	---

Remark: Factor = Antenna Factor + Cable Loss – Pre-amplifier.

Vertical:

Frequency	Meter Reading	Factor	Emission Level	Limits	Margin	Detector Type
(MHz)	(dBµV)	(dB)	(dBµV/m)	(dBµV/m)	(dB)	
4824	62.16	-3.64	58.52	74	-15.48	peak
4824	45.39	-3.64	41.75	54	-12.25	AVG
7236	57.17	-0.95	56.22	74	-17.78	peak
7236	42.75	-0.95	41.8	54	-12.2	AVG
---	---	---	---	---	---	---
---	---	---	---	---	---	---

Remark: Factor = Antenna Factor + Cable Loss – Pre-amplifier.

MID CH6 (802.11g Mode)/2437

Horizontal:

Frequency	Meter Reading	Factor	Emission Level	Limits	Margin	Detector Type
(MHz)	(dBµV)	(dB)	(dBµV/m)	(dBµV/m)	(dB)	
4874	61.27	-3.51	57.76	74	-16.24	peak
4874	44.45	-3.51	40.94	54	-13.06	AVG
7311	56.32	-0.82	55.5	74	-18.5	peak
7311	42.28	-0.82	41.46	54	-12.54	AVG
---	---	---	---	---	---	---
---	---	---	---	---	---	---

Remark: Factor = Antenna Factor + Cable Loss – Pre-amplifier.

Vertical:

Frequency	Meter Reading	Factor	Emission Level	Limits	Margin	Detector Type
(MHz)	(dBµV)	(dB)	(dBµV/m)	(dBµV/m)	(dB)	
4874	60.37	-3.51	56.86	74	-17.14	peak
4874	44.21	-3.51	40.7	54	-13.3	AVG
7311	56.74	-0.82	55.92	74	-18.08	peak
7311	41.21	-0.82	40.39	54	-13.61	AVG
---	---	---	---	---	---	---
---	---	---	---	---	---	---

Remark: Factor = Antenna Factor + Cable Loss – Pre-amplifier.

HIGH CH11 (802.11g Mode)/2462

Horizontal:

Frequency	Meter Reading	Factor	Emission Level	Limits	Margin	Detector Type
(MHz)	(dBµV)	(dB)	(dBµV/m)	(dBµV/m)	(dB)	
4924	62.16	-3.43	58.73	74	-15.27	peak
4924	43.28	-3.43	39.85	54	-14.15	AVG
7386	55.97	-0.75	55.22	74	-18.78	peak
7386	42.13	-0.75	41.38	54	-12.62	AVG
---	---	---	---	---	---	---
---	---	---	---	---	---	---

Remark: Factor = Antenna Factor + Cable Loss – Pre-amplifier.

Vertical:

Frequency	Meter Reading	Factor	Emission Level	Limits	Margin	Detector Type
(MHz)	(dBµV)	(dB)	(dBµV/m)	(dBµV/m)	(dB)	
4924	61.28	-3.43	57.85	74	-16.15	peak
4924	46.32	-3.43	42.89	54	-11.11	AVG
7386	56.46	-0.75	55.71	74	-18.29	peak
7386	42.19	-0.75	41.44	54	-12.56	AVG
---	---	---	---	---	---	---
---	---	---	---	---	---	---

Remark: Factor = Antenna Factor + Cable Loss – Pre-amplifier.

Remark:

- (1) Measuring frequencies from 1 GHz to the 25 GHz.
- (2) "F" denotes fundamental frequency; "H" denotes spurious frequency. "E" denotes band edge frequency.
- (3) * denotes emission frequency which appearing within the Restricted Bands specified in provision of 15.205, then the general radiated emission limits in 15.209 apply.
- (4) Data of measurement within this frequency range shown "----" in the table above means the reading of emissions are attenuated more than 20dB below the permissible limits or the field strength is too small to be measured.
- (5) The IF bandwidth of EMI Test Receiver between 30MHz to 1GHz was 120KHz, 1 MHz for measuring above 1 GHz, below 30MHz was 10KHz.
- (6) When the test results of Peak Detected below the limits of Average Detected, the Average Detected is not need completed. For example: Top Channel at Fundamental 73.16dBuV/m(PK Value) <93.98(AV Limit), at harmonic 53.20 dBuV/m(PK Value) <54 dBuV/m(AV Limit), the Average Detected not need to completed.

LOW CH1 (802.11n/H20 Mode)/2412

Horizontal:

Frequency	Meter Reading	Factor	Emission Level	Limits	Margin	Detector Type
(MHz)	(dBμV)	(dB)	(dBμV/m)	(dBμV/m)	(dB)	
4824	61.29	-3.64	57.65	74	-16.35	peak
4824	46.21	-3.64	42.57	54	-11.43	AVG
7236	54.17	-0.95	53.22	74	-20.78	peak
7236	41.23	-0.95	40.28	54	-13.72	AVG
---	---	---	---	---	---	---
---	---	---	---	---	---	---

Remark: Factor = Antenna Factor + Cable Loss – Pre-amplifier.

Vertical:

Frequency	Meter Reading	Factor	Emission Level	Limits	Margin	Detector Type
(MHz)	(dBμV)	(dB)	(dBμV/m)	(dBμV/m)	(dB)	
4824	60.21	-3.64	56.57	74	-17.43	peak
4824	45.87	-3.64	42.23	54	-11.77	AVG
7236	55.16	-0.95	54.21	74	-19.79	peak
7236	41.32	-0.95	40.37	54	-13.63	AVG
---	---	---	---	---	---	---
---	---	---	---	---	---	---

Remark: Factor = Antenna Factor + Cable Loss – Pre-amplifier.

MID CH6 (802.11n/H20 Mode)/2437

Horizontal:

Frequency (MHz)	Meter Reading (dBµV)	Factor (dB)	Emission Level (dBµV/m)	Limits (dBµV/m)	Margin (dB)	Detector Type
4874	61.63	-3.51	58.12	74	-15.88	peak
4874	45.25	-3.51	41.74	54	-12.26	AVG
7311	56.42	-0.82	55.6	74	-18.4	peak
7311	42.17	-0.82	41.35	54	-12.65	AVG
---	---	---	---	---	---	---
---	---	---	---	---	---	---

Remark: Factor = Antenna Factor + Cable Loss – Pre-amplifier.

Vertical:

Frequency (MHz)	Meter Reading (dBµV)	Factor (dB)	Emission Level (dBµV/m)	Limits (dBµV/m)	Margin (dB)	Detector Type
4874	61.03	-3.51	57.52	74	-16.48	peak
4874	46.42	-3.51	42.91	54	-11.09	AVG
7311	54.34	-0.82	53.52	74	-20.48	peak
7311	42.25	-0.82	41.43	54	-12.57	AVG
---	---	---	---	---	---	---
---	---	---	---	---	---	---

Remark: Factor = Antenna Factor + Cable Loss – Pre-amplifier.

HIGH CH11 (802.11n/H20 Mode)/2462

Horizontal:

Frequency	Meter Reading	Factor	Emission Level	Limits	Margin	Detector Type
(MHz)	(dBμV)	(dB)	(dBμV/m)	(dBμV/m)	(dB)	
4924	60.59	-3.43	57.16	74	-16.84	peak
4924	44.37	-3.43	40.94	54	-13.06	AVG
7386	56.26	-0.75	55.51	74	-18.49	peak
7386	41.15	-0.75	40.4	54	-13.6	AVG
---	---	---	---	---	---	---
---	---	---	---	---	---	---

Remark: Factor = Antenna Factor + Cable Loss – Pre-amplifier.

Vertical:

Frequency	Meter Reading	Factor	Emission Level	Limits	Margin	Detector Type
(MHz)	(dBμV)	(dB)	(dBμV/m)	(dBμV/m)	(dB)	
4924	60.39	-3.43	56.96	74	-17.04	peak
4924	45.76	-3.43	42.33	54	-11.67	AVG
7386	56.64	-0.75	55.89	74	-18.11	peak
7386	40.85	-0.75	40.1	54	-13.9	AVG
---	---	---	---	---	---	---
---	---	---	---	---	---	---

Remark: Factor = Antenna Factor + Cable Loss – Pre-amplifier.

Remark:

- (1) Measuring frequencies from 1 GHz to the 25 GHz.
- (2) "F" denotes fundamental frequency; "H" denotes spurious frequency. "E" denotes band edge frequency.
- (3) * denotes emission frequency which appearing within the Restricted Bands specified in provision of 15.205, then the general radiated emission limits in 15.209 apply.
- (4) Data of measurement within this frequency range shown "----" in the table above means the reading of emissions are attenuated more than 20dB below the permissible limits or the field strength is too small to be measured.
- (5) The IF bandwidth of EMI Test Receiver between 30MHz to 1GHz was 120KHz, 1 MHz for measuring above 1 GHz, below 30MHz was 10KHz.
- (6) When the test results of Peak Detected below the limits of Average Detected, the Average Detected is not need completed. For example: Top Channel at Fundamental 73.16dBuV/m(PK Value) <93.98(AV Limit), at harmonic 53.20 dBuV/m(PK Value) <54 dBuV/m(AV Limit), the Average Detected not need to completed.

LOW CH3 (802.11n/H40 Mode)/2422
Horizontal:

Frequency	Meter Reading	Factor	Emission Level	Limits	Margin	Detector Type
(MHz)	(dBμV)	(dB)	(dBμV/m)	(dBμV/m)	(dB)	
4924	63.21	-3.63	59.58	74	-14.42	peak
4924	46.23	-3.63	42.6	54	-11.4	AVG
7386	54.17	-0.94	53.23	74	-20.77	peak
7386	41.42	-0.94	40.48	54	-13.52	AVG
---	---	---	---	---	---	---
---	---	---	---	---	---	---

Remark: Factor = Antenna Factor + Cable Loss – Pre-amplifier.

Vertical:

Frequency	Meter Reading	Factor	Emission Level	Limits	Margin	Detector Type
(MHz)	(dBμV)	(dB)	(dBμV/m)	(dBμV/m)	(dB)	
4924	60.65	-3.63	57.02	74	-16.98	peak
4924	43.45	-3.63	39.82	54	-14.18	AVG
7386	56.38	-0.94	55.44	74	-18.56	peak
7386	40.24	-0.94	39.3	54	-14.7	AVG
---	---	---	---	---	---	---
---	---	---	---	---	---	---

Remark: Factor = Antenna Factor + Cable Loss – Pre-amplifier.

MID CH6 (802.11n/H40 Mode)/2437
Horizontal:

Frequency	Meter Reading	Factor	Emission Level	Limits	Margin	Detector Type
(MHz)	(dBµV)	(dB)	(dBµV/m)	(dBµV/m)	(dB)	
4874	61.31	-3.51	57.8	74	-16.2	peak
4874	45.16	-3.51	41.65	54	-12.35	AVG
7311	54.85	-0.82	54.03	74	-19.97	peak
7311	40.74	-0.82	39.92	54	-14.08	AVG
---	---	---	---	---	---	---
---	---	---	---	---	---	---

Remark: Factor = Antenna Factor + Cable Loss – Pre-amplifier.

Vertical:

Frequency	Meter Reading	Factor	Emission Level	Limits	Margin	Detector Type
(MHz)	(dBµV)	(dB)	(dBµV/m)	(dBµV/m)	(dB)	
4874	60.53	-3.51	57.02	74	-16.98	peak
4874	44.45	-3.51	40.94	54	-13.06	AVG
7311	54.17	-0.82	53.35	74	-20.65	peak
7311	41.25	-0.82	40.43	54	-13.57	AVG
---	---	---	---	---	---	---
---	---	---	---	---	---	---

Remark: Factor = Antenna Factor + Cable Loss – Pre-amplifier.

HIGH CH9 (802.11n/H40 Mode)/2452
Horizontal:

Frequency	Meter Reading	Factor	Emission Level	Limits	Margin	Detector Type
(MHz)	(dBµV)	(dB)	(dBµV/m)	(dBµV/m)	(dB)	
4904	60.28	-3.43	56.85	74	-17.15	peak
4904	44.14	-3.43	40.71	54	-13.29	AVG
7356	56.15	-0.75	55.4	74	-18.6	peak
7356	41.75	-0.75	41	54	-13	AVG
---	---	---	---	---	---	---
---	---	---	---	---	---	---

Remark: Factor = Antenna Factor + Cable Loss – Pre-amplifier.

Vertical:

Frequency	Meter Reading	Factor	Emission Level	Limits	Margin	Detector Type
(MHz)	(dBµV)	(dB)	(dBµV/m)	(dBµV/m)	(dB)	
4904	60.57	-3.43	57.14	74	-16.86	peak
4904	44.53	-3.43	41.1	54	-12.9	AVG
7356	54.29	-0.75	53.54	74	-20.46	peak
7356	40.54	-0.75	39.79	54	-14.21	AVG
---	---	---	---	---	---	---
---	---	---	---	---	---	---

Remark: Factor = Antenna Factor + Cable Loss – Pre-amplifier.

Remark:

- (1) Measuring frequencies from 1 GHz to the 25 GHz.
- (2) "F" denotes fundamental frequency; "H" denotes spurious frequency. "E" denotes band edge frequency.
- (3) * denotes emission frequency which appearing within the Restricted Bands specified in provision of 15.205, then the general radiated emission limits in 15.209 apply.
- (4) Data of measurement within this frequency range shown "----" in the table above means the reading of emissions are attenuated more than 20dB below the permissible limits or the field strength is too small to be measured.
- (5) The IF bandwidth of EMI Test Receiver between 30MHz to 1GHz was 120KHz, 1 MHz for measuring above 1 GHz, below 30MHz was 10KHz.
- (6) When the test results of Peak Detected below the limits of Average Detected, the Average Detected is not need completed. For example: Top Channel at Fundamental 73.16dBuV/m(PK Value) <93.98(AV Limit), at harmonic 53.20 dBuV/m(PK Value) <54 dBuV/m(AV Limit), the Average Detected not need to completed.

5 BAND EDGE

5.1 Limits

Please refer section 15.247

All the lower and upper band-edges emissions appearing within 2310MHz to 2390MHz and 2483.5MHz to 2500MHz restricted frequency bands shall not exceed the limits shown in 15.209, all the other emissions outside operation frequency band 2400MHz to 2483.5MHz shall be at least 20dB below the fundamental emissions, or comply with 15.209 limits.

5.2 Test Procedure

The band edge compliance of RF radiated emission should be measured by following the guidance in ANSI C63.10 with respect to maximizing the emission by rotating the EUT, measuring the emission while the EUT is situated in three orthogonal planes (if appropriate), adjusting the measurement antenna height and polarization etc. Set RBW to 100KHz and VBW to 300KHz to measure the peak field strength and set RBW to 1MHz and VBW to 10Hz to measure the average radiated field strength. The conducted RF band edge was measured by using a spectrum analyzer. Set span wide enough to capture the highest in-band emission and the emission at the band edge. Set RBW to 100 KHz and VBW to 300 KHz, to measure the conducted peak band edge.

5.3 Test Result

PASS

Detailed information please see the following page.

Radiated Band Edge Test:
 Operation Mode: 802.11b Mode TX CH Low (2412MHz)

Horizontal

Frequency	Meter Reading	Factor	Emission Level	Limits	Margin	Detector Type
(MHz)	(dBµV)	(dB)	(dBµV/m)	(dBµV/m)	(dB)	
2390	55.54	-5.81	49.73	74	-24.27	peak
2390	/	-5.81	/	54	/	AVG
2399	62.21	-5.84	56.37	74	-17.63	peak
2399	47.83	-5.84	41.99	54	-12.01	AVG
Remark: Factor = Antenna Factor + Cable Loss – Pre-amplifier.						

Vertical:

Frequency	Meter Reading	Factor	Emission Level	Limits	Margin	Detector Type
(MHz)	(dBµV)	(dB)	(dBµV/m)	(dBµV/m)	(dB)	
2390	53.21	-5.81	47.4	74	-26.6	peak
2390	/	-5.81	/	54	/	AVG
2399	61.32	-5.84	55.48	74	-18.52	peak
2399	46.27	-5.84	40.43	54	-13.57	AVG
Remark: Factor = Antenna Factor + Cable Loss – Pre-amplifier.						



Operation Mode: TX CH High (2462MHz)

Horizontal

Frequency	Meter Reading	Factor	Emission Level	Limits	Margin	Detector Type
(MHz)	(dB μ V)	(dB)	(dB μ V/m)	(dB μ V/m)	(dB)	
2483.5	55.97	-5.65	50.32	74	-23.68	peak
2483.5	/	-5.65	/	54	/	AVG

Remark: Factor = Antenna Factor + Cable Loss – Pre-amplifier.

Vertical:

Frequency	Meter Reading	Factor	Emission Level	Limits	Margin	Detector Type
(MHz)	(dB μ V)	(dB)	(dB μ V/m)	(dB μ V/m)	(dB)	
2483.5	53.23	-5.65	47.58	74	-26.42	peak
2483.5	/	-5.65	/	54	/	AVG

Remark: Factor = Antenna Factor + Cable Loss – Pre-amplifier.

Remark: All the other emissions not reported were too low to read and deemed to comply with FCC limit.

Operation Mode: 802.11g Mode TX CH Low (2412MHz)

Horizontal

Frequency	Meter Reading	Factor	Emission Level	Limits	Margin	Detector Type
(MHz)	(dBμV)	(dB)	(dBμV/m)	(dBμV/m)	(dB)	
2390	54.39	-5.81	48.58	74	-25.42	peak
2390	/	-5.81	/	54	/	AVG
2399	60.57	-5.84	54.73	74	-19.27	peak
2399	45.23	-5.84	39.39	54	-14.61	AVG

Remark: Factor = Antenna Factor + Cable Loss – Pre-amplifier.

Vertical:

Frequency	Meter Reading	Factor	Emission Level	Limits	Margin	Detector Type
(MHz)	(dBμV)	(dB)	(dBμV/m)	(dBμV/m)	(dB)	
2390	53.19	-5.81	47.38	74	-26.62	peak
2390	/	-5.81	/	54	/	AVG
2399	61.64	-5.84	55.8	74	-18.2	peak
2399	46.08	-5.84	40.24	54	-13.76	AVG

Remark: Factor = Antenna Factor + Cable Loss – Pre-amplifier.



Operation Mode: TX CH High (2462MHz)

Horizontal

Frequency	Meter Reading	Factor	Emission Level	Limits	Margin	Detector Type
(MHz)	(dB μ V)	(dB)	(dB μ V/m)	(dB μ V/m)	(dB)	
2483.5	54.28	-5.65	48.63	74	-25.37	peak
2483.5	/	-5.65	/	54	/	AVG

Remark: Factor = Antenna Factor + Cable Loss – Pre-amplifier.

Vertical:

Frequency	Meter Reading	Factor	Emission Level	Limits	Margin	Detector Type
(MHz)	(dB μ V)	(dB)	(dB μ V/m)	(dB μ V/m)	(dB)	
2483.5	53.78	-5.65	48.13	74	-25.87	peak
2483.5	/	-5.65	/	54	/	AVG

Remark: Factor = Antenna Factor + Cable Loss – Pre-amplifier.

Remark: All the other emissions not reported were too low to read and deemed to comply with FCC limit.

Operation Mode: 802.11n/H20 Mode TX CH Low (2412MHz)

Horizontal

Frequency	Meter Reading	Factor	Emission Level	Limits	Margin	Detector Type
(MHz)	(dBμV)	(dB)	(dBμV/m)	(dBμV/m)	(dB)	
2390	54.21	-5.81	48.4	74	-25.6	peak
2390	/	-5.81	/	54	/	AVG
2399	60.35	-5.84	54.51	74	-19.49	peak
2399	45.67	-5.84	39.83	54	-14.17	AVG
Remark: Factor = Antenna Factor + Cable Loss – Pre-amplifier.						

Vertical:

Frequency	Meter Reading	Factor	Emission Level	Limits	Margin	Detector Type
(MHz)	(dBμV)	(dB)	(dBμV/m)	(dBμV/m)	(dB)	
2390	52.17	-5.81	46.36	74	-27.64	peak
2390	/	-5.81	/	54	/	AVG
2399	60.26	-5.84	54.42	74	-19.58	peak
2399	46.72	-5.84	40.88	54	-13.12	AVG
Remark: Factor = Antenna Factor + Cable Loss – Pre-amplifier.						



Operation Mode: TX CH High (2462MHz)

Horizontal

Frequency	Meter Reading	Factor	Emission Level	Limits	Margin	Detector Type
(MHz)	(dB μ V)	(dB)	(dB μ V/m)	(dB μ V/m)	(dB)	
2483.5	54.62	-5.65	48.97	74	-25.03	peak
2483.5	/	-5.65	/	54	/	AVG
Remark: Factor = Antenna Factor + Cable Loss – Pre-amplifier.						

Vertical:

Frequency	Meter Reading	Factor	Emission Level	Limits	Margin	Detector Type
(MHz)	(dB μ V)	(dB)	(dB μ V/m)	(dB μ V/m)	(dB)	
2483.5	53.47	-5.65	47.82	74	-26.18	peak
2483.5	/	-5.65	/	54	/	AVG
Remark: Factor = Antenna Factor + Cable Loss – Pre-amplifier.						
Remark: All the other emissions not reported were too low to read and deemed to comply with FCC limit.						

Operation Mode: 802.11n/H40 Mode TX CH Low (2422MHz)
Horizontal

Frequency	Meter Reading	Factor	Emission Level	Limits	Margin	Detector Type
(MHz)	(dBμV)	(dB)	(dBμV/m)	(dBμV/m)	(dB)	
2390	53.17	-5.81	47.36	74	-26.64	peak
2390	/	-5.81	/	54	/	AVG
2399	61.07	-5.84	55.23	74	-18.77	peak
2399	45.23	-5.84	39.39	54	-14.61	AVG

Remark: Factor = Antenna Factor + Cable Loss – Pre-amplifier.

Vertical:

Frequency	Meter Reading	Factor	Emission Level	Limits	Margin	Detector Type
(MHz)	(dBμV)	(dB)	(dBμV/m)	(dBμV/m)	(dB)	
2390	53.24	-5.81	47.43	74	-26.57	peak
2390	/	-5.81	/	54	/	AVG
2399	60.53	-5.84	54.69	74	-19.31	peak
2399	43.86	-5.84	38.02	54	-15.98	AVG

Remark: Factor = Antenna Factor + Cable Loss – Pre-amplifier.



Operation Mode: TX CH High (2452MHz)
Horizontal

Frequency	Meter Reading	Factor	Emission Level	Limits	Margin	Detector Type
(MHz)	(dB μ V)	(dB)	(dB μ V/m)	(dB μ V/m)	(dB)	
2483.5	53.57	-5.65	47.92	74	-26.08	peak
2483.5	/	-5.65	/	54	/	AVG

Remark: Factor = Antenna Factor + Cable Loss – Pre-amplifier.

Vertical:

Frequency	Meter Reading	Factor	Emission Level	Limits	Margin	Detector Type
(MHz)	(dB μ V)	(dB)	(dB μ V/m)	(dB μ V/m)	(dB)	
2483.5	52.86	-5.65	47.21	74	-26.79	peak
2483.5	/	-5.65	/	54	/	AVG

Remark: Factor = Antenna Factor + Cable Loss – Pre-amplifier.

Remark: All the other emissions not reported were too low to read and deemed to comply with FCC limit.

6 OCCUPIED BANDWIDTH MEASUREMENT

6.1 Test Limit

FCC Part15 (15.247) , Subpart C				
Section	Test Item	Limit	Frequency Range (MHz)	Result
15.247(a)(2)	Bandwidth	$\geq 500\text{KHz}$ (6dB bandwidth)	2400-2483.5	PASS

6.2 Test Procedure

1. The EUT was placed on a turn table which is 0.8m above ground plane.
2. Set EUT as normal operation.
3. Based on FCC Part15 C Section 15.247: RBW= 100KHz. VBW= 300 KHz.
4. The useful radiated emission from the EUT was detected by the spectrum analyser with peak detector.

6.3 Measurement Equipment Used

Same as Radiated Emission Measurement

6.4 Test Result

PASS

All the test modes completed for test.

TX 802.11b Mode			
Frequency	6dB Bandwidth (MHz)	Channel Separation (MHz)	Result
2412 MHz	7.734	>=500KHz	PASS
2437 MHz	7.946	>=500KHz	PASS
2462 MHz	8.906	>=500KHz	PASS

CH: 2412MHz

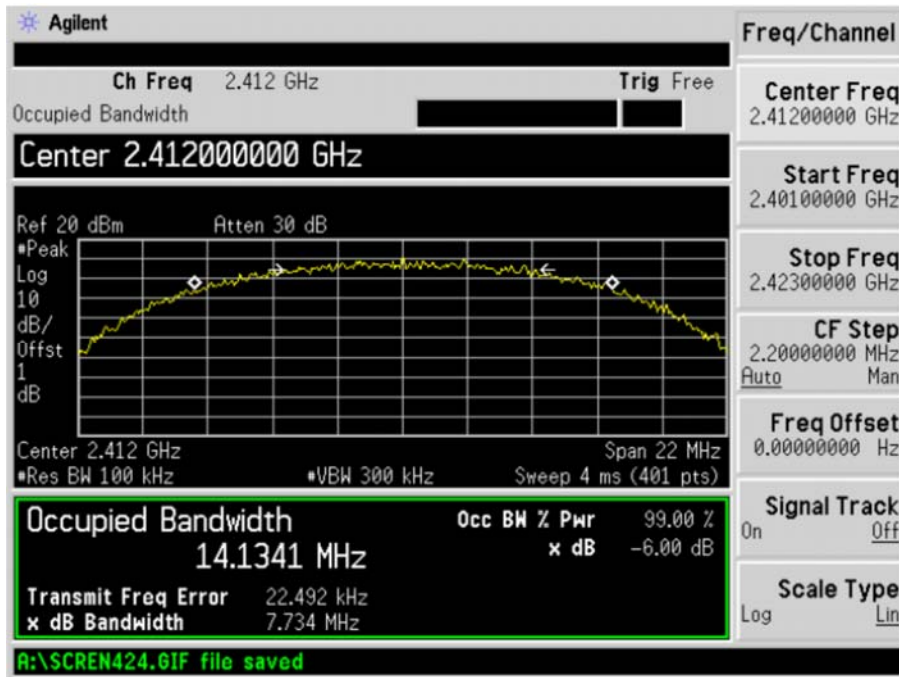

CH: 2437MHz

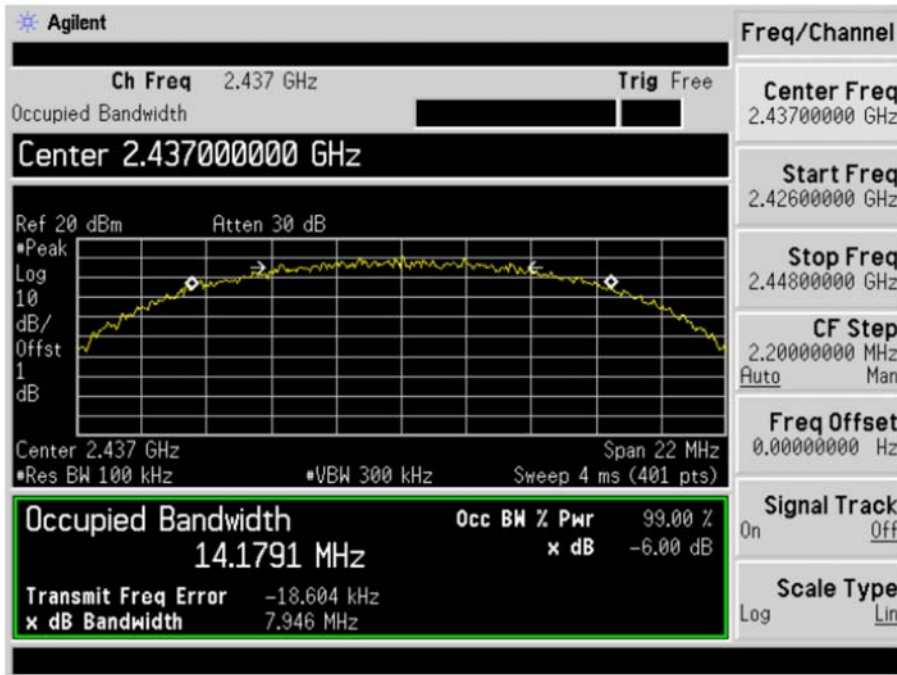

CH: 2462MHz

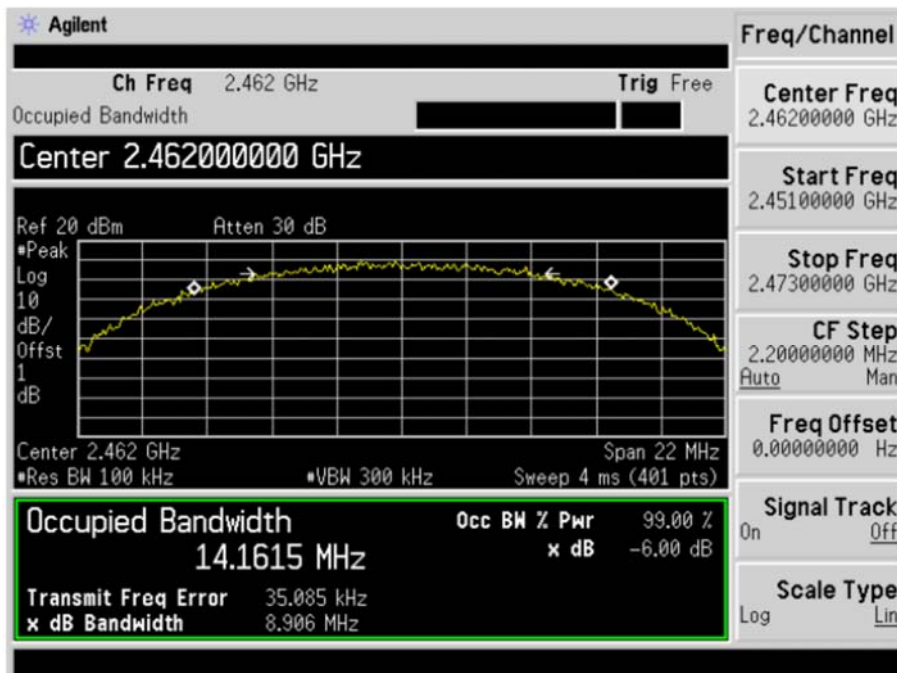

TX 802.11g Mode			
Frequency	6dB Bandwidth (MHz)	Channel Separation (MHz)	Result
2412 MHz	15.178	>=500KHz	PASS
2437 MHz	15.183	>=500KHz	PASS
2462 MHz	15.182	>=500KHz	PASS

CH: 2412MHz

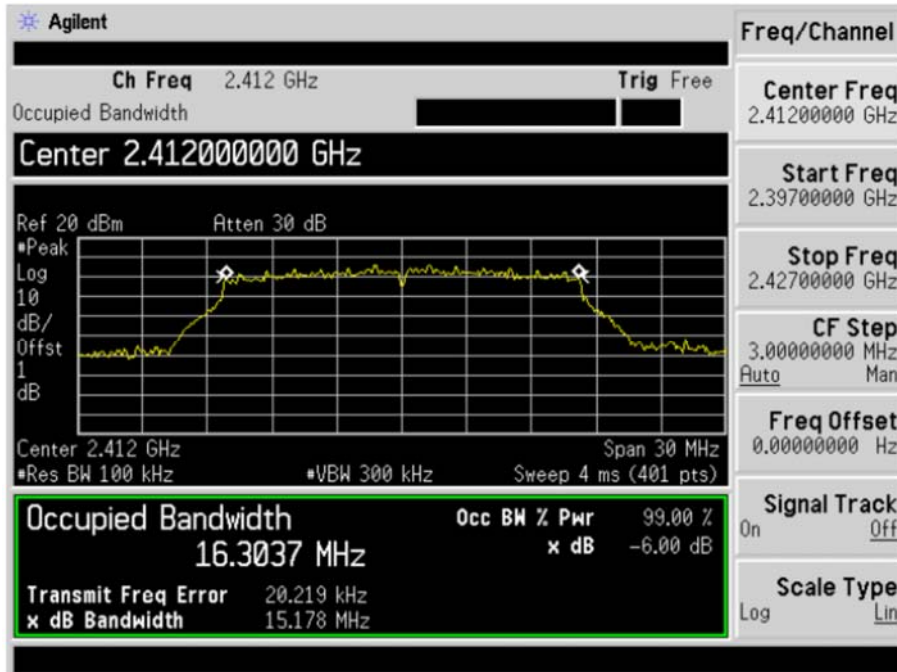

CH: 2437MHz

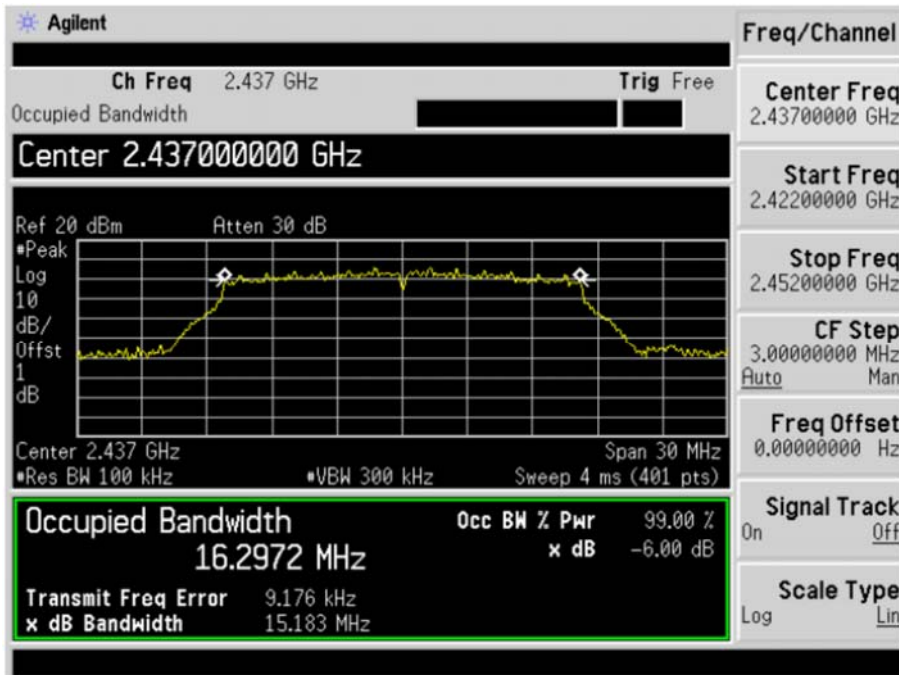

CH: 2462MHz

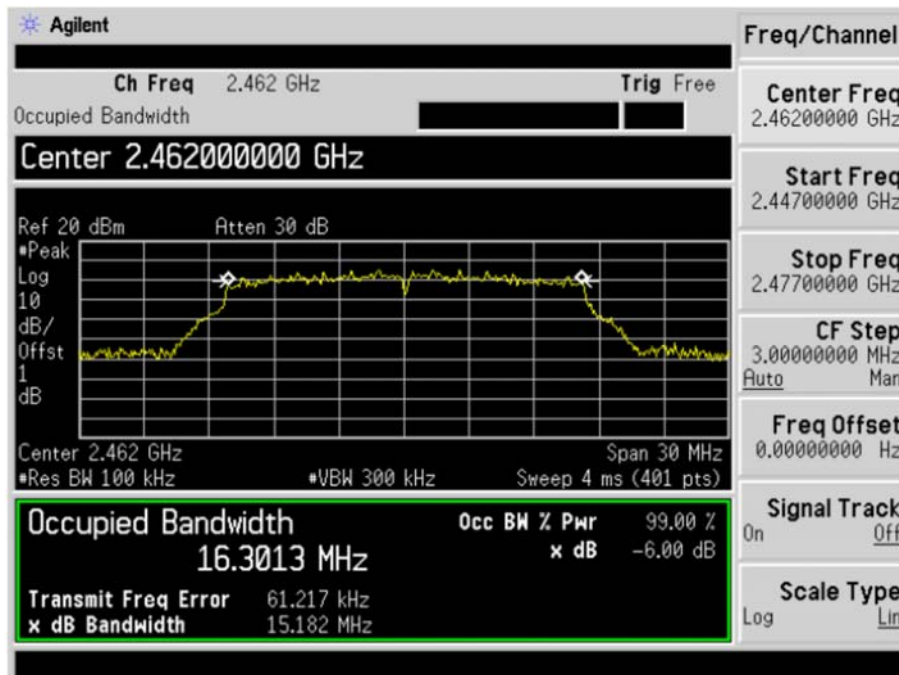

TX 802.11n/HT20 Mode			
Frequency	6dB Bandwidth (MHz)	Channel Separation (MHz)	Result
2412 MHz	16.040	>=500KHz	PASS
2437 MHz	16.590	>=500KHz	PASS
2462 MHz	15.095	>=500KHz	PASS

CH: 2412MHz

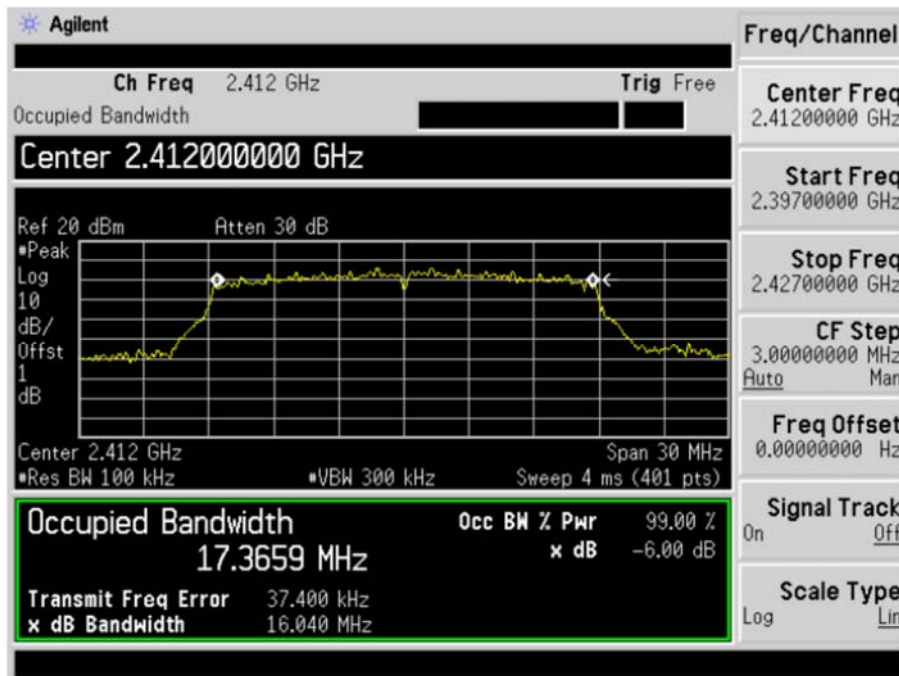

CH: 2437MHz

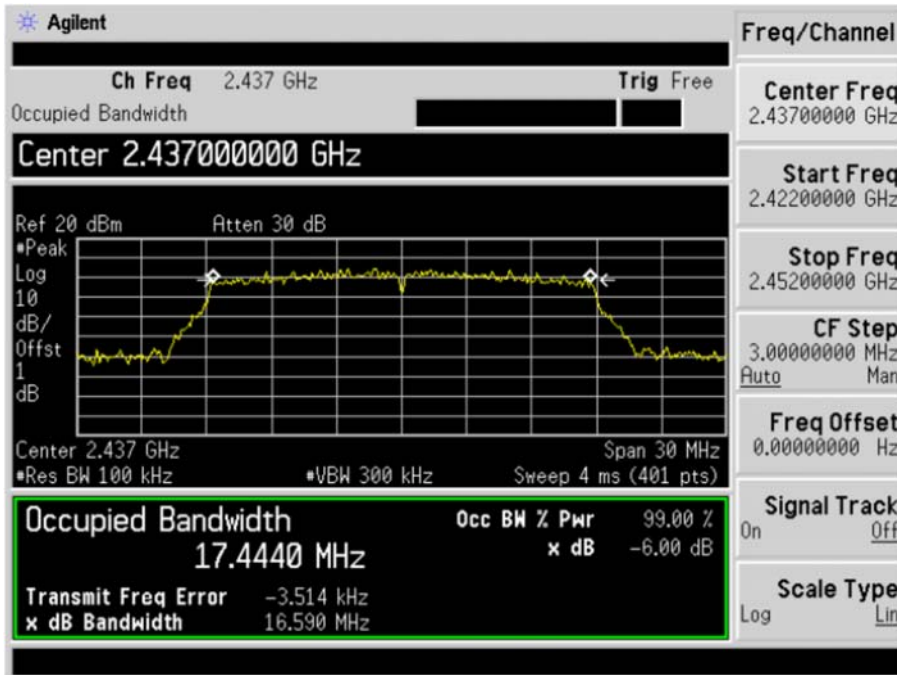

CH: 2462MHz

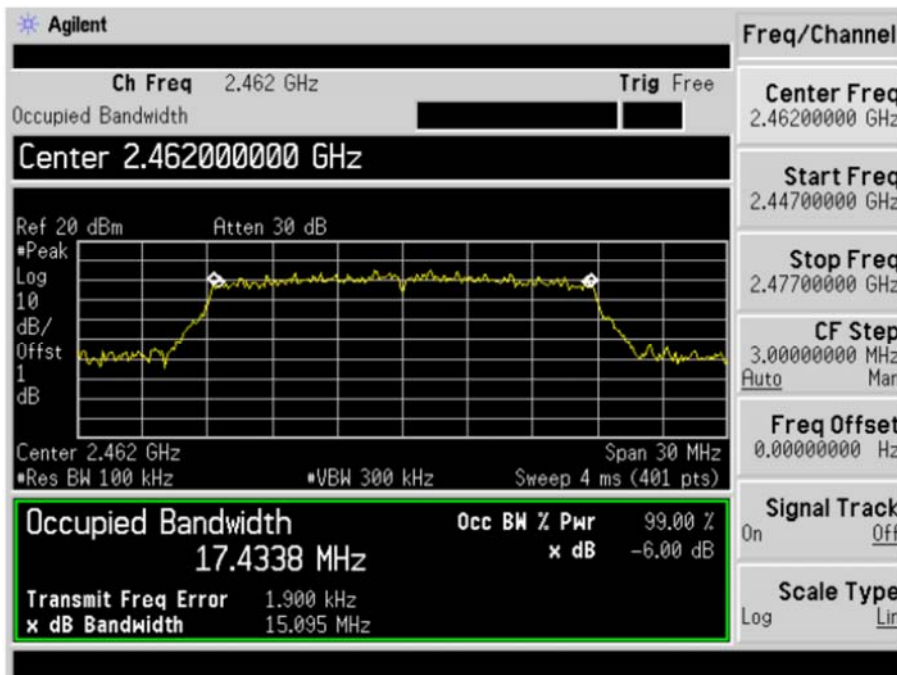

TX 802.11n/HT40 Mode			
Frequency	6dB Bandwidth (MHz)	Channel Separation (MHz)	Result
2422 MHz	35.192	>=500KHz	PASS
2437 MHz	35.175	>=500KHz	PASS
2452 MHz	35.215	>=500KHz	PASS

CH: 2422MHz

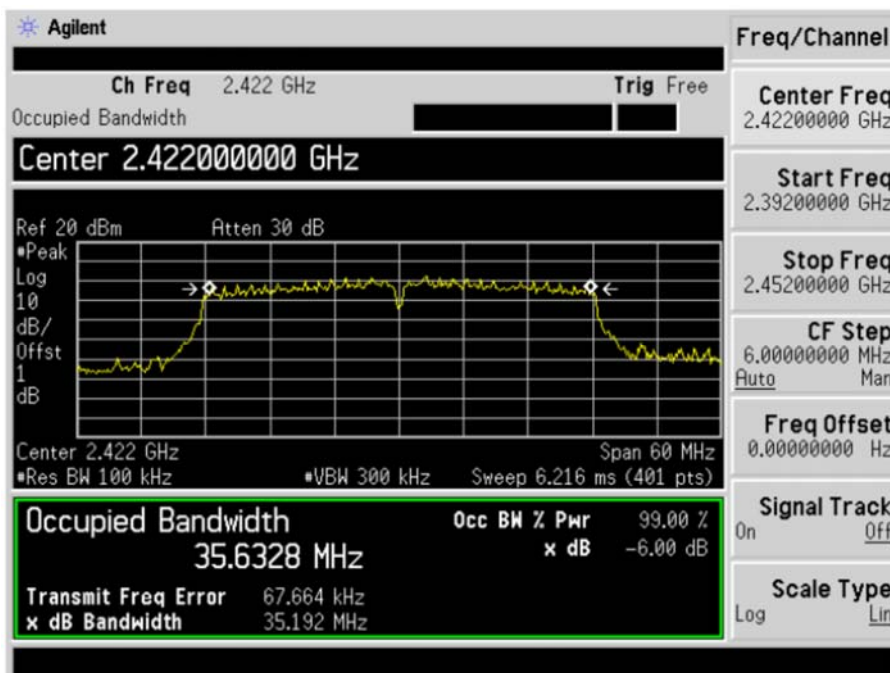

CH: 2437MHz

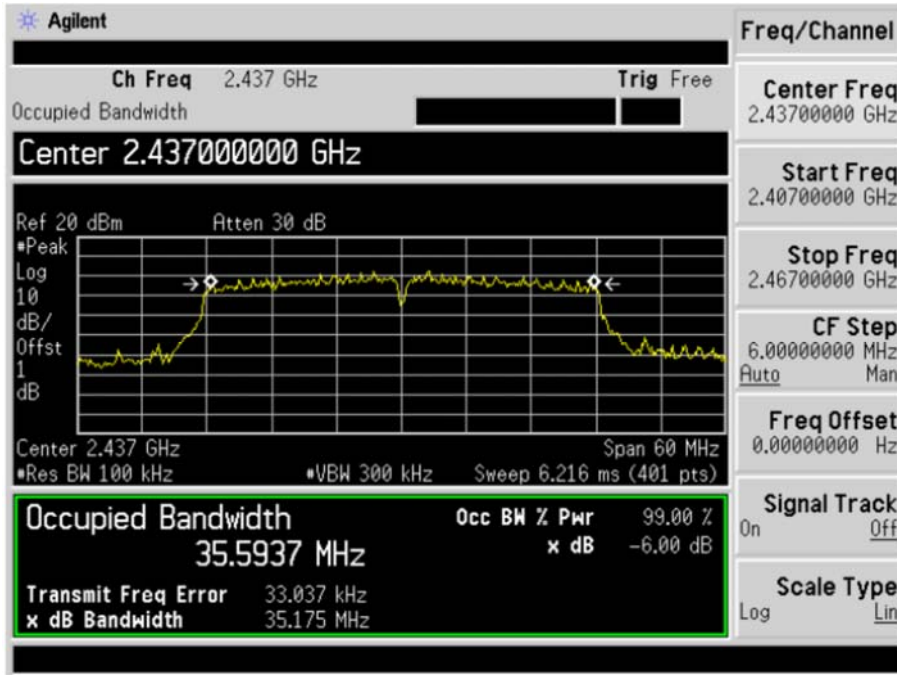

CH: 2452MHz

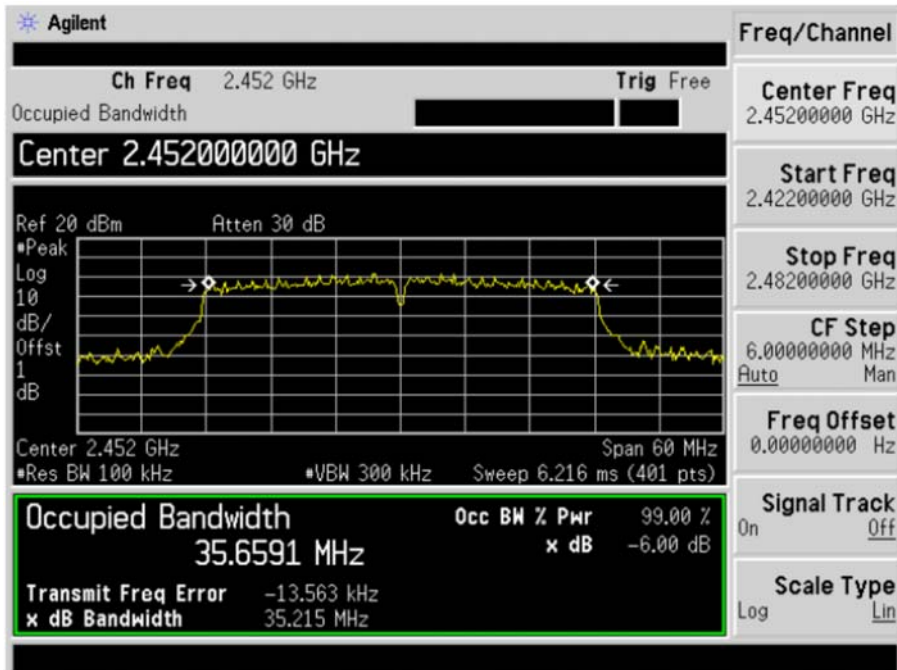

7 POWER SPECTRAL DENSITY TEST

7.1 Test Limit

FCC Part15 (15.247) , Subpart C				
Section	Test Item	Limit	Frequency Range (MHz)	Result
15.247	Power Spectral Density	8 dBm (in any 3KHz)	2400-2483.5	PASS

7.2 Test Procedure

1. The EUT was placed on a turn table which is 0.8m above ground plane.
2. Set EUT as normal operation.
3. Based on FCC Part15 C Section 15.247: RBW= 3KHz. VBW= 10 KHz, Span=3MHz.
4. The useful radiated emission from the EUT was detected by the spectrum analyser with peak detector.

7.3 Measurement Equipment Used

Same as Radiated Emission Measurement

7.4 Test Result

PASS

All the test modes completed for test.

TX 802.11b Mode			
Frequency	Power Density (dBm)	Limit (dBm)	Result
2412 MHz	-6.788	8	PASS
2437 MHz	-7.871	8	PASS
2462 MHz	-8.133	8	PASS

CH: 2412MHz

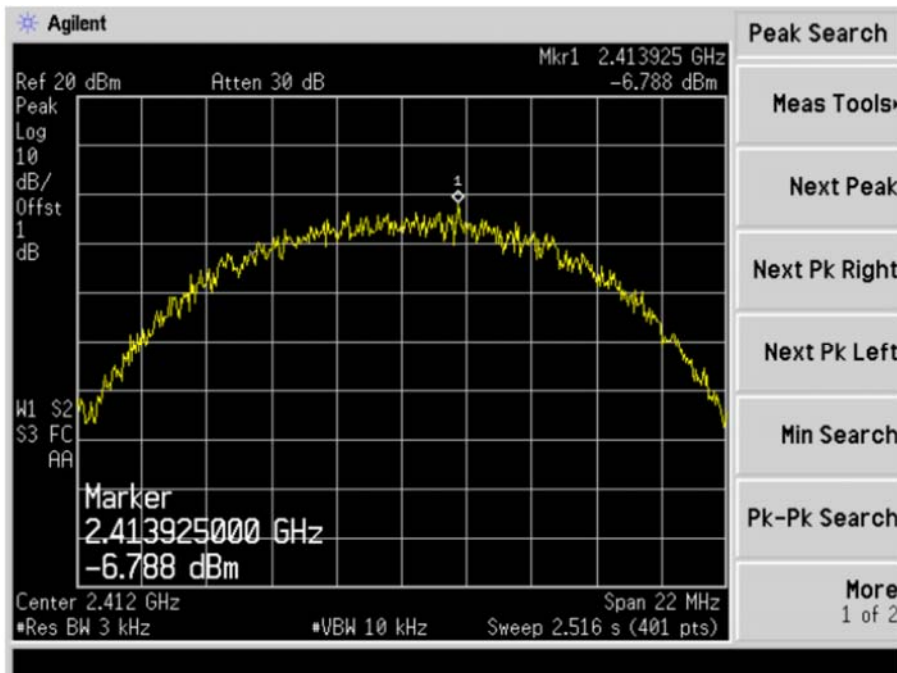

CH: 2437MHz

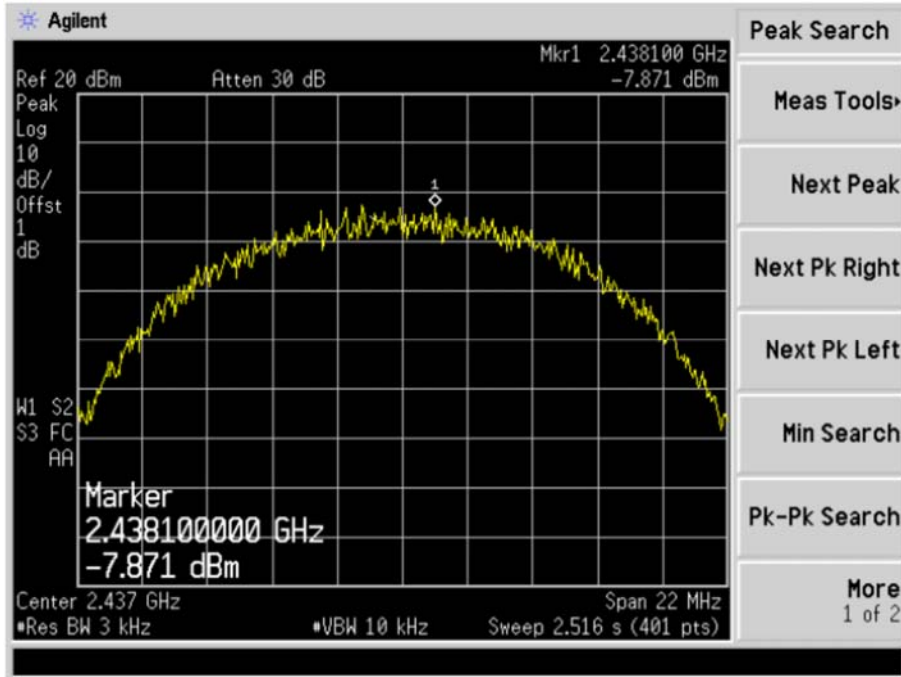

CH: 2462MHz

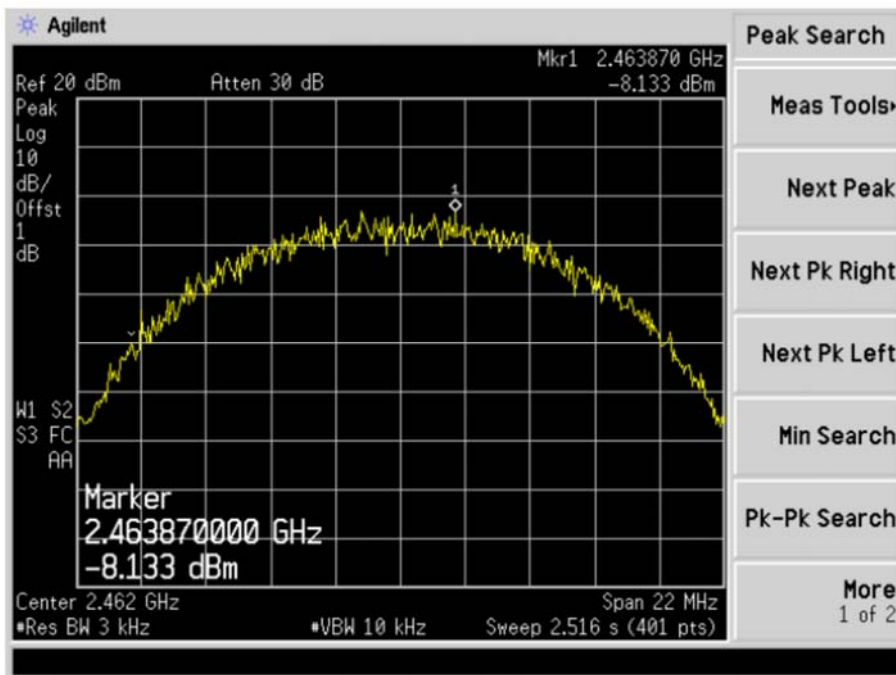

TX 802.11g Mode			
Frequency	Power Density (dBm)	Limit (dBm)	Result
2412 MHz	-12.03	8	PASS
2437 MHz	-12.94	8	PASS
2462 MHz	-12.96	8	PASS

CH: 2412MHz

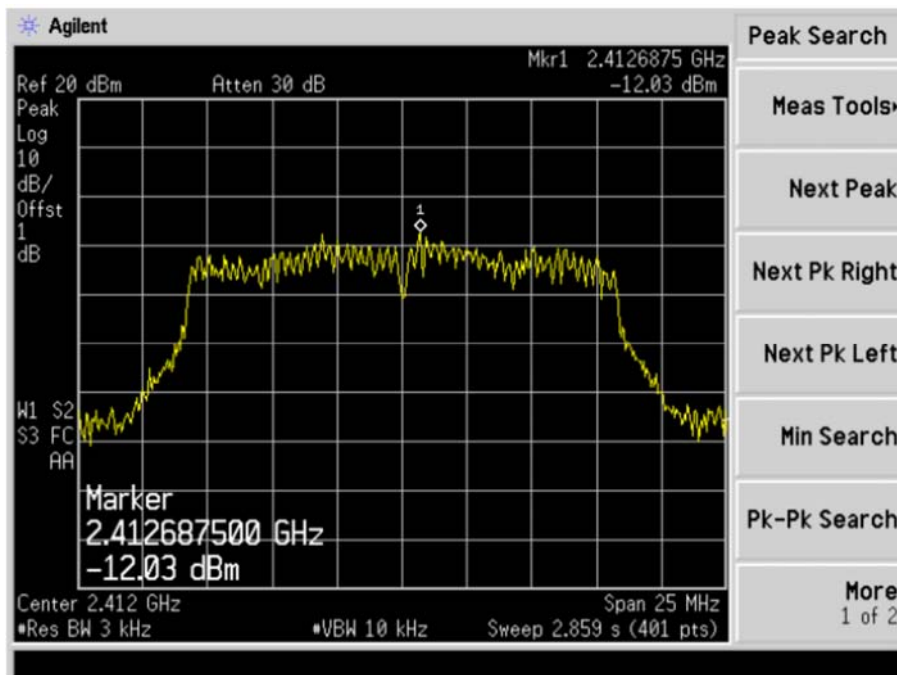

CH: 2437MHz

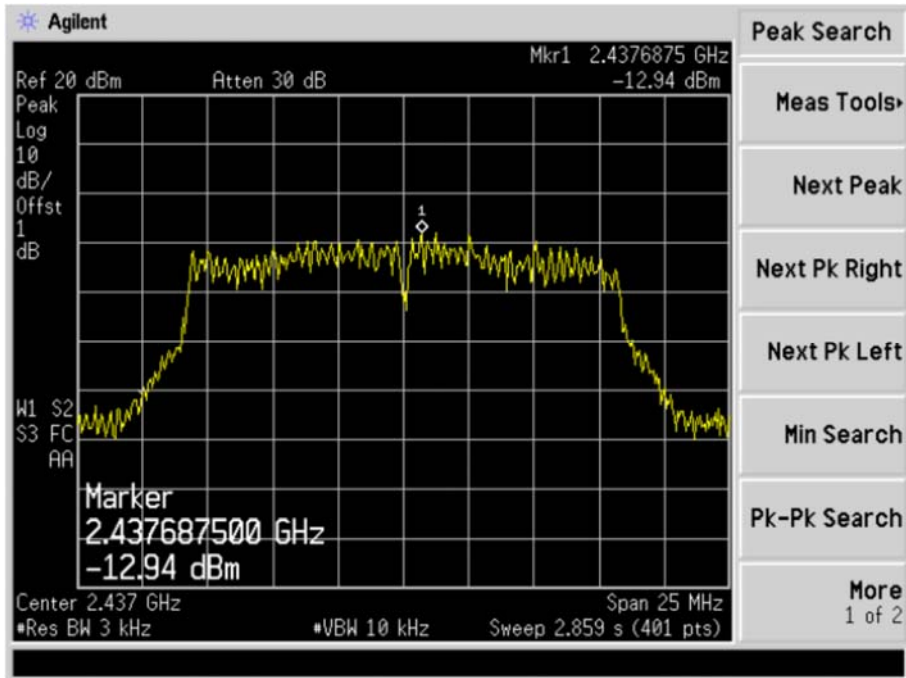

CH: 2462MHz

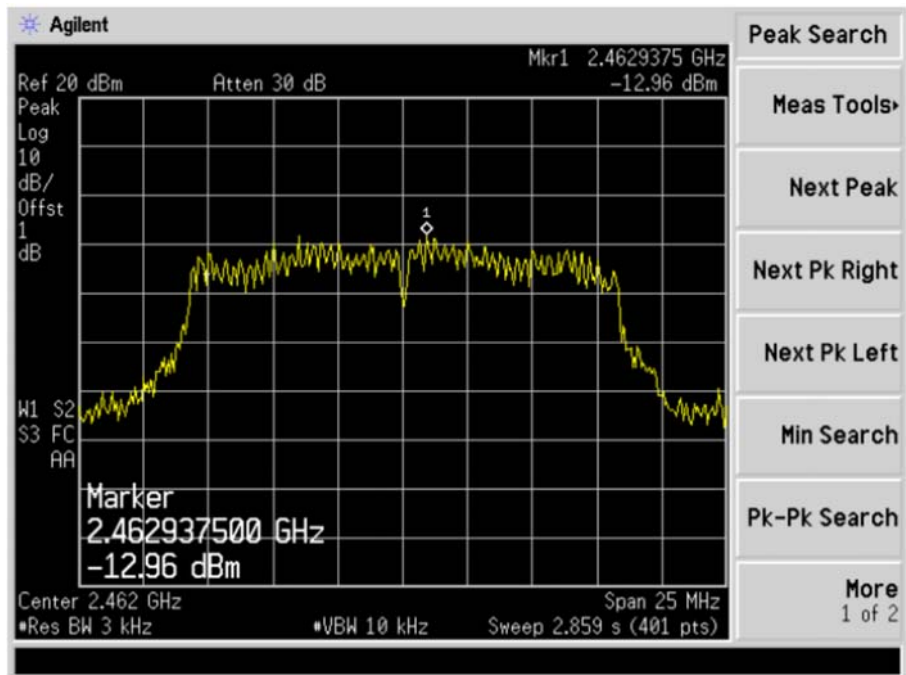

TX 802.11n/HT20 Mode			
Frequency	Power Density (dBm)	Limit (dBm)	Result
2412 MHz	-12.69	8	PASS
2437 MHz	-12.76	8	PASS
2462 MHz	-13.88	8	PASS

CH: 2412MHz

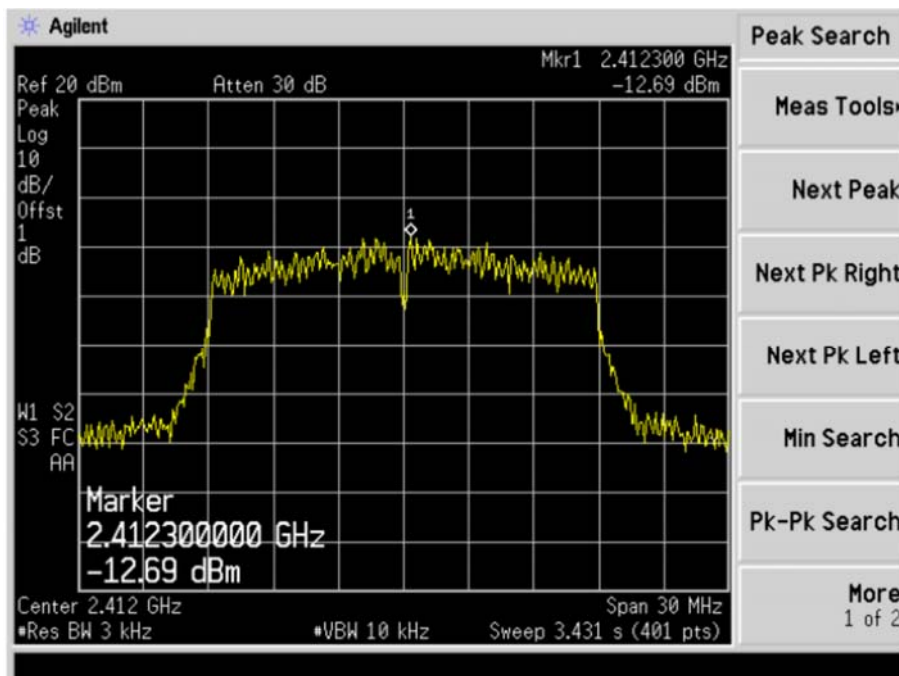

CH: 2437MHz

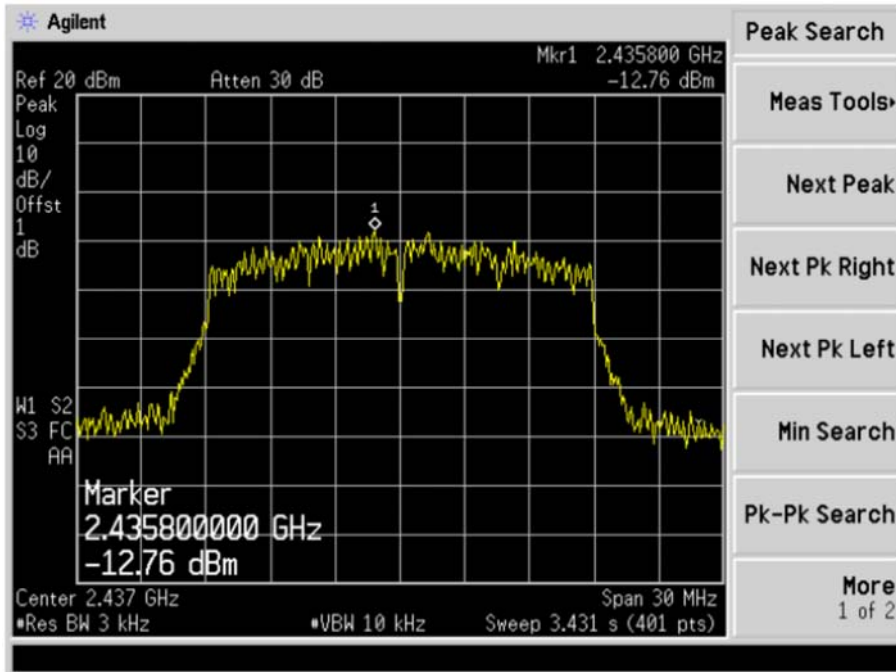

CH: 2462MHz

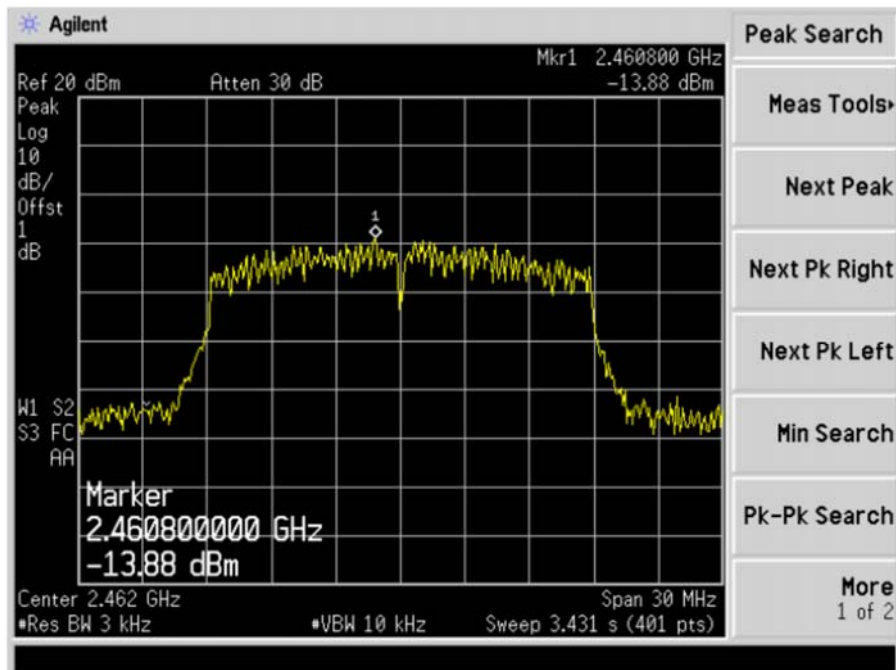

TX 802.11n/HT40 Mode			
Frequency	Power Density (dBm)	Limit (dBm)	Result
2422 MHz	-12.69	8	PASS
2437 MHz	-12.76	8	PASS
2452 MHz	-13.88	8	PASS

CH: 2422MHz

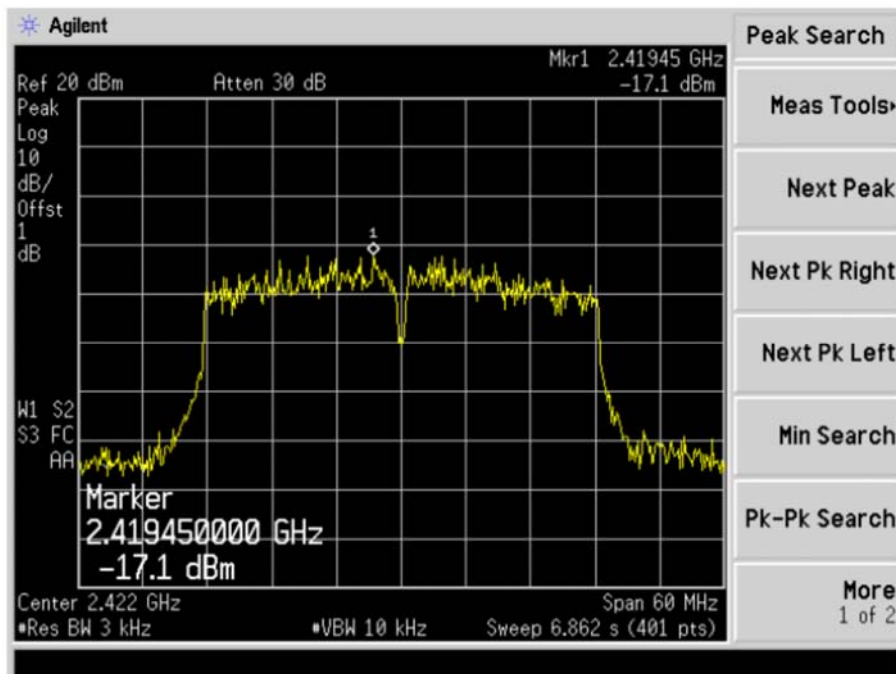

CH: 2437MHz

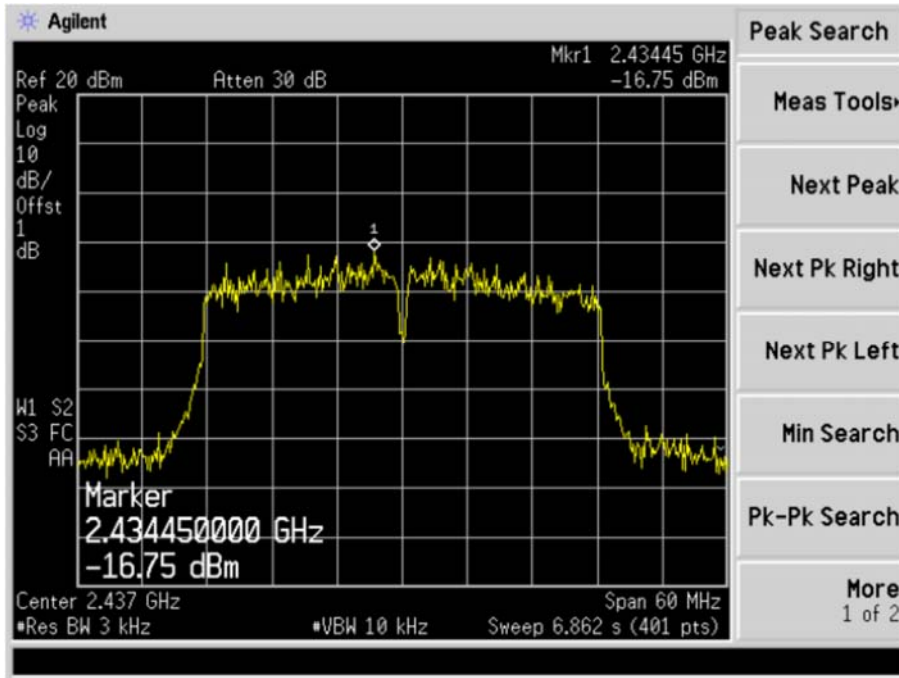

CH: 2452MHz

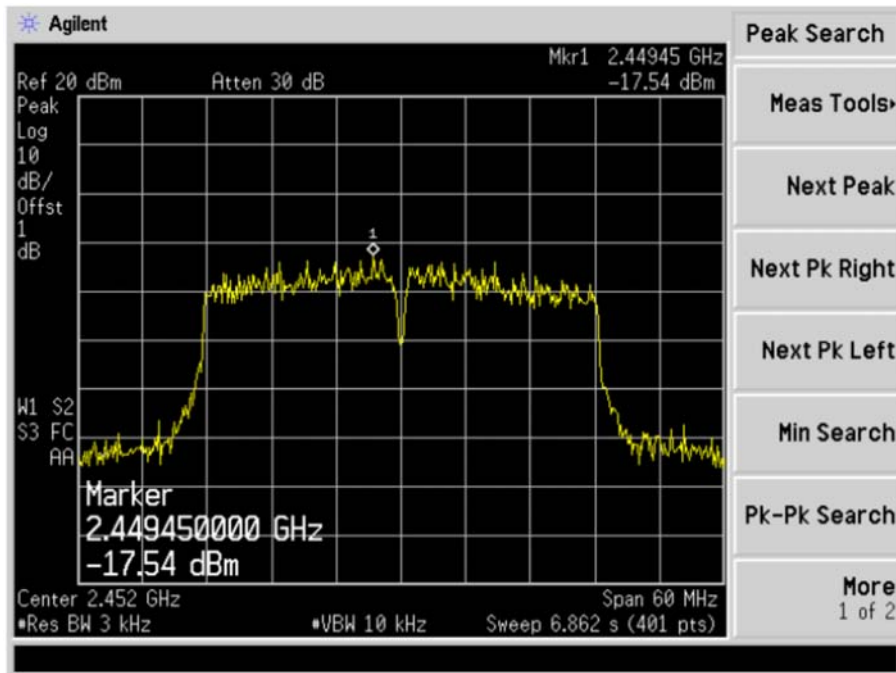

8 PEAK OUTPUT POWER TEST

8.1 Test Limit

FCC Part15 (15.247) , Subpart C				
Section	Test Item	Limit	Frequency Range (MHz)	Result
15.247(b)(3)	Peak Output Power	1 watt or 30dBm	2400-2483.5	PASS

8.2 Test Procedure

1. The EUT was placed on a turn table which is 0.8m above ground plane.
2. The EUT was directly connected to the Power meter.

8.3 Measurement Equipment Used

Same as Radiated Emission Measurement

8.4 Test Result

PASS

All the test modes completed for test.

TX 802.11b Mode			
Test	Frequency	Maximum Peak Conducted Output Power	LIMIT
Channe	(MHz)	(dBm)	dBm
CH01	2412	12.32	30
CH06	2437	12.21	30
CH11	2462	12.07	30
TX 802.11g Mode			
CH01	2412	11.87	30
CH06	2437	11.23	30
CH11	2462	11.42	30
TX 802.11n20 Mode			
CH01	2412	10.82	30
CH06	2437	10.27	30
CH11	2462	10.64	30
TX 802.11n40 Mode			
CH03	2422	8.27	30
CH06	2437	8.16	30
CH09	2452	8.05	30

9 Out of Band Emissions

9.1 Test Limit

In any 100 kHz bandwidth outside the frequency band in which the spread spectrum or digitally modulated intentional radiator is operating, the radio frequency power that is produced by the intentional radiator shall be at least 20 dB below that in the 100 kHz bandwidth within the band that contains the highest level of the desired power, based on either an RF conducted or a radiated measurement, provided the transmitter demonstrates compliance with the peak conducted power limits. If the transmitter complies with the conducted power limits based on the use of RMS averaging over a time interval, as permitted under paragraph (b)(3) of this section, the attenuation required under this paragraph shall be 30 dB instead of 20 dB.

9.2 Test Procedure

1. The EUT was placed on a turn table which is 0.8m above ground plane.
2. Set EUT as TX operation and connect directly to the spectrum analyzer.
3. Set spectrum analyzer RBW= 100KHz. VBW= 300 KHz
4. Set detected by the spectrum analyser with peak detector.

9.3 Test Setup

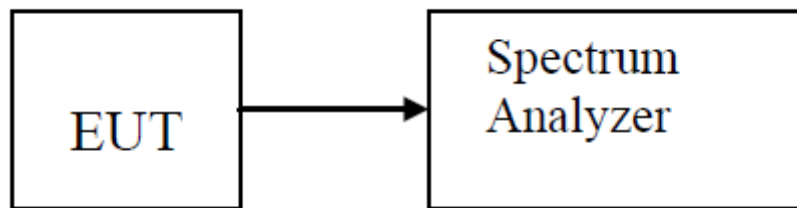

7.4 Test Result

PASS

All the test modes completed for test.

TX 802.11b Mode

Lowest

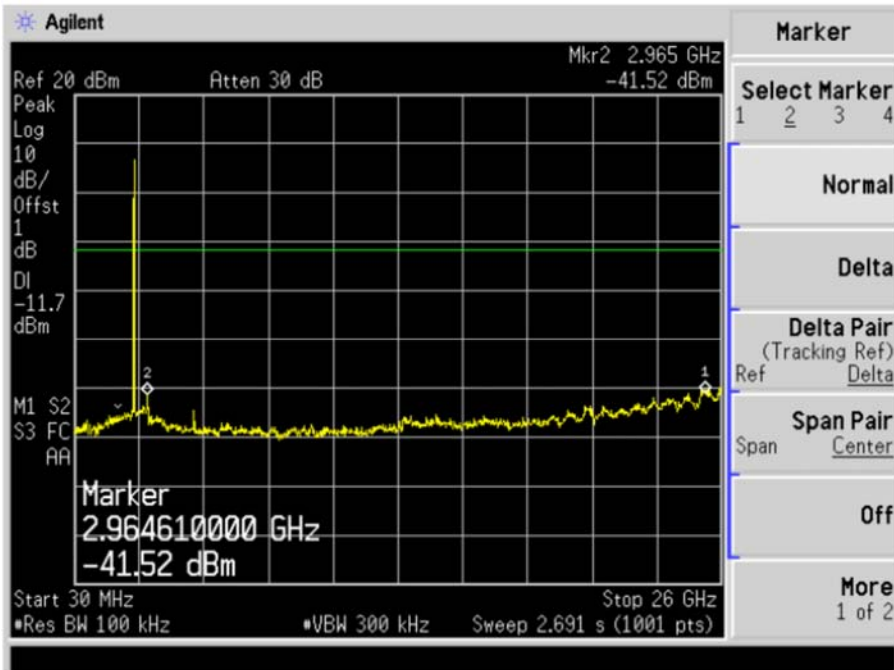
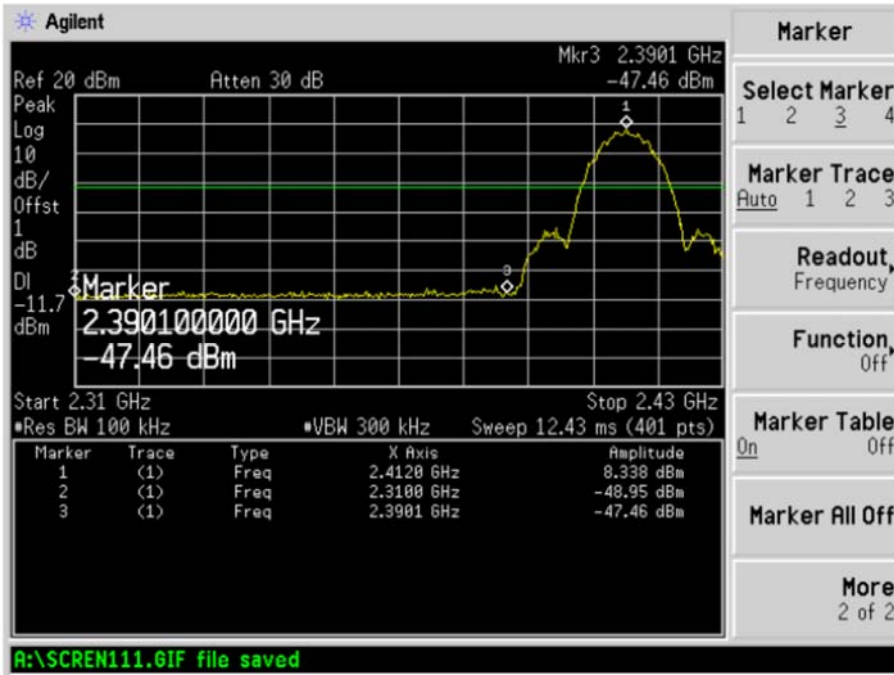

Middle

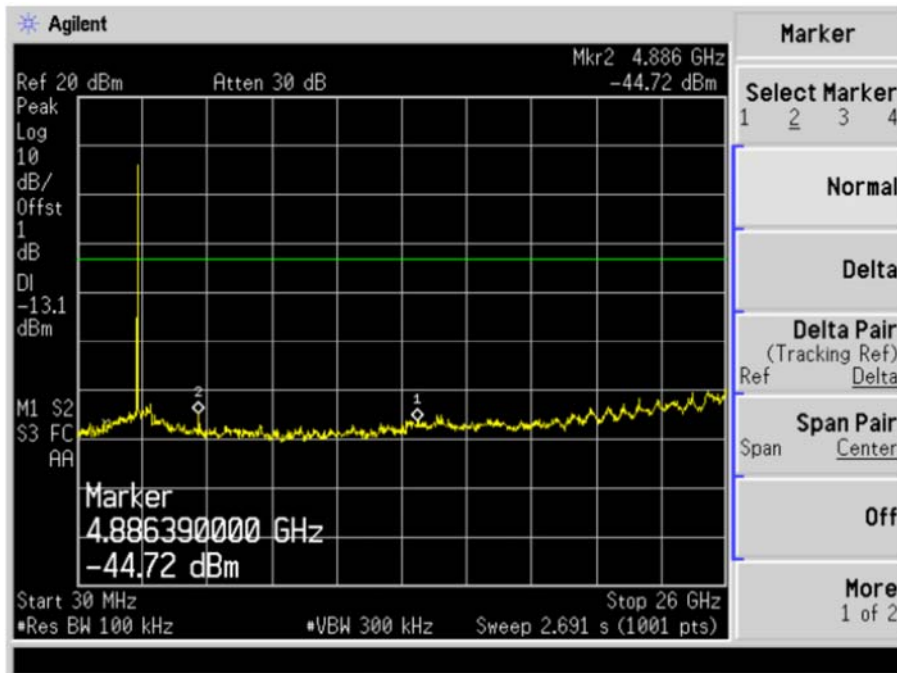
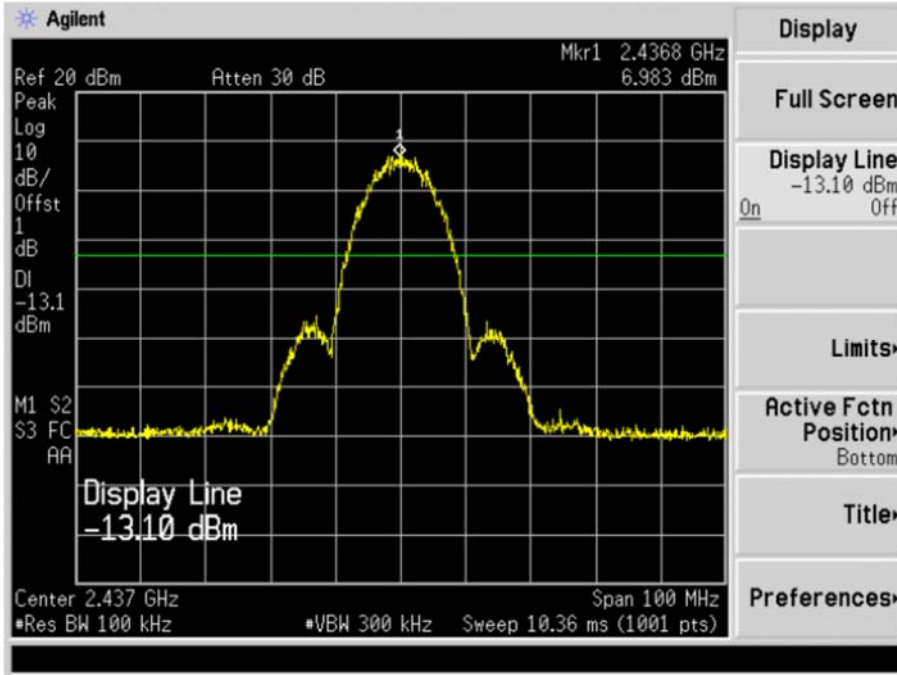

Highest

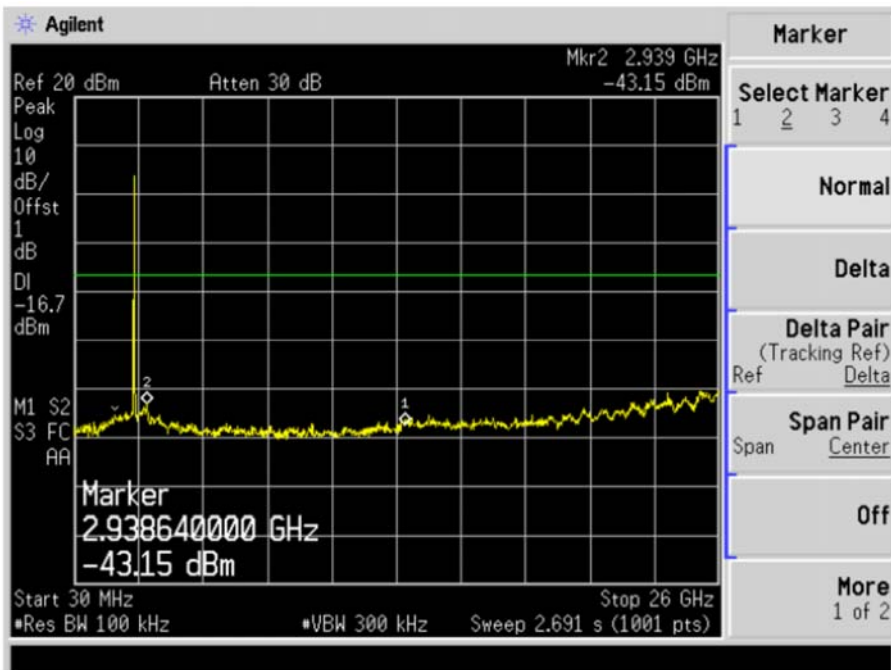
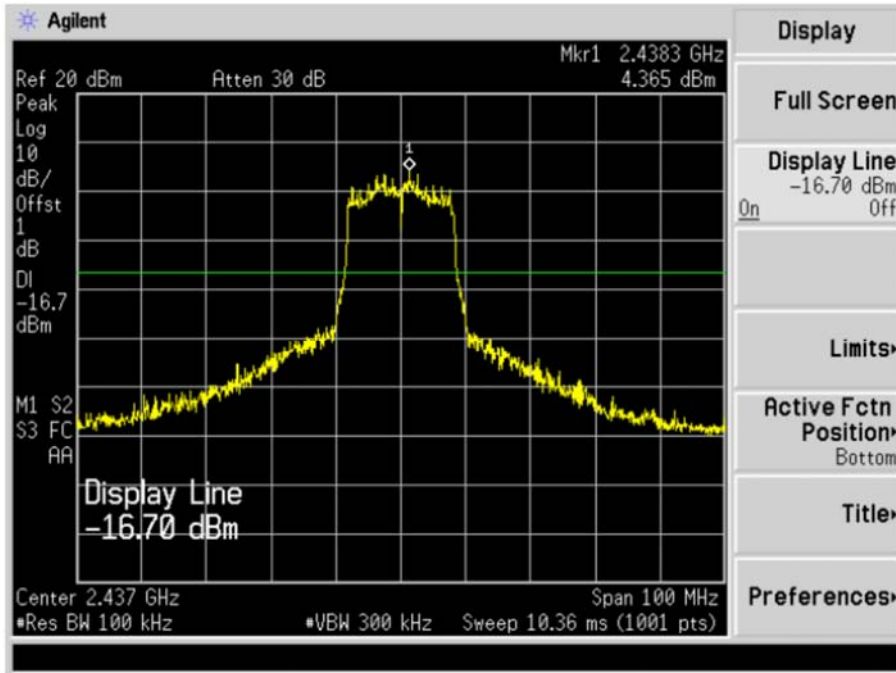

TX 802.11g Mode

Lowest

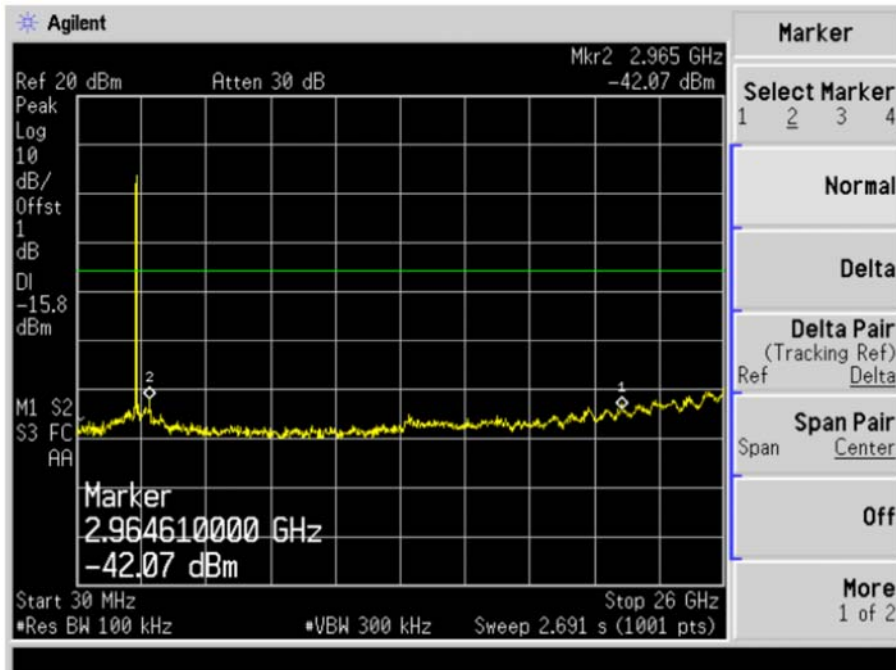
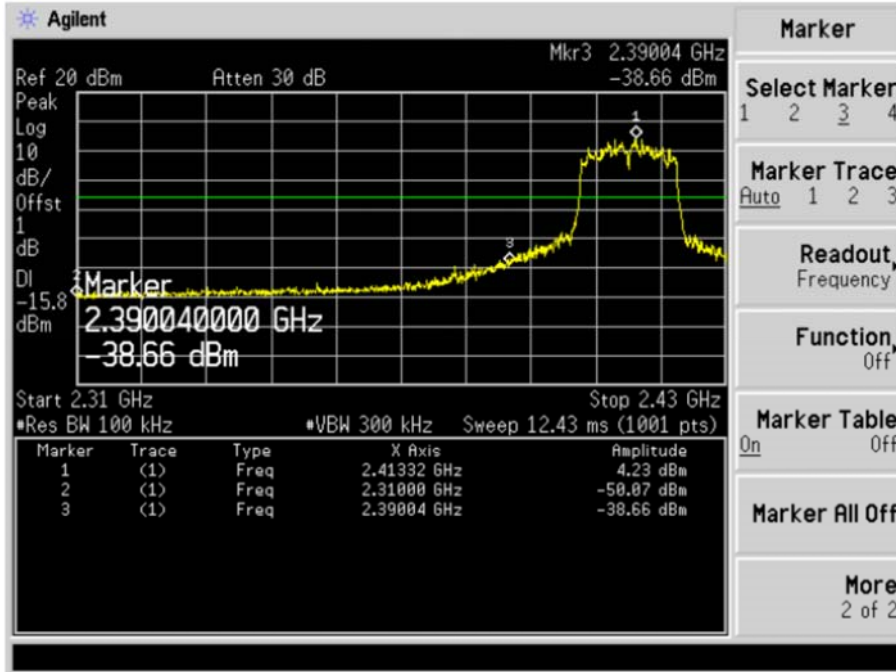

Middle

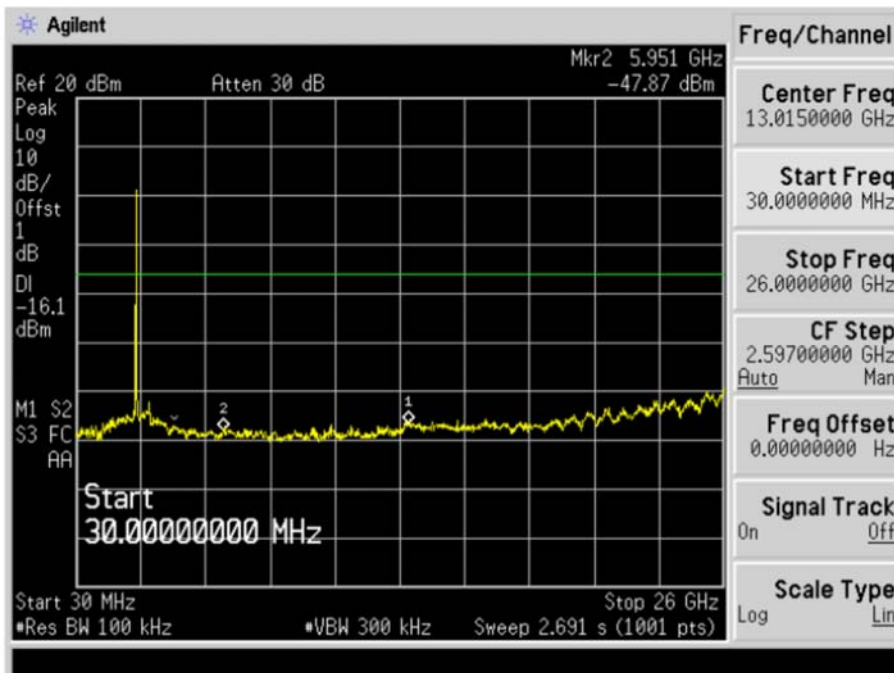
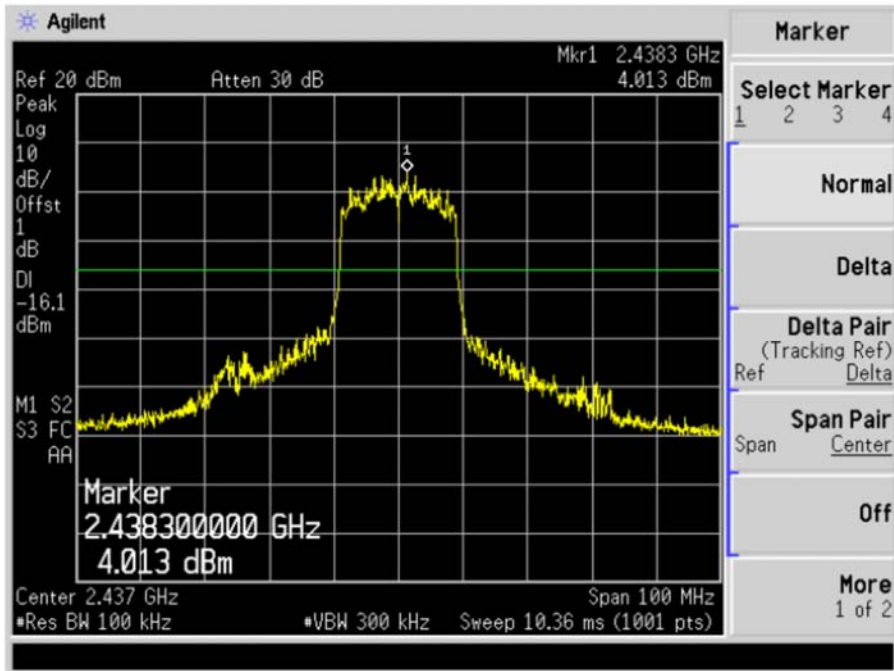

Highest

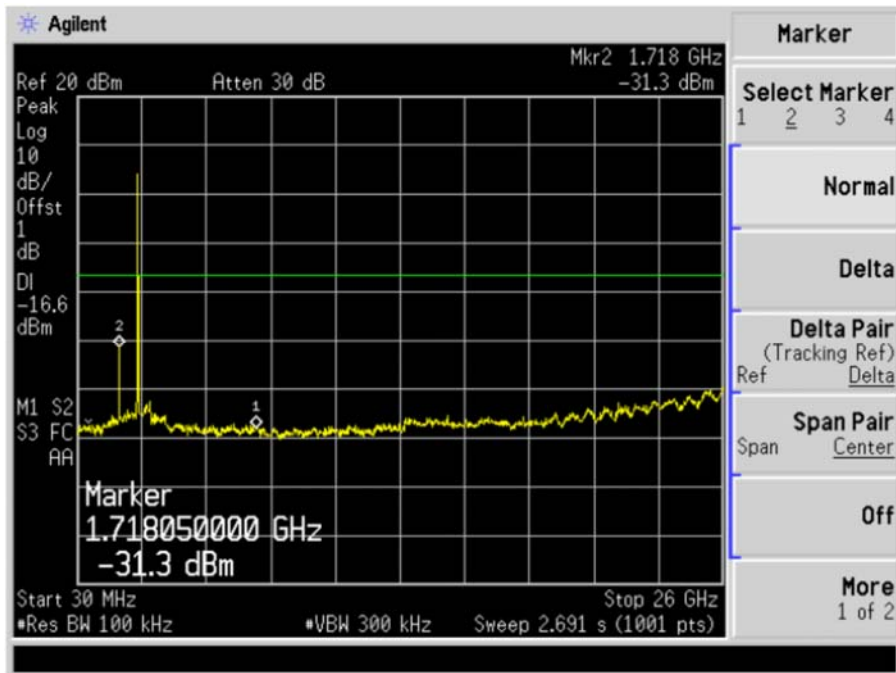
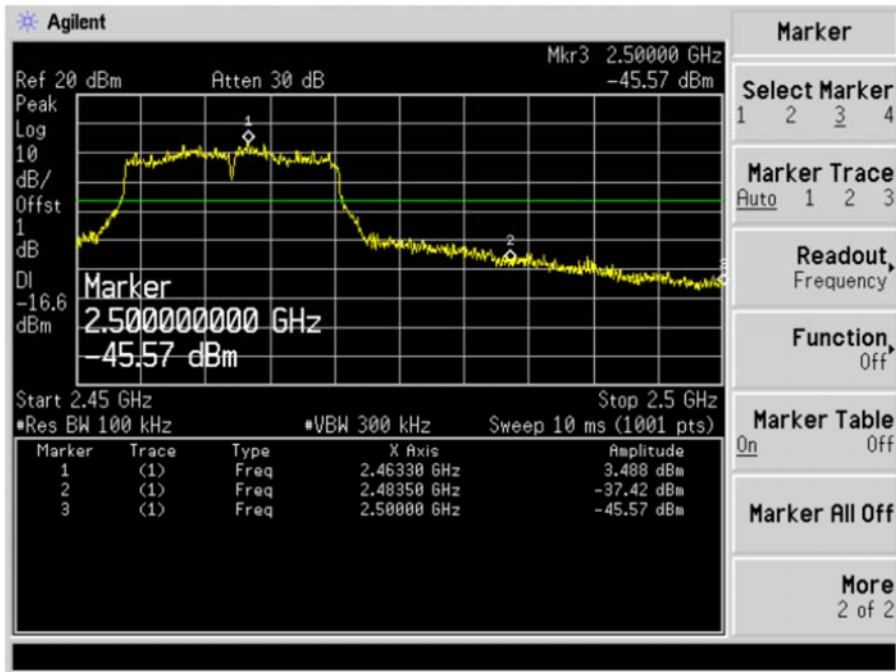

TX 802.11n/HT20 Mode

Lowest

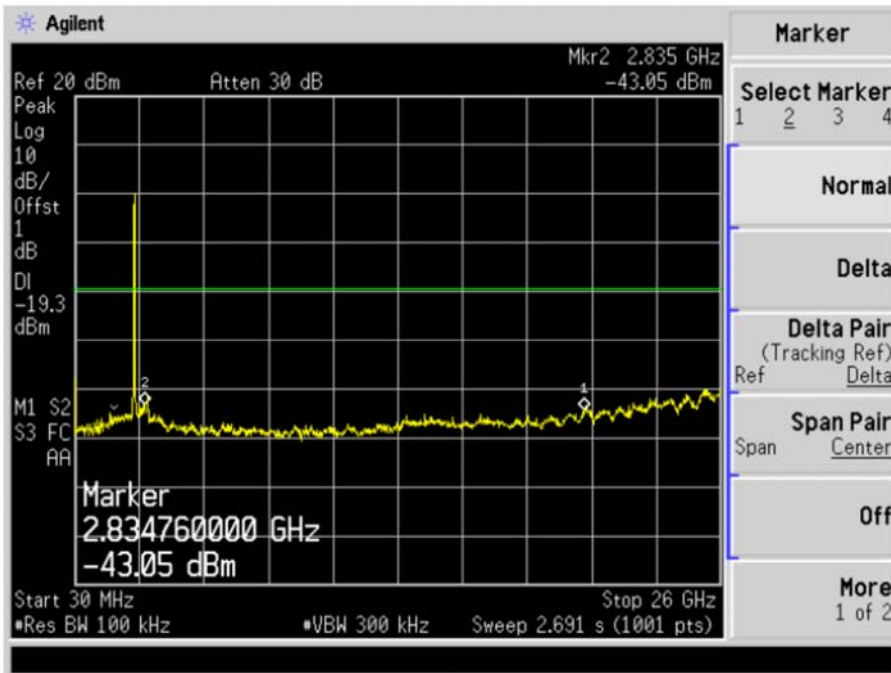
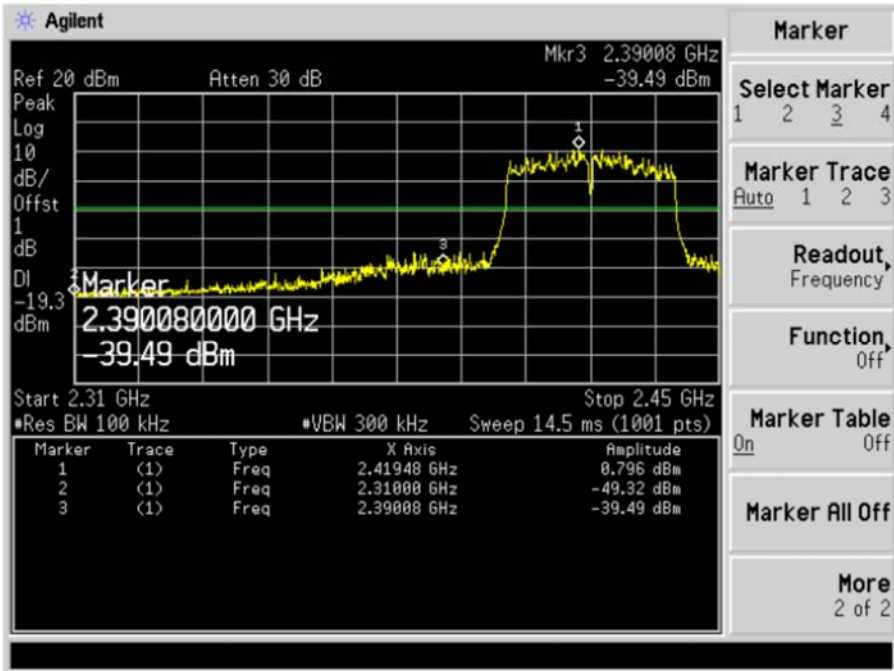

Middle

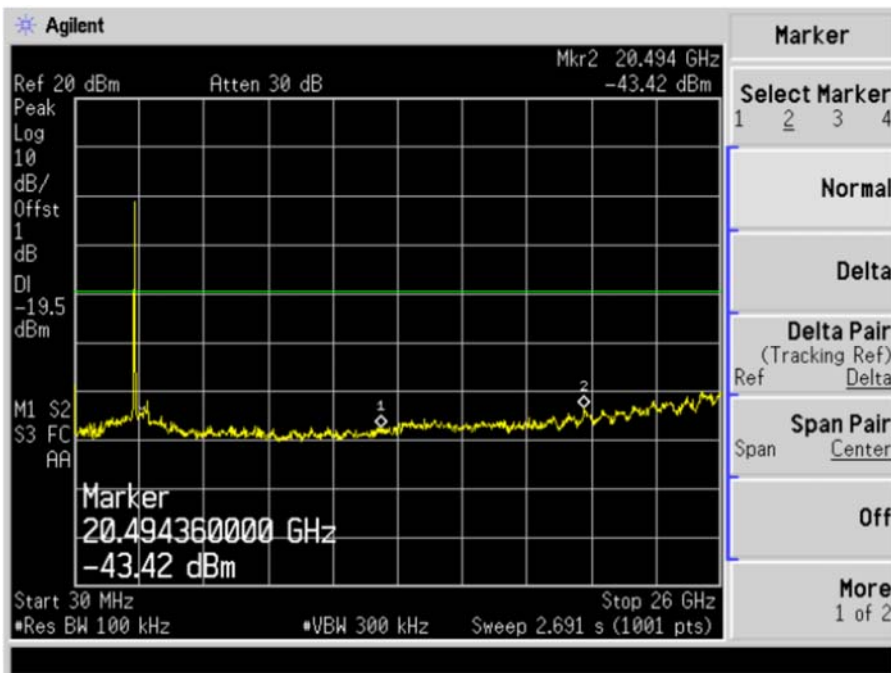
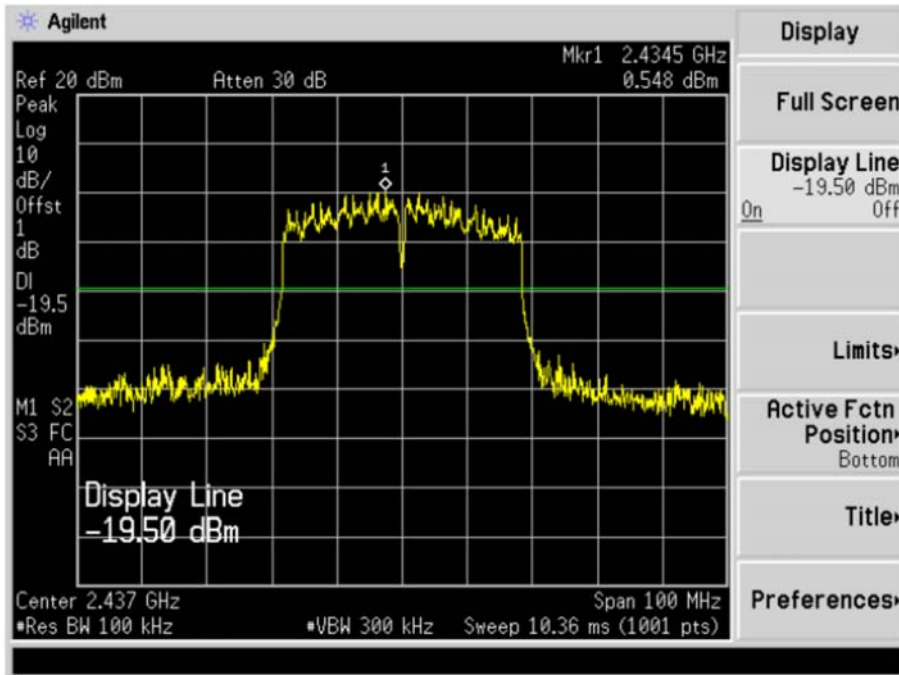

Highest

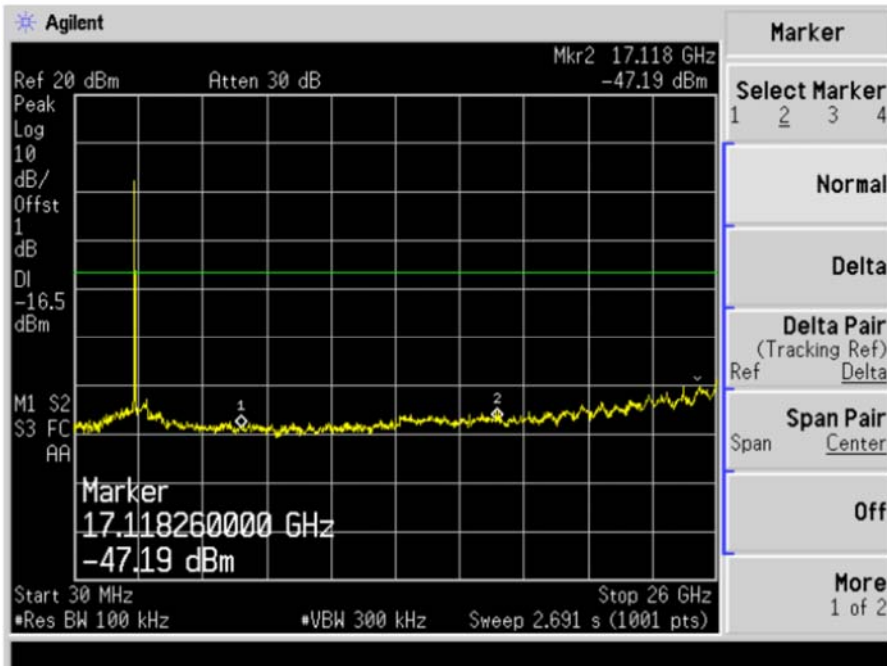
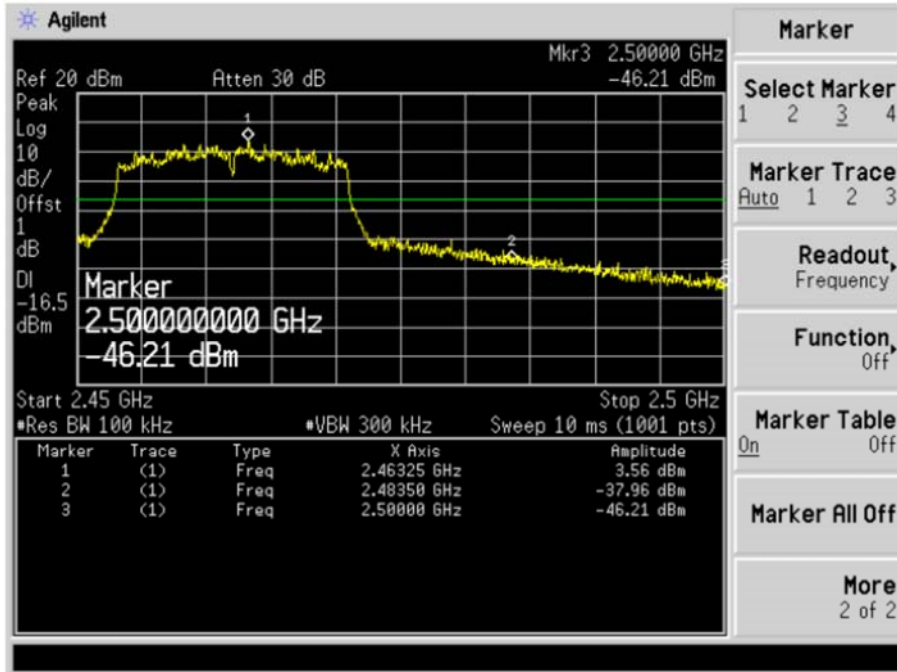

TX 802.11n/HT40 Mode

Lowest

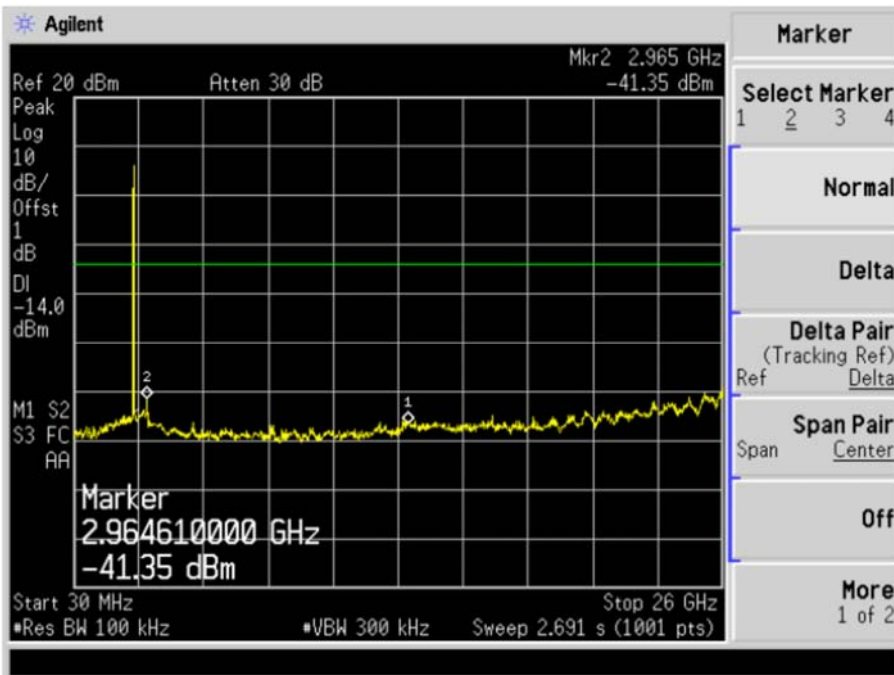
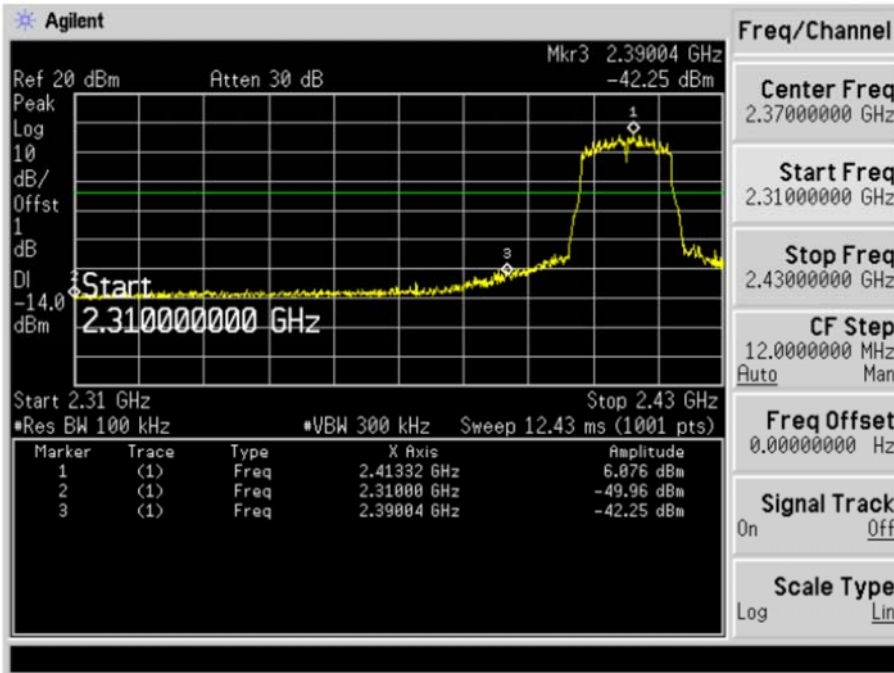

Middle

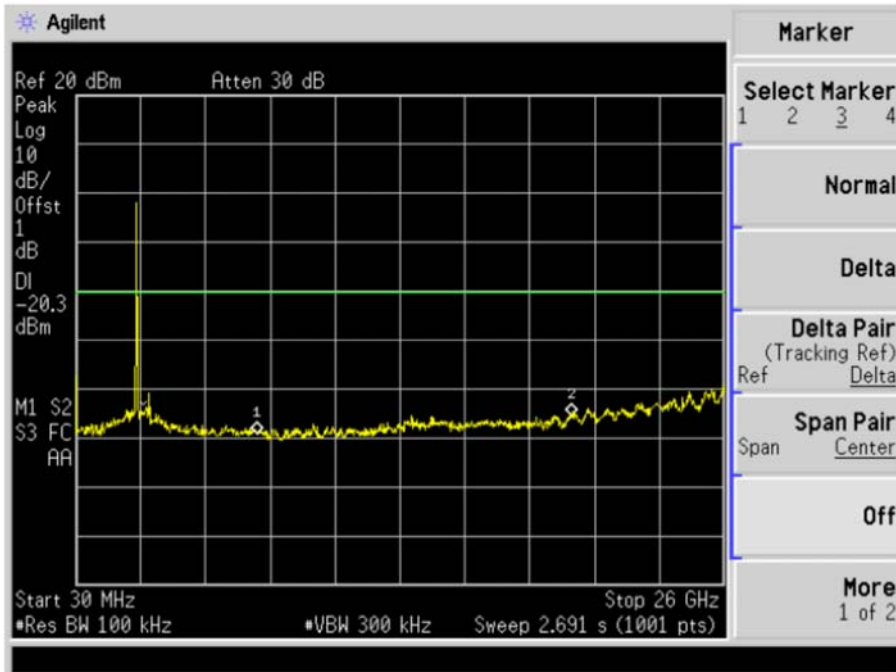
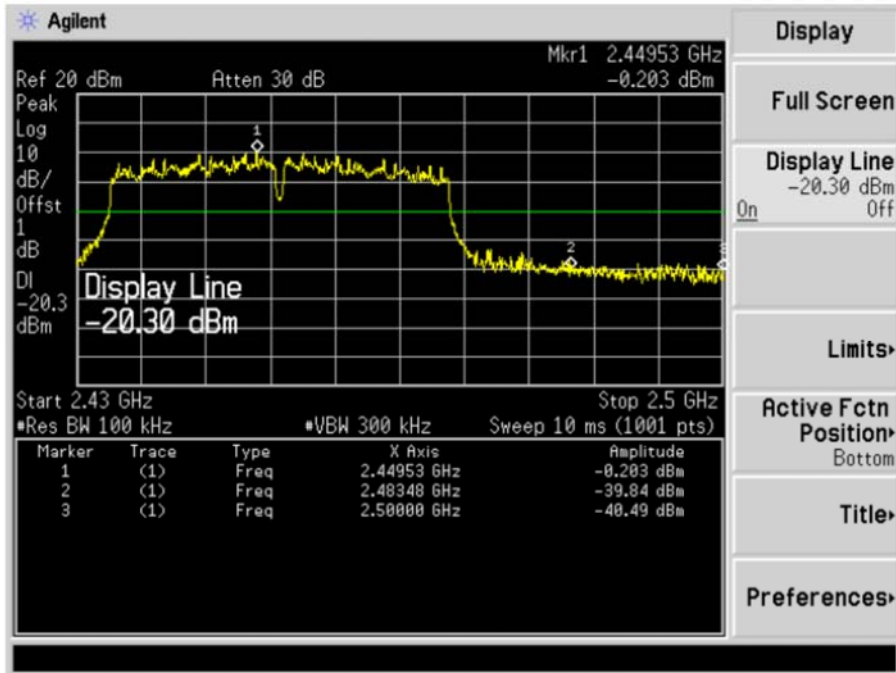

Highest

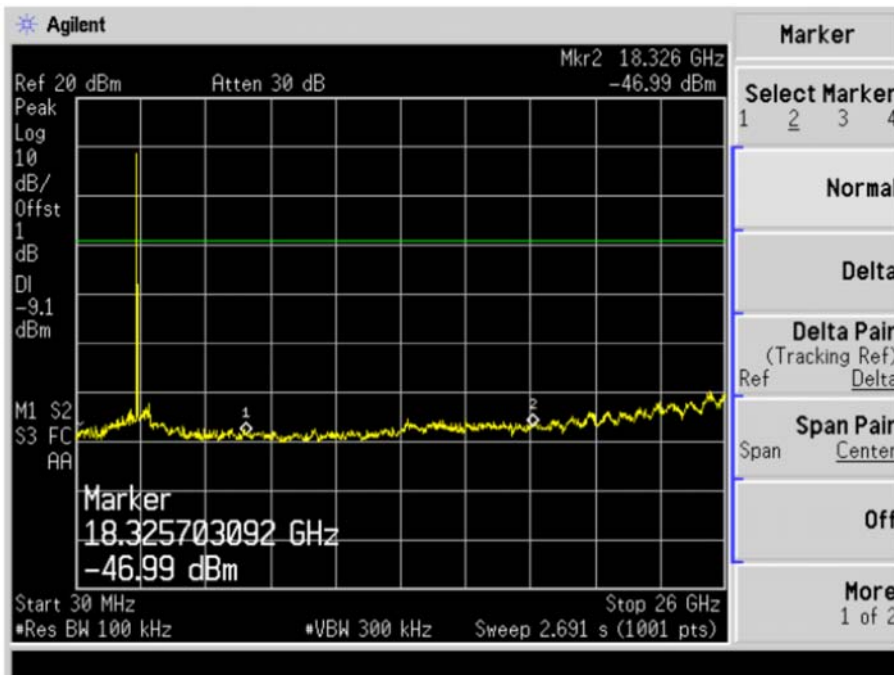
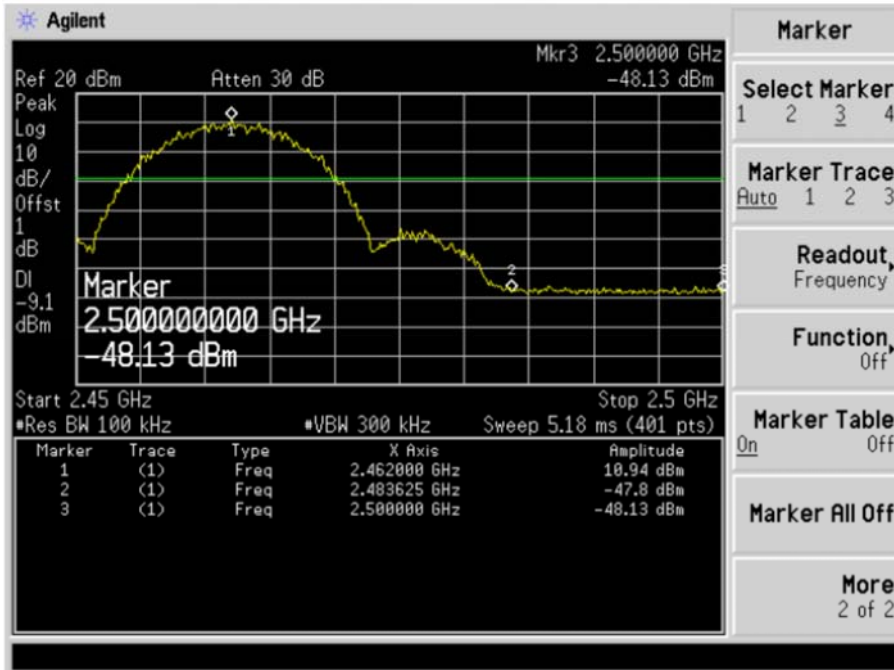

10 ANTENNA REQUIREMENT

Standard Applicable

For intentional device, according to FCC 47 CFR Section 15.203, an intentional radiator shall be designed to ensure that no antenna other than that furnished by the responsible party shall be used with the device. And according to FCC 47 CFR Section 15.249, if transmitting antennas of directional gain greater than 6dBi are used, the power shall be reduced by the amount in dB that the directional gain of the antenna exceeds 6dBi.

Refer to statement below for compliance.

The manufacturer may design the unit so that the user can replace a broken antenna, but the use of a standard antenna jack or electrical connector is prohibited. Further, this requirement does not apply to intentional radiators that must be professionally installed.

Antenna Connected Construction

The antenna used in this product is a Integral Antenna, The directional gains of antenna used for transmitting is 2dBi.

ANTENNA

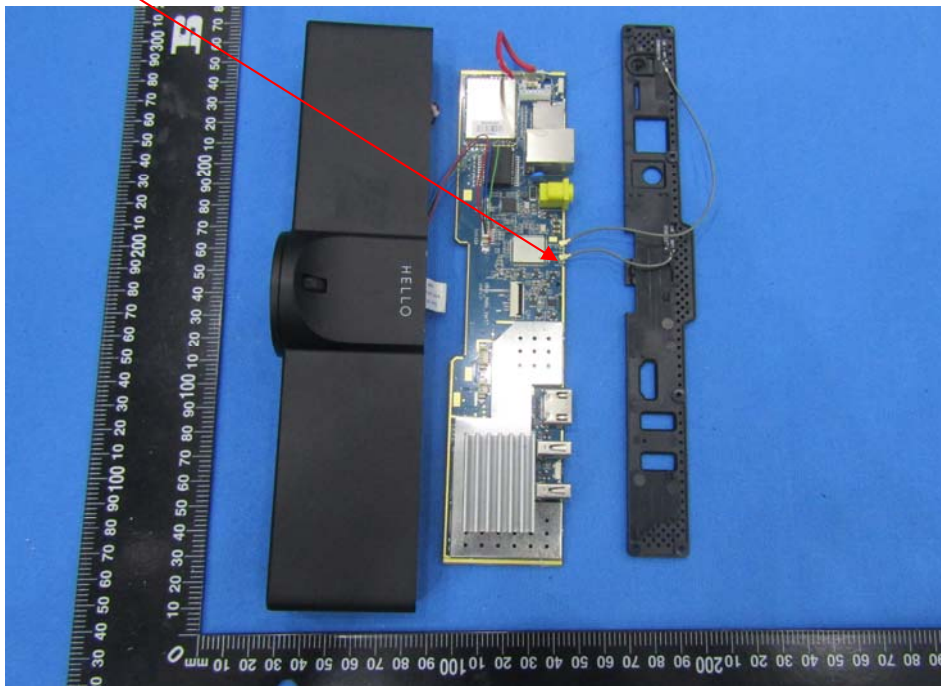

11 PHOTOGRAPH OF TEST

11.1 Radiated Emission

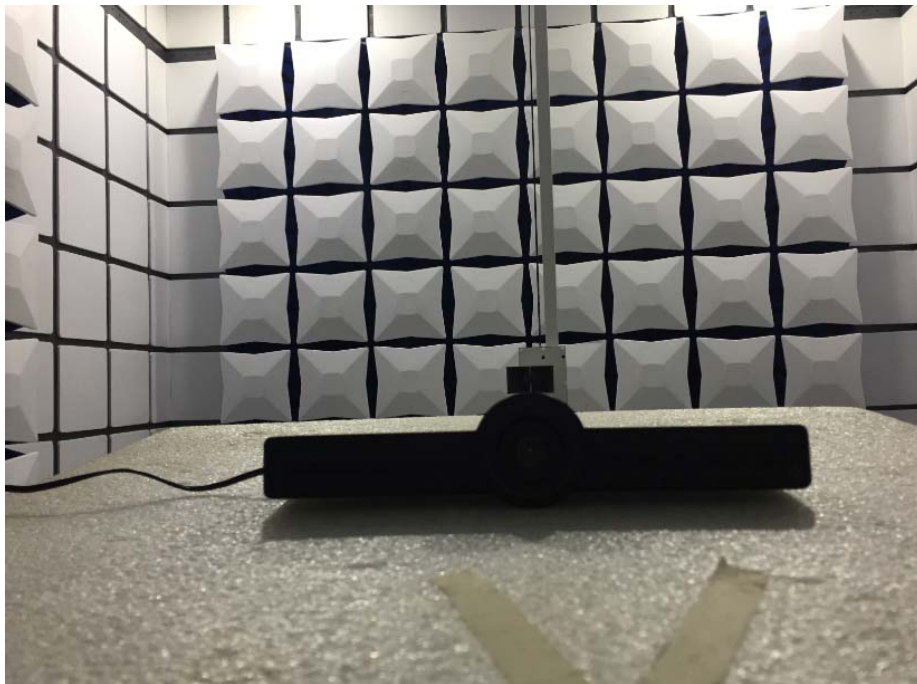

11.2 Conducted Emission

