

FCC RADIO TEST REPORT

For

FCC ID: 2ALTX-TFMTKAW01216

Report Reference No..... : 18EFAS10049 21
Date of issue : 2018-10-15
Testing Laboratory : DongGuan ShuoXin Electronic Technology Co., Ltd.
Address : Zone A, 1F, No. 6, XinGang Road YuanGang Street, XinAn
District, ChangAn Town, DongGuan City, GuangDong,
China

Applicant's name..... : TrekStor GmbH
Address..... : Berliner Ring 7, 64625 Bensheim, Germany

Manufacturer..... : Heyuan Vastking Electronic Co., Ltd.

Test specification:

Test item description..... : TrekStor SurfTab theatre K13
Trade Mark..... : TREKSTOR
Model/Type reference..... : TFMTKAW01216
Ratings..... : INPUT: 100-240V~ 50/60HZ 0.45A, OUTPUT: DC5V 3A
DC 3.8V 10000mAh Li-polymer Battery

Responsible Engineer :

Smile Wang

Authorized Signatory:



King Wang

TABLE OF CONTENTS

1. Summary of test Standards and results	4
2.1. Description of EUT	5
2.2. Accessories of EUT	5
2.3. Assistant equipment used for test	5
2.4. Block diagram of EUT configuration for test.....	6
2.5. Test environment conditions	6
2.6. Measurement uncertainty	7
3. 6dB Bandwidth and 99% Occupied Bandwidth.....	8
3.1. Test equipment	8
3.2. Block diagram of test setup.....	8
3.3. Limits	8
3.4. Test Procedure	8
3.. Test Result.....	9
3.6. Original test data.....	10
4. Maximum Peak Output Power	16
4.1. Test equipment	16
4.2. Block diagram of test setup.....	16
4.3. Limits	16
4.4. Test Procedure	16
5. Power Spectral Density.....	18
5.1. Test equipment	18
5.2. Block diagram of test setup.....	18
5.3. Limits	18
5.5. Test Result.....	19
5.6. Original test data.....	20
6. Spurious Emissions	26
6.1. Test equipment	26
6.2. Block diagram of test setup.....	27
6.3. Limit	28
7. 100 kHz Bandwidth of Frequency Band Edge	37
7.1. Test equipment	37
7.2. Block diagram of test setup.....	37
7.3. Limit	37
7.4. Test Procedure	38
7.5. Test result	38

8. Conducted Spurious Emissions	43
8.1. Test Equipment.....	43
8.2. Limit	43
8.3. Test Procedure	43
8.4. Test result	44
9 Power Line Conducted Emission	56
9.1 Test equipment	56
9.2 Block diagram of test setup.....	56
9.3 Power Line Conducted Emission Limits(Class B)	56
9.4 Test Procedure	57
9.5 Test Result.....	57
Note2: “-----” means peak detection; “-----” mans average detection.....	57
10. Antenna Requirements	60
10.1. Limit	60
10.2. Result.....	60

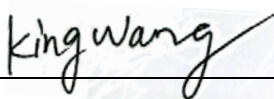
TEST REPORT DECLARE

Applicant	:	TrekStor GmbH
Address	:	Berliner Ring 7, 64625 Bensheim, Germany
Equipment under Test	:	TrekStor SurfTab theatre K13
Model No	:	TFMTKAW01216
Trade Mark	:	TREKSTOR
Manufacturer	:	Heyuan Vastking Electronic Co., Ltd.
Address	:	No.13, Hepu Avenue, Yuancheng District, Heyuan City, Guangdong

Test Standard Used: FCC Rules and Regulations Part 15 Subpart C (15.247)

Test procedure used: ANSI C63.10:2013, 558074 V05.

We Declare:

The equipment described above is tested by DongGuan ShuoXin Electronic Technology Co., Ltd. and in the configuration tested the equipment complied with the standards specified above. The test results are contained in this test report and DongGuan ShuoXin Electronic Technology Co., Ltd. is assumed of full responsibility for the accuracy and completeness of these tests.

After test and evaluation, our opinion is that the equipment provided for test compliance with the requirement of the above FCC standards.

Report No:	18EFAS10049 21		
Date of Test:	2018-10-15	Date of Report:	2018-10-19

Note: This report applies to above tested sample only. This report shall not be reproduced in parts without written approval of DongGuan ShuoXin Electronic Technology Co., Ltd.

1. Summary of test Standards and results

The EUT have been tested according to the applicable standards as referenced below.

Description of Test Item	Standard	Results
6dB Bandwidth And 99% Occupied Bandwidth	FCC Part 15.247 (a)(2)	PASS
Peak Output Power	FCC Part 15.247(b)(3)	PASS
Power Spectral Density	FCC Part 15.247(e)	PASS
Spurious Emissions at Antenna Port	FCC Part 15.247(d)	PASS
Spurious Emissions	FCC Part 15.205, 15.209, FCC Part 15.247(d)	PASS
100 kHz Bandwidth of Frequency Band Edge	FCC Part 15.247(d)	PASS
AC Line Conducted Emissions	FCC Part 15.207 (a)	PASS
Antenna requirement	FCC Part 15: 15.203	PASS

2. GENERAL TEST INFORMATION

2.1. Description of EUT

EUT* Name	:	TrekStor SurfTab theatre K13
Model Number	:	TFMTKAW01216
Trade Mark	:	TREKSTOR
EUT function description	:	TrekStor SurfTab theatre K13 with WiFi & BT function.
Power supply	:	INPUT: 100-240V~ 50/60HZ 0.45A, OUTPUT: DC5V 3A DC 3.8V 10000mAh Li-polymer Battery
Adaptor	:	JHD-AP015U-050300BA-C
Radio Specification	:	IEEE802.11b/g/n20/n40
Operation frequency	:	IEEE 802.11b: 2412MHz—2462MHz IEEE 802.11g: 2412MHz—2462MHz IEEE 802.11n20: HT20: 2412MHz—2462MHz IEEE 802.11n40: HT40: 2422MHz—2452MHz
Modulation	:	IEEE 802.11b: DSSS(CCK,DQPSK,DBPSK) IEEE 802.11g: OFDM(64QAM, 16QAM, QPSK, BPSK) IEEE 802.11n20: HT20: OFDM (64QAM, 16QAM, QPSK,BPSK) IEEE 802.11n40: HT40: OFDM (64QAM, 16QAM, QPSK,BPSK)
Antenna Type	:	FPCB Antenna
FVIN	:	NA
Date of Receipt	:	2018/10/19
Sample Type	:	N/A

Note: EUT is the ab. of equipment under test.

2.2. Accessories of EUT

Description of Accessories	Manufacturer	Model number or Type	Other
Adapter	Shen Zhen Jihongda Power Co., Ltd	JHD-AP015U-050300BA-C	/

2.3. Assistant equipment used for test

Description of Assistant equipment	Manufacturer	Model number or Type	Other
/	/	/	/

2.4. Block diagram of EUT configuration for test



EUT was connected to control to a special test jig provided by manufacturer which has a standard RSS-232 connector to connect to Notebook, and the Notebook will run a special test software “MP_v1.1.1” provided by manufacturer to control EUT work in test mode as blow table.

Tested mode, channel, and data rate information			
Mode	data rate (Mbps) (see Note)	Channel	Frequency (MHz)
IEEE 802.11b	1	Low :CH1	2412
	1	Middle: CH6	2437
	1	High: CH11	2462
IEEE 802.11g	6	Low :CH1	2412
	6	Middle: CH6	2437
	6	High: CH11	2462
IEEE 802.11n HT20	MCS 0	Low :CH1	2412
	MCS 0	Middle: CH6	2437
	MCS 0	High: CH11	2462
IEEE 802.11n HT40	MCS 0	Low :CH3	2422
	MCS 0	Middle: CH6	2437
	MCS 0	High: CH9	2452

Note: According exploratory test, EUT will have maximum output power in those data rate, so those data rate were used for all test.

2.5. Test environment conditions

During the measurement the environmental conditions were within the listed ranges:

Temperature range:	21-25℃
Humidity range:	40-75%
Pressure range:	86-106kPa

2.6. Measurement uncertainty

Test Item	Uncertainty
Uncertainty for Conduction emission test (9kHz-150kHz)	3.7 dB
Uncertainty for Conduction emission test (150kHz-30MHz)	3.3 dB
Uncertainty for Radiation Emission test (30MHz-200MHz)	4.60 dB (Polarize: V)
	4.60 dB (Polarize: H)
Uncertainty for Radiation Emission test (200MHz-1GHz)	6.10 dB (Polarize: V)
	5.08 dB (Polarize: H)
Uncertainty for Radiation Emission test (1GHz-6GHz)	5.01 dB (Polarize: V)
	5.01 dB (Polarize: H)
Uncertainty for Radiation Emission test (6GHz-18GHz)	5.26 dB (Polarize: V)
	5.26 dB (Polarize: H)
Uncertainty for Radiation Emission test (18GHz-40GHz)	5.06 dB (Polarize: V)
	5.06 dB (Polarize: H)
Uncertainty for radio frequency	$\pm 0.048\text{kHz}$
Uncertainty for conducted RF Power	$\pm 0.32\text{dB}$

Note: This uncertainty represents an expanded uncertainty expressed at approximately the 95% confidence level using a coverage factor of k=2.

3. 6dB Bandwidth and 99% Occupied Bandwidth

3.1. Test equipment

Item	Equipment	Manufacturer	Model No.	Serial No.	Calibrated until	Calibrated Date
1	Spectrum analyzer	KEYSIGHT	N9010A	MY55150427	05/25/2019	05/26/2018
2	Attenuator	Mini-Circuits	BW-S10W2	101109	12/17/2018	12/18/2017
3	RF Cable	Micable	C10-01-01-1	100309	12/17/2018	12/18/2017
4	Spectrum analyzer	R&S	FSV40	101470	06/29/2019	06/28/2018

3.2. Block diagram of test setup

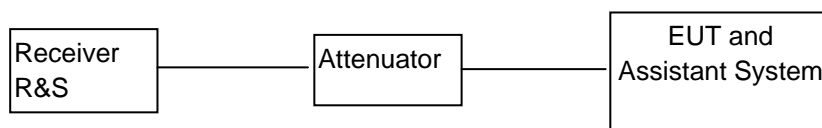

3.3. Limits

For direct sequence systems, the minimum 6dB bandwidth shall be at least 500 KHz

3.4. Test Procedure

- (1) Check the calibration of the measuring instrument using either an internal calibrator or a known signal from an external generator.
- (2) Position the EUT without connection to measurement instrument. Turn on the EUT and connect it to measurement instrument. Then set it to any one convenient frequency within its operating range. Set a reference level on the measuring instrument equal to the highest peak value.
- (3) Measure the frequency difference of two frequencies that were attenuated 6 dB from the reference level. Record the frequency difference as the emission bandwidth.
- (4) Repeat above procedures until all frequencies measured were complete.

3.. Test Result

EUT Set Mode	CH or Frequency	6 dB bandwidth	99% dB bandwidth	Limt	Conclusion
		Result (MHz)	Result (MHz)		
IEEE 802.11B	CH 1	9.0175	/	>500KHz	PASS
	CH 6	9.0363	/		PASS
	CH 11	9.0313	/		PASS
IEEE 802.11G	CH 1	16.1938	/		PASS
	CH 6	16.3400	/		PASS
	CH 11	16.3475	/		PASS
IEEE 802.11N20	CH 1	17.5425	/		PASS
	CH 6	17.5225	/		PASS
	CH 11	17.5575	/		PASS
IEEE 802.11N40	CH 1	35.6825	/		PASS
	CH 6	35.6925	/		PASS
	CH 11	35.4875	/		PASS

3.6. Original test data

802.11 B Mode CH1

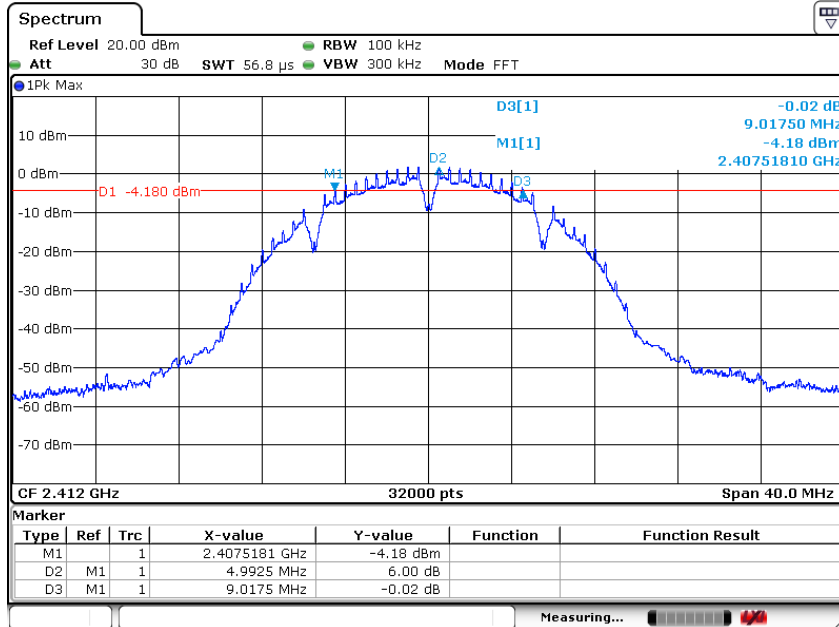

802.11 B Mode CH6

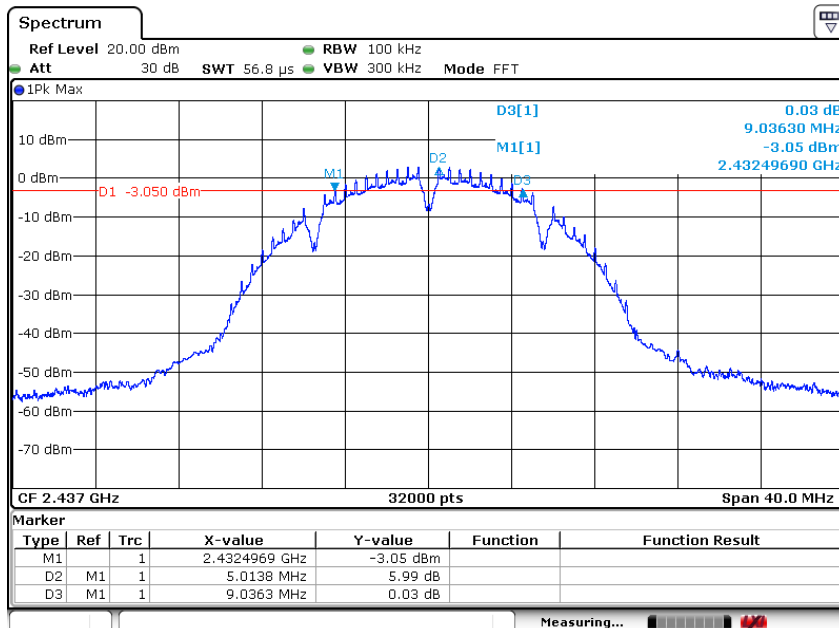

802.11 B Mode CH11

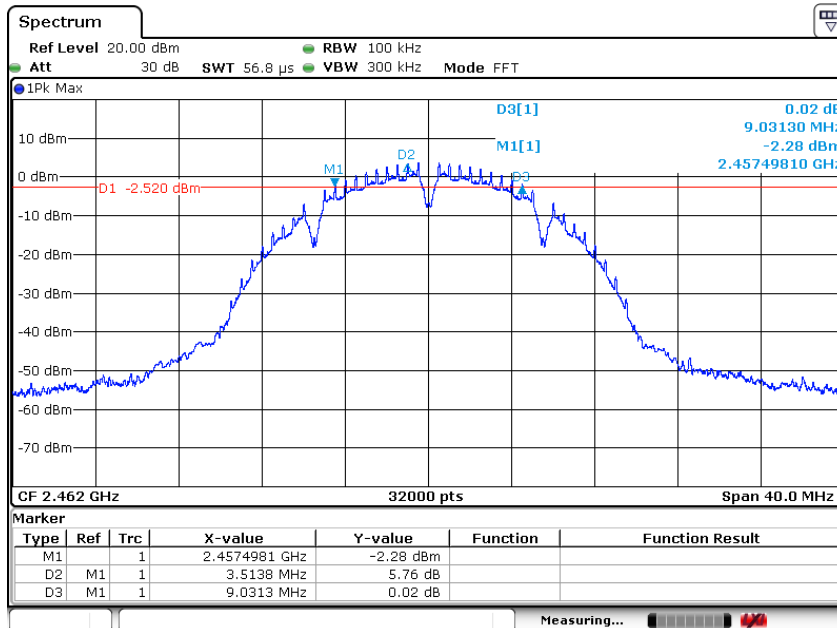

802.11 G Mode CH1

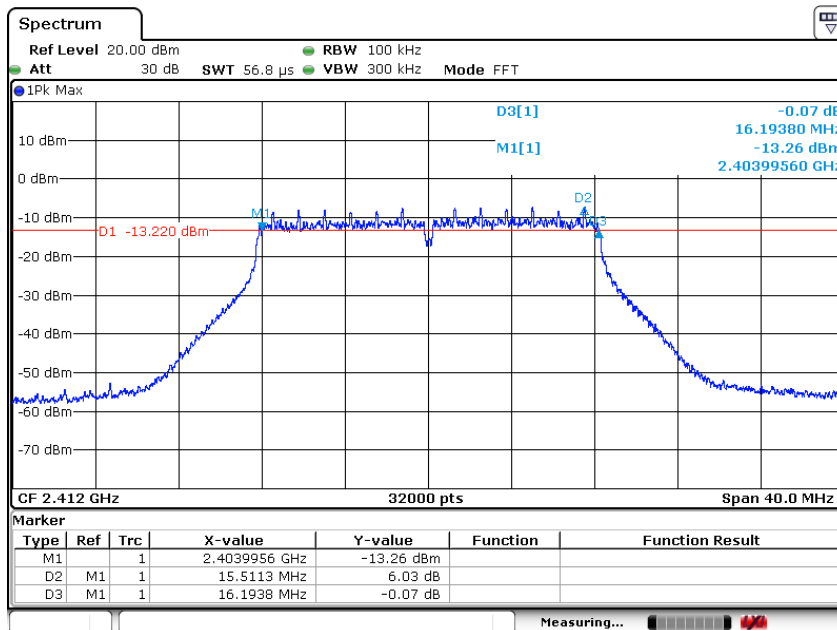

802.11 G Mode CH6

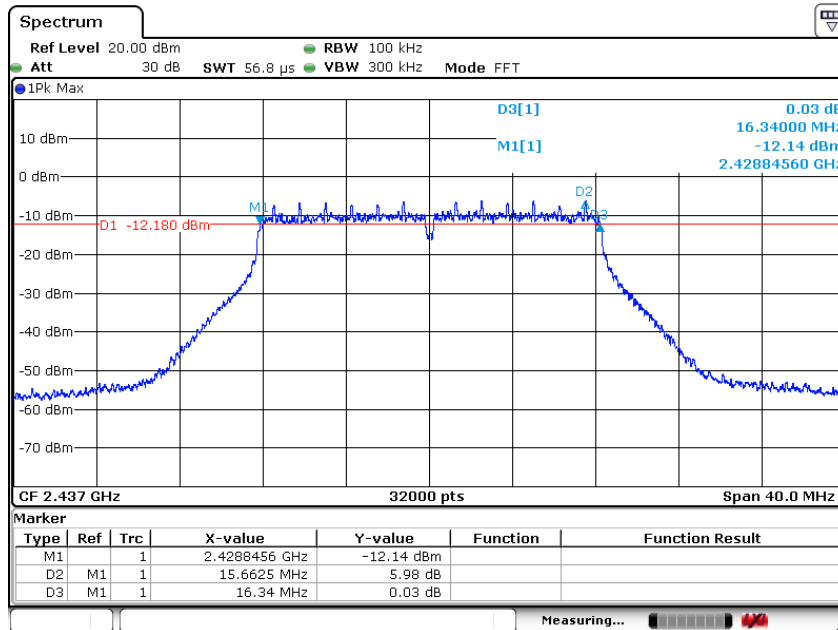

802.11 G Mode CH11

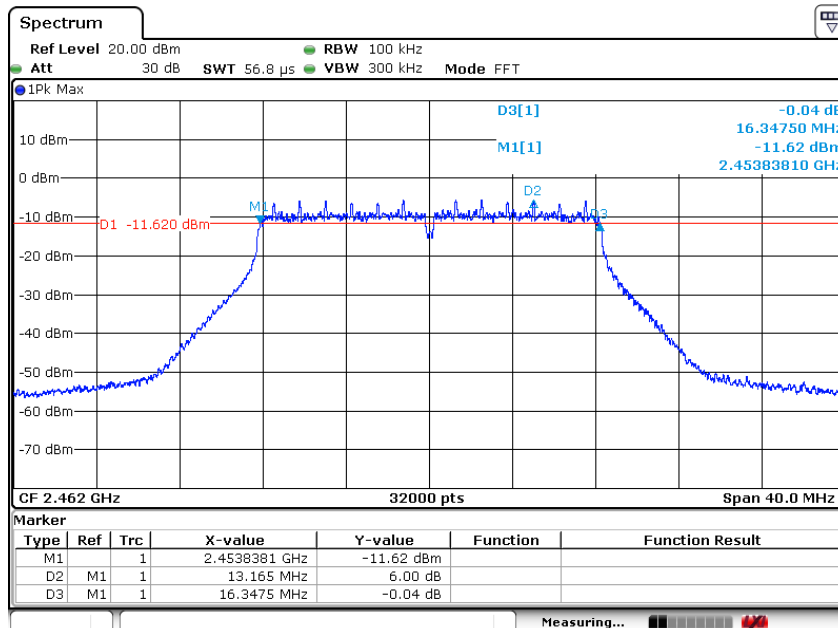

802.11 N20 Mode CH1

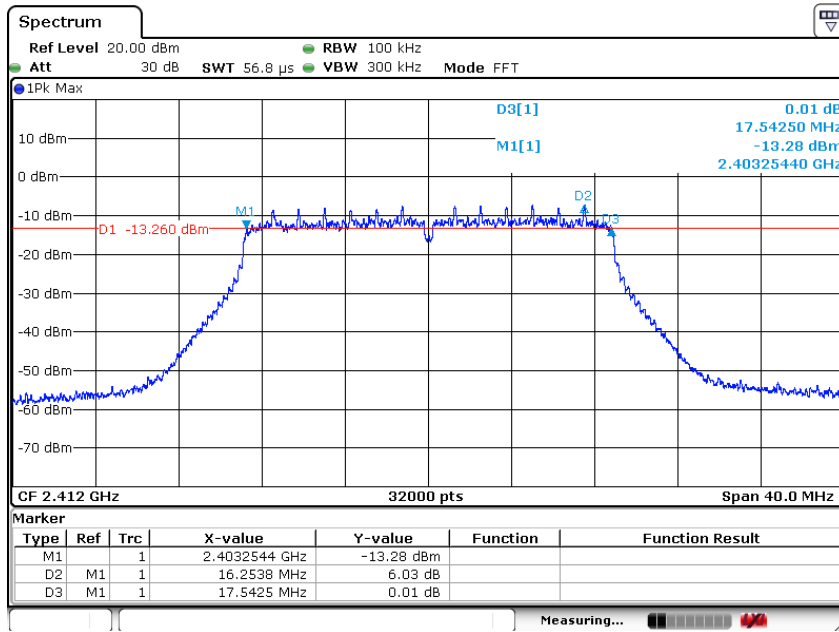

802.11 N20 Mode CH6

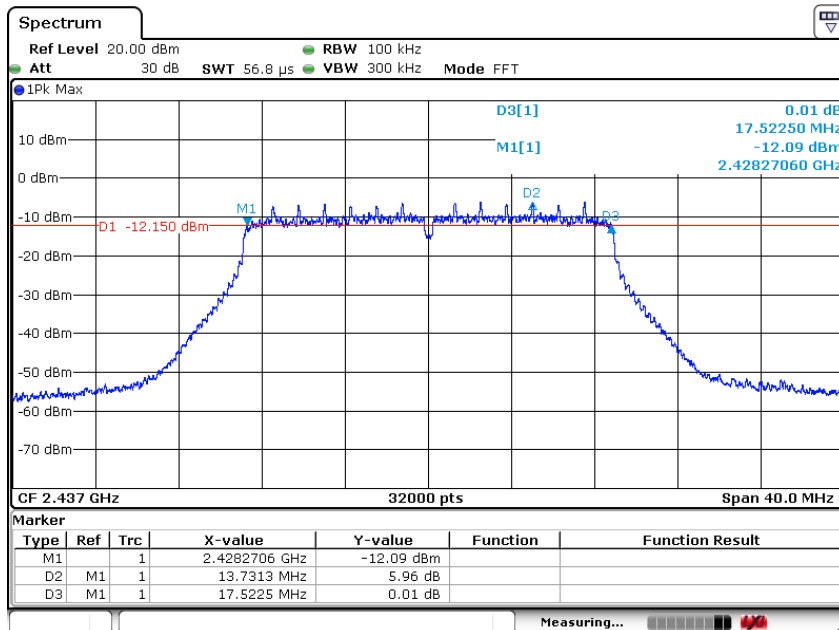

802.11 N20 Mode CH11

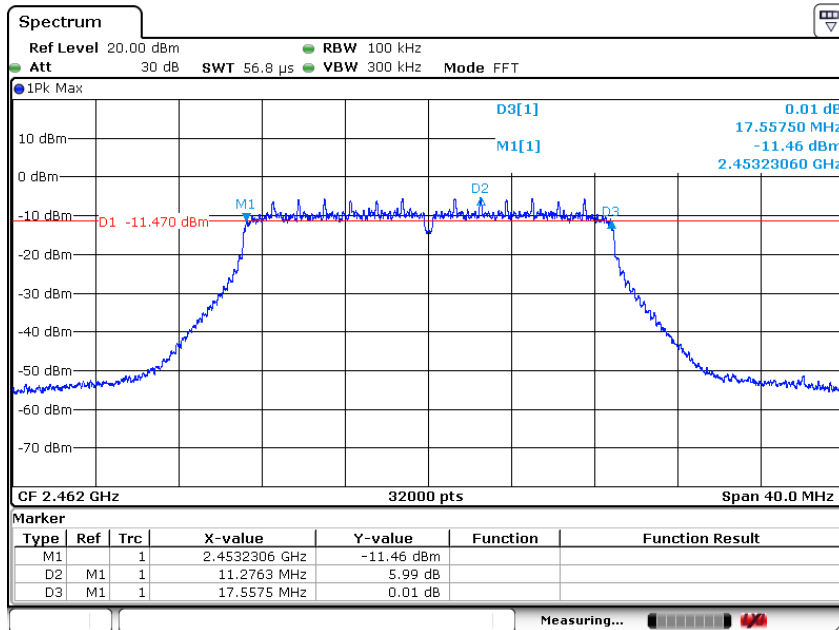

802.11 N40 Mode CH3

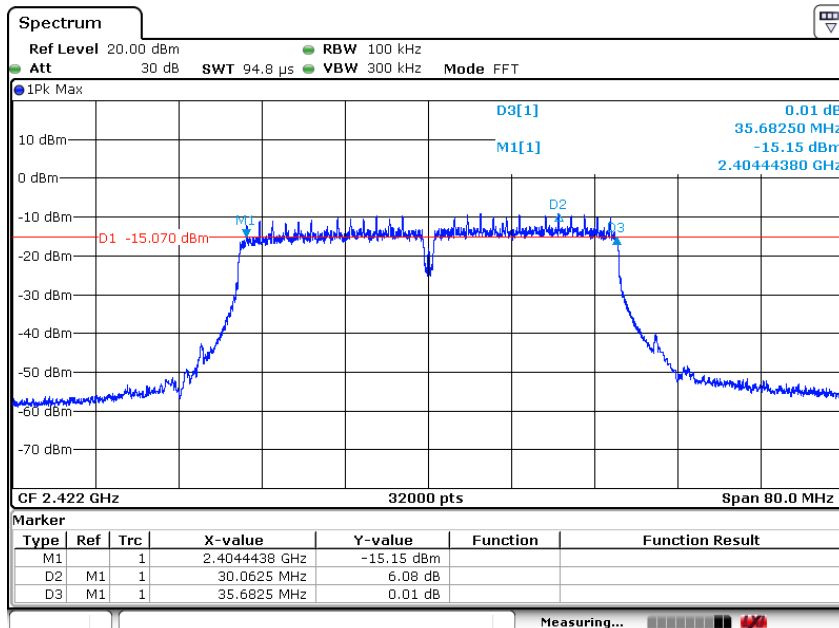

802.11 N40 Mode CH6

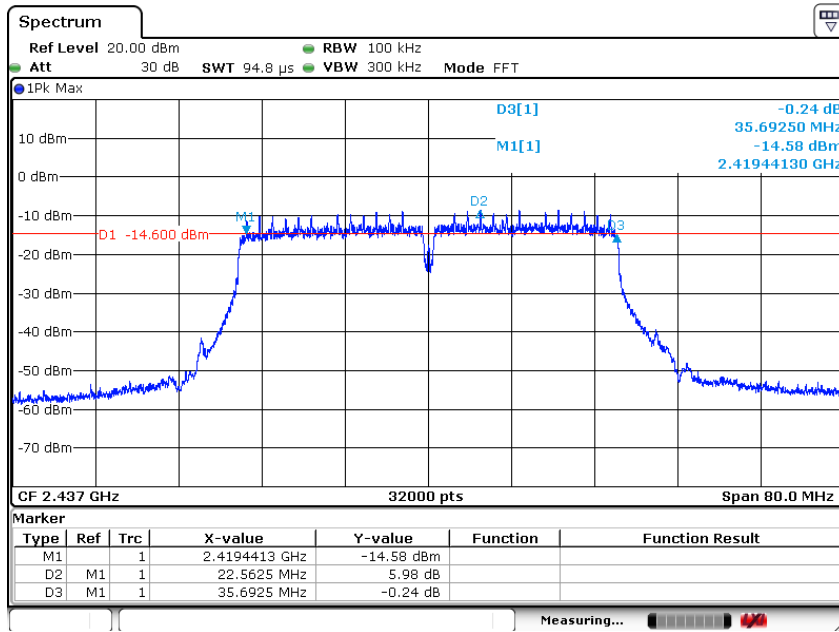

802.11 N40 Mode CH9

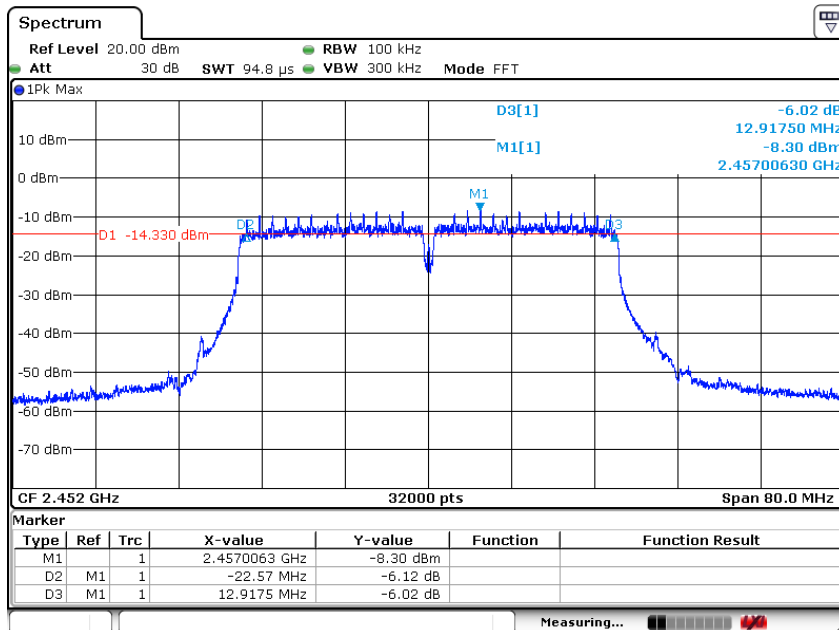

4. Maximum Peak Output Power

4.1. Test equipment

Item	Equipment	Manufacturer	Model No.	Serial No.	Calibrated until	Calibrated Date
1	Power meter	Agilent	E4417A	MY45100473	05/26/2019	05/27/2018
2	Wireband Power sensor	Agilent	E4427A	MY5100041	12/17/2018	12/18/2017
3	RF Cable	Micable	C10-01-01-1	100309	12/17/2018	12/18/2017

4.2. Block diagram of test setup

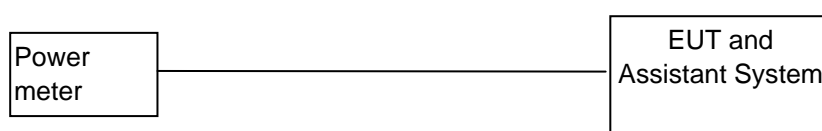

4.3. Limits

For systems using digital modulation in the 902-928 MHz, 2400-2483.5 MHz bands: 1 Watt. If transmitting antennas of directional gain greater than 6 dBi are used, the conducted output power from the intentional radiator shall be reduced below the stated values as appropriate, by the amount in dB that the directional gain of the antenna exceeds 6 dBi.

4.4. Test Procedure

1. Place the EUT on a bench and set it in transmitting mode.
2. A wide band power meter with a matched thermocouple detector was used to directly measure the output power from the RF output port of the EUT in continuously transmitting mode.
3. The measurement shall be repeated at the lowest, the middle, and the highest channel of the stated frequency range.

4.5. TEST RESULT

EUT Set Mode	CH	Result(dBm)	Total Power (dBm)	Limit	Conclusion
		Peak			
IEEE 802.11B	CH 1	14.51	/	30dBm	PASS
	CH 6	14.06	/	30dBm	PASS
	CH 11	14.32	/	30dBm	PASS
IEEE 802.11G	CH 1	13.54	/	30dBm	PASS
	CH 6	13.15	/	30dBm	PASS
	CH 11	13.22	/	30dBm	PASS
IEEE 802.11N20	CH 1	13.64	/	30dBm	PASS
	CH 6	13.28	/	30dBm	PASS
	CH 11	13.32	/	30dBm	PASS
IEEE 802.11N40	CH 3	13.84	/	30dBm	PASS
	CH 6	13.26	/	30dBm	PASS
	CH 9	13.47	/	30dBm	PASS

5. Power Spectral Density

5.1. Test equipment

Item	Equipment	Manufacturer	Model No.	Serial No.	Calibrated until	Calibrated Date
1	Spectrum analyzer	KEYSIGHT	N9010A	MY55150427	05/26/2019	05/27/2018
2	Attenuator	Mini-Circuits	BW-S10W2	101109	12/17/2018	12/18/2017
3	RF Cable	Micable	C10-01-01-1	100309	12/17/2018	12/18/2017
4	Spectrum analyzer	R&S	FSV40	101470	06/29/2019	06/28/2018

5.2. Block diagram of test setup

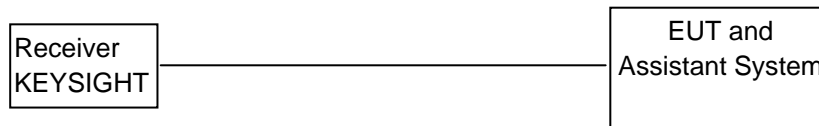

5.3. Limits

For digitally modulated systems, the power spectral density conducted from the intentional radiator to the antenna shall not be greater than 8dBm in any 3 kHz band during any time interval of continuous transmission.

5.4. TEST PROCEDURE

1. Check the calibration of the measuring instrument using either an internal calibrator or a known signal from an external generatorl.
2. Position the EUT was set without connection to measurement instrument. Turn on the EUT and connect its antenna terminal to measurement instrument via a low loss cable. Then set it to any one measured frequency within its operating range, and make sure the instrument is operated in its linear range
3. According to KDB 558074 D01 DTS Meas Guidance v05, set the RBW = 3 kHz, VBW = 10 kHz, Set the span to 1.5 times the DTS channel bandwidth.
4. Use the peak marker function to determine the maximum power level in any 3 kHz band segment within the fundamental EBW

5.5. Test Result

EUT Set Mode	CH	Result(dBm)	Total (dBm)	Limit (dBm/3 kHz)	Conclusion
IEEE 802.11B	CH 1	-11.01	/	8	PASS
	CH 6	-10.79	/	8	PASS
	CH 11	-9.92	/	8	PASS
IEEE 802.11G	CH 1	-21.38	/	8	PASS
	CH 6	-20.15	/	8	PASS
	CH 11	-19.31	/	8	PASS
IEEE 802.11N20	CH 1	-21.06	/	8	PASS
	CH 6	-19.98	/	8	PASS
	CH 11	-19.51	/	8	PASS
IEEE 802.11N40	CH 1	-21.62	/	8	PASS
	CH 6	-21.10	/	8	PASS
	CH 11	-20.66	/	8	PASS

5.6. Original test data

802.11 B Mode CH1

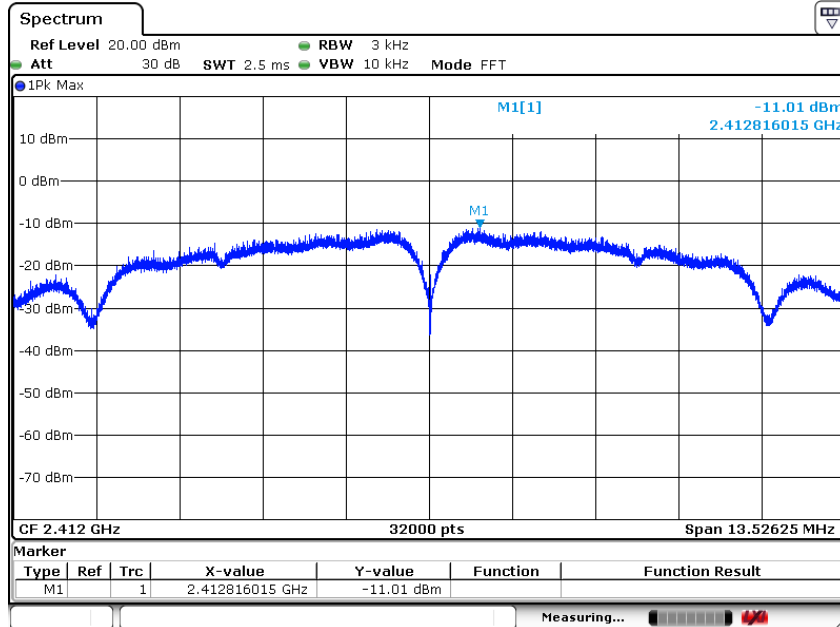

802.11 B Mode CH6

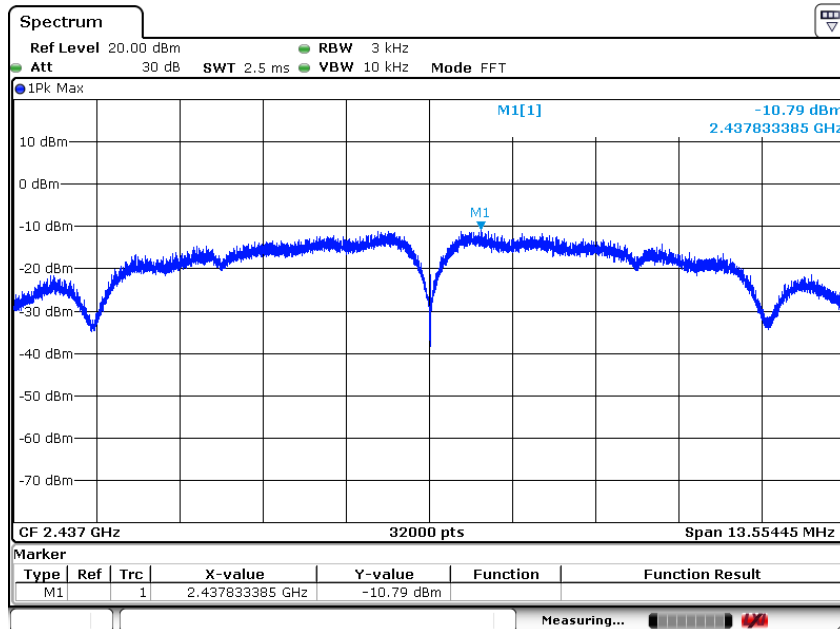

802.11 B Mode CH11

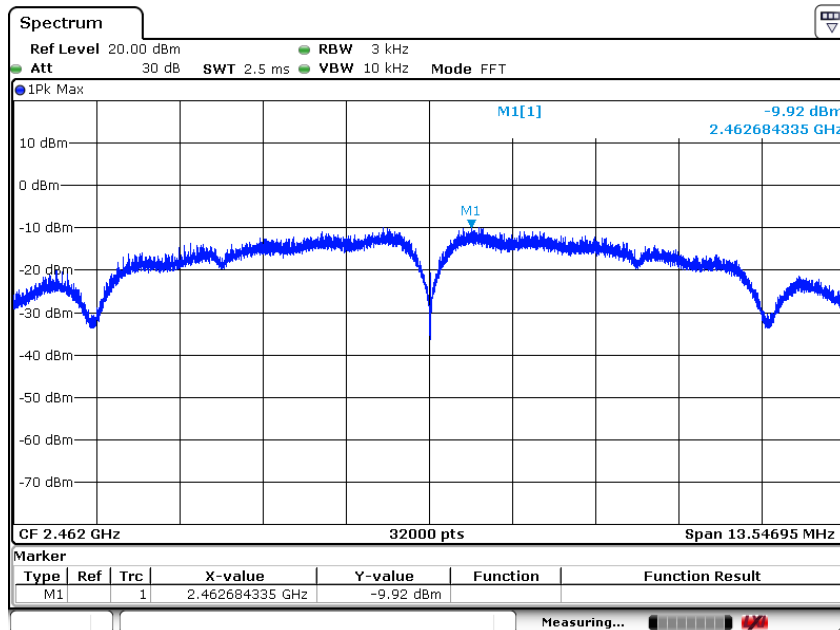

802.11 G Mode CH1

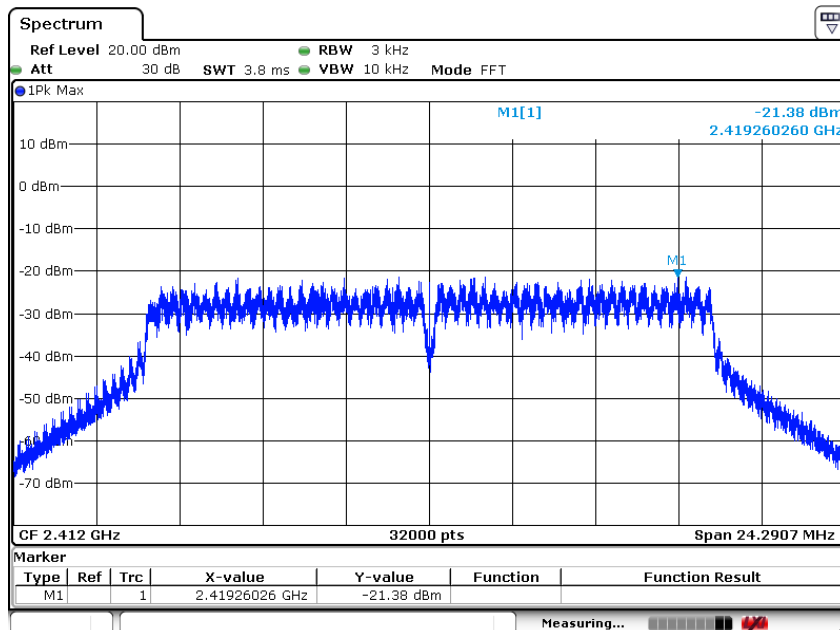

802.11 G Mode CH6

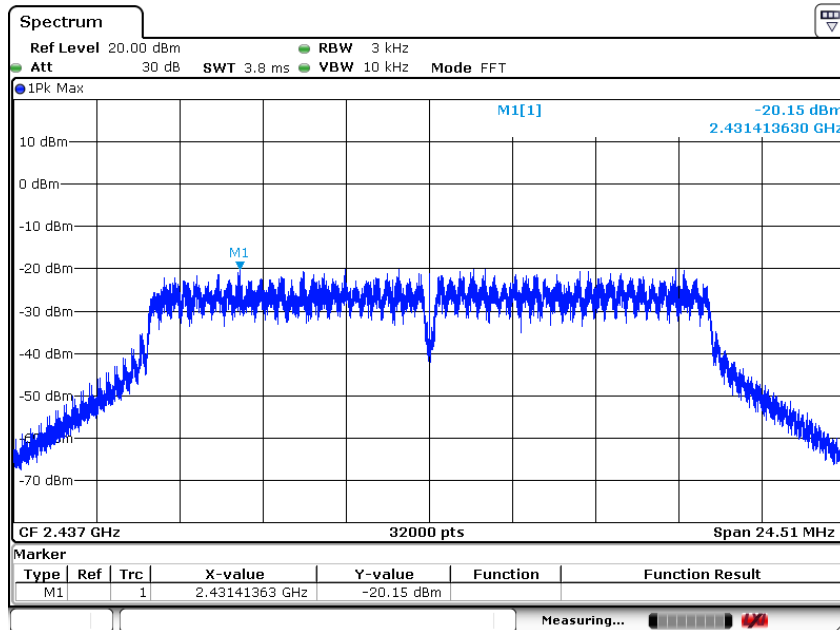

802.11 G Mode CH11

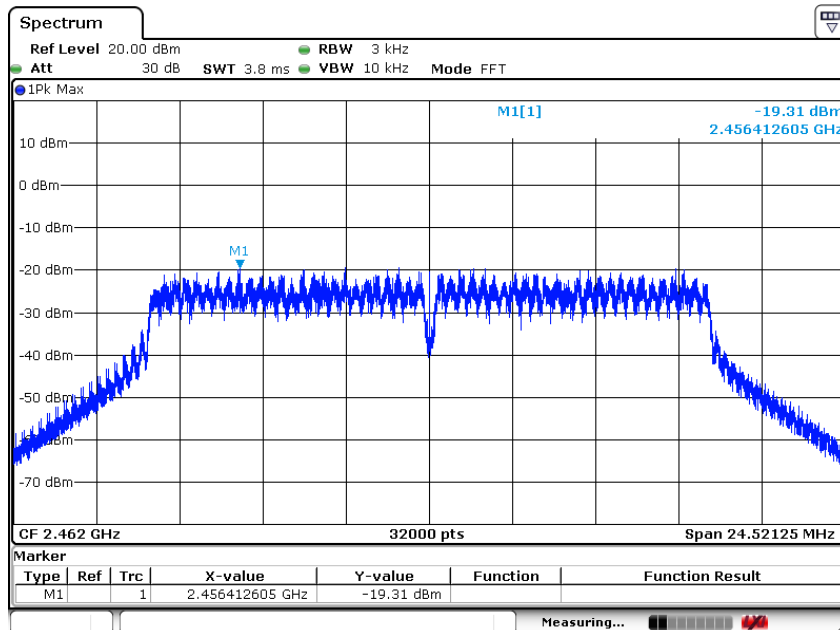

802.11 N20 Mode CH1

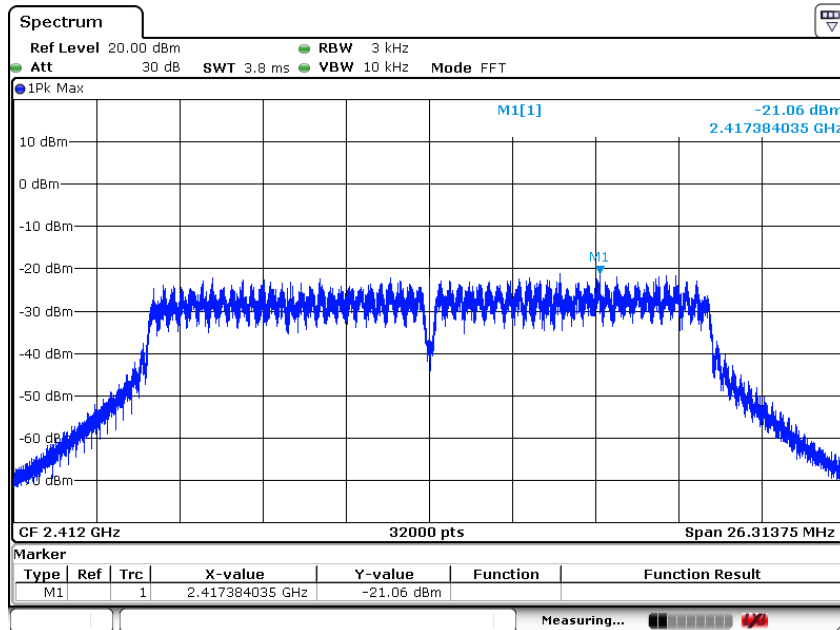

802.11 N20 Mode CH6

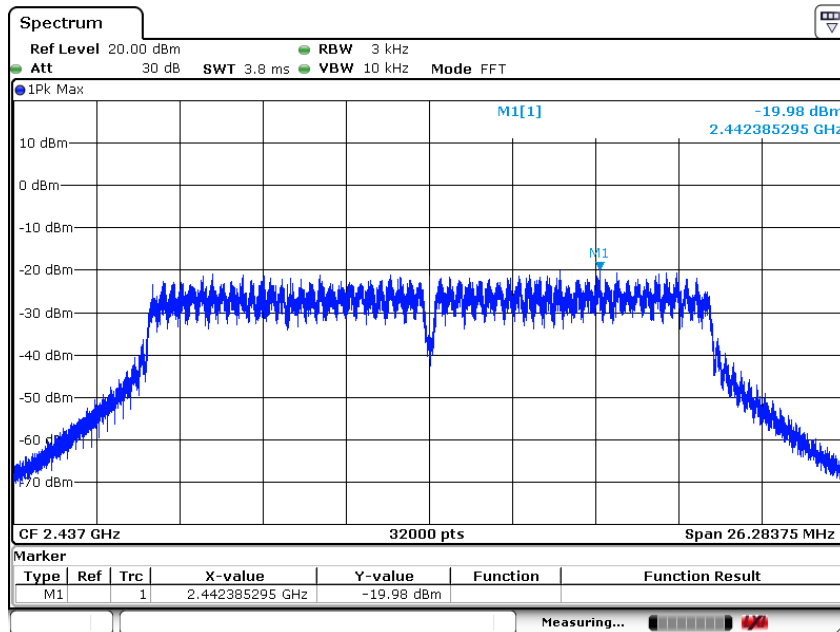

802.11 N20 Mode CH11

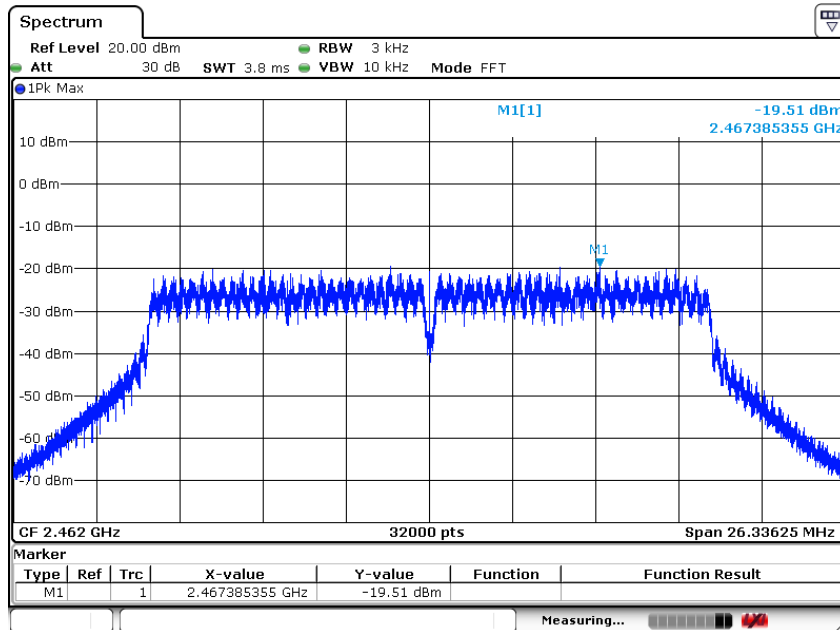

802.11 N40 Mode CH3

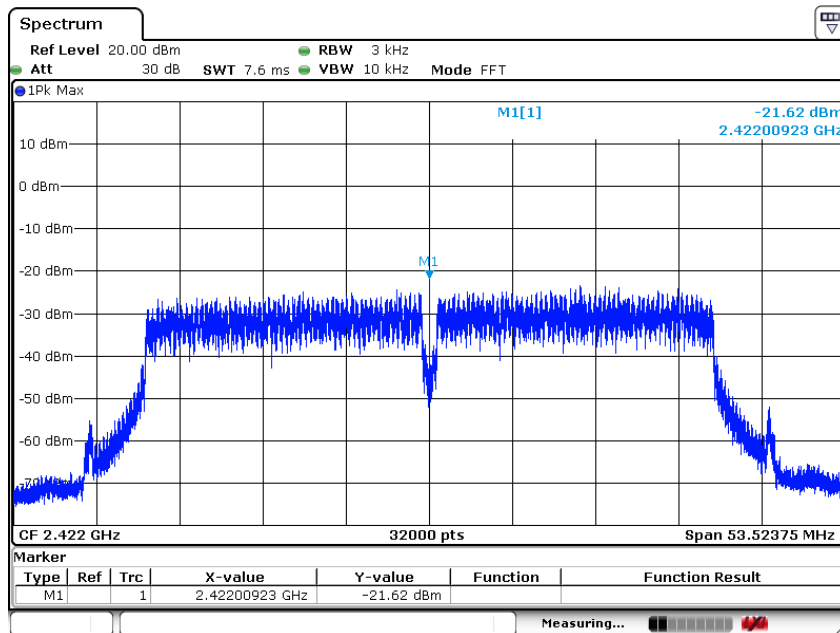

802.11 N40 Mode CH6

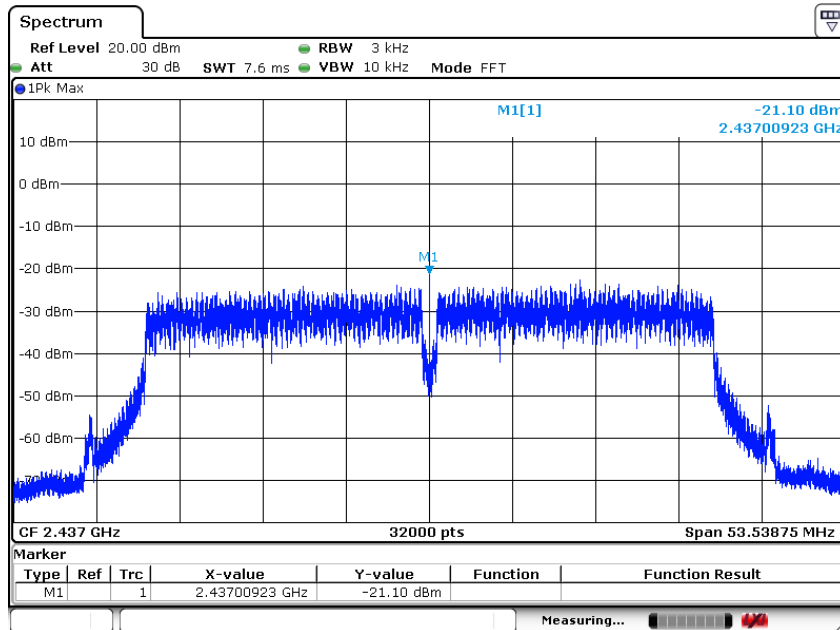

802.11 N40 Mode CH9

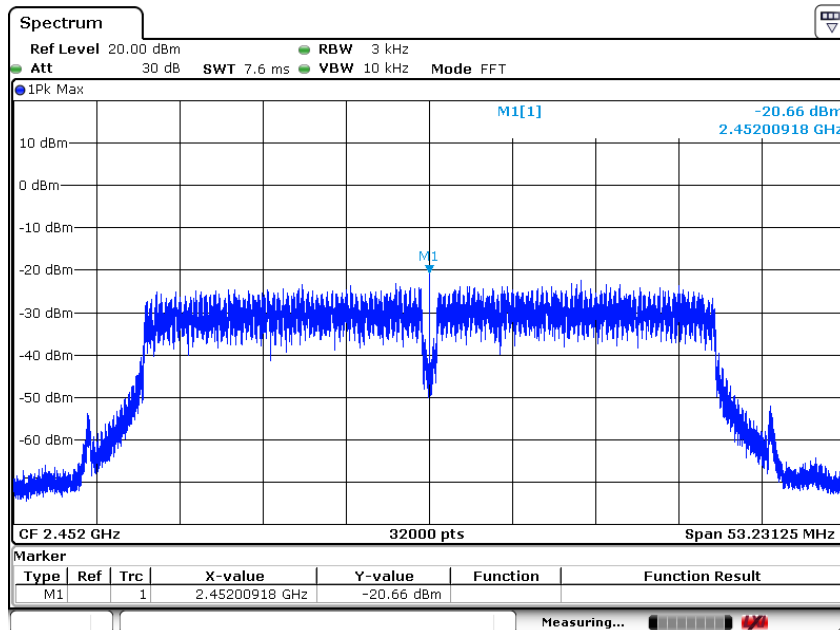

6. Spurious Emissions

6.1. Test equipment

Item	Equipment	Manufacturer	Model No.	Serial No.	Calibrated until	Calibrated Date
1	EMI Test Receiver	R&S	ESCI	101307	12/17/2018	12/18/2017
2	Spectrum analyzer	Agilent	E4407B	US40240708	07/04/2019	07/05/2018
3	Trilog Broadband Antenna	Schwarzbeck	VULB9168	VULB9168-192	03/04/2019	03/05/2018
4	Double Ridged Horn Antenna	SCHWARZBEC K	BBHA 9120D1065	100276	12/17/2018	12/18/2017
5	Double Ridged Horn Antenna	SCHWARZBEC K	BBHA 9120D1065	100546	12/17/2018	12/18/2017
6	Dipole antenna	Schwarzbeck	UHAP	1101	12/17/2018	12/18/2017
7	Dipole antenna	Schwarzbeck	VHAP	1118	12/17/2018	12/18/2017
8	Pre-Amplifier	CY	EMC011830	980136	12/17/2018	12/18/2017
9	Pre-amplifier	HP	8447F	3113A05680	12/17/2018	12/18/2017
10	RF Cable	R&S	R01	10403	12/17/2018	12/18/2017
11	RF Cable	R&S	R02	10512	12/17/2018	12/18/2017
12	RF Cable	R&S	R01	10454	12/17/2018	12/18/2017
13	RF Cable	R&S	R02	10343	12/17/2018	12/18/2017
14	6 dB Attenuator	EMEC	ATT6000-6-N N	N/A	11/21/2018	11/22/2017
15	Turn Table	UC	UC3000	N/A	N/A	N/A
16	Antenna Mast	UC	UC3000	N/A	N/A	N/A
17	Measurement Software	Farad	EZ-EMC (Ver.ATT-03 A)	N/A	N/A	N/A

6.2. Block diagram of test setup

In 3m Anechoic Chamber Test Setup Diagram for below 1GHz

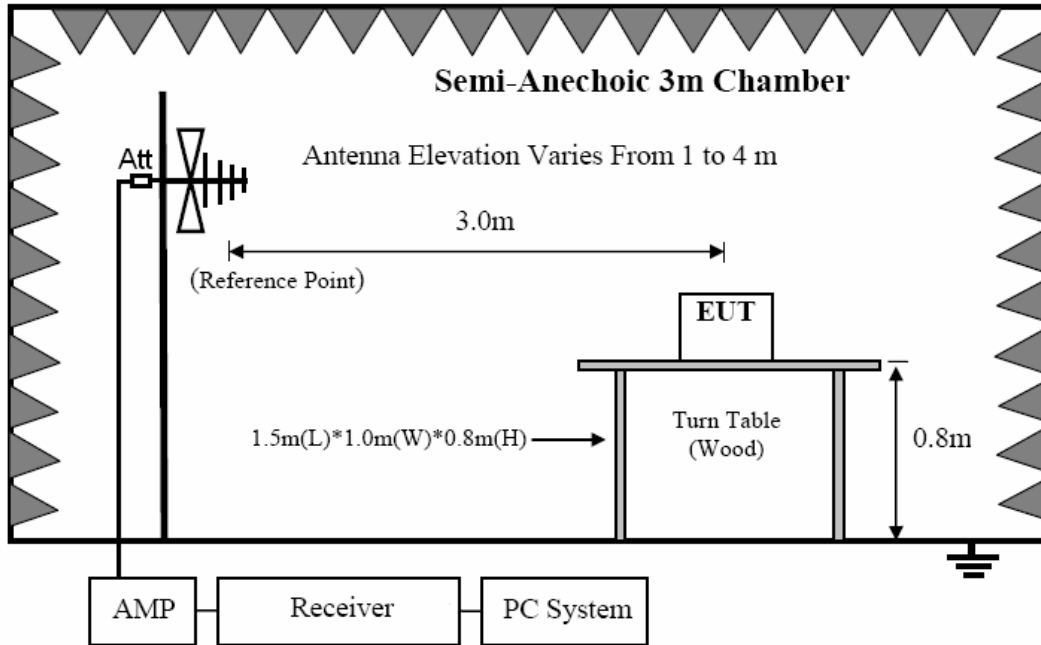

In 3m Anechoic Chamber Test Setup Diagram for frequency above 1GHz

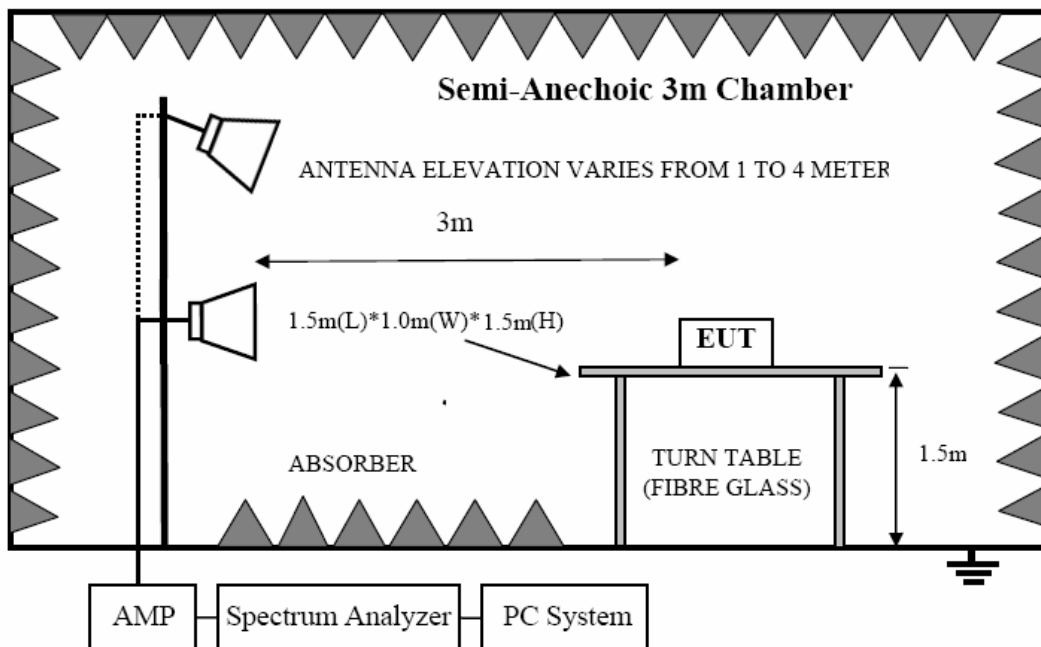

Note: For harmonic emissions test a appropriate high pass filter was inserted in the input port of AMP.

6.3. Limit

6.3.1 FCC 15.205 Restricted frequency band

MHz	MHz	MHz	GHz
0.090 - 0.110	16.42 - 16.423	399.9 - 410	4.5 - 5.15
¹ 0.495 - 0.505	16.69475 - 16.69525	608 - 614	5.35 - 5.46
2.1735 - 2.1905	16.80425 - 16.80475	960 - 1240	7.25 - 7.75
4.125 - 4.128	25.5 - 25.67	1300 - 1427	8.025 - 8.5
4.17725 - 4.17775	37.5 - 38.25	1435 - 1626.5	9.0 - 9.2
4.20725 - 4.20775	73 - 74.6	1645.5 - 1646.5	9.3 - 9.5
6.215 - 6.218	74.8 - 75.2	1660 - 1710	10.6 - 12.7
6.26775 - 6.26825	108 - 121.94	1718.8 - 1722.2	13.25 - 13.4
6.31175 - 6.31225	123 - 138	2200 - 2300	14.47 - 14.5
8.291 - 8.294	149.9 - 150.05	2310 - 2390	15.35 - 16.2
8.362 - 8.366	156.52475 - 156.52525	2483.5 - 2500	17.7 - 21.4
8.37625 - 8.38675	156.7 - 156.9	2690 - 2900	22.01 - 23.12
8.41425 - 8.41475	162.0125 - 167.17	3260 - 3267	23.6 - 24.0
12.29 - 12.293	167.72 - 173.2	3332 - 3339	31.2 - 31.8
12.51975 - 12.52025	240 - 285	3345.8 - 3358	36.43 - 36.5
12.57675 - 12.57725	322 - 335.4	3600 - 4400	(²)

6.3.2 FCC 15.209 Limit

FREQUENCY MHz	DISTANCE Meters	FIELD STRENGTHS LIMIT	
		$\mu\text{V}/\text{m}$	$\text{dB}(\mu\text{V})/\text{m}$
30 ~ 88	3	100	40.0
88 ~ 216	3	150	43.5
216 ~ 960	3	200	46.0
960 ~ 1000	3	500	54.0
Above 1000	3	74.0 $\text{dB}(\mu\text{V})/\text{m}$ (Peak) 54.0 $\text{dB}(\mu\text{V})/\text{m}$ (Average)	

6.3.3 Limit for this EUT

The radiated emission tests were performed in the 3 meters test site, using the setup accordance with the

ANSI C63.10:2013. The specification used was the FCC 15.209, and FCC 15.247 limits.

6.4. TEST PROCEDURE

- (1) EUT was placed on a non-metallic table, 80 cm above the ground plane inside a semi-anechoic chamber.
- (2) Setup EUT and assistant system according clause 2.4 and 8.2
- (3) Test antenna was located 3m from the EUT on an adjustable mast. Below pre-scan procedure was first performed in order to find prominent radiated emissions.
 - (a) Change work frequency or channel of device if practicable.
 - (b) Change modulation type of device if practicable.
 - (c) Change power supply range from 85% to 115% of the rated supply voltage
 - (d) Rotated EUT though three orthogonal axes to determine the attitude of EUT arrangement produces highest emissions
- (4) Spectrum frequency from 9MHz to 25GHz (tenth harmonic of fundamental frequency) was investigated, and no any obvious emission were detected from 9KHz to 30MHz and 18GHz to 25GHz, so below final test was performed with frequency range from 30MHz to 18GHz.
- (5) For final emissions measurements at each frequency of interest, the EUT were rotated and the antenna height was varied between 1m and 4m in order to maximize the emission. Measurements in both horizontal and vertical polarities were made and the data was recorded. In order to find the maximum emission, the relative positions of equipments and all of the interface cables were changed according to ANSI C63.10 2013 on Radiated Emission test.
- (6) For emissions from 30MHz to 1GHz, Quasi-Peak values were measured with EMI Receiver and the bandwidth of Receiver is 120 KHz.
- (7) For emissions above 1GHz, both Peak and Average level were measured with Spectrum Analyzer, and the RBW is set at 1MHz, VBW is set at 3MHz for Peak measure, Detector is at PK; RBW is set at 1MHz, VBW is set at 3MHz for Average measure, Detector is at RMS..

Note: The worst data is Antenna A, only shown Antenna A Plot.

6.5. TEST RESULT

Below 30M

EUT:	TrekStor SurfTab theatre K13	Model No.:	TFMTKAW01216
Temperature:	24°C	Relative Humidity:	55%
Distance:	3m	Test Power:	120V/60Hz
Polarization:	--	Test Result:	Pass
Test Mode:	Keep TX Mode	Test By:	smile

Freq. (MHz)	Reading (dBuV/m)	Limit (dBuV/m)	Margin (dB)	State P/F
--	--	--	--	P
--	--	--	--	P

Note:

The amplitude of spurious emissions which are attenuated by more than 20dB below the permissible value has no need to be reported.

Distance extrapolation factor = $20 \log(\text{specific distance}/\text{test distance})$ (dB);

Limit line = specific limits(dBuv) + distance extrapolation factor

Between 30M – 1000 MHz

EUT:	TrekStor SurfTab theatre K13	Model No.:	TFMTKAW01216
Temperature:	24	Relative Humidity:	55%
Distance:	3m	Test Power:	120V/60Hz
Polarization:	Vertical	Test Result:	Pass
Standard:	(RE)FCC PART 15 class B 3m	Test By:	smile
Test Mode:	Keep TX Mode		

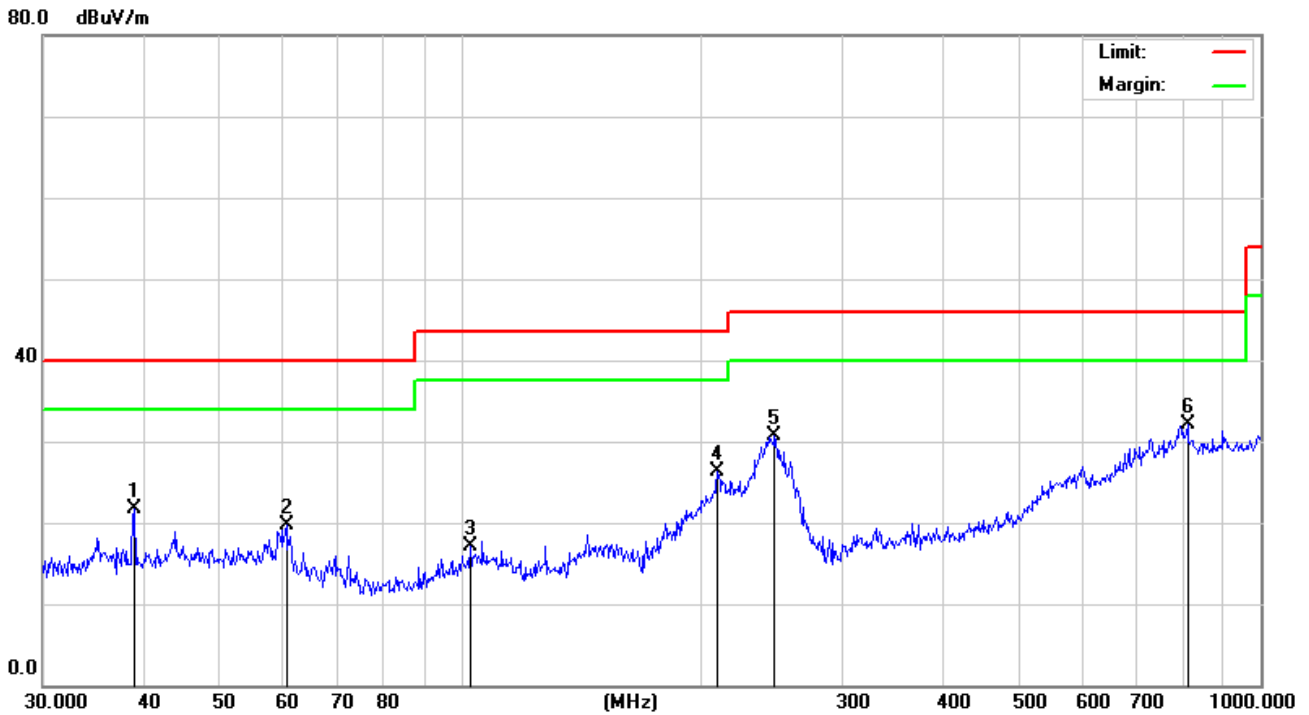

No.	Mk.	Freq. MHz	Reading Level dBuV	Correct Factor dB	Measure- ment dBuV/m	Limit dBuV/m	Over dB	Detector
1		39.0245	27.99	-6.32	21.67	40.00	-18.33	QP
2		60.4919	27.35	-7.58	19.77	40.00	-20.23	QP
3		102.7192	25.23	-8.18	17.05	43.50	-26.45	QP
4		209.3129	30.25	-3.96	26.29	43.50	-17.21	QP
5		246.8149	38.13	-7.38	30.75	46.00	-15.25	QP
6	*	810.2654	24.71	7.45	32.16	46.00	-13.84	QP

The test result is calculated as the following:

- (1) Result = Reading + Correct Factor
- (2) Correct Factor = Antenna Factor + Cable Loss – Amplifier Gain + Attenuator
- (3) Margin = Result - Limit

EUT:	TrekStor SurfTab theatre K13	Model No.:	TFMTKAW01216
Temperature:	24	Relative Humidity:	55%
Distance:	3m	Test Power:	120V/60Hz
Polarization:	Horizontal	Test Result:	Pass
Standard:	(RE)FCC PART 15 class B 3m	Test By:	smile
Test Mode:	Keep TX Mode		

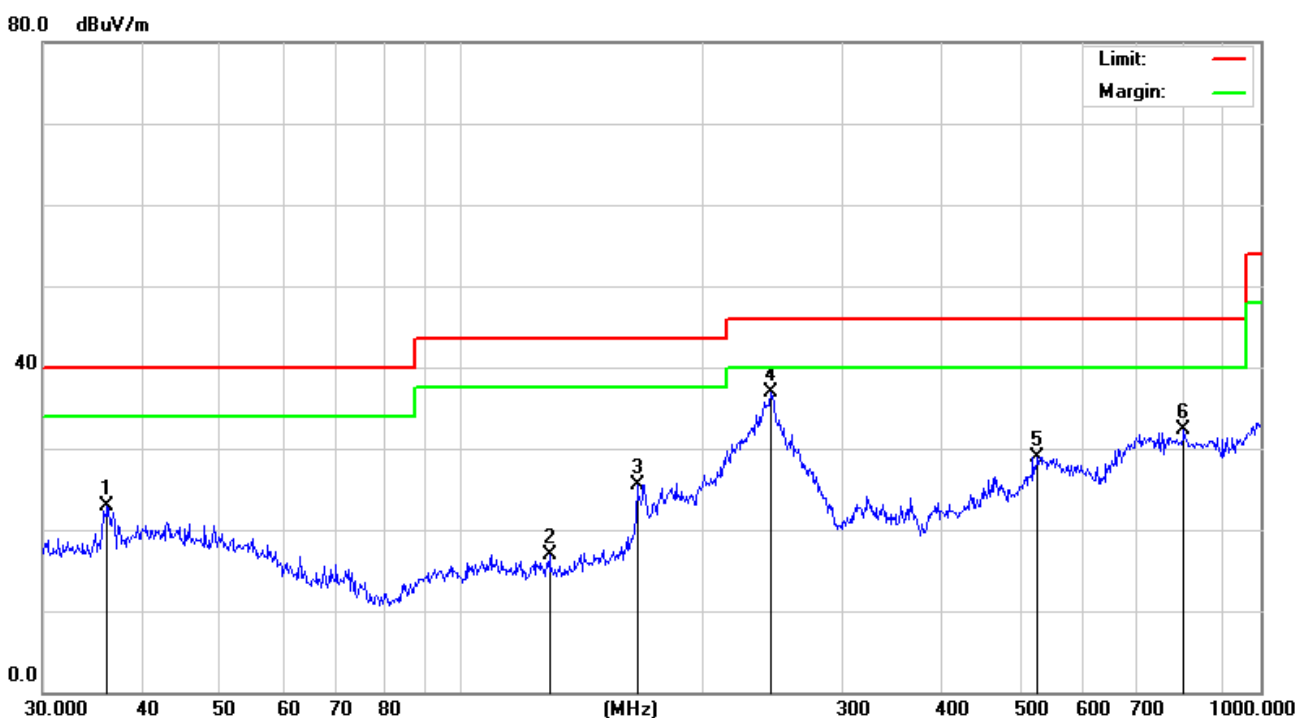

No.	Mk.	Freq.	Reading Level	Correct Factor	Measurement	Limit	Over	
		MHz	dBuV	dB	dBuV/m	dBuV/m	dB	Detector
1		36.1272	26.38	-3.41	22.97	40.00	-17.03	QP
2		129.0146	24.73	-7.86	16.87	43.50	-26.63	QP
3		166.0680	33.04	-7.49	25.55	43.50	-17.95	QP
4	*	244.2321	43.36	-6.49	36.87	46.00	-9.13	QP
5		526.3967	25.34	3.65	28.99	46.00	-17.01	QP
6		801.7863	24.98	7.27	32.25	46.00	-13.75	QP

The test result is calculated as the following:

- (1) Result = Reading + Correct Factor
- (2) Correct Factor = Antenna Factor + Cable Loss – Amplifier Gain + Attenuator
- (3) Margin = Result - Limit

Between 1000M – 25000 MHz

Test Site	: 3m Chamber		
EUT	: TrekStor SurfTab theatre K13	Tested By	: Smile
Power Supply	: 3.8 Vdc	Model Number	: TFMTKAW01216
Condition	: Temp:24.5°C,Humi:55%, Press:100.1kPa	Test Mode	: Tx mode
Memo	: 802.11B	Antenna/Distance	:

Frequency (MHz)	Receiver		Rx Antenna		Corrected Amplitude (dB μ V/m)	FCC 15.247	
	Reading (dB μ V)	Detector (PK/QP/AV)	Polar (H/V)	Factor (dB)		Limit (dB μ V/m)	Margin (dB)
Low Channel (2412)							
2390	42.23	PK	H	-5.79	36.44	74	-37.56
2390	30.20	AV	H	-5.79	24.41	54	-29.59
2390	42.29	PK	V	-5.79	36.5	74	-37.50
2390	30.13	AV	V	-5.79	24.34	54	-29.66
4824	41.96	PK	H	5.08	47.04	74	-26.96
4824	29.51	AV	H	5.08	34.59	54	-19.41
4824	43.02	PK	V	5.08	48.1	74	-25.90
4824	30.03	AV	V	5.08	35.11	54	-18.89
Middle Channel (2437)							
4874	42.23	PK	H	5.73	47.96	74	-26.04
4874	30.03	AV	H	5.73	35.76	54	-18.24
4874	42.03	PK	V	5.73	47.76	74	-26.24
4874	30.30	AV	V	5.73	36.03	54	-17.97
High Channel (2462)							
2483.5	40.42	PK	H	-4.98	35.44	74	-38.56
2483.5	30.19	AV	H	-4.98	25.21	54	-28.79
2483.5	41.95	PK	V	-4.98	36.97	74	-37.03
2483.5	30.26	AV	V	-4.98	25.28	54	-28.72
4924	40.26	PK	H	5.18	45.44	74	-28.56
4924	30.18	AV	H	5.18	35.36	54	-18.64
4924	40.73	PK	V	5.18	45.91	74	-28.09
4924	31.18	AV	V	5.18	36.36	54	-17.64

The test result is calculated as the following:

- (1) Corrected Amplitude = Read Level + Antenna Factor + Cable loss - Amplifier Gain
- (2) Margin = Corrected Amplitude - Limit

Test Site	: 3m Chamber		
EUT	: TrekStor SurfTab theatre K13	Tested By	: Smile
Power Supply	: 3.8 Vdc	Model Number	: TFMTKAW01216
Condition	: Temp:24.5°C,Humi:55%, Press:100.1kPa	Test Mode	: Tx mode
Memo	: 802.11G	Antenna/Distance	:

Frequency (MHz)	Receiver		Rx Antenna		Corrected Amplitude (dB μ V/m)	FCC 15.247	
	Reading (dB μ V)	Detector (PK/QP/AV)	Polar (H/V)	Factor (dB)		Limit (dB μ V/m)	Margin (dB)
Low Channel (2412)							
2390	42.58	PK	H	-5.79	36.79	74	-37.21
2390	30.79	AV	H	-5.79	25	54	-29.00
2390	42.69	PK	V	-5.79	36.9	74	-37.10
2390	30.88	AV	V	-5.79	25.09	54	-28.91
4824	41.90	PK	H	5.08	46.98	74	-27.02
4824	30.45	AV	H	5.08	35.53	54	-18.47
4824	42.51	PK	V	5.08	47.59	74	-26.41
4824	30.38	AV	V	5.08	35.46	54	-18.54
Middle Channel (2437)							
4874	42.36	PK	H	5.73	48.09	74	-25.91
4874	31.18	AV	H	5.73	36.91	54	-17.09
4874	42.48	PK	V	5.73	48.21	74	-25.79
4874	30.35	AV	V	5.73	36.08	54	-17.92
High Channel (2462)							
2483.5	40.62	PK	H	-4.98	35.64	74	-38.36
2483.5	30.71	AV	H	-4.98	25.73	54	-28.27
2483.5	41.42	PK	V	-4.98	36.44	74	-37.56
2483.5	30.15	AV	V	-4.98	25.17	54	-28.83
4924	40.23	PK	H	5.18	45.41	74	-28.59
4924	30.21	AV	H	5.18	35.39	54	-18.61
4924	40.57	PK	V	5.18	45.75	74	-28.25
4924	31.42	AV	V	5.18	36.6	54	-17.40

The test result is calculated as the following:

- (1) Corrected Amplitude = Read Level + Antenna Factor + Cable loss - Amplifier Gain
- (2) Margin = Corrected Amplitude - Limit

Test Site	: 3m Chamber		
EUT	: TrekStor SurfTab theatre K13	Tested By	: Smile
Power Supply	: 3.8 Vdc	Model Number	: TFMTKAW01216
Condition	: Temp:24.5°C,Humi:55%, Press:100.1kPa	Test Mode	: Tx mode
Memo	: 802.11N20	Antenna/Distance	:

Frequency (MHz)	Receiver		Rx Antenna		Corrected Amplitude (dBμV/m)	FCC 15.247	
	Reading (dBμV)	Detector (PK/QP/AV)	Polar (H/V)	Factor (dB)		Limit (dBμV/m)	Margin (dB)
Low Channel (2412)							
2390	41.57	PK	H	-5.79	35.78	74	-38.22
2390	31.58	AV	H	-5.79	25.79	54	-28.21
2390	42.42	PK	V	-5.79	36.63	74	-37.37
2390	31.39	AV	V	-5.79	25.6	54	-28.40
4824	42.02	PK	H	5.08	47.1	74	-26.90
4824	30.22	AV	H	5.08	35.3	54	-18.70
4824	41.93	PK	V	5.08	47.01	74	-26.99
4824	30.35	AV	V	5.08	35.43	54	-18.57
Middle Channel (2437)							
4874	41.65	PK	H	5.73	47.38	74	-26.62
4874	30.64	AV	H	5.73	36.37	54	-17.63
4874	42.47	PK	V	5.73	48.2	74	-25.80
4874	30.05	AV	V	5.73	35.78	54	-18.22
High Channel (2462)							
2483.5	40.63	PK	H	-4.98	35.65	74	-38.35
2483.5	30.52	AV	H	-4.98	25.54	54	-28.46
2483.5	41.20	PK	V	-4.98	36.22	74	-37.78
2483.5	29.88	AV	V	-4.98	24.9	54	-29.10
4924	40.07	PK	H	5.18	45.25	74	-28.75
4924	30.44	AV	H	5.18	35.62	54	-18.38
4924	40.64	PK	V	5.18	45.82	74	-28.18
4924	31.01	AV	V	5.18	36.19	54	-17.81

The test result is calculated as the following:

- (1) Corrected Amplitude = Read Level + Antenna Factor + Cable loss - Amplifier Gain
- (2) Margin = Corrected Amplitude - Limit

Test Site	: 3m Chamber		
EUT	: TrekStor SurfTab theatre K13	Tested By	: Smile
Power Supply	: 3.8 Vdc	Model Number	: TFMTKAW01216
Condition	: Temp:24.5°C,Humi:55%, Press:100.1kPa	Test Mode	: Tx mode
Memo	: 802.11N40	Antenna/Distance	:

Frequency (MHz)	Receiver		Rx Antenna		Corrected Amplitude (dBμV/m)	FCC 15.247	
	Reading (dBμV)	Detector (PK/QP/AV)	Polar (H/V)	Factor (dB)		Limit (dBμV/m)	Margin (dB)
Low Channel (2412)							
2390	41.96	PK	H	-5.79	36.17	74	-37.83
2390	30.95	AV	H	-5.79	25.16	54	-28.84
2390	42.85	PK	V	-5.79	37.06	74	-36.94
2390	31.23	AV	V	-5.79	25.44	54	-28.56
4824	42.11	PK	H	5.08	47.19	74	-26.81
4824	30.09	AV	H	5.08	35.17	54	-18.83
4824	40.74	PK	V	5.08	45.82	74	-28.18
4824	30.10	AV	V	5.08	35.18	54	-18.82
Middle Channel (2437)							
4874	41.82	PK	H	5.73	47.55	74	-26.45
4874	30.29	AV	H	5.73	36.02	54	-17.98
4874	42.43	PK	V	5.73	48.16	74	-25.84
4874	29.92	AV	V	5.73	35.65	54	-18.35
High Channel (2462)							
2483.5	40.11	PK	H	-4.98	35.13	74	-38.87
2483.5	30.70	AV	H	-4.98	25.72	54	-28.28
2483.5	41.59	PK	V	-4.98	36.61	74	-37.39
2483.5	30.25	AV	V	-4.98	25.27	54	-28.73
4924	40.63	PK	H	5.18	45.81	74	-28.19
4924	30.07	AV	H	5.18	35.25	54	-18.75
4924	40.28	PK	V	5.18	45.46	74	-28.54
4924	30.00	AV	V	5.18	35.18	54	-18.82

The test result is calculated as the following:

- (1) Corrected Amplitude = Read Level + Antenna Factor + Cable loss - Amplifier Gain
- (2) Margin = Corrected Amplitude - Limit

7. 100 kHz Bandwidth of Frequency Band Edge

7.1. Test equipment

Item	Equipment	Manufacturer	Model No.	Serial No.	Calibrated until	Calibrated Date
1	Spectrum analyzer	KEYSIGHT	N9010A	MY55150427	05/25/2019	05/26/2018
2	Attenuator	Mini-Circuits	BW-S10W2	101109	12/17/2018	12/18/2017
3	RF Cable	Micable	C10-01-01-1	100309	12/17/2018	12/18/2017
4	Spectrum analyzer	R&S	FSV40	101470	06/29/2019	06/28/2018

7.2. Block diagram of test setup

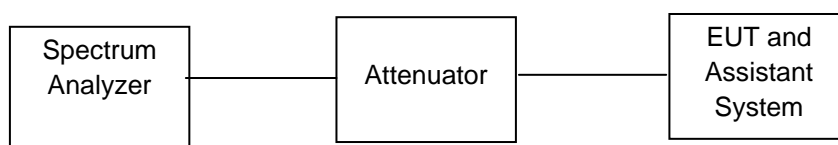

7.3. Limit

In any 100 kHz bandwidth outside the frequency band in which the spread spectrum or digitally modulated intentional radiator is operating, the radio frequency power that is produced by the intentional radiator shall be at least 20 dB below that in the 100 kHz bandwidth within the band that contains the highest level of the desired power, based on either an RF conducted or a radiated measurement, provided the transmitter demonstrates compliance with the peak conducted power limits. If the transmitter complies with the conducted power limits based on the use of RMS averaging over a time interval, as permitted under paragraph (b)(3) of this section, the attenuation required under this paragraph shall be 30 dB instead of 20 dB. Attenuation below the general limits specified in §15.209(a) is not required. In addition, radiated emissions which fall in the restricted bands, as defined in §15.205(a), must also comply with the radiated emission limits specified in §15.209(a) (see §15.205(c)).

7.4. Test Procedure

1. Check the calibration of the measuring instrument using either an internal calibrator or a known signal from an external generator.
2. Remove the antenna from the EUT and then connect to a low loss RF cable from the antenna port to a EMI test receiver, then turn on the EUT and make it operate in transmitting mode. Then set it to Low Channel and High Channel within its operating range, and make sure the instrument is operated in its linear range.
3. Set both RBW and VBW of spectrum analyzer to 100 kHz with a convenient frequency span including 100 kHz bandwidth from band edge.
4. Measure the highest amplitude appearing on spectral display and set it as a reference level. Plot the graph with marking the highest point and edge frequency.
5. Repeat above procedures until all measured frequencies were complete.

7.5. Test result

Frequency Band	Delta Peak to band emission (dBc)	>Limit (dBc)	Result
IEEE 802.11B Mdoe			
2390	51.58	20	Pass
2483.5	60.49	20	Pass
IEEE 802.11G Mdoe			
2390	40.34	20	Pass
2483.5	50.88	20	Pass
IEEE 802.11N20 Mdoe			
2390	39.12	20	Pass
2483.5	51.40	20	Pass
IEEE 802.11N40 Mdoe			
2390	36.02	20	Pass
2483.5	46.19	20	Pass

802.11B Mode

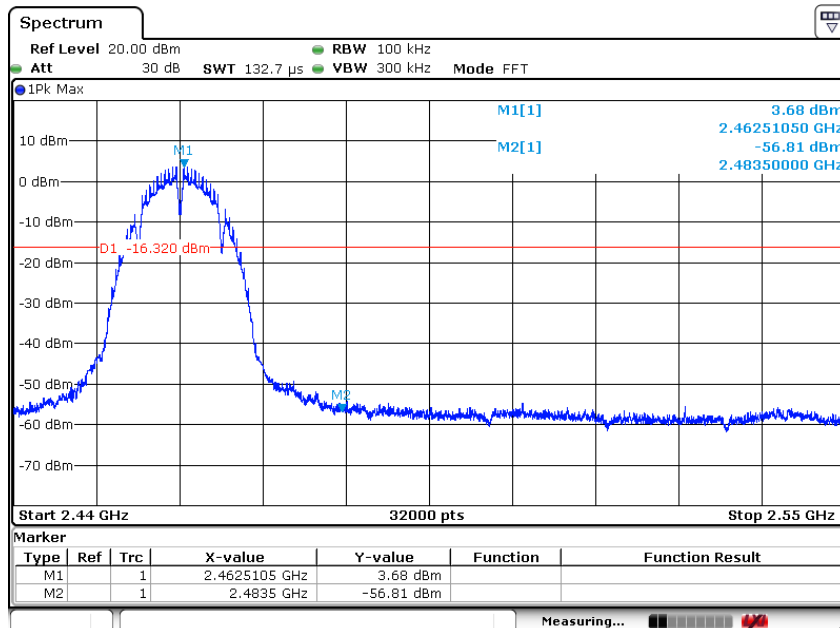
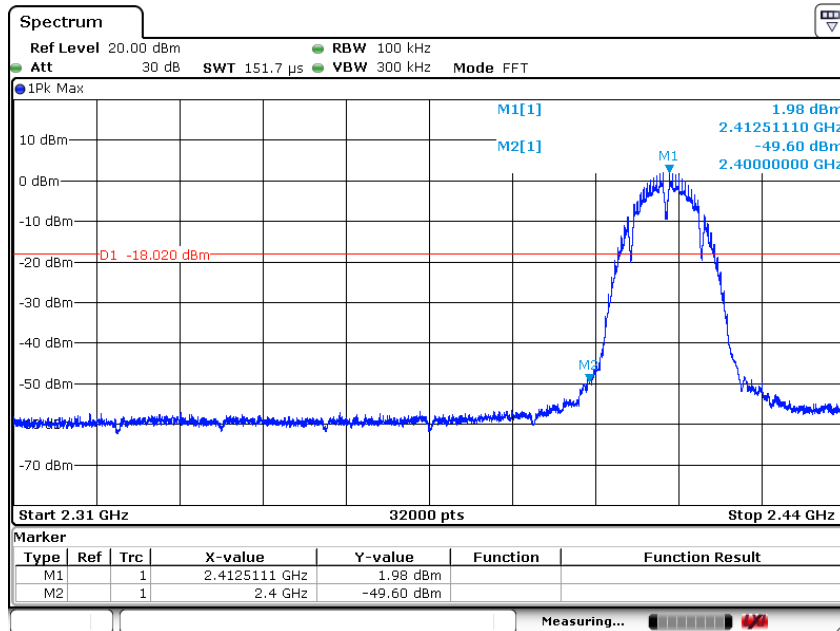

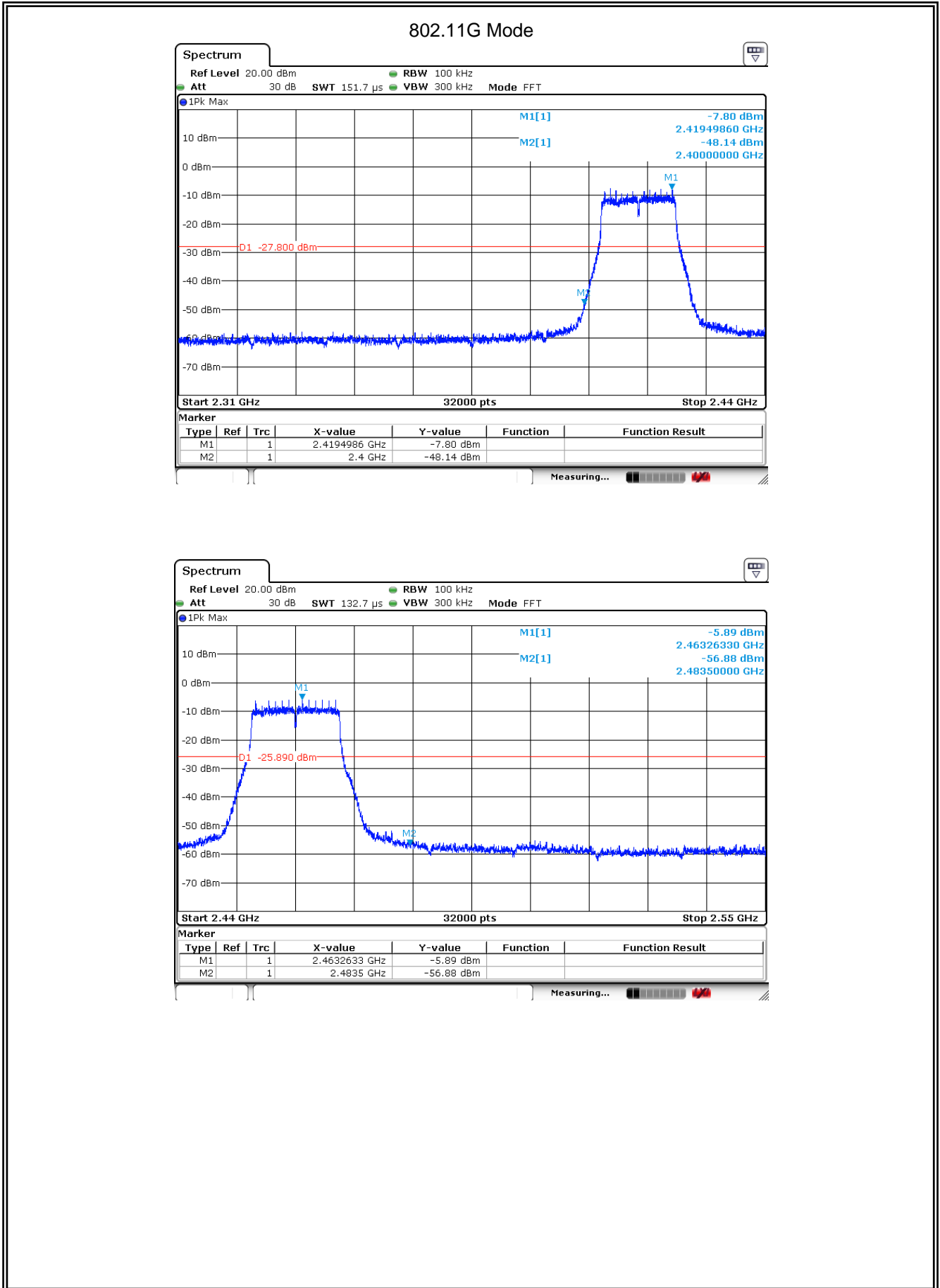

802.11 N20 Mode

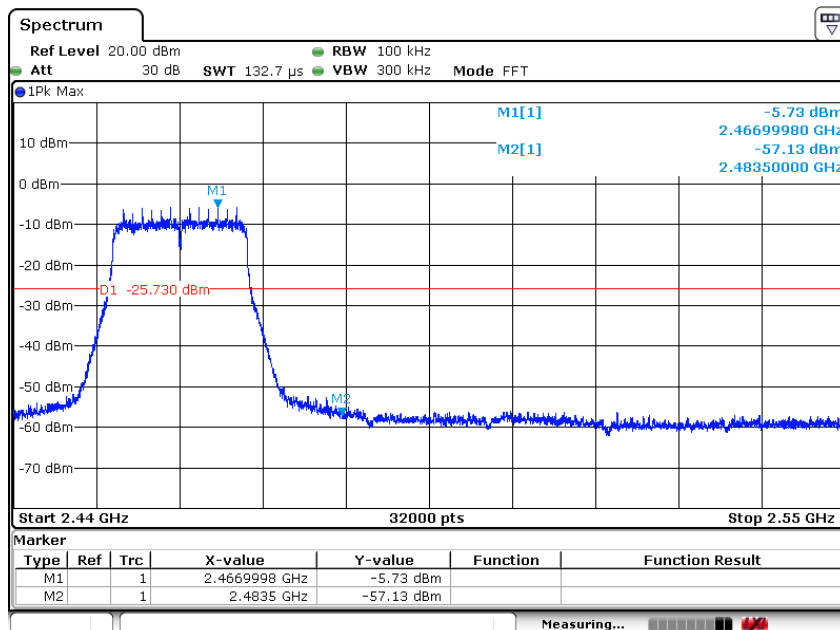
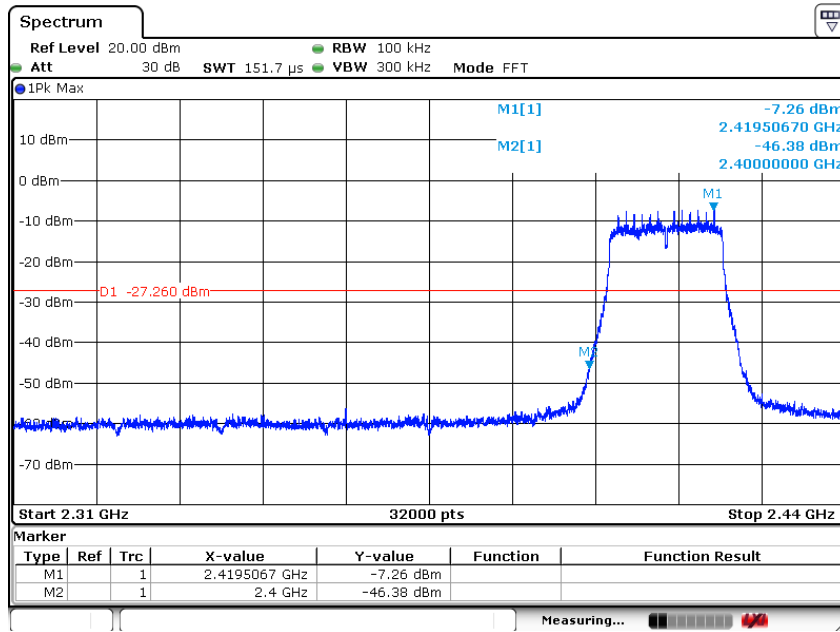

802.11 N40 Mode

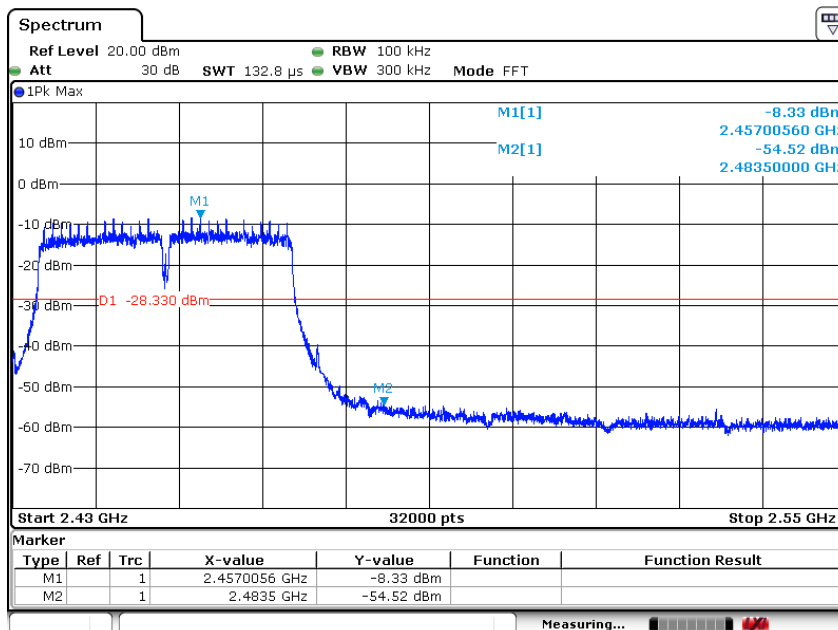
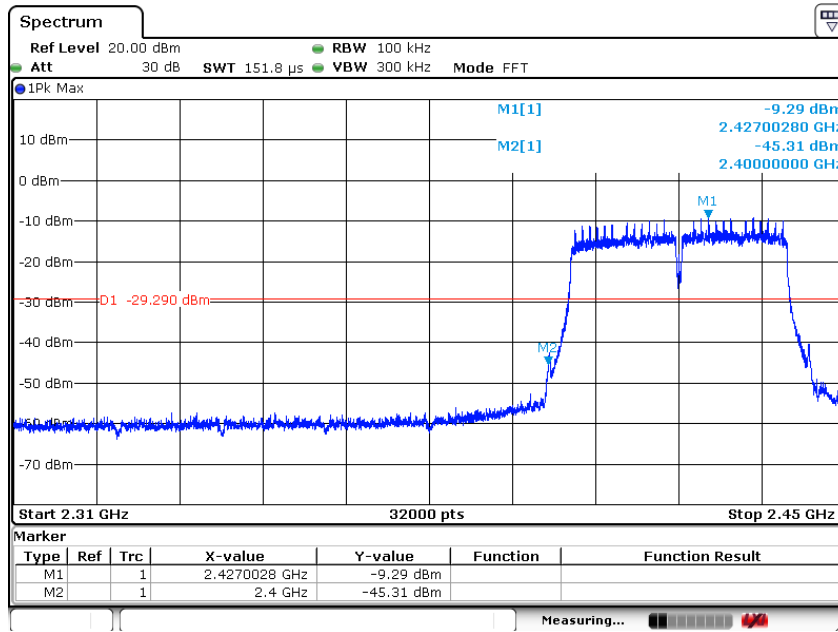

8. Conducted Spurious Emissions

8.1. Test Equipment

Item	Equipment	Manufacturer	Model No.	Serial No.	Calibrated until	Calibrated Date
1	Spectrum analyzer	KEYSIGHT	N9010A	MY55150427	05/26/2019	05/27/2018
2	Attenuator	Mini-Circuits	BW-S10W2	101109	12/17/2018	12/18/2017
3	RF Cable	Micable	C10-01-01-1	100309	12/17/2018	12/18/2017

8.2. Limit

In any 100kHz bandwidth outside the frequency bands in which the spread spectrum intentional radiator is operating, the radio frequency power that is produced by the intentional radiator shall be at least 20dB below that in the 100kHz bandwidth within the band that contains the highest level of the desired power.

8.3. Test Procedure

The transmitter output was connected to a spectrum analyzer, The resolution bandwidth is set to 100 kHz, The video bandwidth is set to 300 kHz and measure all the emissions detected.

8.4. Test result

PASS (See below detailed test result.)

802.11 B Mode CH0

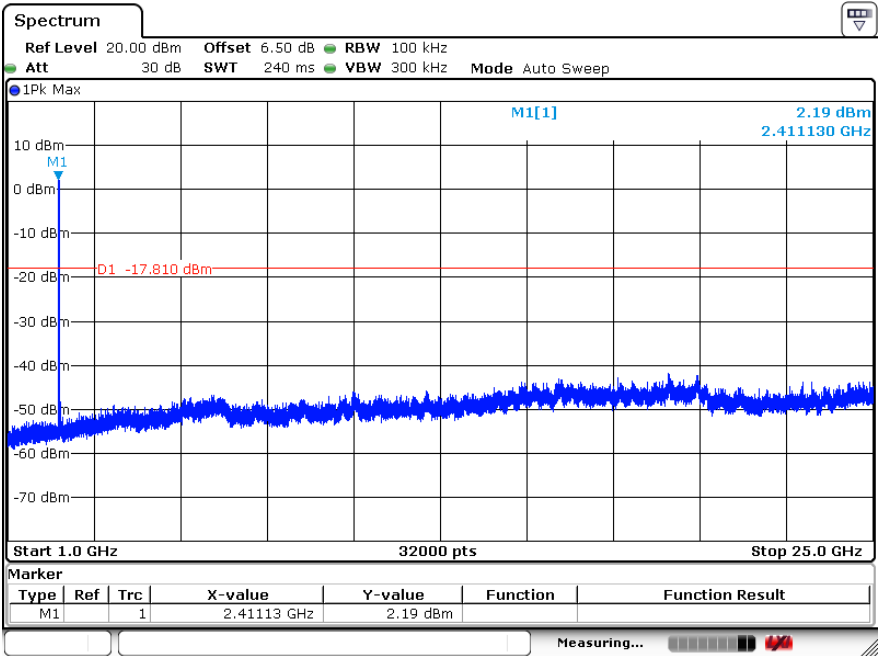
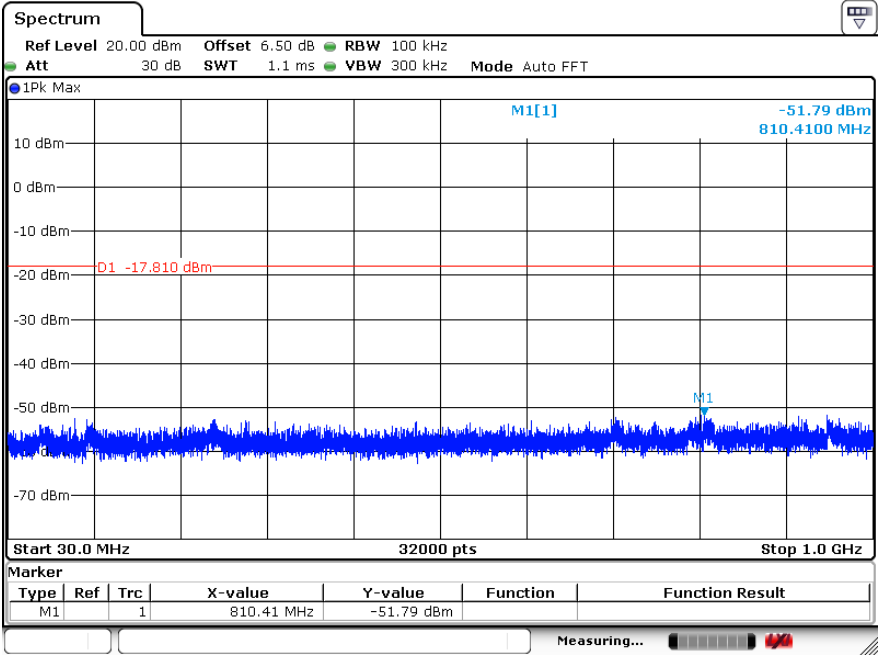

802.11 B Mode CH6

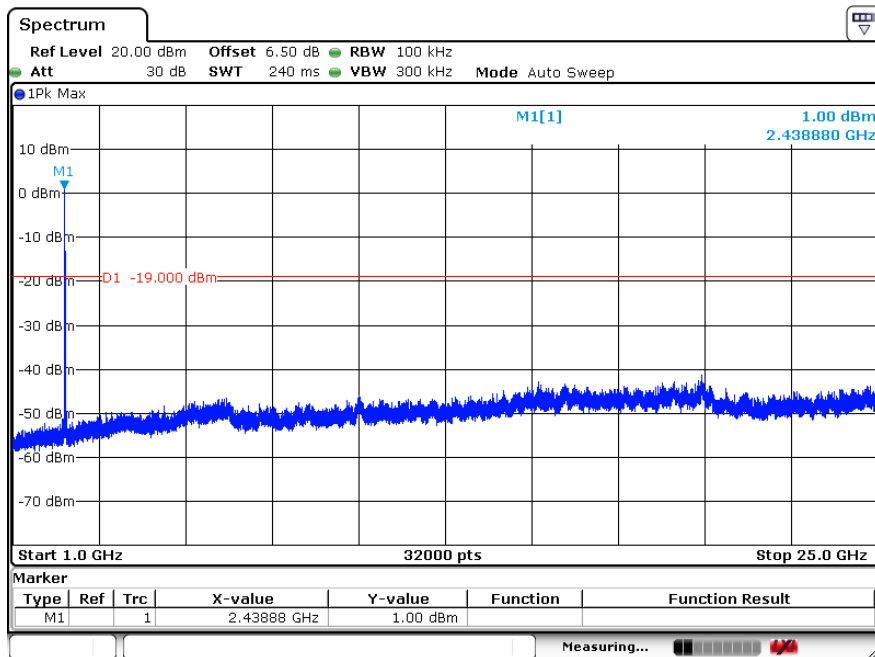
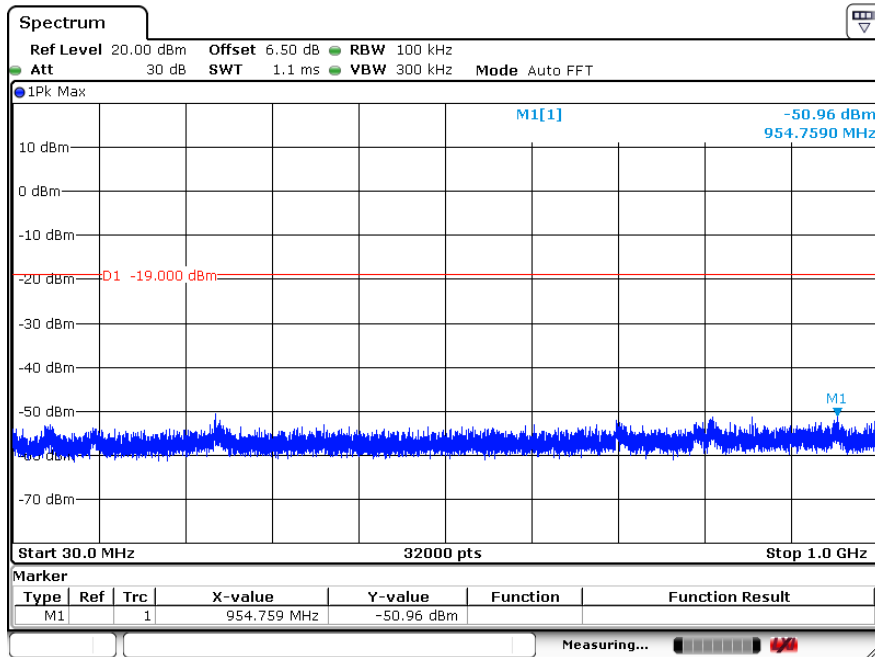

802.11 B Mode CH11

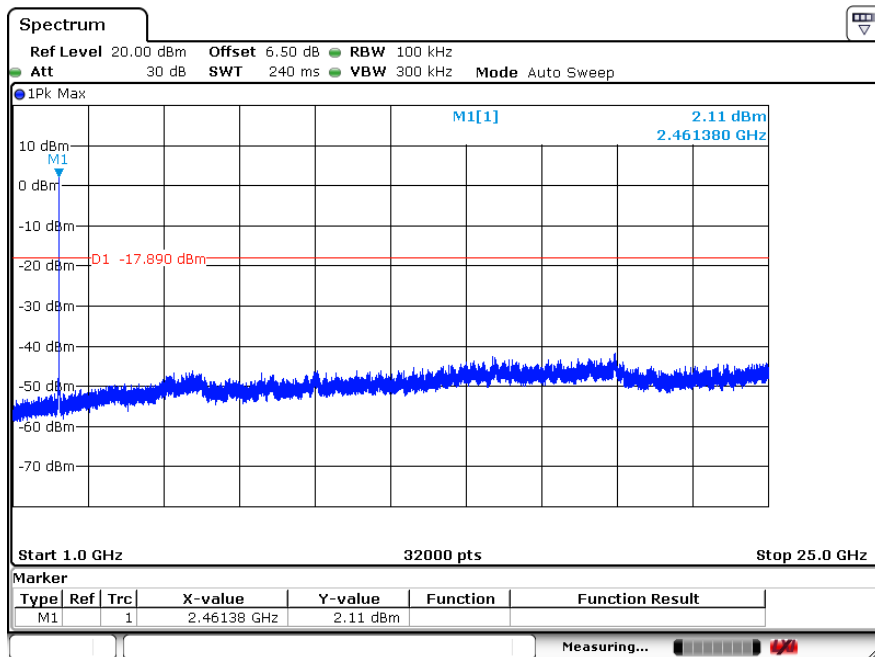
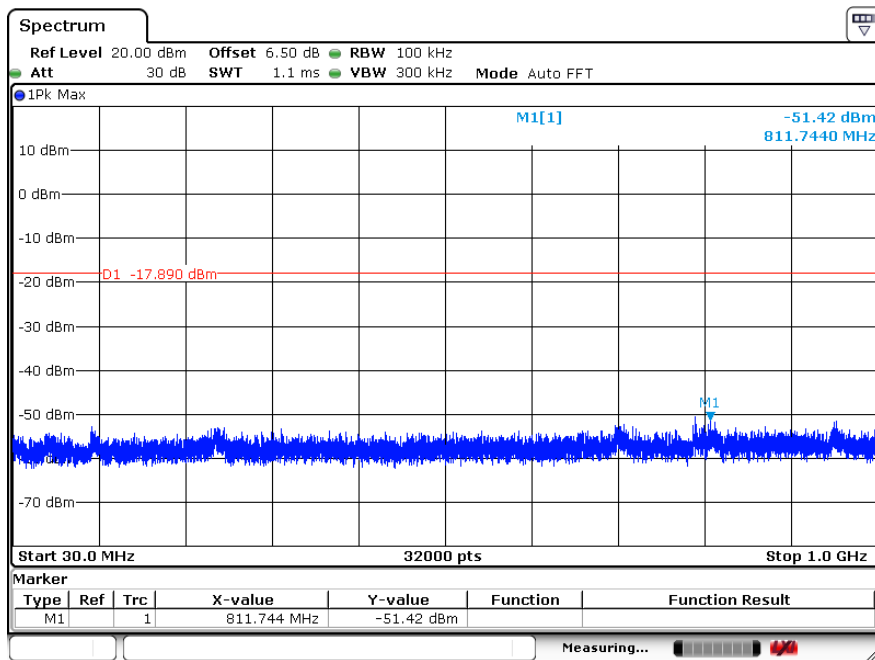

802.11 G Mode CH1

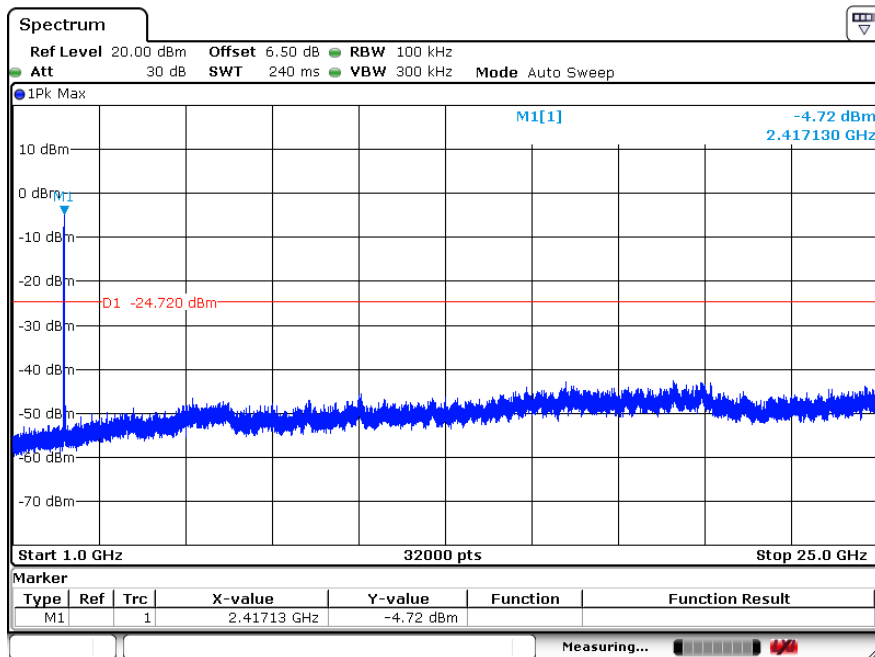
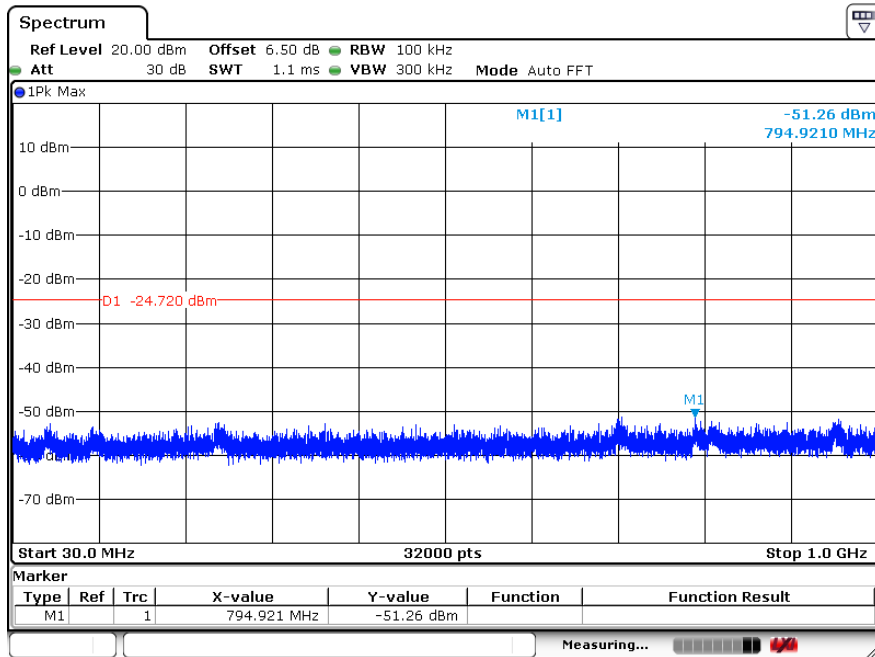

802.11 G Mode CH6

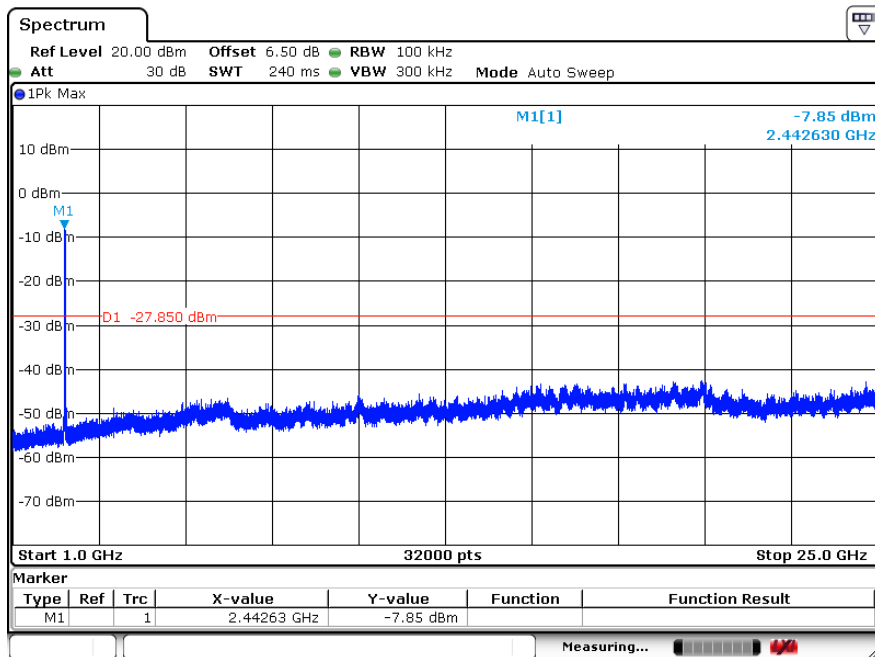
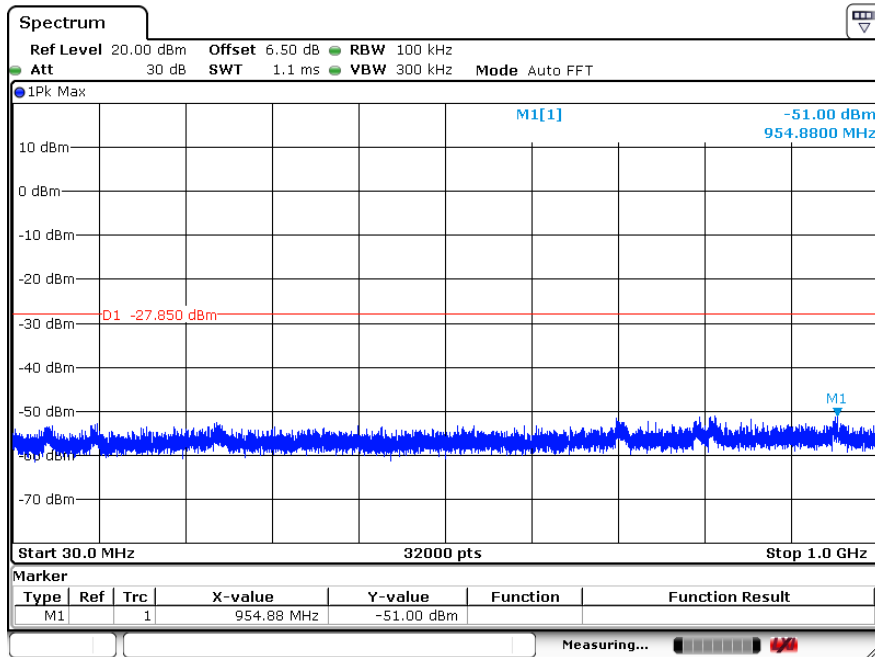

802.11 G Mode CH11

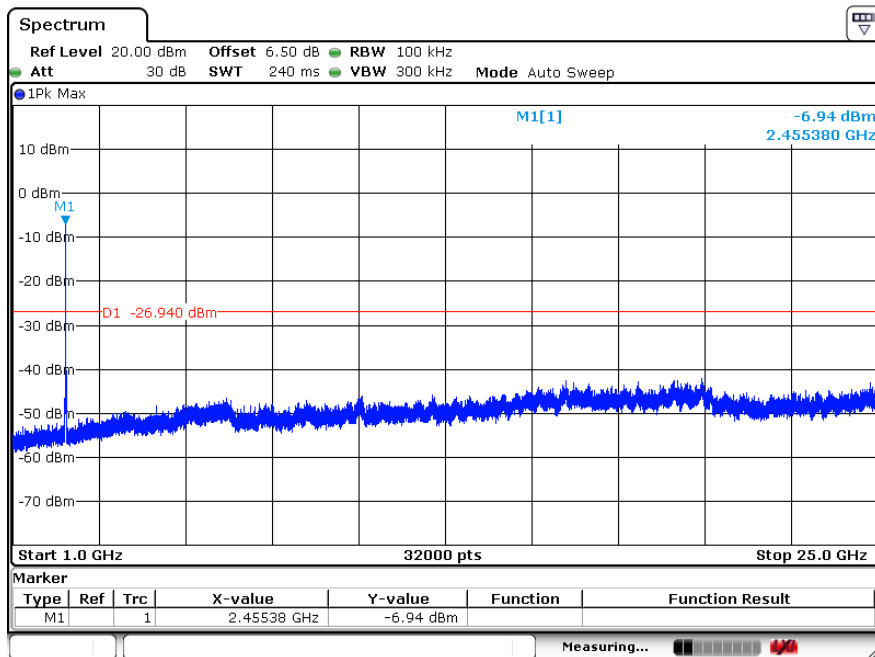
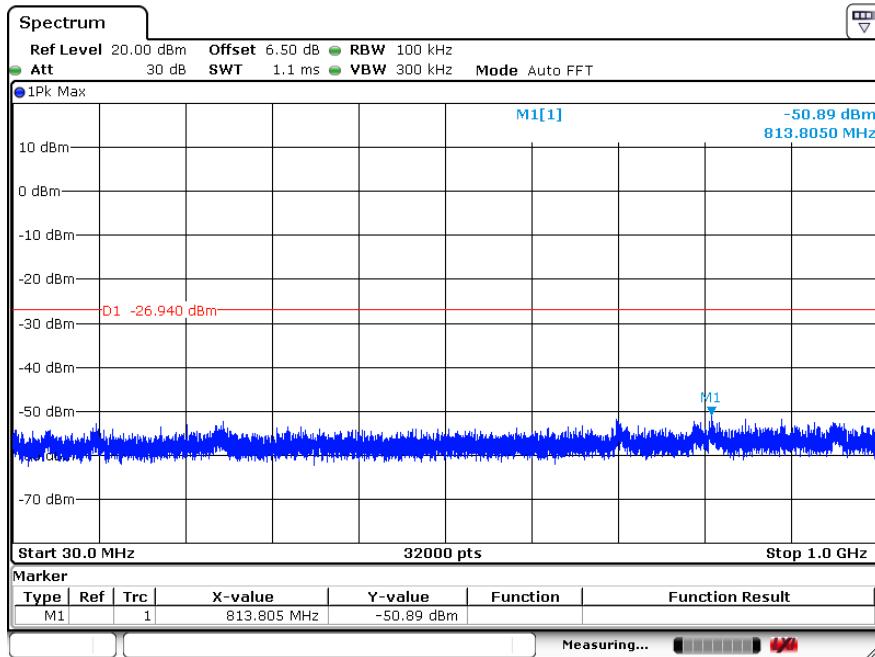

802.11 N20 Mode CH1

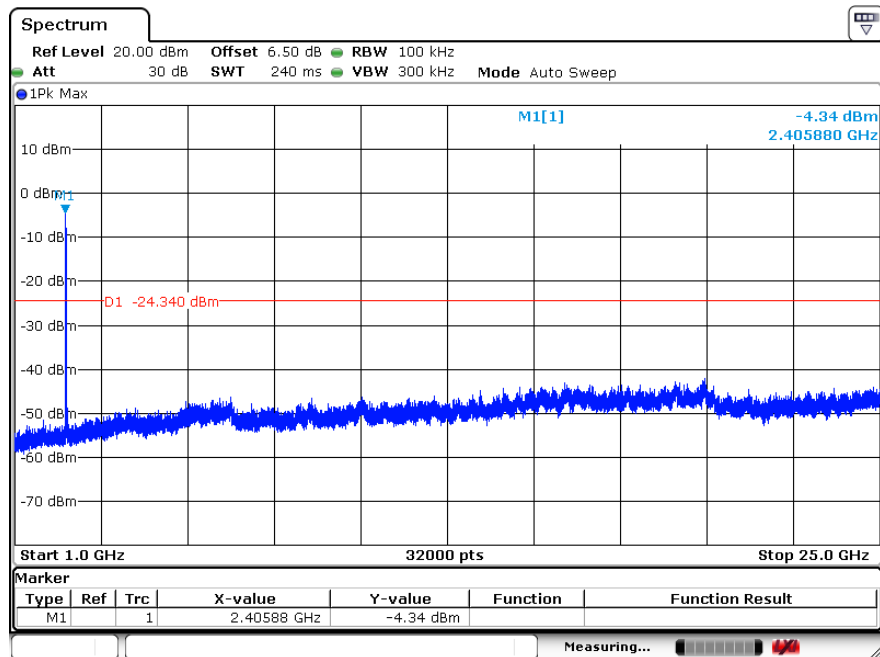
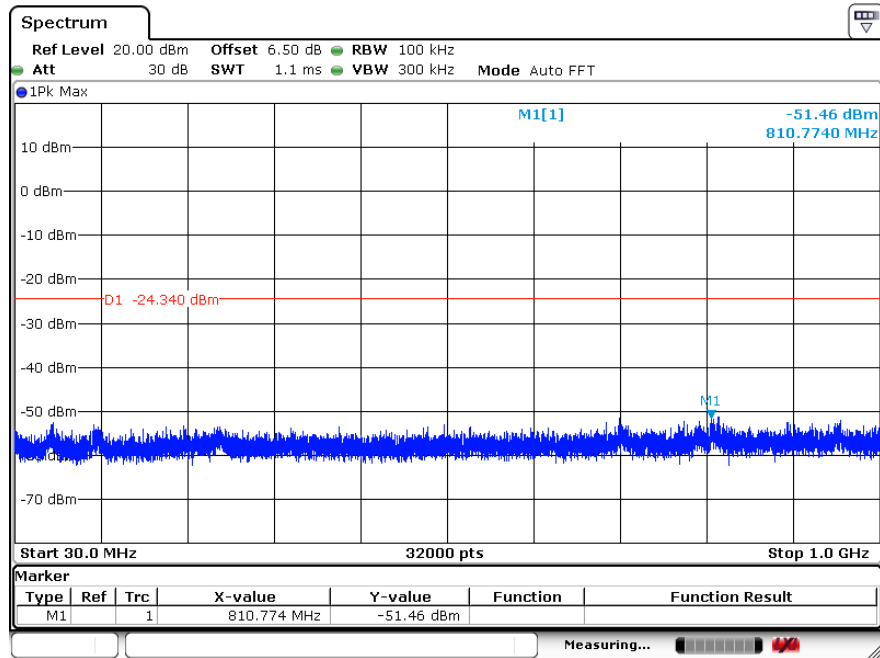

802.11 N20 Mode CH6

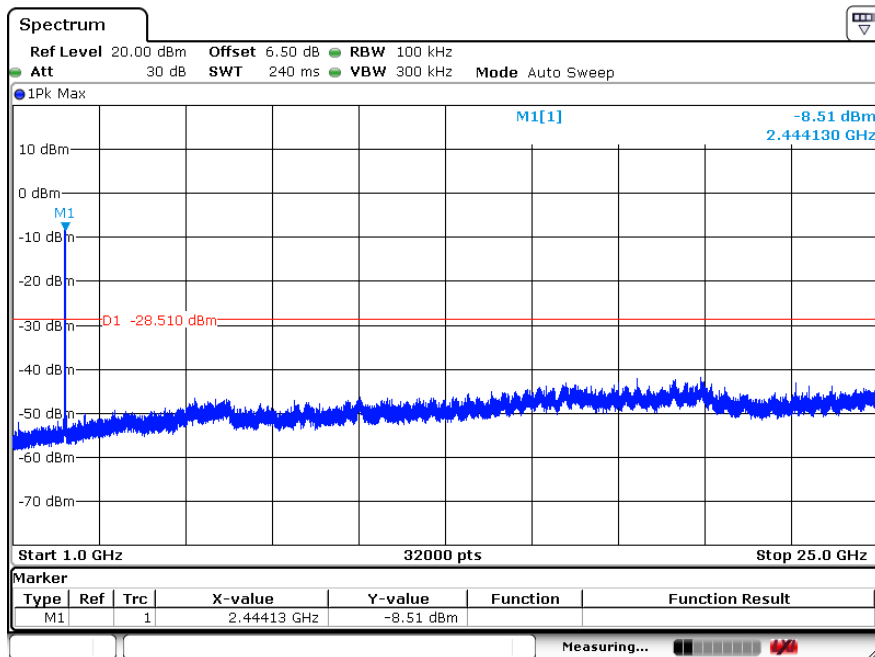
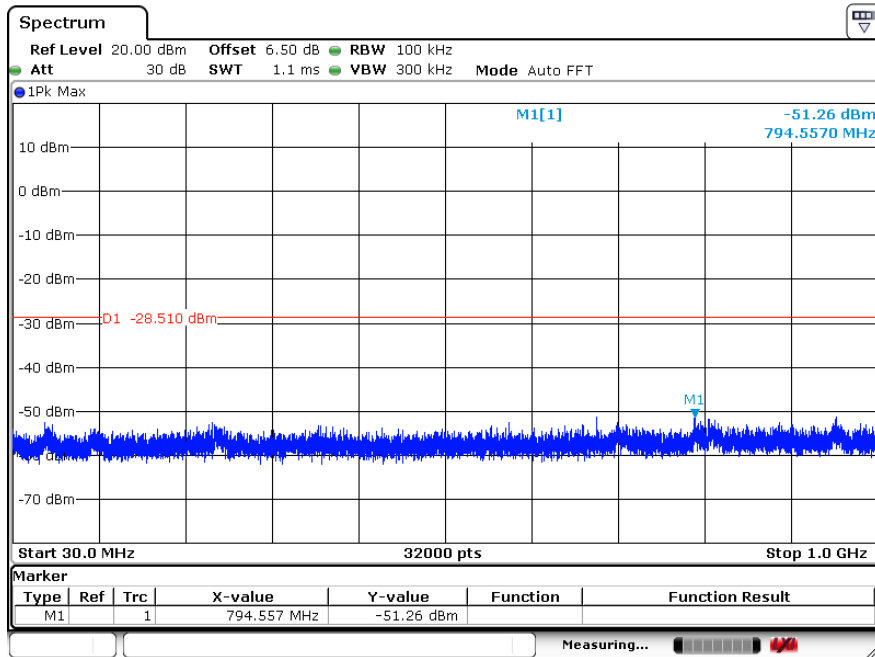

802.11 N20 Mode CH11

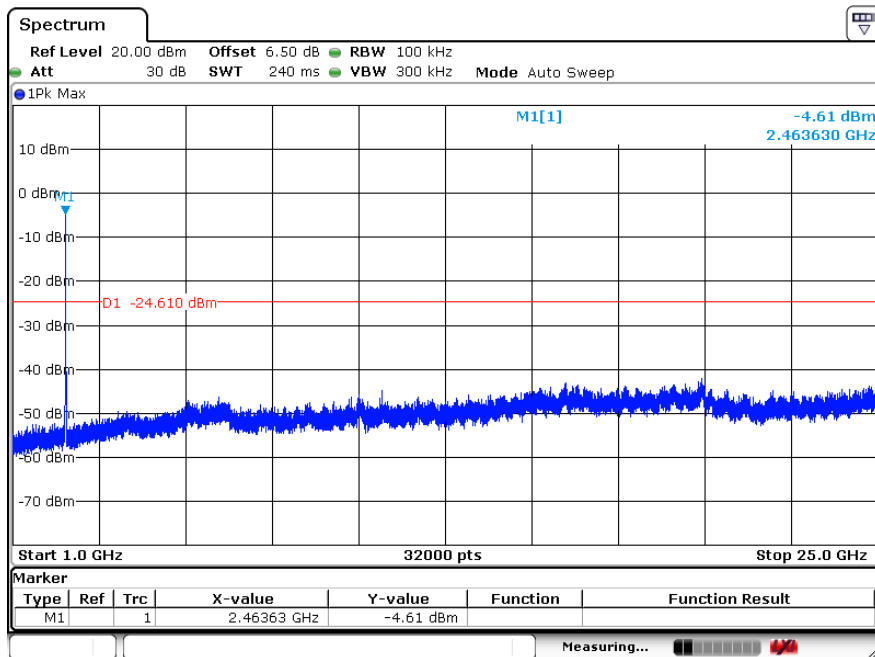
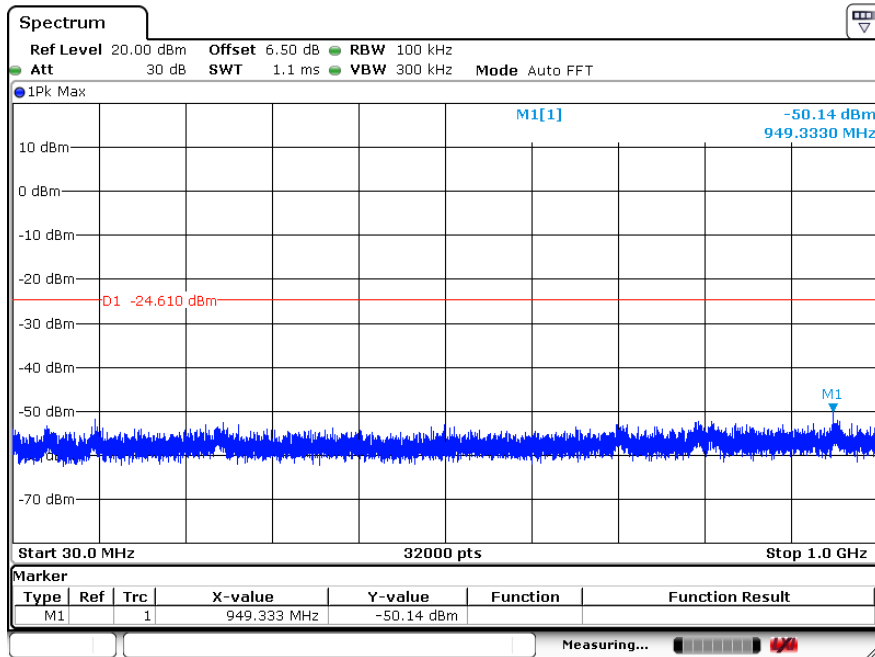

802.11 N40 Mode CH3

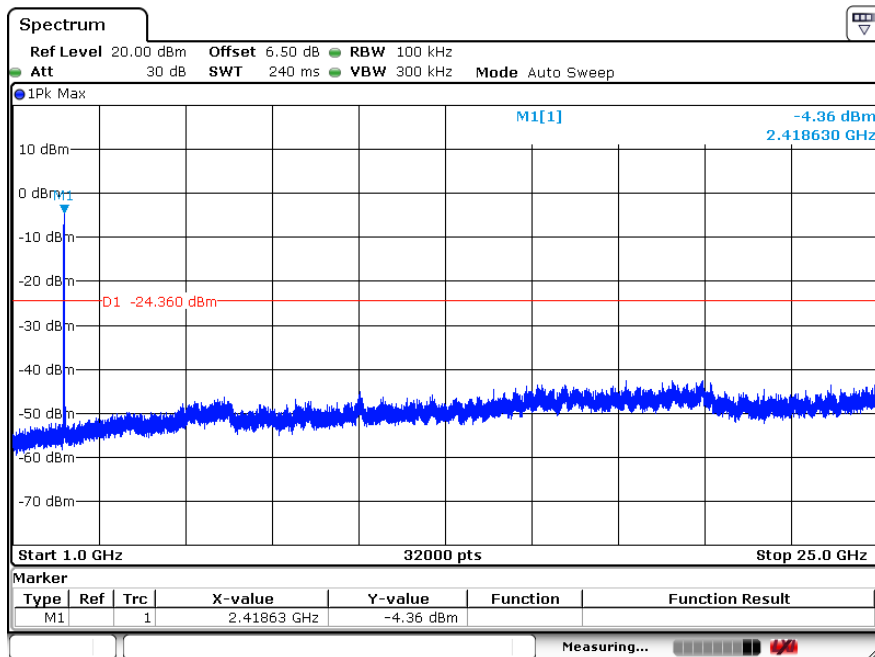
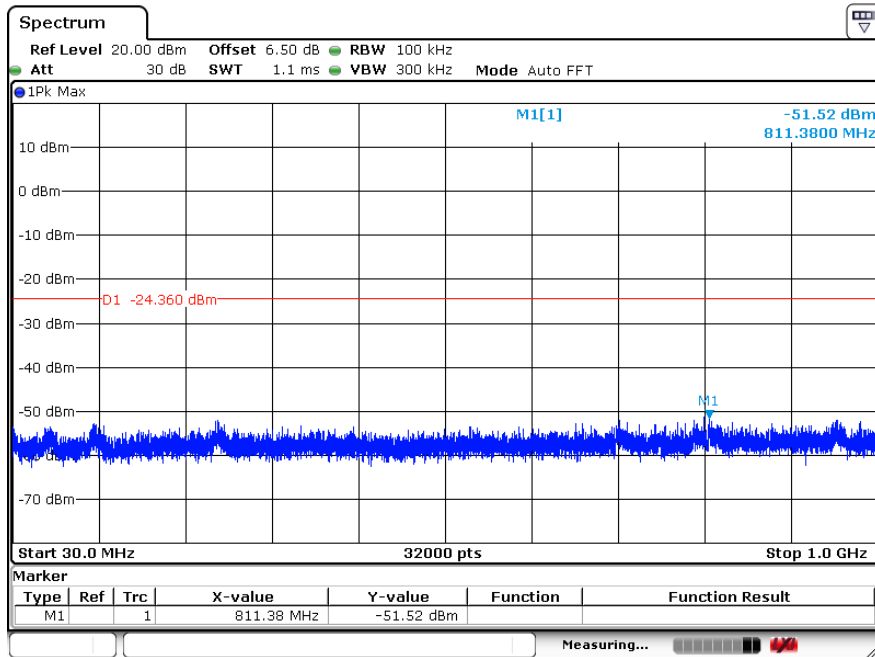

802.11 N40 Mode CH6

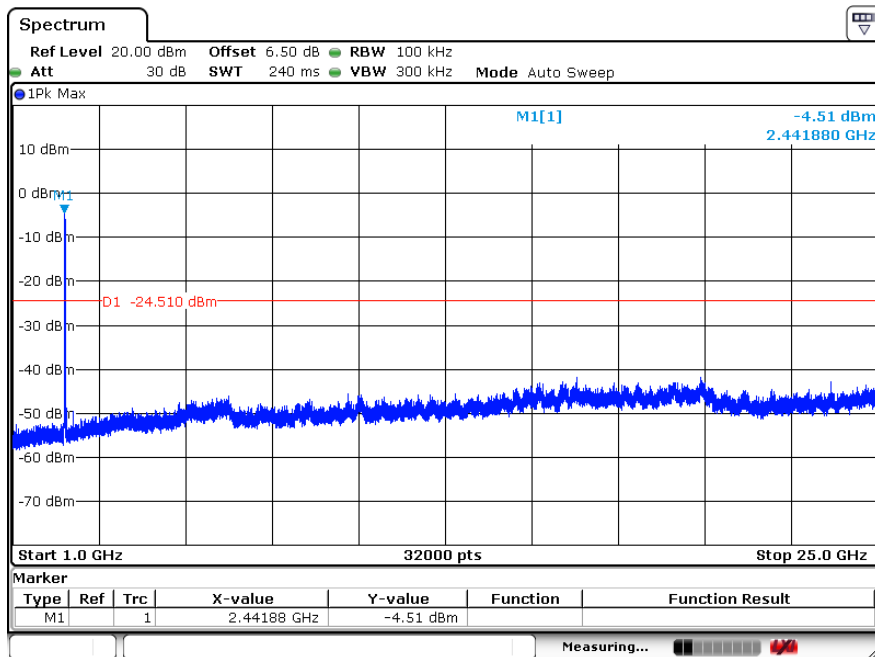
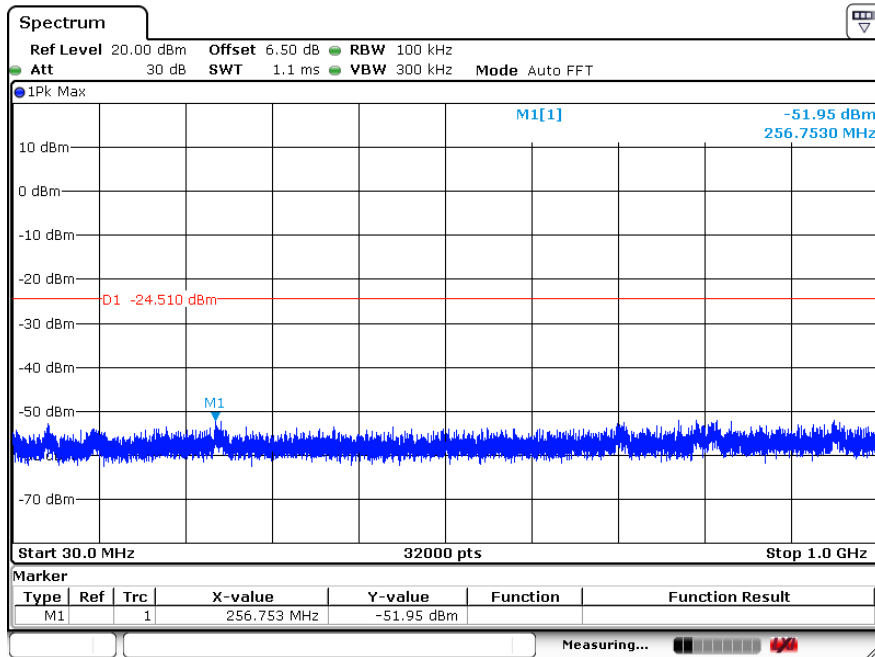

802.11 N40 Mode CH9

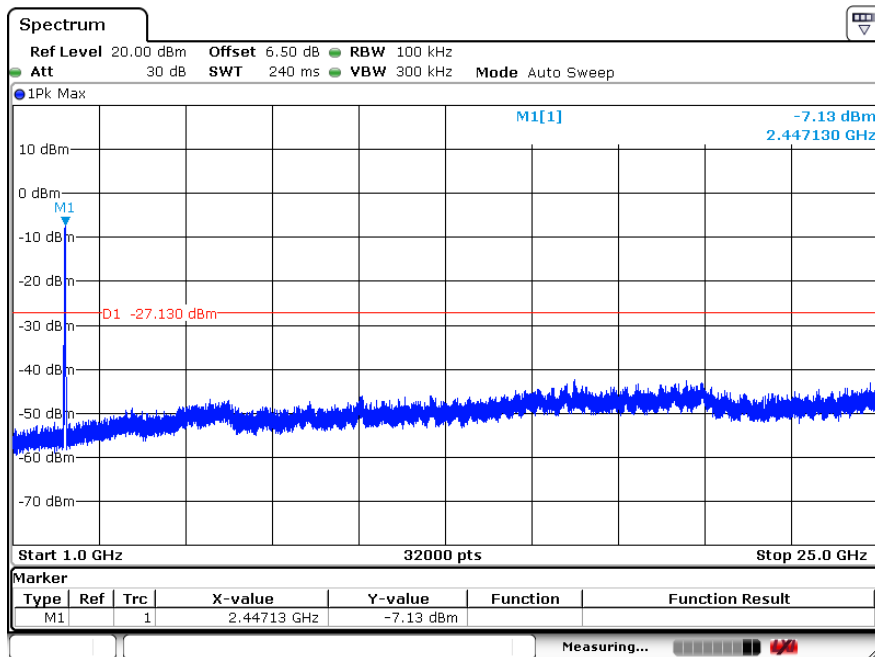
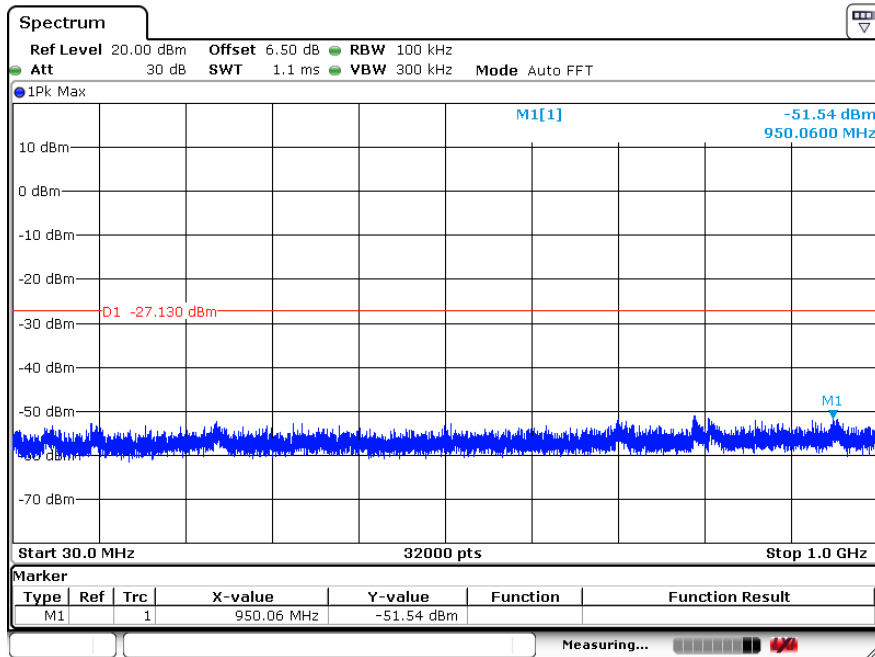

9 Power Line Conducted Emission

9.1 Test equipment

Item	Kind of Equipment	Manufacturer	Type No.	Serial No.	Calibrated until
1	Pulse Limiter	MTS-systemtechnik	MTS-IMP-136	261115-010-0024	12/17/2018
2	EMI Test Receiver	R&S	ESCI	101308	12/17/2018
3	LISN	AFJ	LS16	16011103219	12/17/2018
4	LISN	Schwarzbeck	NSLK 8127	8127-432	12/17/2018
5	Measurement Software	Farad	EZ-EMC (Ver.ATT-03A)	N/A	N/A
6	MeasurementSoftware	Farad	EZ-EMC (Ver.ATT-03A)	N/A	N/A

9.2 Block diagram of test setup

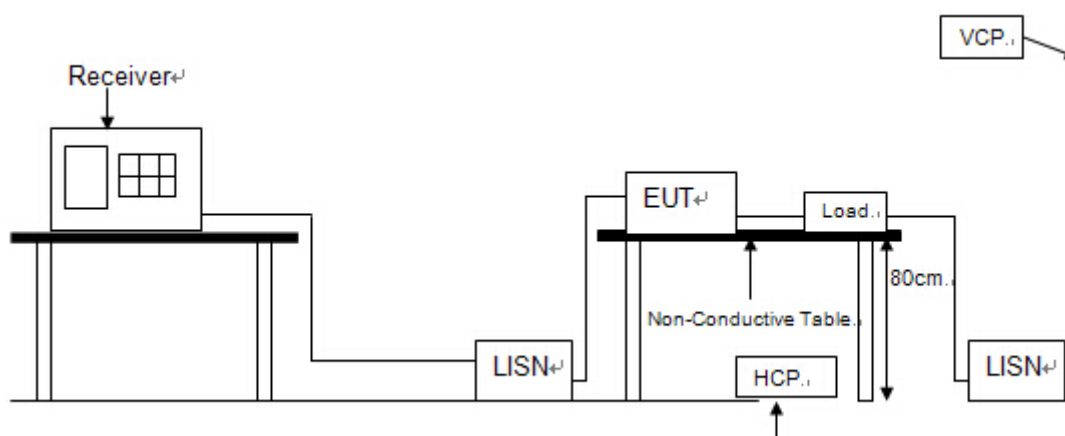

9.3 Power Line Conducted Emission Limits(Class B)

Frequency	Quasi-Peak Level dB(μ V)	Average Level dB(μ V)
150kHz ~ 500kHz	66 ~ 56*	56 ~ 46*
500kHz ~ 5MHz	56	46
5MHz ~ 30MHz	60	50

Note 1: * Decreasing linearly with logarithm of frequency.

Note 2: The lower limit shall apply at the transition frequencies.

9.4 Test Procedure

The EUT and Support equipment, if needed, were put placed on a non-metallic table, 80cm above the ground plane.

Configuration EUT to simulate typical usage as described in clause 2.4 and test equipment as described in clause 10.2 of this report.

All I/O cables were positioned to simulate typical actual usage as per ANSI C63.4.

All support equipment power received from a second LISN.

Emissions were measured on each current carrying line of the EUT using an EMI Test Receiver connected to the LISN powering the EUT.

The Receiver scanned from 150 kHz to 30MHz for emissions in each of the test modes.

During the above scans, the emissions were maximized by cable manipulation.

The test mode(s) described in clause 2.4 were scanned during the preliminary test.

After the preliminary scan, we found the test mode producing the highest emission level.

The EUT configuration and worse cable configuration of the above highest emission levels were recorded for reference of the final test.

EUT and support equipment were set up on the test bench as per the configuration with highest emission level in the preliminary test.

A scan was taken on both power lines, Neutral and Line, recording at least the six highest emissions.

Emission frequency and amplitude were recorded into a computer in which correction factors were used to calculate the emission level and compare reading to the applicable limit.

The test data of the worst-case condition(s) was recorded.

The bandwidth of test receiver is set at 9 KHz.

9.5 Test Result

PASS. (See below detailed test result)

Note1: All emissions not reported below are too low against the prescribed limits.

Note2: “----” means peak detection; “----” mans average detection

EUT:	TrekStor SurfTab theatre K13	Model No.:	TFMTKAW01216
Temperature:	23°C	Relative Humidity:	52%
Probe:	N	Test Power:	AC 120V/60Hz
Test Time:	2018-10-17	Test Result:	Pass
Standard:	(CE)FCC PART 15 class B_QP		
Test Mode:	TX		
Note:			

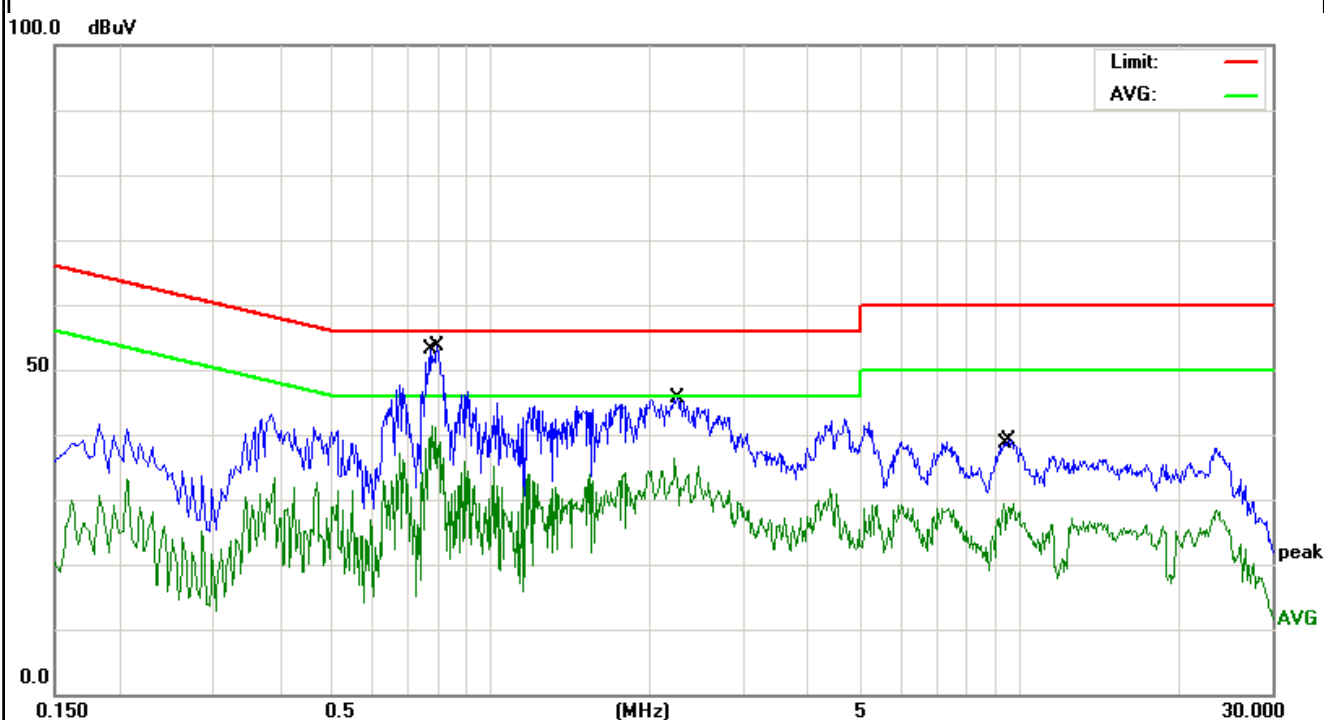

No.	Mk.	Freq.	Reading Level	Correct Factor	Measurement	Limit	Over	Detector
		MHz	dBuV	dB	dBuV	dBuV	dB	
1		0.7780	31.48	9.97	41.45	46.00	-4.55	AVG
2	*	0.7940	43.54	9.96	53.50	56.00	-2.50	QP
3		2.2340	26.34	10.00	36.34	46.00	-9.66	AVG
4		2.2580	35.72	10.00	45.72	56.00	-10.28	QP
5		9.3380	19.24	10.16	29.40	50.00	-20.60	AVG
6		9.5460	29.07	10.14	39.21	60.00	-20.79	QP

The test result is calculated as the following:

- (1) Result = Reading + Correct Factor
- (2) Correct Factor = (LISN, ISN, PLC or Current Probe) Factor + Cable Loss + Attenuator
- (3) Margin = Result - Limit

EUT:	TrekStor SurfTab theatre K13	Model No.:	TFMTKAW01216
Temperature:	23°C	Relative Humidity:	52%
Probe:	L1	Test Power:	AC 120V/60Hz
Test Time:	2018-10-17	Test Result:	Pass
Standard:	(CE)FCC PART 15 class B_QP		
Test Mode:	TX		
Note:			

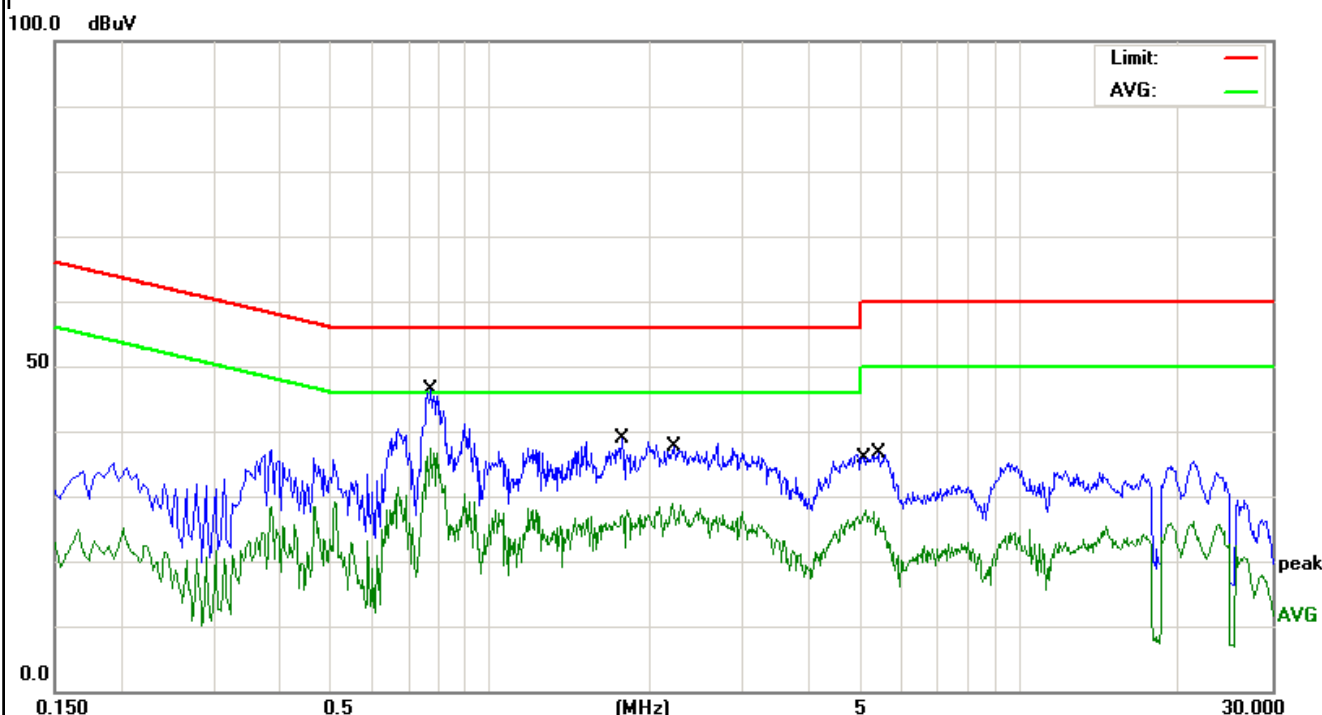

No.	Mk.	Freq. MHz	Reading Level dBuV	Correct Factor dB	Measure- ment dBuV	Limit dBuV	Over dB	Detector
1		0.7740	36.53	9.97	46.50	56.00	-9.50	QP
2	*	0.7740	27.50	9.97	37.47	46.00	-8.53	AVG
3		1.7780	28.96	9.98	38.94	56.00	-17.06	QP
4		2.2020	18.94	10.00	28.94	46.00	-17.06	AVG
5		5.1300	17.77	10.11	27.88	50.00	-22.12	AVG
6		5.3980	26.62	10.12	36.74	60.00	-23.26	QP

The test result is calculated as the following:

- (1) Result = Reading + Correct Factor
- (2) Correct Factor = (LISN, ISN, PLC or Current Probe) Factor + Cable Loss + Attenuator
- (3) Margin = Result - Limit

10. Antenna Requirements

10.1. Limit

For intentional device, according to FCC 47 CFR Section 15.203, an intentional radiator shall be designed to ensure that no antenna other than that furnished by the responsible party shall be used with the device. And according to FCC 47 CFR Section 15.247 (b), if transmitting antennas of directional gain greater than 6dBi are used, the power shall be reduced by the amount in dB that the directional gain of the antenna exceeds 6dBi.

10.2. Result

The antennas used for this product is FPCB antenna and that no antenna other than that furnished by the responsible party shall be used with the device, the maximum peak gain of the transmit antenna is only 1 dBi. The EUT has an internal antenna, the directional gain of antenna is 1 dBi, and the antenna connector is designed with permanent attachment and no consideration of replacement. Therefore the EUT is considered sufficient to comply with the provision.