

# FCC SAR Test Report

APPLICANT : Planet Avvio LLC  
EQUIPMENT : Mobile Phone  
BRAND NAME : Avvio  
MODEL NAME : BSC451  
FCC ID : 2ALTASC451  
STANDARD : FCC 47 CFR Part 2 (2.1093)  
ANSI/IEEE C95.1-1992  
IEEE 1528-2013

We, SPORTON International (ShenZhen) INC., would like to declare that the tested sample has been evaluated in accordance with the procedures and had been in compliance with the applicable technical standards.

The test results in this report apply exclusively to the tested model / sample. Without written approval of SPORTON International (ShenZhen) INC., the test report shall not be reproduced except in full.



Prepared by: Mark Qu / Manager



Approved by: Jones Tsai / Manager



**SPORTON International (ShenZhen) INC.**

**1/F, 2/F, Bldg 5, Shiling Industrial Zone, Xinwei Village, Xili, Nanshan District,  
Shenzhen City, Guangdong Province, China**



# Table of Contents

- 1. Statement of Compliance ..... 4**
- 2. Administration Data ..... 5**
- 3. Guidance Applied..... 5**
- 4. Equipment Under Test (EUT) Information..... 6**
  - 4.1 General Information ..... 6
  - 4.2 General LTE SAR Test and Reporting Considerations ..... 7
- 5. RF Exposure Limits..... 9**
  - 5.1 Uncontrolled Environment..... 9
  - 5.2 Controlled Environment..... 9
- 6. Specific Absorption Rate (SAR).....10**
  - 6.1 Introduction .....10
  - 6.2 SAR Definition.....10
- 7. System Description and Setup .....11**
  - 7.1 E-Field Probe .....12
  - 7.2 Data Acquisition Electronics (DAE) .....12
  - 7.3 Phantom.....13
  - 7.4 Device Holder.....14
- 8. Measurement Procedures .....15**
  - 8.1 Spatial Peak SAR Evaluation .....15
  - 8.2 Power Reference Measurement.....16
  - 8.3 Area Scan .....16
  - 8.4 Zoom Scan.....17
  - 8.5 Volume Scan Procedures.....17
  - 8.6 Power Drift Monitoring.....17
- 9. Test Equipment List .....18**
- 10. System Verification .....19**
  - 10.1 Tissue Simulating Liquids.....19
  - 10.2 Tissue Verification .....20
  - 10.3 System Performance Check Results.....21
- 11. RF Exposure Positions .....22**
  - 11.1 Ear and handset reference point .....22
  - 11.2 Definition of the cheek position.....23
  - 11.3 Definition of the tilt position.....24
  - 11.4 Body Worn Accessory .....25
  - 11.5 Wireless Router.....25
- 12. Conducted RF Output Power (Unit: dBm).....26**
- 13. Bluetooth Exclusions Applied .....40**
- 14. Antenna Location .....41**
- 15. SAR Test Results .....42**
  - 15.1 Head SAR .....44
  - 15.2 Hotspot SAR .....46
  - 15.3 Body Worn Accessory SAR.....48
  - 15.4 Repeated SAR Measurement .....49
- 16. Simultaneous Transmission Analysis.....50**
  - 16.1 Head Exposure Conditions .....51
  - 16.2 Hotspot Exposure Conditions.....52
  - 16.3 Body-Worn Accessory Exposure Conditions .....53
- 17. Uncertainty Assessment .....54**
- 18. References.....56**
- Appendix A. Plots of System Performance Check**
- Appendix B. Plots of High SAR Measurement**
- Appendix C. DASYS Calibration Certificate**
- Appendix D. Test Setup Photos**





### 1. Statement of Compliance

The maximum results of Specific Absorption Rate (SAR) found during testing for Planet Avvio LLC, Mobile Phone, BSC451, are as follows.

Frequency Band		Highest SAR Summary			Highest Simultaneous Transmission 1g SAR (W/kg)
		Head (Separation 0mm)	Body-worn (Separation 10mm)	Hotspot (Separation 10mm)	
		1g SAR (W/kg)			
GSM	GSM850	0.54	<b>0.95</b>	<b>0.95</b>	1.24
	GSM1900	0.21	0.64	0.64	
WCDMA	WCDMA V	0.29	0.53	0.53	
	WCDMA II	0.21	0.72	0.72	
LTE	LTE Band 28	0.06	0.14	0.14	
	LTE Band 4	0.42	0.88	0.88	
	LTE Band 7	0.01	0.17	0.17	
WLAN	2.4GHz WLAN	<b>0.69</b>	0.17	0.17	1.24
Date of Testing:		2017/04/11 ~ 2017/04/14			

This device is in compliance with Specific Absorption Rate (SAR) for general population/uncontrolled exposure limits (1.6 W/kg) specified in FCC 47 CFR part 2 (2.1093) and ANSI/IEEE C95.1-1992, and had been tested in accordance with the measurement methods and procedures specified in IEEE 1528-2013 and FCC KDB publications.

.

## **2. Administration Data**

<b>Testing Site</b>	
<b>Test Site</b>	SPORTON International (ShenZhen) INC.
<b>Test Site Location</b>	1/F, 2/F, Bldg 5, Shiling Industrial Zone, Xinwei Village, Xili, Nanshan District, Shenzhen City, Guangdong Province, China TEL: +86-755-8637-9589 FAX: +86-755-8637-9595

<b>Applicant</b>	
<b>Company Name</b>	Planet Awio LLC
<b>Address</b>	9725 NW 117th Ave., Medley, FL 33178, United States

<b>Manufacturer</b>	
<b>Company Name</b>	SHENZHEN SINTAVE COMMUNICATION CO, LTD
<b>Address</b>	6th/F, Building 3, SangTai Technology Park, LiuXianDong, XiLi, NanShan District, ShenZhen City, GuangDong Province, China

## **3. Guidance Applied**

The Specific Absorption Rate (SAR) testing specification, method, and procedure for this device is in accordance with the following standards:

- FCC 47 CFR Part 2 (2.1093)
- ANSI/IEEE C95.1-1992
- IEEE 1528-2013
- FCC KDB 865664 D01 SAR Measurement 100 MHz to 6 GHz v01r04
- FCC KDB 865664 D02 SAR Reporting v01r02
- FCC KDB 447498 D01 General RF Exposure Guidance v06
- FCC KDB 648474 D04 SAR Evaluation Considerations for Wireless Handsets v01r03
- FCC KDB 248227 D01 802.11 Wi-Fi SAR v02r02
- FCC KDB 941225 D01 3G SAR Procedures v03r01
- FCC KDB 941225 D05 SAR for LTE Devices v02r05
- FCC KDB 941225 D06 Hotspot Mode SAR v02r01



**4. Equipment Under Test (EUT) Information**

**4.1 General Information**

Product Feature & Specification	
Equipment Name	Mobile Phone
Brand Name	Avvio
Model Name	BSC451
FCC ID	2ALTASC451
IMEI Code	865623692586652
Wireless Technology and Frequency Range	GSM850: 824.2 MHz ~ 848.8 MHz GSM1900: 1850.2 MHz ~ 1909.8 MHz WCDMA Band II: 1852.4 MHz ~ 1907.6 MHz WCDMA Band V: 826.4 MHz ~ 846.6 MHz LTE Band 4: 1710 MHz ~ 1755 MHz LTE Band 7: 2502.5 MHz ~ 2567.5 MHz LTE Band 28 : 704.5 MHz ~ 746.5 MHz WLAN 2.4GHz Band: 2412 MHz ~ 2462 MHz Bluetooth: 2402 MHz ~ 2480 MHz
Mode	GSM/GPRS/EGPRS RMC/AMR 12.2Kbps HSDPA HSUPA HSPA+ (16QAM uplink is not supported) LTE: QPSK, 16QAM 802.11b/g/n HT20/HT40 Bluetooth v3.0+EDR, Bluetooth v4.0 LE
HW Version	WMEVb
SW Version	Platinum5.0+_SKY_V1.0_20161029
GSM / (E)GPRS Transfer mode	Class B – EUT cannot support Packet Switched and Circuit Switched Network simultaneously but can automatically switch between Packet and Circuit Switched Network.
EUT Stage	Production Unit
<b>Remark:</b> 1. This device 2.4GHz WLAN supports hotspot operation. 2. This device supported VoIP in GPRS, EGPRS, WCDMA, LTE (e.g. 3rd party VoIP). 3. This device supports GRPS/EGPRS mode up to multi-slot class 12. 4. This device does not support DTM operation. 5. LTE Band 28 SAR testing is added for the requirement of customer. 6. This project is FCC change ID application and changed Model Name. Based on the similarity between two products, the test result is not affected; all test cases were performed on original report which can be referred to Sporton Report Number FA731002, FCC ID: 2ALTAPRO450X.	



**4.2 General LTE SAR Test and Reporting Considerations**

Summarized necessary items addressed in KDB 941225 D05 v02r05																																							
FCC ID	2ALTASC451																																						
Equipment Name	Mobile Phone																																						
Operating Frequency Range of each LTE transmission band	LTE Band 4: 1710 MHz ~ 1755 MHz LTE Band 7: 2502.5 MHz ~ 2567.5 MHz LTE Band 28 : 704.5 MHz ~ 746.5 MHz																																						
Channel Bandwidth	LTE Band 4: 1.4MHz, 3MHz, 5MHz, 10MHz, 15MHz, 20MHz LTE Band 7: 5MHz, 10MHz, 15MHz, 20MHz LTE Band 28: 3MHz, 5MHz, 10MHz, 15MHz, 20MHz																																						
uplink modulations used	QPSK, and 16QAM																																						
LTE Voice / Data requirements	Data only																																						
LTE MPR permanently built-in by design	<table border="1"> <caption>Table 6.2.3-1: Maximum Power Reduction (MPR) for Power Class 3</caption> <thead> <tr> <th rowspan="2">Modulation</th> <th colspan="6">Channel bandwidth / Transmission bandwidth (RB)</th> <th rowspan="2">MPR (dB)</th> </tr> <tr> <th>1.4 MHz</th> <th>3.0 MHz</th> <th>5 MHz</th> <th>10 MHz</th> <th>15 MHz</th> <th>20 MHz</th> </tr> </thead> <tbody> <tr> <td>QPSK</td> <td>&gt;5</td> <td>&gt;4</td> <td>&gt;8</td> <td>&gt;12</td> <td>&gt;16</td> <td>&gt;18</td> <td>≤ 1</td> </tr> <tr> <td>16 QAM</td> <td>≤ 5</td> <td>≤ 4</td> <td>≤ 8</td> <td>≤ 12</td> <td>≤ 16</td> <td>≤ 18</td> <td>≤ 1</td> </tr> <tr> <td>16 QAM</td> <td>&gt;5</td> <td>&gt;4</td> <td>&gt;8</td> <td>&gt;12</td> <td>&gt;16</td> <td>&gt;18</td> <td>≤ 2</td> </tr> </tbody> </table>	Modulation	Channel bandwidth / Transmission bandwidth (RB)						MPR (dB)	1.4 MHz	3.0 MHz	5 MHz	10 MHz	15 MHz	20 MHz	QPSK	>5	>4	>8	>12	>16	>18	≤ 1	16 QAM	≤ 5	≤ 4	≤ 8	≤ 12	≤ 16	≤ 18	≤ 1	16 QAM	>5	>4	>8	>12	>16	>18	≤ 2
Modulation	Channel bandwidth / Transmission bandwidth (RB)						MPR (dB)																																
	1.4 MHz	3.0 MHz	5 MHz	10 MHz	15 MHz	20 MHz																																	
QPSK	>5	>4	>8	>12	>16	>18	≤ 1																																
16 QAM	≤ 5	≤ 4	≤ 8	≤ 12	≤ 16	≤ 18	≤ 1																																
16 QAM	>5	>4	>8	>12	>16	>18	≤ 2																																
LTE A-MPR	In the base station simulator configuration, Network Setting value is set to NS_01 to disable A-MPR during SAR testing and the LTE SAR tests was transmitting on all TTI frames (Maximum TTI)																																						
Spectrum plots for RB configuration	A properly configured base station simulator was used for the SAR and power measurement; therefore, spectrum plots for each RB allocation and offset configuration are not included in the SAR report.																																						
LTE Release	R9, Cat 4																																						
CA supports	Not Supported																																						



Transmission (H, M, L) channel numbers and frequencies in each LTE band												
LTE Band 4												
	Bandwidth 1.4 MHz		Bandwidth 3 MHz		Bandwidth 5 MHz		Bandwidth 10 MHz		Bandwidth 15 MHz		Bandwidth 20 MHz	
	Ch. #	Freq. (MHz)	Ch. #	Freq. (MHz)	Ch. #	Freq. (MHz)	Ch. #	Freq. (MHz)	Ch. #	Freq. (MHz)	Ch. #	Freq. (MHz)
L	19957	1710.7	19965	1711.5	19975	1712.5	20000	1715	20025	1717.5	20050	1720
M	20175	1732.5	20175	1732.5	20175	1732.5	20175	1732.5	20175	1732.5	20175	1732.5
H	20393	1754.3	20385	1753.5	20375	1752.5	20350	1750	20325	1747.5	20300	1745
LTE Band 7												
	Bandwidth 5 MHz		Bandwidth 10 MHz		Bandwidth 15 MHz		Bandwidth 20 MHz					
	Ch. #	Freq. (MHz)	Ch. #	Freq. (MHz)	Ch. #	Freq. (MHz)	Ch. #	Freq. (MHz)	Ch. #	Freq. (MHz)	Ch. #	Freq. (MHz)
L	20775	2502.5	20800	2505	20825	2507.5	20850	2510				
M	21100	2535	21100	2535	21100	2535	21100	2535				
H	21425	2567.5	21400	2565	21375	2562.5	21350	2560				
LTE Band 28												
	Bandwidth 3 MHz		Bandwidth 5 MHz		Bandwidth 10 MHz		Bandwidth 15 MHz		Bandwidth 20 MHz			
	Ch. #	Freq. (MHz)	Ch. #	Freq. (MHz)	Ch. #	Freq. (MHz)	Ch. #	Freq. (MHz)	Ch. #	Freq. (MHz)	Ch. #	Freq. (MHz)
L	27225	704.5	27235	705.5	27260	708	27285	710.5	27310	713		
M	27435	725.5	27435	725.5	27435	725.5	27435	725.5	27435	725.5		
H	27645	746.5	27635	745.5	27610	743	27585	740.5	27560	738		



**5. RF Exposure Limits**

**5.1 Uncontrolled Environment**

Uncontrolled Environments are defined as locations where there is the exposure of individuals who have no knowledge or control of their exposure. The general population/uncontrolled exposure limits are applicable to situations in which the general public may be exposed or in which persons who are exposed as a consequence of their employment may not be made fully aware of the potential for exposure or cannot exercise control over their exposure. Members of the general public would come under this category when exposure is not employment-related; for example, in the case of a wireless transmitter that exposes persons in its vicinity.

**5.2 Controlled Environment**

Controlled Environments are defined as locations where there is exposure that may be incurred by persons who are aware of the potential for exposure, (i.e. as a result of employment or occupation). In general, occupational/controlled exposure limits are applicable to situations in which persons are exposed as a consequence of their employment, who have been made fully aware of the potential for exposure and can exercise control over their exposure. The exposure category is also applicable when the exposure is of a transient nature due to incidental passage through a location where the exposure levels may be higher than the general population/uncontrolled limits, but the exposed person is fully aware of the potential for exposure and can exercise control over his or her exposure by leaving the area or by some other appropriate means.

**Limits for Occupational/Controlled Exposure (W/kg)**

Whole-Body	Partial-Body	Hands, Wrists, Feet and Ankles
0.4	8.0	20.0

**Limits for General Population/Uncontrolled Exposure (W/kg)**

Whole-Body	Partial-Body	Hands, Wrists, Feet and Ankles
0.08	1.6	4.0

1. Whole-Body SAR is averaged over the entire body, partial-body SAR is averaged over any 1gram of tissue defined as a tissue volume in the shape of a cube. SAR for hands, wrists, feet and ankles is averaged over any 10 grams of tissue defined as a tissue volume in the shape of a cube.

## **6. Specific Absorption Rate (SAR)**

### **6.1 Introduction**

SAR is related to the rate at which energy is absorbed per unit mass in an object exposed to a radio field. The SAR distribution in a biological body is complicated and is usually carried out by experimental techniques or numerical modeling. The standard recommends limits for two tiers of groups, occupational/controlled and general population/uncontrolled, based on a person's awareness and ability to exercise control over his or her exposure. In general, occupational/controlled exposure limits are higher than the limits for general population/uncontrolled.

### **6.2 SAR Definition**

The SAR definition is the time derivative (rate) of the incremental energy (dW) absorbed by (dissipated in) an incremental mass (dm) contained in a volume element (dv) of a given density ( $\rho$ ). The equation description is as below:

$$\text{SAR} = \frac{d}{dt} \left( \frac{dW}{dm} \right) = \frac{d}{dt} \left( \frac{dW}{\rho dv} \right)$$

SAR is expressed in units of Watts per kilogram (W/kg)

$$\text{SAR} = \frac{\sigma |E|^2}{\rho}$$

Where:  $\sigma$  is the conductivity of the tissue,  $\rho$  is the mass density of the tissue and E is the RMS electrical field strength.

## 7. System Description and Setup

The DASY system used for performing compliance tests consists of the following items:

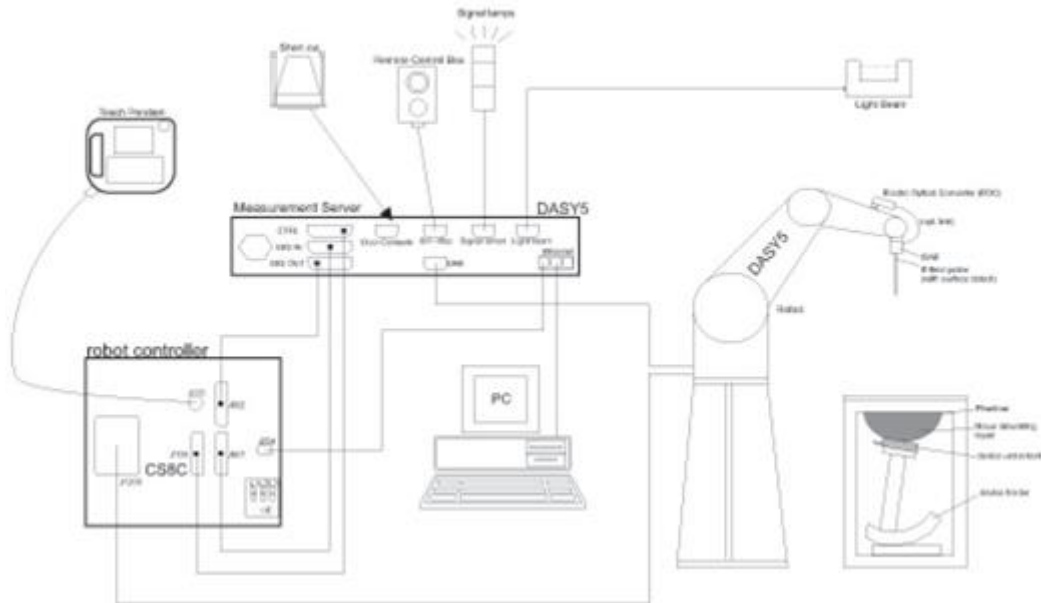

- A standard high precision 6-axis robot with controller, teach pendant and software. An arm extension for accommodating the data acquisition electronics (DAE).
- An isotropic Field probe optimized and calibrated for the targeted measurement.
- A data acquisition electronics (DAE) which performs the signal amplification, signal multiplexing, AD-conversion, offset measurements, mechanical surface detection, collision detection, etc. The unit is battery powered with standard or rechargeable batteries. The signal is optically transmitted to the EOC.
- The Electro-optical converter (EOC) performs the conversion from optical to electrical signals for the digital communication to the DAE. To use optical surface detection, a special version of the EOC is required. The EOC signal is transmitted to the measurement server.
- The function of the measurement server is to perform the time critical tasks such as signal filtering, control of the robot operation and fast movement interrupts.
- The Light Beam used is for probe alignment. This improves the (absolute) accuracy of the probe positioning.
- A computer running WinXP or Win7 and the DASY5 software.
- Remote control and teach pendant as well as additional circuitry for robot safety such as warning lamps, etc.
- The phantom, the device holder and other accessories according to the targeted measurement.

**7.1 E-Field Probe**

The SAR measurement is conducted with the dosimetric probe (manufactured by SPEAG).The probe is specially designed and calibrated for use in liquid with high permittivity. The dosimetric probe has special calibration in liquid at different frequency. This probe has a built in optical surface detection system to prevent from collision with phantom.

**<EX3DV4 Probe>**

<b>Construction</b>	Symmetric design with triangular core Built-in shielding against static charges PEEK enclosure material (resistant to organic solvents, e.g., DGBE)	
<b>Frequency</b>	10 MHz – >6 GHz Linearity: ±0.2 dB (30 MHz – 6 GHz)	
<b>Directivity</b>	±0.3 dB in TSL (rotation around probe axis) ±0.5 dB in TSL (rotation normal to probe axis)	
<b>Dynamic Range</b>	10 µW/g – >100 mW/g Linearity: ±0.2 dB (noise: typically <1 µW/g)	
<b>Dimensions</b>	Overall length: 337 mm (tip: 20 mm) Tip diameter: 2.5 mm (body: 12 mm) Typical distance from probe tip to dipole centers: 1 mm	

**7.2 Data Acquisition Electronics (DAE)**

The data acquisition electronics (DAE) consists of a highly sensitive electrometer-grade preamplifier with auto-zeroing, a channel and gain-switching multiplexer, a fast 16 bit AD-converter and a command decoder and control logic unit. Transmission to the measurement server is accomplished through an optical downlink for data and status information as well as an optical uplink for commands and the clock.

The input impedance of the DAE is 200 MOhm; the inputs are symmetrical and floating. Common mode rejection is above 80 dB.



**Fig 5.1 Photo of DAE**

**7.3 Phantom**

**<SAM Twin Phantom>**

<b>Shell Thickness</b>	2 ± 0.2 mm; Center ear point: 6 ± 0.2 mm
<b>Filling Volume</b>	Approx. 25 liters
<b>Dimensions</b>	Length: 1000 mm; Width: 500 mm; Height: adjustable feet
<b>Measurement Areas</b>	Left Hand, Right Hand, Flat Phantom



The bottom plate contains three pair of bolts for locking the device holder. The device holder positions are adjusted to the standard measurement positions in the three sections. A white cover is provided to tap the phantom during off-periods to prevent water evaporation and changes in the liquid parameters. On the phantom top, three reference markers are provided to identify the phantom position with respect to the robot.

**<ELI Phantom>**

<b>Shell Thickness</b>	2 ± 0.2 mm (sagging: <1%)
<b>Filling Volume</b>	Approx. 30 liters
<b>Dimensions</b>	Major ellipse axis: 600 mm Minor axis: 400 mm

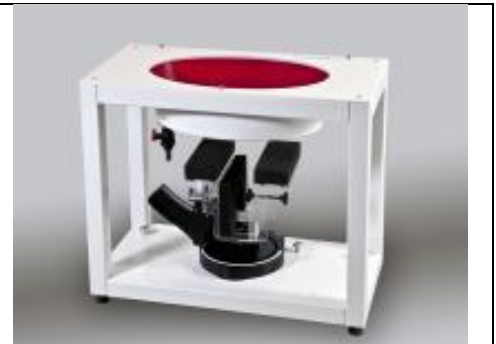

The ELI phantom is intended for compliance testing of handheld and body-mounted wireless devices in the frequency range of 30 MHz to 6 GHz. ELI4 is fully compatible with standard and all known tissue simulating liquids.

### 7.4 Device Holder

#### <Mounting Device for Hand-Held Transmitter>

In combination with the Twin SAM V5.0/V5.0c or ELI phantoms, the Mounting Device for Hand-Held Transmitters enables rotation of the mounted transmitter device to specified spherical coordinates. At the heads, the rotation axis is at the ear opening. Transmitter devices can be easily and accurately positioned according to IEC 62209-1, IEEE 1528, FCC, or other specifications. The device holder can be locked for positioning at different phantom sections (left head, right head, flat). And upgrade kit to Mounting Device to enable easy mounting of wider devices like big smart-phones, e-books, small tablets, etc. It holds devices with width up to 140 mm.



Mounting Device for Hand-Held Transmitters



Mounting Device Adaptor for Wide-Phones

#### <Mounting Device for Laptops and other Body-Worn Transmitters>

The extension is lightweight and made of POM, acrylic glass and foam. It fits easily on the upper part of the mounting device in place of the phone positioned. The extension is fully compatible with the SAM Twin and ELI phantoms.



Mounting Device for Laptops

## **8. Measurement Procedures**

The measurement procedures are as follows:

### <Conducted power measurement>

- (a) For WWAN power measurement, use base station simulator to configure EUT WWAN transmission in conducted connection with RF cable, at maximum power in each supported wireless interface and frequency band.
- (b) Read the WWAN RF power level from the base station simulator.
- (c) For WLAN/BT power measurement, use engineering software to configure EUT WLAN/BT continuously transmission, at maximum RF power in each supported wireless interface and frequency band
- (d) Connect EUT RF port through RF cable to the power meter, and measure WLAN/BT output power

### <SAR measurement>

- (a) Use base station simulator to configure EUT WWAN transmission in radiated connection, and engineering software to configure EUT WLAN/BT continuously transmission, at maximum RF power, in the highest power channel.
- (b) Place the EUT in the positions as Appendix D demonstrates.
- (c) Set scan area, grid size and other setting on the DASY software.
- (d) Measure SAR results for the highest power channel on each testing position.
- (e) Find out the largest SAR result on these testing positions of each band
- (f) Measure SAR results for other channels in worst SAR testing position if the reported SAR of highest power channel is larger than 0.8 W/kg

According to the test standard, the recommended procedure for assessing the peak spatial-average SAR value consists of the following steps:

- (a) Power reference measurement
- (b) Area scan
- (c) Zoom scan
- (d) Power drift measurement

### **8.1 Spatial Peak SAR Evaluation**

The procedure for spatial peak SAR evaluation has been implemented according to the test standard. It can be conducted for 1g and 10g, as well as for user-specific masses. The DASY software includes all numerical procedures necessary to evaluate the spatial peak SAR value.

The base for the evaluation is a "cube" measurement. The measured volume must include the 1g and 10g cubes with the highest averaged SAR values. For that purpose, the center of the measured volume is aligned to the interpolated peak SAR value of a previously performed area scan.

The entire evaluation of the spatial peak values is performed within the post-processing engine (SEMCAD). The system always gives the maximum values for the 1g and 10g cubes. The algorithm to find the cube with highest averaged SAR is divided into the following stages:

- (a) Extraction of the measured data (grid and values) from the Zoom Scan
- (b) Calculation of the SAR value at every measurement point based on all stored data (A/D values and measurement parameters)
- (c) Generation of a high-resolution mesh within the measured volume
- (d) Interpolation of all measured values from the measurement grid to the high-resolution grid
- (e) Extrapolation of the entire 3-D field distribution to the phantom surface over the distance from sensor to surface
- (f) Calculation of the averaged SAR within masses of 1g and 10g



**8.2 Power Reference Measurement**

The Power Reference Measurement and Power Drift Measurements are for monitoring the power drift of the device under test in the batch process. The minimum distance of probe sensors to surface determines the closest measurement point to phantom surface. This distance cannot be smaller than the distance of sensor calibration points to probe tip as defined in the probe properties.

**8.3 Area Scan**

The area scan is used as a fast scan in two dimensions to find the area of high field values, before doing a fine measurement around the hot spot. The sophisticated interpolation routines implemented in DASY software can find the maximum found in the scanned area, within a range of the global maximum. The range (in dB0 is specified in the standards for compliance testing. For example, a 2 dB range is required in IEEE standard 1528 and IEC 62209 standards, whereby 3 dB is a requirement when compliance is assessed in accordance with the ARIB standard (Japan), if only one zoom scan follows the area scan, then only the absolute maximum will be taken as reference. For cases where multiple maximums are detected, the number of zoom scans has to be increased accordingly.

Area scan parameters extracted from FCC KDB 865664 D01v01r04 SAR measurement 100 MHz to 6 GHz.

	≤ 3 GHz	> 3 GHz
Maximum distance from closest measurement point (geometric center of probe sensors) to phantom surface	5 ± 1 mm	$\frac{1}{2} \cdot \delta \cdot \ln(2) \pm 0.5$ mm
Maximum probe angle from probe axis to phantom surface normal at the measurement location	30° ± 1°	20° ± 1°
Maximum area scan spatial resolution: $\Delta x_{Area}, \Delta y_{Area}$	≤ 2 GHz: ≤ 15 mm 2 – 3 GHz: ≤ 12 mm	3 – 4 GHz: ≤ 12 mm 4 – 6 GHz: ≤ 10 mm
	When the x or y dimension of the test device, in the measurement plane orientation, is smaller than the above, the measurement resolution must be ≤ the corresponding x or y dimension of the test device with at least one measurement point on the test device.	



**8.4 Zoom Scan**

Zoom scans are used assess the peak spatial SAR values within a cubic averaging volume containing 1 gram and 10 gram of simulated tissue. The zoom scan measures points (refer to table below) within a cube shoes base faces are centered on the maxima found in a preceding area scan job within the same procedure. When the measurement is done, the zoom scan evaluates the averaged SAR for 1 gram and 10 gram and displays these values next to the job's label.

Zoom scan parameters extracted from FCC KDB 865664 D01v01r04 SAR measurement 100 MHz to 6 GHz.

		≤ 3 GHz	> 3 GHz	
Maximum zoom scan spatial resolution: $\Delta x_{Zoom}, \Delta y_{Zoom}$		$\leq 2$ GHz: $\leq 8$ mm 2 – 3 GHz: $\leq 5$ mm*	3 – 4 GHz: $\leq 5$ mm* 4 – 6 GHz: $\leq 4$ mm*	
Maximum zoom scan spatial resolution, normal to phantom surface	uniform grid: $\Delta z_{Zoom}(n)$	$\leq 5$ mm	3 – 4 GHz: $\leq 4$ mm 4 – 5 GHz: $\leq 3$ mm 5 – 6 GHz: $\leq 2$ mm	
	graded grid	$\Delta z_{Zoom}(1)$ : between 1 <sup>st</sup> two points closest to phantom surface	$\leq 4$ mm	3 – 4 GHz: $\leq 3$ mm 4 – 5 GHz: $\leq 2.5$ mm 5 – 6 GHz: $\leq 2$ mm
		$\Delta z_{Zoom}(n>1)$ : between subsequent points	$\leq 1.5 \cdot \Delta z_{Zoom}(n-1)$	
Minimum zoom scan volume	x, y, z	$\geq 30$ mm	3 – 4 GHz: $\geq 28$ mm 4 – 5 GHz: $\geq 25$ mm 5 – 6 GHz: $\geq 22$ mm	
Note: $\delta$ is the penetration depth of a plane-wave at normal incidence to the tissue medium; see draft standard IEEE P1528-2011 for details. * When zoom scan is required and the <i>reported</i> SAR from the <i>area scan based 1-g SAR estimation</i> procedures of KDB 447498 is $\leq 1.4$ W/kg, $\leq 8$ mm, $\leq 7$ mm and $\leq 5$ mm zoom scan resolution may be applied, respectively, for 2 GHz to 3 GHz, 3 GHz to 4 GHz and 4 GHz to 6 GHz.				

**8.5 Volume Scan Procedures**

The volume scan is used for assess overlapping SAR distributions for antennas transmitting in different frequency bands. It is equivalent to an oversized zoom scan used in standalone measurements. The measurement volume will be used to enclose all the simultaneous transmitting antennas. For antennas transmitting simultaneously in different frequency bands, the volume scan is measured separately in each frequency band. In order to sum correctly to compute the 1g aggregate SAR, the EUT remain in the same test position for all measurements and all volume scan use the same spatial resolution and grid spacing. When all volume scan were completed, the software, SEMCAD postprocessor can combine and subsequently superpose these measurement data to calculating the multiband SAR.

**8.6 Power Drift Monitoring**

All SAR testing is under the EUT install full charged battery and transmit maximum output power. In DASy measurement software, the power reference measurement and power drift measurement procedures are used for monitoring the power drift of EUT during SAR test. Both these procedures measure the field at a specified reference position before and after the SAR testing. The software will calculate the field difference in dB. If the power drifts more than 5%, the SAR will be retested.



**9. Test Equipment List**

Manufacturer	Name of Equipment	Type/Model	Serial Number	Calibration	
				Last Cal.	Due Date
SPEAG	750MHz System Validation Kit	D750V3	1099	Nov. 21, 2016	Nov. 20, 2017
SPEAG	835MHz System Validation Kit	D835V2	4d162	Nov. 22, 2016	Nov. 21, 2017
SPEAG	1750MHz System Validation Kit	D1750V2	1137	May 18, 2016	May 17, 2017
SPEAG	1900MHz System Validation Kit	D1900V2	5d182	Nov. 24, 2016	Nov. 23, 2017
SPEAG	2450MHz System Validation Kit	D2450V2	840	Nov. 25, 2016	Nov. 24, 2017
SPEAG	2600MHz System Validation Kit	D2600V2	1070	Nov. 24, 2016	Nov. 23, 2017
SPEAG	Data Acquisition Electronics	DAE4	1338	Nov. 22, 2016	Nov. 21, 2017
SPEAG	Dosimetric E-Field Probe	EX3DV4	3911	Sep. 29, 2016	Sep. 28, 2017
SPEAG	SAM Twin Phantom	SAM V5.0	1795	NCR	NCR
SPEAG	Phone Positioner	N/A	N/A	NCR	NCR
Anritsu	Radio communication analyzer	MT8820C	6201300653	Jul. 16, 2016	Jul. 15, 2017
Agilent	Wireless Communication Test Set	E5515C	MY50267224	Jul. 16, 2016	Jul. 15, 2017
Agilent	Network Analyzer	E5071C	MY46523671	Oct. 11, 2016	Oct. 10, 2017
Speag	Dielectric Assessment KIT	DAK-3.5	1071	Nov. 23, 2016	Nov. 22, 2017
Agilent	Signal Generator	N5181A	MY50145381	Jan. 03, 2017	Jan. 02, 2018
Anritsu	Power Sensor	MA2411B	1306099	Jan. 03, 2017	Jan. 02, 2018
Anritsu	Power Meter	ML2495A	1349001	Jan. 03, 2017	Jan. 02, 2018
Anritsu	Power Sensor	MA2411B	1207253	Jan. 03, 2017	Jan. 02, 2018
Anritsu	Power Meter	ML2495A	1218010	Jan. 03, 2017	Jan. 02, 2018
R&S	Spectrum Analyzer	FSP7	101634	Jul. 16, 2016	Jul. 15, 2017
ARRA	Power Divider	A3200-2	N/A	Note	
PASTERNAK	Dual Directional Coupler	PE2214-10	N/A	Note	
Agilent	Dual Directional Coupler	778D	50422	Note	
MCL	Attenuation1	BW-S10W5	N/A	Note	
Weinschel	Attenuation2	3M-20	N/A	Note	
Zhongjilianhe	Attenuation3	MVE2214-03	N/A	Note	
AR	Amplifier	5S1G4	333096	Note	
mini-circuits	Amplifier	ZVE-3W-83+	162601250	Note	

**Note:**

Prior to system verification and validation, the path loss from the signal generator to the system check source and the power meter, which includes the amplifier, cable, attenuator and directional coupler, was measured by the network analyzer. The reading of the power meter was offset by the path loss difference between the path to the power meter and the path to the system check source to monitor the actual power level fed to the system check source.

## 10. System Verification

### 10.1 Tissue Simulating Liquids

For the measurement of the field distribution inside the SAM phantom with DASY, the phantom must be filled with around 25 liters of homogeneous body tissue simulating liquid. For head SAR testing, the liquid height from the ear reference point (ERP) of the phantom to the liquid top surface is larger than 15 cm, which is shown in Fig. 10.1. For body SAR testing, the liquid height from the center of the flat phantom to the liquid top surface is larger than 15 cm, which is shown in Fig. 10.2.

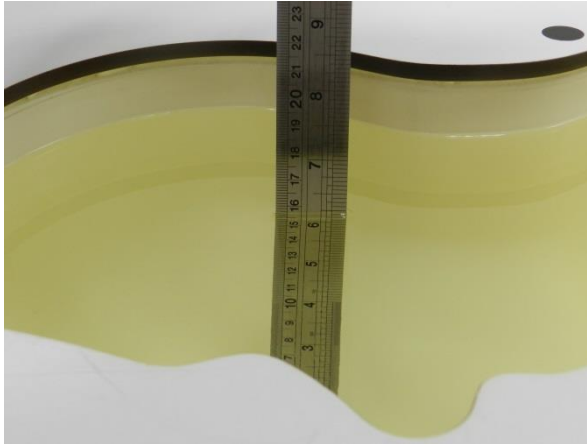

Fig 10.1 Photo of Liquid Height for Head SAR

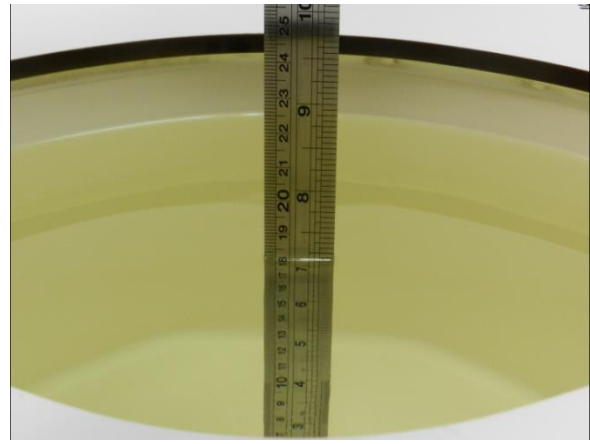

Fig 10.2 Photo of Liquid Height for Body SAR

### 10.2 Tissue Verification

The following tissue formulations are provided for reference only as some of the parameters have not been thoroughly verified. The composition of ingredients may be modified accordingly to achieve the desired target tissue parameters required for routine SAR evaluation.

Frequency (MHz)	Water (%)	Sugar (%)	Cellulose (%)	Salt (%)	Preventol (%)	DGBE (%)	Conductivity ( $\sigma$ )	Permittivity ( $\epsilon_r$ )
<b>For Head</b>								
750	41.1	57.0	0.2	1.4	0.2	0	0.89	41.9
835	40.3	57.9	0.2	1.4	0.2	0	0.90	41.5
1800, 1900, 2000	55.2	0	0	0.3	0	44.5	1.40	40.0
2450	55.0	0	0	0	0	45.0	1.80	39.2
2600	54.8	0	0	0.1	0	45.1	1.96	39.0
<b>For Body</b>								
750	51.7	47.2	0	0.9	0.1	0	0.96	55.5
835	50.8	48.2	0	0.9	0.1	0	0.97	55.2
1800, 1900, 2000	70.2	0	0	0.4	0	29.4	1.52	53.3
2450	68.6	0	0	0	0	31.4	1.95	52.7
2600	68.1	0	0	0.1	0	31.8	2.16	52.5

### <Tissue Dielectric Parameter Check Results>

Frequency (MHz)	Tissue Type	Liquid Temp. (°C)	Conductivity ( $\sigma$ )	Permittivity ( $\epsilon_r$ )	Conductivity Target ( $\sigma$ )	Permittivity Target ( $\epsilon_r$ )	Delta ( $\sigma$ ) (%)	Delta ( $\epsilon_r$ ) (%)	Limit (%)	Date
750	Head	22.7	0.880	40.797	0.89	41.90	-1.12	-2.63	±5	2017/4/13
835	Head	22.8	0.915	41.529	0.90	41.50	1.67	0.07	±5	2017/4/13
1750	Head	22.9	1.378	41.340	1.37	40.10	0.58	3.09	±5	2017/4/14
1900	Head	22.5	1.440	40.038	1.40	40.00	2.86	0.09	±5	2017/4/14
2450	Head	22.7	1.809	37.604	1.80	39.20	0.50	-4.07	±5	2017/4/13
2600	Head	22.6	2.056	37.575	1.96	39.00	4.90	-3.65	±5	2017/4/13
750	Body	22.7	0.961	53.917	0.96	55.50	0.10	-2.85	±5	2017/4/11
835	Body	22.5	0.998	54.379	0.97	55.20	2.89	-1.49	±5	2017/4/11
1750	Body	22.8	1.512	55.273	1.49	53.40	1.48	3.51	±5	2017/4/11
1900	Body	22.6	1.545	53.535	1.52	53.30	1.64	0.44	±5	2017/4/11
2450	Body	22.8	1.976	54.130	1.95	52.70	1.33	2.71	±5	2017/4/13
2600	Body	22.7	2.201	52.823	2.16	52.50	1.90	0.62	±5	2017/4/12

**10.3 System Performance Check Results**

Comparing to the original SAR value provided by SPEAG, the verification data should be within its specification of 10 %. Below table shows the target SAR and measured SAR after normalized to 1W input power. The table below indicates the system performance check can meet the variation criterion and the plots can be referred to Appendix A of this report.

Date	Frequency (MHz)	Tissue Type	Input Power (mW)	Dipole S/N	Probe S/N	DAE S/N	Measured 1g SAR (W/kg)	Targeted 1g SAR (W/kg)	Normalized 1g SAR (W/kg)	Deviation (%)
2017/4/13	750	Head	250	1099	3911	1338	1.93	8.28	7.72	-6.76
2017/4/13	835	Head	250	4d162	3911	1338	2.21	9.31	8.84	-5.05
2017/4/14	1750	Head	250	1137	3911	1338	8.47	36.50	33.88	-7.18
2017/4/14	1900	Head	250	5d182	3911	1338	9.55	40.00	38.2	-4.50
2017/4/13	2450	Head	250	840	3911	1338	13.00	54.00	52	-3.70
2017/4/13	2600	Head	250	1070	3911	1338	14.60	56.80	58.4	2.82
2017/4/11	750	Body	250	1099	3911	1338	2.08	8.71	8.32	-4.48
2017/4/11	835	Body	250	4d162	3911	1338	2.29	9.64	9.16	-4.98
2017/4/11	1750	Body	250	1137	3911	1338	9.29	37.40	37.16	-0.64
2017/4/11	1900	Body	250	5d182	3911	1338	9.91	40.80	39.64	-2.84
2017/4/13	2450	Body	250	840	3911	1338	12.20	50.90	48.8	-4.13
2017/4/12	2600	Body	250	1070	3911	1338	12.80	55.40	51.2	-7.58

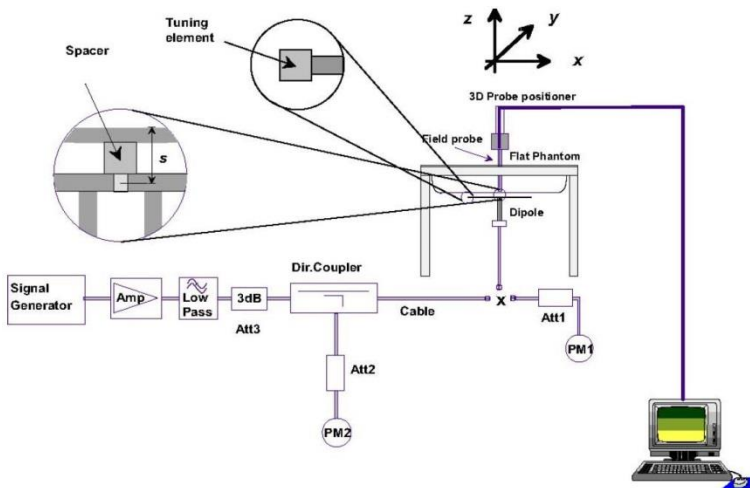

**Fig 8.3.1 System Performance Check Setup**



**Fig 8.3.2 Setup Photo**

## 11. RF Exposure Positions

### 11.1 Ear and handset reference point

Figure 9.1.1 shows the front, back, and side views of the SAM phantom. The center-of-mouth reference point is labeled “M,” the left ear reference point (ERP) is marked “LE,” and the right ERP is marked “RE.” Each ERP is 15 mm along the B-M (back-mouth) line behind the entrance-to-ear-canal (EEC) point, as shown in Figure 9.1.2 The Reference Plane is defined as passing through the two ear reference points and point M. The line N-F (neck-front), also called the reference pivoting line, is normal to the Reference Plane and perpendicular to both a line passing through RE and LE and the B-M line (see Figure 9.1.3). Both N-F and B-M lines should be marked on the exterior of the phantom shell to facilitate handset positioning. Posterior to the N-F line the ear shape is a flat surface with 6 mm thickness at each ERP, and forward of the N-F line the ear is truncated, as illustrated in Figure 9.1.2. The ear truncation is introduced to preclude the ear lobe from interfering with handset tilt, which could lead to unstable positioning at the cheek.

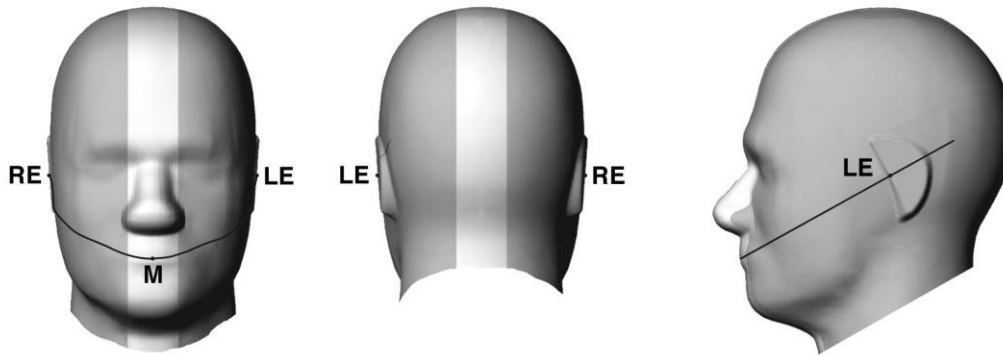

Fig 9.1.1 Front, back, and side views of SAM twin phantom

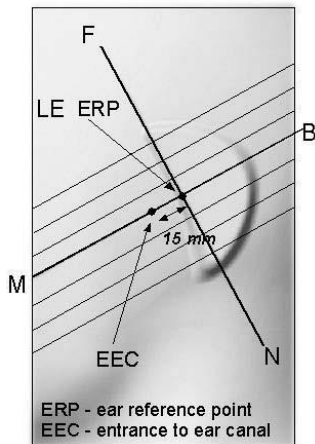

Fig 9.1.2 Close-up side view of phantom showing the ear region.

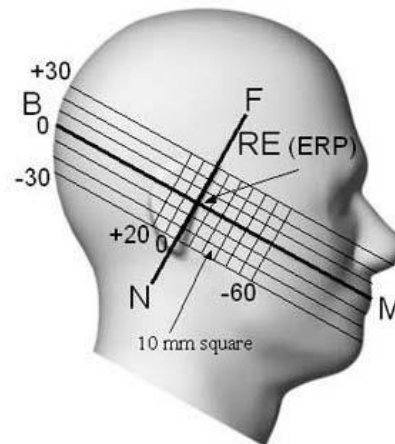
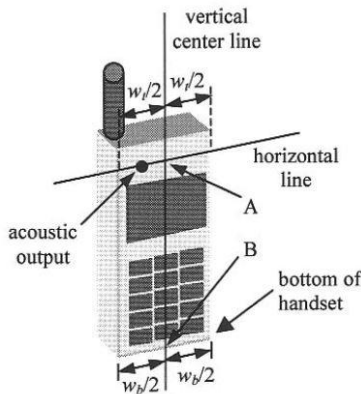

Fig 9.1.3 Side view of the phantom showing relevant markings and seven cross-sectional plane locations



**11.2 Definition of the cheek position**

1. Ready the handset for talk operation, if necessary. For example, for handsets with a cover piece (flip cover), open the cover. If the handset can transmit with the cover closed, both configurations must be tested.
2. Define two imaginary lines on the handset—the vertical centerline and the horizontal line. The vertical centerline passes through two points on the front side of the handset—the midpoint of the width  $w_t$  of the handset at the level of the acoustic output (point A in Figure 9.2.1 and Figure 9.2.2), and the midpoint of the width  $w_b$  of the bottom of the handset (point B). The horizontal line is perpendicular to the vertical centerline and passes through the center of the acoustic output (see Figure 9.2.1). The two lines intersect at point A. Note that for many handsets, point A coincides with the center of the acoustic output; however, the acoustic output may be located elsewhere on the horizontal line. Also note that the vertical centerline is not necessarily parallel to the front face of the handset (see Figure 9.2.2), especially for clamshell handsets, handsets with flip covers, and other irregularly-shaped handsets.
3. Position the handset close to the surface of the phantom such that point A is on the (virtual) extension of the line passing through points RE and LE on the phantom (see Figure 9.2.3), such that the plane defined by the vertical centerline and the horizontal line of the handset is approximately parallel to the sagittal plane of the phantom.
4. Translate the handset towards the phantom along the line passing through RE and LE until handset point A touches the pinna at the ERP.
5. While maintaining the handset in this plane, rotate it around the LE-RE line until the vertical centerline is in the plane normal to the plane containing B-M and N-F lines, i.e., the Reference Plane.
6. Rotate the handset around the vertical centerline until the handset (horizontal line) is parallel to the N-F line.
7. While maintaining the vertical centerline in the Reference Plane, keeping point A on the line passing through RE and LE, and maintaining the handset contact with the pinna, rotate the handset about the N-F line until any point on the handset is in contact with a phantom point below the pinna on the cheek. See Figure 9.2.3. The actual rotation angles should be documented in the test report.



**Fig 9.2.1 Handset vertical and horizontal reference lines—“fixed case”**

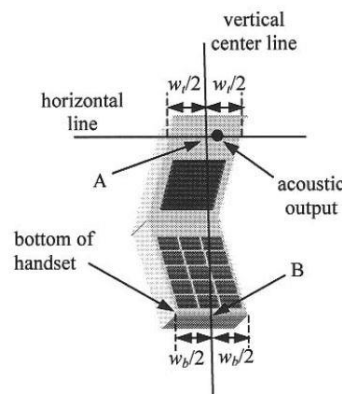

**Fig 9.2.2 Handset vertical and horizontal reference lines—“clam-shell case”**

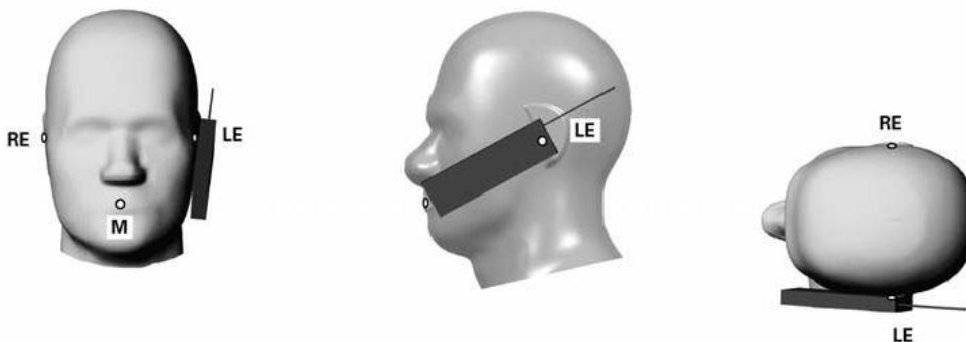

**Fig 9.2.3 cheek or touch position. The reference points for the right ear (RE), left ear (LE), and mouth (M), which establish the Reference Plane for handset positioning, are indicated.**

### **11.3 Definition of the tilt position**

1. Ready the handset for talk operation, if necessary. For example, for handsets with a cover piece (flip cover), open the cover. If the handset can transmit with the cover closed, both configurations must be tested.
2. While maintaining the orientation of the handset, move the handset away from the pinna along the line passing through RE and LE far enough to allow a rotation of the handset away from the cheek by 15°.
3. Rotate the handset around the horizontal line by 15°.
4. While maintaining the orientation of the handset, move the handset towards the phantom on the line passing through RE and LE until any part of the handset touches the ear. The tilt position is obtained when the contact point is on the pinna. See Figure 9.3.1. If contact occurs at any location other than the pinna, e.g., the antenna at the back of the phantom head, the angle of the handset should be reduced. In this case, the tilt position is obtained if any point on the handset is in contact with the pinna and a second point

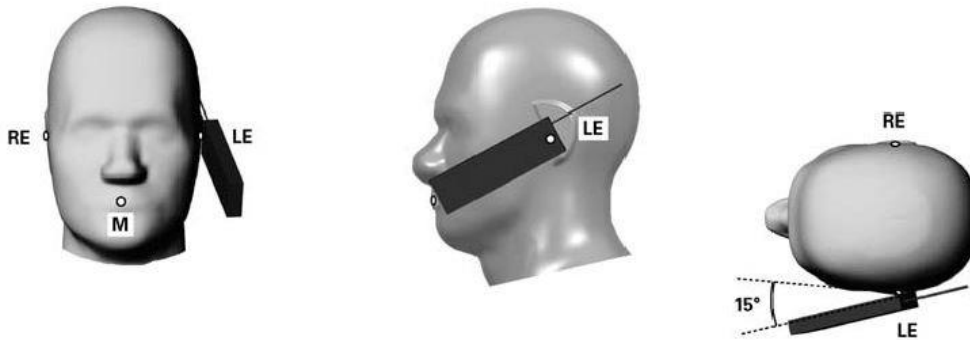

**Fig 9.3.1 Tilt position. The reference points for the right ear (RE), left ear (LE), and mouth (M), which define the Reference Plane for handset positioning, are indicated.**



### **11.4 Body Worn Accessory**

Body-worn operating configurations are tested with the belt-clips and holsters attached to the device and positioned against a flat phantom in a normal use configuration (see Figure 9.4). Per KDB648474 D04v01r03, body-worn accessory exposure is typically related to voice mode operations when handsets are carried in body-worn accessories. The body-worn accessory procedures in FCC KDB 447498 D01v06 should be used to test for body-worn accessory SAR compliance, without a headset connected to it. This enables the test results for such configuration to be compatible with that required for hotspot mode when the body-worn accessory test separation distance is greater than or equal to that required for hotspot mode, when applicable. When the reported SAR for body-worn accessory, measured without a headset connected to the handset is  $> 1.2$  W/kg, the highest reported SAR configuration for that wireless mode and frequency band should be repeated for that body-worn accessory with a headset attached to the handset.

Accessories for body-worn operation configurations are divided into two categories: those that do not contain metallic components and those that do contain metallic components. When multiple accessories that do not contain metallic components are supplied with the device, the device is tested with only the accessory that dictates the closest spacing to the body. Then multiple accessories that contain metallic components are test with the device with each accessory. If multiple accessories share an identical metallic component (i.e. the same metallic belt-clip used with different holsters with no other metallic components) only the accessory that dictates the closest spacing to the body is tested.

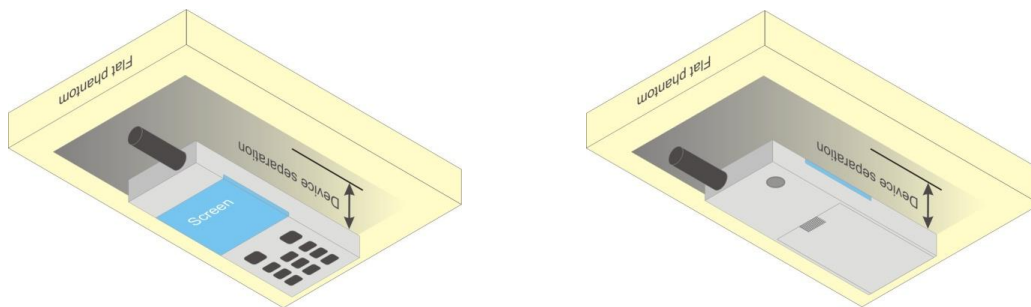

**Fig 9.4 Body Worn Position**

### **11.5 Wireless Router**

Some battery-operated handsets have the capability to transmit and receive user through simultaneous transmission of WIFI simultaneously with a separate licensed transmitter. The FCC has provided guidance in FCC KDB Publication 941225 D06 v02r01 where SAR test considerations for handsets ( $L \times W \geq 9 \text{ cm} \times 5 \text{ cm}$ ) are based on a composite test separation distance of 10mm from the front, back and edges of the device containing transmitting antennas within 2.5cm of their edges, determined from general mixed use conditions for this type of devices. Since the hotspot SAR results may overlap with the body-worn accessory SAR requirements, the more conservative configurations can be considered, thus excluding some body-worn accessory SAR tests.

When the user enables the personal wireless router functions for the handset, actual operations include simultaneous transmission of both the WIFI transmitter and another licensed transmitter. Both transmitters often do not transmit at the same transmitting frequency and thus cannot be evaluated for SAR under actual use conditions due to the limitations of the SAR assessment probes. Therefore, SAR must be evaluated for each frequency transmission and mode separately and spatially summed with the WIFI transmitter according to FCC KDB Publication 447498 D01v06 publication procedures. The "Portable Hotspot" feature on the handset was NOT activated during SAR assessments, to ensure the SAR measurements were evaluated for a single transmission frequency RF signal at a time.



## 12. Conducted RF Output Power (Unit: dBm)

### <GSM Conducted Power>

- Per KDB 447498 D01v06, the maximum output power channel is used for SAR testing and for further SAR test reduction.
- Per KDB 941225 D01v03r01, for SAR test reduction for GSM / GPRS / EDGE modes is determined by the source-based time-averaged output power including tune-up tolerance. The mode with highest specified time-averaged output power should be tested for SAR compliance in the applicable exposure conditions. For modes with the same specified maximum output power and tolerance, the higher number time-slot configuration should be tested. Therefore, the GPRS (4Tx slots) for GSM850/GSM1900 is considered as the primary mode.
- Other configurations of GSM / GPRS / EDGE are considered as secondary modes. The 3G SAR test reduction procedure is applied, when the maximum output power and tune-up tolerance specified for production units in a secondary mode is  $\leq \frac{1}{4}$  dB higher than the primary mode, SAR measurement is not required for the secondary mode

GSM850 Tx Channel	Burst Average Power (dBm)			Tune-up Limit (dBm)	Frame-Average Power (dBm)			Tune-up Limit (dBm)
	128	189	251		128	189	251	
Frequency (MHz)	824.2	836.4	848.8		824.2	836.4	848.8	
GSM 1 Tx slot	32.21	<b>32.32</b>	32.30	32.50	23.21	23.32	23.30	23.50
GPRS 1 Tx slot	32.20	32.30	32.27	32.50	23.20	23.30	23.27	23.50
GPRS 2 Tx slots	31.43	31.56	31.54	32.00	25.43	25.56	25.54	26.00
GPRS 3 Tx slots	29.69	29.82	29.82	30.00	25.43	25.56	25.56	25.74
GPRS 4 Tx slots	28.60	28.70	28.73	29.00	25.60	25.70	<b>25.73</b>	26.00
EDGE 1 Tx slot	26.50	26.60	26.82	27.50	17.50	17.60	17.82	18.50
EDGE 2 Tx slots	25.16	25.50	25.61	26.50	19.16	19.50	19.61	20.50
EDGE 3 Tx slots	23.25	23.42	23.52	24.50	18.99	19.16	19.26	20.24
EDGE 4 Tx slots	22.00	22.11	22.23	23.50	19.00	19.11	19.23	20.50

**Remark:** The frame-averaged power is linearly scaled the maximum burst averaged power over 8 time slots.  
The calculated method are shown as below:  
Frame-averaged power = Maximum burst averaged power (1 Tx Slot) - 9 dB  
Frame-averaged power = Maximum burst averaged power (2 Tx Slots) - 6 dB  
Frame-averaged power = Maximum burst averaged power (3 Tx Slots) - 4.26 dB  
Frame-averaged power = Maximum burst averaged power (4 Tx Slots) - 3 dB

GSM1900 Tx Channel	Burst Average Power (dBm)			Tune-up Limit (dBm)	Frame-Average Power (dBm)			Tune-up Limit (dBm)
	512	661	810		512	661	810	
Frequency (MHz)	1850.2	1880	1909.8		1850.2	1880	1909.8	
GSM 1 Tx slot	<b>29.58</b>	29.50	29.33	30.00	20.58	20.50	20.33	21.00
GPRS 1 Tx slot	29.57	29.48	29.35	30.00	20.57	20.48	20.35	21.00
GPRS 2 Tx slots	28.89	28.79	28.68	29.00	22.89	22.79	22.68	23.00
GPRS 3 Tx slots	27.28	27.20	27.05	27.50	23.02	22.94	22.79	23.24
GPRS 4 Tx slots	26.23	26.21	26.06	26.50	<b>23.23</b>	23.21	23.06	23.50
EDGE 1 Tx slot	25.40	25.67	25.51	26.50	16.40	16.67	16.51	17.50
EDGE 2 Tx slots	24.32	24.75	24.52	25.50	18.32	18.75	18.52	19.50
EDGE 3 Tx slots	22.34	22.63	22.54	23.50	18.08	18.37	18.28	19.24
EDGE 4 Tx slots	21.34	21.53	21.49	22.50	18.34	18.53	18.49	19.50

**Remark:** The frame-averaged power is linearly scaled the maximum burst averaged power over 8 time slots.  
The calculated method are shown as below:  
Frame-averaged power = Maximum burst averaged power (1 Tx Slot) - 9 dB  
Frame-averaged power = Maximum burst averaged power (2 Tx Slots) - 6 dB  
Frame-averaged power = Maximum burst averaged power (3 Tx Slots) - 4.26 dB  
Frame-averaged power = Maximum burst averaged power (4 Tx Slots) - 3 dB

**<WCDMA Conducted Power>**

1. The following tests were conducted according to the test requirements outlines in 3GPP TS 34.121 specification.
2. The procedures in KDB 941225 D01v03r01 are applied for 3GPP Rel. 6 HSPA to configure the device in the required sub-test mode(s) to determine SAR test exclusion.

A summary of these settings are illustrated below:

**HSDPA Setup Configuration:**

- a. The EUT was connected to Base Station Agilent E5515C referred to the Setup Configuration.
- b. The RF path losses were compensated into the measurements.
- c. A call was established between EUT and Base Station with following setting:
  - i. Set Gain Factors ( $\beta_c$  and  $\beta_d$ ) and parameters were set according to each
  - ii. Specific sub-test in the following table, C10.1.4, quoted from the TS 34.121
  - iii. Set RMC 12.2Kbps + HSDPA mode.
  - iv. Set Cell Power = -86 dBm
  - v. Set HS-DSCH Configuration Type to FRC (H-set 1, QPSK)
  - vi. Select HSDPA Uplink Parameters
  - vii. Set Delta ACK, Delta NACK and Delta CQI = 8
  - viii. Set Ack-Nack Repetition Factor to 3
  - ix. Set CQI Feedback Cycle (k) to 4 ms
  - x. Set CQI Repetition Factor to 2
  - xi. Power Ctrl Mode = All Up bits
- d. The transmitted maximum output power was recorded.

**Table C.10.1.4:  $\beta$  values for transmitter characteristics tests with HS-DPCCH**

Sub-test	$\beta_c$	$\beta_d$	$\beta_d$ (SF)	$\beta_c/\beta_d$	$\beta_{HS}$ (Note 1, Note 2)	CM (dB) (Note 3)	MPR (dB) (Note 3)
1	2/15	15/15	64	2/15	4/15	0.0	0.0
2	12/15 (Note 4)	15/15 (Note 4)	64	12/15 (Note 4)	24/15	1.0	0.0
3	15/15	8/15	64	15/8	30/15	1.5	0.5
4	15/15	4/15	64	15/4	30/15	1.5	0.5

Note 1:  $\Delta_{ACK}, \Delta_{NACK}$  and  $\Delta_{CQI} = 30/15$  with  $\beta_{HS} = 30/15 * \beta_c$ .

Note 2: For the HS-DPCCH power mask requirement test in clause 5.2C, 5.7A, and the Error Vector Magnitude (EVM) with HS-DPCCH test in clause 5.13.1A, and HSDPA EVM with phase discontinuity in clause 5.13.1AA,  $\Delta_{ACK}$  and  $\Delta_{NACK} = 30/15$  with  $\beta_{HS} = 30/15 * \beta_c$ , and  $\Delta_{CQI} = 24/15$  with  $\beta_{HS} = 24/15 * \beta_c$ .

Note 3: CM = 1 for  $\beta_c/\beta_d = 12/15, \beta_{HS}/\beta_c = 24/15$ . For all other combinations of DPDCH, DPCCH and HS-DPCCH the MPR is based on the relative CM difference. This is applicable for only UEs that support HSDPA in release 6 and later releases.

Note 4: For subtest 2 the  $\beta_c/\beta_d$  ratio of 12/15 for the TFC during the measurement period (TF1, TF0) is achieved by setting the signalled gain factors for the reference TFC (TF1, TF1) to  $\beta_c = 11/15$  and  $\beta_d = 15/15$ .

**Setup Configuration**

**HSUPA Setup Configuration:**

- a. The EUT was connected to Base Station Agilent E5515C referred to the Setup Configuration.
- b. The RF path losses were compensated into the measurements.
- c. A call was established between EUT and Base Station with following setting \* :
  - i. Call Configs = 5.2B, 5.9B, 5.10B, and 5.13.2B with QPSK
  - ii. Set the Gain Factors ( $\beta_c$  and  $\beta_d$ ) and parameters (AG Index) were set according to each specific sub-test in the following table, C11.1.3, quoted from the TS 34.121
  - iii. Set Cell Power = -86 dBm
  - iv. Set Channel Type = 12.2k + HSPA
  - v. Set UE Target Power
  - vi. Power Ctrl Mode= Alternating bits
  - vii. Set and observe the E-TFCl
  - viii. Confirm that E-TFCl is equal to the target E-TFCl of 75 for sub-test 1, and other subtest's E-TFCl
- d. The transmitted maximum output power was recorded.

**Table C.11.1.3:  $\beta$  values for transmitter characteristics tests with HS-DPCCH and E-DCH**

Sub-test	$\beta_c$	$\beta_d$	$\beta_d$ (SF)	$\beta_c/\beta_d$	$\beta_{HS}$ (Note 1)	$\beta_{ec}$	$\beta_{ed}$ (Note 5) (Note 6)	$\beta_{ed}$ (SF)	$\beta_{ed}$ (Codes)	CM (dB) (Note 2)	MPR (dB) (Note 2)	AG Index (Note 6)	E-TFCl
1	11/15 (Note 3)	15/15 (Note 3)	64	11/15 (Note 3)	22/15	209/25	1309/225	4	1	1.0	0.0	20	75
2	6/15	15/15	64	6/15	12/15	12/15	94/75	4	1	3.0	2.0	12	67
3	15/15	9/15	64	15/9	30/15	30/15	$\beta_{ed1}: 47/15$ $\beta_{ed2}: 47/15$	4 4	2	2.0	1.0	15	92
4	2/15	15/15	64	2/15	4/15	2/15	56/75	4	1	3.0	2.0	17	71
5	15/15 (Note 4)	15/15 (Note 4)	64	15/15 (Note 4)	30/15	24/15	134/15	4	1	1.0	0.0	21	81

Note 1:  $\Delta_{ACK}, \Delta_{NACK}$  and  $\Delta_{CQI} = 30/15$  with  $\beta_{hs} = 30/15 * \beta_c$ .

Note 2: CM = 1 for  $\beta_c/\beta_d = 12/15, \beta_{hs}/\beta_c = 24/15$ . For all other combinations of DPDCH, DPCCH, HS- DPCCH, E-DPDCH and E-DPCCH the MPR is based on the relative CM difference.

Note 3: For subtest 1 the  $\beta_c/\beta_d$  ratio of 11/15 for the TFC during the measurement period (TF1, TF0) is achieved by setting the signalled gain factors for the reference TFC (TF1, TF1) to  $\beta_c = 10/15$  and  $\beta_d = 15/15$ .

Note 4: For subtest 5 the  $\beta_c/\beta_d$  ratio of 15/15 for the TFC during the measurement period (TF1, TF0) is achieved by setting the signalled gain factors for the reference TFC (TF1, TF1) to  $\beta_c = 14/15$  and  $\beta_d = 15/15$ .

Note 5: In case of testing by UE using E-DPDCH Physical Layer category 1, Sub-test 3 is omitted according to TS25.306 Table 5.1g.

Note 6:  $\beta_{ed}$  can not be set directly, it is set by Absolute Grant Value.

**Setup Configuration**



<WCDMA Conducted Power>

General Note:

1. Per KDB 941225 D01v03r01, for SAR testing is measured using a 12.2 kbps RMC with TPC bits configured to all "1's".
2. Per KDB 941225 D01v03r01, RMC 12.2kbps setting is used to evaluate SAR. If the maximum output power and tune-up tolerance specified for production units in HSDPA / HSUPA is  $\leq 1/4$  dB higher than RMC 12.2Kbps or when the highest reported SAR of the RMC12.2Kbps is scaled by the ratio of specified maximum output power and tune-up tolerance of HSDPA / HSUPA to RMC12.2Kbps and the adjusted SAR is  $\leq 1.2$  W/kg, SAR measurement is not required for HSDPA / HSUPA.

Band		WCDMA Band II			Tune-up Limit (dBm)	WCDMA Band V			Tune-up Limit (dBm)
TX Channel		9262	9400	9538		4132	4182	4233	
Rx Channel		9662	9800	9938		4357	4407	4458	
Frequency (MHz)		1852.4	1880	1907.6		826.4	836.4	846.6	
3GPP Rel 99	AMR 12.2Kbps	21.73	21.87	22.00	22.50	21.65	21.73	21.58	22.00
3GPP Rel 99	RMC 12.2Kbps	21.75	21.88	22.01	22.50	21.66	21.75	21.60	22.00
3GPP Rel 6	HSDPA Subtest-1	20.64	20.73	20.64	21.00	20.66	20.68	20.51	21.00
3GPP Rel 6	HSDPA Subtest-2	20.66	20.73	20.49	21.00	20.72	20.68	20.53	21.00
3GPP Rel 6	HSDPA Subtest-3	20.26	20.23	20.01	20.50	20.23	20.25	20.05	20.50
3GPP Rel 6	HSDPA Subtest-4	20.25	20.20	20.04	20.50	20.19	20.23	20.03	20.50
3GPP Rel 6	HSUPA Subtest-1	18.75	18.72	18.77	19.00	18.67	18.67	18.51	19.00
3GPP Rel 6	HSUPA Subtest-2	18.76	18.75	18.72	19.00	18.70	18.74	18.53	19.00
3GPP Rel 6	HSUPA Subtest-3	19.72	19.76	19.74	20.00	19.72	19.72	19.54	20.00
3GPP Rel 6	HSUPA Subtest-4	18.22	18.23	18.26	18.50	18.15	18.20	17.93	18.50
3GPP Rel 6	HSUPA Subtest-5	20.70	20.70	20.80	21.00	20.70	20.70	20.50	21.00



**<LTE Conducted Power>**

**General Note:**

1. Anritsu MT8820C base station simulator was used to setup the connection with EUT; the frequency band, channel bandwidth, RB allocation configuration, modulation type are set in the base station simulator to configure EUT transmitting at maximum power and at different configurations which are requested to be reported to FCC, for conducted power measurement and SAR testing.
2. Per KDB 941225 D05v02r05, when a properly configured base station simulator is used for the SAR and power measurements, spectrum plots for each RB allocation and offset configuration is not required.
3. Per KDB 941225 D05v02r05, start with the largest channel bandwidth and measure SAR for QPSK with 1 RB allocation, using the RB offset and required test channel combination with the highest maximum output power for RB offsets at the upper edge, middle and lower edge of each required test channel.
4. Per KDB 941225 D05v02r05, 50% RB allocation for QPSK SAR testing follows 1RB QPSK allocation procedure.
5. Per KDB 941225 D05v02r05, For QPSK with 100% RB allocation, SAR is not required when the highest maximum output power for 100 % RB allocation is less than the highest maximum output power in 50% and 1 RB allocations and the highest reported SAR for 1 RB and 50% RB allocation are  $\leq 0.8$  W/kg. Otherwise, SAR is measured for the highest output power channel; and if the reported SAR is  $> 1.45$  W/kg, the remaining required test channels must also be tested.
6. Per KDB 941225 D05v02r05, 16QAM output power for each RB allocation configuration is  $>$  not  $\frac{1}{2}$  dB higher than the same configuration in QPSK and the reported SAR for the QPSK configuration is  $\leq 1.45$  W/kg; Per KDB 941225 D05v02r05, 16QAM SAR testing is not required.
7. Per KDB 941225 D05v02r05, Smaller bandwidth output power for each RB allocation configuration is  $>$  not  $\frac{1}{2}$  dB higher than the same configuration in the largest supported bandwidth, and the reported SAR for the largest supported bandwidth is  $\leq 1.45$  W/kg; Per KDB 941225 D05v02r05, smaller bandwidth SAR testing is not required.
8. For LTE B4 the maximum bandwidth does not support three non-overlapping channels, per KDB 941225 D05v02r05, when a device supports overlapping channel assignment in a channel bandwidth configuration, the middle channel of the group of overlapping channels should be selected for testing.



<LTE Band 4>

BW [MHz]	Modulation	RB Size	RB Offset	Power Low Ch. / Freq.	Power Middle Ch. / Freq.	Power High Ch. / Freq.	Tune-up limit (dBm)	MPR (dB)
Channel				20050	20175	20300		
Frequency (MHz)				1720	1732.5	1745		
20	QPSK	1	0	21.65	21.72	21.58	22.0	0
20	QPSK	1	49	21.56	21.58	21.50		
20	QPSK	1	99	21.43	21.49	21.28		
20	QPSK	50	0	20.65	20.61	20.61	21.0	1
20	QPSK	50	24	20.57	20.57	20.55		
20	QPSK	50	50	20.52	20.52	20.46		
20	QPSK	100	0	20.56	20.55	20.51	21.5	0.5
20	16QAM	1	0	21.23	20.85	20.60		
20	16QAM	1	49	21.08	20.74	20.51		
20	16QAM	1	99	20.97	20.66	20.27	20.0	2
20	16QAM	50	0	19.68	19.63	19.65		
20	16QAM	50	24	19.60	19.55	19.56		
20	16QAM	50	50	19.51	19.52	19.55	20.0	2
20	16QAM	100	0	19.57	19.55	19.52		
Channel				20025	20175	20325		
Frequency (MHz)				1717.5	1732.5	1747.5		
15	QPSK	1	0	21.60	21.59	21.55	22.0	0
15	QPSK	1	37	21.54	21.52	21.45		
15	QPSK	1	74	21.41	21.44	21.28		
15	QPSK	36	0	20.66	20.64	20.54	21.0	1
15	QPSK	36	20	20.64	20.60	20.48		
15	QPSK	36	39	20.54	20.51	20.44		
15	QPSK	75	0	20.59	20.59	20.48	21.5	0.5
15	16QAM	1	0	21.21	21.18	20.79		
15	16QAM	1	37	21.18	20.76	20.68		
15	16QAM	1	74	21.02	20.71	20.57	20.0	2
15	16QAM	36	0	19.72	19.62	19.56		
15	16QAM	36	20	19.66	19.58	19.53		
15	16QAM	36	39	19.62	19.51	19.49	20.0	2
15	16QAM	75	0	19.63	19.61	19.54		





Channel				20000	20175	20350	Tune-up limit (dBm)	MPR (dB)
Frequency (MHz)				1715	1732.5	1750		
10	QPSK	1	0	21.46	21.61	21.50	22.0	0
10	QPSK	1	25	21.40	21.54	21.41		
10	QPSK	1	49	21.34	21.47	21.26		
10	QPSK	25	0	20.61	20.57	20.42	21.0	1
10	QPSK	25	12	20.58	20.51	20.42		
10	QPSK	25	25	20.49	20.47	20.34		
10	QPSK	50	0	20.60	20.56	20.38	21.5	0.5
10	16QAM	1	0	21.11	21.14	21.05		
10	16QAM	1	25	21.04	21.06	20.59		
10	16QAM	1	49	20.92	20.98	20.47	20.0	2
10	16QAM	25	0	19.56	19.53	19.55		
10	16QAM	25	12	19.55	19.53	19.51		
10	16QAM	25	25	19.48	19.49	19.46	19.58	19.44
10	16QAM	50	0	19.58	19.58	19.44		
Channel				19975	20175	20375	Tune-up limit (dBm)	MPR (dB)
Frequency (MHz)				1712.5	1732.5	1752.5		
5	QPSK	1	0	21.51	21.48	21.31	22.0	0
5	QPSK	1	12	21.56	21.52	21.27		
5	QPSK	1	24	21.43	21.39	21.15		
5	QPSK	12	0	20.62	20.57	20.42	21.0	1
5	QPSK	12	7	20.61	20.54	20.38		
5	QPSK	12	13	20.61	20.55	20.36		
5	QPSK	25	0	20.60	20.52	20.33	21.5	0.5
5	16QAM	1	0	20.77	21.09	20.93		
5	16QAM	1	12	20.79	21.08	20.88		
5	16QAM	1	24	20.69	20.96	20.80	20.0	2
5	16QAM	12	0	19.66	19.68	19.51		
5	16QAM	12	7	19.66	19.67	19.48		
5	16QAM	12	13	19.65	19.60	19.36	19.56	19.37
5	16QAM	25	0	19.56	19.55	19.37		





Channel				19965	20175	20385	Tune-up limit (dBm)	MPR (dB)
Frequency (MHz)				1711.5	1732.5	1753.5		
3	QPSK	1	0	21.41	21.35	21.27	22.0	0
3	QPSK	1	8	21.47	21.36	21.29		
3	QPSK	1	14	21.41	21.32	21.22		
3	QPSK	8	0	20.59	20.53	20.36	21.0	1
3	QPSK	8	4	20.58	20.54	20.35		
3	QPSK	8	7	20.57	20.54	20.31		
3	QPSK	15	0	20.57	20.49	20.29	21.5	0.5
3	16QAM	1	0	20.73	20.93	20.73		
3	16QAM	1	8	20.82	20.92	20.72		
3	16QAM	1	14	20.75	20.84	20.71	20.0	2
3	16QAM	8	0	19.56	19.63	19.50		
3	16QAM	8	4	19.53	19.63	19.45		
3	16QAM	8	7	19.54	19.64	19.44	20.0	2
3	16QAM	15	0	19.63	19.46	19.39		
Channel				19957	20175	20393	Tune-up limit (dBm)	MPR (dB)
Frequency (MHz)				1710.7	1732.5	1754.3		
1.4	QPSK	1	0	21.47	21.45	21.18	22.0	0
1.4	QPSK	1	3	21.50	21.52	21.27		
1.4	QPSK	1	5	21.43	21.45	21.12		
1.4	QPSK	3	0	21.58	21.57	21.34		
1.4	QPSK	3	1	21.50	21.53	21.31		
1.4	QPSK	3	3	21.56	21.59	21.30	21.0	1
1.4	QPSK	6	0	20.58	20.55	20.33		
1.4	16QAM	1	0	20.49	20.51	20.45	21.5	0.5
1.4	16QAM	1	3	20.56	20.55	20.44		
1.4	16QAM	1	5	20.50	20.51	20.39		
1.4	16QAM	3	0	20.70	20.49	20.41		
1.4	16QAM	3	1	20.47	20.42	20.40		
1.4	16QAM	3	3	20.48	20.46	20.42	20.0	2
1.4	16QAM	6	0	19.63	19.58	19.51		



<LTE Band 7>

BW [MHz]	Modulation	RB Size	RB Offset	Measured Power			Tune-up limit (dBm)	MPR (dB)
Channel				20850	21100	21350		
Frequency (MHz)				2510	2535	2560		
20	QPSK	1	0	21.56	21.75	22.18	22.5	0
20	QPSK	1	49	21.48	21.94	22.03		
20	QPSK	1	99	21.65	22.09	22.03		
20	QPSK	50	0	20.58	20.92	21.26	21.5	1
20	QPSK	50	24	20.61	21.00	21.23		
20	QPSK	50	50	20.68	21.09	21.19		
20	QPSK	100	0	20.64	20.99	21.18	21.5	1
20	16QAM	1	0	20.67	20.98	21.38		
20	16QAM	1	49	20.65	21.15	21.34		
20	16QAM	1	99	20.83	21.27	21.20	20.5	2
20	16QAM	50	0	19.60	19.93	20.17		
20	16QAM	50	24	19.59	19.98	20.14		
20	16QAM	50	50	19.69	19.16	20.14	20.5	2
20	16QAM	100	0	19.63	19.98	20.14		
Channel				20825	21100	21375		
Frequency (MHz)				2507.5	2535	2562.5	Tune-up limit (dBm)	MPR (dB)
15	QPSK	1	0	21.53	21.69	22.10	22.5	0
15	QPSK	1	37	21.50	21.74	22.13		
15	QPSK	1	74	21.58	22.10	21.98		
15	QPSK	36	0	20.58	20.98	21.16	21.5	1
15	QPSK	36	20	20.59	21.43	21.11		
15	QPSK	36	39	20.62	21.40	21.04		
15	QPSK	75	0	20.59	21.49	21.13	21.5	1
15	16QAM	1	0	20.84	21.46	21.23		
15	16QAM	1	37	20.87	20.31	21.35		
15	16QAM	1	74	20.98	20.59	21.09	20.5	2
15	16QAM	36	0	19.53	20.42	20.15		
15	16QAM	36	20	18.88	19.43	20.12		
15	16QAM	36	39	19.16	19.81	20.06	20.5	2
15	16QAM	75	0	19.53	19.98	20.11		



Channel				20800	21100	21400	Tune-up limit (dBm)	MPR (dB)
Frequency (MHz)				2505	2535	2565		
10	QPSK	1	0	21.49	21.97	22.09	22.5	0
10	QPSK	1	25	21.52	21.98	22.01		
10	QPSK	1	49	21.24	22.09	21.88		
10	QPSK	25	0	20.55	20.91	21.02	21.5	1
10	QPSK	25	12	20.53	20.96	20.99		
10	QPSK	25	25	20.51	20.98	20.98		
10	QPSK	50	0	20.57	21.03	21.12	21.5	1
10	16QAM	1	0	20.50	20.74	21.04		
10	16QAM	1	25	20.56	20.81	21.04		
10	16QAM	1	49	20.55	20.83	20.85	20.5	2
10	16QAM	25	0	19.57	19.90	20.04		
10	16QAM	25	12	19.54	19.92	20.01		
10	16QAM	25	25	19.55	19.91	19.97	20.5	2
10	16QAM	50	0	19.53	20.02	20.01		
Channel				20775	21100	21425	Tune-up limit (dBm)	MPR (dB)
Frequency (MHz)				2502.5	2535	2567.5		
5	QPSK	1	0	21.41	21.82	21.97	22.5	0
5	QPSK	1	12	21.40	21.88	21.86		
5	QPSK	1	24	21.39	21.82	21.76		
5	QPSK	12	0	20.51	20.97	21.03	21.5	1
5	QPSK	12	7	20.52	21.01	20.97		
5	QPSK	12	13	20.49	21.02	20.94		
5	QPSK	25	0	20.50	20.93	21.01	21.5	1
5	16QAM	1	0	20.53	21.00	21.35		
5	16QAM	1	12	20.47	21.06	21.28		
5	16QAM	1	24	20.46	20.98	21.19	20.5	2
5	16QAM	12	0	19.53	19.95	20.03		
5	16QAM	12	7	19.52	19.99	20.00		
5	16QAM	12	13	19.50	19.99	19.94	20.5	2
5	16QAM	25	0	19.41	19.93	20.00		



<LTE Band 28>

BW [MHz]	Modulation	RB Size	RB Offset	Power Low Ch. / Freq.	Power Middle Ch. / Freq.	Power High Ch. / Freq.	Tune-up limit (dBm)	MPR (dB)
Channel				27310	27435	27560		
Frequency (MHz)				713	725.5	738		
20	QPSK	1	0	21.93	21.95	22.02		
20	QPSK	1	49	21.93	21.97	22.05	22.5	0
20	QPSK	1	99	22.08	22.22	22.26		
20	QPSK	50	0	21.14	21.11	21.16		
20	QPSK	50	24	21.18	21.14	21.16	21.5	1
20	QPSK	50	50	21.25	21.18	21.26		
20	QPSK	100	0	21.16	21.06	21.14		
20	16QAM	1	0	21.15	21.38	21.45	22.0	0.5
20	16QAM	1	49	21.16	21.53	21.46		
20	16QAM	1	99	21.28	21.73	21.59		
20	16QAM	50	0	20.08	20.18	20.15	20.5	2
20	16QAM	50	24	20.11	20.05	20.15		
20	16QAM	50	50	20.17	20.16	20.23		
20	16QAM	100	0	20.06	20.06	20.08		
Channel				27285	27435	27585	Tune-up limit (dBm)	MPR (dB)
Frequency (MHz)				710.5	725.5	740.5		
15	QPSK	1	0	22.02	21.95	21.92	22.5	0
15	QPSK	1	37	22.00	22.06	22.03		
15	QPSK	1	74	22.08	22.02	22.13		
15	QPSK	36	0	21.15	21.13	21.11	21.5	1
15	QPSK	36	20	21.25	21.13	21.15		
15	QPSK	36	39	21.25	21.09	21.15		
15	QPSK	75	0	21.18	21.19	21.11	22.0	0.5
15	16QAM	1	0	20.95	21.11	21.28		
15	16QAM	1	37	21.09	21.47	20.88		
15	16QAM	1	74	21.26	21.19	21.25	20.5	2
15	16QAM	36	0	20.14	20.07	20.07		
15	16QAM	36	20	20.24	20.15	20.04		
15	16QAM	36	39	20.22	20.17	20.16		
15	16QAM	75	0	20.19	20.07	20.10		



Channel				27260	27435	27610	Tune-up limit (dBm)	MPR (dB)
Frequency (MHz)				708	725.5	743		
10	QPSK	1	0	22.11	21.97	22.03	22.5	0
10	QPSK	1	25	22.00	22.10	21.98		
10	QPSK	1	49	21.99	22.02	22.20		
10	QPSK	25	0	21.13	21.10	21.03	21.5	1
10	QPSK	25	12	21.09	21.10	21.10		
10	QPSK	25	25	21.20	21.08	21.13		
10	QPSK	50	0	21.14	21.14	21.17	22.0	0.5
10	16QAM	1	0	20.95	21.50	21.10		
10	16QAM	1	25	21.14	21.12	21.44		
10	16QAM	1	49	21.56	21.35	21.26	20.5	2
10	16QAM	25	0	20.18	20.13	20.11		
10	16QAM	25	12	20.10	20.07	20.02		
10	16QAM	25	25	20.23	20.02	20.13	20.5	2
10	16QAM	50	0	20.14	20.06	20.05		
Channel				27235	27435	27635	Tune-up limit (dBm)	MPR (dB)
Frequency (MHz)				705.5	725.5	745.5		
5	QPSK	1	0	22.13	21.95	21.89	22.5	0
5	QPSK	1	12	22.04	22.02	22.14		
5	QPSK	1	24	22.02	22.05	21.92		
5	QPSK	12	0	21.19	21.11	21.15	21.5	1
5	QPSK	12	7	21.17	21.11	21.10		
5	QPSK	12	13	21.21	21.11	21.12		
5	QPSK	25	0	21.18	21.11	21.12	22.0	0.5
5	16QAM	1	0	21.25	21.21	21.03		
5	16QAM	1	12	21.25	21.49	21.46		
5	16QAM	1	24	21.15	21.41	21.42	20.5	2
5	16QAM	12	0	20.19	20.13	20.09		
5	16QAM	12	7	20.23	20.10	20.05		
5	16QAM	12	13	20.21	20.16	20.06	20.5	2
5	16QAM	25	0	20.18	20.10	20.08		



Channel				27225	27435	27645	Tune-up limit (dBm)	MPR (dB)
Frequency (MHz)				704.5	725.5	746.5		
3	QPSK	1	0	22.02	21.98	21.82	22.5	0
3	QPSK	1	8	22.12	22.02	21.93		
3	QPSK	1	14	21.90	21.89	21.92		
3	QPSK	8	0	21.18	21.12	21.05	21.5	1
3	QPSK	8	4	21.22	21.14	20.99		
3	QPSK	8	7	21.19	21.09	21.06		
3	QPSK	15	0	21.22	21.18	21.12		
3	16QAM	1	0	21.20	21.07	20.99	22.0	0.5
3	16QAM	1	8	21.58	21.47	21.07		
3	16QAM	1	14	21.33	21.02	21.37		
3	16QAM	8	0	20.21	20.22	20.03	20.5	2
3	16QAM	8	4	20.15	20.16	19.97		
3	16QAM	8	7	20.09	20.08	20.09		
3	16QAM	15	0	20.22	20.14	20.10		

**<WLAN Conducted Power>**

**General Note:**

1. Per KDB 248227 D01v02r02, SAR test reduction is determined according to 802.11 transmission mode configurations and certain exposure conditions with multiple test positions. In the 2.4 GHz band, separate SAR procedures are applied to DSSS and OFDM configurations to simplify DSSS test requirements. For OFDM, in both 2.4 and 5 GHz bands, an initial test configuration must be determined for each standalone and aggregated frequency band, according to the transmission mode configuration with the highest maximum output power specified for production units to perform SAR measurements. If the same highest maximum output power applies to different combinations of channel bandwidths, modulations and data rates, additional procedures are applied to determine which test configurations require SAR measurement. When applicable, an initial test position may be applied to reduce the number of SAR measurements required for next to the ear, UMPC mini-tablet or hotspot mode configurations with multiple test positions.
2. For 2.4 GHz 802.11b DSSS, either the initial test position procedure for multiple exposure test positions or the DSSS procedure for fixed exposure position is applied; these are mutually exclusive. For 2.4 GHz and 5 GHz OFDM configurations, the initial test configuration is applied to measure SAR using either the initial test position procedure for multiple exposure test position configurations or the initial test configuration procedures for fixed exposure test conditions. Based on the reported SAR of the measured configurations and maximum output power of the transmission mode configurations that are not included in the initial test configuration, the subsequent test configuration and initial test position procedures are applied to determine if SAR measurements are required for the remaining OFDM transmission configurations. In general, the number of test channels that require SAR measurement is minimized based on maximum output power measured for the test sample(s).
3. For OFDM transmission configurations in the 2.4 GHz and 5 GHz bands, When the same maximum power is specified for multiple transmission modes in a frequency band, the largest channel bandwidth, lowest order modulation, lowest data rate and lowest order 802.11a/g/n/ac mode is used for SAR measurement, on the highest measured output power channel for each frequency band.
4. DSSS and OFDM configurations are considered separately according to the required SAR procedures. SAR is measured in the initial test position using the 802.11 transmission mode configuration required by the DSSS procedure or initial test configuration and subsequent test configuration(s) according to the OFDM procedures.18 The initial test position procedure is described in the following:
  - a. When the reported SAR of the initial test position is  $\leq 0.4$  W/kg, further SAR measurement is not required for the other test positions in that exposure configuration and 802.11 transmission mode combinations within the frequency band or aggregated band.
  - b. When the reported SAR of the test position is  $> 0.4$  W/kg, SAR is repeated for the 802.11 transmission mode configuration tested in the initial test position to measure the subsequent next closet/smallest test separation distance and maximum coupling test position on the highest maximum output power channel, until the report SAR is  $\leq 0.8$  W/kg or all required test position are tested.
  - c. For all positions/configurations, when the reported SAR is  $> 0.8$  W/kg, SAR is measured for these test positions/configurations on the subsequent next highest measured output power channel(s) until the reported SAR is  $\leq 1.2$  W/kg or all required channels are tested.

	Mode	Channel	Frequency (MHz)	Data Rate	Average power (dBm)	Tune-Up Limit	Duty Cycle %
2.4GHz WLAN	802.11b	CH 1	2412	1Mbps	<b>16.51</b>	17.00	99.66
		CH 6	2437		16.08	16.50	
		CH 11	2462		16.32	16.50	
	802.11g	CH 1	2412	6Mbps	12.42	13.00	97.56
		CH 6	2437		13.53	14.00	
		CH 11	2462		14.08	14.50	
	802.11n-HT20	CH 1	2412	MCS0	12.47	13.00	97.39
		CH 6	2437		13.52	14.00	
		CH 11	2462		14.21	14.50	
	802.11n-HT40	CH 3	2422	MCS0	13.30	13.50	94.92
		CH 6	2437		13.51	14.00	
		CH 9	2452		13.47	14.00	

### 13. Bluetooth Exclusions Applied

Mode Band	Average power(dBm)	
	Bluetooth-BR/EDR	Bluetooth-LE
2.4GHz Bluetooth	7.0	0

**Note:**

Per KDB 447498 D01v06, the 1-g and 10-g SAR test exclusion thresholds for 100 MHz to 6 GHz at *test separation distances* ≤ 50 mm are determined by:

$$[(\text{max. power of channel, including tune-up tolerance, mW}) / (\text{min. test separation distance, mm})] \cdot [\sqrt{f(\text{GHz})}] \leq 3.0 \text{ for 1-g SAR and } \leq 7.5 \text{ for 10-g extremity SAR}$$

- f(GHz) is the RF channel transmit frequency in GHz
- Power and distance are rounded to the nearest mW and mm before calculation
- The result is rounded to one decimal place for comparison

Bluetooth Max Power (dBm)	Separation Distance (mm)	Frequency (GHz)	exclusion thresholds
7.0	10	2.48	0.8

**Note:**

Per KDB 447498 D01v06, a distance of 10 mm is applied to determine SAR test exclusion. The test exclusion threshold is 0.8 which is ≤ 3, SAR testing is not required.



### 14. Antenna Location

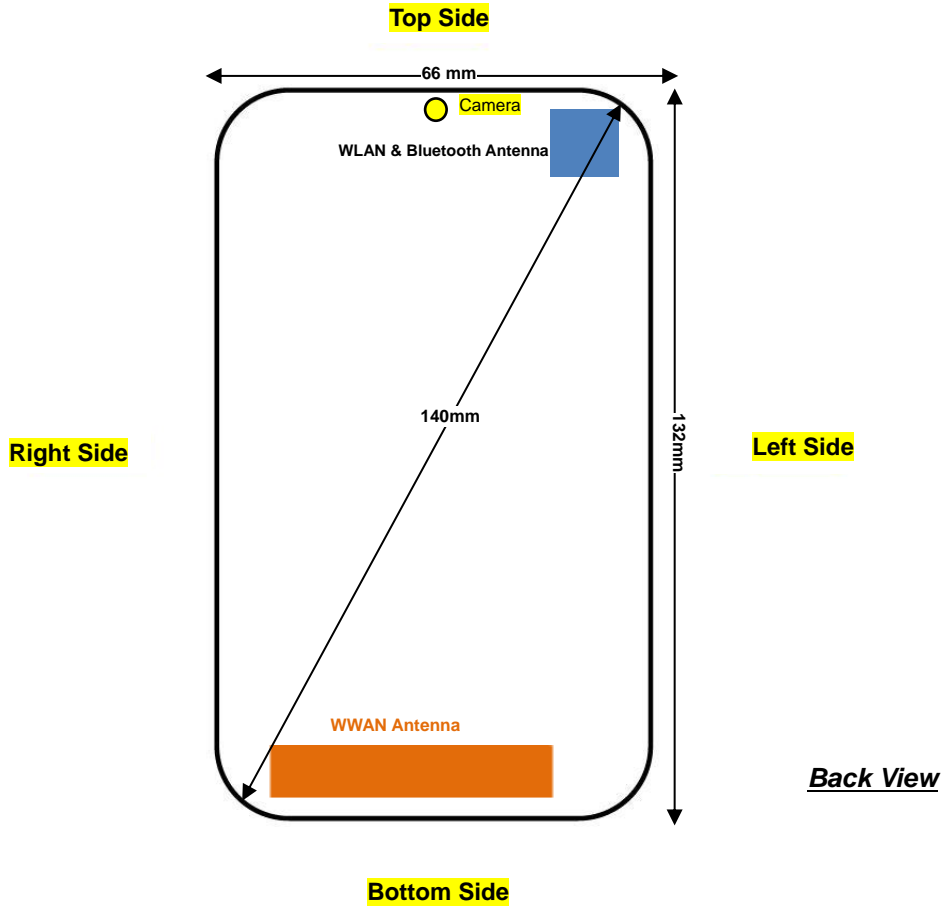

Distance of the Antenna to the EUT surface/edge						
Antennas	Back	Front	Top Side	Bottom Side	Right Side	Left Side
WWAN Main	≤ 25mm	≤ 25mm	>25mm	≤ 25mm	≤ 25mm	≤ 25mm
BT&2.4GWLAN	≤ 25mm	≤ 25mm	≤ 25mm	>25mm	>25mm	≤ 25mm

Positions for SAR tests; Hotspot mode						
Antennas	Back	Front	Top Side	Bottom Side	Right Side	Left Side
WWAN Main	Yes	Yes	No	Yes	Yes	Yes
BT&2.4GWLAN	Yes	Yes	Yes	No	No	Yes

**General Note:**

Referring to KDB 941225 D06 v02r01, when the overall device length and width are ≥ 9cm\*5cm, the test distance is 10 mm. SAR must be measured for all sides and surfaces with a transmitting antenna located within 25mm from that surface or edge.



## **15. SAR Test Results**

### **General Note:**

1. Per KDB 447498 D01v06, the reported SAR is the measured SAR value adjusted for maximum tune-up tolerance.
  - a. Tune-up scaling Factor = tune-up limit power (mW) / EUT RF power (mW), where tune-up limit is the maximum rated power among all production units.
  - b. For SAR testing of WLAN signal with non-100% duty cycle, the measured SAR is scaled-up by the duty cycle scaling factor which is equal to "1/(duty cycle)"
  - c. For WWAN: Reported SAR(W/kg)= Measured SAR(W/kg)\*Tune-up Scaling Factor
  - d. For WLAN: Reported SAR(W/kg)= Measured SAR(W/kg)\* Duty Cycle scaling factor \* Tune-up scaling factor
2. Per KDB 447498 D01v06, for each exposure position, testing of other required channels within the operating mode of a frequency band is not required when the *reported* 1-g or 10-g SAR for the mid-band or highest output power channel is:
  - $\leq 0.8$  W/kg or 2.0 W/kg, for 1-g or 10-g respectively, when the transmission band is  $\leq 100$  MHz
  - $\leq 0.6$  W/kg or 1.5 W/kg, for 1-g or 10-g respectively, when the transmission band is between 100 MHz and 200 MHz
  - $\leq 0.4$  W/kg or 1.0 W/kg, for 1-g or 10-g respectively, when the transmission band is  $\geq 200$  MHz
3. Per KDB 865664 D01v01r04, for each frequency band, repeated SAR measurement is required only when the measured SAR is  $\geq 0.8$ W/kg.
4. Per KDB 648474 D04v01r03, when the reported SAR for a body-worn accessory measured without a headset connected to the handset is  $\leq 1.2$  W/kg, SAR testing with a headset connected to the handset is not required.

### **GSM Note:**

1. Per KDB 941225 D01v03r01, for SAR test reduction for GSM / GPRS / EDGE modes is determined by the source-based time-averaged output power including tune-up tolerance. The mode with highest specified time-averaged output power should be tested for SAR compliance in the applicable exposure conditions. For modes with the same specified maximum output power and tolerance, the higher number time-slot configuration should be tested. Therefore, the GPRS (4Tx slots) for GSM850/GSM1900 is considered as the primary mode.
2. Other configurations of GSM / GPRS / EDGE are considered as secondary modes. The 3G SAR test reduction procedure is applied, when the maximum output power and tune-up tolerance specified for production units in a secondary mode is  $\leq \frac{1}{4}$  dB higher than the primary mode, SAR measurement is not required for the secondary mode.

### **UMTS Note:**

1. Per KDB 941225 D01v03r01, for SAR testing is measured using a 12.2 kbps RMC with TPC bits configured to all "1's".
2. Per KDB 941225 D01v03r01, RMC 12.2kbps setting is used to evaluate SAR. If the maximum output power and tune-up tolerance specified for production units in HSDPA / HSUPA is  $\leq \frac{1}{4}$  dB higher than RMC 12.2Kbps or when the highest reported SAR of the RMC12.2Kbps is scaled by the ratio of specified maximum output power and tune-up tolerance of HSDPA / HSUPA to RMC12.2Kbps and the adjusted SAR is  $\leq 1.2$  W/kg, SAR measurement is not required for HSDPA / HSUPA.

**LTE Note:**

1. Per KDB 941225 D05v02r05, start with the largest channel bandwidth and measure SAR for QPSK with 1 RB allocation, using the RB offset and required test channel combination with the highest maximum output power for RB offsets at the upper edge, middle and lower edge of each required test channel.
2. Per KDB 941225 D05v02r05, 50% RB allocation for QPSK SAR testing follows 1RB QPSK allocation procedure.
3. Per KDB 941225 D05v02r05, For QPSK with 100% RB allocation, SAR is not required when the highest maximum output power for 100 % RB allocation is less than the highest maximum output power in 50% and 1 RB allocations and the highest reported SAR for 1 RB and 50% RB allocation are  $\leq 0.8$  W/kg. Otherwise, SAR is measured for the highest output power channel; and if the reported SAR is  $> 1.45$  W/kg, the remaining required test channels must also be tested.
4. Per KDB 941225 D05v02r05, 16QAM output power for each RB allocation configuration is  $>$  not  $\frac{1}{2}$  dB higher than the same configuration in QPSK and the reported SAR for the QPSK configuration is  $\leq 1.45$  W/kg; Per KDB 941225 D05v02r05, 16QAM SAR testing is not required.
5. Per KDB 941225 D05v02r05, Smaller bandwidth output power for each RB allocation configuration is  $>$  not  $\frac{1}{2}$  dB higher than the same configuration in the largest supported bandwidth, and the reported SAR for the largest supported bandwidth is  $\leq 1.45$  W/kg; Per KDB 941225 D05v02r05, smaller bandwidth SAR testing is not required.
6. For LTE B4/B28 the maximum bandwidth does not support three non-overlapping channels, per KDB 941225 D05v02r05, when a device supports overlapping channel assignment in a channel bandwidth configuration, the middle channel of the group of overlapping channels should be selected for testing.

**WLAN Note:**

1. Per KDB 248227 D01v02r02, for 2.4GHz 802.11g/n SAR testing is not required when the highest reported SAR for DSSS is adjusted by the ratio of OFDM to DSSS specified maximum output power and the adjusted SAR is  $\leq 1.2$  W/kg.
2. When the reported SAR of the test position is  $> 0.4$  W/kg, SAR is repeated for the 802.11 transmission mode configuration tested in the initial test position to measure the subsequent next closet/smallest test separation distance and maximum coupling test position on the highest maximum output power channel, until the report SAR is  $\leq 0.8$  W/kg or all required test position are tested.
3. For all positions / configurations, when the reported SAR is  $> 0.8$  W/kg, SAR is measured for these test positions / configurations on the subsequent next highest measured output power channel(s) until the reported SAR is  $\leq 1.2$  W/kg or all required channels are tested.
4. During SAR testing the WLAN transmission was verified using a spectrum analyzer.



**15.1 Head SAR**

**<GSM SAR>**

Plot No.	Band	Mode	Test Position	Ch.	Freq. (MHz)	Average Power (dBm)	Tune-Up Limit (dBm)	Tune-up Scaling Factor	Power Drift (dB)	Measured 1g SAR (W/kg)	Reported 1g SAR (W/kg)
01	GSM850	GPRS(4 Tx slots)	Right Cheek	251	848.8	28.73	29	1.064	0.13	0.509	<b>0.542</b>
	GSM850	GPRS(4 Tx slots)	Right Tilted	251	848.8	28.73	29	1.064	0.07	0.352	0.375
	GSM850	GPRS(4 Tx slots)	Left Cheek	251	848.8	28.73	29	1.064	0.06	0.505	0.537
	GSM850	GPRS(4 Tx slots)	Left Tilted	251	848.8	28.73	29	1.064	0.06	0.377	0.401
	GSM1900	GPRS(4 Tx slots)	Right Cheek	512	1850.2	26.23	26.5	1.064	0.09	0.150	0.160
	GSM1900	GPRS(4 Tx slots)	Right Tilted	512	1850.2	26.23	26.5	1.064	0.09	0.066	0.070
02	GSM1900	GPRS(4 Tx slots)	Left Cheek	512	1850.2	26.23	26.5	1.064	-0.07	0.197	<b>0.210</b>
	GSM1900	GPRS(4 Tx slots)	Left Tilted	512	1850.2	26.23	26.5	1.064	0.04	0.049	0.052

**<WCDMA SAR>**

Plot No.	Band	Mode	Test Position	Ch.	Freq. (MHz)	Average Power (dBm)	Tune-Up Limit (dBm)	Tune-up Scaling Factor	Power Drift (dB)	Measured 1g SAR (W/kg)	Reported 1g SAR (W/kg)
03	WCDMA Band V	RMC 12.2Kbps	Right Cheek	4182	836.4	21.75	22	1.059	0.04	0.273	<b>0.289</b>
	WCDMA Band V	RMC 12.2Kbps	Right Tilted	4182	836.4	21.75	22	1.059	0.12	0.160	0.169
	WCDMA Band V	RMC 12.2Kbps	Left Cheek	4182	836.4	21.75	22	1.059	0.08	0.246	0.261
	WCDMA Band V	RMC 12.2Kbps	Left Tilted	4182	836.4	21.75	22	1.059	-0.02	0.166	0.176
	WCDMA Band II	RMC 12.2Kbps	Right Cheek	9538	1907.6	22.01	22.5	1.119	0.03	0.153	0.171
	WCDMA Band II	RMC 12.2Kbps	Right Tilted	9538	1907.6	22.01	22.5	1.119	0.01	0.068	0.076
04	WCDMA Band II	RMC 12.2Kbps	Left Cheek	9538	1907.6	22.01	22.5	1.119	-0.06	0.183	<b>0.205</b>
	WCDMA Band II	RMC 12.2Kbps	Left Tilted	9538	1907.6	22.01	22.5	1.119	-0.03	0.042	0.047



<LTE SAR>

Plot No.	Band	BW (MHz)	Modulation	RB Size	RB offset	Test Position	Ch.	Freq. (MHz)	Average Power (dBm)	Tune-Up Limit (dBm)	Tune-up Scaling Factor	Power Drift (dB)	Measured 1g SAR (W/kg)	Reported 1g SAR (W/kg)
	LTE Band 28	20M	QPSK	1RB	99Offset	Right Cheek	27435	725.5	22.22	22.5	1.067	0.06	0.059	0.063
	LTE Band 28	20M	QPSK	1RB	99Offset	Right Tilted	27435	725.5	22.22	22.5	1.067	0.04	0.035	0.037
	LTE Band 28	20M	QPSK	1RB	99Offset	Left Cheek	27435	725.5	22.22	22.5	1.067	0.09	0.051	0.054
	LTE Band 28	20M	QPSK	1RB	99Offset	Left Tilted	27435	725.5	22.22	22.5	1.067	-0.11	0.031	0.033
05	LTE Band 28	20M	QPSK	50RB	50Offset	Right Cheek	27435	725.5	21.18	21.5	1.076	0.04	0.059	0.064
	LTE Band 28	20M	QPSK	50RB	50Offset	Right Tilted	27435	725.5	21.18	21.5	1.076	-0.02	0.036	0.039
	LTE Band 28	20M	QPSK	50RB	50Offset	Left Cheek	27435	725.5	21.18	21.5	1.076	0.03	0.054	0.058
	LTE Band 28	20M	QPSK	50RB	50Offset	Left Tilted	27435	725.5	21.18	21.5	1.076	0.09	0.032	0.034
	LTE Band 4	20M	QPSK	1RB	0Offset	Right Cheek	20175	1732.5	21.72	22	1.067	0.04	0.367	0.391
	LTE Band 4	20M	QPSK	1RB	0Offset	Right Tilted	20175	1732.5	21.72	22	1.067	-0.12	0.102	0.109
06	LTE Band 4	20M	QPSK	1RB	0Offset	Left Cheek	20175	1732.5	21.72	22	1.067	-0.03	0.390	0.416
	LTE Band 4	20M	QPSK	1RB	0Offset	Left Tilted	20175	1732.5	21.72	22	1.067	0.08	0.110	0.117
	LTE Band 4	20M	QPSK	50RB	0Offset	Right Cheek	20175	1732.5	20.61	21	1.094	0.04	0.290	0.317
	LTE Band 4	20M	QPSK	50RB	0Offset	Right Tilted	20175	1732.5	20.61	21	1.094	0.07	0.079	0.087
	LTE Band 4	20M	QPSK	50RB	0Offset	Left Cheek	20175	1732.5	20.61	21	1.094	-0.09	0.302	0.330
	LTE Band 4	20M	QPSK	50RB	0Offset	Left Tilted	20175	1732.5	20.61	21	1.094	-0.15	0.084	0.092
07	LTE Band 7	20M	QPSK	1RB	0Offset	Right Cheek	21350	2560	22.18	22.5	1.076	0.03	0.00715	0.008
	LTE Band 7	20M	QPSK	1RB	0Offset	Right Tilted	21350	2560	22.18	22.5	1.076	0.06	0.003	0.003
	LTE Band 7	20M	QPSK	1RB	0Offset	Left Cheek	21350	2560	22.18	22.5	1.076	0.01	0.004	0.005
	LTE Band 7	20M	QPSK	1RB	0Offset	Left Tilted	21350	2560	22.18	22.5	1.076	-0.08	0.004	0.004
	LTE Band 7	20M	QPSK	50RB	0Offset	Right Cheek	21350	2560	21.26	21.5	1.057	0.13	0.001	0.001
	LTE Band 7	20M	QPSK	50RB	0Offset	Right Tilted	21350	2560	21.26	21.5	1.057	0.07	0.002	0.002
	LTE Band 7	20M	QPSK	50RB	0Offset	Left Cheek	21350	2560	21.26	21.5	1.057	0.01	<0.001	<0.001
	LTE Band 7	20M	QPSK	50RB	0Offset	Left Tilted	21350	2560	21.26	21.5	1.057	-0.11	<0.001	<0.001

<WLAN SAR>

Plot No.	Band	Mode	Test Position	Ch.	Freq. (MHz)	Average Power (dBm)	Tune-Up Limit (dBm)	Tune-up Scaling Factor	Duty Cycle %	Duty Factor	Power Drift (dB)	Measured 1g SAR (W/kg)	Reported 1g SAR (W/kg)
08	WLAN2.4GHz	802.11b 1Mbps	Right Cheek	1	2412	16.51	17	1.119	99.66	1.003	0.18	0.617	0.693
	WLAN2.4GHz	802.11b 1Mbps	Right Tilted	1	2412	16.51	17	1.119	99.66	1.003	0.05	0.482	0.541
	WLAN2.4GHz	802.11b 1Mbps	Left Cheek	1	2412	16.51	17	1.119	99.66	1.003	-0.13	0.354	0.397
	WLAN2.4GHz	802.11b 1Mbps	Left Tilted	1	2412	16.51	17	1.119	99.66	1.003	0.08	0.196	0.220



**15.2 Hotspot SAR**

**<GSM SAR>**

Plot No.	Band	Mode	Test Position	Gap (mm)	Ch.	Freq. (MHz)	Average Power (dBm)	Tune-Up Limit (dBm)	Tune-up Scaling Factor	Power Drift (dB)	Measured 1g SAR (W/kg)	Reported 1g SAR (W/kg)
09	GSM850	GPRS(4 Tx slots)	Front	10	251	848.8	28.73	29	1.064	0.06	0.628	0.668
	GSM850	GPRS(4 Tx slots)	Back	10	251	848.8	28.73	29	1.064	0.05	0.892	<b>0.949</b>
	GSM850	GPRS(4 Tx slots)	Left Side	10	251	848.8	28.73	29	1.064	0.01	0.620	0.660
	GSM850	GPRS(4 Tx slots)	Right Side	10	251	848.8	28.73	29	1.064	-0.12	0.727	0.774
	GSM850	GPRS(4 Tx slots)	Bottom Side	10	251	848.8	28.73	29	1.064	0.03	0.255	0.271
10	GSM850	GPRS(4 Tx slots)	Back	10	128	824.2	28.60	29	1.096	0.07	0.852	0.934
	GSM850	GPRS(4 Tx slots)	Back	10	189	836.4	28.70	29	1.072	0.08	0.828	0.887
	GSM1900	GPRS(4 Tx slots)	Front	10	512	1850.2	26.23	26.5	1.064	0.11	0.597	<b>0.635</b>
	GSM1900	GPRS(4 Tx slots)	Back	10	512	1850.2	26.23	26.5	1.064	0.02	0.504	0.536
	GSM1900	GPRS(4 Tx slots)	Left Side	10	512	1850.2	26.23	26.5	1.064	0.04	0.069	0.073
	GSM1900	GPRS(4 Tx slots)	Right Side	10	512	1850.2	26.23	26.5	1.064	-0.11	0.087	0.092
	GSM1900	GPRS(4 Tx slots)	Bottom Side	10	512	1850.2	26.23	26.5	1.064	0.06	0.466	0.496

**<WCDMA SAR>**

Plot No.	Band	Mode	Test Position	Gap (mm)	Ch.	Freq. (MHz)	Average Power (dBm)	Tune-Up Limit (dBm)	Tune-up Scaling Factor	Power Drift (dB)	Measured 1g SAR (W/kg)	Reported 1g SAR (W/kg)
11	WCDMA Band V	RMC 12.2Kbps	Front	10	4182	836.4	21.75	22	1.059	0.02	0.343	0.363
	WCDMA Band V	RMC 12.2Kbps	Back	10	4182	836.4	21.75	22	1.059	0.14	0.502	<b>0.532</b>
	WCDMA Band V	RMC 12.2Kbps	Left Side	10	4182	836.4	21.75	22	1.059	0.09	0.273	0.289
	WCDMA Band V	RMC 12.2Kbps	Right Side	10	4182	836.4	21.75	22	1.059	0.06	0.342	0.362
	WCDMA Band V	RMC 12.2Kbps	Bottom Side	10	4182	836.4	21.75	22	1.059	-0.06	0.112	0.119
12	WCDMA Band II	RMC 12.2Kbps	Front	10	9538	1907.6	22.01	22.5	1.119	0.08	0.500	0.560
	WCDMA Band II	RMC 12.2Kbps	Back	10	9538	1907.6	22.01	22.5	1.119	0.01	0.647	<b>0.724</b>
	WCDMA Band II	RMC 12.2Kbps	Left Side	10	9538	1907.6	22.01	22.5	1.119	-0.05	0.068	0.077
	WCDMA Band II	RMC 12.2Kbps	Right Side	10	9538	1907.6	22.01	22.5	1.119	-0.04	0.085	0.095
	WCDMA Band II	RMC 12.2Kbps	Bottom Side	10	9538	1907.6	22.01	22.5	1.119	0.03	0.545	0.610



<LTE SAR>

Plot No.	Band	BW (MHz)	Modulation	RB Size	RB offset	Test Position	Gap (mm)	Ch.	Freq. (MHz)	Average Power (dBm)	Tune-Up Limit (dBm)	Tune-up Scaling Factor	Power Drift (dB)	Measured 1g SAR (W/kg)	Reported 1g SAR (W/kg)
13	LTE Band 28	20M	QPSK	1RB	99Offset	Front	10	27435	725.5	22.22	22.5	1.067	0.04	0.085	0.091
	LTE Band 28	20M	QPSK	1RB	99Offset	Back	10	27435	725.5	22.22	22.5	1.067	0.05	0.129	0.138
	LTE Band 28	20M	QPSK	1RB	99Offset	Left Side	10	27435	725.5	22.22	22.5	1.067	0.01	0.051	0.055
	LTE Band 28	20M	QPSK	1RB	99Offset	Right Side	10	27435	725.5	22.22	22.5	1.067	-0.02	0.078	0.083
	LTE Band 28	20M	QPSK	1RB	99Offset	Bottom Side	10	27435	725.5	22.22	22.5	1.067	-0.06	0.026	0.028
	LTE Band 28	20M	QPSK	50RB	50Offset	Front	10	27435	725.5	21.18	21.5	1.076	-0.11	0.082	0.089
	LTE Band 28	20M	QPSK	50RB	50Offset	Back	10	27435	725.5	21.18	21.5	1.076	0.05	0.118	0.127
	LTE Band 28	20M	QPSK	50RB	50Offset	Left Side	10	27435	725.5	21.18	21.5	1.076	0.13	0.049	0.053
	LTE Band 28	20M	QPSK	50RB	50Offset	Right Side	10	27435	725.5	21.18	21.5	1.076	0.15	0.076	0.082
	LTE Band 28	20M	QPSK	50RB	50Offset	Bottom Side	10	27435	725.5	21.18	21.5	1.076	0.1	0.027	0.029
14	LTE Band 4	20M	QPSK	1RB	0Offset	Front	10	20175	1732.5	21.72	22	1.067	0.01	0.776	0.828
	LTE Band 4	20M	QPSK	1RB	0Offset	Back	10	20175	1732.5	21.72	22	1.067	0.03	0.825	0.880
	LTE Band 4	20M	QPSK	1RB	0Offset	Left Side	10	20175	1732.5	21.72	22	1.067	0.08	0.119	0.127
	LTE Band 4	20M	QPSK	1RB	0Offset	Right Side	10	20175	1732.5	21.72	22	1.067	0.07	0.186	0.198
	LTE Band 4	20M	QPSK	1RB	0Offset	Bottom Side	10	20175	1732.5	21.72	22	1.067	0.11	0.666	0.710
	LTE Band 4	20M	QPSK	50RB	0Offset	Front	10	20175	1732.5	20.61	21	1.094	0.14	0.617	0.675
	LTE Band 4	20M	QPSK	50RB	0Offset	Back	10	20175	1732.5	20.61	21	1.094	0.06	0.658	0.720
	LTE Band 4	20M	QPSK	50RB	0Offset	Left Side	10	20175	1732.5	20.61	21	1.094	0.01	0.092	0.101
	LTE Band 4	20M	QPSK	50RB	0Offset	Right Side	10	20175	1732.5	20.61	21	1.094	-0.01	0.148	0.162
	LTE Band 4	20M	QPSK	50RB	0Offset	Bottom Side	10	20175	1732.5	20.61	21	1.094	0.01	0.480	0.525
15	LTE Band 4	20M	QPSK	100RB	0Offset	Front	10	20175	1732.5	20.55	21	1.109	0.11	0.548	0.608
	LTE Band 4	20M	QPSK	100RB	0Offset	Back	10	20175	1732.5	20.55	21	1.109	0.02	0.657	0.729
	LTE Band 7	20M	QPSK	1RB	0Offset	Front	10	21350	2560	22.18	22.5	1.076	-0.13	0.080	0.086
	LTE Band 7	20M	QPSK	1RB	0Offset	Back	10	21350	2560	22.18	22.5	1.076	0.05	0.156	0.168
	LTE Band 7	20M	QPSK	1RB	0Offset	Left Side	10	21350	2560	22.18	22.5	1.076	0.07	<0.001	<0.001
	LTE Band 7	20M	QPSK	1RB	0Offset	Right Side	10	21350	2560	22.18	22.5	1.076	0.12	0.014	0.015
	LTE Band 7	20M	QPSK	1RB	0Offset	Bottom Side	10	21350	2560	22.18	22.5	1.076	-0.02	0.094	0.101
	LTE Band 7	20M	QPSK	50RB	0Offset	Front	10	21350	2560	21.26	21.5	1.057	0.15	0.058	0.062
	LTE Band 7	20M	QPSK	50RB	0Offset	Back	10	21350	2560	21.26	21.5	1.057	0.07	0.104	0.110
	LTE Band 7	20M	QPSK	50RB	0Offset	Left Side	10	21350	2560	21.26	21.5	1.057	-0.05	<0.001	<0.001
LTE Band 7	20M	QPSK	50RB	0Offset	Right Side	10	21350	2560	21.26	21.5	1.057	-0.12	0.013	0.014	
LTE Band 7	20M	QPSK	50RB	0Offset	Bottom Side	10	21350	2560	21.26	21.5	1.057	0.06	0.074	0.078	

<WLAN SAR>

Plot No.	Band	Mode	Test Position	Gap (mm)	Ch.	Freq. (MHz)	Average Power (dBm)	Tune-Up Limit (dBm)	Tune-up Scaling Factor	Duty Cycle %	Duty Factor	Power Drift (dB)	Measured 1g SAR (W/kg)	Reported 1g SAR (W/kg)
16	WLAN2.4GHz	802.11b 1Mbps	Front	10	1	2412	16.51	17	1.119	99.66	1.003	0.05	0.137	0.154
	WLAN2.4GHz	802.11b 1Mbps	Back	10	1	2412	16.51	17	1.119	99.66	1.003	0.16	0.154	0.173
	WLAN2.4GHz	802.11b 1Mbps	Left Side	10	1	2412	16.51	17	1.119	99.66	1.003	0.11	0.129	0.145
	WLAN2.4GHz	802.11b 1Mbps	Top Side	10	1	2412	16.51	17	1.119	99.66	1.003	0.09	0.087	0.098





**15.3 Body Worn Accessory SAR**

**<GSM SAR>**

Plot No.	Band	Mode	Test Position	Gap (mm)	Ch.	Freq. (MHz)	Average Power (dBm)	Tune-Up Limit (dBm)	Tune-up Scaling Factor	Power Drift (dB)	Measured 1g SAR (W/kg)	Reported 1g SAR (W/kg)
	GSM850	GPRS(4 Tx slots)	Front	10	251	848.8	28.73	29	1.064	0.06	0.628	0.668
17	GSM850	GPRS(4 Tx slots)	Back	10	251	848.8	28.73	29	1.064	0.05	0.892	<b>0.949</b>
	GSM850	GPRS(4 Tx slots)	Back	10	128	824.2	28.60	29	1.096	0.07	0.852	0.934
	GSM850	GPRS(4 Tx slots)	Back	10	189	836.4	28.70	29	1.072	0.08	0.828	0.887
18	GSM1900	GPRS(4 Tx slots)	Front	10	512	1850.2	26.23	26.5	1.064	0.11	0.597	<b>0.635</b>
	GSM1900	GPRS(4 Tx slots)	Back	10	512	1850.2	26.23	26.5	1.064	0.02	0.504	0.536

**<WCDMA SAR>**

Plot No.	Band	Mode	Test Position	Gap (mm)	Ch.	Freq. (MHz)	Average Power (dBm)	Tune-Up Limit (dBm)	Tune-up Scaling Factor	Power Drift (dB)	Measured 1g SAR (W/kg)	Reported 1g SAR (W/kg)
	WCDMA Band V	RMC 12.2Kbps	Front	10	4182	836.4	21.75	22	1.059	0.02	0.343	0.363
19	WCDMA Band V	RMC 12.2Kbps	Back	10	4182	836.4	21.75	22	1.059	0.14	0.502	<b>0.532</b>
	WCDMA Band II	RMC 12.2Kbps	Front	10	9538	1907.6	22.01	22.5	1.119	0.08	0.500	0.560
20	WCDMA Band II	RMC 12.2Kbps	Back	10	9538	1907.6	22.01	22.5	1.119	0.01	0.647	<b>0.724</b>

**<LTE SAR>**

Plot No.	Band	BW (MHz)	Modulation	RB Size	RB offset	Test Position	Gap (mm)	Ch.	Freq. (MHz)	Average Power (dBm)	Tune-Up Limit (dBm)	Tune-up Scaling Factor	Power Drift (dB)	Measured 1g SAR (W/kg)	Reported 1g SAR (W/kg)
	LTE Band 28	20M	QPSK	1RB	99Offset	Front	10	27435	725.5	22.22	22.5	1.067	0.04	0.085	0.091
21	LTE Band 28	20M	QPSK	1RB	99Offset	Back	10	27435	725.5	22.22	22.5	1.067	0.05	0.129	<b>0.138</b>
	LTE Band 28	20M	QPSK	50RB	50Offset	Front	10	27435	725.5	21.18	21.5	1.076	-0.11	0.082	0.089
	LTE Band 28	20M	QPSK	50RB	50Offset	Back	10	27435	725.5	21.18	21.5	1.076	0.05	0.118	0.127
	LTE Band 4	20M	QPSK	1RB	0Offset	Front	10	20175	1732.5	21.72	22	1.067	0.01	0.776	0.828
22	LTE Band 4	20M	QPSK	1RB	0Offset	Back	10	20175	1732.5	21.72	22	1.067	0.03	0.825	<b>0.880</b>
	LTE Band 4	20M	QPSK	50RB	0Offset	Front	10	20175	1732.5	20.61	21	1.094	0.14	0.617	0.675
	LTE Band 4	20M	QPSK	50RB	0Offset	Back	10	20175	1732.5	20.61	21	1.094	0.06	0.658	0.720
	LTE Band 4	20M	QPSK	100RB	0Offset	Front	10	20175	1732.5	20.55	21	1.109	0.11	0.548	0.608
	LTE Band 4	20M	QPSK	100RB	0Offset	Back	10	20175	1732.5	20.55	21	1.109	0.02	0.657	0.729
	LTE Band 7	20M	QPSK	1RB	0Offset	Front	10	21350	2560	22.18	22.5	1.076	-0.13	0.080	0.086
23	LTE Band 7	20M	QPSK	1RB	0Offset	Back	10	21350	2560	22.18	22.5	1.076	0.05	0.156	<b>0.168</b>
	LTE Band 7	20M	QPSK	50RB	0Offset	Front	10	21350	2560	21.26	21.5	1.057	0.15	0.058	0.062
	LTE Band 7	20M	QPSK	50RB	0Offset	Back	10	21350	2560	21.26	21.5	1.057	0.07	0.104	0.110

**<WLAN SAR>**

Plot No.	Band	Mode	Test Position	Gap (mm)	Ch.	Freq. (MHz)	Average Power (dBm)	Tune-Up Limit (dBm)	Tune-up Scaling Factor	Duty Cycle %	Duty Factor	Power Drift (dB)	Measured 1g SAR (W/kg)	Reported 1g SAR (W/kg)
	WLAN2.4GHz	802.11b 1Mbps	Front	10	1	2412	16.51	17	1.119	99.66	1.003	0.05	0.137	0.154
24	WLAN2.4GHz	802.11b 1Mbps	Back	10	1	2412	16.51	17	1.119	99.66	1.003	0.16	0.154	<b>0.173</b>





15.4 Repeated SAR Measurement

Plot No.	Band	BW (MHz)	Mode	RB Size	RB offset	Test Position	Gap (mm)	Ch.	Freq. (MHz)	Average Power (dBm)	Tune-Up Limit (dBm)	Tune-up Scaling Factor	Power Drift (dB)	Measured 1g SAR (W/kg)	Ratio	Reported 1g SAR (W/kg)
1st	GSM850	-	GPRS(4 Tx slots)	-	-	Back	10	251	848.8	28.73	29	1.064	0.05	0.892	1	0.949
2nd	GSM850	-	GPRS(4 Tx slots)	-	-	Back	10	251	848.8	28.73	29	1.064	0.08	0.856	1.040	0.911
1st	LTE Band 4	20M	QPSK	1RB	0Offset	Back	10	20175	1732.5	21.72	22	1.067	0.03	0.825	1	0.880
2nd	LTE Band 4	20M	QPSK	1RB	0Offset	Back	10	20175	1732.5	21.72	22	1.067	0.12	0.821	1.005	0.876

General Note:

1. Per KDB 865664 D01v01r04, for each frequency band, repeated SAR measurement is required only when the measured SAR is  $\geq 0.8W/kg$ .
2. Per KDB 865664 D01v01r04, if the ratio among the repeated measurement is  $\leq 1.2$  and the measured SAR  $< 1.45W/kg$ , only one repeated measurement is required.
3. The ratio is the difference in percentage between original and repeated *measured* SAR.
4. All measurement SAR result is scaled-up to account for tune-up tolerance and is compliant.

### 16. Simultaneous Transmission Analysis

NO.	Simultaneous Transmission Configurations	Portable Handset			Note
		Head	Body-worn	Hotspot	
1.	GSM Voice + WLAN2.4GHz	Yes	Yes		
2.	GPRS/EDGE + WLAN2.4GHz	Yes	Yes	Yes	Hotspot
3.	WCDMA + WLAN2.4GHz	Yes	Yes	Yes	Hotspot
4.	LTE + WLAN2.4GHz	Yes	Yes	Yes	Hotspot
5.	GSM Voice + Bluetooth		Yes		
6.	GPRS/EDGE + Bluetooth		Yes		WWAN VoIP
7.	WCDMA+ Bluetooth		Yes		WWAN VoIP
8.	LTE + Bluetooth		Yes		WWAN VoIP

**General Note:**

1. This device supports VoIP in GPRS, EGPRS, WCDMA and LTE (e.g. for 3rd-party VoIP).
2. This device 2.4GHz WLAN supports hotspot operation.
3. EUT will choose each GSM, WCDMA and LTE according to the network signal condition; therefore, they will not operate simultaneously at any moment.
4. WLAN and Bluetooth share the same antenna, and cannot transmit simultaneously.
5. The reported SAR summation is calculated based on the same configuration and test position.
6. Per KDB 447498 D01v06, simultaneous transmission SAR is compliant if,
  - i) Scalar SAR summation < 1.6W/kg.
  - ii)  $SPLSR = (SAR1 + SAR2)^{1.5} / (\text{min. separation distance, mm})$ , and the peak separation distance is determined from the square root of  $[(x1-x2)^2 + (y1-y2)^2 + (z1-z2)^2]$ , where (x1, y1, z1) and (x2, y2, z2) are the coordinates of the extrapolated peak SAR locations in the zoom scan.
  - iii) If  $SPLSR \leq 0.04$ , simultaneously transmission SAR measurement is not necessary.
  - iv) Simultaneously transmission SAR measurement, and the reported multi-band SAR < 1.6W/kg.
7. For simultaneous transmission analysis, Bluetooth SAR is estimated per KDB 447498 D01v06 based on the formula below.
  - i)  $(\text{max. power of channel, including tune-up tolerance, mW}) / (\text{min. test separation distance, mm}) \cdot [\sqrt{f(\text{GHz})} / x] \text{ W/kg}$  for test separation distances  $\leq 50 \text{ mm}$ ; where  $x = 7.5$  for 1-g SAR, and  $x = 18.75$  for 10-g SAR.
  - ii) When the minimum separation distance is < 5mm, the distance is used 5mm to determine SAR test exclusion.
  - iii) 0.4 W/kg for 1-g SAR and 1.0 W/kg for 10-g SAR, when the test separation distances is > 50 mm.

Bluetooth Max Power	Exposure Position	Body Worn
	Test separation	10 mm
7.0 dBm	Estimated SAR (W/kg)	0.105



**16.1 Head Exposure Conditions**

WWAN Band		Exposure Position	1	2	1+2 Summed 1g SAR (W/kg)
			WWAN	2.4GHz WLAN	
			1g SAR (W/kg)	1g SAR (W/kg)	
GSM	GSM850	Right Cheek	0.542	0.693	1.24
		Right Tilted	0.375	0.541	0.92
		Left Cheek	0.537	0.397	0.93
		Left Tilted	0.401	0.220	0.62
	GSM1900	Right Cheek	0.160	0.693	0.85
		Right Tilted	0.070	0.541	0.61
		Left Cheek	0.210	0.397	0.61
		Left Tilted	0.052	0.220	0.27
WCDMA	WCDMA II	Right Cheek	0.171	0.693	0.86
		Right Tilted	0.076	0.541	0.62
		Left Cheek	0.205	0.397	0.60
		Left Tilted	0.047	0.220	0.27
	WCDMA V	Right Cheek	0.289	0.693	0.98
		Right Tilted	0.169	0.541	0.71
		Left Cheek	0.261	0.397	0.66
		Left Tilted	0.176	0.220	0.40
LTE	LTE Band 4	Right Cheek	0.391	0.693	1.08
		Right Tilted	0.109	0.541	0.65
		Left Cheek	0.416	0.397	0.81
		Left Tilted	0.117	0.220	0.34
	LTE Band 7	Right Cheek	0.008	0.693	0.70
		Right Tilted	0.003	0.541	0.54
		Left Cheek	0.005	0.397	0.40
		Left Tilted	0.004	0.220	0.22
	LTE Band 28	Right Cheek	0.064	0.693	0.76
		Right Tilted	0.039	0.541	0.58
		Left Cheek	0.058	0.397	0.46
		Left Tilted	0.034	0.220	0.25



16.2 Hotspot Exposure Conditions

WWAN Band		Exposure Position	1	2	1+2 Summed 1g SAR (W/kg)
			WWAN	2.4GHz WLAN	
			1g SAR (W/kg)	1g SAR (W/kg)	
GSM	GSM850	Front	0.668	0.154	0.82
		Back	0.949	0.173	1.12
		Left side	0.660	0.145	0.81
		Right side	0.774		0.77
		Top side		0.098	0.10
		Bottom side	0.271		0.27
	GSM1900	Front	0.635	0.154	0.79
		Back	0.536	0.173	0.71
		Left side	0.073	0.145	0.22
		Right side	0.092		0.09
		Top side		0.098	0.10
		Bottom side	0.496		0.50
WCDMA	WCDMA II	Front	0.560	0.154	0.71
		Back	0.724	0.173	0.90
		Left side	0.077	0.145	0.22
		Right side	0.095		0.10
		Top side		0.098	0.10
		Bottom side	0.610		0.61
	WCDMA V	Front	0.363	0.154	0.52
		Back	0.532	0.173	0.71
		Left side	0.289	0.145	0.43
		Right side	0.362		0.36
		Top side		0.098	0.10
		Bottom side	0.119		0.12
LTE	LTE Band 4	Front	0.828	0.154	0.98
		Back	0.880	0.173	1.05
		Left side	0.127	0.145	0.27
		Right side	0.198		0.20
		Top side		0.098	0.10
		Bottom side	0.710		0.71
	LTE Band 7	Front	0.086	0.154	0.24
		Back	0.168	0.173	0.34
		Left side	<0.001	0.145	0.15
		Right side	0.015		0.02
		Top side		0.098	0.10
		Bottom side	0.101		0.10
	LTE Band 28	Front	0.091	0.154	0.25
		Back	0.138	0.173	0.31



		Left side	0.055	0.145	0.20
		Right side	0.083		0.08
		Top side		0.098	0.10
		Bottom side	0.029		0.03

**16.3 Body-Worn Accessory Exposure Conditions**

WWAN Band		Exposure Position	1	2	1+2 Summed 1g SAR (W/kg)
			WWAN 1g SAR (W/kg)	2.4GHz WLAN 1g SAR (W/kg)	
GSM	GSM850	Front	0.668	0.154	0.82
		Back	0.949	0.173	1.12
	GSM1900	Front	0.635	0.154	0.79
		Back	0.536	0.173	0.71
WCDMA	Band II	Front	0.560	0.154	0.71
		Back	0.724	0.173	0.90
	Band V	Front	0.363	0.154	0.52
		Back	0.532	0.173	0.71
LTE	Band 4	Front	0.828	0.154	0.98
		Back	0.880	0.173	1.05
	Band 7	Front	0.086	0.154	0.24
		Back	0.168	0.173	0.34
	Band 28	Front	0.091	0.154	0.25
		Back	0.138	0.173	0.31

WWAN Band		Exposure Position	1	2	1+2 Summed 1g SAR (W/kg)
			WWAN 1g SAR (W/kg)	Bluetooth Estimated 1g SAR (W/kg)	
GSM	GSM850	Front	0.668	0.105	0.77
		Back	0.949	0.105	1.05
	GSM1900	Front	0.635	0.105	0.74
		Back	0.536	0.105	0.64
WCDMA	Band II	Front	0.560	0.105	0.67
		Back	0.724	0.105	0.83
	Band V	Front	0.363	0.105	0.47
		Back	0.532	0.105	0.64
LTE	Band 4	Front	0.828	0.105	0.93
		Back	0.880	0.105	0.99
	Band 7	Front	0.086	0.105	0.19
		Back	0.168	0.105	0.27
	Band 28	Front	0.091	0.105	0.20
		Back	0.138	0.105	0.24

Test Engineer: Luke Lu

## 17. Uncertainty Assessment

The component of uncertainty may generally be categorized according to the methods used to evaluate them. The evaluation of uncertainty by the statistical analysis of a series of observations is termed a Type A evaluation of uncertainty. The evaluation of uncertainty by means other than the statistical analysis of a series of observation is termed a Type B evaluation of uncertainty. Each component of uncertainty, however evaluated, is represented by an estimated standard deviation, termed standard uncertainty, which is determined by the positive square root of the estimated variance.

A Type A evaluation of standard uncertainty may be based on any valid statistical method for treating data. This includes calculating the standard deviation of the mean of a series of independent observations; using the method of least squares to fit a curve to the data in order to estimate the parameter of the curve and their standard deviations; or carrying out an analysis of variance in order to identify and quantify random effects in certain kinds of measurement.

A type B evaluation of standard uncertainty is typically based on scientific judgment using all of the relevant information available. These may include previous measurement data, experience, and knowledge of the behavior and properties of relevant materials and instruments, manufacture’s specification, data provided in calibration reports and uncertainties assigned to reference data taken from handbooks. Broadly speaking, the uncertainty is either obtained from an outdoor source or obtained from an assumed distribution, such as the normal distribution, rectangular or triangular distributions indicated in table below.

Uncertainty Distributions	Normal	Rectangular	Triangular	U-Shape
Multi-plying Factor <sup>(a)</sup>	1/k <sup>(b)</sup>	1/√3	1/√6	1/√2

(a) standard uncertainty is determined as the product of the multiplying factor and the estimated range of variations in the measured quantity

(b)  $\kappa$  is the coverage factor

**Table 17.1. Standard Uncertainty for Assumed Distribution**

The combined standard uncertainty of the measurement result represents the estimated standard deviation of the result. It is obtained by combining the individual standard uncertainties of both Type A and Type B evaluation using the usual “root-sum-squares” (RSS) methods of combining standard deviations by taking the positive square root of the estimated variances.

Expanded uncertainty is a measure of uncertainty that defines an interval about the measurement result within which the measured value is confidently believed to lie. It is obtained by multiplying the combined standard uncertainty by a coverage factor. Typically, the coverage factor ranges from 2 to 3. Using a coverage factor allows the true value of a measured quantity to be specified with a defined probability within the specified uncertainty range. For purpose of this document, a coverage factor two is used, which corresponds to confidence interval of about 95 %. The DASY uncertainty Budget is shown in the following tables.

Error Description	Uncertainty Value (±%)	Probability	Divisor	(Ci) 1g	(Ci) 10g	Standard Uncertainty (1g) (±%)	Standard Uncertainty (10g) (±%)
<b>Measurement System</b>							
Probe Calibration	6.0	N	1	1	1	6.0	6.0
Axial Isotropy	4.7	R	1.732	0.7	0.7	1.9	1.9
Hemispherical Isotropy	9.6	R	1.732	0.7	0.7	3.9	3.9
Boundary Effects	1.0	R	1.732	1	1	0.6	0.6
Linearity	4.7	R	1.732	1	1	2.7	2.7
System Detection Limits	1.0	R	1.732	1	1	0.6	0.6
Modulation Response	3.2	R	1.732	1	1	1.8	1.8
Readout Electronics	0.3	N	1	1	1	0.3	0.3
Response Time	0.0	R	1.732	1	1	0.0	0.0
Integration Time	2.6	R	1.732	1	1	1.5	1.5
RF Ambient Noise	3.0	R	1.732	1	1	1.7	1.7
RF Ambient Reflections	3.0	R	1.732	1	1	1.7	1.7
Probe Positioner	0.4	R	1.732	1	1	0.2	0.2
Probe Positioning	2.9	R	1.732	1	1	1.7	1.7
Max. SAR Eval.	2.0	R	1.732	1	1	1.2	1.2
<b>Test Sample Related</b>							
Device Positioning	3.0	N	1	1	1	3.0	3.0
Device Holder	3.6	N	1	1	1	3.6	3.6
Power Drift	5.0	R	1.732	1	1	2.9	2.9
Power Scaling	0.0	R	1.732	1	1	0.0	0.0
<b>Phantom and Setup</b>							
Phantom Uncertainty	6.1	R	1.732	1	1	3.5	3.5
SAR correction	0.0	R	1.732	1	0.84	0.0	0.0
Liquid Conductivity Repeatability	0.2	N	1	0.78	0.71	0.1	0.1
Liquid Conductivity (target)	5.0	R	1.732	0.78	0.71	2.3	2.0
Liquid Conductivity (mea.)	2.5	R	1.732	0.78	0.71	1.1	1.0
Temp. unc. - Conductivity	3.4	R	1.732	0.78	0.71	1.5	1.4
Liquid Permittivity Repeatability	0.15	N	1	0.23	0.26	0.0	0.0
Liquid Permittivity (target)	5.0	R	1.732	0.23	0.26	0.7	0.8
Liquid Permittivity (mea.)	2.5	R	1.732	0.23	0.26	0.3	0.4
Temp. unc. - Permittivity	0.83	R	1.732	0.23	0.26	0.1	0.1
<b>Combined Std. Uncertainty</b>						11.4%	11.4%
<b>Coverage Factor for 95 %</b>						K=2	K=2
<b>Expanded STD Uncertainty</b>						22.9%	22.7%

**Table 17.2. Uncertainty Budget for frequency range 300 MHz to 3 GHz**



## **18. References**

- [1] FCC 47 CFR Part 2 “Frequency Allocations and Radio Treaty Matters; General Rules and Regulations”
- [2] ANSI/IEEE Std. C95.1-1992, “IEEE Standard for Safety Levels with Respect to Human Exposure to Radio Frequency Electromagnetic Fields, 3 kHz to 300 GHz”, September 1992
- [3] IEEE Std. 1528-2013, “IEEE Recommended Practice for Determining the Peak Spatial-Average Specific Absorption Rate (SAR) in the Human Head from Wireless Communications Devices: Measurement Techniques”, Sep 2013
- [4] SPEAG DASY System Handbook
- [5] FCC KDB 248227 D01 v02r02, “SAR Guidance for IEEE 802.11 (WiFi) Transmitters”, Oct 2015.
- [6] FCC KDB 447498 D01 v06, “Mobile and Portable Device RF Exposure Procedures and Equipment Authorization Policies”, Oct 2015
- [7] FCC KDB 648474 D04 v01r03, “SAR Evaluation Considerations for Wireless Handsets”, Oct 2015.
- [8] FCC KDB 941225 D01 v03r01, “3G SAR MEAUREMENT PROCEDURES”, Oct 2015
- [9] FCC KDB 941225 D05 v02r05, “SAR Evaluation Considerations for LTE Devices”, Dec 2015
- [10] FCC KDB 941225 D06 v02r01, "SAR Evaluation Procedures for Portable Devices with Wireless Router Capabilities", Oct 2015.
- [11] FCC KDB 865664 D01 v01r04, "SAR Measurement Requirements for 100 MHz to 6 GHz", Aug 2015.
- [12] FCC KDB 865664 D02 v01r02, “RF Exposure Compliance Reporting and Documentation Considerations” Oct 2015.





---

**Appendix A. Plots of System Performance Check**

The plots are shown as follows.

### System Check\_Head\_750MHz\_170413

#### DUT: D750V3\_1099

Communication System: UID 0, CW (0); Frequency: 750 MHz; Duty Cycle: 1:1  
Medium: HSL\_750\_170413 Medium parameters used:  $f = 750$  MHz;  $\sigma = 0.88$  S/m;  $\epsilon_r = 40.797$ ;  $\rho = 1000$  kg/m<sup>3</sup>  
Ambient Temperature : 23.5 °C; Liquid Temperature : 22.7 °C

#### DASY5 Configuration:

- Probe: EX3DV4 - SN3911; ConvF(10.99, 10.99, 10.99); Calibrated: 2016.09.29;
- Sensor-Surface: 2mm (Mechanical Surface Detection)
- Electronics: DAE4 Sn1338; Calibrated: 2016.11.22
- Phantom: SAM (Front) with CRP v5.0; Type: QD000P40CD; Serial: TP:1795
- Measurement SW: DASY52, Version 52.8 (8); SEMCAD X Version 14.6.10 (7331)

**Pin=250mW/Area Scan (61x61x1):** Interpolated grid: dx=15mm, dy=15mm  
Maximum value of SAR (interpolated) = 2.37 W/kg

**Pin=250mW/Zoom Scan (5x5x7)/Cube 0:** Measurement grid: dx=8mm, dy=8mm, dz=5mm  
Reference Value = 53.28 V/m; Power Drift = -0.08 dB  
Peak SAR (extrapolated) = 2.74 W/kg  
**SAR(1 g) = 1.93 W/kg; SAR(10 g) = 1.32 W/kg**  
Maximum value of SAR (measured) = 2.38 W/kg

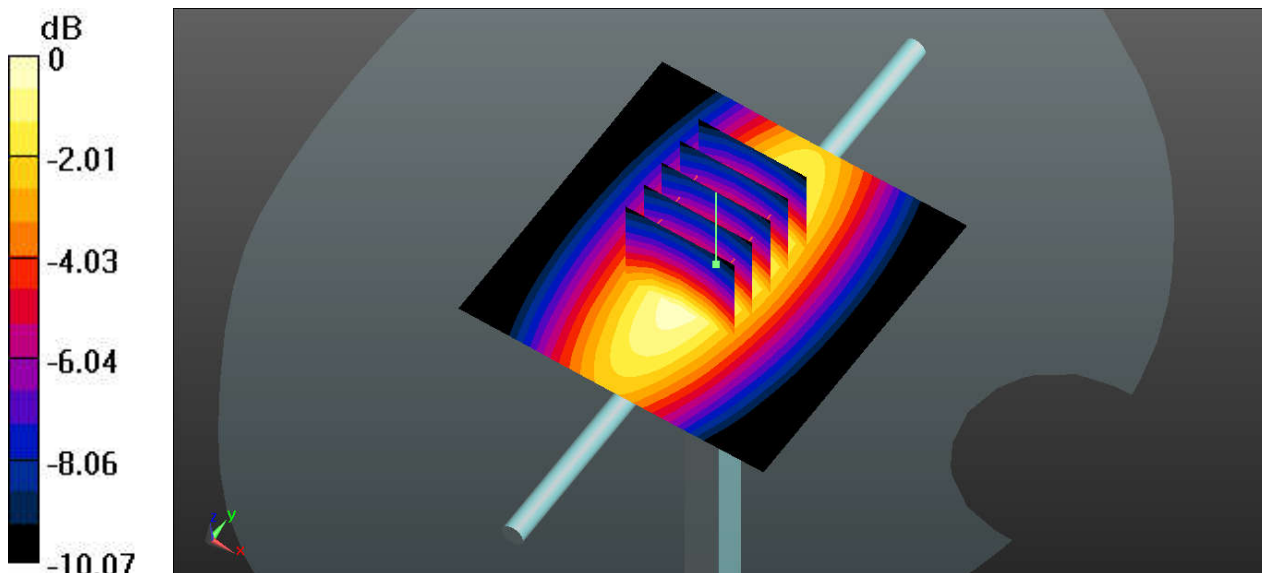

0 dB = 2.37 W/kg

## System Check\_Head\_835MHz\_170413

### DUT: 835V2\_4d162

Communication System: UID 0, CW; Frequency: 835 MHz; Duty Cycle: 1:1

Medium: HSL\_835\_170413 Medium parameters used:  $f = 835$  MHz;  $\sigma = 0.915$  S/m;  $\epsilon_r = 41.529$ ;  $\rho = 1000$  kg/m<sup>3</sup>

Ambient Temperature : 23.6 °C; Liquid Temperature : 22.8 °C

#### DASY5 Configuration:

- Probe: EX3DV4 - SN3911; ConvF(10.54, 10.54, 10.54); Calibrated: 2016.09.29;
- Sensor-Surface: 2mm (Mechanical Surface Detection)
- Electronics: DAE4 Sn1338; Calibrated: 2016.11.22
- Phantom: SAM (Front) with CRP v5.0; Type: QD000P40CD; Serial: TP:1795
- Measurement SW: DASY52, Version 52.8 (8); SEMCAD X Version 14.6.10 (7331)

**Pin=250mW/Area Scan (61x61x1):** Interpolated grid: dx=15mm, dy=15mm

Maximum value of SAR (interpolated) = 2.81 W/kg

**Pin=250mW/Zoom Scan (5x5x7)/Cube 0:** Measurement grid: dx=8mm, dy=8mm, dz=5mm

Reference Value = 56.17 V/m; Power Drift = 0.01 dB

Peak SAR (extrapolated) = 3.21 W/kg

**SAR(1 g) = 2.21 W/kg; SAR(10 g) = 1.45 W/kg**

Maximum value of SAR (measured) = 2.76 W/kg

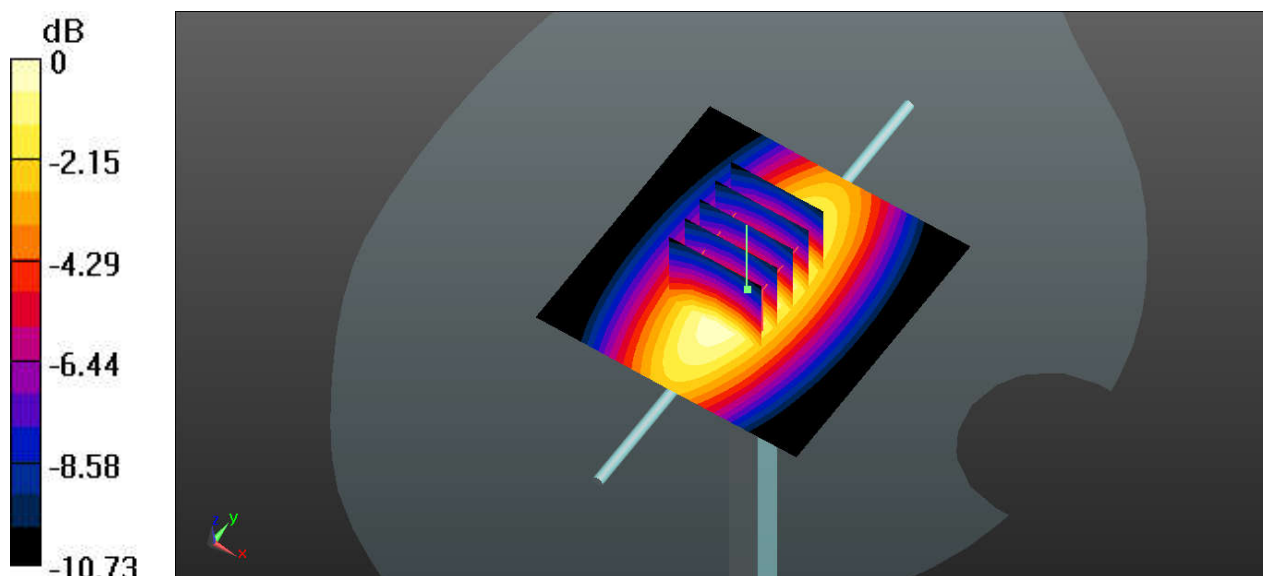

0 dB = 2.76 W/kg

## System Check\_Head\_1750MHz\_170414

### DUT: D1750V2\_1137

Communication System: UID 0, CW; Frequency: 1750 MHz; Duty Cycle: 1:1

Medium: HSL\_1800\_170414 Medium parameters used:  $f = 1750$  MHz;  $\sigma = 1.378$  S/m;  $\epsilon_r = 41.34$ ;  $\rho = 1000$  kg/m<sup>3</sup>

Ambient Temperature : 23.5 °C; Liquid Temperature : 22.9 °C

#### DASY5 Configuration:

- Probe: EX3DV4 - SN3911; ConvF(8.88, 8.88, 8.88); Calibrated: 2016.09.29;
- Sensor-Surface: 2mm (Mechanical Surface Detection)
- Electronics: DAE4 Sn1338; Calibrated: 2016.11.22
- Phantom: SAM (Front) with CRP v5.0; Type: QD000P40CD; Serial: TP:1795
- Measurement SW: DASY52, Version 52.8 (8); SEMCAD X Version 14.6.10 (7331)

**Pin=250mW/Area Scan (61x61x1):** Interpolated grid: dx=15mm, dy=15mm

Maximum value of SAR (interpolated) = 11.3 W/kg

**Pin=250mW/Zoom Scan (5x5x7)/Cube 0:** Measurement grid: dx=8mm, dy=8mm, dz=5mm

Reference Value = 85.92 V/m; Power Drift = -0.03 dB

Peak SAR (extrapolated) = 13.8 W/kg

**SAR(1 g) = 8.47 W/kg; SAR(10 g) = 4.68 W/kg**

Maximum value of SAR (measured) = 11.2 W/kg

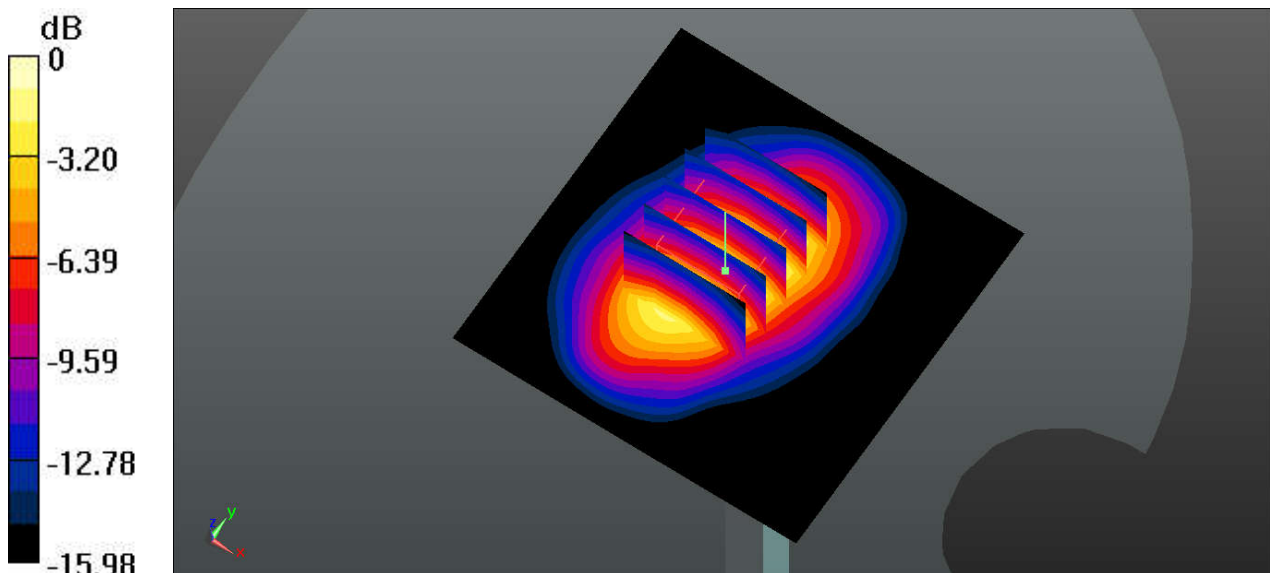

0 dB = 11.3 W/kg

## System Check\_Head\_1900MHz\_170414

### DUT: D1900V2\_5d182

Communication System: UID 0, CW; Frequency: 1900 MHz; Duty Cycle: 1:1

Medium: HSL\_1900\_170414 Medium parameters used:  $f = 1900$  MHz;  $\sigma = 1.44$  S/m;  $\epsilon_r = 40.038$ ;  $\rho = 1000$  kg/m<sup>3</sup>

Ambient Temperature : 23.6 °C; Liquid Temperature : 22.5 °C

#### DASY5 Configuration:

- Probe: EX3DV4 - SN3911; ConvF(8.5, 8.5, 8.5); Calibrated: 2016.09.29;
- Sensor-Surface: 2mm (Mechanical Surface Detection)
- Electronics: DAE4 Sn1338; Calibrated: 2016.11.22
- Phantom: SAM (Front) with CRP v5.0; Type: QD000P40CD; Serial: TP:1795
- Measurement SW: DASY52, Version 52.8 (8); SEMCAD X Version 14.6.10 (7331)

**Pin=250mW/Area Scan (61x61x1):** Interpolated grid: dx=15mm, dy=15mm

Maximum value of SAR (interpolated) = 13.0 W/kg

**Pin=250mW/Zoom Scan (5x5x7)/Cube 0:** Measurement grid: dx=8mm, dy=8mm, dz=5mm

Reference Value = 89.35 V/m; Power Drift = -0.01 dB

Peak SAR (extrapolated) = 16.1 W/kg

**SAR(1 g) = 9.55 W/kg; SAR(10 g) = 4.96 W/kg**

Maximum value of SAR (measured) = 12.5 W/kg

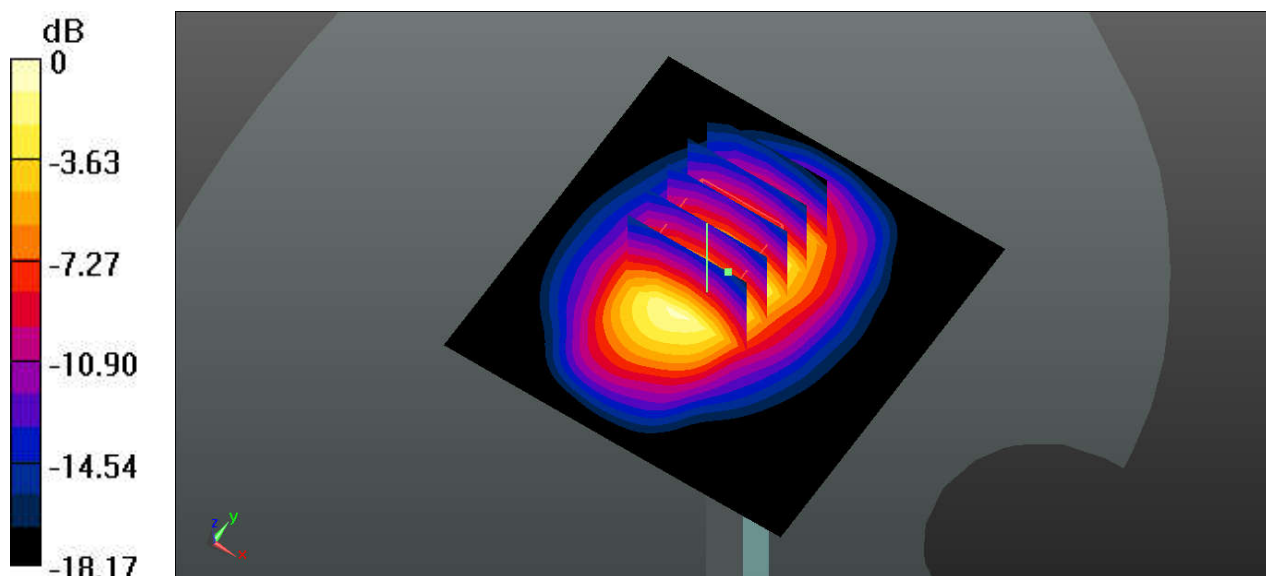

0 dB = 12.5 W/kg

## System Check\_Head\_2450MHz\_170413

### DUT: D2450V2\_840

Communication System: UID 0, CW; Frequency: 2450 MHz; Duty Cycle: 1:1  
Medium: HSL\_2450\_170413 Medium parameters used:  $f = 2450$  MHz;  $\sigma = 1.809$  S/m;  $\epsilon_r = 37.604$ ;  
 $\rho = 1000$  kg/m<sup>3</sup>  
Ambient Temperature : 23.5 °C; Liquid Temperature : 22.7 °C

#### DASY5 Configuration:

- Probe: EX3DV4 - SN3911; ConvF(7.43, 7.43, 7.43); Calibrated: 2016.09.29;
- Sensor-Surface: 2mm (Mechanical Surface Detection)
- Electronics: DAE4 Sn1338; Calibrated: 2016.11.22
- Phantom: SAM (Front) with CRP v5.0; Type: QD000P40CD; Serial: TP:1795
- Measurement SW: DASY52, Version 52.8 (8); SEMCAD X Version 14.6.10 (7331)

**Pin=250mW/Area Scan (81x81x1):** Interpolated grid: dx=12mm, dy=12mm  
Maximum value of SAR (interpolated) = 20.0 W/kg

**Pin=250mW/Zoom Scan (7x7x7)/Cube 0:** Measurement grid: dx=5mm, dy=5mm, dz=5mm  
Reference Value = 92.88 V/m; Power Drift = -0.03 dB  
Peak SAR (extrapolated) = 26.5 W/kg  
**SAR(1 g) = 13 W/kg; SAR(10 g) = 6.08 W/kg**  
Maximum value of SAR (measured) = 19.9 W/kg

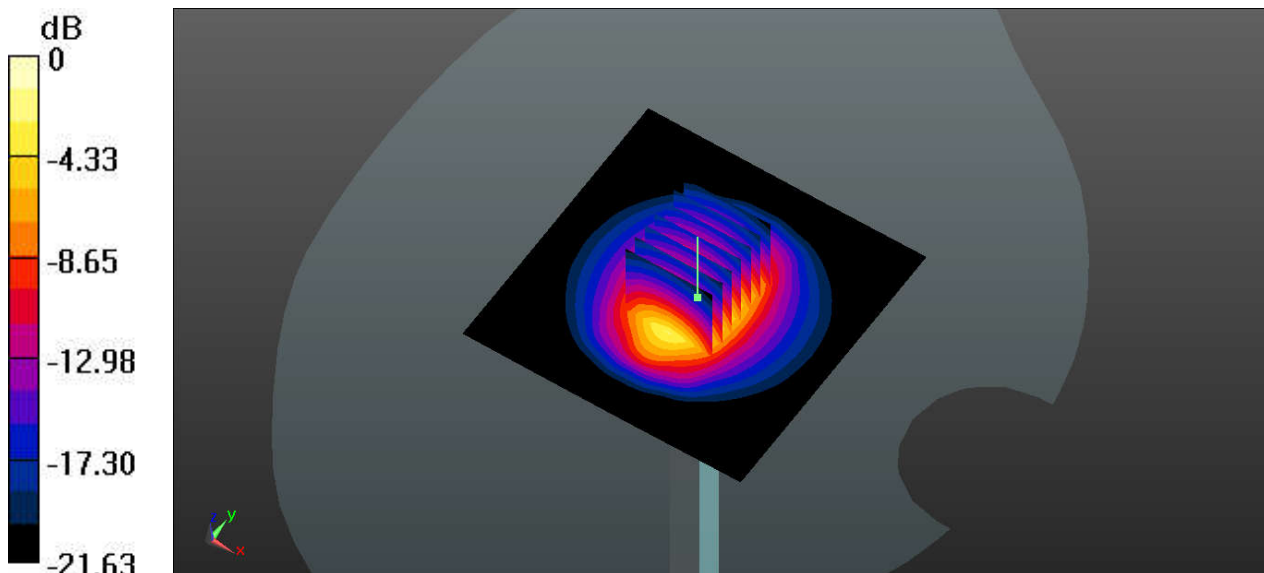

0 dB = 19.9 W/kg

## System Check\_Head\_2600MHz\_170413

### DUT: D2600V2\_1070

Communication System: UID 0, CW (0); Frequency: 2600 MHz; Duty Cycle: 1:1  
Medium: HSL\_2600\_170413 Medium parameters used:  $f = 2600$  MHz;  $\sigma = 2.056$  S/m;  $\epsilon_r = 37.575$ ;  
 $\rho = 1000$  kg/m<sup>3</sup>  
Ambient Temperature : 23.5 °C; Liquid Temperature : 22.6 °C

### DASY5 Configuration:

- Probe: EX3DV4 - SN3911; ConvF(7.39, 7.39, 7.39); Calibrated: 2016.09.29;
- Sensor-Surface: 2mm (Mechanical Surface Detection)
- Electronics: DAE4 Sn1338; Calibrated: 2016.11.22
- Phantom: SAM (Front) with CRP v5.0; Type: QD000P40CD; Serial: TP:1795
- Measurement SW: DASY52, Version 52.8 (8); SEMCAD X Version 14.6.10 (7331)

**Pin=250mW/Area Scan (71x71x1):** Interpolated grid: dx=12mm, dy=12mm  
Maximum value of SAR (interpolated) = 22.7 W/kg

**Pin=250mW/Zoom Scan (7x7x7)/Cube 0:** Measurement grid: dx=5mm, dy=5mm, dz=5mm  
Reference Value = 104.8 V/m; Power Drift = -0.17 dB  
Peak SAR (extrapolated) = 30.9 W/kg  
**SAR(1 g) = 14.6 W/kg; SAR(10 g) = 6.54 W/kg**  
Maximum value of SAR (measured) = 22.8 W/kg

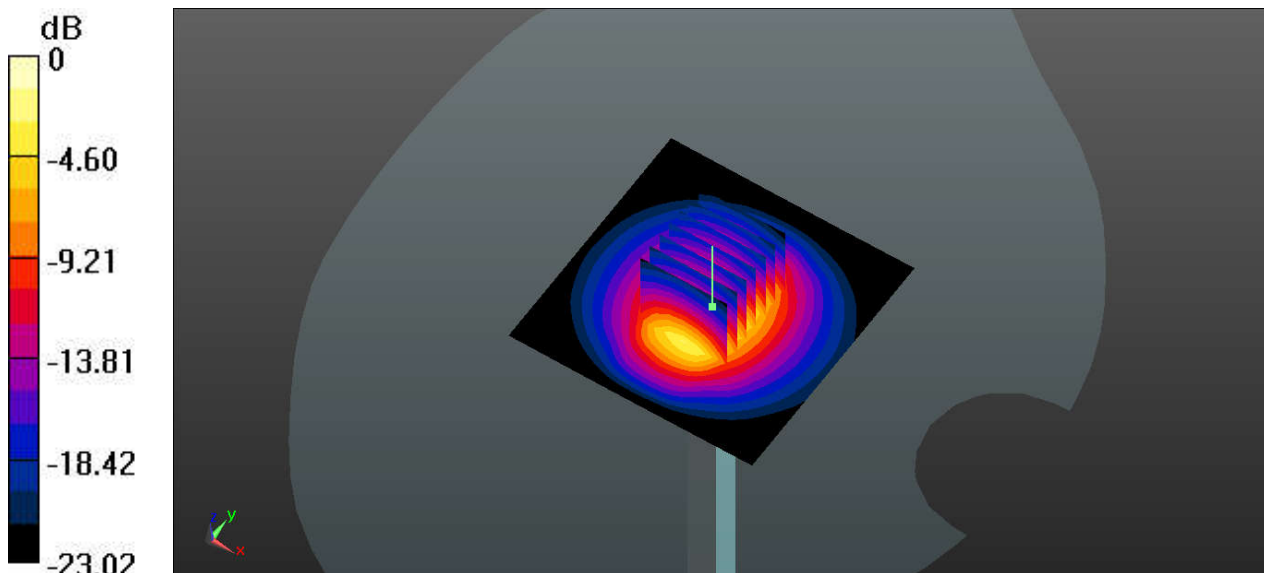

0 dB = 22.8 W/kg

## System Check\_Body\_750MHz\_170411

### DUT: D750V3\_1099

Communication System: UID 0, CW (0); Frequency: 750 MHz; Duty Cycle: 1:1  
Medium: MSL\_750\_170411 Medium parameters used:  $f = 750$  MHz;  $\sigma = 0.961$  S/m;  $\epsilon_r = 53.917$ ;  $\rho = 1000$  kg/m<sup>3</sup>  
Ambient Temperature : 23.4 °C; Liquid Temperature : 22.7 °C

#### DASY5 Configuration:

- Probe: EX3DV4 - SN3911; ConvF(10.43, 10.43, 10.43); Calibrated: 2016.09.29;
- Sensor-Surface: 2mm (Mechanical Surface Detection)
- Electronics: DAE4 Sn1338; Calibrated: 2016.11.22
- Phantom: SAM (Front) with CRP v5.0; Type: QD000P40CD; Serial: TP:1795
- Measurement SW: DASY52, Version 52.8 (8); SEMCAD X Version 14.6.10 (7331)

**Pin=250mW/Area Scan (61x61x1):** Interpolated grid: dx=15mm, dy=15mm  
Maximum value of SAR (interpolated) = 2.61 W/kg

**Pin=250mW/Zoom Scan (5x5x7)/Cube 0:** Measurement grid: dx=8mm, dy=8mm, dz=5mm  
Reference Value = 51.98 V/m; Power Drift = -0.03 dB  
Peak SAR (extrapolated) = 3.02 W/kg  
**SAR(1 g) = 2.08 W/kg; SAR(10 g) = 1.39 W/kg**  
Maximum value of SAR (measured) = 2.62 W/kg

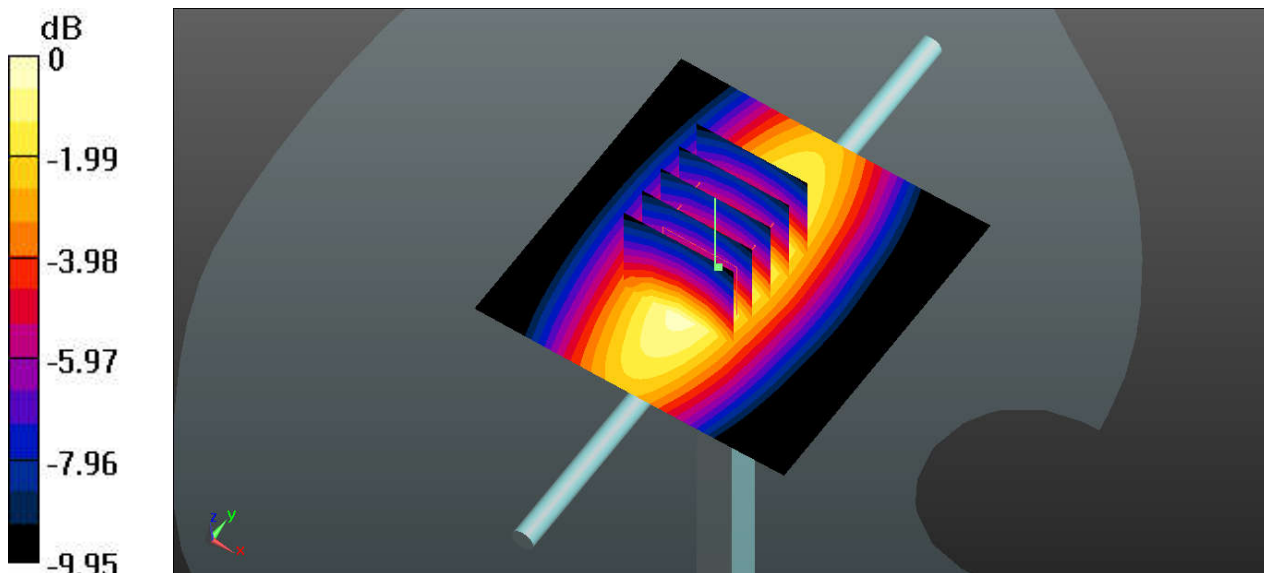

0 dB = 2.61 W/kg



## System Check\_Body\_835MHz\_170411

### DUT: D835V2\_4d162

Communication System: UID 0, CW; Frequency: 835 MHz; Duty Cycle: 1:1  
Medium: MSL\_835\_170411 Medium parameters used:  $f = 835$  MHz;  $\sigma = 0.998$  S/m;  $\epsilon_r = 54.379$ ;  $\rho = 1000$  kg/m<sup>3</sup>  
Ambient Temperature : 23.4 °C; Liquid Temperature : 22.5 °C

#### DASY5 Configuration:

- Probe: EX3DV4 - SN3911; ConvF(10.19, 10.19, 10.19); Calibrated: 2016.09.29;
- Sensor-Surface: 2mm (Mechanical Surface Detection)
- Electronics: DAE4 Sn1338; Calibrated: 2016.11.22
- Phantom: SAM (Front) with CRP v5.0; Type: QD000P40CD; Serial: TP:1795
- Measurement SW: DASY52, Version 52.8 (8); SEMCAD X Version 14.6.10 (7331)

**Pin=250mW/Area Scan (61x61x1):** Interpolated grid: dx=15mm, dy=15mm  
Maximum value of SAR (interpolated) = 2.92 W/kg

**Pin=250mW/Zoom Scan (5x5x7)/Cube 0:** Measurement grid: dx=8mm, dy=8mm, dz=5mm  
Reference Value = 49.93 V/m; Power Drift = -0.12 dB  
Peak SAR (extrapolated) = 3.29 W/kg  
**SAR(1 g) = 2.29 W/kg; SAR(10 g) = 1.51 W/kg**  
Maximum value of SAR (measured) = 2.86 W/kg

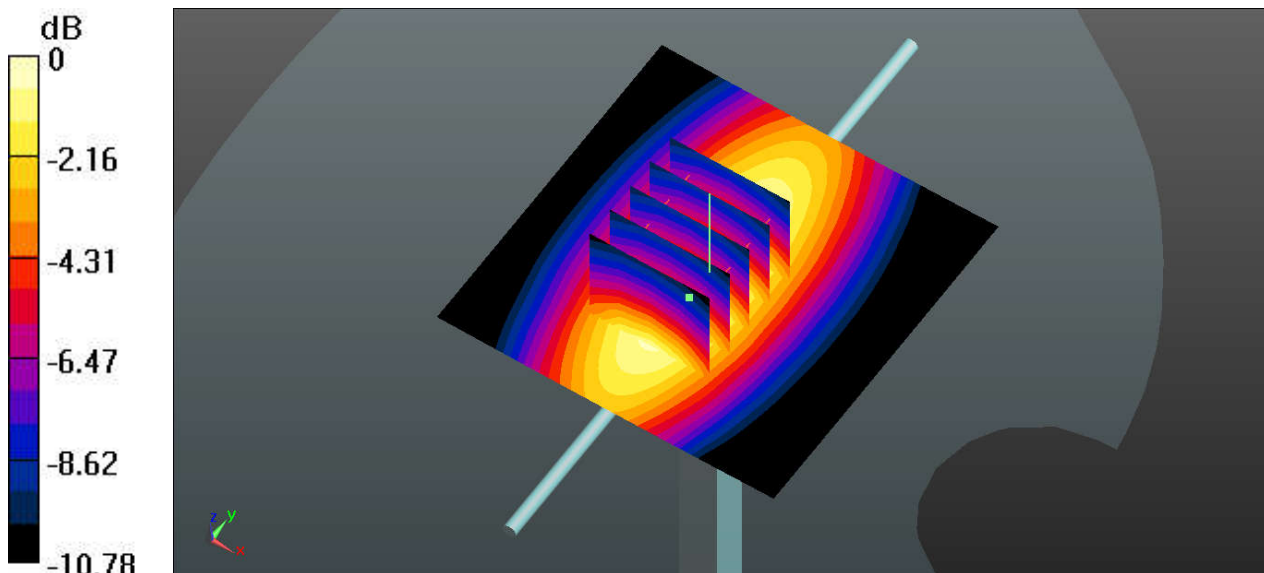

0 dB = 2.92 W/kg

## System Check\_Body\_1750MHz\_170411

### DUT: D1750V2\_1137

Communication System: UID 0, CW; Frequency: 1750 MHz; Duty Cycle: 1:1  
 Medium: MSL\_1800\_170411 Medium parameters used:  $f = 1750$  MHz;  $\sigma = 1.512$  S/m;  $\epsilon_r = 55.273$ ;  
 $\rho = 1000$  kg/m<sup>3</sup>  
 Ambient Temperature : 23.4 °C; Liquid Temperature : 22.8 °C

#### DASY5 Configuration:

- Probe: EX3DV4 - SN3911; ConvF(8.46, 8.46, 8.46); Calibrated: 2016.09.29;
- Sensor-Surface: 2mm (Mechanical Surface Detection)
- Electronics: DAE4 Sn1338; Calibrated: 2016.11.22
- Phantom: SAM (Front) with CRP v5.0; Type: QD000P40CD; Serial: TP:1795
- Measurement SW: DASY52, Version 52.8 (8); SEMCAD X Version 14.6.10 (7331)

**Pin=250mW/Area Scan (61x61x1):** Interpolated grid: dx=15mm, dy=15mm  
 Maximum value of SAR (interpolated) = 13.1 W/kg

**Pin=250mW/Zoom Scan (5x5x7)/Cube 0:** Measurement grid: dx=8mm, dy=8mm, dz=5mm  
 Reference Value = 94.15 V/m; Power Drift = 0.03 dB  
 Peak SAR (extrapolated) = 16.5 W/kg  
**SAR(1 g) = 9.29 W/kg; SAR(10 g) = 4.89 W/kg**  
 Maximum value of SAR (measured) = 13.1 W/kg

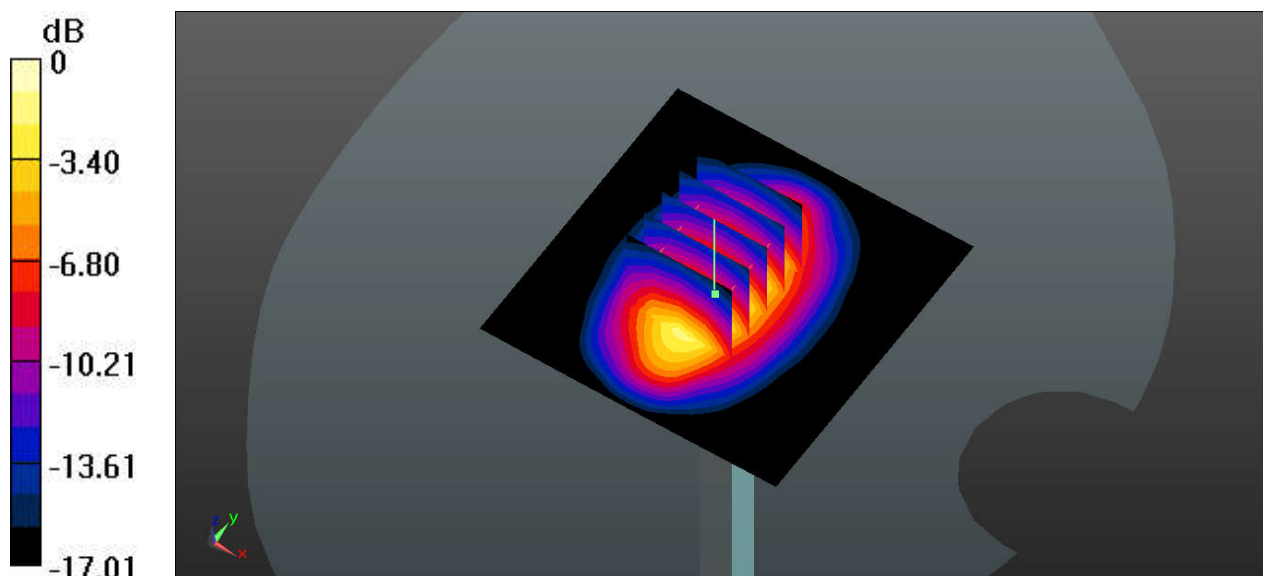

0 dB = 13.1 W/kg

## System Check\_Body\_1900MHz\_170411

### DUT: D1900V2\_5d182

Communication System: UID 0, CW; Frequency: 1900 MHz; Duty Cycle: 1:1  
Medium: MSL\_1900\_170411 Medium parameters used:  $f = 1900$  MHz;  $\sigma = 1.545$  S/m;  $\epsilon_r = 53.535$ ;  
 $\rho = 1000$  kg/m<sup>3</sup>  
Ambient Temperature : 23.3 °C; Liquid Temperature : 22.6 °C

### DASY5 Configuration:

- Probe: EX3DV4 - SN3911; ConvF(8.17, 8.17, 8.17); Calibrated: 2016.09.29;
- Sensor-Surface: 2mm (Mechanical Surface Detection)
- Electronics: DAE4 Sn1338; Calibrated: 2016.11.22
- Phantom: SAM (Front) with CRP v5.0; Type: QD000P40CD; Serial: TP:1795
- Measurement SW: DASY52, Version 52.8 (8); SEMCAD X Version 14.6.10 (7331)

**Pin=250mW/Area Scan (61x61x1):** Interpolated grid: dx=15mm, dy=15mm  
Maximum value of SAR (interpolated) = 14.5 W/kg

**Pin=250mW/Zoom Scan (5x5x7)/Cube 0:** Measurement grid: dx=8mm, dy=8mm, dz=5mm  
Reference Value = 85.13 V/m; Power Drift = -0.12 dB  
Peak SAR (extrapolated) = 18.1 W/kg  
**SAR(1 g) = 9.91 W/kg; SAR(10 g) = 5.04 W/kg**  
Maximum value of SAR (measured) = 14.3 W/kg

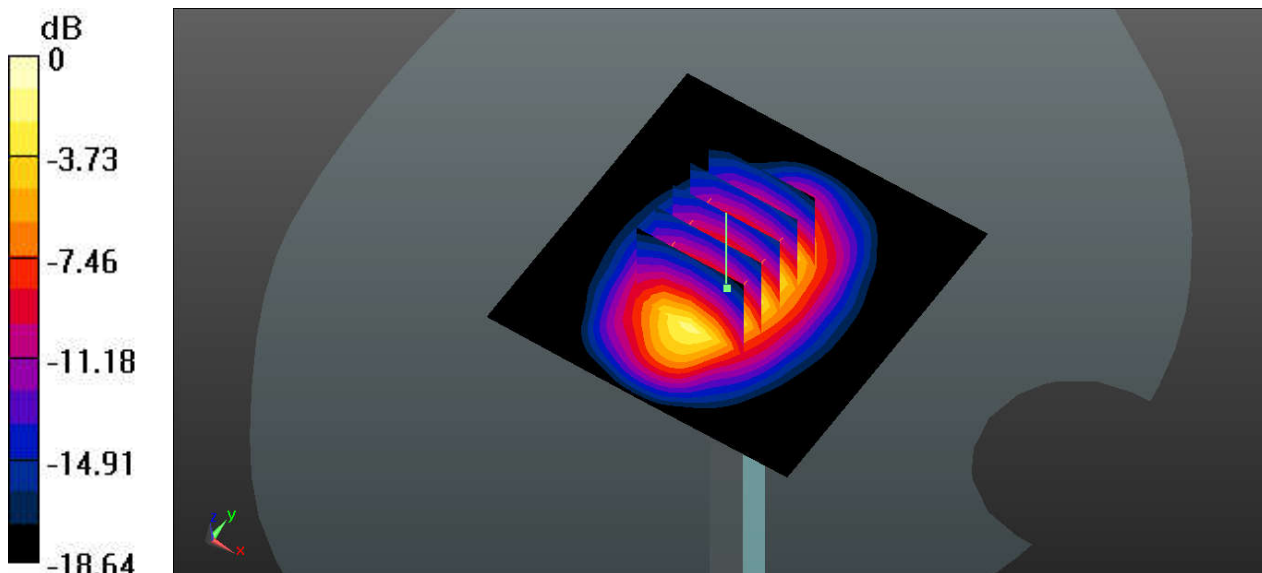

0 dB = 14.3 W/kg

## System Check\_Body\_2450MHz\_170413

### DUT: D2450V2\_840

Communication System: UID 0, CW; Frequency: 2450 MHz; Duty Cycle: 1:1

Medium: MSL\_2450\_170413 Medium parameters used:  $f = 2450$  MHz;  $\sigma = 1.976$  S/m;  $\epsilon_r = 54.13$ ;  $\rho = 1000$  kg/m<sup>3</sup>

Ambient Temperature : 23.5 °C; Liquid Temperature : 22.8 °C

#### DASY5 Configuration:

- Probe: EX3DV4 - SN3911; ConvF(7.66, 7.66, 7.66); Calibrated: 2016.09.29;
- Sensor-Surface: 2mm (Mechanical Surface Detection)
- Electronics: DAE4 Sn1338; Calibrated: 2016.11.22
- Phantom: SAM (Front) with CRP v5.0; Type: QD000P40CD; Serial: TP:1795
- Measurement SW: DASY52, Version 52.8 (8); SEMCAD X Version 14.6.10 (7331)

**Pin=250mW/Area Scan (81x81x1):** Interpolated grid: dx=12mm, dy=12mm

Maximum value of SAR (interpolated) = 18.1 W/kg

**Pin=250mW/Zoom Scan (7x7x7)/Cube 0:** Measurement grid: dx=5mm, dy=5mm, dz=5mm

Reference Value = 76.01 V/m; Power Drift = -0.02 dB

Peak SAR (extrapolated) = 23.5 W/kg

**SAR(1 g) = 12.2 W/kg; SAR(10 g) = 5.85 W/kg**

Maximum value of SAR (measured) = 18.1 W/kg

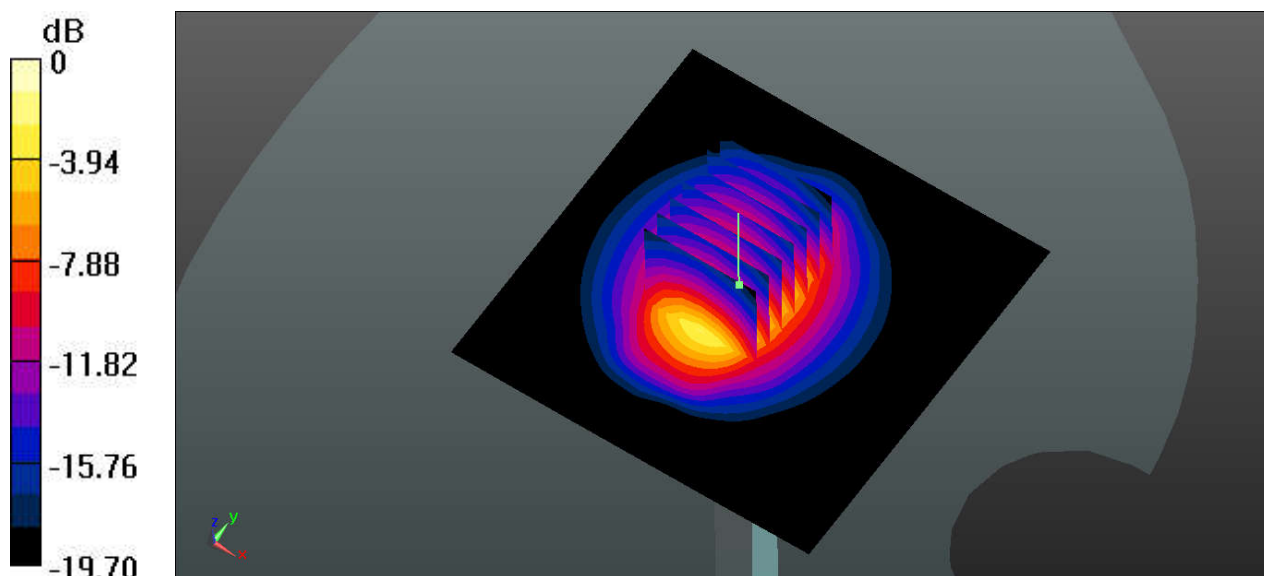

0 dB = 18.1 W/kg

## System Check\_Body\_2600MHz\_170412

### DUT: D2600V2\_1070

Communication System: UID 0, CW (0); Frequency: 2600 MHz; Duty Cycle: 1:1  
Medium: MSL\_2600\_170412 Medium parameters used:  $f = 2600$  MHz;  $\sigma = 2.201$  S/m;  $\epsilon_r = 52.823$ ;  
 $\rho = 1000$  kg/m<sup>3</sup>  
Ambient Temperature : 23.4 °C; Liquid Temperature : 22.7 °C

### DASY5 Configuration:

- Probe: EX3DV4 - SN3911; ConvF(7.38, 7.38, 7.38); Calibrated: 2016.09.29;
- Sensor-Surface: 2mm (Mechanical Surface Detection)
- Electronics: DAE4 Sn1338; Calibrated: 2016.11.22
- Phantom: SAM (Front) with CRP v5.0; Type: QD000P40CD; Serial: TP:1795
- Measurement SW: DASY52, Version 52.8 (8); SEMCAD X Version 14.6.10 (7331)

**Pin=250mW/Area Scan (71x71x1):** Interpolated grid: dx=12mm, dy=12mm  
Maximum value of SAR (interpolated) = 20.5 W/kg

**Pin=250mW/Zoom Scan (7x7x7)/Cube 0:** Measurement grid: dx=5mm, dy=5mm, dz=5mm  
Reference Value = 86.16 V/m; Power Drift = -0.09 dB  
Peak SAR (extrapolated) = 26.0 W/kg  
**SAR(1 g) = 12.8 W/kg; SAR(10 g) = 5.85 W/kg**  
Maximum value of SAR (measured) = 19.6 W/kg

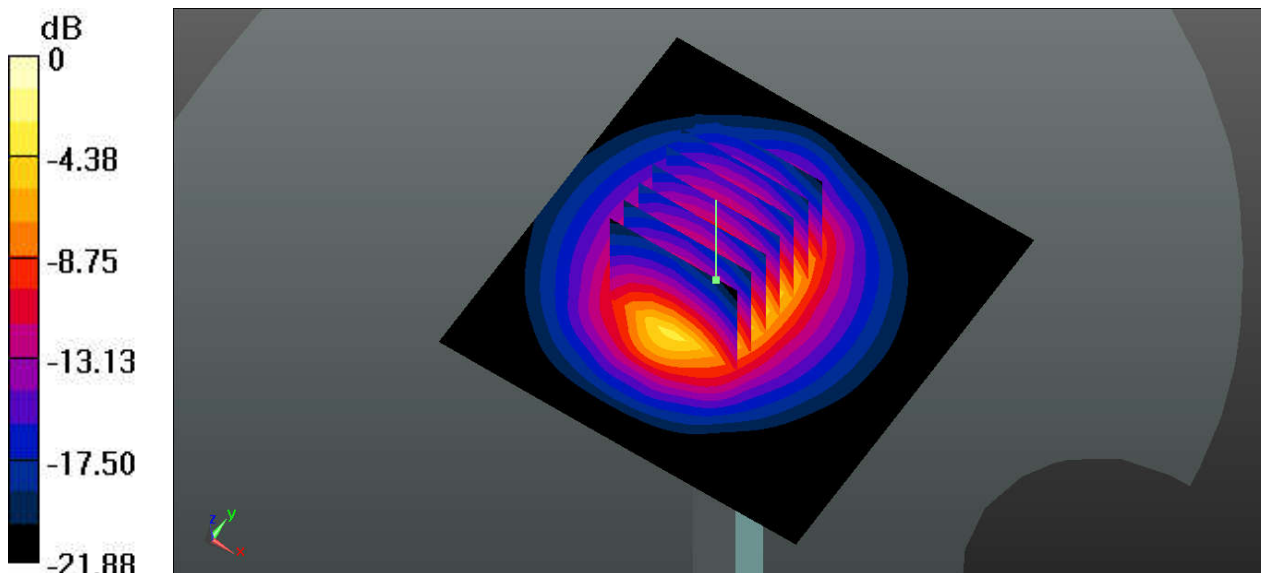

0 dB = 20.5 W/kg



---

**Appendix B. Plots of High SAR Measurement**

The plots are shown as follows.

### 01\_GSM850\_GPRS(4 Tx slots)\_Right Cheek\_Ch251

Communication System: UID 0, GPRS/EDGE12 (0); Frequency: 848.8 MHz; Duty Cycle: 1:2.08  
Medium: HSL\_835\_170413 Medium parameters used:  $f = 849 \text{ MHz}$ ;  $\sigma = 0.927 \text{ S/m}$ ;  $\epsilon_r = 41.382$ ;  $\rho = 1000 \text{ kg/m}^3$   
Ambient Temperature :  $23.6 \text{ }^\circ\text{C}$ ; Liquid Temperature :  $22.8 \text{ }^\circ\text{C}$

#### DASY5 Configuration:

- Probe: EX3DV4 - SN3911; ConvF(10.54, 10.54, 10.54); Calibrated: 2016.09.29;
- Sensor-Surface: 2mm (Mechanical Surface Detection)
- Electronics: DAE4 Sn1338; Calibrated: 2016.11.22
- Phantom: SAM (Front) with CRP v5.0; Type: QD000P40CD; Serial: TP:1795
- Measurement SW: DASY52, Version 52.8 (8); SEMCAD X Version 14.6.10 (7331)

**Ch251/Area Scan (71x111x1):** Interpolated grid:  $dx=15\text{mm}$ ,  $dy=15\text{mm}$   
Maximum value of SAR (interpolated) =  $0.578 \text{ W/kg}$

**Ch251/Zoom Scan (5x5x7)/Cube 0:** Measurement grid:  $dx=8\text{mm}$ ,  $dy=8\text{mm}$ ,  $dz=5\text{mm}$   
Reference Value =  $1.305 \text{ V/m}$ ; Power Drift =  $0.13 \text{ dB}$   
Peak SAR (extrapolated) =  $0.633 \text{ W/kg}$   
**SAR(1 g) =  $0.509 \text{ W/kg}$ ; SAR(10 g) =  $0.375 \text{ W/kg}$**   
Maximum value of SAR (measured) =  $0.577 \text{ W/kg}$

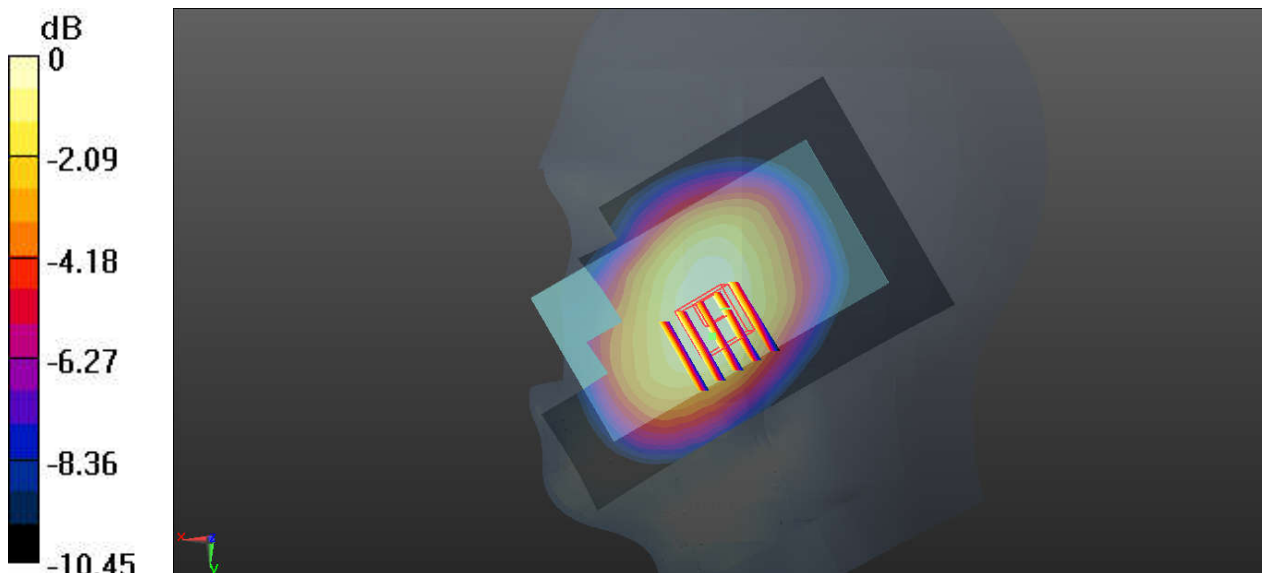

0 dB =  $0.577 \text{ W/kg}$

## 02\_GSM1900\_GPRS(4 Tx slots)\_Left Cheek\_Ch512

Communication System: UID 0, GPRS/EDGE12 (0); Frequency: 1850.2 MHz; Duty Cycle: 1:2.08  
 Medium: HSL\_1900\_170414 Medium parameters used:  $f = 1850.2$  MHz;  $\sigma = 1.389$  S/m;  $\epsilon_r = 40.259$ ;  $\rho = 1000$  kg/m<sup>3</sup>  
 Ambient Temperature : 23.6 °C; Liquid Temperature : 22.5 °C

### DASY5 Configuration:

- Probe: EX3DV4 - SN3911; ConvF(8.5, 8.5, 8.5); Calibrated: 2016.09.29;
- Sensor-Surface: 2mm (Mechanical Surface Detection)
- Electronics: DAE4 Sn1338; Calibrated: 2016.11.22
- Phantom: SAM (Front) with CRP v5.0; Type: QD000P40CD; Serial: TP:1795
- Measurement SW: DASY52, Version 52.8 (8); SEMCAD X Version 14.6.10 (7331)

**Ch512/Area Scan (71x111x1):** Interpolated grid: dx=15mm, dy=15mm  
 Maximum value of SAR (interpolated) = 0.247 W/kg

**Ch512/Zoom Scan (5x5x7)/Cube 0:** Measurement grid: dx=8mm, dy=8mm, dz=5mm  
 Reference Value = 0.3650 V/m; Power Drift = -0.07 dB  
 Peak SAR (extrapolated) = 0.297 W/kg  
**SAR(1 g) = 0.197 W/kg; SAR(10 g) = 0.124 W/kg**  
 Maximum value of SAR (measured) = 0.249 W/kg

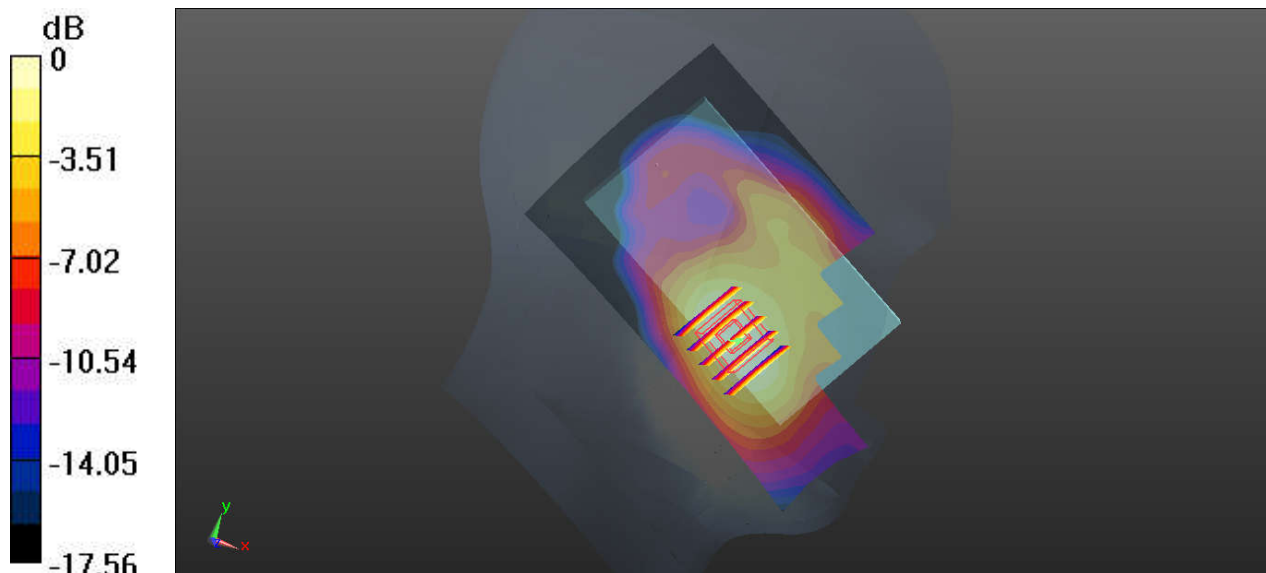

0 dB = 0.247 W/kg



### 03\_WCDMA V\_RMC 12.2Kbps\_Right Cheek\_Ch4182

Communication System: UID 0, UMTS (0); Frequency: 836.4 MHz; Duty Cycle: 1:1  
Medium: HSL\_835\_170413 Medium parameters used:  $f = 836.5$  MHz;  $\sigma = 0.917$  S/m;  $\epsilon_r = 41.516$ ;  
 $\rho = 1000$  kg/m<sup>3</sup>  
Ambient Temperature : 23.6 °C; Liquid Temperature : 22.8 °C

#### DASY5 Configuration:

- Probe: EX3DV4 - SN3911; ConvF(10.54, 10.54, 10.54); Calibrated: 2016.09.29;
- Sensor-Surface: 2mm (Mechanical Surface Detection)
- Electronics: DAE4 Sn1338; Calibrated: 2016.11.22
- Phantom: SAM (Front) with CRP v5.0; Type: QD000P40CD; Serial: TP:1795
- Measurement SW: DASY52, Version 52.8 (8); SEMCAD X Version 14.6.10 (7331)

**Ch4182/Area Scan (71x111x1):** Interpolated grid: dx=15mm, dy=15mm  
Maximum value of SAR (interpolated) = 0.307 W/kg

**Ch4182/Zoom Scan (5x5x7)/Cube 0:** Measurement grid: dx=8mm, dy=8mm, dz=5mm  
Reference Value = 0.6340 V/m; Power Drift = 0.04 dB  
Peak SAR (extrapolated) = 0.342 W/kg  
**SAR(1 g) = 0.273 W/kg; SAR(10 g) = 0.202 W/kg**  
Maximum value of SAR (measured) = 0.312 W/kg

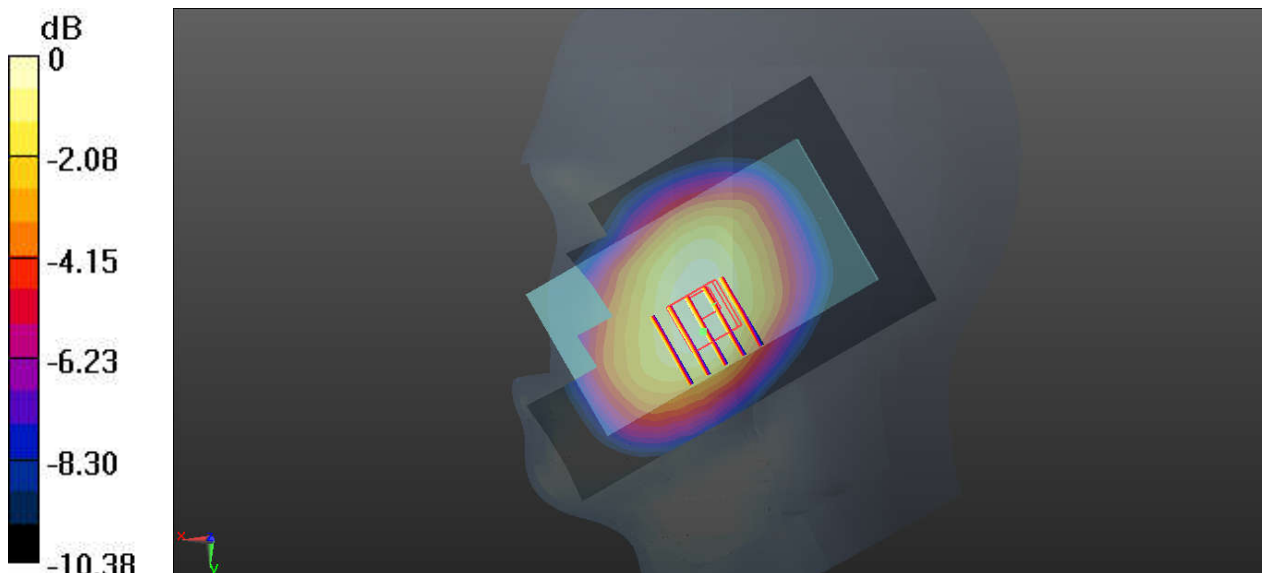

0 dB = 0.312 W/kg

## 04\_WCDMA II\_RMC 12.2Kbps\_Left Cheek\_Ch9538

Communication System: UID 0, UMTS (0); Frequency: 1907.6 MHz; Duty Cycle: 1:1  
 Medium: HSL\_1900\_170414 Medium parameters used:  $f = 1908 \text{ MHz}$ ;  $\sigma = 1.448 \text{ S/m}$ ;  $\epsilon_r = 40.004$ ;  
 $\rho = 1000 \text{ kg/m}^3$   
 Ambient Temperature :  $23.6 \text{ }^\circ\text{C}$ ; Liquid Temperature :  $22.5 \text{ }^\circ\text{C}$

### DASY5 Configuration:

- Probe: EX3DV4 - SN3911; ConvF(8.5, 8.5, 8.5); Calibrated: 2016.09.29;
- Sensor-Surface: 2mm (Mechanical Surface Detection)
- Electronics: DAE4 Sn1338; Calibrated: 2016.11.22
- Phantom: SAM (Front) with CRP v5.0; Type: QD000P40CD; Serial: TP:1795
- Measurement SW: DASY52, Version 52.8 (8); SEMCAD X Version 14.6.10 (7331)

**Ch9538/Area Scan (71x111x1):** Interpolated grid:  $dx=15\text{mm}$ ,  $dy=15\text{mm}$   
 Maximum value of SAR (interpolated) =  $0.239 \text{ W/kg}$

**Ch9538/Zoom Scan (5x5x7)/Cube 0:** Measurement grid:  $dx=8\text{mm}$ ,  $dy=8\text{mm}$ ,  $dz=5\text{mm}$   
 Reference Value =  $0.8370 \text{ V/m}$ ; Power Drift =  $-0.06 \text{ dB}$   
 Peak SAR (extrapolated) =  $0.282 \text{ W/kg}$   
**SAR(1 g) =  $0.183 \text{ W/kg}$ ; SAR(10 g) =  $0.113 \text{ W/kg}$**   
 Maximum value of SAR (measured) =  $0.235 \text{ W/kg}$

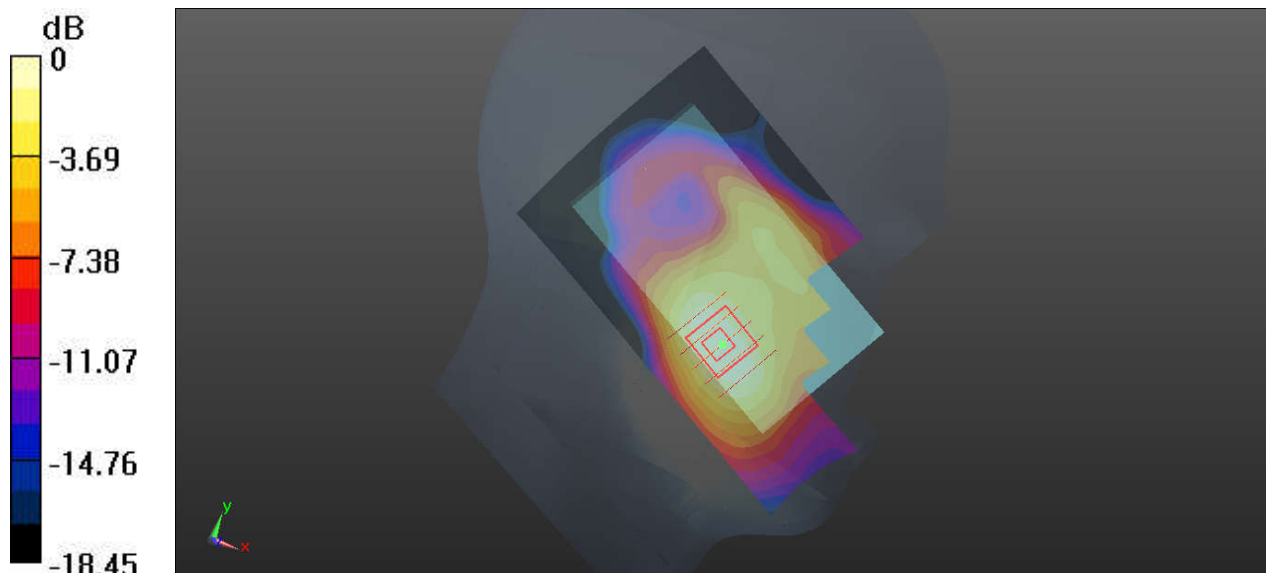

0 dB =  $0.239 \text{ W/kg}$

### 05\_LTE Band 28\_20M\_QPSK\_50RB\_50Offset\_Right Cheek\_Ch27435

Communication System: UID 0, LTE (0); Frequency: 725.5 MHz; Duty Cycle: 1:1  
Medium: HSL\_750\_170413 Medium parameters used:  $f = 725.5$  MHz;  $\sigma = 0.873$  S/m;  $\epsilon_r = 41.418$ ;  
 $\rho = 1000$  kg/m<sup>3</sup>  
Ambient Temperature : 23.5 °C; Liquid Temperature : 22.7 °C

#### DASY5 Configuration:

- Probe: EX3DV4 - SN3911; ConvF(10.99, 10.99, 10.99); Calibrated: 2016.09.29;
- Sensor-Surface: 2mm (Mechanical Surface Detection)
- Electronics: DAE4 Sn1338; Calibrated: 2016.11.22
- Phantom: SAM (Front) with CRP v5.0; Type: QD000P40CD; Serial: TP:1795
- Measurement SW: DASY52, Version 52.8 (8); SEMCAD X Version 14.6.10 (7331)

**Ch27435/Area Scan (71x111x1):** Interpolated grid: dx=15mm, dy=15mm  
Maximum value of SAR (interpolated) = 0.0698 W/kg

**Ch27435/Zoom Scan (5x5x7)/Cube 0:** Measurement grid: dx=8mm, dy=8mm, dz=5mm  
Reference Value = 1.140 V/m; Power Drift = 0.04 dB  
Peak SAR (extrapolated) = 0.0720 W/kg  
**SAR(1 g) = 0.059 W/kg; SAR(10 g) = 0.045 W/kg**  
Maximum value of SAR (measured) = 0.0657 W/kg

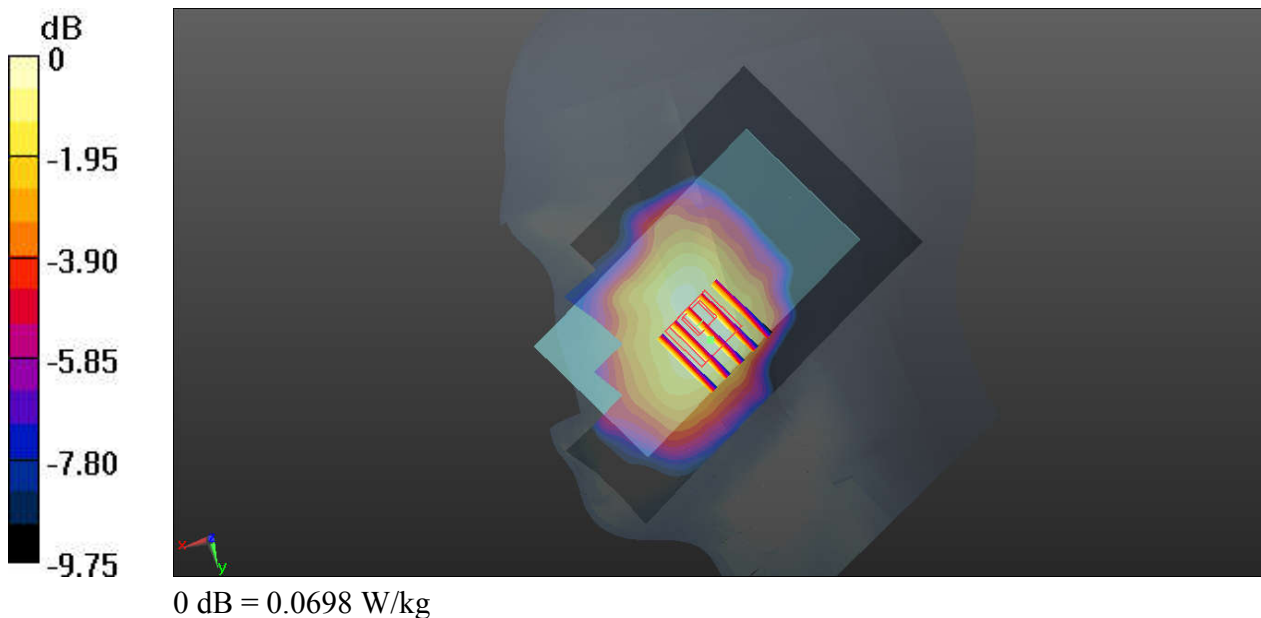

### 06\_LTE Band 4\_20M\_QPSK\_1RB\_0Offset\_Left Cheek\_Ch20175

Communication System: UID 0, LTE (0); Frequency: 1732.5 MHz; Duty Cycle: 1:1  
Medium: HSL\_1800\_170414 Medium parameters used:  $f = 1732.5$  MHz;  $\sigma = 1.36$  S/m;  $\epsilon_r = 41.426$ ;  
 $\rho = 1000$  kg/m<sup>3</sup>  
Ambient Temperature : 23.5 °C; Liquid Temperature : 22.9 °C

#### DASY5 Configuration:

- Probe: EX3DV4 - SN3911; ConvF(8.88, 8.88, 8.88); Calibrated: 2016.09.29;
- Sensor-Surface: 2mm (Mechanical Surface Detection)
- Electronics: DAE4 Sn1338; Calibrated: 2016.11.22
- Phantom: SAM (Front) with CRP v5.0; Type: QD000P40CD; Serial: TP:1795
- Measurement SW: DASY52, Version 52.8 (8); SEMCAD X Version 14.6.10 (7331)

**Ch20175/Area Scan (71x111x1):** Interpolated grid: dx=15mm, dy=15mm  
Maximum value of SAR (interpolated) = 0.474 W/kg

**Ch20175/Zoom Scan (5x5x7)/Cube 0:** Measurement grid: dx=8mm, dy=8mm, dz=5mm  
Reference Value = 1.037 V/m; Power Drift = -0.03 dB  
Peak SAR (extrapolated) = 0.568 W/kg  
**SAR(1 g) = 0.390 W/kg; SAR(10 g) = 0.254 W/kg**  
Maximum value of SAR (measured) = 0.480 W/kg

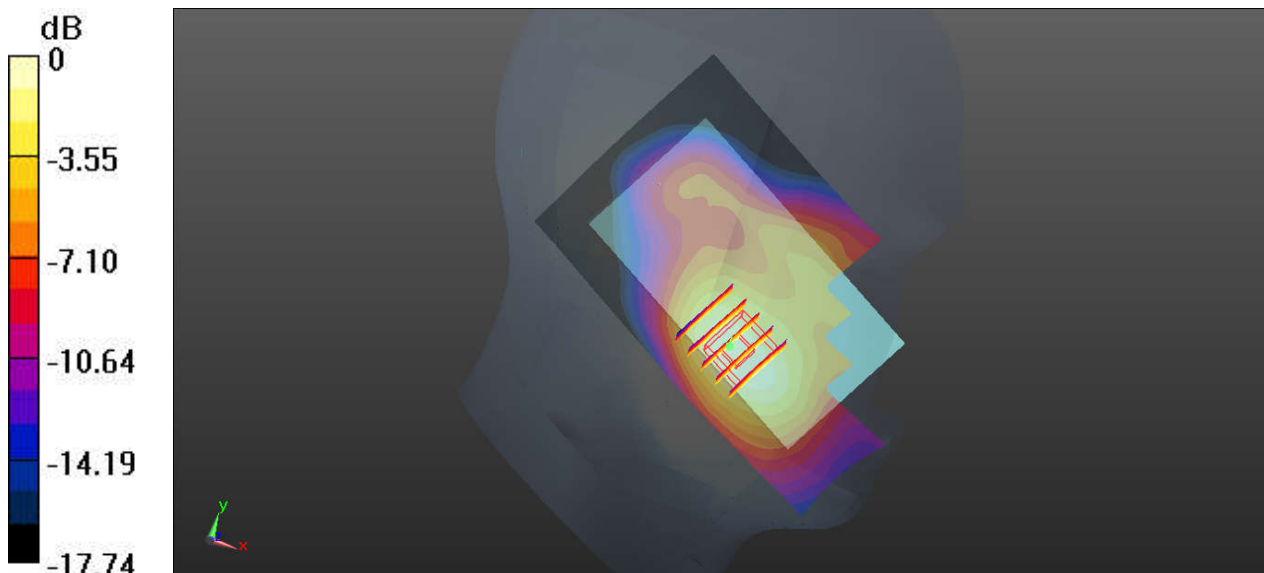

0 dB = 0.474 W/kg

### 07\_LTE Band 7\_20M\_QPSK\_1RB\_0Offset\_Right Cheek\_Ch21350

Communication System: UID 0, LTE (0); Frequency: 2560 MHz; Duty Cycle: 1:1  
Medium: HSL\_2600\_170413 Medium parameters used:  $f = 2560$  MHz;  $\sigma = 2.009$  S/m;  $\epsilon_r = 37.777$ ;  
 $\rho = 1000$  kg/m<sup>3</sup>  
Ambient Temperature : 23.5 °C; Liquid Temperature : 22.6 °C

#### DASY5 Configuration:

- Probe: EX3DV4 - SN3911; ConvF(7.39, 7.39, 7.39); Calibrated: 2016.09.29;
- Sensor-Surface: 2mm (Mechanical Surface Detection)
- Electronics: DAE4 Sn1338; Calibrated: 2016.11.22
- Phantom: SAM (Front) with CRP v5.0; Type: QD000P40CD; Serial: TP:1795
- Measurement SW: DASY52, Version 52.8 (8); SEMCAD X Version 14.6.10 (7331)

**Ch21350/Area Scan (81x131x1):** Interpolated grid: dx=12mm, dy=12mm  
Maximum value of SAR (interpolated) = 0.0353 W/kg

**Ch21350/Zoom Scan (7x7x7)/Cube 0:** Measurement grid: dx=5mm, dy=5mm, dz=5mm  
Reference Value = 1.957 V/m; Power Drift = 0.03 dB  
Peak SAR (extrapolated) = 0.0520 W/kg  
**SAR(1 g) = 0.00715 W/kg; SAR(10 g) = 0.00112 W/kg**  
Maximum value of SAR (measured) = 0.0442 W/kg

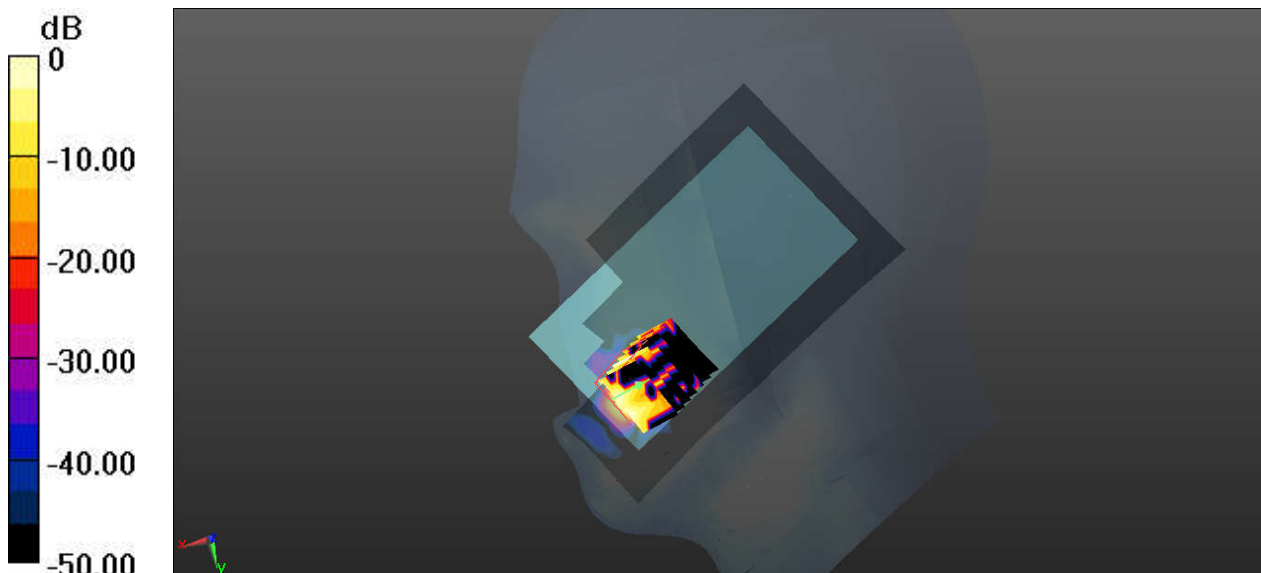

0 dB = 0.0353 W/kg = -14.52 dBW/kg

### 08\_WLAN2.4GHz\_802.11b 1Mbps\_Right Cheek\_0mm\_Ch1

Communication System: UID 0, WIFI (0); Frequency: 2412 MHz; Duty Cycle: 1:1.003  
Medium: HSL\_2450\_170413 Medium parameters used:  $f = 2412$  MHz;  $\sigma = 1.768$  S/m;  $\epsilon_r = 37.788$ ;  
 $\rho = 1000$  kg/m<sup>3</sup>  
Ambient Temperature : 23.5 °C; Liquid Temperature : 22.7 °C

#### DASY5 Configuration:

- Probe: EX3DV4 - SN3911; ConvF(7.43, 7.43, 7.43); Calibrated: 2016.09.29;
- Sensor-Surface: 2mm (Mechanical Surface Detection)
- Electronics: DAE4 Sn1338; Calibrated: 2016.11.22
- Phantom: SAM (Front) with CRP v5.0; Type: QD000P40CD; Serial: TP:1795
- Measurement SW: DASY52, Version 52.8 (8); SEMCAD X Version 14.6.10 (7331)

**Ch1/Area Scan (81x131x1):** Interpolated grid: dx=12mm, dy=12mm  
Maximum value of SAR (interpolated) = 0.980 W/kg

**Ch1/Zoom Scan (7x7x7)/Cube 0:** Measurement grid: dx=5mm, dy=5mm, dz=5mm  
Reference Value = 13.39 V/m; Power Drift = 0.18 dB  
Peak SAR (extrapolated) = 1.28 W/kg  
**SAR(1 g) = 0.617 W/kg; SAR(10 g) = 0.298 W/kg**  
Maximum value of SAR (measured) = 0.939 W/kg

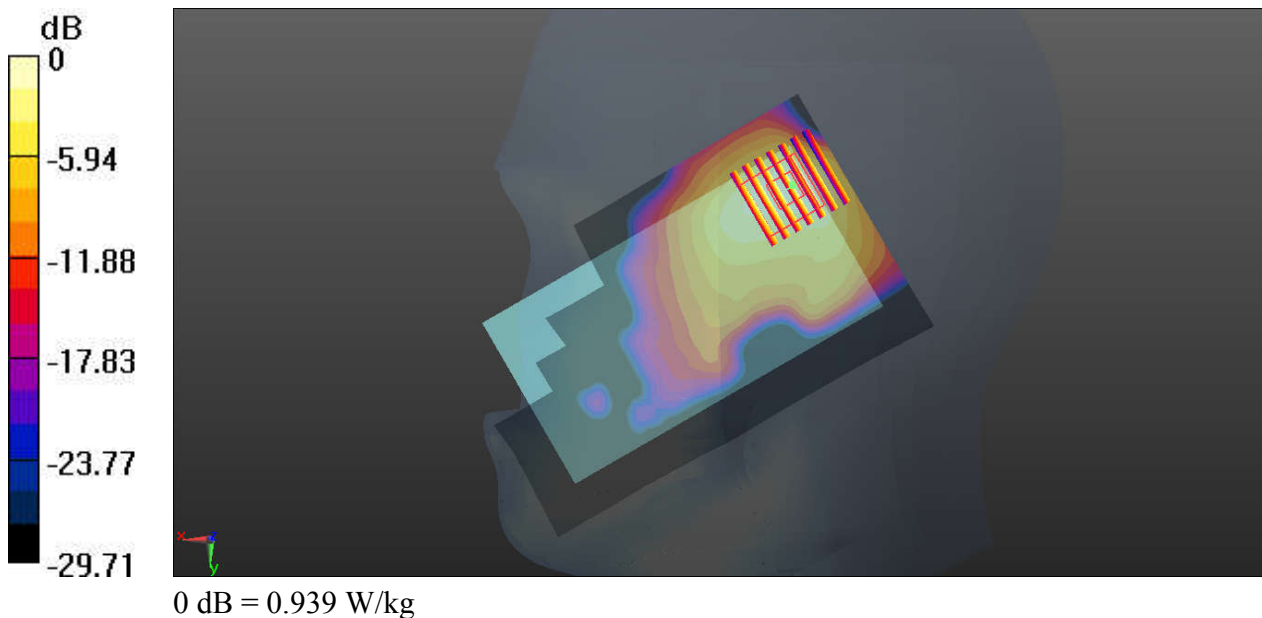

### 09\_GSM850\_GPRS(4 Tx slots)\_Back\_10mm\_Ch251

Communication System: UID 0, GPRS/EDGE12 (0); Frequency: 848.8 MHz; Duty Cycle: 1:2.08  
Medium: MSL\_835\_170411 Medium parameters used:  $f = 849$  MHz;  $\sigma = 1.01$  S/m;  $\epsilon_r = 54.249$ ;  $\rho = 1000$  kg/m<sup>3</sup>  
Ambient Temperature : 23.4 °C; Liquid Temperature : 22.5 °C

#### DASY5 Configuration:

- Probe: EX3DV4 - SN3911; ConvF(10.19, 10.19, 10.19); Calibrated: 2016.09.29;
- Sensor-Surface: 2mm (Mechanical Surface Detection)
- Electronics: DAE4 Sn1338; Calibrated: 2016.11.22
- Phantom: SAM (Front) with CRP v5.0; Type: QD000P40CD; Serial: TP:1795
- Measurement SW: DASY52, Version 52.8 (8); SEMCAD X Version 14.6.10 (7331)

**Ch251/Area Scan (61x101x1):** Interpolated grid: dx=15mm, dy=15mm  
Maximum value of SAR (interpolated) = 1.02 W/kg

**Ch251/Zoom Scan (5x5x7)/Cube 0:** Measurement grid: dx=8mm, dy=8mm, dz=5mm  
Reference Value = 3.101 V/m; Power Drift = 0.05 dB  
Peak SAR (extrapolated) = 1.11 W/kg  
**SAR(1 g) = 0.892 W/kg; SAR(10 g) = 0.685 W/kg**  
Maximum value of SAR (measured) = 1.02 W/kg

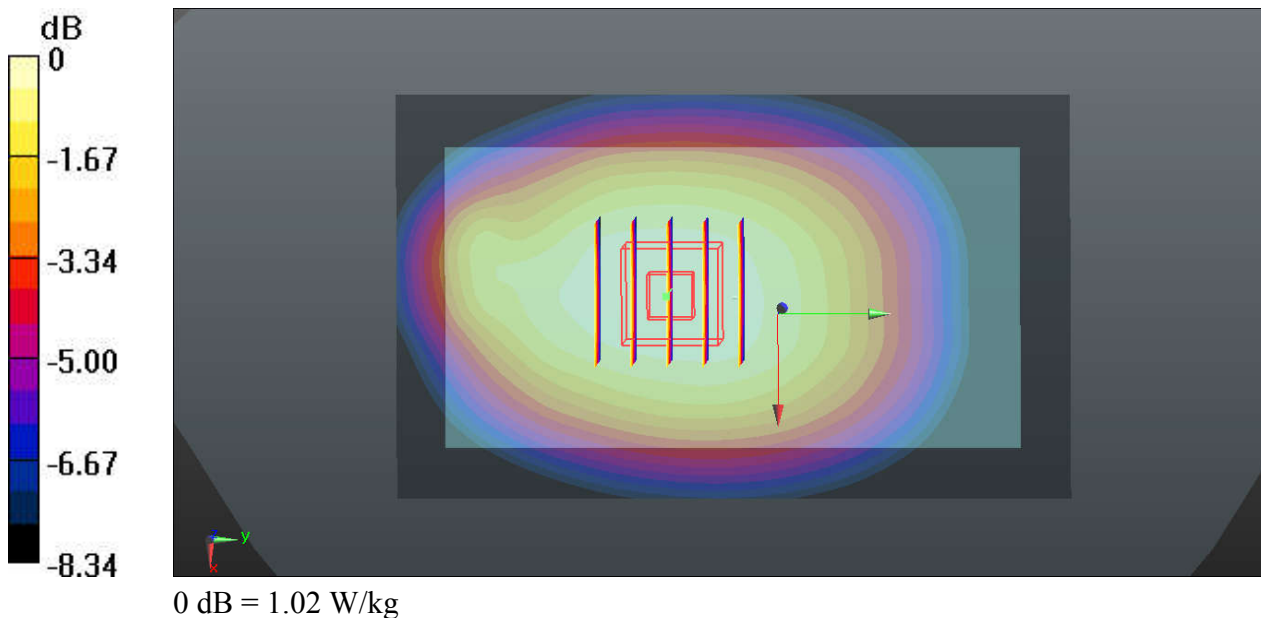

### 10\_GSM1900\_GPRS(4 Tx slots)\_Front\_10mm\_Ch512

Communication System: UID 0, GPRS/EDGE12 (0); Frequency: 1850.2 MHz; Duty Cycle: 1:2.08  
Medium: MSL\_1900\_170411 Medium parameters used:  $f = 1850.2$  MHz;  $\sigma = 1.487$  S/m;  $\epsilon_r = 53.637$ ;  $\rho = 1000$  kg/m<sup>3</sup>  
Ambient Temperature : 23.3 °C; Liquid Temperature : 22.6 °C

#### DASY5 Configuration:

- Probe: EX3DV4 - SN3911; ConvF(8.17, 8.17, 8.17); Calibrated: 2016.09.29;
- Sensor-Surface: 2mm (Mechanical Surface Detection)
- Electronics: DAE4 Sn1338; Calibrated: 2016.11.22
- Phantom: SAM (Front) with CRP v5.0; Type: QD000P40CD; Serial: TP:1795
- Measurement SW: DASY52, Version 52.8 (8); SEMCAD X Version 14.6.10 (7331)

**Ch512/Area Scan (61x101x1):** Interpolated grid: dx=15mm, dy=15mm  
Maximum value of SAR (interpolated) = 0.675 W/kg

**Ch512/Zoom Scan (5x5x7)/Cube 0:** Measurement grid: dx=8mm, dy=8mm, dz=5mm  
Reference Value = 0.2120 V/m; Power Drift = 0.11 dB  
Peak SAR (extrapolated) = 0.981 W/kg  
**SAR(1 g) = 0.597 W/kg; SAR(10 g) = 0.322 W/kg**  
Maximum value of SAR (measured) = 0.777 W/kg

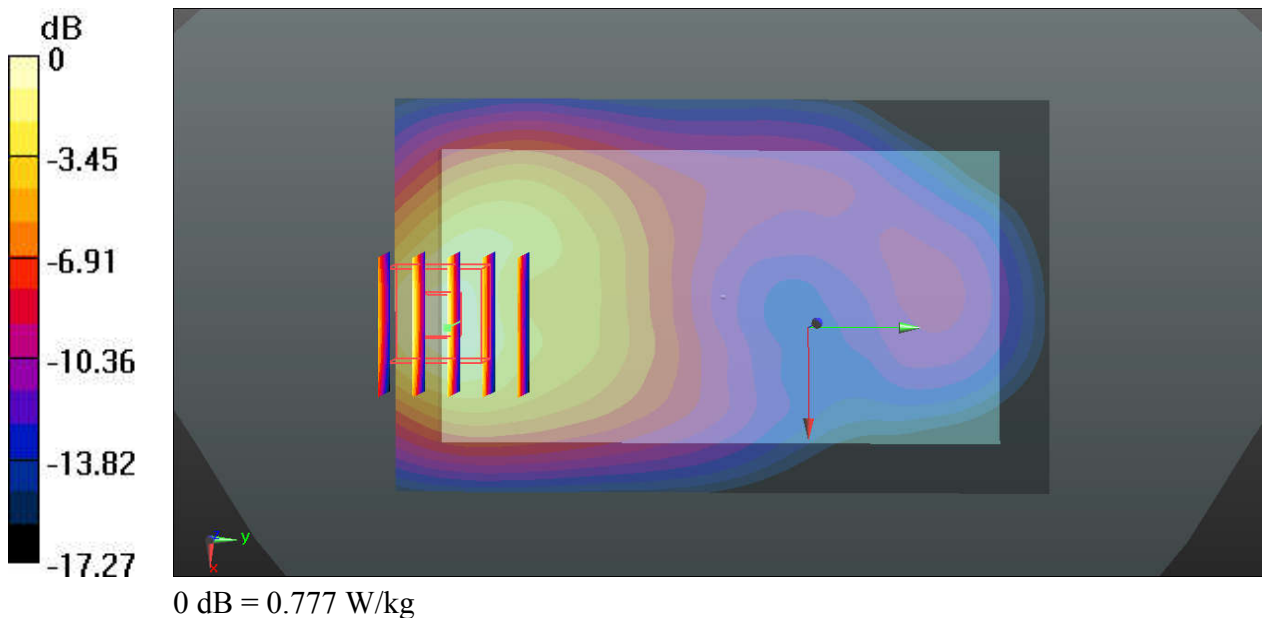



## 11\_WCDMA V\_RMC 12.2Kbps\_Back\_10mm\_Ch4182

Communication System: UID 0, UMTS (0); Frequency: 836.4 MHz; Duty Cycle: 1:1  
Medium: MSL\_835\_170411 Medium parameters used:  $f = 836.4$  MHz;  $\sigma = 0.999$  S/m;  $\epsilon_r = 54.362$ ;  
 $\rho = 1000$  kg/m<sup>3</sup>  
Ambient Temperature : 23.4 °C; Liquid Temperature : 22.5 °C

### DASY5 Configuration:

- Probe: EX3DV4 - SN3911; ConvF(10.19, 10.19, 10.19); Calibrated: 2016.09.29;
- Sensor-Surface: 2mm (Mechanical Surface Detection)
- Electronics: DAE4 Sn1338; Calibrated: 2016.11.22
- Phantom: SAM (Front) with CRP v5.0; Type: QD000P40CD; Serial: TP:1795
- Measurement SW: DASY52, Version 52.8 (8); SEMCAD X Version 14.6.10 (7331)

**Ch4182/Area Scan (61x101x1):** Interpolated grid: dx=15mm, dy=15mm  
Maximum value of SAR (interpolated) = 0.588 W/kg

**Ch4182/Zoom Scan (5x5x7)/Cube 0:** Measurement grid: dx=8mm, dy=8mm, dz=5mm  
Reference Value = 2.600 V/m; Power Drift = 0.14 dB  
Peak SAR (extrapolated) = 0.622 W/kg  
**SAR(1 g) = 0.502 W/kg; SAR(10 g) = 0.386 W/kg**  
Maximum value of SAR (measured) = 0.570 W/kg

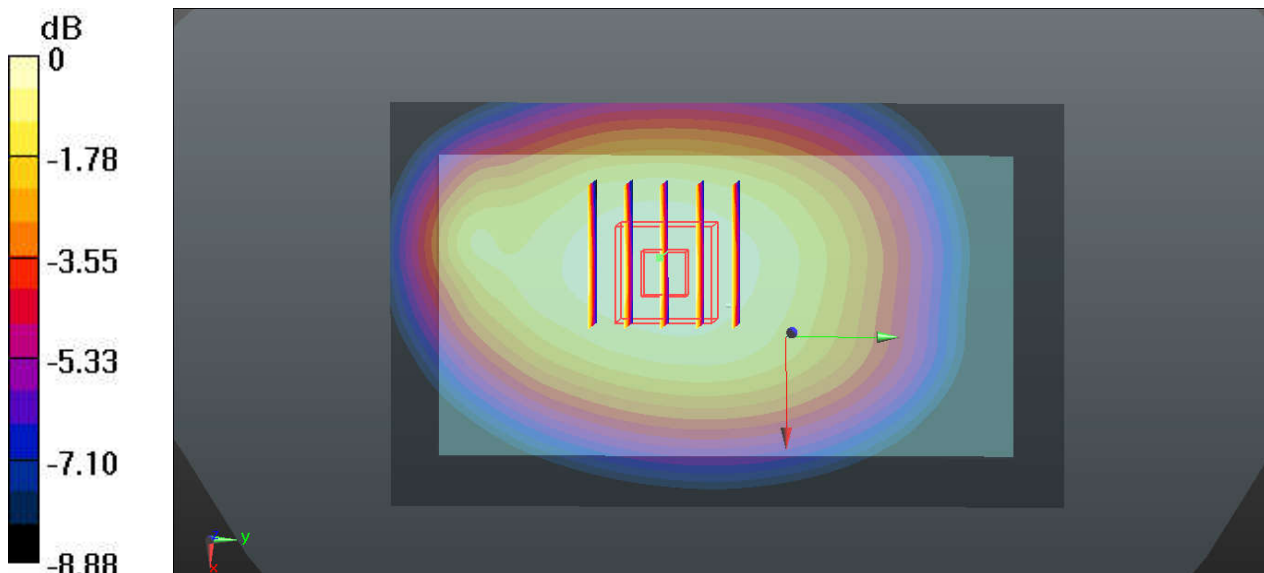

0 dB = 0.588 W/kg

## 12\_WCDMA II\_RMC 12.2Kbps\_Back\_10mm\_Ch9538

Communication System: UID 0, UMTS (0); Frequency: 1907.6 MHz; Duty Cycle: 1:1  
Medium: MSL\_1900\_170411 Medium parameters used:  $f = 1908$  MHz;  $\sigma = 1.554$  S/m;  $\epsilon_r = 53.517$ ;  
 $\rho = 1000$  kg/m<sup>3</sup>  
Ambient Temperature : 23.3 °C; Liquid Temperature : 22.6 °C

### DASY5 Configuration:

- Probe: EX3DV4 - SN3911; ConvF(8.17, 8.17, 8.17); Calibrated: 2016.09.29;
- Sensor-Surface: 2mm (Mechanical Surface Detection)
- Electronics: DAE4 Sn1338; Calibrated: 2016.11.22
- Phantom: SAM (Front) with CRP v5.0; Type: QD000P40CD; Serial: TP:1795
- Measurement SW: DASY52, Version 52.8 (8); SEMCAD X Version 14.6.10 (7331)

**Ch9538/Area Scan (61x101x1):** Interpolated grid: dx=15mm, dy=15mm  
Maximum value of SAR (interpolated) = 0.928 W/kg

**Ch9538/Zoom Scan (5x5x7)/Cube 0:** Measurement grid: dx=8mm, dy=8mm, dz=5mm  
Reference Value = 1.176 V/m; Power Drift = 0.01 dB  
Peak SAR (extrapolated) = 1.08 W/kg  
**SAR(1 g) = 0.647 W/kg; SAR(10 g) = 0.354 W/kg**  
Maximum value of SAR (measured) = 0.888 W/kg

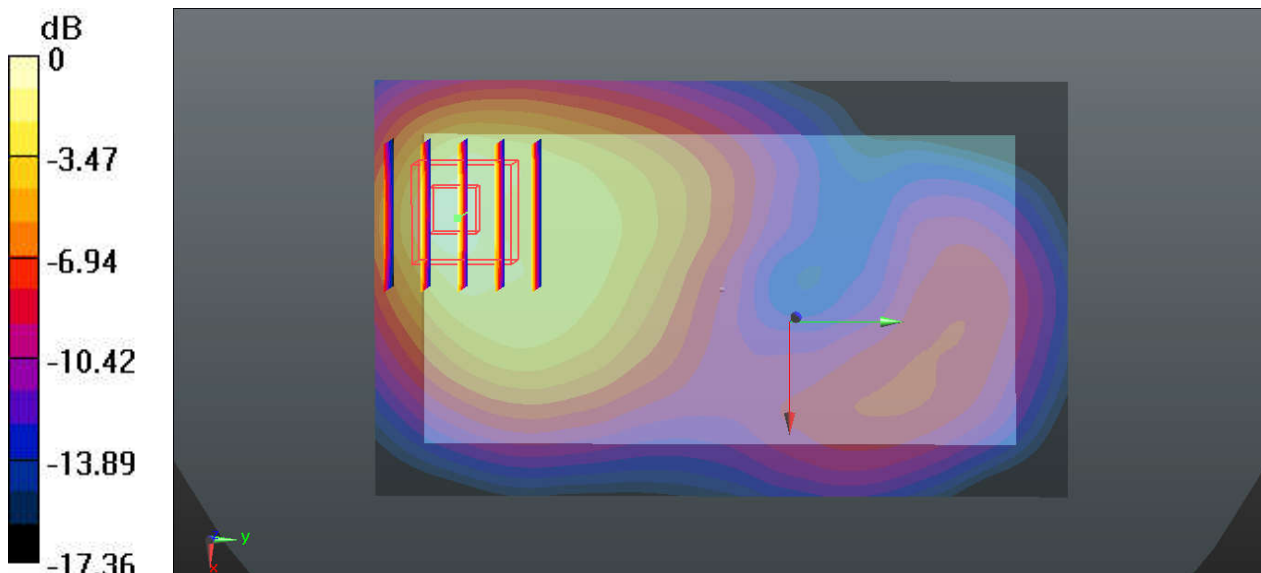

0 dB = 0.928 W/kg

### 13\_LTE Band 28\_20M\_QPSK\_1RB\_99Offset\_Back\_10mm\_Ch27435

Communication System: UID 0, LTE (0); Frequency: 725.5 MHz; Duty Cycle: 1:1  
Medium: MSL\_750\_170411 Medium parameters used:  $f = 725.5$  MHz;  $\sigma = 0.948$  S/m;  $\epsilon_r = 54.526$ ;  
 $\rho = 1000$  kg/m<sup>3</sup>  
Ambient Temperature : 23.4 °C; Liquid Temperature : 22.7 °C

#### DASY5 Configuration:

- Probe: EX3DV4 - SN3911; ConvF(10.43, 10.43, 10.43); Calibrated: 2016.09.29;
- Sensor-Surface: 2mm (Mechanical Surface Detection)
- Electronics: DAE4 Sn1338; Calibrated: 2016.11.22
- Phantom: SAM (Front) with CRP v5.0; Type: QD000P40CD; Serial: TP:1795
- Measurement SW: DASY52, Version 52.8 (8); SEMCAD X Version 14.6.10 (7331)

**Ch27435/Area Scan (61x101x1):** Interpolated grid: dx=15mm, dy=15mm  
Maximum value of SAR (interpolated) = 0.171 W/kg

**Ch27435/Zoom Scan (5x5x7)/Cube 0:** Measurement grid: dx=8mm, dy=8mm, dz=5mm  
Reference Value = 0.2180 V/m; Power Drift = 0.05 dB  
Peak SAR (extrapolated) = 0.183 W/kg  
**SAR(1 g) = 0.129 W/kg; SAR(10 g) = 0.089 W/kg**  
Maximum value of SAR (measured) = 0.160 W/kg

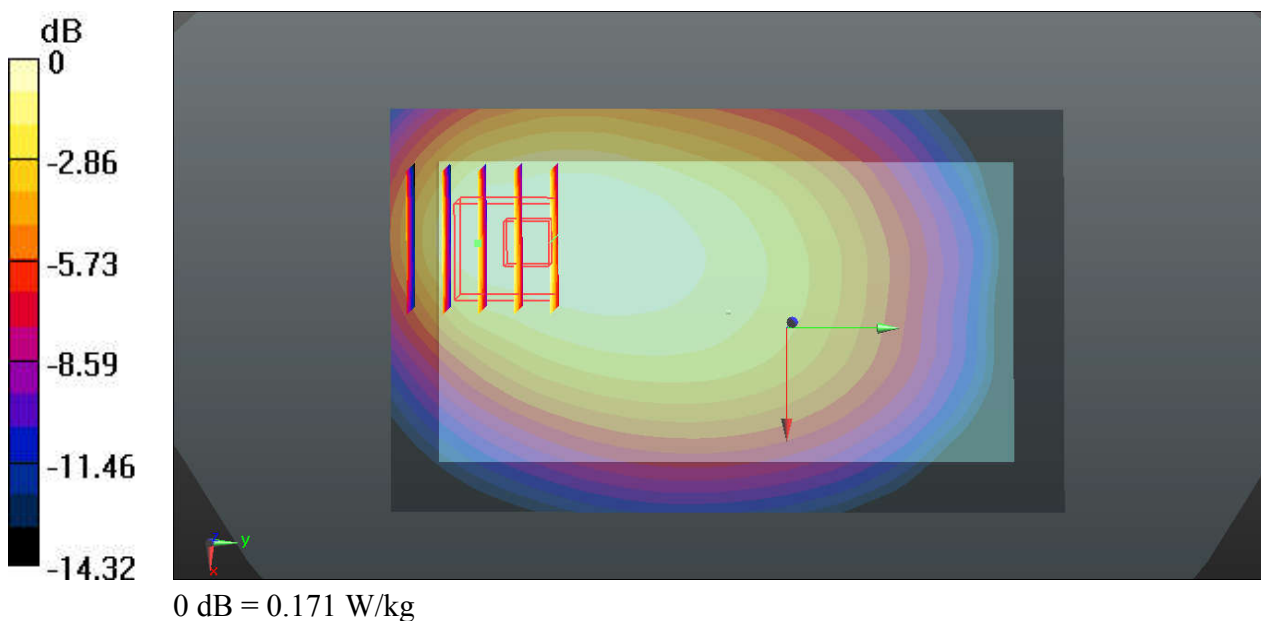

### 14\_LTE Band 4\_20M\_QPSK\_1RB\_0Offset\_Back\_10mm\_Ch20175

Communication System: UID 0, LTE (0); Frequency: 1732.5 MHz; Duty Cycle: 1:1  
 Medium: MSL\_1800\_170411 Medium parameters used:  $f = 1732.5$  MHz;  $\sigma = 1.493$  S/m;  $\epsilon_r = 55.302$ ;  $\rho = 1000$  kg/m<sup>3</sup>  
 Ambient Temperature : 23.4 °C; Liquid Temperature : 22.8 °C

**DASY5 Configuration:**

- Probe: EX3DV4 - SN3911; ConvF(8.46, 8.46, 8.46); Calibrated: 2016.09.29;
- Sensor-Surface: 2mm (Mechanical Surface Detection)
- Electronics: DAE4 Sn1338; Calibrated: 2016.11.22
- Phantom: SAM (Front) with CRP v5.0; Type: QD000P40CD; Serial: TP:1795
- Measurement SW: DASY52, Version 52.8 (8); SEMCAD X Version 14.6.10 (7331)

**Ch20175/Area Scan (61x101x1):** Interpolated grid: dx=15mm, dy=15mm  
 Maximum value of SAR (interpolated) = 1.17 W/kg

**Ch20175/Zoom Scan (5x5x7)/Cube 0:** Measurement grid: dx=8mm, dy=8mm, dz=5mm  
 Reference Value = 1.918 V/m; Power Drift = 0.03 dB  
 Peak SAR (extrapolated) = 1.35 W/kg  
**SAR(1 g) = 0.825 W/kg; SAR(10 g) = 0.493 W/kg**  
 Maximum value of SAR (measured) = 1.09 W/kg

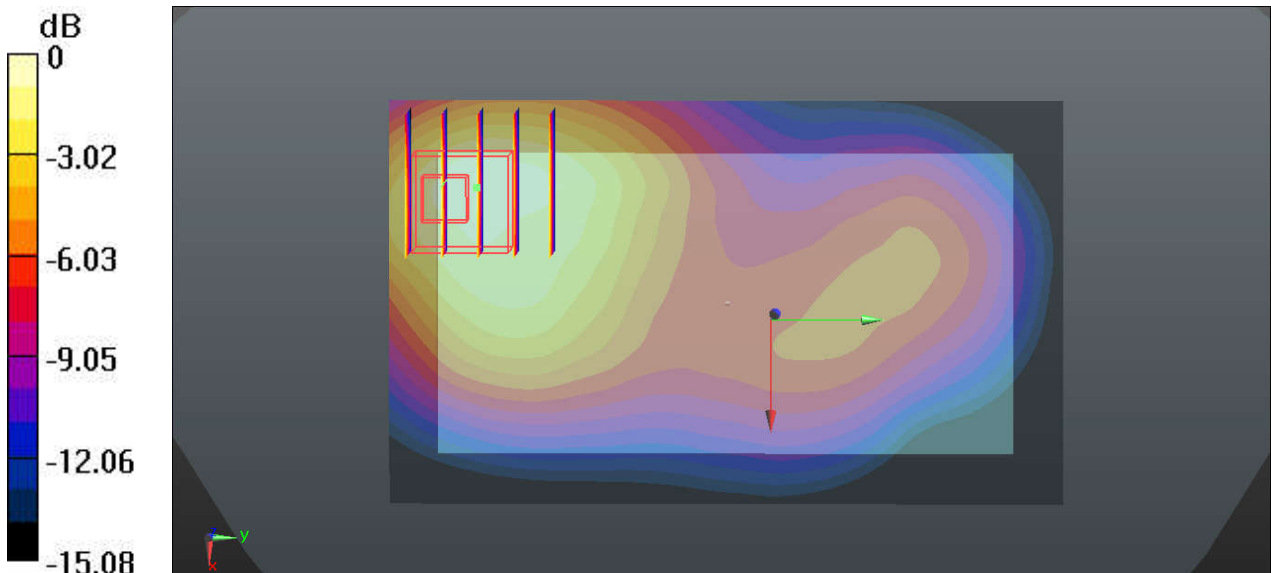

0 dB = 1.17 W/kg

### 15\_LTE Band 7\_20M\_QPSK\_1RB\_0Offset\_Back\_10mm\_Ch21350

Communication System: UID 0, LTE (0); Frequency: 2560 MHz; Duty Cycle: 1:1  
Medium: MSL\_2600\_170412 Medium parameters used:  $f = 2560$  MHz;  $\sigma = 2.149$  S/m;  $\epsilon_r = 52.782$ ;  
 $\rho = 1000$  kg/m<sup>3</sup>  
Ambient Temperature : 23.4 °C; Liquid Temperature : 22.7 °C

#### DASY5 Configuration:

- Probe: EX3DV4 - SN3911; ConvF(7.38, 7.38, 7.38); Calibrated: 2016.09.29;
- Sensor-Surface: 2mm (Mechanical Surface Detection)
- Electronics: DAE4 Sn1338; Calibrated: 2016.11.22
- Phantom: SAM (Front) with CRP v5.0; Type: QD000P40CD; Serial: TP:1795
- Measurement SW: DASY52, Version 52.8 (8); SEMCAD X Version 14.6.10 (7331)

**Ch21350/Area Scan (81x131x1):** Interpolated grid: dx=12mm, dy=12mm  
Maximum value of SAR (interpolated) = 0.260 W/kg

**Ch21350/Zoom Scan (7x7x7)/Cube 0:** Measurement grid: dx=5mm, dy=5mm, dz=5mm  
Reference Value = 0 V/m; Power Drift = 0.05 dB  
Peak SAR (extrapolated) = 0.354 W/kg  
**SAR(1 g) = 0.156 W/kg; SAR(10 g) = 0.063 W/kg**  
Maximum value of SAR (measured) = 0.245 W/kg

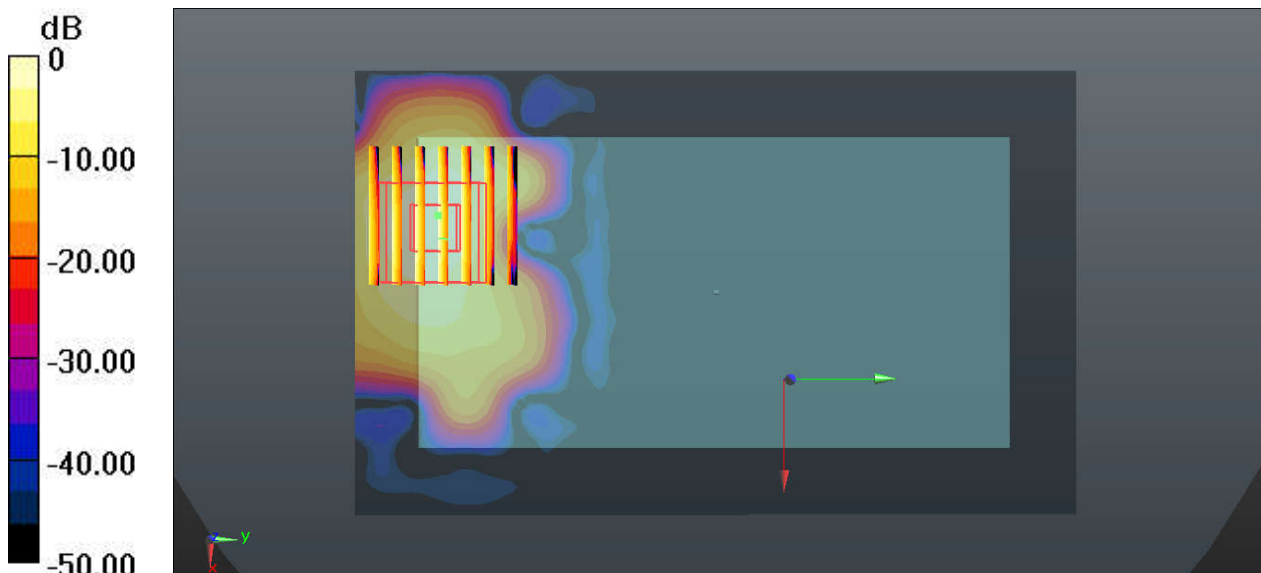

0 dB = 0.245 W/kg

### 16\_WLAN2.4GHz\_802.11b 1Mbps\_Back\_10mm\_Ch1

Communication System: UID 0, WIFI (0); Frequency: 2412 MHz; Duty Cycle: 1:1.003  
Medium: MSL\_2450\_170413 Medium parameters used:  $f = 2412$  MHz;  $\sigma = 1.906$  S/m;  $\epsilon_r = 54.182$ ;  
 $\rho = 1000$  kg/m<sup>3</sup>  
Ambient Temperature : 23.5 °C; Liquid Temperature : 22.8 °C

#### DASY5 Configuration:

- Probe: EX3DV4 - SN3911; ConvF(7.66, 7.66, 7.66); Calibrated: 2016.09.29;
- Sensor-Surface: 2mm (Mechanical Surface Detection)
- Electronics: DAE4 Sn1338; Calibrated: 2016.11.22
- Phantom: SAM (Front) with CRP v5.0; Type: QD000P40CD; Serial: TP:1795
- Measurement SW: DASY52, Version 52.8 (8); SEMCAD X Version 14.6.10 (7331)

**Ch1/Area Scan (81x131x1):** Interpolated grid: dx=12mm, dy=12mm  
Maximum value of SAR (interpolated) = 0.238 W/kg

**Ch1/Zoom Scan (7x7x7)/Cube 0:** Measurement grid: dx=5mm, dy=5mm, dz=5mm  
Reference Value = 0.5490 V/m; Power Drift = 0.16 dB  
Peak SAR (extrapolated) = 0.336 W/kg  
**SAR(1 g) = 0.154 W/kg; SAR(10 g) = 0.073 W/kg**  
Maximum value of SAR (measured) = 0.235 W/kg

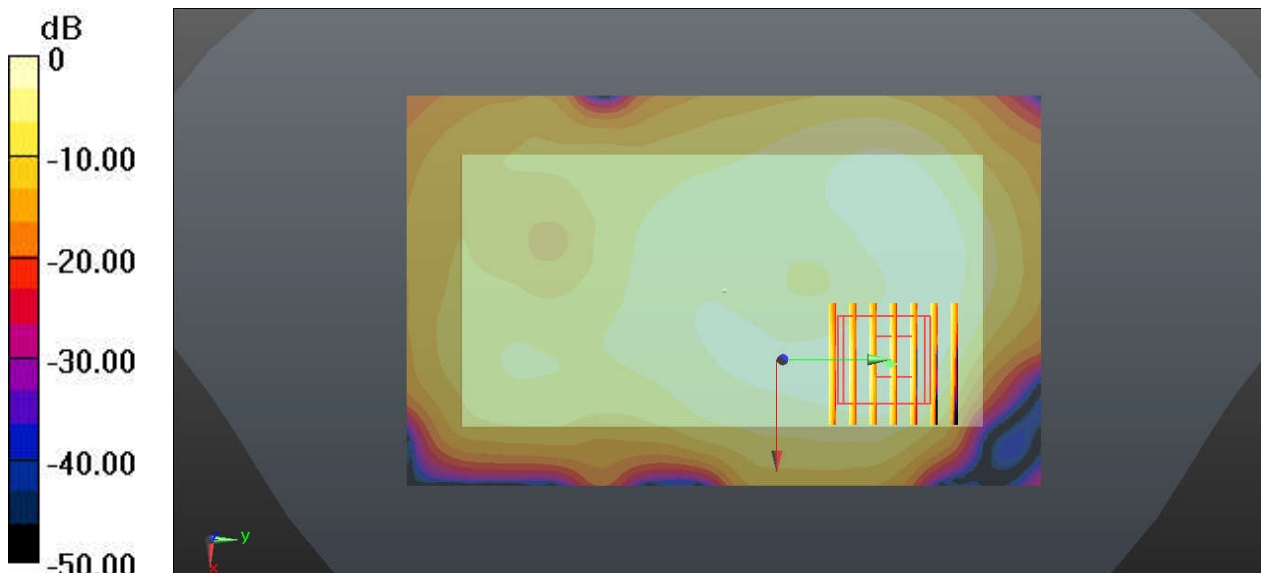

### 17\_GSM850\_GPRS(4 Tx slots)\_Back\_10mm\_Ch251

Communication System: UID 0, GPRS/EDGE12 (0); Frequency: 848.8 MHz; Duty Cycle: 1:2.08  
Medium: MSL\_835\_170411 Medium parameters used:  $f = 849$  MHz;  $\sigma = 1.01$  S/m;  $\epsilon_r = 54.249$ ;  $\rho = 1000$  kg/m<sup>3</sup>  
Ambient Temperature : 23.4 °C; Liquid Temperature : 22.5 °C

#### DASY5 Configuration:

- Probe: EX3DV4 - SN3911; ConvF(10.19, 10.19, 10.19); Calibrated: 2016.09.29;
- Sensor-Surface: 2mm (Mechanical Surface Detection)
- Electronics: DAE4 Sn1338; Calibrated: 2016.11.22
- Phantom: SAM (Front) with CRP v5.0; Type: QD000P40CD; Serial: TP:1795
- Measurement SW: DASY52, Version 52.8 (8); SEMCAD X Version 14.6.10 (7331)

**Ch251/Area Scan (61x101x1):** Interpolated grid: dx=15mm, dy=15mm  
Maximum value of SAR (interpolated) = 1.02 W/kg

**Ch251/Zoom Scan (5x5x7)/Cube 0:** Measurement grid: dx=8mm, dy=8mm, dz=5mm  
Reference Value = 3.101 V/m; Power Drift = 0.05 dB  
Peak SAR (extrapolated) = 1.11 W/kg  
**SAR(1 g) = 0.892 W/kg; SAR(10 g) = 0.685 W/kg**  
Maximum value of SAR (measured) = 1.02 W/kg

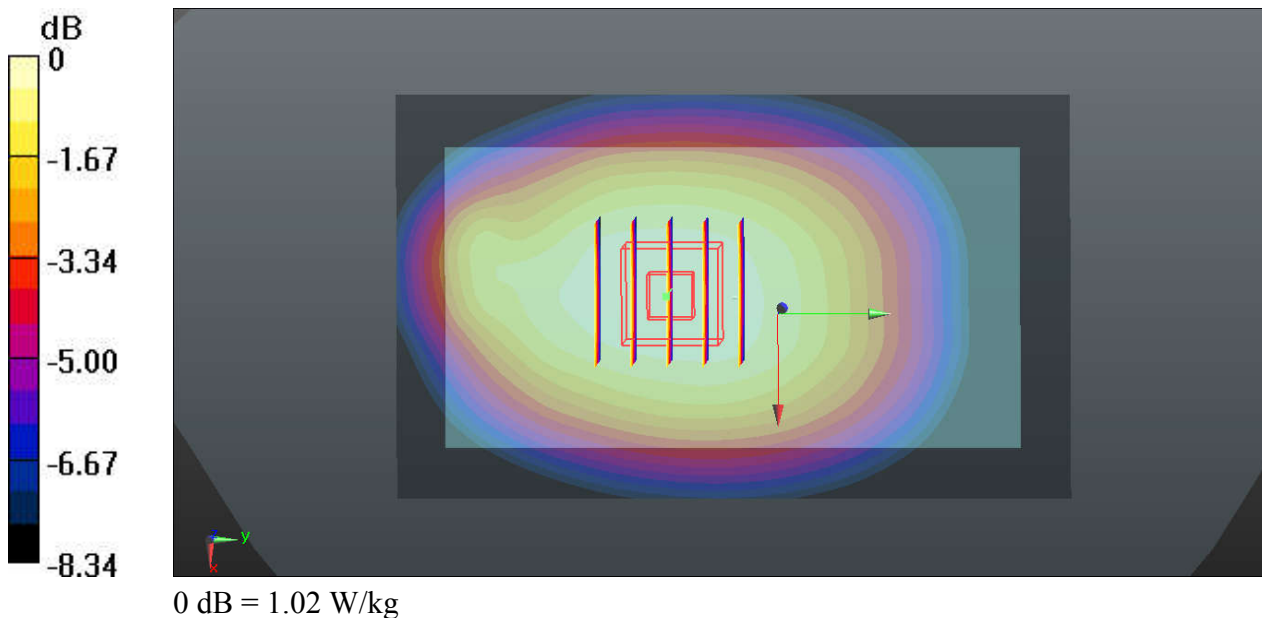



### 18\_GSM1900\_GPRS(4 Tx slots)\_Front\_10mm\_Ch512

Communication System: UID 0, GPRS/EDGE12 (0); Frequency: 1850.2 MHz; Duty Cycle: 1:2.08  
Medium: MSL\_1900\_170411 Medium parameters used:  $f = 1850.2$  MHz;  $\sigma = 1.487$  S/m;  $\epsilon_r = 53.637$ ;  $\rho = 1000$  kg/m<sup>3</sup>  
Ambient Temperature : 23.3 °C; Liquid Temperature : 22.6 °C

#### DASY5 Configuration:

- Probe: EX3DV4 - SN3911; ConvF(8.17, 8.17, 8.17); Calibrated: 2016.09.29;
- Sensor-Surface: 2mm (Mechanical Surface Detection)
- Electronics: DAE4 Sn1338; Calibrated: 2016.11.22
- Phantom: SAM (Front) with CRP v5.0; Type: QD000P40CD; Serial: TP:1795
- Measurement SW: DASY52, Version 52.8 (8); SEMCAD X Version 14.6.10 (7331)

**Ch512/Area Scan (61x101x1):** Interpolated grid: dx=15mm, dy=15mm  
Maximum value of SAR (interpolated) = 0.675 W/kg

**Ch512/Zoom Scan (5x5x7)/Cube 0:** Measurement grid: dx=8mm, dy=8mm, dz=5mm  
Reference Value = 0.2120 V/m; Power Drift = 0.11 dB  
Peak SAR (extrapolated) = 0.981 W/kg  
**SAR(1 g) = 0.597 W/kg; SAR(10 g) = 0.322 W/kg**  
Maximum value of SAR (measured) = 0.777 W/kg

