



FCC Test Report

APPLICANT : Planet Avvio LLC
EQUIPMENT : Mobile phone
BRAND NAME : Avvio
MODEL NAME : A50
MARKETING NAME : AVVIO A50
FCC ID : 2ALTAP50X
STANDARD : FCC 47 CFR FCC Part 15 Subpart B
CLASSIFICATION : Certification

The product was received on Aug. 11, 2017 and testing was completed on Sep. 01, 2017. We, Sporton International (Shenzhen) Inc., would like to declare that the tested sample has been evaluated in accordance with the test procedures given in ANSI C63.4-2014 and has been in compliance with the applicable technical standards.

The test results in this report apply exclusively to the tested model / sample. Without written approval of Sporton International (Shenzhen) Inc., the test report shall not be reproduced except in full.



Approved by: Eric Shih / Manager

Sporton International (Shenzhen) Inc.
1/F, 2/F, Bldg 5, Shiling Industrial Zone, Xinwei Village, Xili, Nanshan Shenzhen City
Guangdong Province 518055 China



TABLE OF CONTENTS

REVISION HISTORY.....3

SUMMARY OF TEST RESULT4

1. GENERAL DESCRIPTION5

 1.1. Applicant.....5

 1.2. Manufacturer5

 1.3. Product Feature of Equipment Under Test5

 1.4. Product Specification of Equipment Under Test6

 1.5. Modification of EUT6

 1.6. Test Location7

 1.7. Applicable Standards7

2. TEST CONFIGURATION OF EQUIPMENT UNDER TEST.....8

 2.1. Test Mode8

 2.2. Connection Diagram of Test System9

 2.3. Support Unit used in test configuration and system.....11

 2.4. EUT Operation Test Setup12

5. TEST RESULT.....13

 5.1. Test of AC Conducted Emission Measurement13

 5.2. Test of Radiated Emission Measurement20

6. LIST OF MEASURING EQUIPMENT26

7. UNCERTAINTY OF EVALUATION27

APPENDIX A. SETUP PHOTOGRAPHS



REVISION HISTORY

REPORT NO.	VERSION	DESCRIPTION	ISSUED DATE
FC781104	Rev. 01	Initial issue of report	Sep. 18, 2017



SUMMARY OF TEST RESULT

Report Section	FCC Rule	Description	Limit	Result	Remark
5.1	15.107	AC Conducted Emission	< 15.107 limits	PASS	Under limit 7.20 dB at 0.42 MHz
5.2	15.109	Radiated Emission	< 15.109 limits	PASS	Under limit 3.71 dB at 79.47 MHz for Quasi-Peak



1. General Description

1.1. Applicant

Planet Avvio LLC
9725 NW 117th Ave., Medley, FL 33178, United States

1.2. Manufacturer

Heng Da Chuang Xin Technology Limited
Rm 1301 Block D, Tianan Cloud Pack Building 3th, Bantian Street, Longgang District, Shenzhen City, Guangdong Province, P. R. C. 518000

1.3. Product Feature of Equipment Under Test

Product Feature	
Equipment	Mobile phone
Brand Name	Avvio
Model Name	A50
Marketing Name	Avvio A50
FCC ID	2ALTAP50X
EUT supports Radios application	GSM/GPRS/EGPRS/WCDMA/HSPA/HSPA+/DC-HSDPA/LTE/ WLAN 2.4GHz 802.11b/g/n HT20/HT40 Bluetooth v3.0 + EDR/Bluetooth v4.0 LE
HW Version	B939-30H-M
SW Version	B939_30H_HF526_HD_V0.1_20170617
EUT Stage	Production Unit

Remark: The above EUT's information was declared by manufacturer. Please refer to the specifications or user's manual for more detailed description.

1.4. Product Specification of Equipment Under Test

Standards-related Product Specification	
Tx Frequency	GSM850: 824.2 MHz ~ 848.8 MHz GSM1900: 1850.2 MHz ~ 1909.8MHz WCDMA Band V: 826.4 MHz ~ 846.6 MHz WCDMA Band II: 1852.4 MHz ~ 1907.6 MHz LTE Band 2 : 1850.7 MHz ~ 1909.3 MHz LTE Band 4 : 1710.7 MHz ~ 1754.3 MHz LTE Band 7 : 2502.5 MHz ~ 2567.5 MHz 802.11b/g/n: 2412 MHz ~ 2462 MHz Bluetooth: 2402 MHz ~ 2480 MHz
Rx Frequency	GSM850: 869.2 MHz ~ 893.8 MHz GSM1900: 1930.2 MHz ~ 1989.8 MHz WCDMA Band V: 871.4 MHz ~ 891.6 MHz WCDMA Band II: 1932.4 MHz ~ 1987.6 MHz LTE Band 2 : 1930.7 MHz ~ 1989.3 MHz LTE Band 4 : 2110.7 MHz ~ 2154.3 MHz LTE Band 7 : 2622.5 MHz ~ 2687.5 MHz 802.11b/g/n: 2412 MHz ~ 2462 MHz Bluetooth: 2402 MHz ~ 2480 MHz GPS : 1.57542 GHz FM : 87.5 MHz ~ 108 MHz
Antenna Type	WWAN : Monopole Antenna WLAN : FPC Antenna Bluetooth : FPC Antenna GPS : FPC Antenna FM : External Headset Antenna
Type of Modulation	GSM: GMSK GPRS: GMSK EDGE(MCS 0-4): GMSK / (MCS 5-9): 8PSK WCDMA : BPSK (Uplink) HSDPA/DC-HSDPA : QPSK (Uplink) HSUPA : QPSK (Uplink) HSPA+: 16QAM DC-HSDPA: 64QAM LTE: QPSK / 16QAM 802.11b : DSSS (DBPSK / DQPSK / CCK) 802.11g/n : OFDM (BPSK / QPSK / 16QAM / 64QAM) Bluetooth LE : GFSK Bluetooth (1Mbps) : GFSK Bluetooth (2Mbps) : $\pi/4$ -DQPSK Bluetooth (3Mbps) : 8-DPSK GPS : BPSK FM : FM

1.5. Modification of EUT

No modifications are made to the EUT during all test items.



1.6. Test Location

Sporton Lab is accredited to ISO 17025 by National Voluntary Laboratory Accreditation Program (NVLAP code: 600156-0) and the FCC designation No are CN5018 and CN5019.

Test Site	Sporton International (Shenzhen) Inc.	
Test Site Location	1/F, 2/F, Bldg 5, Shiling Industrial Zone, Xinwei Village, Xili, Nanshan Shenzhen City Guangdong Province 518055 China TEL: +86-755-8637-9589 FAX: +86-755-8637-9595	
Test Site No.	Sporton Site No.	FCC Test Firm Registration No.
	CO01-SZ	251365

Test Site	Sporton International (Shenzhen) Inc.	
Test Site Location	No. 3 Bldg the third floor of south, Shahe River west, Fengzeyuan Warehouse, Nanshan District Shenzhen City Guangdong Province 518055 China TEL: +86-755-3320-2398	
Test Site No.	Sporton Site No.	FCC Test Firm Registration No.
	03CH01-SZ	577730

Note: The test site complies with ANSI C63.4 2014 requirement.

1.7. Applicable Standards

According to the specifications of the manufacturer, the EUT must comply with the requirements of the following standards:

- FCC 47 CFR FCC Part 15 Subpart B
- ANSI C63.4-2014

Remark: All test items were verified and recorded according to the standards and without any deviation during the test.



2. Test Configuration of Equipment Under Test

2.1. Test Mode

The EUT has been associated with peripherals pursuant to ANSI C63.4-2014 and configuration operated in a manner tended to maximize its emission characteristics in a typical application.

Frequency range investigated: conduction (150 kHz to 30 MHz), radiation (30MHz to the 5th harmonic of the highest fundamental frequency or to 40 GHz, whichever is lower).

Test Items	Function Type
AC Conducted Emission	Mode 1 : GSM850 Idle + Bluetooth Idle + WLAN Idle(2.4G) + USB Cable (Charging from Adapter) + Earphone + Camera(Rear) + SD Card(load) with SIM1<Fig.1>
	Mode 2 : GSM1900 Idle + Bluetooth Idle + WLAN Idle(2.4G) + USB Cable (Charging from Adapter) + Earphone + Camera(Front) + SD Card(load) with SIM2<Fig.1>
	Mode 3 : WCDMA Band V Idle + Bluetooth Idle + WLAN Idle(2.4G) + USB Cable (Charging from Adapter) + Earphone + MPEG4 + SD Card(load) with SIM1<Fig.1>
	Mode 4 : LTE Band 2 Idle + Bluetooth Idle + WLAN Idle(2.4G) + USB Cable (Charging from Adapter) + Earphone + SD Card(load) + GPS On with SIM2<Fig.2>
	Mode 5 : LTE Band 4 Idle + Bluetooth Idle + WLAN Idle(2.4G) + USB Cable (Data Link with Notebook) + Earphone + SD Card(Link) + Camera(Front) with SIM1<Fig.3>
Radiated Emissions	Mode 1 : GSM850 Idle + Bluetooth Idle + WLAN Idle(2.4G) + USB Cable (Charging from Adapter) + Earphone + Camera(Rear) + SD Card(load) with SIM1 <Fig.1>
	Mode 2 : GSM1900 Idle + Bluetooth Idle + WLAN Idle(2.4G) + USB Cable (Charging from Adapter) + Earphone + Camera(Front) + SD Card(load) with SIM2<Fig.1>
	Mode 3 : WCDMA Band V Idle + Bluetooth Idle + WLAN Idle(2.4G) + USB Cable (Charging from Adapter) + Earphone + MPEG4 + SD Card(load) with SIM1<Fig.1>
	Mode 4 : LTE Band 2 Idle + Bluetooth Idle + WLAN Idle(2.4G) + USB Cable (Charging from Adapter) + Earphone + SD Card(load) + GPS On with SIM2<Fig.2>
	Mode 5 : LTE Band 4 Idle + Bluetooth Idle + WLAN Idle(2.4G) + USB Cable (Data Link with Notebook) + Earphone + SD Card(Link) + MPEG4 with SIM1<Fig.3>
Remark:	
<ol style="list-style-type: none"> 1. The worst case of AC is mode 2; and the USB Link mode is mode 5, the test data of these two modes were reported. 2. The worst case of RE < 1G is mode 3; and the USB Link mode is mode 5, the test data of these two modes were reported. 3. Data Link with Notebook means data application transferred mode between EUT and Notebook. 	

2.2. Connection Diagram of Test System

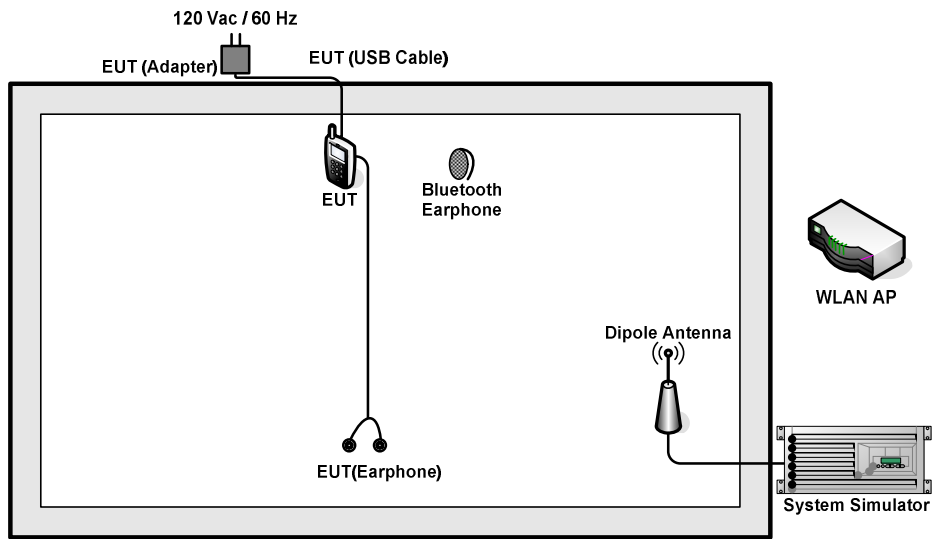

<Fig.1>

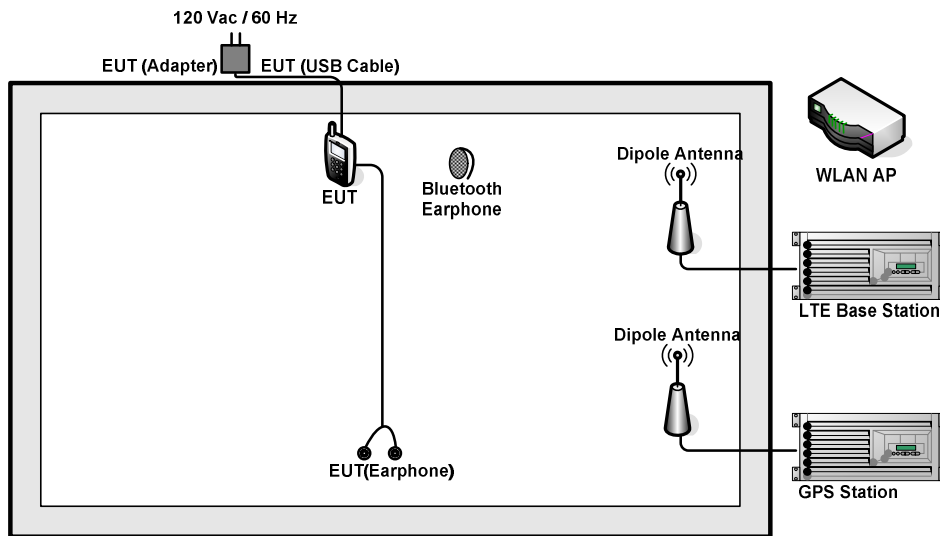

<Fig.2>

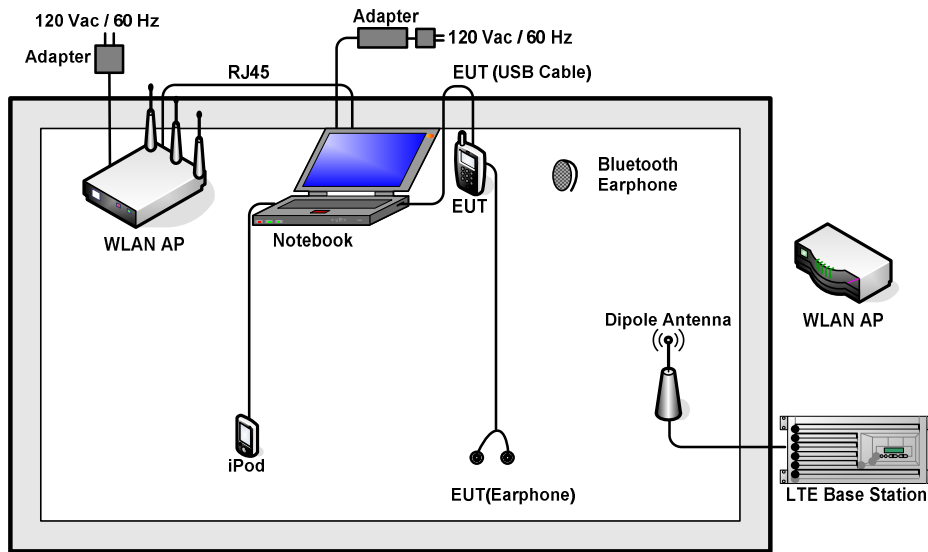

<Fig.3>



2.3. Support Unit used in test configuration and system

Item	Equipment	Trade Name	Model Name	FCC ID	Data Cable	Power Cord
1.	System Simulator	R&S	CMU 200	N/A	N/A	Unshielded, 1.8 m
2.	LTE Base Station	Anritsu	MT8820C	N/A	N/A	Unshielded, 1.8m
3.	GPS Station	ADIVIE	MP9000	N/A	N/A	Unshielded, 1.8m
4.	WLAN AP	ASUS	RT-AC66U	MSQ-RTAC66U	N/A	Unshielded, 1.8m
5.	WLAN AP	Dlink	DIR-820L	KA2IR820LA1	N/A	WLAN AP
6.	Bluetooth Earphone	Samsung	HS3000	A3LHS3000	N/A	N/A
7.	Bluetooth Earphone	Samsung	EO-MG900	PYAHS-107W	N/A	N/A
8.	NOTE BOOK	Lenovo	E540	FCC DoC	N/A	AC I/P : Unshielded, 1.2m DC O/P : Shielded, 1.8m
9.	iPod nano 8GB	Apple	MC690ZP/A	N/A	Shielded, 1.2m	iPod nano 8GB
10.	iPod	Apple	MC525 ZP/A	DoC	Shielded, 1.0m	N/A
11.	SD Card	Kingston	MicroSD HC	FCC DoC	N/A	N/A
12.	SD Card	SanDisk	MicroSD HC	FCC DoC	N/A	SD Card



2.4. EUT Operation Test Setup

The EUT was in GSM or WCDMA or LTE idle mode during the testing. The EUT was synchronized to the BCCH, and is in continuous receiving mode by setting system simulator's paging reorganization.

At the same time, the EUT was attached to the Bluetooth earphone or WLAN AP, and the following programs installed in the EUT were programmed during the test.

1. Data application is transferred between Notebook and EUT via USB cable.
2. Turn on GPS function to make the EUT receive continuous signals from GPS station.
3. Execute "Video player" to play MPEG4 files.
4. Turn on camera to capture images.

5. Test Result

5.1. Test of AC Conducted Emission Measurement

3.1.1 Limits of AC Conducted Emission

For equipment that is designed to be connected to the public utility (AC) power line, the radio frequency voltage that is conducted back onto the AC power line on any frequency or frequencies within the band 150 kHz to 30 MHz shall not exceed the limits in the following table.

Frequency of emission (MHz)	Conducted limit (dBuV)	
	Quasi-peak	Average
0.15-0.5	66 to 56*	56 to 46*
0.5-5	56	46
5-30	60	50

*Decreases with the logarithm of the frequency.

3.1.2 Measuring Instruments

The measuring equipment is listed in the section 4 of this test report.

3.1.3 Test Procedure

1. The EUT was placed 0.4 meter from the conducting wall of the shielding room was kept at least 80 centimeters from any other grounded conducting surface.
2. Connect EUT to the power mains through a line impedance stabilization network (LISN).
3. All the support units are connecting to the other LISN.
4. The LISN provides 50 ohm coupling impedance for the measuring instrument.
5. The FCC states that a 50 ohm, 50 microhenry LISN should be used.
6. Both sides of AC line were checked for maximum conducted interference.
7. The frequency range from 150 kHz to 30 MHz was searched.
8. Set the test-receiver system to Peak Detect Function and specified bandwidth (IF Bandwidth = 9kHz) with Maximum Hold Mode. Then measurement is also conducted by Average Detector and Quasi-Peak Detector Function respectively.

3.1.4 Test Setup





3.1.5 Test Result of AC Conducted Emission

Test Mode :	Mode 2	Temperature :	22~25°C
Test Engineer :	Peng Wang	Relative Humidity :	50~55%
Test Voltage :	120Vac / 60Hz	Phase :	Line
Function Type :	GSM1900 Idle + Bluetooth Idle + WLAN Idle(2.4G) + USB Cable (Charging from Adapter) + Earphone + Camera(Front) + SD Card(load) with SIM2		

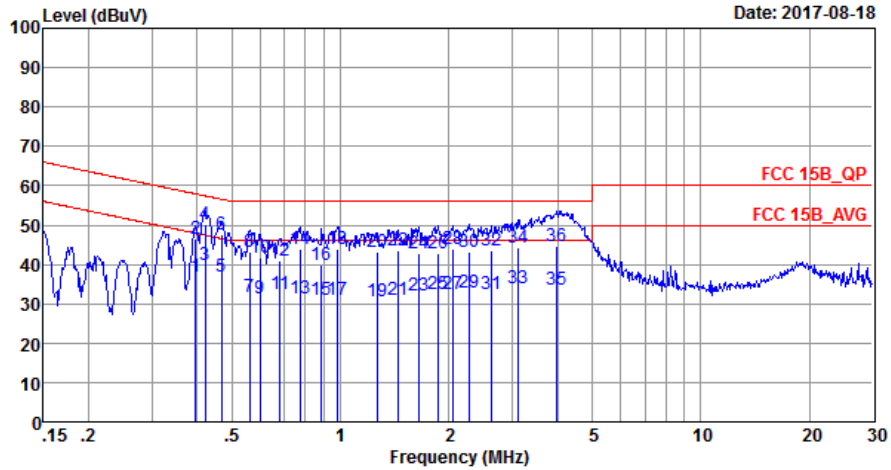

Site : C001-SZ
 Condition: FCC 15B_QP LISN_20170301_L LINE
 Project : (FC) 781104
 Mode : mode 2
 Sample : #3

	Freq	Level	Over Limit	Limit Line	Read Level	LISN Factor	Cable Loss	Remark
	MHz	dBuV	dB	dBuV	dBuV	dB	dB	
1	0.40	36.92	-11.03	47.95	26.70	0.03	10.19	Average
2	0.40	46.52	-11.43	57.95	36.30	0.03	10.19	QP
3	0.42	39.82	-7.60	47.42	29.60	0.03	10.19	Average
4 *	0.42	50.22	-7.20	57.42	40.00	0.03	10.19	QP
5	0.47	37.01	-9.53	46.54	26.81	0.02	10.18	Average
6	0.47	47.71	-8.83	56.54	37.51	0.02	10.18	QP
7	0.56	31.70	-14.30	46.00	21.50	0.02	10.18	Average
8	0.56	43.20	-12.80	56.00	33.00	0.02	10.18	QP
9	0.60	31.49	-14.51	46.00	21.30	0.02	10.17	Average
10	0.60	41.59	-14.41	56.00	31.40	0.02	10.17	QP
11	0.68	32.49	-13.51	46.00	22.30	0.02	10.17	Average
12	0.68	41.09	-14.91	56.00	30.90	0.02	10.17	QP
13	0.77	31.39	-14.61	46.00	21.20	0.03	10.16	Average
14	0.77	43.99	-12.01	56.00	33.80	0.03	10.16	QP
15	0.88	31.11	-14.89	46.00	20.90	0.05	10.16	Average
16	0.88	39.84	-16.16	56.00	29.63	0.05	10.16	QP
17	0.98	31.02	-14.98	46.00	20.80	0.07	10.15	Average
18	0.98	43.92	-12.08	56.00	33.70	0.07	10.15	QP
19	1.26	30.74	-15.26	46.00	20.51	0.08	10.15	Average
20	1.26	43.14	-12.86	56.00	32.91	0.08	10.15	QP
21	1.44	31.15	-14.85	46.00	20.90	0.09	10.16	Average
22	1.44	43.45	-12.55	56.00	33.20	0.09	10.16	QP
23	1.64	32.26	-13.74	46.00	22.00	0.10	10.16	Average
24	1.64	42.86	-13.14	56.00	32.60	0.10	10.16	QP
25	1.86	32.56	-13.44	46.00	22.29	0.11	10.16	Average
26	1.86	42.96	-13.04	56.00	32.69	0.11	10.16	QP
27	2.04	32.58	-13.42	46.00	22.31	0.11	10.16	Average
28	2.04	43.78	-12.22	56.00	33.51	0.11	10.16	QP
29	2.28	32.70	-13.30	46.00	22.39	0.13	10.18	Average



Test Mode :	Mode 2	Temperature :	22~25°C
Test Engineer :	Peng Wang	Relative Humidity :	50~55%
Test Voltage :	120Vac / 60Hz	Phase :	Line
Function Type :	GSM1900 Idle + Bluetooth Idle + WLAN Idle(2.4G) + USB Cable (Charging from Adapter) + Earphone + Camera(Front) + SD Card(load) with SIM2		

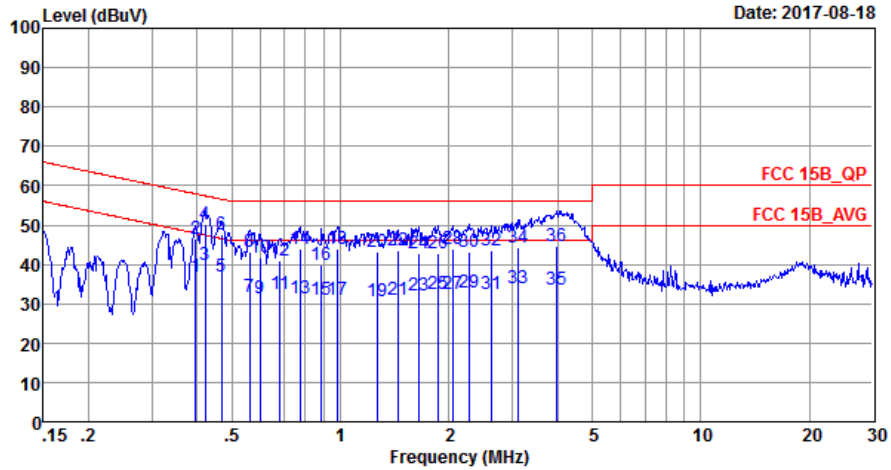

Site : C001-SZ
 Condition: FCC 15B_QP LISN_20170301_L LINE
 Project : (FC) 781104
 Mode : mode 2
 Sample : #3

	Freq	Level	Over Limit	Limit Line	Read Level	LISN Factor	Cable Loss	Remark
	MHz	dBuV	dB	dBuV	dBuV	dB	dB	
30	2.28	43.20	-12.80	56.00	32.89	0.13	10.18	QP
31	2.64	32.34	-13.66	46.00	22.00	0.14	10.20	Average
32	2.64	43.44	-12.56	56.00	33.10	0.14	10.20	QP
33	3.12	33.78	-12.22	46.00	23.40	0.16	10.22	Average
34	3.12	44.38	-11.62	56.00	34.00	0.16	10.22	QP
35	3.99	33.63	-12.37	46.00	23.20	0.18	10.25	Average
36	3.99	44.53	-11.47	56.00	34.10	0.18	10.25	QP



Test Mode :	Mode 2	Temperature :	22~25°C
Test Engineer :	Peng Wang	Relative Humidity :	50~55%
Test Voltage :	120Vac / 60Hz	Phase :	Neutral
Function Type :	GSM1900 Idle + Bluetooth Idle + WLAN Idle(2.4G) + USB Cable (Charging from Adapter) + Earphone + Camera(Front) + SD Card(load) with SIM2		

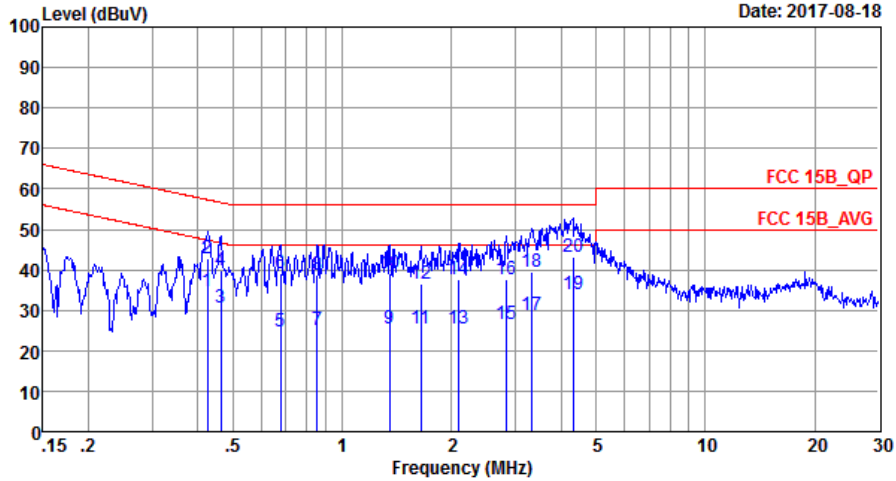

Site : C001-SZ
 Condition: FCC 15B_QP LISN_20170301_N NEUTRAL
 Project : (FC)781104
 Mode : mode 2
 Sample : #3

	Freq	Level	Over Limit	Limit Line	Read Level	LISN Factor	Cable Loss	Remark
	MHz	dBuV	dB	dBuV	dBuV	dB	dB	
1	0.43	34.84	-12.49	47.33	24.63	0.02	10.19	Average
2	0.43	42.71	-14.62	57.33	32.50	0.02	10.19	QP
3	0.46	30.80	-15.83	46.63	20.60	0.02	10.18	Average
4	0.46	40.00	-16.63	56.63	29.80	0.02	10.18	QP
5	0.68	24.79	-21.21	46.00	14.60	0.02	10.17	Average
6	0.68	38.99	-17.01	56.00	28.80	0.02	10.17	QP
7	0.85	25.09	-20.91	46.00	14.89	0.04	10.16	Average
8	0.85	38.69	-17.31	56.00	28.49	0.04	10.16	QP
9	1.35	25.50	-20.50	46.00	15.30	0.05	10.15	Average
10	1.35	39.00	-17.00	56.00	28.80	0.05	10.15	QP
11	1.64	25.51	-20.49	46.00	15.30	0.05	10.16	Average
12	1.64	36.41	-19.59	56.00	26.20	0.05	10.16	QP
13	2.10	25.61	-20.39	46.00	15.39	0.05	10.17	Average
14	2.10	37.61	-18.39	56.00	27.39	0.05	10.17	QP
15	2.84	26.44	-19.56	46.00	16.20	0.03	10.21	Average
16	2.84	37.54	-18.46	56.00	27.30	0.03	10.21	QP
17	3.33	28.66	-17.34	46.00	18.39	0.04	10.23	Average
18	3.33	39.56	-16.44	56.00	29.29	0.04	10.23	QP
19 *	4.31	34.02	-11.98	46.00	23.70	0.06	10.26	Average
20	4.31	43.22	-12.78	56.00	32.90	0.06	10.26	QP



Test Mode :	Mode 5	Temperature :	22~25°C
Test Engineer :	Peng Wang	Relative Humidity :	50~55%
Test Voltage :	120Vac / 60Hz	Phase :	Line
Function Type :	LTE Band 4 Idle + Bluetooth Idle + WLAN Idle(2.4G) + USB Cable (Data Link with Notebook) + Earphone + SD Card(Link) + Camera(Front) with SIM1		

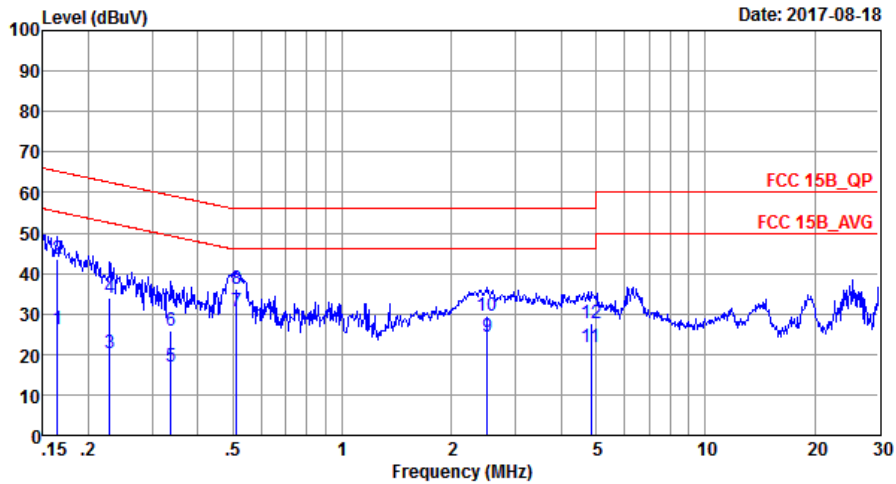

Site : CO01-SZ
 Condition: FCC 15B_QP LISN_20170301_L LINE
 Project : (FC)781104
 Mode : mode 5
 Sample : #3

	Freq	Level	Over Limit	Limit Line	Read Level	LISN Factor	Cable Loss	Remark
	MHz	dBuV	dB	dBuV	dBuV	dB	dB	
1	0.16	26.18	-29.07	55.25	15.80	0.03	10.35	Average
2	0.16	43.38	-21.87	65.25	33.00	0.03	10.35	QP
3	0.23	20.15	-32.33	52.48	9.90	0.03	10.22	Average
4	0.23	33.95	-28.53	62.48	23.70	0.03	10.22	QP
5	0.34	16.94	-32.33	49.27	6.70	0.03	10.21	Average
6	0.34	25.94	-33.33	59.27	15.70	0.03	10.21	QP
7 *	0.51	30.60	-15.40	46.00	20.40	0.02	10.18	Average
8	0.51	36.30	-19.70	56.00	26.10	0.02	10.18	QP
9	2.51	24.53	-21.47	46.00	14.20	0.14	10.19	Average
10	2.51	29.43	-26.57	56.00	19.10	0.14	10.19	QP
11	4.85	21.86	-24.14	46.00	11.40	0.19	10.27	Average
12	4.85	27.66	-28.34	56.00	17.20	0.19	10.27	QP



Test Mode :	Mode 5	Temperature :	22~25°C
Test Engineer :	Peng Wang	Relative Humidity :	50~55%
Test Voltage :	120Vac / 60Hz	Phase :	Neutral
Function Type :	LTE Band 4 Idle + Bluetooth Idle + WLAN Idle(2.4G) + USB Cable (Data Link with Notebook) + Earphone + SD Card(Link) + Camera(Front) with SIM1		

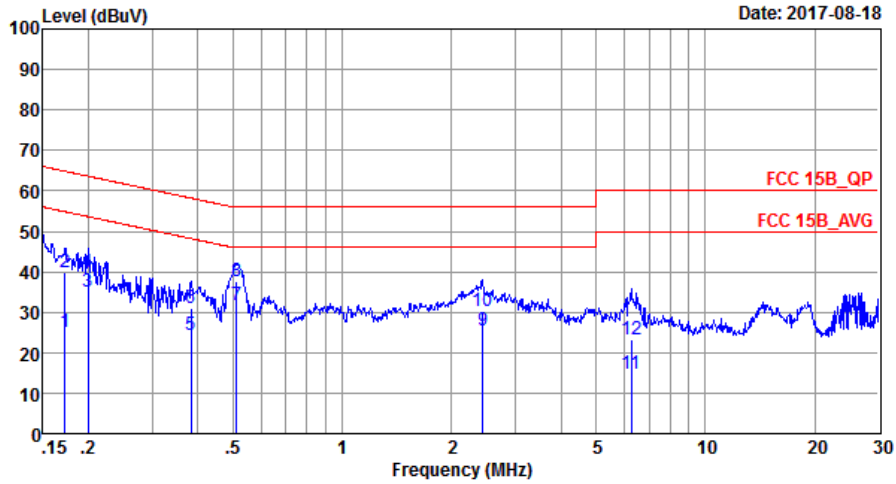

Site : C001-SZ
 Condition: FCC 15B_QP LISN_20170301_N NEUTRAL
 Project : (FC)781104
 Mode : mode 5
 Sample : #3

	Freq	Level	Over	Limit	Read	LISN	Cable	
	MHz	dBuV	Limit	Line	Level	Factor	Loss	Remark
			dB	dBuV	dBuV	dB	dB	
1	0.17	25.25	-29.61	54.86	14.90	0.03	10.32	Average
2	0.17	39.75	-25.11	64.86	29.40	0.03	10.32	QP
3	0.20	35.05	-18.57	53.62	24.80	0.03	10.22	Average
4	0.20	39.95	-23.67	63.62	29.70	0.03	10.22	QP
5	0.38	24.22	-23.99	48.21	14.01	0.02	10.19	Average
6	0.38	31.12	-27.09	58.21	20.91	0.02	10.19	QP
7 *	0.51	31.80	-14.20	46.00	21.60	0.02	10.18	Average
8	0.51	37.60	-18.40	56.00	27.40	0.02	10.18	QP
9	2.43	25.43	-20.57	46.00	15.20	0.04	10.19	Average
10	2.43	30.13	-25.87	56.00	19.90	0.04	10.19	QP
11	6.25	14.58	-35.42	50.00	4.20	0.07	10.31	Average
12	6.25	23.18	-36.82	60.00	12.80	0.07	10.31	QP



5.2. Test of Radiated Emission Measurement

5.2.1. Limit of Radiated Emission

The emissions from an unintentional radiator shall not exceed the field strength levels specified in the following table:

Frequency (MHz)	Field Strength (microvolts/meter)	Measurement Distance (meters)
30 – 88	100	3
88 – 216	150	3
216 - 960	200	3
Above 960	500	3

5.2.2. Measuring Instruments

The measuring equipment is listed in the section 4 of this test report.

5.2.3. Test Procedures

1. The EUT was placed on a turntable with 0.8 meter above ground.
2. The EUT was set 3 meters from the interference receiving antenna, which was mounted on the top of a variable height antenna tower.
3. The table was rotated 360 degrees to determine the position of the highest radiation.
4. The antenna is a Bi-Log antenna and its height is adjusted between one to four meters above ground to find the maximum value of the field strength for both horizontal polarization and vertical polarization of the antenna.
5. For each suspected emission, the EUT was arranged to its worst case and then tune the antenna tower (from 1 m to 4 m) and turntable (from 0 degree to 360 degrees) to find the maximum reading.
6. Set the test-receiver system to Peak Detect Function and specified bandwidth with Maximum Hold Mode (RBW=120kHz/VBW=300kHz for frequency below 1GHz; RBW=1MHz VBW=3MHz (Peak), RBW=1MHz/VBW=10Hz (Average) for frequency above 1GHz).
7. If the emission level of the EUT in peak mode was 3 dB lower than the limit specified, peak values of EUT will be reported. Otherwise, the emission will be repeated by using the quasi-peak method and reported.
8. Emission level (dBµV/m) = 20 log Emission level (µV/m)
9. Corrected Reading: Antenna Factor + Cable Loss + Read Level - Preamp Factor = Level

5.2.4. Test Setup of Radiated Emission

For radiated emissions from 30MHz to 1GHz



For radiated emissions above 1GHz

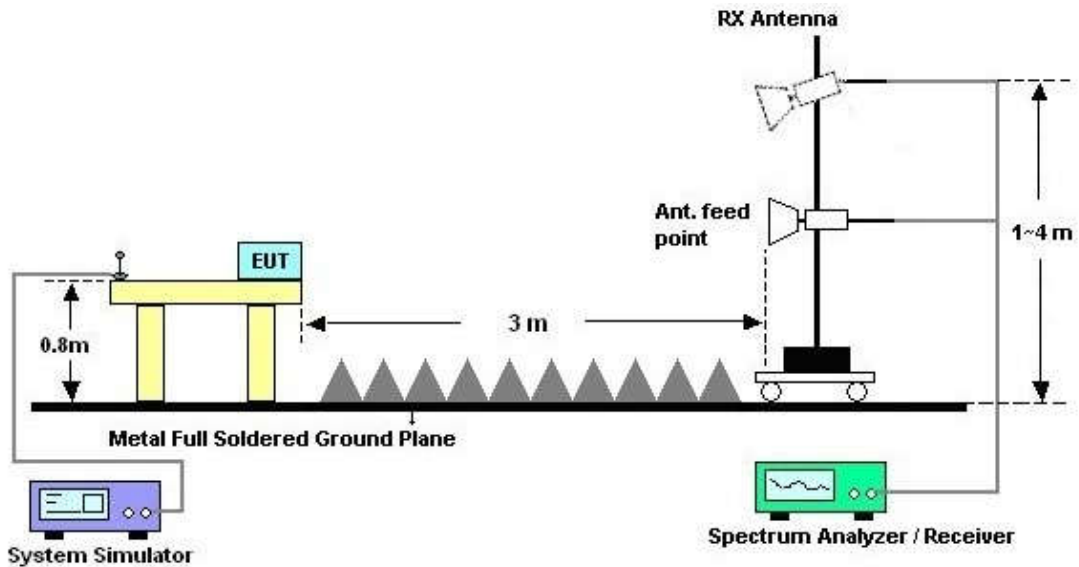



5.2.5. Test Result of Radiated Emission

Test Mode :	Mode 3	Temperature :	24~25°C
Test Engineer :	Clear Peng	Relative Humidity :	48~49%
Test Distance :	3m	Polarization :	Horizontal
Function Type :	WCDMA Band V Idle + Bluetooth Idle + WLAN Idle(2.4G) + USB Cable (Charging from Adapter) + Earphone + MPEG4 + SD Card(load) with SIM1		
Remark :	#6 is system simulator signal which can be ignored.		

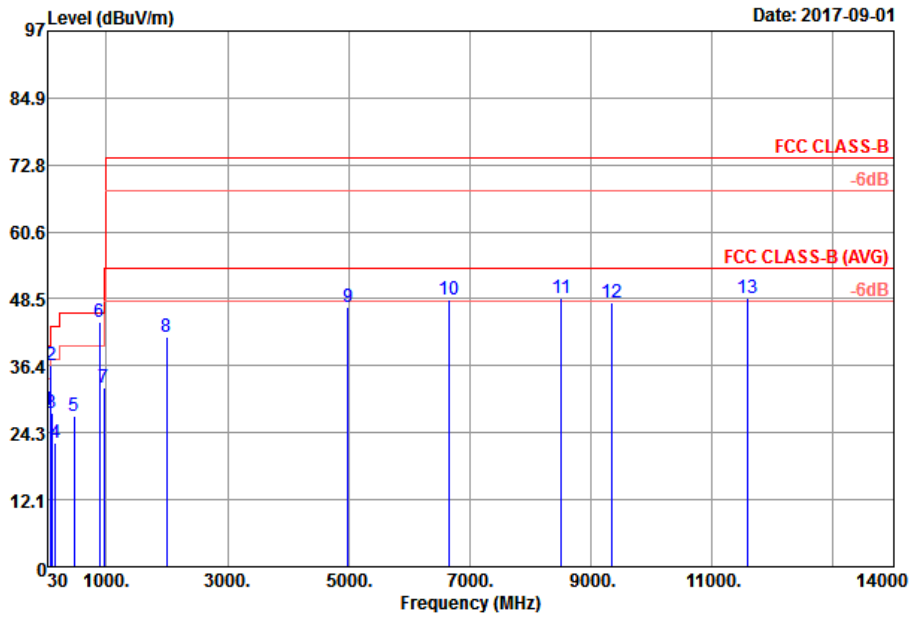

Site : 03CH01-SZ
 Condition : FCC CLASS-B 3m HF_ANT_9120D_1355_03 HORIZONTAL
 Project : 781104
 Mode : Mode 3
 Sample : #1

	Freq	Level	over Limit	Limit Line	ReadAntenna Level	Cable Factor	Preamp Loss	A/Pos	T/Pos	Remark
	MHz	dBuV/m	dB	dBuV/m	dBuV	dB/m	dB	cm	deg	
1	30.00	28.50	-11.50	40.00	33.37	26.60	0.23	31.70	---	Peak
2	79.47	36.60	-3.40	40.00	51.57	15.92	0.71	31.60	130	69 Peak
3	103.72	27.70	-15.80	43.50	39.19	19.21	0.89	31.59	---	Peak
4	164.83	22.42	-21.08	43.50	34.85	17.51	1.40	31.34	---	Peak
5	468.44	27.34	-18.66	46.00	32.07	23.99	2.62	31.34	---	Peak
6	881.66	44.22			43.62	28.33	3.77	31.50	---	Peak
7	959.26	32.54	-13.46	46.00	30.27	29.78	3.99	31.50	---	Peak
8	1998.00	41.66	-32.34	74.00	66.60	26.20	6.12	57.26	---	Peak
9	4992.00	47.06	-26.94	74.00	60.56	31.90	11.02	56.42	---	Peak
10	6652.00	48.32	-25.68	74.00	56.01	34.16	15.63	57.48	---	Peak
11	8508.00	48.67	-25.33	74.00	53.62	37.29	12.56	54.80	140	78 Peak
12	9340.00	47.81	-26.19	74.00	52.75	38.10	13.00	56.04	---	Peak
13	11582.00	48.56	-25.44	74.00	49.64	40.13	14.90	56.11	---	Peak



Test Mode :	Mode 3	Temperature :	24~25°C
Test Engineer :	Clear Peng	Relative Humidity :	48~49%
Test Distance :	3m	Polarization :	Horizontal
Function Type :	WCDMA Band V Idle + Bluetooth Idle + WLAN Idle(2.4G) + USB Cable (Charging from Adapter) + Earphone + MPEG4 + SD Card(load) with SIM1		
Remark :	#6 is system simulator signal which can be ignored.		

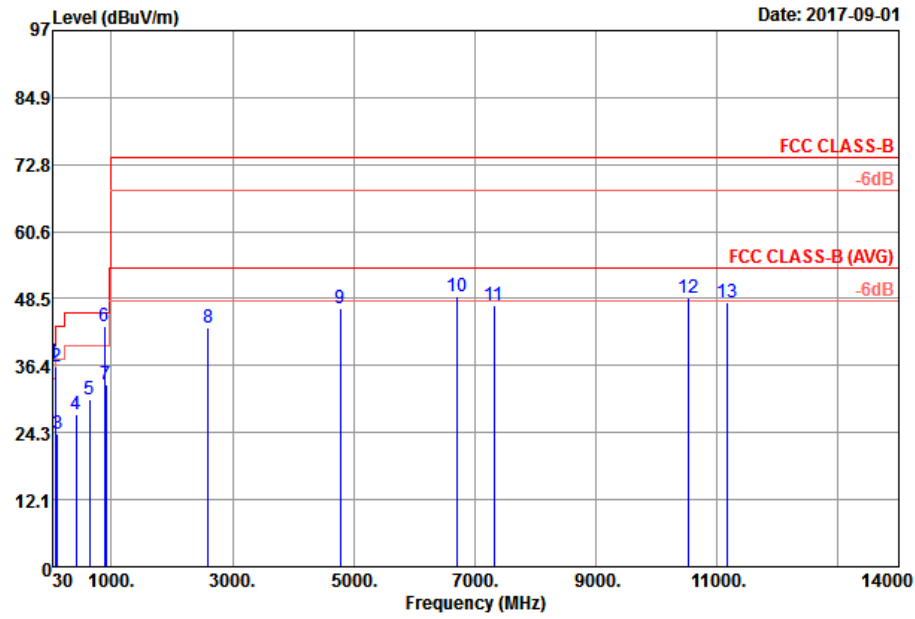

Site : 03CH01-SZ
 Condition : FCC CLASS-B 3m HF_ANT_9120D_1355_03 VERTICAL
 Project : 781104
 Mode : Mode 3
 Sample : #1
 : Y

	Freq	Level	Over	Limit	ReadAntenna	Cable	Preamp	A/Pos	T/Pos	Remark	
	MHz	dBuV/m	dB	dBuV/m	dBuV	dB/m	dB	dB	cm	deg	
1 !	31.94	36.92	-3.08	40.00	42.30	26.00	0.27	31.65	---	---	Peak
2 !	79.47	36.29	-3.71	40.00	51.26	15.92	0.71	31.60	100	40	QP
3	107.60	24.04	-19.46	43.50	35.58	19.12	0.92	31.58	---	---	Peak
4	416.06	27.51	-18.49	46.00	32.26	24.10	2.45	31.30	---	---	Peak
5	638.19	30.14	-15.86	46.00	33.06	25.46	3.12	31.50	---	---	Peak
6 !	881.66	43.40			42.80	28.33	3.77	31.50	---	---	Peak
7	915.61	32.96	-13.04	46.00	31.79	28.81	3.86	31.50	---	---	Peak
8	2598.00	43.30	-30.70	74.00	65.21	27.72	7.07	56.70	---	---	Peak
9	4782.00	46.65	-27.35	74.00	60.83	31.68	10.86	56.72	---	---	Peak
10	6706.00	48.85	-25.15	74.00	56.41	34.34	15.69	57.59	100	200	Peak
11	7320.00	47.20	-26.80	74.00	56.08	35.69	13.29	57.86	---	---	Peak
12	10526.00	48.67	-25.33	74.00	50.65	39.90	14.65	56.53	---	---	Peak
13	11168.00	47.82	-26.18	74.00	48.65	40.10	14.81	55.74	---	---	Peak



Test Mode :	Mode 5	Temperature :	24~25°C
Test Engineer :	Clear Peng	Relative Humidity :	48~49%
Test Distance :	3m	Polarization :	Vertical
Function Type :	LTE Band 4 Idle + Bluetooth Idle + WLAN Idle(2.4G) + USB Cable (Data Link with Notebook) + Earphone + SD Card(Link) + MPEG4 with SIM1		
Remark :	#7 is system simulator signal which can be ignored.		

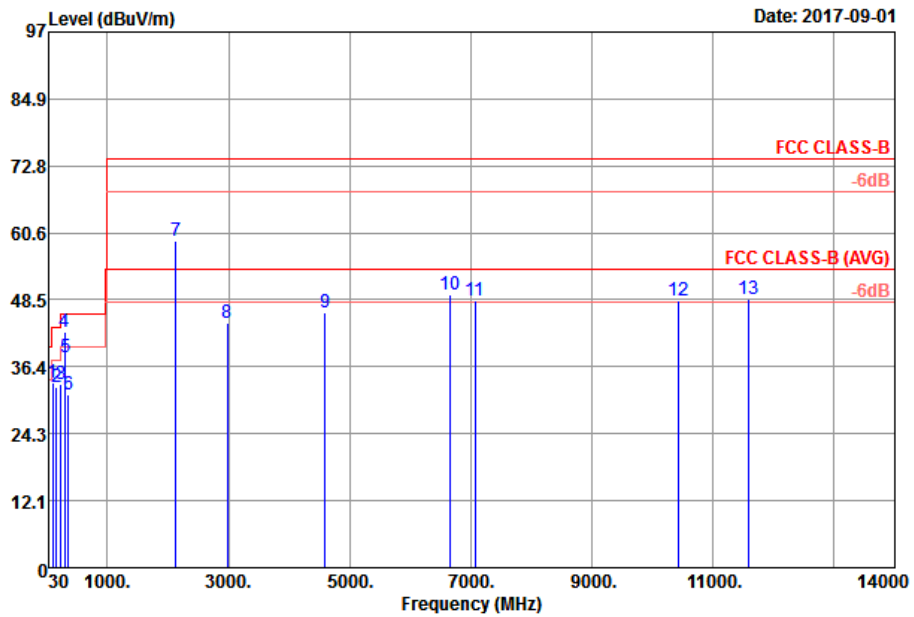

Site : 03CH01-SZ
 Condition : FCC CLASS-B 3m HF_ANT_9120D_1355_03 HORIZONTAL
 Project : 781104
 Mode : Mode 5
 Sample : #1
 : Y

	Freq	Level	Over	Limit	ReadAntenna	Cable	Preamp	A/Pos	T/Pos	Remark	
	MHz	dBuV/m	dB	dBuV/m	dBuV	dB/m	dB	dB	cm	deg	
1	99.84	33.53	-9.97	43.50	44.98	19.30	0.85	31.60	---	---	Peak
2	159.01	32.79	-10.71	43.50	45.03	17.75	1.37	31.36	---	---	Peak
3	231.76	33.28	-12.72	46.00	45.66	16.99	1.77	31.14	---	---	Peak
4	298.69	42.74	-3.26	46.00	53.51	18.48	2.04	31.29	142	68	Peak
5	312.27	38.11	-7.89	46.00	48.34	18.98	2.09	31.30	---	---	Peak
6	359.80	31.25	-14.75	46.00	39.21	21.09	2.25	31.30	---	---	Peak
7	2132.00	59.08			83.33	26.56	6.29	57.10	---	---	Peak
8	2986.00	44.29	-29.71	74.00	63.65	28.56	8.91	56.83	---	---	Peak
9	4590.00	46.16	-27.84	74.00	61.21	31.49	10.64	57.18	---	---	Peak
10	6652.00	49.32	-24.68	74.00	57.01	34.16	15.63	57.48	147	36	Peak
11	7074.00	48.31	-25.69	74.00	56.99	35.22	14.16	58.06	---	---	Peak
12	10438.00	48.41	-25.59	74.00	50.53	39.75	14.63	56.50	---	---	Peak
13	11582.00	48.56	-25.44	74.00	49.64	40.13	14.90	56.11	---	---	Peak



Test Mode :	Mode 5	Temperature :	24~25°C
Test Engineer :	Clear Peng	Relative Humidity :	48~49%
Test Distance :	3m	Polarization :	Vertical
Function Type :	LTE Band 4 Idle + Bluetooth Idle + WLAN Idle(2.4G) + USB Cable (Data Link with Notebook) + Earphone + SD Card(Link) + MPEG4 with SIM1		
Remark :	#8 is system simulator signal which can be ignored.		

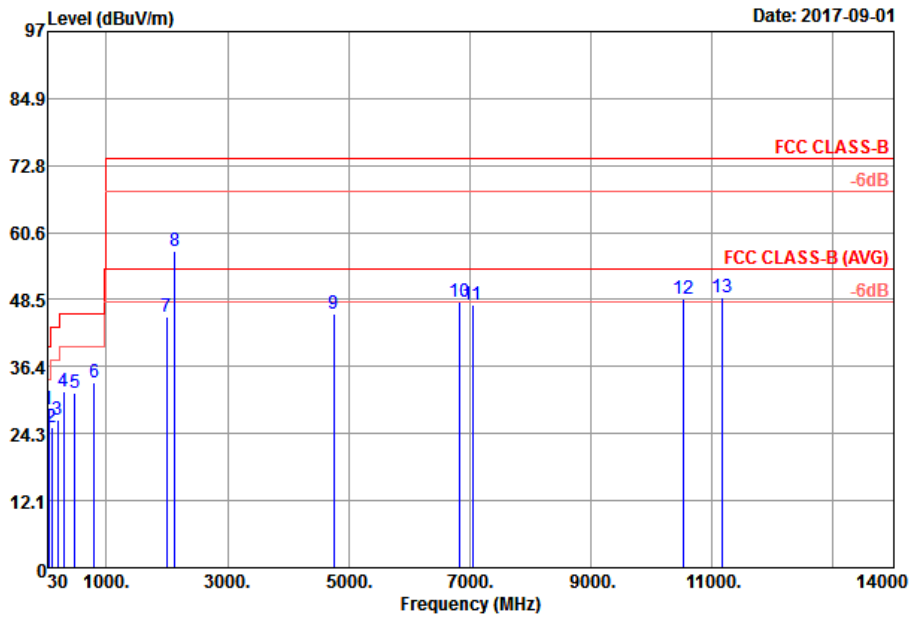

Site : 03CH01-SZ
 Condition : FCC CLASS-B 3m HF_ANT_9120D_1355_03 VERTICAL
 Project : 781104
 Mode : Mode 5
 Sample : #1
 : Y

	Freq	Level	Over	Limit	ReadAntenna	Cable	Preamp	A/Pos	T/Pos	Remark	
	MHz	dBuV/m	dB	dBuV/m	dBuV	dB/m	dB	dB	cm	deg	
1	43.58	28.61	-11.39	40.00	39.51	19.98	0.42	31.30	112	98 Peak	
2	99.84	25.39	-18.11	43.50	36.84	19.30	0.85	31.60	---	---	Peak
3	198.78	26.83	-16.67	43.50	40.28	16.14	1.61	31.20	---	---	Peak
4	299.66	31.98	-14.02	46.00	42.74	18.50	2.04	31.30	---	---	Peak
5	480.08	31.50	-14.50	46.00	36.54	23.67	2.65	31.36	---	---	Peak
6	799.21	33.40	-12.60	46.00	33.19	28.10	3.61	31.50	---	---	Peak
7	1996.00	45.43	-28.57	74.00	70.37	26.20	6.12	57.26	---	---	Peak
8	2132.00	57.27			81.52	26.56	6.29	57.10	---	---	Peak
9	4754.00	45.87	-28.13	74.00	60.16	31.66	10.82	56.77	---	---	Peak
10	6820.00	48.10	-25.90	74.00	55.39	34.61	15.85	57.75	---	---	Peak
11	7040.00	47.67	-26.33	74.00	56.20	35.16	14.36	58.05	---	---	Peak
12	10526.00	48.67	-25.33	74.00	50.65	39.90	14.65	56.53	---	---	Peak
13	11168.00	48.82	-25.18	74.00	49.65	40.10	14.81	55.74	100	90 Peak	



6. List of Measuring Equipment

Instrument	Manufacturer	Model No.	Serial No.	Characteristics	Calibration Date	Test Date	Due Date	Remark
EMI Receiver	R&S	ESR7	101630	9kHz~7GHz;	Jan. 06, 2017	Aug. 18, 2017	Jan. 05, 2018	Conduction (CO01-SZ)
AC LISN	EMCO	3816/2SH	00103912	9kHz~30MHz	Jan. 05, 2017	Aug. 18, 2017	Jan. 04, 2018	Conduction (CO01-SZ)
AC LISN (for auxiliary equipment)	MessTec	3816/2SH	00103892	9kHz~30MHz	Jan. 05, 2017	Aug. 18, 2017	Jan. 04, 2018	Conduction (CO01-SZ)
AC Power Source	Chroma	61602	616020000891	100Vac~250Vac	Jul. 19, 2017	Aug. 18, 2017	Jul. 18, 2018	Conduction (CO01-SZ)
Pulse Limiter	COM-POWER	LIT-153 Transient Limiter	53139	150kHz~30MHz	Oct. 11, 2016	Aug. 18, 2017	Oct. 10, 2017	Conduction (CO01-SZ)
EMI Test Receiver&SA	Agilent	N9038A	MY52260185	20Hz~26.5GHz	Apr. 20, 2017	Sep. 01, 2017	Apr. 19, 2018	Radiation (03CH01-SZ)
Bilog Antenna	TeseQ	CBL6112D	23188	30MHz~2GHz	Apr. 25, 2017	Sep. 01, 2017	Apr. 24, 2018	Radiation (03CH01-SZ)
Double Ridge Horn Antenna	ETS Lindgren	3117	00119436	1GHz~18GHz	Nov. 19, 2016	Sep. 01, 2017	Nov. 18, 2017	Radiation (03CH01-SZ)
LF Amplifier	Burgeon	BPA-530	102209	0.01~3000Mhz	Apr. 20, 2017	Sep. 01, 2017	Apr. 19, 2018	Radiation (03CH01-SZ)
HF Amplifier	MITEQ	AMF-7D-00101800-30-10P-R	1707137	1GHz~18GHz	Oct. 11, 2016	Sep. 01, 2017	Oct. 10, 2017	Radiation (03CH01-SZ)
AC Power Source	Chroma	61601	616010001985	N/A	NCR	Sep. 01, 2017	NCR	Radiation (03CH01-SZ)
Turn Table	EM	EM1000	N/A	0~360 degree	NCR	Sep. 01, 2017	NCR	Radiation (03CH01-SZ)
Antenna Mast	EM	EM1000	N/A	1 m~4 m	NCR	Sep. 01, 2017	NCR	Radiation (03CH01-SZ)

NCR: No Calibration Required



7. Uncertainty of Evaluation

Uncertainty of Conducted Emission Measurement (150 kHz ~ 30 MHz)

Measuring Uncertainty for a Level of Confidence of 95% ($U = 2Uc(y)$)	2.5dB
---	-------

Uncertainty of Radiated Emission Measurement (30 MHz ~ 1000 MHz)

Measuring Uncertainty for a Level of Confidence of 95% ($U = 2Uc(y)$)	5.1dB
---	-------

Uncertainty of Radiated Emission Measurement (1GHz ~ 18GHz)

Measuring Uncertainty for a Level of Confidence of 95% ($U = 2Uc(y)$)	5.2dB
---	-------