



# FCC Test Report

**APPLICANT** : Planet Avvio LLC  
**EQUIPMENT** : Mobile phone  
**BRAND NAME** : Mint  
**MODEL NAME** : M355  
**FCC ID** : 2ALTAM355X  
**STANDARD** : FCC 47 CFR FCC Part 15 Subpart B  
**CLASSIFICATION** : Certification

The product was received on Jun. 22, 2017 and testing was completed on Jun. 30, 2017. We, SPORTON International (ShenZhen) INC., would like to declare that the tested sample has been evaluated in accordance with the test procedures given in ANSI C63.4-2014 and has been in compliance with the applicable technical standards.

The test results in this report apply exclusively to the tested model / sample. Without written approval of SPORTON International (ShenZhen) INC., the test report shall not be reproduced except in full.

Prepared by: Eric Shih / Manager

Approved by: Jones Tsai / Manager



**SPORTON International (ShenZhen) INC.**

**1/F, 2/F, Bldg 5, Shiling Industrial Zone, Xinwei Village, Xili, Nanshan District, Shenzhen City, Guangdong Province, China**



## TABLE OF CONTENTS

REVISION HISTORY.....	3
SUMMARY OF TEST RESULT .....	4
<b>1. GENERAL DESCRIPTION .....</b>	<b>5</b>
1.1. Applicant.....	5
1.2. Manufacturer .....	5
1.3. Product Feature of Equipment Under Test .....	5
1.4. Product Specification of Equipment Under Test .....	6
1.5. Modification of EUT .....	6
1.6. Test Location .....	7
1.7. Applicable Standards .....	7
<b>2. TEST CONFIGURATION OF EQUIPMENT UNDER TEST.....</b>	<b>8</b>
2.1. Test Mode .....	8
2.2. Connection Diagram of Test System .....	9
2.3. Support Unit used in test configuration and system.....	11
2.4. EUT Operation Test Setup .....	12
<b>3. TEST RESULT.....</b>	<b>13</b>
3.1. Test of AC Conducted Emission Measurement .....	13
3.2. Test of Radiated Emission Measurement .....	17
<b>4. LIST OF MEASURING EQUIPMENT .....</b>	<b>22</b>
<b>5. UNCERTAINTY OF EVALUATION .....</b>	<b>23</b>
<b>APPENDIX A. SETUP PHOTOGRAPHS</b>	



### REVISION HISTORY

REPORT NO.	VERSION	DESCRIPTION	ISSUED DATE
FC762205	Rev. 01	Initial issue of report	Jul. 12, 2017



## SUMMARY OF TEST RESULT

Report Section	FCC Rule	Description	Limit	Result	Remark
3.1	15.107	AC Conducted Emission	< 15.107 limits	PASS	Under limit 10.52 dB at 0.150 MHz
3.2	15.109	Radiated Emission	< 15.109 limits	PASS	Under limit 6.32 dB at 298.650 MHz



# 1. General Description

## 1.1. Applicant

**Planet Avvio LLC**  
9725 NW 117th Ave., Medley, FL 33178, United States

## 1.2. Manufacturer

**FortuneShip**  
7th Floor, Kingson Building, New Energy Innovation Industrial Park, No.1 ChuangSheng Road, Nanshan District, P.R. China

## 1.3. Product Feature of Equipment Under Test

Product Feature	
<b>Equipment</b>	Mobile phone
<b>Brand Name</b>	Mint
<b>Model Name</b>	M355
<b>FCC ID</b>	2ALTAM355X
<b>EUT supports Radios application</b>	GSM/GPRS/EGPRS(Downlink Only)/WCDMA/HSPA/ DC-HSDPA/HSPA+/LTE WLAN 2.4GHz 802.11b/g/n HT20/HT40 Bluetooth v3.0 + EDR/Bluetooth v4.0 LE
<b>IMEI Code</b>	Conduction: 353222077826660/353222077826678 Radiation: 353222077826645/353222077826652
<b>HW Version</b>	Version 1.0
<b>SW Version</b>	yk678_37t_fdd_36g_170617_1033-BSF28D-FCC.zip
<b>EUT Stage</b>	Production Unit

**Remark:** The above EUT's information was declared by manufacturer. Please refer to the specifications or user's manual for more detailed description.



### 1.4. Product Specification of Equipment Under Test

Standards-related Product Specification	
<b>Tx Frequency</b>	GSM850: 824.2 MHz ~ 848.8 MHz GSM1900: 1850.2 MHz ~ 1909.8MHz WCDMA Band V: 826.4 MHz ~ 846.6 MHz WCDMA Band II: 1852.4 MHz ~ 1907.6 MHz LTE Band 2 : 1850.7 MHz ~ 1909.3 MHz LTE Band 4 : 1710.7 MHz ~ 1754.3 MHz LTE Band 7 : 2502.5 MHz ~ 2567.5 MHz 802.11b/g/n: 2412 MHz ~ 2462 MHz Bluetooth: 2402 MHz ~ 2480 MHz
<b>Rx Frequency</b>	GSM850: 869.2 MHz ~ 893.8 MHz GSM1900: 1930.2 MHz ~ 1989.8 MHz WCDMA Band V: 871.4 MHz ~ 891.6 MHz WCDMA Band II: 1932.4 MHz ~ 1987.6 MHz LTE Band 2 : 1930.7 MHz ~ 1989.3 MHz LTE Band 4 : 2110.7 MHz ~ 2154.3 MHz LTE Band 7 : 2622.5 MHz ~ 2687.5 MHz 802.11b/g/n: 2412 MHz ~ 2462 MHz Bluetooth: 2402 MHz ~ 2480 MHz GPS : 1.57542 GHz Glonass: 1602 MHz + n× 0.5625MHz (n=-7,-6,-5,...0,...,6)
<b>Antenna Type</b>	WWAN : PIFA Antenna WLAN : PIFA Antenna Bluetooth : PIFA Antenna GPS/Glonass : PIFA Antenna
<b>Type of Modulation</b>	GSM: GMSK GPRS: GMSK EDGE(MCS 0-4): GMSK / (MCS 5-9): 8PSK(Downlink only) WCDMA : BPSK (Uplink) HSDPA/DC-HSDPA : QPSK (Uplink) HSUPA : QPSK (Uplink) HSPA+ : 16QAM DC-HSDPA : 64QAM LTE: QPSK / 16QAM 802.11b : DSSS (DBPSK / DQPSK / CCK) 802.11g/n : OFDM (BPSK / QPSK / 16QAM / 64QAM) Bluetooth LE : GFSK Bluetooth (1Mbps) : GFSK Bluetooth (2Mbps) : $\pi/4$ -DQPSK Bluetooth (3Mbps) : 8-DPSK GPS/Glonass : BPSK

### 1.5. Modification of EUT

No modifications are made to the EUT during all test items.



### 1.6. Test Location

<b>Test Site</b>	SPORTON International (ShenZhen) INC.	
<b>Test Site Location</b>	1/F, 2/F, Bldg 5, Shiling Industrial Zone, Xinwei Village, Xili, Nanshan District, Shenzhen City, Guangdong Province, China TEL: +86-755-8637-9589 FAX: +86-755-8637-9595	
<b>Test Site No.</b>	<b>Sporton Site No.</b>	
	CO01-SZ	

<b>Test Site</b>	SPORTON International (ShenZhen) INC.	
<b>Test Site Location</b>	No. 3 Building, the third floor of south, Shahe River west, Fengzeyuan warehouse, Nanshan District, Shenzhen, Guangdong, P. R. China TEL: +86-755- 3320-2398	
<b>Test Site No.</b>	<b>Sporton Site No.</b>	<b>FCC Registration No.</b>
	03CH03-SZ	565805

**Note:** The test site complies with ANSI C63.4 2014 requirement.

### 1.7. Applicable Standards

According to the specifications of the manufacturer, the EUT must comply with the requirements of the following standards:

- ♦ FCC 47 CFR FCC Part 15 Subpart B
- ♦ ANSI C63.4-2014

**Remark:** All test items were verified and recorded according to the standards and without any deviation during the test.



## 2. Test Configuration of Equipment Under Test

### 2.1. Test Mode

The EUT has been associated with peripherals pursuant to ANSI C63.4-2014 and configuration operated in a manner tended to maximize its emission characteristics in a typical application.

Frequency range investigated: conduction (150 kHz to 30 MHz), radiation (30MHz to the 5th harmonic of the highest fundamental frequency or to 40 GHz, whichever is lower).

Test Items	Function Type
AC Conducted Emission	Mode 1: GSM850 Idle + Bluetooth Idle + WLAN Idle(2.4G) + USB Cable (Charging from Adapter) + Camera(Rear) with SIM1<Fig.1>
	Mode 2: GSM1900 Idle + Bluetooth Idle + WLAN Idle(2.4G) + USB Cable (Charging from Adapter) + Camera(Front) with SIM2<Fig.1>
	Mode 3: WCDMA Band V Idle + Bluetooth Idle + WLAN Idle(2.4G) + USB Cable (Charging from Adapter) + MPEG4 with SIM1<Fig.1>
	Mode 4: LTE Band 2 Idle + Bluetooth Idle + WLAN Idle(2.4G) + USB Cable (Charging from Adapter) + Glonass RX with SIM2<Fig.2>
	Mode 5: LTE Band 7 Idle + Bluetooth Idle + WLAN Idle(2.4G) + USB Cable (Data Link with Notebook) + GPS RX with SIM1<Fig.3>
Radiated Emissions < 1GHz	Mode 1: GSM850 Idle + Bluetooth Idle + WLAN Idle(2.4G) + USB Cable (Charging from Adapter) + Camera(Rear) with SIM1<Fig.1>
	Mode 2: GSM1900 Idle + Bluetooth Idle + WLAN Idle(2.4G) + USB Cable (Charging from Adapter) + Camera(Front) with SIM2<Fig.1>
	Mode 3: WCDMA Band V Idle + Bluetooth Idle + WLAN Idle(2.4G) + USB Cable (Charging from Adapter) + MPEG4 with SIM1<Fig.1>
	Mode 4: LTE Band 2 Idle + Bluetooth Idle + WLAN Idle(2.4G) + USB Cable (Charging from Adapter) + Glonass RX with SIM2<Fig.2>
	Mode 5: LTE Band 7 Idle + Bluetooth Idle + WLAN Idle(2.4G) + USB Cable (Data Link with Notebook) + GPS RX with SIM1<Fig.3>
Radiated Emissions ≥ 1GHz	Mode 1: LTE Band 7 Idle + Bluetooth Idle + WLAN Idle(2.4G) + USB Cable (Data Link with Notebook) + GPS RX with SIM1<Fig.3>
<b>Remark:</b>	
<ol style="list-style-type: none"> <li>1. The worst case of AC is mode 5; and the USB Link mode is mode 5, the test data of this mode was reported.</li> <li>2. The worst case of RE &lt; 1G is mode 5; and the USB Link mode is mode 5, the test data of this mode was reported.</li> <li>3. Data Link with Notebook means data application transferred mode between EUT and Notebook.</li> </ol>	



## 2.2. Connection Diagram of Test System

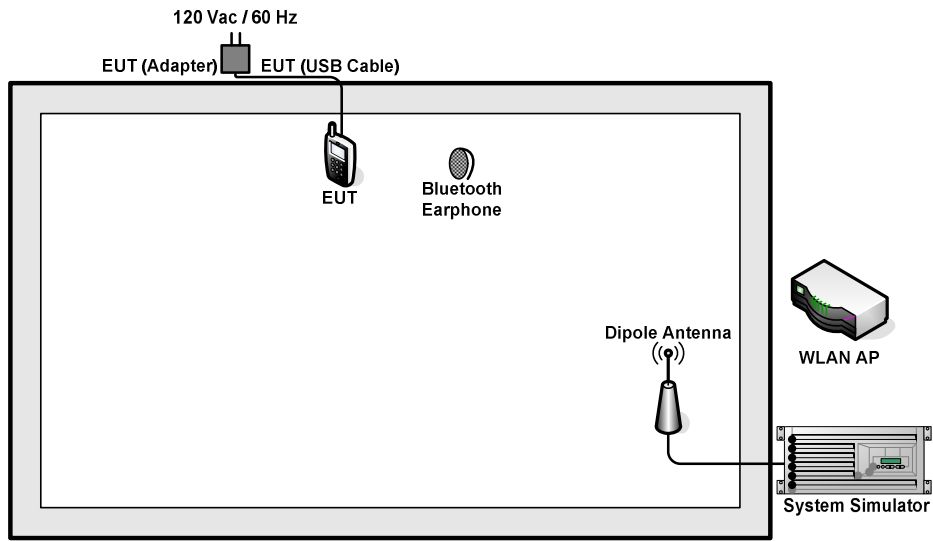

<Fig.1>

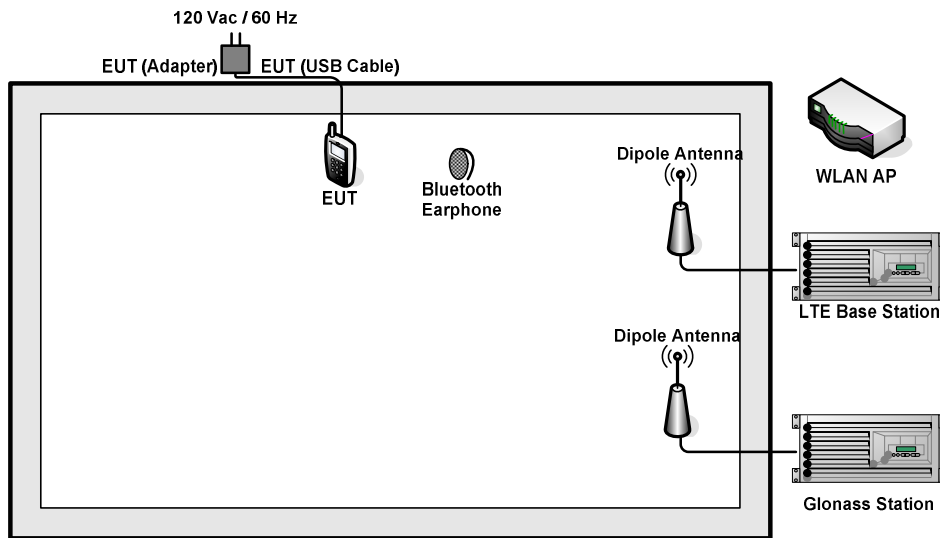

<Fig.2>

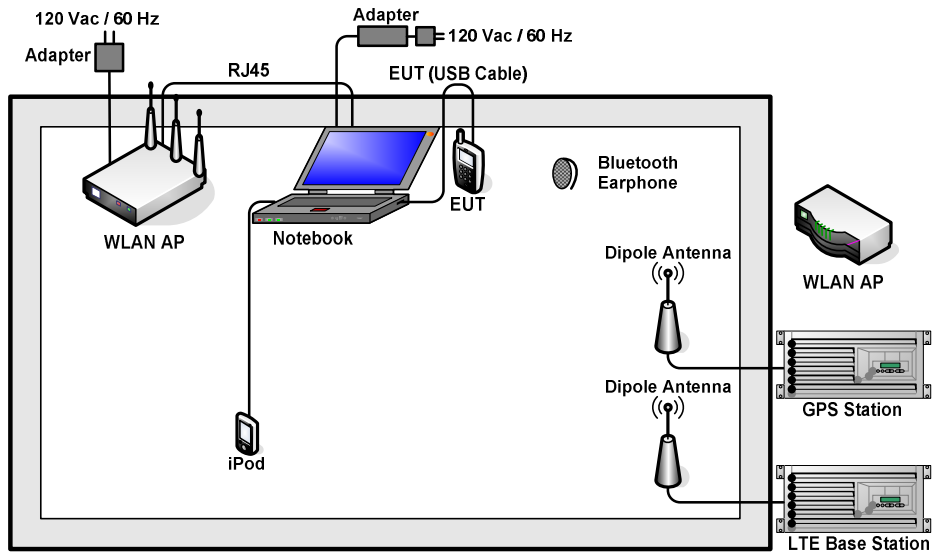

<Fig.3>

### 2.3. Support Unit used in test configuration and system

Item	Equipment	Trade Name	Model Name	FCC ID	Data Cable	Power Cord
1.	System Simulator	R&S	CMU 200	N/A	N/A	Unshielded, 1.8 m
2.	LTE Base Station	Anritus	MT8820C	N/A	N/A	Unshielded, 1.8 m
3.	GPS Station	ADIVIC	MP9000	N/A	N/A	Unshielded, 1.8 m
4.	Glonass Station	RACELOGIC	RLLS03-2RP	N/A	N/A	Unshielded, 1.8 m
5.	WLAN AP	Dlink	DIR-820L	KA2IR820LA1	N/A	Unshielded, 1.8m
6.	WLAN AP	ASUS	RT-AC66U	MSQ-RTAC66U	N/A	Unshielded, 1.8m
7.	Bluetooth Earphone	Nokia	BH-108	PYAHS-107W	N/A	N/A
8.	Bluetooth Earphone	Samsung	HS3000	A3LHS3000	N/A	N/A
9.	Notebook	Lenovo	E450	FCC DoC	N/A	AC I/P : Unshielded, 1.2m DC O/P : Shielded, 1.8m
10.	iPod nano 8GB	Apple	MC690ZP/A	FCC DoC	Shielded, 1.2m	N/A
11.	iPod	Apple	MC525 ZP/A	DoC	Shielded, 1.0m	N/A
12.	SD Card	TGSHIBA	MicroSD HC	FCC DoC	N/A	N/A
13.	SD Card	Kingston	MicroSD HC	FCC DoC	N/A	N/A



## **2.4. EUT Operation Test Setup**

The EUT was in GSM or WCDMA or LTE idle mode during the testing. The EUT was synchronized to the BCCH, and is in continuous receiving mode by setting system simulator's paging reorganization.

At the same time, the EUT was attached to the Bluetooth earphone or WLAN AP, and the following programs installed in the EUT were programmed during the test.

1. Data application is transferred between Notebook and EUT via USB cable.
2. Turn on GPS/Glonass function to make the EUT receive continuous signals from GPS/Glonass station.
3. Execute "Video player" to play MPEG4 files.
4. Turn on camera to capture images.



### 3. Test Result

#### 3.1. Test of AC Conducted Emission Measurement

##### 3.1.1 Limits of AC Conducted Emission

For equipment that is designed to be connected to the public utility (AC) power line, the radio frequency voltage that is conducted back onto the AC power line on any frequency or frequencies within the band 150 kHz to 30 MHz shall not exceed the limits in the following table.

Frequency of emission (MHz)	Conducted limit (dBuV)	
	Quasi-peak	Average
0.15-0.5	66 to 56*	56 to 46*
0.5-5	56	46
5-30	60	50

\*Decreases with the logarithm of the frequency.

##### 3.1.2 Measuring Instruments

The measuring equipment is listed in the section 4 of this test report.

##### 3.1.3 Test Procedure

1. The EUT was placed 0.4 meter from the conducting wall of the shielding room was kept at least 80 centimeters from any other grounded conducting surface.
2. Connect EUT to the power mains through a line impedance stabilization network (LISN).
3. All the support units are connecting to the other LISN.
4. The LISN provides 50 ohm coupling impedance for the measuring instrument.
5. The FCC states that a 50 ohm, 50 microhenry LISN should be used.
6. Both sides of AC line were checked for maximum conducted interference.
7. The frequency range from 150 kHz to 30 MHz was searched.
8. Set the test-receiver system to Peak Detect Function and specified bandwidth (IF Bandwidth = 9kHz) with Maximum Hold Mode. Then measurement is also conducted by Average Detector and Quasi-Peak Detector Function respectively.

### 3.1.4 Test Setup

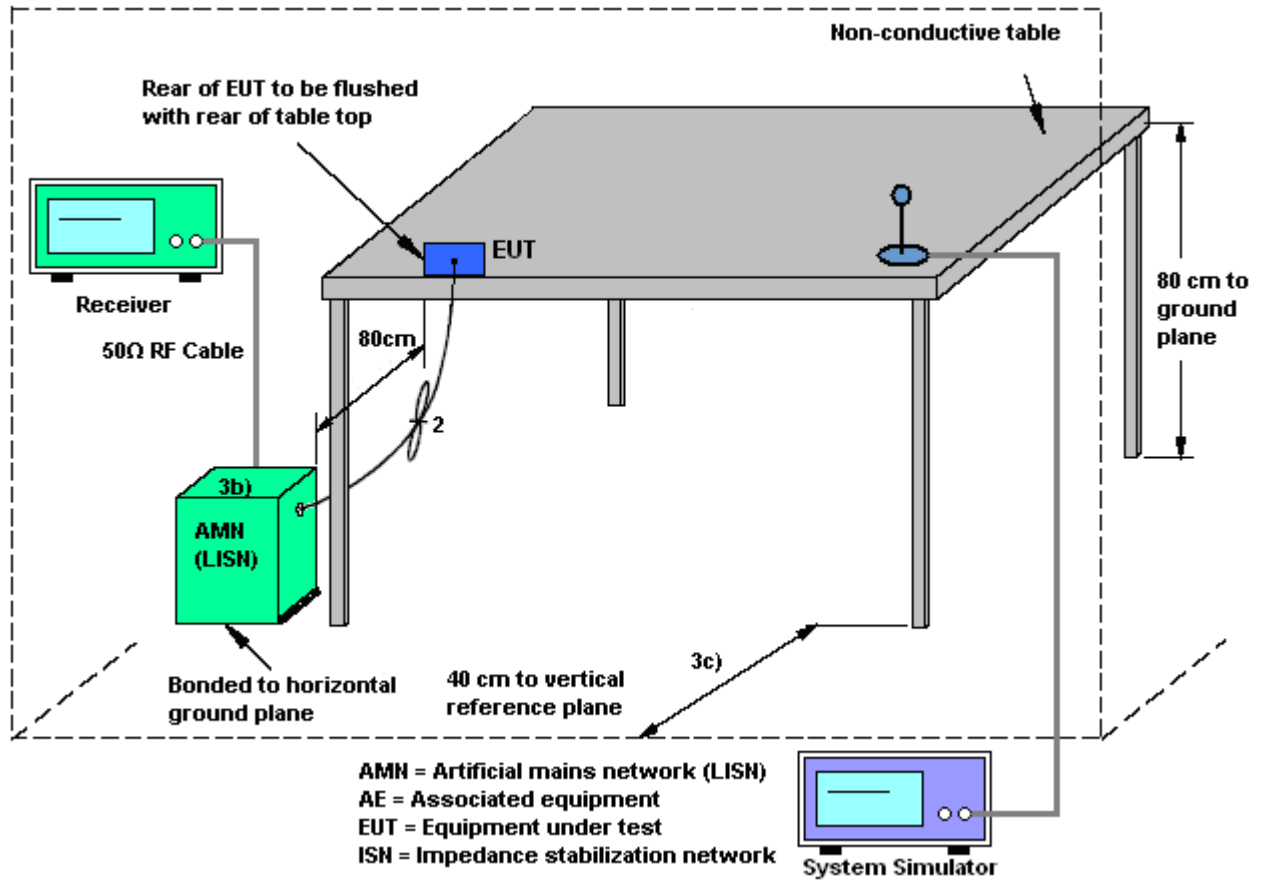



3.1.5 Test Result of AC Conducted Emission

Test Mode :	Mode 5	Temperature :	22~25°C
Test Engineer :	HaoHai YE	Relative Humidity :	50~60%
Test Voltage :	120Vac / 60Hz	Phase :	Line
Function Type :	LTE Band 7 Idle + Bluetooth Idle + WLAN Idle(2.4G) + USB Cable (Data Link with Notebook) + GPS RX with SIM1		

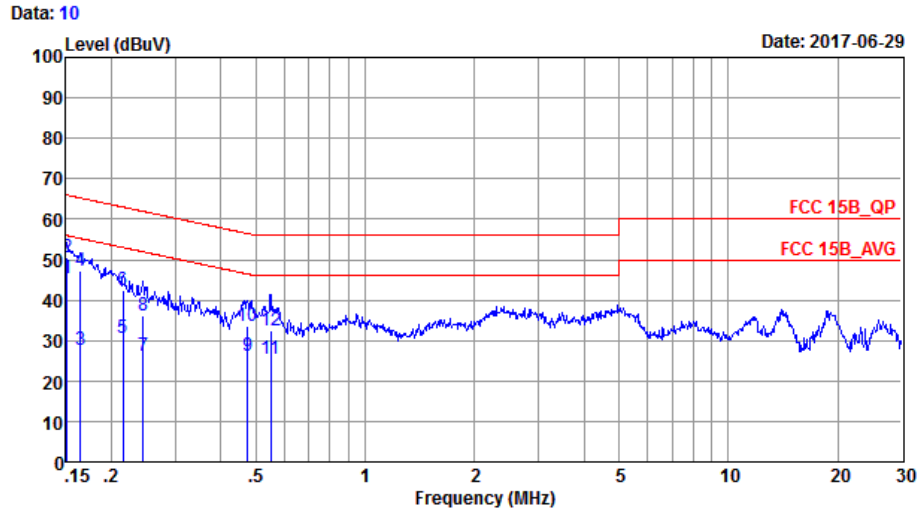

Site : CO01-SZ  
 Condition: FCC 15B QP LISN\_20170301\_L LINE

Mode : Mode 5  
 IMEI : 353222077826660/353222077826678

	Freq	Level	Over Limit	Limit Line	Read Level	LISN Factor	Cable Loss	Remark
	MHz	dBuV	dB	dBuV	dBuV	dB	dB	
1 *	0.15	45.44	-10.52	55.96	35.00	0.03	10.41	Average
2	0.15	50.44	-15.52	65.96	40.00	0.03	10.41	QP
3	0.16	27.78	-27.47	55.25	17.40	0.03	10.35	Average
4	0.16	47.28	-17.97	65.25	36.90	0.03	10.35	QP
5	0.22	30.65	-22.36	53.01	20.40	0.03	10.22	Average
6	0.22	42.45	-20.56	63.01	32.20	0.03	10.22	QP
7	0.24	26.25	-25.70	51.95	16.00	0.03	10.22	Average
8	0.24	36.15	-25.80	61.95	25.90	0.03	10.22	QP
9	0.47	26.30	-20.15	46.45	16.10	0.02	10.18	Average
10	0.47	33.40	-23.05	56.45	23.20	0.02	10.18	QP
11	0.55	25.40	-20.60	46.00	15.20	0.02	10.18	Average
12	0.55	32.50	-23.50	56.00	22.30	0.02	10.18	QP



Test Mode :	Mode 5	Temperature :	22~25°C
Test Engineer :	HaoHai YE	Relative Humidity :	50~60%
Test Voltage :	120Vac / 60Hz	Phase :	Neutral
Function Type :	LTE Band 7 Idle + Bluetooth Idle + WLAN Idle(2.4G) + USB Cable (Data Link with Notebook) + GPS RX with SIM1		

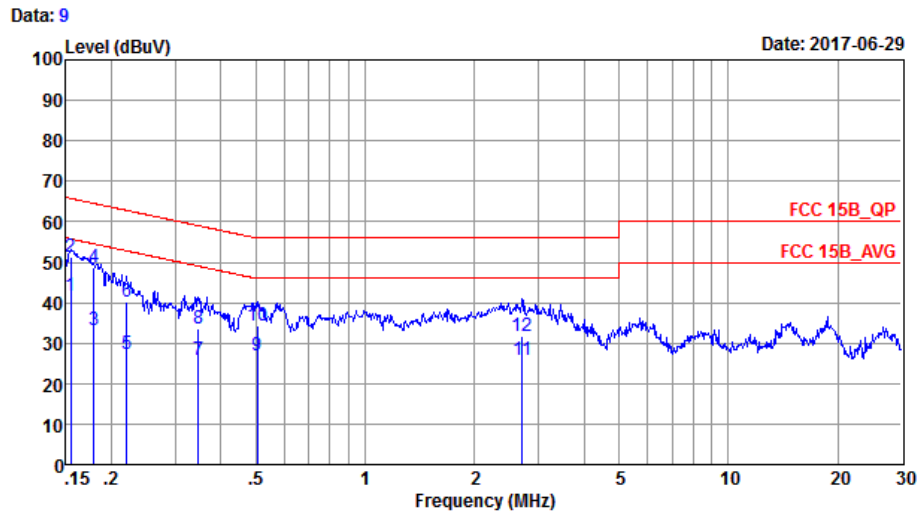

Site : CO01-SZ  
 Condition: FCC 15B\_QP LISN\_20170301\_N NEUTRAL

Mode : Mode 5  
 IMEI : 353222077826660/353222077826678

	Freq	Level	Over Limit	Limit Line	Read Level	LISN Factor	Cable Loss	Remark
	MHz	dBuV	dB	dBuV	dBuV	dB	dB	
1 *	0.15	41.72	-14.02	55.74	31.30	0.03	10.39	Average
2	0.15	51.42	-14.32	65.74	41.00	0.03	10.39	QP
3	0.18	33.22	-21.33	54.55	22.90	0.03	10.29	Average
4	0.18	48.62	-15.93	64.55	38.30	0.03	10.29	QP
5	0.22	27.25	-25.54	52.79	17.00	0.03	10.22	Average
6	0.22	40.25	-22.54	62.79	30.00	0.03	10.22	QP
7	0.35	25.83	-23.22	49.05	15.61	0.02	10.20	Average
8	0.35	33.73	-25.32	59.05	23.51	0.02	10.20	QP
9	0.50	26.90	-19.10	46.00	16.70	0.02	10.18	Average
10	0.50	34.40	-21.60	56.00	24.20	0.02	10.18	QP
11	2.71	25.93	-20.07	46.00	15.69	0.04	10.20	Average
12	2.71	31.63	-24.37	56.00	21.39	0.04	10.20	QP





### 3.2. Test of Radiated Emission Measurement

#### 3.2.1. Limit of Radiated Emission

The emissions from an unintentional radiator shall not exceed the field strength levels specified in the following table:

Frequency (MHz)	Field Strength (microvolts/meter)	Measurement Distance (meters)
30 – 88	100	3
88 – 216	150	3
216 - 960	200	3
Above 960	500	3

#### 3.2.2. Measuring Instruments

The measuring equipment is listed in the section 4 of this test report.



### **3.2.3. Test Procedures**

1. The EUT was placed on a turntable with 0.8 meter above ground.
2. The EUT was set 3 meters from the interference receiving antenna, which was mounted on the top of a variable height antenna tower.
3. The table was rotated 360 degrees to determine the position of the highest radiation.
4. The antenna is a Bi-Log antenna and its height is adjusted between one to four meters above ground to find the maximum value of the field strength for both horizontal polarization and vertical polarization of the antenna.
5. For each suspected emission, the EUT was arranged to its worst case and then tune the antenna tower (from 1 m to 4 m) and turntable (from 0 degree to 360 degrees) to find the maximum reading.
6. Set the test-receiver system to Peak Detect Function and specified bandwidth with Maximum Hold Mode (RBW=120kHz/VBW=300kHz for frequency below 1GHz; RBW=1MHz VBW=3MHz (Peak), RBW=1MHz/VBW=10Hz (Average) for frequency above 1GHz).
7. If the emission level of the EUT in peak mode was 3 dB lower than the limit specified, peak values of EUT will be reported. Otherwise, the emission will be repeated by using the quasi-peak method and reported.
8. Emission level (dB $\mu$ V/m) = 20 log Emission level ( $\mu$ V/m)
9. Corrected Reading: Antenna Factor + Cable Loss + Read Level - Preamp Factor = Level

### 3.2.4. Test Setup of Radiated Emission

For radiated emissions from 30MHz to 1GHz

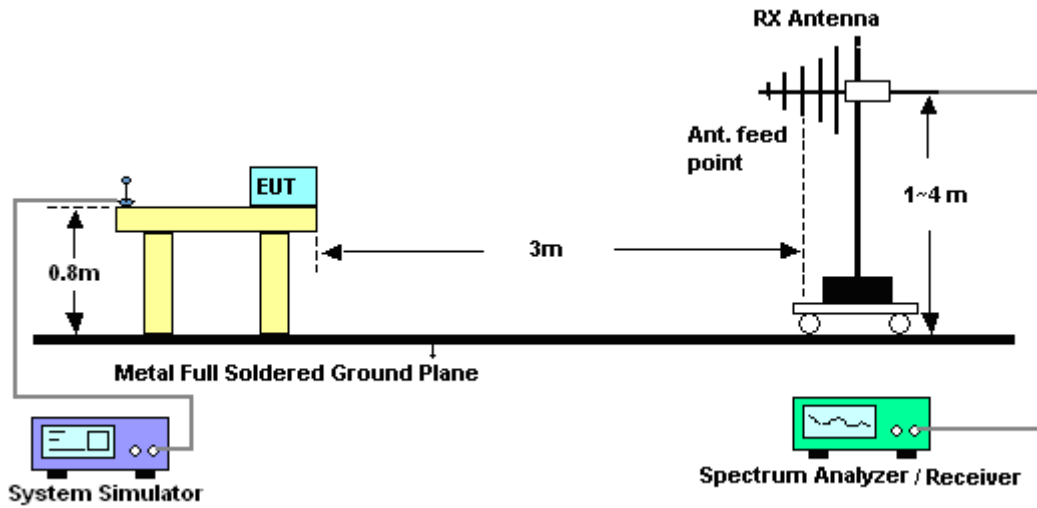

For radiated emissions above 1GHz

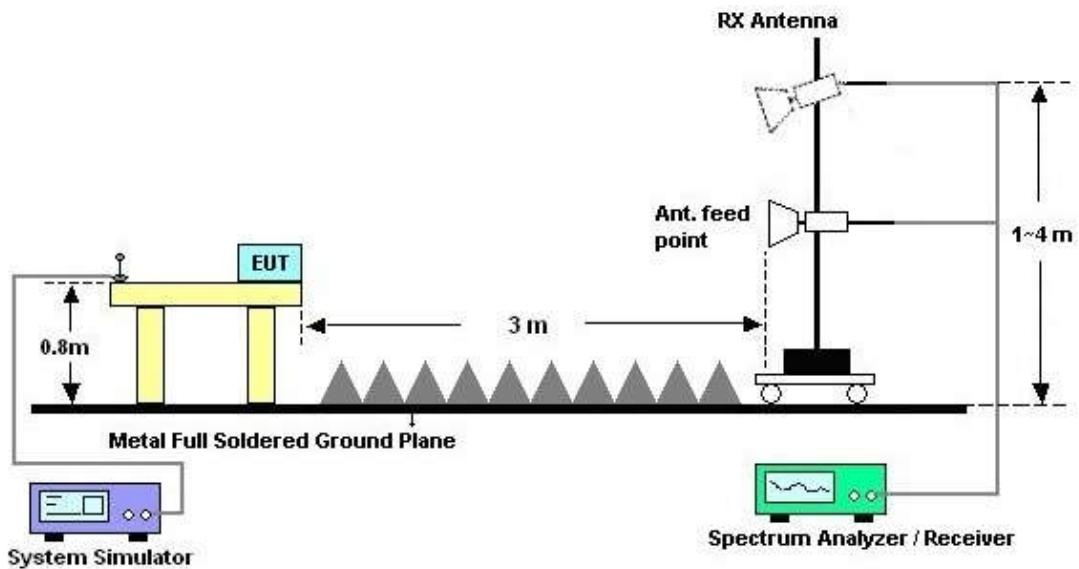



3.2.5. Test Result of Radiated Emission

Test Mode :	Mode 5	Temperature :	24~25°C
Test Engineer :	Clear Peng	Relative Humidity :	48~49%
Test Distance :	3m	Polarization :	Horizontal
Function Type :	LTE Band 7 Idle + Bluetooth Idle + WLAN Idle(2.4G) + USB Cable (Data Link with Notebook) + GPS RX with SIM1		
Remark :	#7 is system simulator signal which can be ignored.		

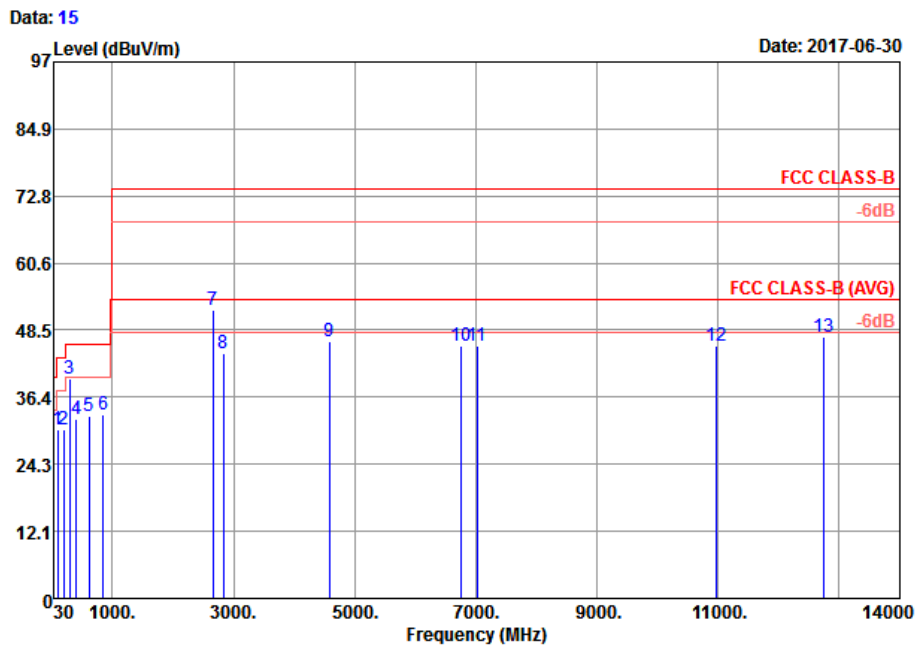

Site : 03CH03-SZ  
 Condition : FCC CLASS-B 3m HF\_ANT(3117)\_119436 HORIZONTAL  
 Mode : Mode 5  
 IMEI : 353222077826645/353222077826652

	Freq	Level	Over	Limit	ReadAntenna	Cable	Preamp	A/Pos	T/Pos	Remark	
	MHz	dBuV/m	dB	dBuV/m	dBuV	dB/m	dB	dB	cm	deg	
1	99.66	30.55	-12.95	43.50	42.00	19.30	0.85	31.60	---	---	Peak
2	199.83	30.63	-12.87	43.50	44.11	16.10	1.62	31.20	---	---	Peak
3	298.65	39.68	-6.32	46.00	50.45	18.48	2.04	31.29	154	264	Peak
4	402.90	32.51	-13.49	46.00	37.48	23.93	2.40	31.30	---	---	Peak
5	612.90	33.01	-12.99	46.00	36.31	25.15	3.05	31.50	---	---	Peak
6	843.20	33.26	-12.74	46.00	32.89	28.19	3.68	31.50	---	---	Peak
7	2655.00	52.24			69.41	32.40	7.15	56.72	---	---	Peak
8	2828.00	44.26	-29.74	74.00	60.50	32.77	7.77	56.78	---	---	Peak
9	4582.00	46.42	-27.58	74.00	59.81	33.15	10.64	57.18	---	---	Peak
10	6748.00	45.73	-28.27	74.00	51.68	35.95	15.74	57.64	---	---	Peak
11	7024.00	45.64	-28.36	74.00	53.26	35.87	14.56	58.05	---	---	Peak
12	10978.00	45.75	-28.25	74.00	48.62	38.00	14.76	55.63	---	---	Peak
13	12734.00	47.31	-26.69	74.00	50.60	38.99	15.10	57.38	200	350	Peak



Test Mode :	Mode 5	Temperature :	24~25°C
Test Engineer :	Clear Peng	Relative Humidity :	48~49%
Test Distance :	3m	Polarization :	Vertical
Function Type :	LTE Band 7 Idle + Bluetooth Idle + WLAN Idle(2.4G) + USB Cable (Data Link with Notebook) + GPS RX with SIM1		
Remark :	#7 is system simulator signal which can be ignored.		

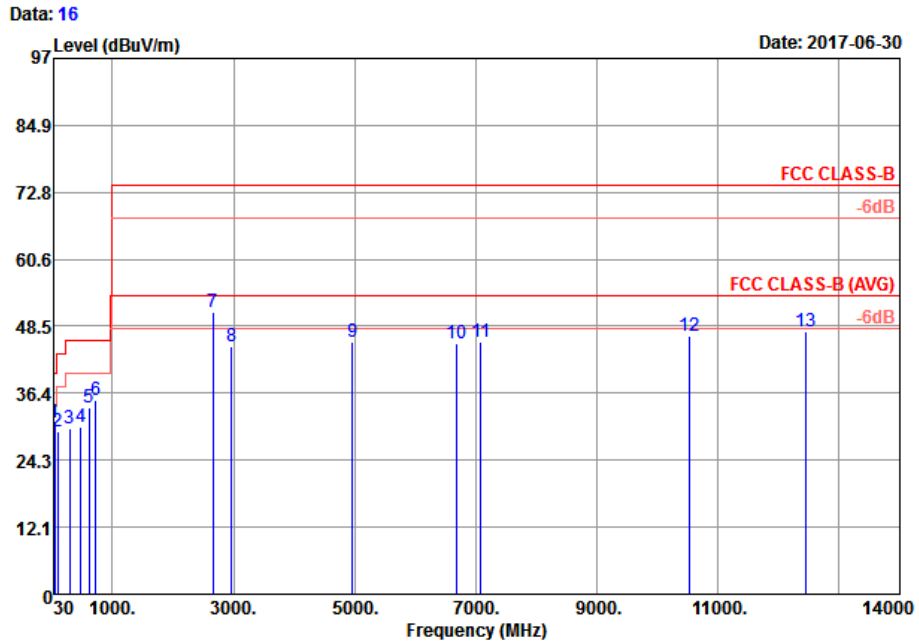

Site : 03CH03-SZ  
 Condition : FCC CLASS-B 3m HF\_ANT(3117)\_119436 VERTICAL  
 Mode : Mode 5  
 IMEI : 353222077826645/353222077826652

	Freq	Level	Over	Limit	ReadAntenna	Cable	Preamp	A/Pos	T/Pos	Remark	
	MHz	dBuV/m	dB	dBuV/m	dBuV	dB/m	dB	dB	cm	deg	
1	48.36	31.16	-8.84	40.00	45.11	17.03	0.47	31.45	112	121 Peak	
2	99.93	29.52	-13.98	43.50	40.97	19.30	0.85	31.60	---	---	Peak
3	299.73	30.08	-15.92	46.00	40.84	18.50	2.04	31.30	---	---	Peak
4	479.90	30.31	-15.69	46.00	35.35	23.67	2.65	31.36	---	---	Peak
5	617.80	33.82	-12.18	46.00	37.05	25.21	3.06	31.50	---	---	Peak
6	729.10	35.16	-10.84	46.00	35.77	27.51	3.38	31.50	---	---	Peak
7	2655.00	51.11			68.28	32.40	7.15	56.72	---	---	Peak
8	2966.00	44.80	-29.20	74.00	59.98	33.03	8.62	56.83	---	---	Peak
9	4966.00	45.55	-28.45	74.00	57.40	33.38	11.02	56.25	---	---	Peak
10	6682.00	45.43	-28.57	74.00	51.30	35.97	15.69	57.53	---	---	Peak
11	7088.00	45.64	-28.36	74.00	53.78	35.76	14.16	58.06	---	---	Peak
12	10532.00	46.82	-27.18	74.00	50.75	37.91	14.65	56.49	---	---	Peak
13	12450.00	47.61	-26.39	74.00	51.34	38.80	15.06	57.59	100	240 Peak	



### 4. List of Measuring Equipment

Instrument	Manufacturer	Model No.	Serial No.	Characteristics	Calibration Date	Test Date	Due Date	Remark
EMI Receiver	R&S	ESR7	101630	9kHz~7GHz;	Jan. 06, 2017	Jun. 29, 2017	Jan. 05, 2018	Conduction (CO01-SZ)
AC LISN	EMCO	3816/2SH	00103892	9kHz~30MHz	Jan. 05, 2017	Jun. 29, 2017	Jan. 04, 2018	Conduction (CO01-SZ)
AC LISN (for auxiliary equipment)	MessTec	3816/2SH	00103912	9kHz~30MHz	Jan. 05, 2017	Jun. 29, 2017	Jan. 04, 2018	Conduction (CO01-SZ)
AC Power Source	Chroma	61602	616020000891	100Vac~250Vac	Jul. 16, 2016	Jun. 29, 2017	Jul. 15, 2017	Conduction (CO01-SZ)
Pulse Limiter	COM-POWER	LIT-153 Transient Limiter	53139	150kHz~30MHz	Oct. 11, 2016	Jun. 29, 2017	Oct. 10, 2017	Conduction (CO01-SZ)
RF Cable	Woken	B0720#0001	CO01SZ0007	150kHz~30MHz	Oct. 08, 2016	Jun. 29, 2017	Oct. 09, 2017	Conduction (CO01-SZ)
EMI Test Receiver&SA	KEYSIGHT	N9038A	MY54450083	20Hz~8.4GHz	Apr. 20, 2017	Jun. 30, 2017	Apr. 19, 2018	Radiation (03CH03-SZ)
EXA Spectrum Analyzer	KEYSIGHT	N9010A	MY55150246	10Hz~44GHz;	Apr. 20, 2017	Jun. 30, 2017	Apr. 19, 2018	Radiation (03CH03-SZ)
Bilog Antenna	TeseQ	CBL6112D	35408	30MHz-2GHz	May 14, 2017	Jun. 30, 2017	May 13, 2018	Radiation (03CH03-SZ)
Double Ridge Horn Antenna	SCHWARZBECK	BBHA 9120D	9120D-1285	1GHz~18GHz	Jan. 11, 2016	Jun. 30, 2017	Jan. 10, 2017	Radiation (03CH03-SZ)
Amplifier	Burgeon	BPA-530	102210	0.01Hz ~3000MHz	Oct. 11, 2016	Jun. 30, 2017	Oct. 10, 2017	Radiation (03CH03-SZ)
HF Amplifier	MITEQ	AMF-7D-0010 1800-30-10P-R	1943528	1GHz~18GHz	Oct. 11, 2016	Jun. 30, 2017	Oct. 10, 2017	Radiation (03CH03-SZ)
AC Power Source	Chroma	61601	616010001985	N/A	NCR	Jun. 30, 2017	NCR	Radiation (03CH03-SZ)
Turn Table	EM	EM1000	N/A	0~360 degree	NCR	Jun. 30, 2017	NCR	Radiation (03CH03-SZ)
Antenna Mast	EM	EM1000	N/A	1 m~4 m	NCR	Jun. 30, 2017	NCR	Radiation (03CH03-SZ)

NCR: No Calibration Required



## 5. Uncertainty of Evaluation

### Uncertainty of Conducted Emission Measurement (150 kHz ~ 30 MHz)

Measuring Uncertainty for a Level of Confidence of 95% ( $U = 2Uc(y)$ )	2.5dB
---	-------

### Uncertainty of Radiated Emission Measurement (30 MHz ~ 1000 MHz)

Measuring Uncertainty for a Level of Confidence of 95% ( $U = 2Uc(y)$ )	5.1dB
---	-------

### Uncertainty of Radiated Emission Measurement (1GHz ~ 18GHz)

Measuring Uncertainty for a Level of Confidence of 95% ( $U = 2Uc(y)$ )	5.0dB
---	-------