



# FCC RF Test Report

**APPLICANT** : Planet Avvio LLC  
**EQUIPMENT** : Mobile phone  
**BRAND NAME** : Mint  
**MODEL NAME** : Mint M351  
**FCC ID** : 2ALTAM351X  
**STANDARD** : FCC 47 CFR Part 2, 22(H), 24(E)  
**CLASSIFICATION** : PCS Licensed Transmitter Held to Ear (PCE)

The product was received on Jul. 17, 2017 and testing was completed on Jul. 28, 2017. We, Sporton International (ShenZhen) Inc., would like to declare that the tested sample has been evaluated in accordance with the test procedures given in ANSI / TIA / EIA-603-D-2010 and has been in compliance with the applicable technical standards.

The test results in this report apply exclusively to the tested model / sample. Without written approval of Sporton International (ShenZhen) Inc., the test report shall not be reproduced except in full.



Approved by: Eric Shih / Manager

## **Sporton International (Shenzhen) Inc.**

**1/F, 2/F, Bldg 5, Shiling Industrial Zone, Xinwei Village, Xili, Nanshan Shenzhen City  
Guangdong Province 518055 China**



# TABLE OF CONTENTS

**REVISION HISTORY..... 3**

**SUMMARY OF TEST RESULT ..... 4**

**1 GENERAL DESCRIPTION ..... 5**

    1.1 Applicant..... 5

    1.2 Manufacturer ..... 5

    1.3 Product Feature of Equipment Under Test ..... 5

    1.4 Product Specification of Equipment Under Test ..... 6

    1.5 Modification of EUT ..... 6

    1.6 Maximum ERP/EIRP Power, Frequency Tolerance, and Emission Designator ..... 7

    1.7 Testing Location ..... 8

    1.8 Applicable Standards ..... 8

**2 TEST CONFIGURATION OF EQUIPMENT UNDER TEST ..... 9**

    2.1 Test Mode..... 9

    2.2 Connection Diagram of Test System ..... 10

    2.3 Support Unit used in test configuration ..... 10

    2.4 Measurement Results Explanation Example ..... 10

**3 CONDUCTED TEST RESULT ..... 11**

    3.1 Measuring Instruments..... 11

    3.2 Test Setup ..... 11

    3.3 Test Result of Conducted Test..... 11

    3.4 Conducted Output Power and ERP/EIRP ..... 12

    3.5 Peak-to-Average Ratio ..... 13

    3.6 99% Occupied Bandwidth and 26dB Bandwidth Measurement..... 14

    3.7 Conducted Band Edge ..... 15

    3.8 Conducted Spurious Emission ..... 16

    3.9 Frequency Stability..... 17

**4 RADIATED TEST ITEMS ..... 18**

    4.1 Measuring Instruments..... 18

    4.2 Test Setup ..... 18

    4.3 Test Result of Radiated Test..... 18

    4.4 Field Strength of Spurious Radiation Measurement ..... 19

**5 LIST OF MEASURING EQUIPMENT ..... 20**

**6 UNCERTAINTY OF EVALUATION ..... 21**

**APPENDIX A. TEST RESULTS OF CONDUCTED TEST**

**APPENDIX B. TEST RESULTS OF RADIATED TEST**

**APPENDIX C. TEST SETUP PHOTOGRAPHS**



### REVISION HISTORY

REPORT NO.	VERSION	DESCRIPTION	ISSUED DATE
FG771706A	Rev. 01	Initial issue of report	Aug. 10, 2017



### SUMMARY OF TEST RESULT

Report Section	FCC Rule	Description	Limit	Result	Remark
3.4	§2.1046	Conducted Output Power	Reporting Only	PASS	-
	§22.913(a)(2)	Effective Radiated Power	< 7 Watts	PASS	-
	§24.232(c)	Equivalent Isotropic Radiated Power	< 2 Watts	PASS	-
3.5	§24.232(d)	Peak-to-Average Ratio	< 13 dB	PASS	-
3.6	§2.1049 §22.917(b) §24.238(b)	Occupied Bandwidth	Reporting Only	PASS	-
3.7	§2.1051 §22.917(a) §24.238(a)	Band Edge Measurement	< 43+10log10(P[Watts])	PASS	-
3.8	§2.1051 §22.917(a) §24.238(a)	Conducted Emission	< 43+10log10(P[Watts])	PASS	-
3.9	§2.1055 §22.355	Frequency Stability for Temperature & Voltage	< 2.5 ppm for Part 22	PASS	-
	§2.1055 §24.235		Within Authorized Band		
4.4	§2.1053 §22.917(a) §24.238(a)	Field Strength of Spurious Radiation	< 43+10log10(P[Watts])	PASS	Under limit 27.42 dB at 13160.00 MHz



# 1 General Description

## 1.1 Applicant

Planet Avvio LLC  
9725 NW 117th Ave., Medley, FL 33178, United States

## 1.2 Manufacturer

Shenzhen Konka Telecommunications Technology Co., Ltd.  
Overseas Chinese Town, Shenzhen Special Zone, P. R. China.

## 1.3 Product Feature of Equipment Under Test

Product Feature	
Equipment	Mobile phone
Brand Name	Mint
Model Name	Mint M351
FCC ID	2ALTAM351X
EUT supports Radios application	GSM/GPRS/EGPRS/WCDMA/HSPA/ HSPA+/LTE WLAN 2.4GHz 802.11b/g/n HT20/HT40 Bluetooth v3.0 + EDR/Bluetooth v4.0 LE
IMEI Code	Conducted: 351738090000530/351738090000548 Radiation: 351738090000456/351738090000464
HW Version	1.0
SW Version	KAAR8P_SAP_ES_EN_0.44.627
EUT Stage	Production Unit

**Remark:** The above EUT's information was declared by manufacturer. Please refer to the specifications or user's manual for more detailed description.



### 1.4 Product Specification of Equipment Under Test

Standards-related Product Specification	
<b>Tx Frequency</b>	<b>GSM/GPRS/EDGE:</b> 850: 824.2 MHz ~ 848.8 MHz 1900: 1850.2 MHz ~ 1909.8MHz <b>WCDMA:</b> Band V: 826.4 MHz ~ 846.6 MHz Band II: 1852.4 MHz ~ 1907.6 MHz
<b>Rx Frequency</b>	<b>GSM/GPRS/EDGE:</b> 850: 869.2 MHz ~ 893.8 MHz 1900: 1930.2 MHz ~ 1989.8 MHz <b>WCDMA:</b> Band V: 871.4 MHz ~ 891.6 MHz Band II: 1932.4 MHz ~ 1987.6 MHz
<b>Maximum Output Power to Antenna</b>	<b>GSM/GPRS/EDGE:</b> 850: 32.35 dBm 1900: 29.57 dBm <b>WCDMA:</b> Band V: 22.50 dBm Band II: 21.93 dBm
<b>Antenna Type</b>	PCB Antenna
<b>Antenna Gain</b>	Cellular Band: -0.87 dBi PCS Band: 1.06 dBi
<b>Type of Modulation</b>	GSM: GMSK GPRS: GMSK EDGE: GMSK / 8PSK WCDMA : BPSK (Uplink) HSDPA : QPSK (Uplink) HSUPA : QPSK (Uplink) HSPA+ : 16QAM

### 1.5 Modification of EUT

No modifications are made to the EUT during all test items.



### 1.6 Maximum ERP/EIRP Power, Frequency Tolerance, and Emission Designator

FCC Rule	System	Type of Modulation	Maximum ERP/EIRP (W)	Frequency Tolerance (ppm)	Emission Designator
Part 22	GSM850 GSM	GMSK	0.8570	0.0087 ppm	245KGXW
Part 22	GSM850 EDGE class 8	8PSK	0.2037	0.0227 ppm	237KG7W
Part 22	WCDMA Band V RMC 12.2Kbps	BPSK	0.0887	0.0052 ppm	4M21F9W
Part 24	GSM1900 GSM	GMSK	1.1561	0.0338 ppm	246KGXW
Part 24	GSM1900 EDGE class 8	8PSK	0.3556	0.0113 ppm	241KG7W
Part 24	WCDMA Band II RMC 12.2Kbps	BPSK	0.1991	0.0150 ppm	4M21F9W



### 1.7 Testing Location

Sporton Lab is accredited to ISO 17025 by National Voluntary Laboratory Accreditation Program (NVLAP code: 600156-0) and the FCC designation No are CN5018 and CN5019.

<b>Test Site</b>	Sporton International (Shenzhen) Inc.	
<b>Test Site Location</b>	1/F, 2/F, Bldg 5, Shiling Industrial Zone, Xinwei Village, Xili, Nanshan Shenzhen City Guangdong Province 518055 China TEL: +86-755-8637-9589 FAX: +86-755-8637-9595	
<b>Test Site No.</b>	<b>Sporton Site No.</b>	<b>FCC Test Firm Registration No.</b>
	TH01-SZ	251365

<b>Test Site</b>	Sporton International (Shenzhen) Inc.	
<b>Test Site Location</b>	No. 3 Bldg the third floor of south, Shahe River west, Fengzeyuan Warehouse, Nanshan District Shenzhen City Guangdong Province 518055 China TEL: +86-755-3320-2398	
<b>Test Site No.</b>	<b>Sporton Site No.</b>	<b>FCC Test Firm Registration No.</b>
	03CH03-SZ	577730

**Note:** The test site complies with ANSI C63.4 2014 requirement.

### 1.8 Applicable Standards

According to the specifications of the manufacturer, the EUT must comply with the requirements of the following standards:

- 47 CFR Part 2, 22(H), 24(E)
- ANSI / TIA / EIA-603-D-2010
- FCC KDB 971168 D01 Power Meas. License Digital Systems v02r02
- FCC KDB 412172 D01 Determining ERP and EIRP v01r01

**Remark:**

1. All test items were verified and recorded according to the standards and without any deviation during the test.
2. This EUT has also been tested and complied with the requirements of FCC Part 15, Subpart B, recorded in a separate test report.





## 2 Test Configuration of Equipment Under Test

### 2.1 Test Mode

Antenna port conducted and radiated test items were performed according to KDB 971168 D01 Power Meas. License Digital Systems v02r02 with maximum output power.

Radiated measurements were performed with rotating EUT in different three orthogonal test planes to find the maximum emission.

Radiated emissions were investigated as following frequency range:

1. 30 MHz to 10th harmonic for GSM850 and WCDMA Band V.
2. 30 MHz to 10th harmonic for GSM1900 and WCDMA Band II.

All modes and data rates and positions were investigated.

Test modes are chosen to be reported as the worst case configuration below:

Test Modes		
Band	Radiated TCs	Conducted TCs
GSM 850	<ul style="list-style-type: none"> <li>■ GSM Link</li> <li>■ EDGE class 8 Link</li> </ul>	<ul style="list-style-type: none"> <li>■ GSM Link</li> <li>■ EDGE class 8 Link</li> </ul>
GSM 1900	<ul style="list-style-type: none"> <li>■ GSM Link</li> <li>■ EDGE class 8 Link</li> </ul>	<ul style="list-style-type: none"> <li>■ GSM Link</li> <li>■ EDGE class 8 Link</li> </ul>
WCDMA Band V	<ul style="list-style-type: none"> <li>■ RMC 12.2Kbps Link</li> </ul>	<ul style="list-style-type: none"> <li>■ RMC 12.2Kbps Link</li> </ul>
WCDMA Band II	<ul style="list-style-type: none"> <li>■ RMC 12.2Kbps Link</li> </ul>	<ul style="list-style-type: none"> <li>■ RMC 12.2Kbps Link</li> </ul>

## 2.2 Connection Diagram of Test System

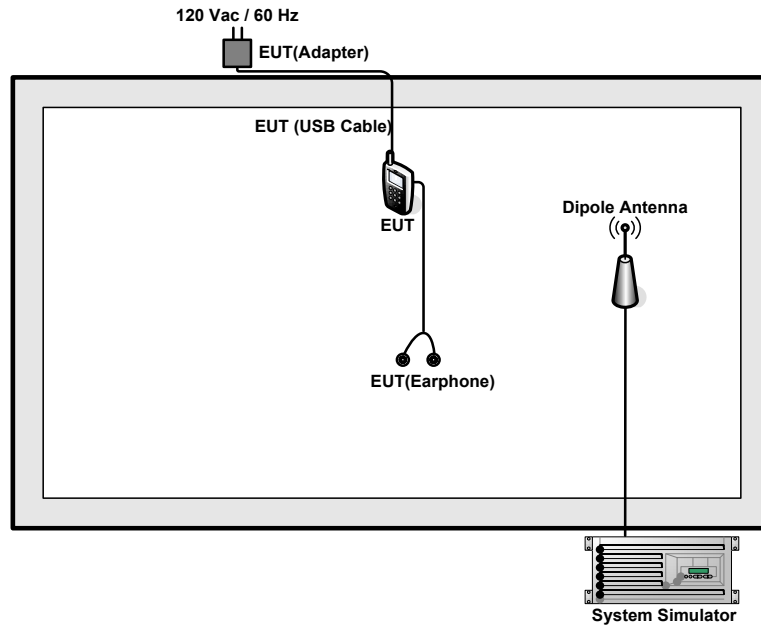

## 2.3 Support Unit used in test configuration

Item	Equipment	Trade Name	Model No.	FCC ID	Data Cable	Power Cord
1.	System Simulator	R&S	CMU 200	N/A	N/A	Unshielded, 1.8 m
2.	DC Power Supply	GW	GPS-3030D	N/A	N/A	Unshielded, 1.8 m

## 2.4 Measurement Results Explanation Example

### For all conducted test items:

The offset level is set in the spectrum analyzer to compensate the RF cable loss and attenuator factor between RF conducted output port and spectrum analyzer. With the offset compensation, the spectrum analyzer reading level will be exactly the RF output level.

The spectrum analyzer offset is derived from RF cable loss and attenuator factor.

$$\text{Offset} = \text{RF cable loss} + \text{attenuator factor}.$$

The following shows an offset computation example with RF cable loss 4.0 dB and a 10dB attenuator.

Example :

$$\begin{aligned} \text{Offset(dB)} &= \text{RF cable loss(dB)} + \text{attenuator factor(dB)}. \\ &= 4.0 + 10 = 14.0 \text{ (dB)} \end{aligned}$$

### 3 Conducted Test Result

#### 3.1 Measuring Instruments

See list of measuring instruments of this test report.

#### 3.2 Test Setup

##### 3.2.1 Conducted Output Power

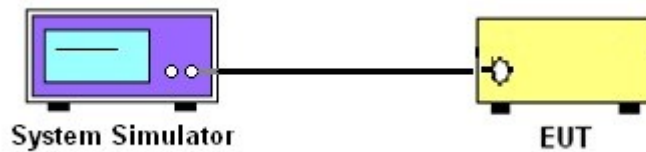

##### 3.2.2 Peak-to-Average Ratio, Occupied Bandwidth, Conducted Band-Edge and Conducted Spurious Emission

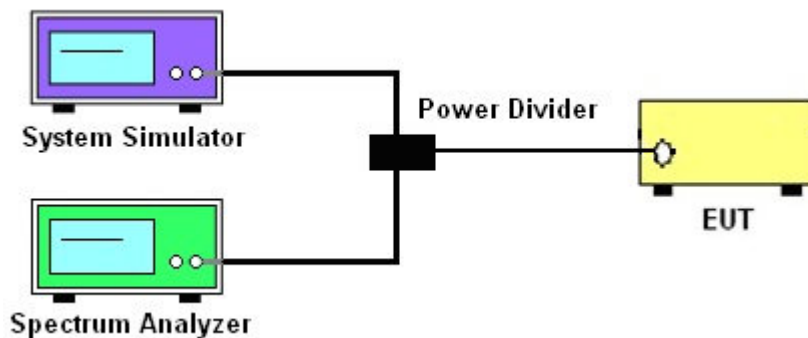

##### 3.2.3 Frequency Stability

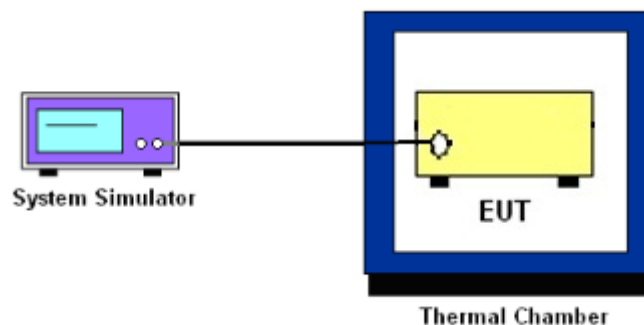

### 3.3 Test Result of Conducted Test

Please refer to Appendix A.



### 3.4 Conducted Output Power and ERP/EIRP

#### 3.4.1 Description of the Conducted Output Power and ERP/EIRP

A system simulator was used to establish communication with the EUT. Its parameters were set to enforce EUT transmitting at the maximum power. The measured power in the radio frequency on the transmitter output terminals shall be reported.

The ERP of mobile transmitters must not exceed 7 Watts for GSM850 and WCDMA Band V.

The EIRP of mobile transmitters must not exceed 2 Watts for GSM1900 and WCDMA Band II.

The EIRP of mobile transmitters must not exceed 1 Watts for WCDMA Band IV.

According to KDB 412172 D01 Power Approach,

$EIRP = P_T + G_T - L_C$ ,  $ERP = EIRP - 2.15$ , where

$P_T$  = transmitter output power in dBm

$G_T$  = gain of the transmitting antenna in dBi

$L_C$  = signal attenuation in the connecting cable between the transmitter and antenna in dB

#### 3.4.2 Test Procedures

1. The transmitter output port was connected to the system simulator.
2. Set EUT at maximum power through system simulator.
3. Select lowest, middle, and highest channels for each band and different modulation.
4. Measure the maximum burst average power for GSM and maximum average power for other modulation signal.



## **3.5 Peak-to-Average Ratio**

### **3.5.1 Description of the PAR Measurement**

The peak-to-average ratio (PAR) of the transmission may not exceed 13 dB.

### **3.5.2 Test Procedures**

1. The testing follows FCC KDB 971168 D01 v02r02 Section 5.7.1.
2. The EUT was connected to spectrum analyzer and system simulator via a power divider.
3. Set EUT to transmit at maximum output power.
4. When the duty cycle is less than 98%, then signal gating will be implemented on the spectrum analyzer by triggering from the system simulator.
5. Set the CCDF (Complementary Cumulative Distribution Function) option of the spectrum analyzer.  
Record the maximum PAPR level associated with a probability of 0.1%.



### 3.6 99% Occupied Bandwidth and 26dB Bandwidth Measurement

#### 3.6.1 Description of 99% Occupied Bandwidth and 26dB Bandwidth Measurement

The occupied bandwidth is the width of a frequency band such that, below the lower and above the upper frequency limits, the mean powers emitted are each equal to a specified percentage 0.5% of the total mean transmitted power.

The 26 dB emission bandwidth is defined as the frequency range between two points, one above and one below the carrier frequency, at which the spectral density of the emission is attenuated 26 dB below the maximum in-band spectral density of the modulated signal. Spectral density (power per unit bandwidth) is to be measured with a detector of resolution bandwidth equal to approximately 1.0% of the emission bandwidth.

#### 3.6.2 Test Procedures

1. The testing follows FCC KDB 971168 v02r02 Section 4.2.
2. The EUT was connected to spectrum analyzer and system simulator via a power divider.
3. The spectrum analyzer center frequency is set to the nominal EUT channel center frequency. The span range for the spectrum analyzer shall be between two and five times the anticipated OBW.
4. The nominal resolution bandwidth (RBW) shall be in the range of 1 to 5 % of the anticipated OBW, and the VBW shall be at least 3 times the RBW.
5. Set the detection mode to peak, and the trace mode to max hold.
6. Determine the reference value: Set the EUT to transmit a modulated signal. Allow the trace to stabilize. Set the spectrum analyzer marker to the highest level of the displayed trace.  
(this is the reference value)
7. Determine the “-26 dB down amplitude” as equal to (Reference Value – X).
8. Place two markers, one at the lowest and the other at the highest frequency of the envelope of the spectral display such that each marker is at or slightly below the “-X dB down amplitude” determined in step 6. If a marker is below this “-X dB down amplitude” value it shall be placed as close as possible to this value. The OBW is the positive frequency difference between the two markers.
9. Use the 99 % power bandwidth function of the spectrum analyzer and report the measured bandwidth.



### 3.7 Conducted Band Edge

#### 3.7.1 Description of Conducted Band Edge Measurement

The power of any emission outside of the authorized operating frequency ranges must be lower than the transmitter power (P) by a factor of at least  $43 + 10 \log (P)$  dB.

#### 3.7.2 Test Procedures

1. The testing follows FCC KDB 971168 D01 v02r02 Section 6.0.
2. The EUT was connected to the spectrum analyzer and system simulator via a power divider.
3. The RF output of EUT was connected to the spectrum analyzer by an RF cable and attenuator. The path loss was compensated to the results for each measurement.
4. The band edges of low and high channels for the highest RF powers were measured.
5. The RF fundamental frequency should be excluded against the limit line in the operating frequency band.
6. The limit line is derived from  $43 + 10\log(P)$  dB below the transmitter power P(Watts)  
=  $P(W) - [43 + 10\log(P)]$  (dB)  
=  $[30 + 10\log(P)]$  (dBm) -  $[43 + 10\log(P)]$  (dB)  
= -13dBm.



### 3.8 Conducted Spurious Emission

#### 3.8.1 Description of Conducted Spurious Emission Measurement

The power of any emission outside of the authorized operating frequency ranges must be lower than the transmitter power (P) by a factor of at least  $43 + 10 \log (P)$  dB.

It is measured by means of a calibrated spectrum analyzer and scanned from 30 MHz up to a frequency including its 10<sup>th</sup> harmonic.

#### 3.8.2 Test Procedures

1. The testing follows FCC KDB 971168 D01 v02r02 Section 6.0.
2. The EUT was connected to the spectrum analyzer and system simulator via a power divider.
3. The RF output of EUT was connected to the spectrum analyzer by an RF cable and attenuator. The path loss was compensated to the results for each measurement.
4. The middle channel for the highest RF power within the transmitting frequency was measured.
5. The conducted spurious emission for the whole frequency range was taken.
6. The RF fundamental frequency should be excluded against the limit line in the operating frequency band.
7. The limit line is derived from  $43 + 10\log(P)$  dB below the transmitter power P(Watts)  
=  $P(W) - [43 + 10\log(P)]$  (dB)  
=  $[30 + 10\log(P)]$  (dBm) -  $[43 + 10\log(P)]$  (dB)  
= -13dBm.





## **3.9 Frequency Stability**

### **3.9.1 Description of Frequency Stability Measurement**

The frequency stability shall be measured by variation of ambient temperature and variation of primary supply voltage to ensure that the fundamental emission stays within the authorized frequency block. The frequency stability of the transmitter shall be maintained within  $\pm 0.00025\%$  ( $\pm 2.5\text{ppm}$ ) of the center frequency.

### **3.9.2 Test Procedures for Temperature Variation**

1. The testing follows FCC KDB 971168 D01 v02r02 Section 9.0.
2. The EUT was set up in the thermal chamber and connected with the system simulator.
3. With power OFF, the temperature was decreased to  $-30^{\circ}\text{C}$  and the EUT was stabilized before testing. Power was applied and the maximum change in frequency was recorded within one minute.
4. With power OFF, the temperature was raised in  $10^{\circ}\text{C}$  steps up to  $50^{\circ}\text{C}$ . The EUT was stabilized at each step for at least half an hour. Power was applied and the maximum frequency change was recorded within one minute.

### **3.9.3 Test Procedures for Voltage Variation**

1. The testing follows FCC KDB 971168 D01 v02r02 Section 9.0.
2. The EUT was placed in a temperature chamber at  $20\pm 5^{\circ}\text{C}$  and connected with the system simulator.
3. The power supply voltage to the EUT was varied from 85% to 115% of the nominal value measured at the input to the EUT.
4. The variation in frequency was measured for the worst case.

## 4 Radiated Test Items

### 4.1 Measuring Instruments

See list of measuring instruments of this test report.

### 4.2 Test Setup

#### 4.2.1 For radiated test from 30MHz to 1GHz

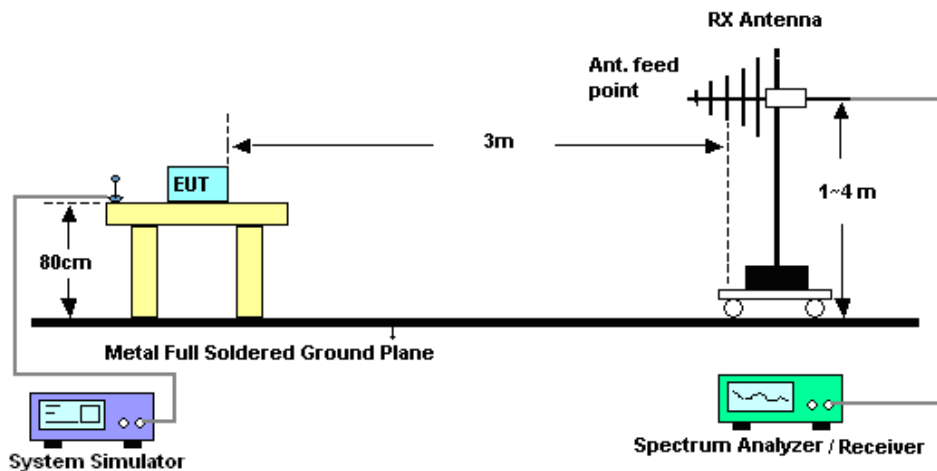

#### 4.2.2 For radiated test above 1GHz

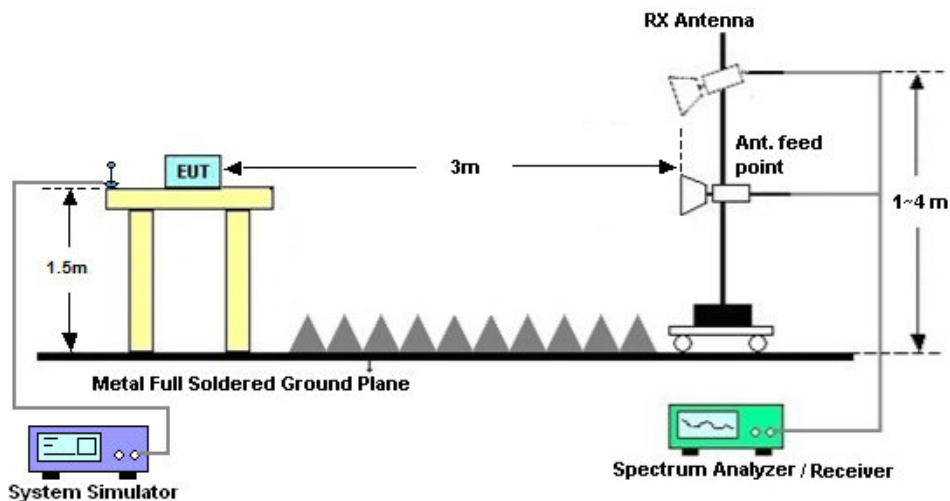

### 4.3 Test Result of Radiated Test

Please refer to Appendix B.



## 4.4 Field Strength of Spurious Radiation Measurement

### 4.4.1 Description of Field Strength of Spurious Radiated Measurement

The power of any emission outside of the authorized operating frequency ranges must be attenuated below the transmitter power (P) by a factor of at least  $43 + 10 \log (P)$  dB. The spectrum is scanned from 30 MHz up to a frequency including its 10th harmonic.

### 4.4.2 Test Procedures

1. The testing follows FCC KDB 971168 D01 v02r02 Section 5.8 and ANSI / TIA-603-D-2010 Section 2.2.12.
2. The EUT was placed on a rotatable wooden table 0.8 meters for frequency below 1GHz and 1.5 meter for frequency above 1GHz above the ground.
3. The EUT was set 3 meters from the receiving antenna, which was mounted on the antenna tower.
4. The table was rotated 360 degrees to determine the position of the highest spurious emission.
5. The height of the receiving antenna is varied between one meter and four meters to search for the maximum spurious emission for both horizontal and vertical polarizations.
6. Make the measurement with the spectrum analyzer's RBW = 1MHz, VBW = 3MHz, taking record of maximum spurious emission.
7. A horn antenna was substituted in place of the EUT and was driven by a signal generator.
8. Tune the output power of signal generator to the same emission level with EUT maximum spurious emission.
9. Taking the record of output power at antenna port.
10. Repeat step 7 to step 8 for another polarization.
11.  $EIRP \text{ (dBm)} = S.G. \text{ Power} - Tx \text{ Cable Loss} + Tx \text{ Antenna Gain}$
12.  $ERP \text{ (dBm)} = EIRP - 2.15$
13. The RF fundamental frequency should be excluded against the limit line in the operating frequency band.
14. The limit line is derived from  $43 + 10\log(P)$  dB below the transmitter power P(Watts)  
=  $P(W) - [43 + 10\log(P)] \text{ (dB)}$   
=  $[30 + 10\log(P)] \text{ (dBm)} - [43 + 10\log(P)] \text{ (dB)}$   
= -13dBm.



## 5 List of Measuring Equipment

Instrument	Manufacturer	Model No.	Serial No.	Characteristics	Calibration Date	Test Date	Due Date	Remark
Spectrum Analyzer	R&S	FSV40	101078	9kHz~40GHz	Apr. 20, 2017	Jul. 25, 2017	Apr. 19, 2018	Conducted (TH01-SZ)
Thermal Chamber	Ten Billion Hongzhangroup	LP-150U	H2014081803	-40~+150°C	Jul. 20, 2017	Jul. 25, 2017	Jul. 19, 2018	Conducted (TH01-SZ)
EMI Test Receiver&SA	KEYSIGHT	N9038A	MY54450083	20Hz~8.4GHz	Apr. 20, 2017	Jul. 27, 2017~ Jul. 28, 2017	Apr. 19, 2018	Radiation (03CH03-SZ)
EXA Spectrum Analyzer	KEYSIGHT	N9010A	MY55150246	10Hz~44GHz;	Apr. 20, 2017	Jul. 27, 2017~ Jul. 28, 2017	Apr. 19, 2018	Radiation (03CH03-SZ)
Bilog Antenna	TeseQ	CBL6112D	35408	30MHz-2GHz	May 14, 2017	Jul. 27, 2017~ Jul. 28, 2017	May 13, 2018	Radiation (03CH03-SZ)
Double Ridge Horn Antenna	SCHWARZBECK	BBHA 9120D	9120D-1285	1GHz~18GHz	Jan. 12, 2017	Jul. 27, 2017~ Jul. 28, 2017	Jan. 11, 2018	Radiation (03CH03-SZ)
SHF-EHF Horn	com-power	AH-840	101071	18GHz-40GHz	Aug. 10, 2016	Jul. 27, 2017~ Jul. 28, 2017	Aug. 09, 2017	Radiation (03CH03-SZ)
Amplifier	Burgeon	BPA-530	102210	0.01Hz ~3000MHz	Oct. 11, 2016	Jul. 27, 2017~ Jul. 28, 2017	Oct. 10, 2017	Radiation (03CH03-SZ)
Amplifier	Agilent Technologies	83017A	MY39501302	500MHz~26.5GHz	Jan. 06, 2017	Jul. 27, 2017~ Jul. 28, 2017	Jan. 05, 2018	Radiation (03CH03-SZ)
HF Amplifier	MITEQ	TTA1840-35-HG	1988315	18GHz~40GHz	Jul. 27, 2017	Jul. 27, 2017~ Jul. 28, 2017	Jul. 26, 2018	Radiation (03CH03-SZ)
AC Power Source	Chroma	61601	616010001985	N/A	NCR	Jul. 27, 2017~ Jul. 28, 2017	NCR	Radiation (03CH03-SZ)
Turn Table	EM	EM1000	N/A	0~360 degree	NCR	Jul. 27, 2017~ Jul. 28, 2017	NCR	Radiation (03CH03-SZ)
Antenna Mast	EM	EM1000	N/A	1 m~4 m	NCR	Jul. 27, 2017~ Jul. 28, 2017	NCR	Radiation (03CH03-SZ)

NCR: No Calibration Required



## 6 Uncertainty of Evaluation

### Uncertainty of Radiated Emission Measurement (30 MHz ~ 1000 MHz)

Measuring Uncertainty for a Level of Confidence of 95% ( $U = 2Uc(y)$ )	3.0dB
---	-------

### Uncertainty of Radiated Emission Measurement (1 GHz ~ 18 GHz)

Measuring Uncertainty for a Level of Confidence of 95% ( $U = 2Uc(y)$ )	3.6dB
---	-------

### Uncertainty of Radiated Emission Measurement (18 GHz ~ 40 GHz)

Measuring Uncertainty for a Level of Confidence of 95% ( $U = 2Uc(y)$ )	3.8dB
---	-------



## Appendix A. Test Results of Conducted Test

### Conducted Output Power(Average power)

Conducted Power (*Unit: dBm)						
Band	GSM850			GSM1900		
Channel	128	189	251	512	661	810
Frequency	824.2	836.4	848.8	1850.2	1880.0	1909.8
<b>GSM</b>	32.21	32.32	<b>32.35</b>	29.51	<b>29.57</b>	29.53
<b>GPRS class 8</b>	32.19	32.31	32.34	29.50	29.56	29.52
<b>GPRS class 10</b>	31.55	31.65	31.73	28.73	28.83	28.72
<b>GPRS class 11</b>	29.90	30.01	30.10	27.00	27.08	27.07
<b>GPRS class 12</b>	28.75	28.86	28.96	25.96	26.03	26.12
<b>EGPRS class 8</b>	26.11	26.06	25.96	24.45	24.30	24.34
<b>EGPRS class 10</b>	25.25	25.21	24.98	23.23	23.19	23.16
<b>EGPRS class 11</b>	23.43	23.37	23.23	21.22	21.15	21.10
<b>EGPRS class 12</b>	22.51	22.41	22.26	19.91	19.88	20.09

Conducted Power (*Unit: dBm)						
Band	WCDMA Band V			WCDMA Band II		
Channel	4132	4182	4233	9262	9400	9538
Frequency	826.4	836.4	846.6	1852.4	1880	1907.6
<b>AMR 12.2Kbps</b>	22.33	22.48	22.32	21.75	21.92	21.81
<b>RMC 12.2 Kbps</b>	22.34	<b>22.50</b>	22.33	21.79	<b>21.93</b>	21.83
<b>HSDPA Subtest-1</b>	21.70	21.74	21.69	21.43	21.72	21.54
<b>HSDPA Subtest-2</b>	21.70	21.72	21.69	21.47	21.73	21.54
<b>HSDPA Subtest-3</b>	20.91	21.27	21.24	21.00	21.27	21.08
<b>HSDPA Subtest-4</b>	21.18	21.30	21.21	20.94	21.23	21.05
<b>HSUPA Subtest-1</b>	19.68	19.76	19.71	19.60	19.88	19.57
<b>HSUPA Subtest-2</b>	19.71	19.76	19.73	19.52	19.78	19.56
<b>HSUPA Subtest-3</b>	20.69	20.75	20.73	20.53	20.74	20.57
<b>HSUPA Subtest-4</b>	19.18	19.22	19.19	18.93	19.22	19.03
<b>HSUPA Subtest-5</b>	21.30	21.70	21.70	21.50	21.70	21.50
<b>HSPA+ (16QAM) Subtest-1</b>	18.98	18.99	19.00	18.44	18.69	18.68



**ERP/EIRP**

<b>GSM850 (G<sub>T</sub> - L<sub>C</sub>= -0.87dBi)</b>			
<b>Channel</b>	<b>128</b>	<b>189</b>	<b>251</b>
	<b>(Low)</b>	<b>(Mid)</b>	<b>(High)</b>
<b>Frequency</b>	<b>824.2</b>	<b>836.4</b>	<b>848.8</b>
<b>(MHz)</b>			
<b>Conducted Power (dBm)</b>	32.21	32.32	32.35
<b>Conducted Power (Watts)</b>	1.6634	1.7061	1.7179
<b>ERP(dBm)</b>	29.19	29.30	29.33
<b>ERP(Watts)</b>	0.8299	0.8511	0.8570

<b>EDGE850 (G<sub>T</sub> - L<sub>C</sub>= -0.87 dB)</b>			
<b>Channel</b>	<b>128</b>	<b>189</b>	<b>251</b>
	<b>(Low)</b>	<b>(Mid)</b>	<b>(High)</b>
<b>Frequency</b>	<b>824.2</b>	<b>836.4</b>	<b>848.8</b>
<b>(MHz)</b>			
<b>Conducted Power (dBm)</b>	26.11	26.06	25.96
<b>Conducted Power (Watts)</b>	0.4083	0.4036	0.3945
<b>ERP(dBm)</b>	23.09	23.04	22.94
<b>ERP(Watts)</b>	0.2037	0.2014	0.1968

<b>GSM1900 (G<sub>T</sub> - L<sub>C</sub>= 1.06dBi)</b>			
<b>Channel</b>	<b>512</b>	<b>661</b>	<b>810</b>
	<b>(Low)</b>	<b>(Mid)</b>	<b>(High)</b>
<b>Frequency</b>	<b>1850.2</b>	<b>1880</b>	<b>1909.8</b>
<b>(MHz)</b>			
<b>Conducted Power (dBm)</b>	29.51	29.57	29.53
<b>Conducted Power (Watts)</b>	0.8933	0.9057	0.8974
<b>EIRP(dBm)</b>	30.57	30.63	30.59
<b>EIRP(Watts)</b>	1.1402	1.1561	1.1455



EDGE1900 ( $G_T - L_C = 1.06$ dB)			
Channel	512	661	810
	(Low)	(Mid)	(High)
Frequency	1850.2	1880	1909.8
(MHz)			
Conducted Power (dBm)	24.45	24.30	24.34
Conducted Power (Watts)	0.2786	0.2692	0.2716
EIRP(dBm)	25.51	25.36	25.40
EIRP(Watts)	0.3556	0.3436	0.3467

WCDMA Band V ( $G_T - L_C = -0.79$ dBi)			
Channel	4132	4182	4233
	(Low)	(Mid)	(High)
Frequency	826.4	836.4	846.6
(MHz)			
Conducted Power (dBm)	22.34	22.50	22.33
Conducted Power (Watts)	0.1714	0.1778	0.1710
ERP(dBm)	19.32	19.48	19.31
ERP(Watts)	0.0855	0.0887	0.0853

WCDMA Band II ( $G_T - L_C = 1.06$ dBi)			
Channel	9262	9400	9538
	(Low)	(Mid)	(High)
Frequency	1852.4	1880	1907.6
(MHz)			
Conducted Power (dBm)	21.79	21.93	21.83
Conducted Power (Watts)	0.1510	0.1560	0.1524
EIRP(dBm)	22.85	22.99	22.89
EIRP(Watts)	0.1928	0.1991	0.1945





### Peak-to-Average Ratio

Mode	GSM850(dB)		Limit: 13dB
Mod.	GSM	EDGE class 8	Result
Lowest CH	0.12	2.87	PASS
Middle CH	0.14	2.87	
Highest CH	0.12	2.64	

Mode	GSM1900(dB)		Limit: 13dB
Mod.	GSM	EDGE class 8	Result
Lowest CH	0.20	3.07	PASS
Middle CH	0.20	3.10	
Highest CH	0.17	3.28	

Mode	WCDMA Band V(dB)	WCDMA Band II(dB)	Limit: 13dB
Mod.	RMC 12.2Kbps	RMC 12.2Kbps	Result
Lowest CH	2.93	2.87	PASS
Middle CH	2.90	2.81	
Highest CH	2.67	2.81	

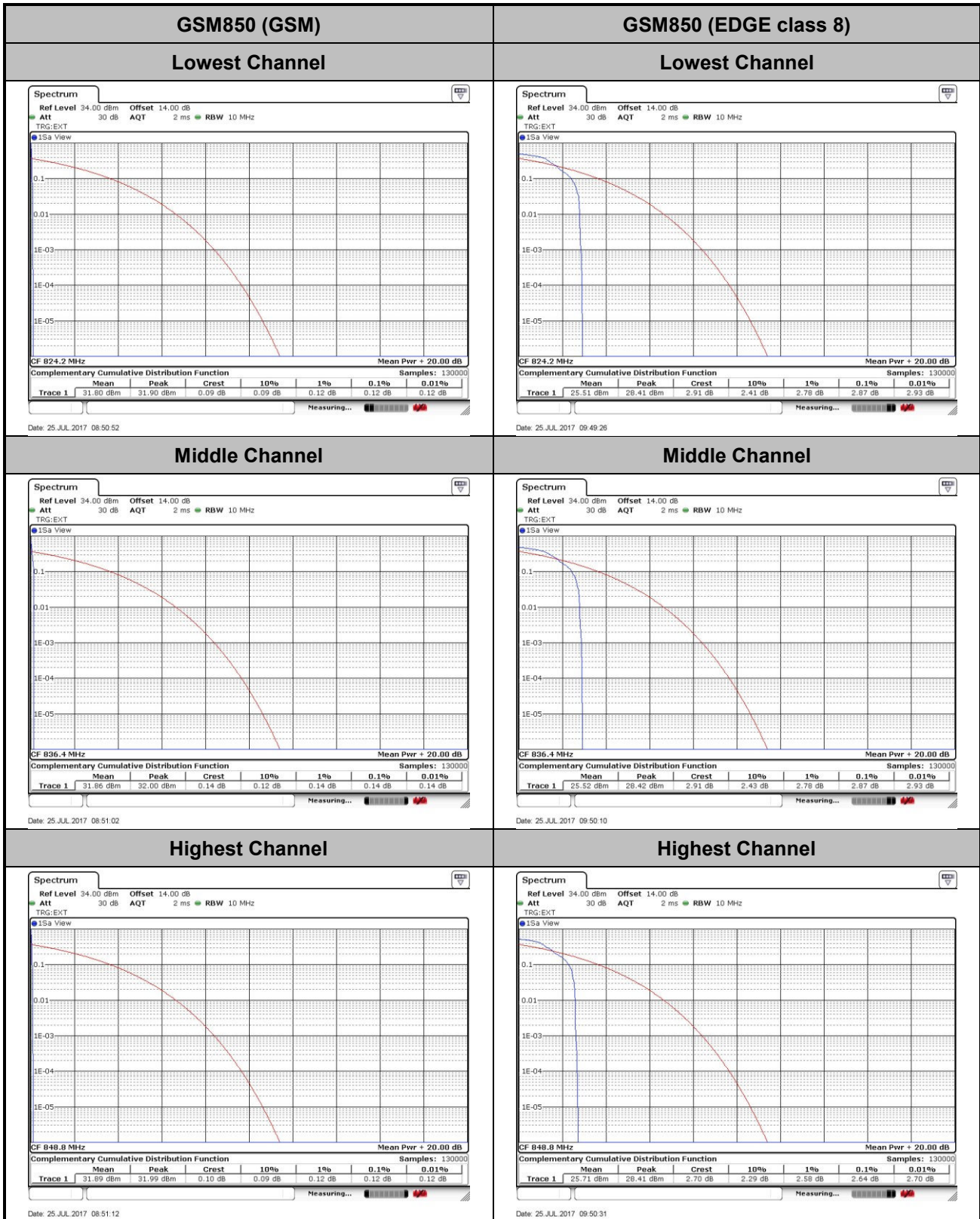

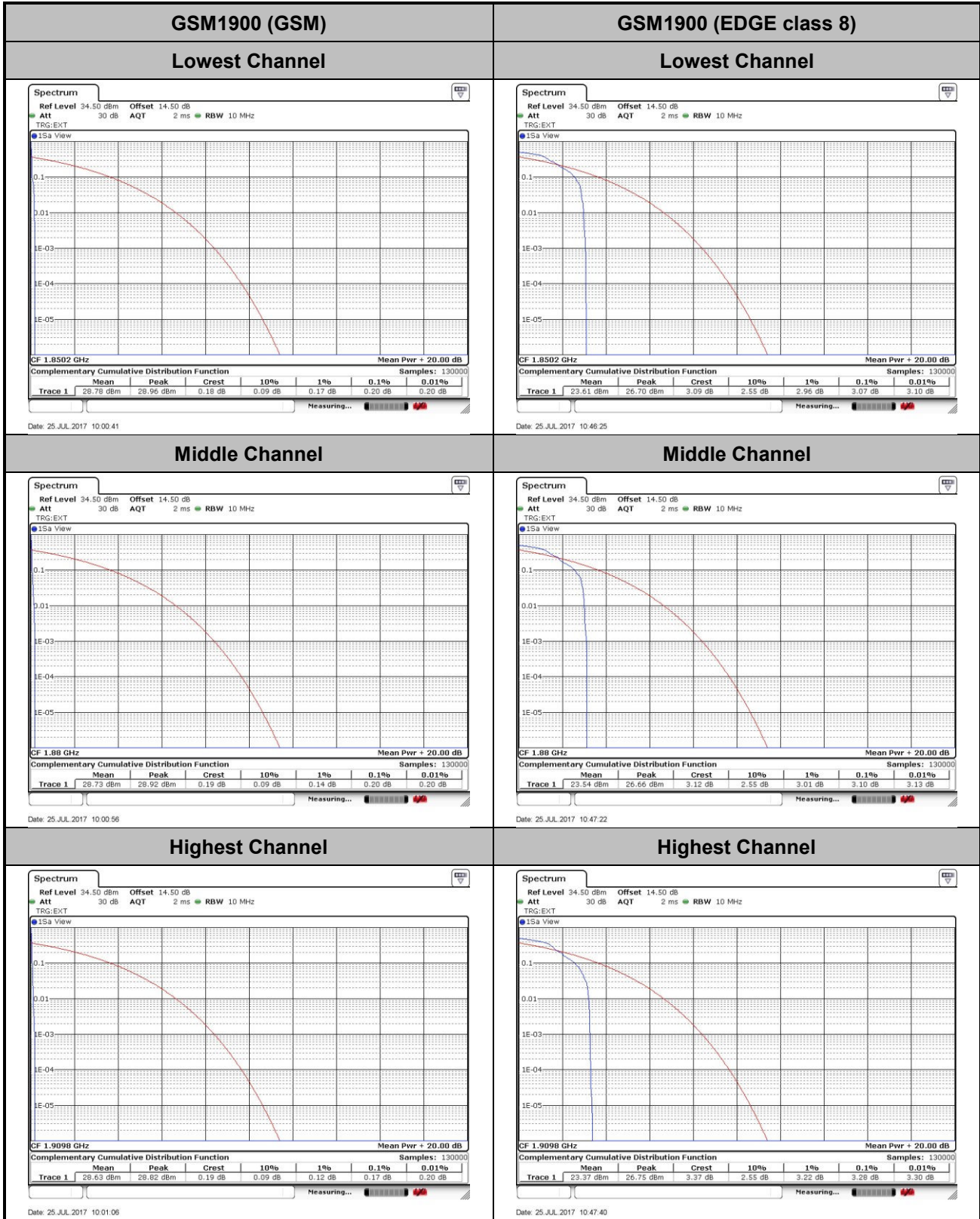

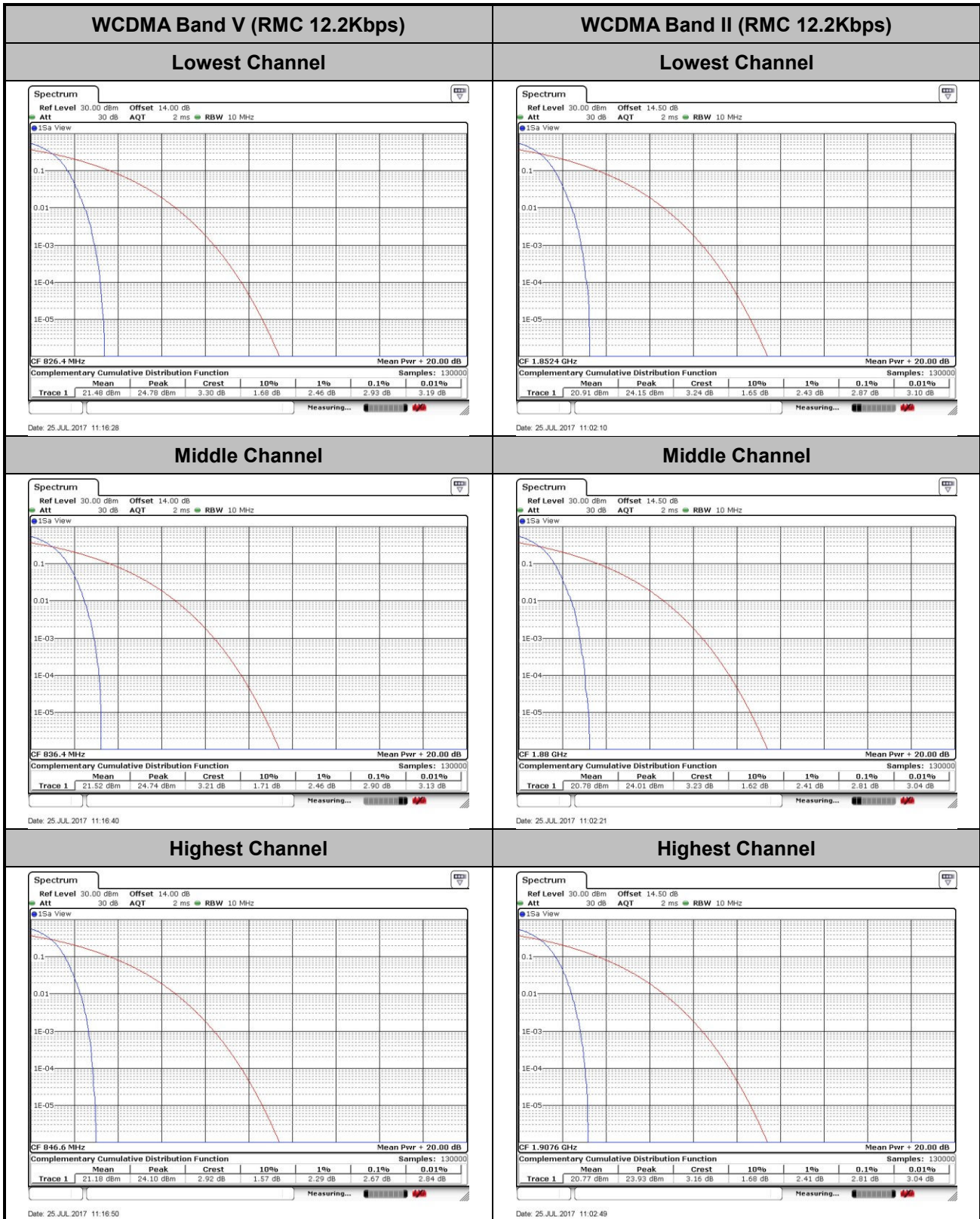



**26dB Bandwidth**

Mode	GSM850(MHz)	
Mod.	GSM	EDGE class 8
Lowest CH	0.315	0.292
Middle CH	0.314	0.293
Highest CH	0.315	0.295

Mode	GSM1900(MHz)	
Mod.	GSM	EDGE class 8
Lowest CH	0.317	0.309
Middle CH	0.316	0.294
Highest CH	0.315	0.299

Mode	WCDMA Band V(MHz)	WCDMA Band II(MHz)
Mod.	RMC 12.2Kbps	RMC 12.2Kbps
Lowest CH	4.86	4.90
Middle CH	4.86	4.87
Highest CH	4.87	4.85



GSM850 (GSM)

Lowest Channel

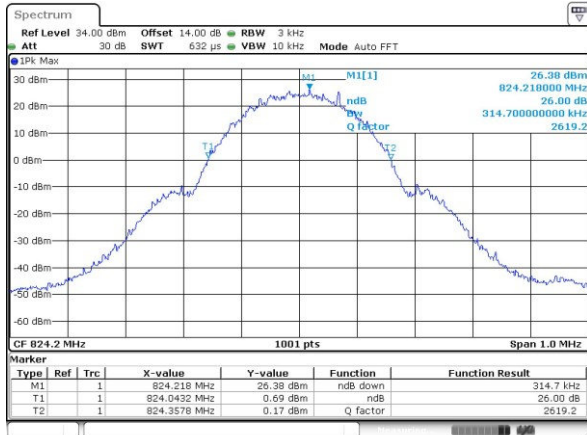

Date: 25 JUL 2017 08:40:30

GSM850 (EDGE class 8)

Lowest Channel

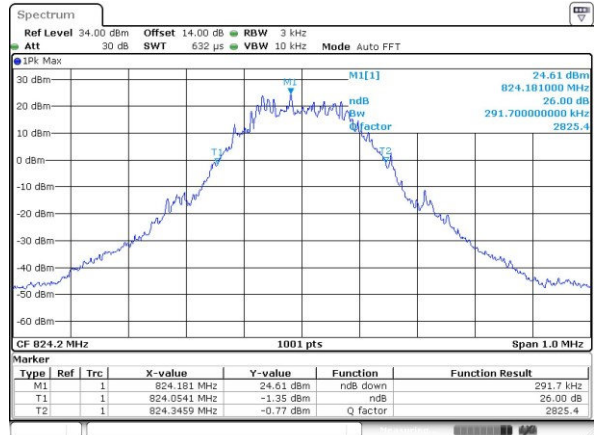

Date: 25 JUL 2017 09:36:24

Middle Channel

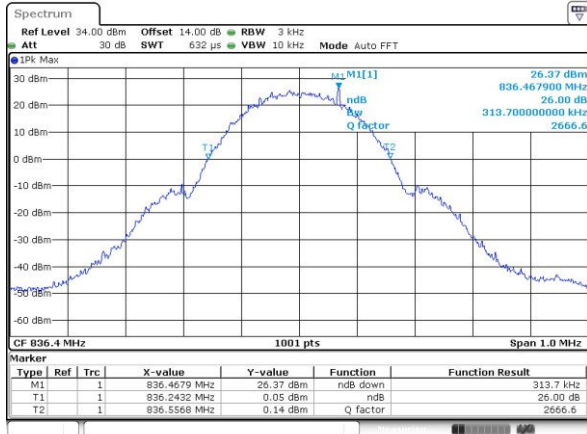

Date: 25 JUL 2017 08:40:58

Middle Channel

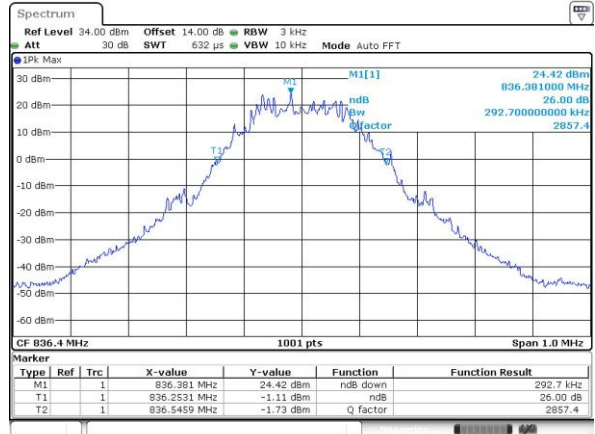

Date: 25 JUL 2017 09:37:47

Highest Channel

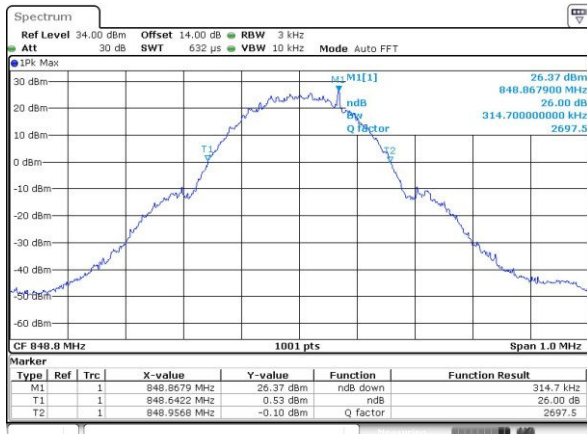

Date: 25 JUL 2017 08:41:26

Highest Channel

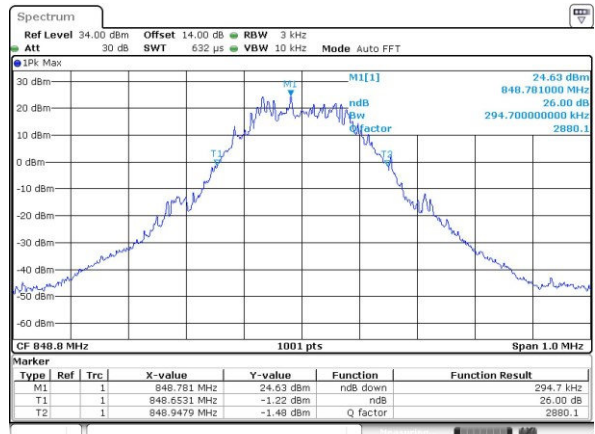

Date: 25 JUL 2017 09:38:22



GSM1900 (GSM)

Lowest Channel

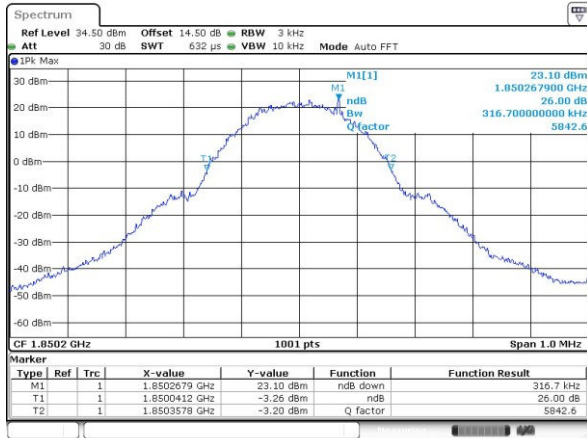

Date: 25 JUL 2017 09:53:35

GSM1900 (EDGE class 8)

Lowest Channel



Date: 25 JUL 2017 10:26:45

Middle Channel

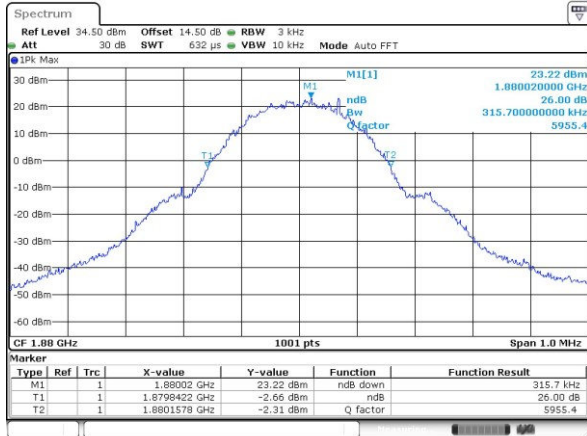

Date: 25 JUL 2017 09:54:03

Middle Channel

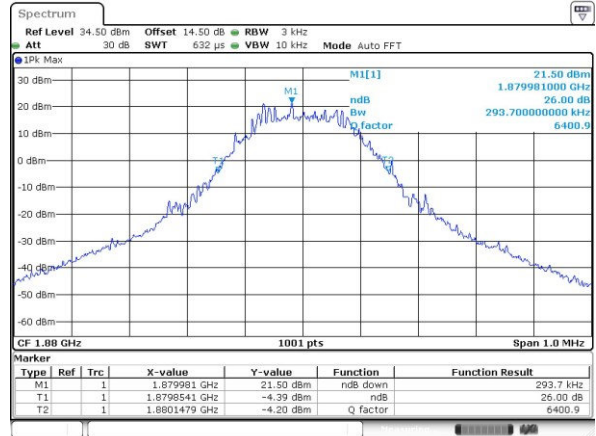

Date: 25 JUL 2017 10:28:44

Highest Channel

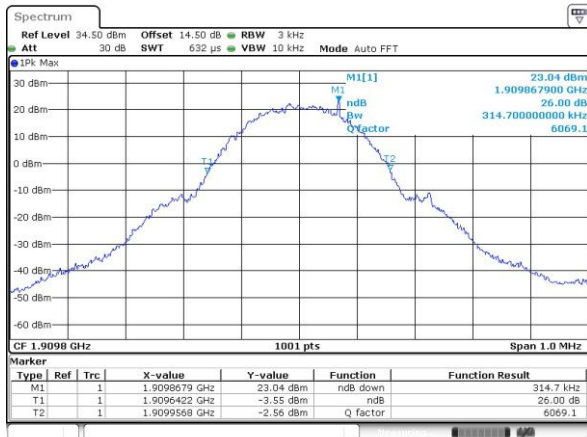

Date: 25 JUL 2017 09:54:31

Highest Channel

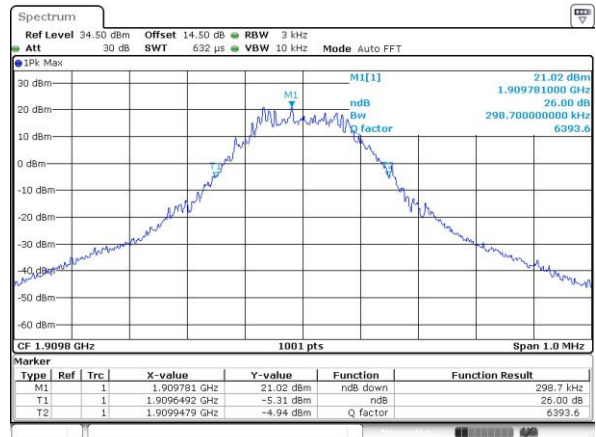

Date: 25 JUL 2017 10:31:22



WCDMA Band V (RMC 12.2Kbps)

Lowest Channel

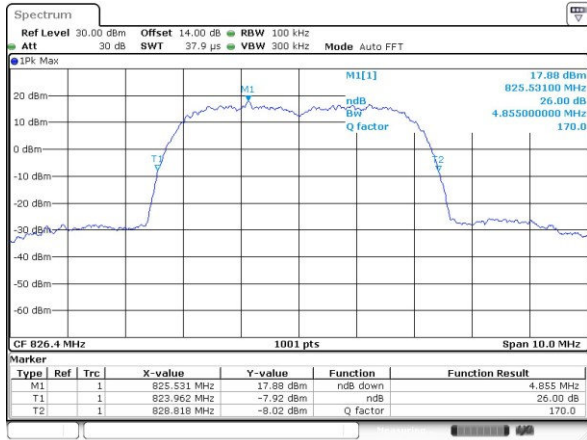

Date: 25 JUL 2017 11:07:57

WCDMA Band II (RMC 12.2Kbps)

Lowest Channel

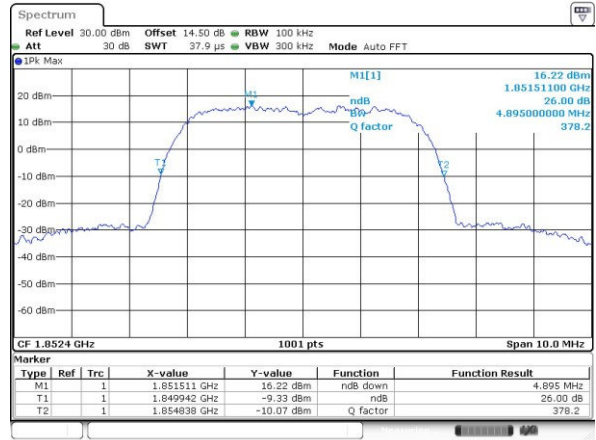

Date: 25 JUL 2017 10:53:09

Middle Channel

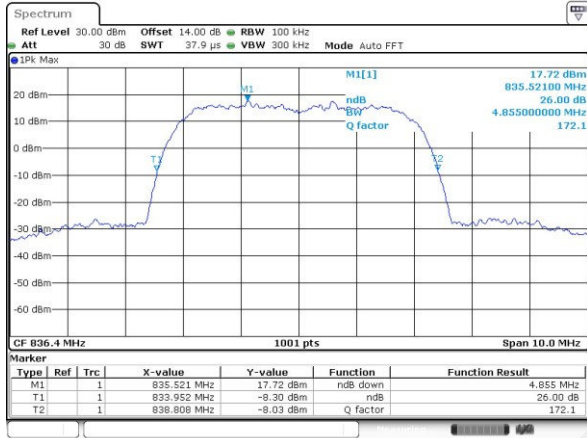

Date: 25 JUL 2017 11:08:25

Middle Channel

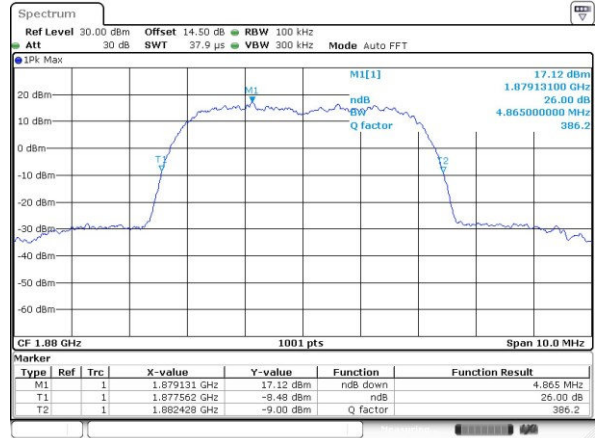

Date: 25 JUL 2017 10:53:36

Highest Channel

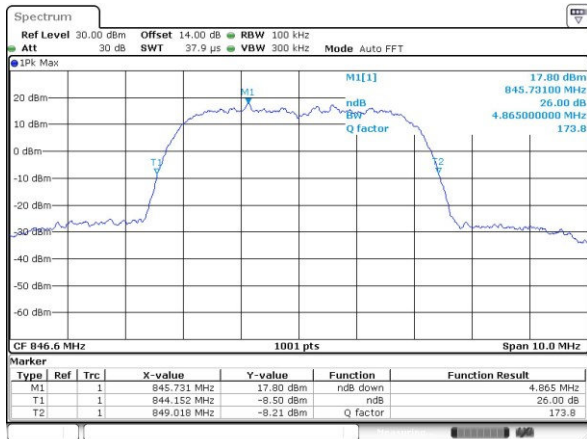

Date: 25 JUL 2017 11:08:53

Highest Channel

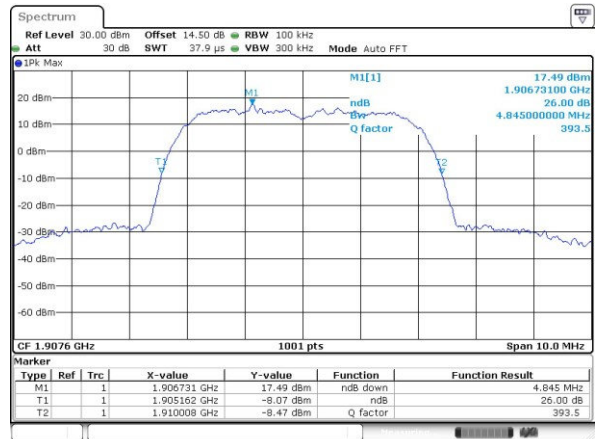

Date: 25 JUL 2017 10:54:04





### Occupied Bandwidth

Mode	GSM850(MHz)	
Mod.	GSM	EDGE class 8
Lowest CH	0.242	0.237
Middle CH	0.245	0.234
Highest CH	0.244	0.236

Mode	GSM1900(MHz)	
Mod.	GSM	EDGE class 8
Lowest CH	0.244	0.241
Middle CH	0.246	0.240
Highest CH	0.245	0.239

Mode	WCDMA Band V(MHz)	WCDMA Band II(MHz)
Mod.	RMC 12.2Kbps	RMC 12.2Kbps
Lowest CH	4.21	4.20
Middle CH	4.21	4.20
Highest CH	4.20	4.21



GSM850 (GSM)

Lowest Channel

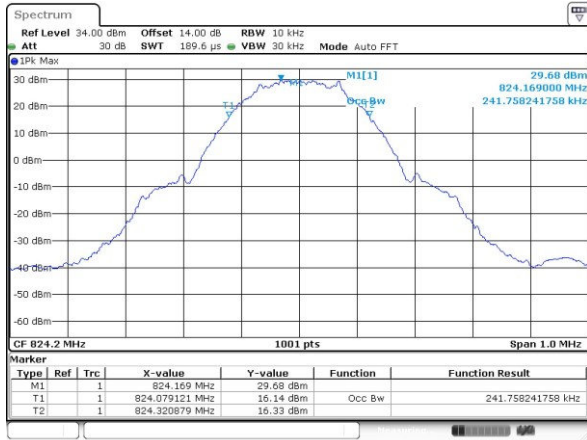

Date: 25 JUL 2017 08:43:03

GSM850 (EDGE class 8)

Lowest Channel

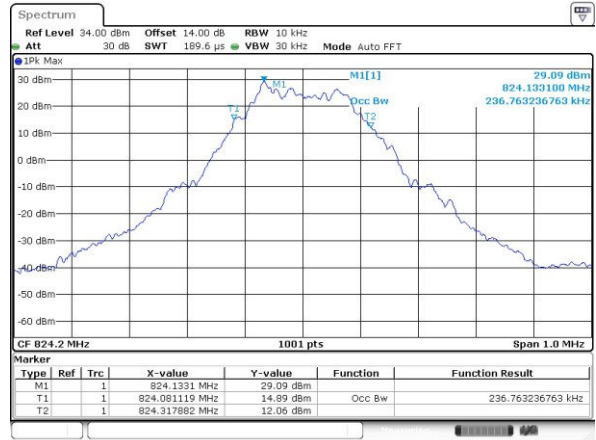

Date: 25 JUL 2017 09:40:25

Middle Channel

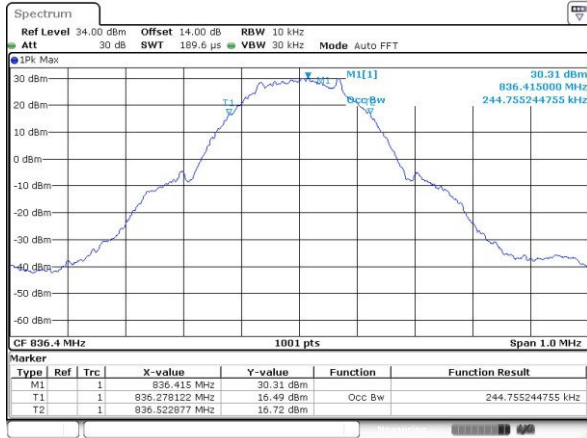

Date: 25 JUL 2017 08:43:31

Middle Channel

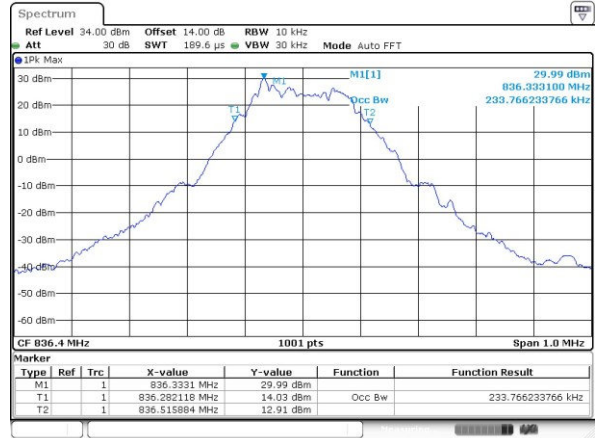

Date: 25 JUL 2017 09:41:00

Highest Channel

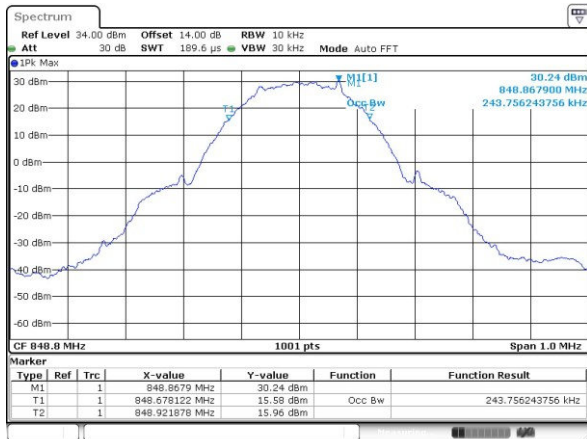

Date: 25 JUL 2017 08:43:59

Highest Channel

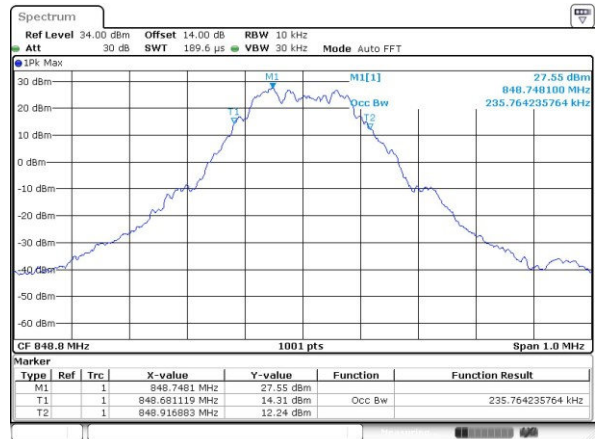

Date: 25 JUL 2017 09:41:35



GSM1900 (GSM)

Lowest Channel

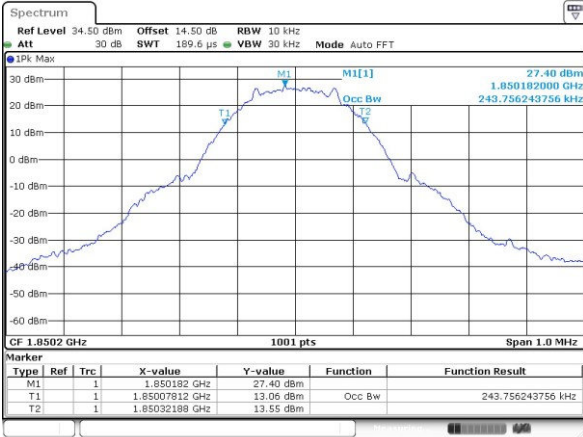

Date: 25 JUL 2017 09:55:05

GSM1900 (EDGE class 8)

Lowest Channel

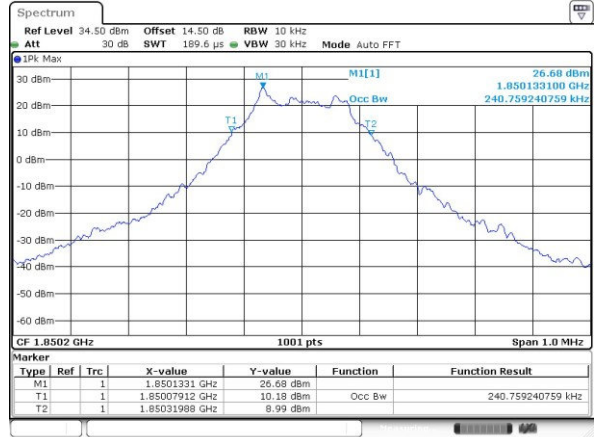

Date: 25 JUL 2017 10:32:55

Middle Channel

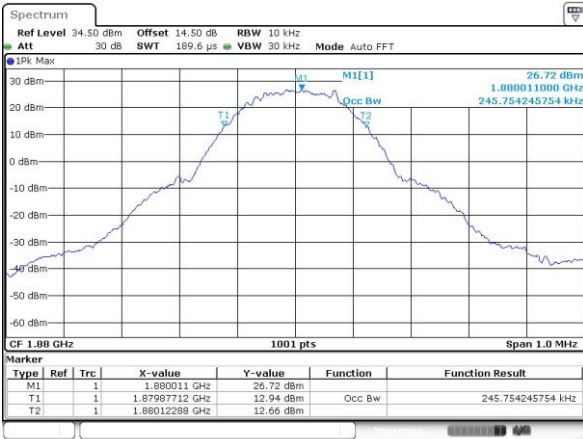

Date: 25 JUL 2017 09:55:33

Middle Channel

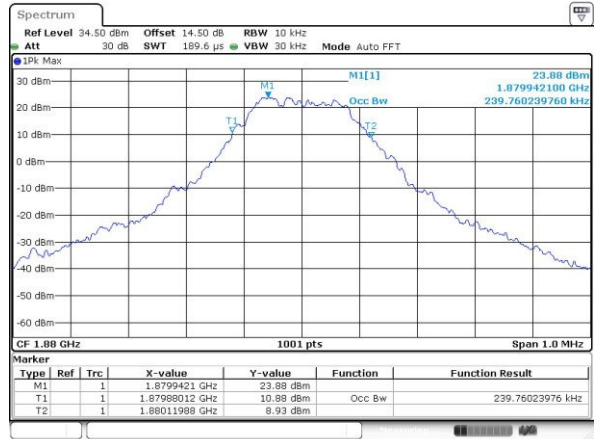

Date: 25 JUL 2017 10:33:34

Highest Channel

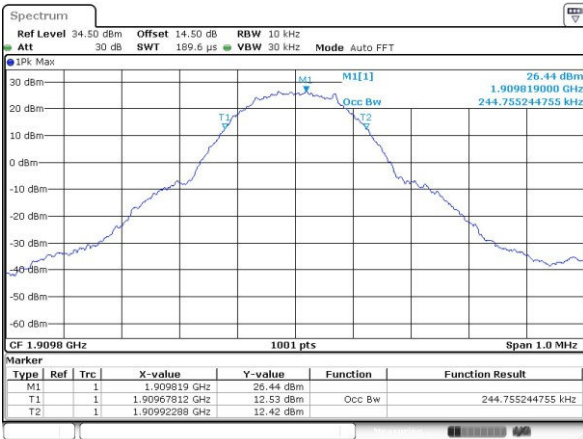

Date: 25 JUL 2017 09:56:01

Highest Channel

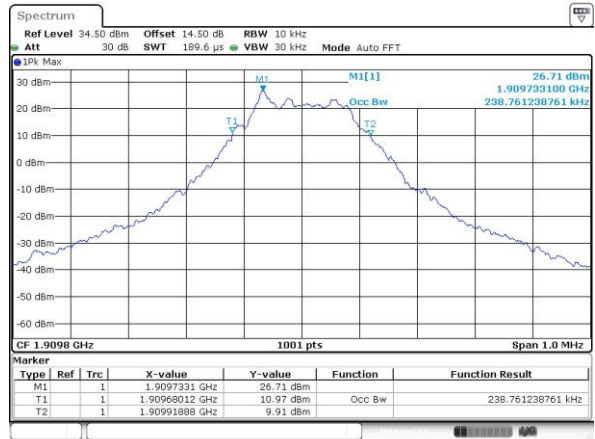

Date: 25 JUL 2017 10:34:11



WCDMA Band V (RMC 12.2Kbps)

Lowest Channel

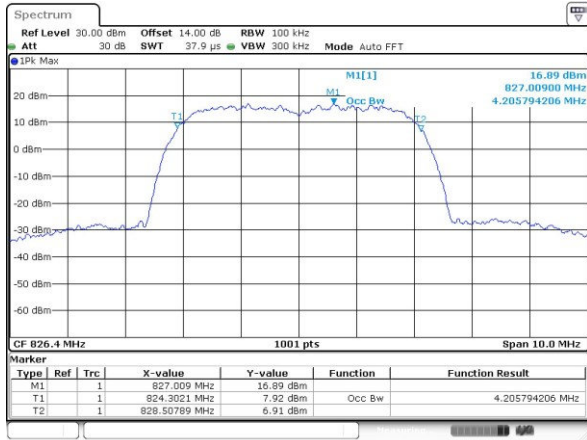

Date: 25 JUL 2017 11:09:28

WCDMA Band II (RMC 12.2Kbps)

Lowest Channel

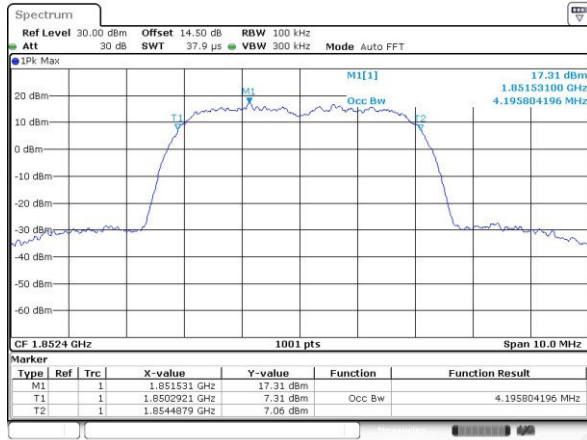

Date: 25 JUL 2017 10:55:18

Middle Channel

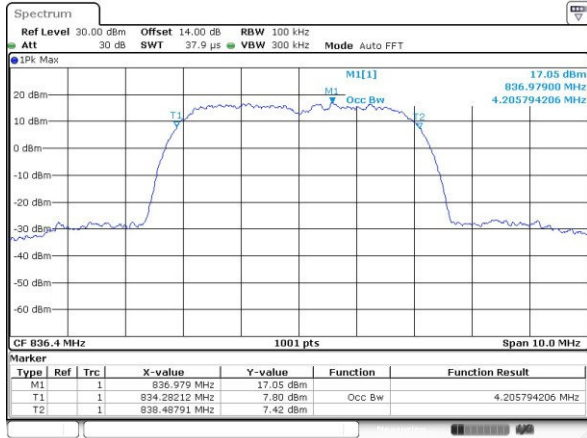

Date: 25 JUL 2017 11:09:56

Middle Channel

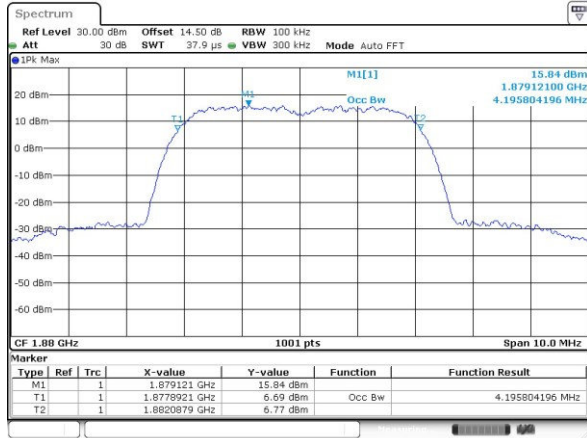

Date: 25 JUL 2017 10:55:46

Highest Channel

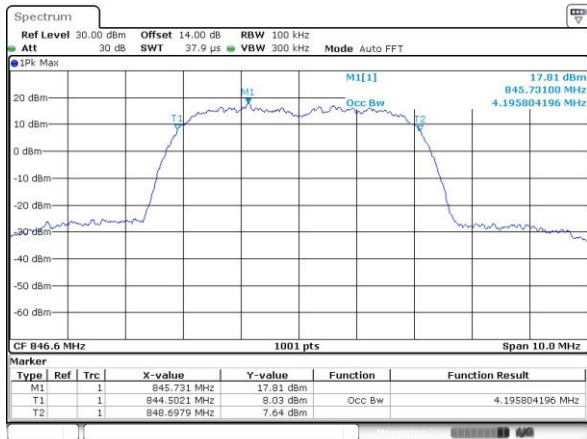

Date: 25 JUL 2017 11:10:24

Highest Channel

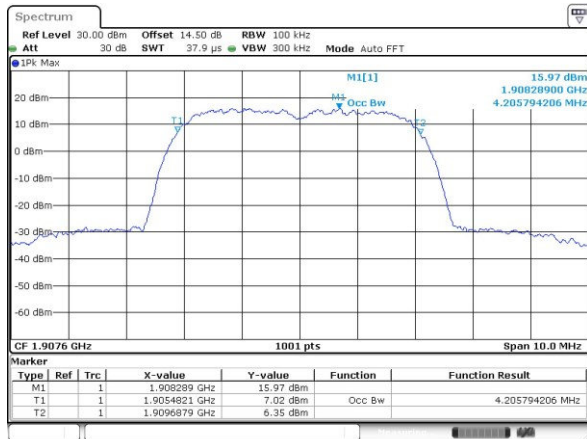

Date: 25 JUL 2017 10:56:14



# Conducted Band Edge

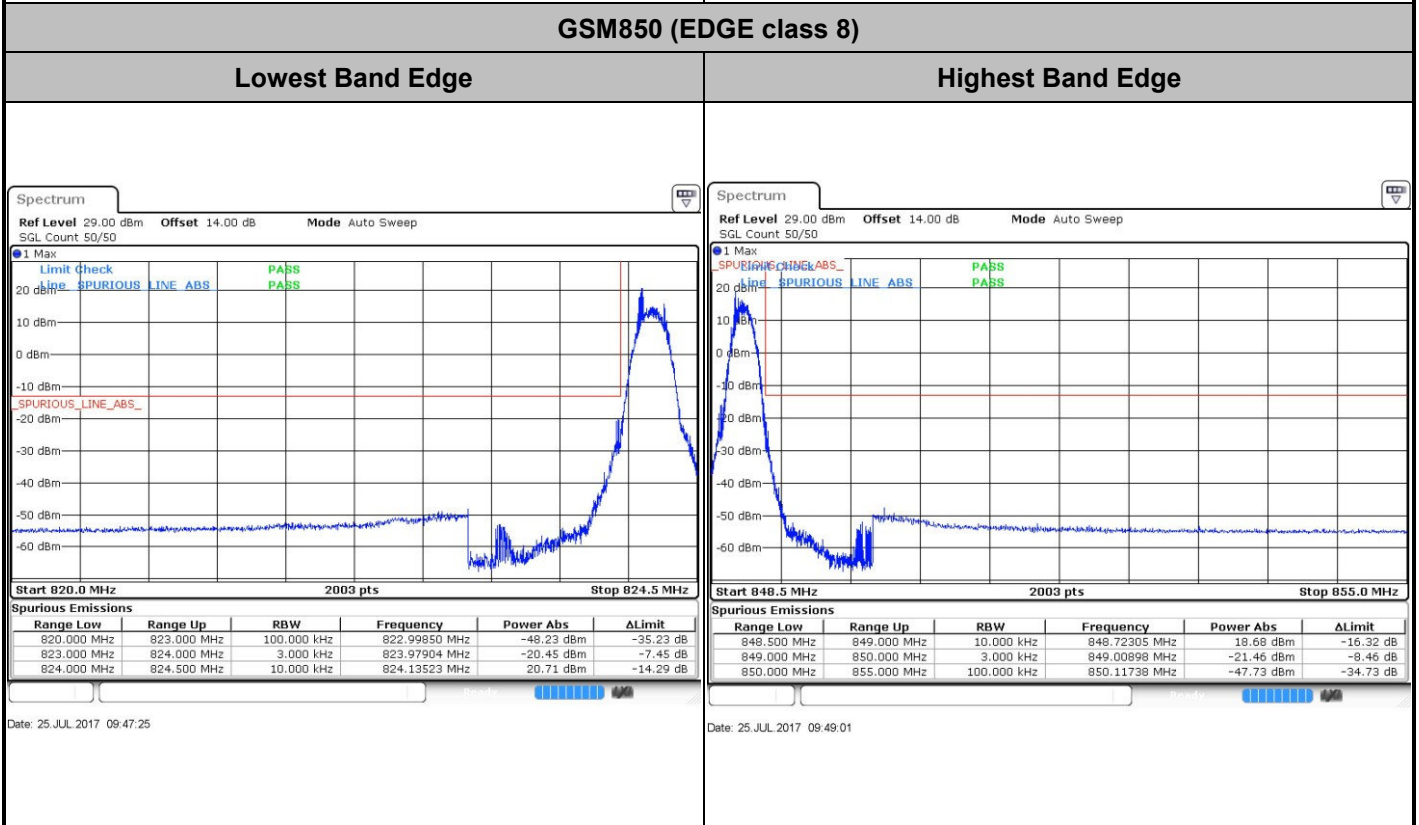
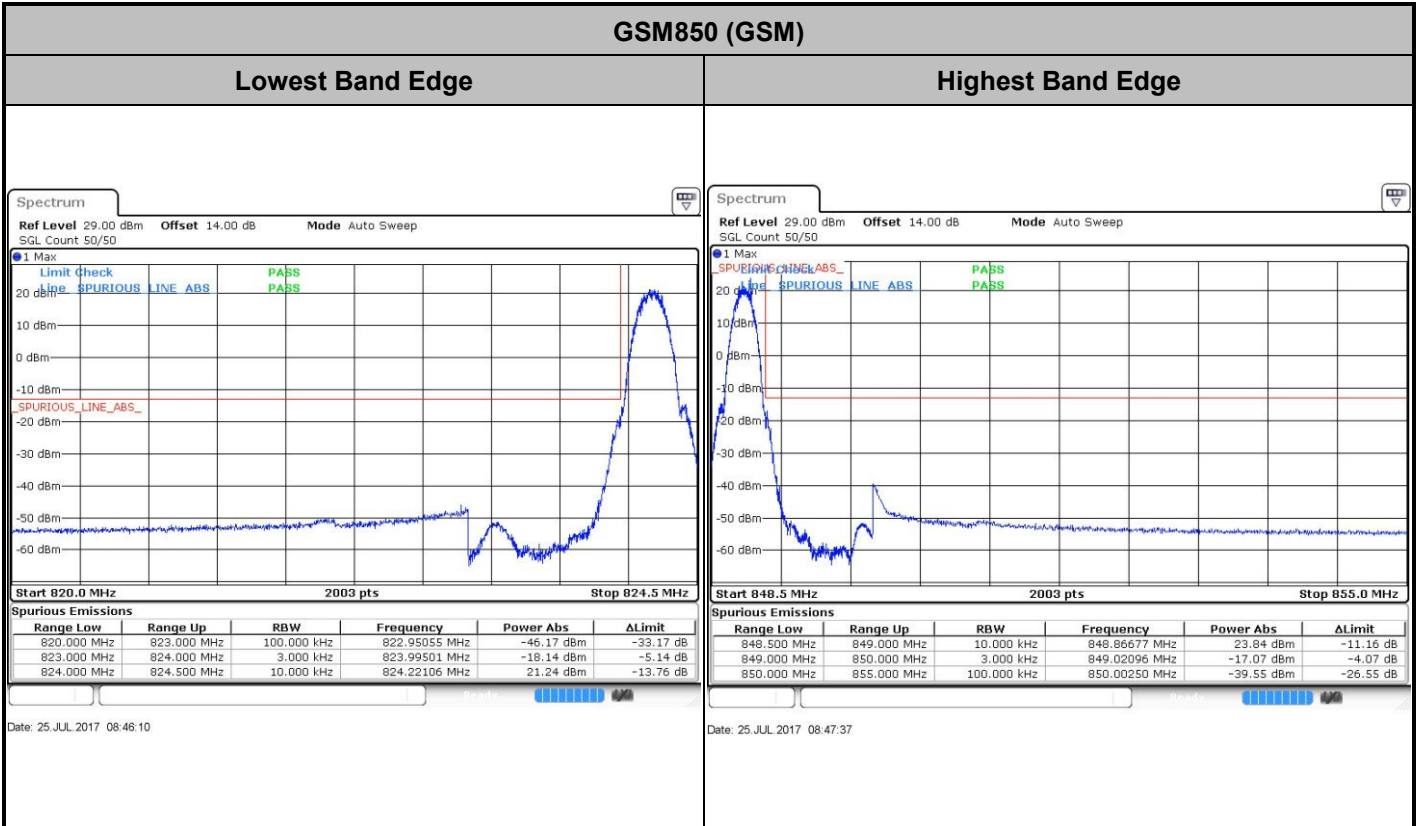



GSM1900 (GSM)

Lowest Band Edge

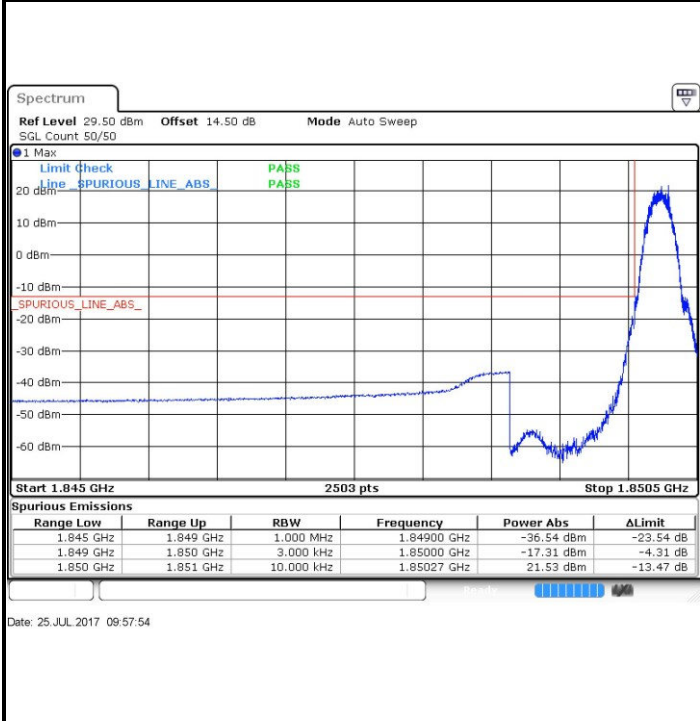

Highest Band Edge

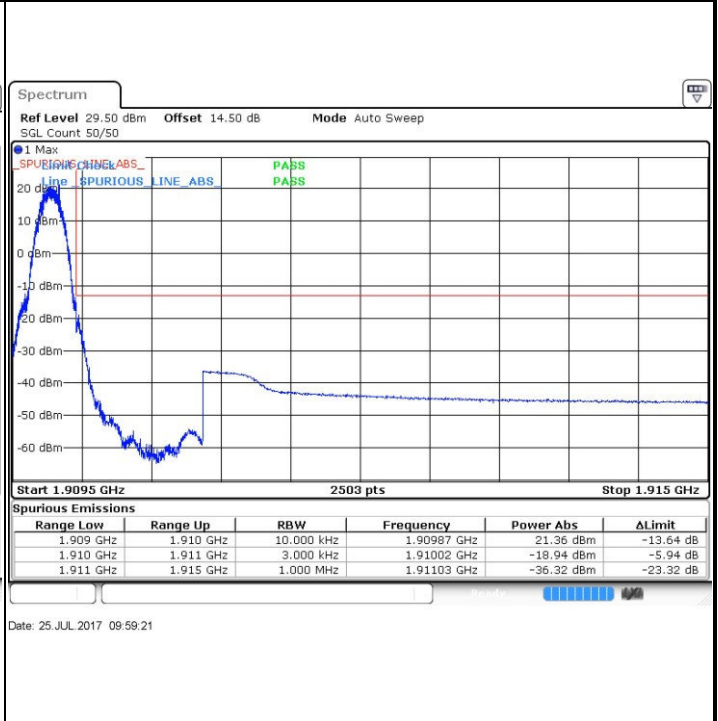

GSM1900 (EDGE class 8)

Lowest Band Edge

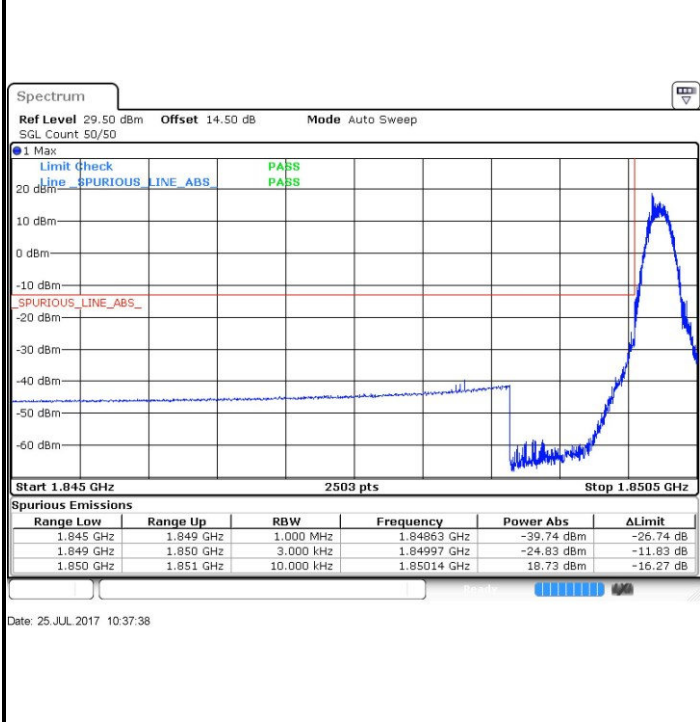

Highest Band Edge

