

SAR Test Report

Report No.: AGC00767190402FH01

FCC ID : 2ALTA4G001X
APPLICATION PURPOSE : Original Equipment
PRODUCT DESIGNATION : Smart phone
BRAND NAME : Avvio, Mint
MODEL NAME : 4G0, 4G0+, M342
CLIENT : Planet Avvio LLC
DATE OF ISSUE : May 16,2019
STANDARD(S) : IEEE Std. 1528:2013
FCC 47 CFR Part 2§2.1093:2013
IEEE C95.1TM:2005
REPORT VERSION : V1.0

Attestation of Global Compliance(Shenzhen) Co., Ltd.

CAUTION:

This report shall not be reproduced except in full without the written permission of the test laboratory and shall not be quoted out of context.



The results shown in this test report refer only to the sample(s) tested unless otherwise stated and the sample(s) are retained for 30 days only. The document is issued by AGC, this document cannot be reproduced except in full with our prior written permission. The more details and the authenticity of the report will be confirmed at <http://www.agc-cert.com>.

Report Revise Record

Report Version	Revise Time	Issued Date	Valid Version	Notes
V1.0	/	May 16,2019	Valid	Initial Release

The results shown in this test report refer only to the sample(s) tested unless otherwise stated and the sample(s) are retained for 30 days only. The document is issued by AGC, this document cannot be reproduced except in full with our prior written permission. The more details and the authenticity of the report will be confirmed at <http://www.agc-cert.com>.

Test Report

Applicant Name	Planet Avvio LLC
Applicant Address	8200 NW 33 ST suite 103 Doral, FL, 33122
Manufacturer Name	LAAGIN COMPANY LIMITED
Manufacturer Address	RM 1905 NAN FUNG CENTRE, 264-298 CASTLE PEAK ROAD, TSUEN WAN, HONG KONG 518000
Factory Name	Shenzhen Tensen Technology Co., LTD.
Factory Address	4th Floor, Yufeng Building, Jinhai Road No.6-9, Xixiang Street Bao'an District, Shenzhen
Product Designation	Smart phone
Brand Name	Avvio, Mint
Model Name	4GO, 4GO+, M342
Different Description	All the same except for brand name and model name, The corresponding relationships are as follows: Avvio is corresponding to 4GO, 4GO+; Mint is corresponding M342; the test model is 4GO.
EUT Voltage	DC3.7V by battery
Applicable Standard	IEEE Std. 1528:2013 FCC 47 CFR Part 2§2.1093:2013 IEEE C95.1TM:2005
Test Date	May 02,2019 to May 06,2019
Report Template	AGCRT-US-3G3/SAR (2018-01-01)

Note: The results of testing in this report apply to the product/system which was tested only.

Thea Huang

Tested By _____

Thea Huang (Huang Qianqian)

May 06,2019

Angela Li

Checked By _____

Angela Li(Li Jiao)

May 16,2019

Forrest Lei

Authorized By _____

Forrest Lei(Lei Yonggang)

Authorized Officer

May 16,2019

The results shown in this test report refer only to the sample(s) tested unless otherwise stated and the sample(s) are retained for 30 days only. The document is issued by AGC, this document cannot be reproduced except in full with our prior written permission. The more details and the authenticity of the report will be confirmed at <http://www.agc-cert.com>.

TABLE OF CONTENTS

1. SUMMARY OF MAXIMUM SAR VALUE 5

2. GENERAL INFORMATION 6

 2.1. EUT DESCRIPTION 6

3. SAR MEASUREMENT SYSTEM 8

 3.1. THE SATIMO SYSTEM USED FOR PERFORMING COMPLIANCE TESTS CONSISTS OF FOLLOWING ITEMS 8

 3.2. COMOSAR E-FIELD PROBE 9

 3.3. ROBOT 9

 3.4. VIDEO POSITIONING SYSTEM 10

 3.5. DEVICE HOLDER 10

 3.6. SAM TWIN PHANTOM 11

4. SAR MEASUREMENT PROCEDURE 12

 4.1. SPECIFIC ABSORPTION RATE (SAR) 12

 4.2. SAR MEASUREMENT PROCEDURE 13

 4.3. RF EXPOSURE CONDITIONS 15

5. TISSUE SIMULATING LIQUID 17

 5.1. THE COMPOSITION OF THE TISSUE SIMULATING LIQUID 17

 5.2. TISSUE DIELECTRIC PARAMETERS FOR HEAD AND BODY PHANTOMS 17

 5.3. TISSUE CALIBRATION RESULT 18

6. SAR SYSTEM CHECK PROCEDURE 20

 6.1. SAR SYSTEM CHECK PROCEDURES 20

 6.2. SAR SYSTEM CHECK 21

7. EUT TEST POSITION 22

 7.2. CHEEK POSITION 23

 7.3. TILT POSITION 23

 7.4. BODY WORN POSITION 24

8. SAR EXPOSURE LIMITS 25

9. TEST FACILITY 26

10. TEST EQUIPMENT LIST 27

11. MEASUREMENT UNCERTAINTY 28

12. CONDUCTED POWER MEASUREMENT 32

13. TEST RESULTS 42

 13.1. SAR TEST RESULTS SUMMARY 42

APPENDIX A. SAR SYSTEM CHECK DATA 54

APPENDIX B. SAR MEASUREMENT DATA 66

APPENDIX C. TEST SETUP PHOTOGRAPHS 92

APPENDIX D. CALIBRATION DATA 98

The results shown in this test report refer only to the sample(s) tested unless otherwise stated and the sample(s) are retained for 30 days only. The document is issued by AGC, this document cannot be reproduced except in full with our prior written permission. The more details and the authenticity of the report will be confirmed at <http://www.agc-cert.com>.

1. SUMMARY OF MAXIMUM SAR VALUE

The maximum results of Specific Absorption Rate (SAR) found during testing for EUT are as follows:

Frequency Band	Highest Reported 1g-SAR(W/Kg)		SAR Test Limit (W/Kg)
	Head	Body-worn	
GSM 850	0.280	1.081	1.6
PCS 1900	0.018	0.723	
UMTS Band II	0.031	0.551	
UMTS Band V	0.050	0.255	
WIFI 2.4G	0.301	0.210	
Simultaneous Reported SAR	1.251		
SAR Test Result	PASS		

This device is compliance with Specific Absorption Rate (SAR) for general population/uncontrolled exposure limits (1.6W/Kg) specified in IEEE Std. 1528:2013; FCC 47CFR § 2.1093; IEEE/ANSI C95.1:2005 and the following specific FCC Test Procedures:

- KDB 447498 D01 General RF Exposure Guidance v06
- KDB 648474 D04 Handset SAR v01r03
- KDB 865664 D01 SAR Measurement 100MHz to 6GHz v01r04
- KDB 941225 D01 3G SAR Procedures v03r01
- KDB 941225 D06 Hotspot Mode v02r01
- KDB 248227 D01 802 11 Wi-Fi SAR v02r02

The results shown in this test report refer only to the sample(s) tested unless otherwise stated and the sample(s) are retained for 30 days only. The document is issued by AGC, this document cannot be reproduced except in full with our prior written permission. The more details and the authenticity of the report will be confirmed at <http://www.agc-cert.com>.

2. GENERAL INFORMATION

2.1. EUT Description

General Information	
Product Designation	Smart phone
Test Model	4GO
Hardware Version	K200-PW-V2.0
Software Version	Avvio_4GO_Claro_v2.00
Device Category	Portable
RF Exposure Environment	Uncontrolled
Antenna Type	Internal
GSM and GPRS& EGPRS	
Support Band	<input checked="" type="checkbox"/> GSM 850 <input checked="" type="checkbox"/> PCS 1900 <input checked="" type="checkbox"/> GSM 900 <input checked="" type="checkbox"/> DCS 1800
GPRS & EGPRS Type	Class B
GPRS & EGPRS Class	Class 12(1Tx+4Rx, 2Tx+3Rx, 3Tx+2Rx, 4Tx+1Rx)
TX Frequency Range	GSM 850 : 820-850MHz;; PCS 1900: 1850-1910MHz;
RX Frequency Range	GSM 850 : 869~894MHz; PCS 1900: 1930~1990MHz
Release Version	R99
Type of modulation	GMSK for GSM/GPRS; GMSK & 8-PSK for EGPRS
Antenna Gain	GSM850:1.52dBi; PCS1900: 1.2dBi;
Max. Average Power	GSM850: 32.46dBm ;PCS1900: 31.71dBm
WCDMA	
Support Band	<input checked="" type="checkbox"/> UMTS FDD Band II <input checked="" type="checkbox"/> UMTS FDD Band V <input type="checkbox"/> UMTS FDD Band I <input type="checkbox"/> UMTS FDD Band VIII
HS Type	HSPA(HSUPA/HSDPA)
TX Frequency Range	WCDMA FDD Band II: 1850-1910MHz; WCDMA FDD Band V: 820-850MHz
RX Frequency Range	WCDMA FDD Band II: 1930-1990MHz; WCDMA FDD Band V: 869-894MHz
Release Version	Rel-6
Type of modulation	HSDPA:QPSK/16QAM; HSUPA:BPSK; WCDMA:QPSK
Antenna Gain	WCDMA850: 1.30dBi; WCDMA1900:1.2dBi;
Max. Average Power	Band II: 23.74dBm; Band V: 23.55dBm

The results shown in this test report refer only to the sample(s) tested unless otherwise stated and the sample(s) are retained for 30 days only. The document is issued by AGC, this document cannot be reproduced except in full with our prior written permission. The more details and the authenticity of the report will be confirmed at <http://www.agc-cert.com>.

EUT Description(Continue)

Bluetooth	
Bluetooth Version	BR/EDR,BLE
Operation Frequency	2402~2480MHz
Type of modulation	GFSK, $\pi/4$ -DQPSK,8-DPSK
Avg. Burst Power	BR/EDR:0.969 dBm; BLE:1.065dBm
Antenna Gain	1.0dBi
WIFI	
WIFI Specification	<input type="checkbox"/> 802.11a <input checked="" type="checkbox"/> 802.11b <input checked="" type="checkbox"/> 802.11g <input checked="" type="checkbox"/> 802.11n(20) <input checked="" type="checkbox"/> 802.11n(40)
Operation Frequency	2412~2462MHz
Avg. Burst Power	11b:11.79dBm,11g:9.66dBm,11n(20):9.65dBm,11n(40):9.19dBm
Antenna Gain	1.0dBi
Accessories	
Battery	Brand name: Avvio, Mint Model No. : 4GO, 4GO+, M342 Voltage and Capacitance: 3.7 V & 1450mAh
Earphone	Brand name: N/A Model No. : N/A

Note:1.CMU200 can measure the average power and Peak power at the same time
 2.The sample used for testing is end product.

Product	Type
	<input checked="" type="checkbox"/> Production unit <input type="checkbox"/> Identical Prototype

The results shown in this test report refer only to the sample(s) tested unless otherwise stated and the sample(s) are retained for 30 days only. The document is issued by AGC, this document cannot be reproduced except in full with our prior written permission. The more details and the authenticity of the report will be confirmed at <http://www.agc-cert.com>.

3. SAR MEASUREMENT SYSTEM

3.1. The SATIMO system used for performing compliance tests consists of following items

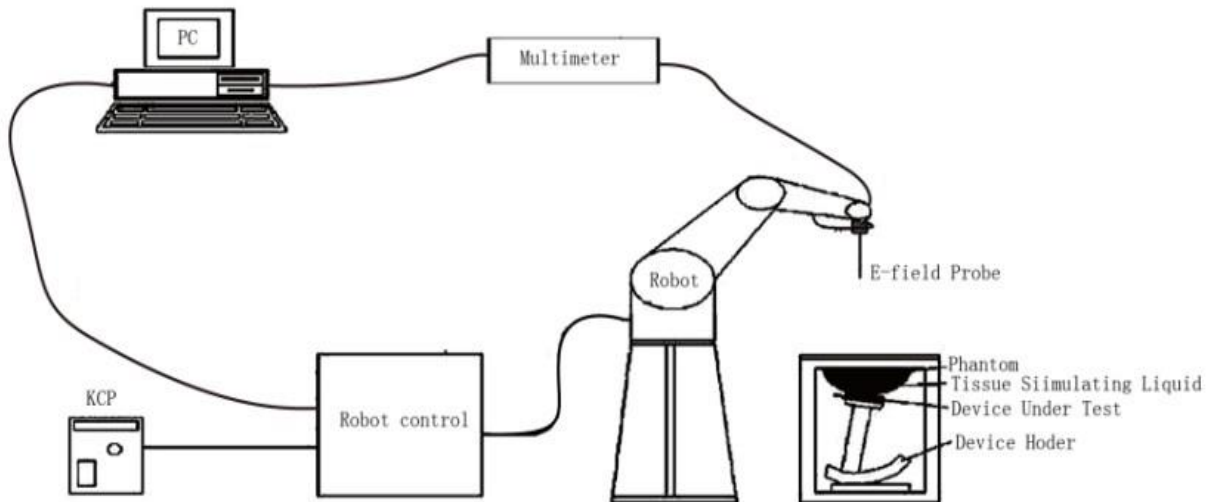

The COMOSAR system for performing compliance tests consists of the following items:

- The PC. It controls most of the bench devices and stores measurement data. A computer running WinXP and the Opensar software.
- The E-Field probe. The probe is a 3-axis system made of 3 distinct dipoles. Each dipole returns a voltage in function of the ambient electric field.
- The Keithley multimeter measures each probe dipole voltages.
- The SAM phantom simulates a human head. The measurement of the electric field is made inside the phantom.
- The liquids simulate the dielectric properties of the human head tissues.
- The network emulator controls the mobile phone under test.
- The validation dipoles are used to measure a reference SAR. They are used to periodically check the bench to make sure that there is no drift of the system characteristics over time.
- The phantom, the device holder and other accessories according to the targeted measurement.

The results shown in this test report refer only to the sample(s) tested unless otherwise stated and the sample(s) are retained for 30 days only. The document is issued by AGC, this document cannot be reproduced except in full with our prior written permission. The more details and the authenticity of the report will be confirmed at <http://www.agc-cert.com>.

3.2. COMOSAR E-Field Probe

The SAR measurement is conducted with the dosimetric probe manufactured by SATIMO. The probe is specially designed and calibrated for use in liquid with high permittivity. The dosimetric probe has special calibration in liquid at different frequency. SATIMO conducts the probe calibration in compliance with international and national standards (e.g. IEEE 1528 and relevant KDB files.) The calibration data are in Appendix D.

Isotropic E-Field Probe Specification

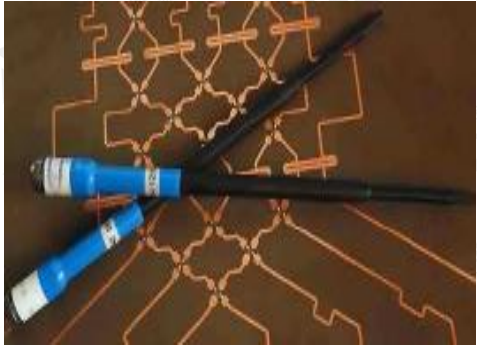
Model	SSE5	
Manufacture	MVG	
Identification No.	SN 22/12 EP159	
Frequency	0.45GHz-3GHz Linearity:±0.11dB(0.45GHz-3GHz)	
Dynamic Range	0.01W/Kg-100W/Kg Linearity:±0.11dB	
Dimensions	Overall length:330mm Length of individual dipoles:4.5mm Maximum external diameter:8mm Probe Tip external diameter:5mm Distance between dipoles/ probe extremity:2.7mm	
Application	High precision dosimetric measurements in any exposure scenario (e.g., very strong gradient fields). Only probe which enables compliance testing for frequencies up to 3 GHz with precision of better 30%.	

3.3. Robot

The COMOSAR system uses the KUKA robot from SATIMO SA (France). For the 6-axis controller COMOSAR system, the KUKA robot controller version from SATIMO is used.

The XL robot series have many features that are important for our application:

- High precision (repeatability 0.02 mm)
- High reliability (industrial design)
- Jerk-free straight movements
- Low ELF interference (the closed metallic construction shields against motor control fields)
- 6-axis controller



The results shown in this test report refer only to the sample(s) tested unless otherwise stated and the sample(s) are retained for 30 days only. The document is issued by AGC, this document cannot be reproduced except in full with our prior written permission. The more details and the authenticity of the report will be confirmed at <http://www.agc-cert.com>.

3.4. Video Positioning System

The video positioning system is used in OpenSAR to check the probe. Which is composed of a camera, LED, mirror and mechanical parts. The camera is piloted by the main computer with firewire link. During the process, the actual position of the probe tip with respect to the robot arm is measured, as well as the probe length and the horizontal probe offset. The software then corrects all movements, such that the robot coordinates are valid for the probe tip. The repeatability of this process is better than 0.1 mm. If a position has been taught with an aligned probe, the same position will be reached with another aligned probe within 0.1 mm, even if the other probe has different dimensions. During probe rotations, the probe tip will keep its actual position.

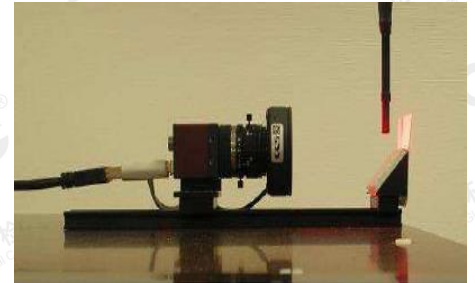

3.5. Device Holder

The COMOSAR device holder is designed to cope with different positions given in the standard. It has two scales for the device rotation (with respect to the body axis) and the device inclination (with respect to the line between the ear reference points). The rotation center for both scales is the ear reference point (EPR). Thus the device needs no repositioning when changing the angles. The COMOSAR device holder has been made out of low-loss POM material having the following dielectric parameters: relative permittivity $\epsilon_r = 3$ and loss tangent $\delta = 0.02$. The amount of dielectric material has been reduced in the closest vicinity of the device, since measurements have suggested that the influence of the clamp on the test results could thus be lowered.

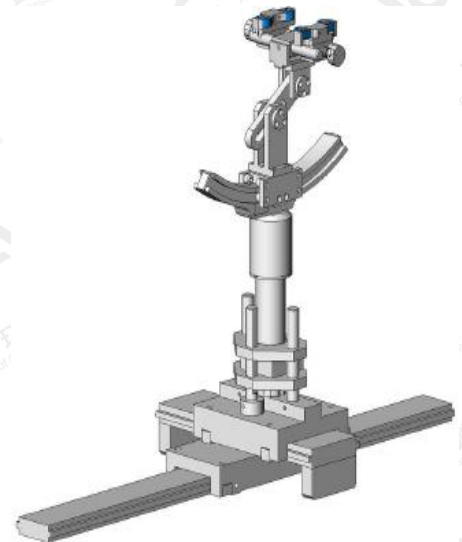

The results shown in this test report refer only to the sample(s) tested unless otherwise stated and the sample(s) are retained for 30 days only. The document is issued by AGC, this document cannot be reproduced except in full with our prior written permission. The more details and the authenticity of the report will be confirmed at <http://www.agc-cert.com>.

3.6. SAM Twin Phantom

The SAM twin phantom is a fiberglass shell phantom with 2mm shell thickness (except the ear region where shell thickness increases to 6mm). It has three measurement areas:

- Left head
- Right head
- Flat phantom



The bottom plate contains three pair of bolts for locking the device holder. The device holder positions are adjusted to the standard measurement positions in the three sections. A white cover is provided to tap the phantom during off-periods to prevent water evaporation and changes in the liquid parameters. On the phantom top, three reference markers are provided to identify the phantom position with respect to the robot.

The results shown in this test report refer only to the sample(s) tested unless otherwise stated and the sample(s) are retained for 30 days only. The document is issued by AGC, this document cannot be reproduced except in full with our prior written permission. The more details and the authenticity of the report will be confirmed at <http://www.agc-cert.com>.

4. SAR MEASUREMENT PROCEDURE

4.1. Specific Absorption Rate (SAR)

SAR is related to the rate at which energy is absorbed per unit mass in object exposed to a radio field. The SAR distribution in a biological body is complicated and is usually carried out by experimental techniques or numerical modeling. The standard recommends limits for two tiers of groups, occupational/controlled and occupational/uncontrolled, based on a person's awareness and ability to exercise control over his or her exposure. In general, occupational/controlled exposure limits are higher than the limits for general population/uncontrolled.

The SAR definition is the time derivative (rate) of the incremental energy (dW) absorbed by (dissipated in) an incremental mass (dm) contained in a volume element(dv) of given mass density (ρ). The equation description is as below:

$$SAR = \frac{d}{dt} \left(\frac{dW}{dm} \right) = \frac{d}{dt} \left(\frac{dW}{\rho dV} \right)$$

SAR is expressed in units of Watts per kilogram (W/Kg)

SAR can be obtained using either of the following equations:

$$SAR = \frac{\sigma E^2}{\rho}$$

$$SAR = c_h \left. \frac{dT}{dt} \right|_{t=0}$$

Where

SAR	is the specific absorption rate in watts per kilogram;
E	is the r.m.s. value of the electric field strength in the tissue in volts per meter;
σ	is the conductivity of the tissue in siemens per metre;
ρ	is the density of the tissue in kilograms per cubic metre;
Ch	is the heat capacity of the tissue in joules per kilogram and Kelvin;
$\left. \frac{dT}{dt} \right _{t=0}$	is the initial time derivative of temperature in the tissue in kelvins per second

4.2. SAR Measurement Procedure

Step 1: Power Reference Measurement

The Power Reference Measurement and Power Drift Measurement are for monitoring the power drift of the device under test in the batch process. The minimum distance of probe sensors to surface is 2.7mm This distance cannot be smaller than the distance os sensor calibration points to probe tip as `defined in the probe properties,

Step 2: Area Scan

The Area Scan is used as a fast scan in two dimensions to find the area of high field values, before doing a fine measurement around the hot spot. The sophisticated interpolation routines implemented in SATIMO software can find the maximum locations even in relatively coarse grids. When an Area Scan has measured all reachable points, it computes the field maximal found in the scanned area, within a range of the global maximum. The range (in db) is specified in the standards for compliance testing. For example, a 2db range is required in IEEE Standard 1528, whereby 3db is a requirement when compliance is assessed in accordance with the ARIB standard (Japan) If one Zoom Scan follows the Area Scan, then only the absolute maximum will be taken as reference. For cases where multiple maximum are detected, the number of Zoom Scan has to be increased accordingly.

Area Scan Parameters extracted from KDB 865664 D01 SAR Measurement 100MHz to 6GHz

	≤ 3 GHz	> 3 GHz
Maximum distance from closest measurement point (geometric center of probe sensors) to phantom surface	5 ± 1 mm	$\frac{1}{2} \cdot \delta \cdot \ln(2) \pm 0.5 \text{ mm}$
Maximum probe angle from probe axis to phantom surface normal at the measurement location	30° ± 1°	20° ± 1°
Maximum area scan spatial resolution: $\Delta x_{\text{Area}}, \Delta y_{\text{Area}}$	≤ 2 GHz: ≤ 15 mm 2 – 3 GHz: ≤ 12 mm	3 – 4 GHz: ≤ 12 mm 4 – 6 GHz: ≤ 10 mm
	When the x or y dimension of the test device, in the measurement plane orientation, is smaller than the above, the measurement resolution must be ≤ the corresponding x or y dimension of the test device with at least one measurement point on the test device.	

Step 3: Zoom Scan

Zoom Scan are used to assess the peak spatial SAR value within a cubic average volume containing 1g abd 10g of simulated tissue. The Zoom Scan measures points(refer to table below) within a cube whose base faces are centered on the maxima found in a preceding area scan job within the same procedure. When the measurement is done, the Zoom Scan evaluates the averaged SAR for 1g and 10g and displays these values next to the job's label.

The results shown in this test report refer only to the sample(s) tested unless otherwise stated and the sample(s) are retained for 30 days only. The document is issued by AGC, this document cannot be reproduced except in full with our prior written permission. The more details and the authenticity of the report will be confirmed at <http://www.agc-cert.com>.

Zoom Scan Parameters extracted from KDB865664 d01 SAR Measurement 100MHz to 6GHz

Maximum zoom scan spatial resolution: Δx_{Zoom} , Δy_{Zoom}		≤ 2 GHz: ≤ 8 mm 2 – 3 GHz: ≤ 5 mm*	3 – 4 GHz: ≤ 5 mm* 4 – 6 GHz: ≤ 4 mm*
Maximum zoom scan spatial resolution, normal to phantom surface	uniform grid: $\Delta z_{Zoom}(n)$	≤ 5 mm	3 – 4 GHz: ≤ 4 mm 4 – 5 GHz: ≤ 3 mm 5 – 6 GHz: ≤ 2 mm
	graded grid	$\Delta z_{Zoom}(1)$: between 1 st two points closest to phantom surface	≤ 4 mm
		$\Delta z_{Zoom}(n>1)$: between subsequent points	$\leq 1.5 \cdot \Delta z_{Zoom}(n-1)$
Minimum zoom scan volume	x, y, z	≥ 30 mm	3 – 4 GHz: ≥ 28 mm 4 – 5 GHz: ≥ 25 mm 5 – 6 GHz: ≥ 22 mm
<p>Note: δ is the penetration depth of a plane-wave at normal incidence to the tissue medium; see draft standard IEEE P1528-2011 for details.</p> <p>* When zoom scan is required and the <i>reported</i> SAR from the <i>area scan based 1-g SAR estimation</i> procedures of KDB 447498 is ≤ 1.4 W/kg, ≤ 8 mm, ≤ 7 mm and ≤ 5 mm zoom scan resolution may be applied, respectively, for 2 GHz to 3 GHz, 3 GHz to 4 GHz and 4 GHz to 6 GHz.</p>			

Step 4: Power Drift Measurement

The Power Drift Measurement measures the field at the same location as the most recent power reference measurement within the same procedure, and with the same settings. The Power Drift Measurement gives the field difference in dB from the reading conducted within the same settings. This allows a user to monitor the power drift of the device under test within a batch process. The measurement procedure is the same as Step 1.

The results shown in this test report refer only to the sample(s) tested unless otherwise stated and the sample(s) are retained for 30 days only. The document is issued by AGC, this document cannot be reproduced except in full with our prior written permission. The more details and the authenticity of the report will be confirmed at <http://www.agc-cert.com>.

4.3. RF Exposure Conditions

Test Configuration and setting:

The EUT is a model of GSM/WCDMA Portable Mobile Station (MS). It supports GSM/GPRS/EGPRS, WCDMA/HSPA, BT, WIFI, and support hot spot mode.

For WWAN SAR testing, the device was controlled by using a base station emulator. Communication between the device and the emulator were established by air link. The distance between the EUT and the antenna is larger than 50cm, and the output power radiated from the emulator antenna is at least 30db smaller than the output power of EUT.

For WLAN testing, the EUT is configured with the WLAN continuous TX tool through engineering command.

Antenna Location: (the back view)

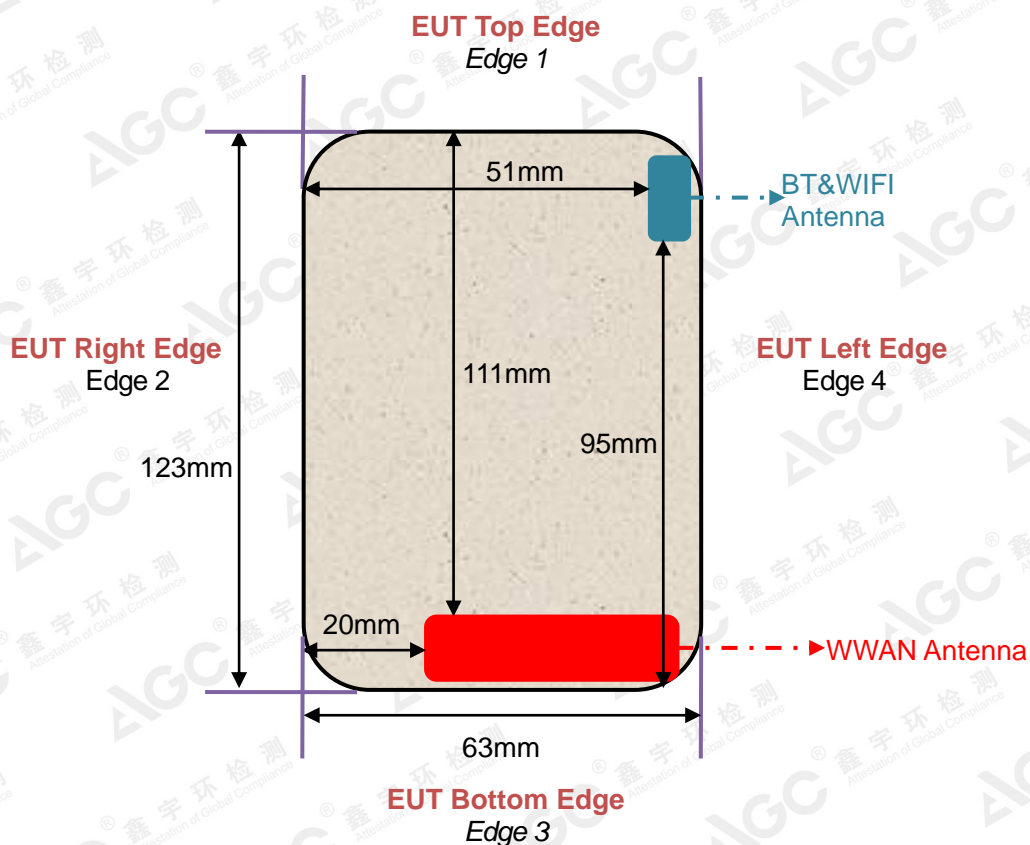

The results shown in this test report refer only to the sample(s) tested unless otherwise stated and the sample(s) are retained for 30 days only. The document is issued by AGC, this document cannot be reproduced except in full with our prior written permission. The more details and the authenticity of the report will be confirmed at <http://www.agc-cert.com>.

For WWAN mode:

Test Configurations	Antenna to edges/surface	SAR required	Note
Head			
Left Touch		Yes	--
Left Tilt		Yes	--
Right Touch		Yes	--
Right Tilt		Yes	--
Body			
Back	<25mm	Yes	--
Front	<25mm	Yes	--
Hotspot			
Back	<25mm	Yes	--
Front	<25mm	Yes	--
Edge 1 (Top)	111mm	No	SAR is not required for the distance between the antenna and the edge is >25mm as per KDB 941225 D06 Hotspot SAR
Edge 2 (Right)	20mm	Yes	--
Edge 3 (Bottom)	1mm	Yes	--
Edge 4 (Left)	2mm	Yes	--

For WLAN mode:

Test Configurations	Antenna to edges/surface	SAR required	Note
Head			
Left Touch		Yes	--
Left Tilt		Yes	--
Right Touch		Yes	--
Right Tilt		Yes	--
Body			
Back	<25mm	Yes	--
Front	<25mm	Yes	--
Hotspot			
Back	<25mm	Yes	--
Front	<25mm	Yes	--
Edge 1 (Top)	1mm	Yes	--
Edge 2 (Right)	51mm	No	SAR is not required for the distance between the antenna and the edge is >25mm as per KDB 941225 D06 Hotspot SAR
Edge 3 (Bottom)	95mm	No	SAR is not required for the distance between the antenna and the edge is >25mm as per KDB 941225 D06 Hotspot SAR
Edge 4 (Left)	1mm	Yes	--

The results shown in this test report refer only to the sample(s) tested unless otherwise stated and the sample(s) are retained for 30 days only. The document is issued by AGC, this document cannot be reproduced except in full with our prior written permission. The more details and the authenticity of the report will be confirmed at <http://www.agc-cert.com>.

5. TISSUE SIMULATING LIQUID

For SAR measurement of the field distribution inside the phantom, the phantom must be filled with homogeneous tissue simulating liquid to a depth of at least 15cm. For head SAR testing the liquid height from the ear reference point (ERP) of the phantom to the liquid top surface is larger than 15cm For body SAR testing, the liquid height from the center of the flat phantom to the liquid top surface is larger than 15cm. The nominal dielectric values of the tissue simulating liquids in the phantom and the tolerance of 5% are listed in 5.2

5.1. The composition of the tissue simulating liquid

Ingredient (% Weight) Frequency (MHz)	Water	Nacl	Polysorbate 20	DGBE	1,2 Propanediol	Triton X-100
835 Head	50.36	1.25	48.39	0.0	0.0	0.0
835 Body	54.00	1	0.0	15	0.0	30
1900 Head	54.9	0.18	0.0	44.92	0.0	0.0
1900 Body	70	1	0.0	9	0.0	20
2450 Head	71.88	0.16	0.0	7.99	0.0	19.97
2450 Body	70	1	0.0	9	0.0	20

5.2. Tissue Dielectric Parameters for Head and Body Phantoms

The head tissue dielectric parameters recommended by the IEEE 1528 have been incorporated in the following table. These head parameters are derived from planar layer models simulating the highest expected SAR for the dielectric properties and tissue thickness variations in a human head. Other head and body tissue parameters that have not been specified in IEEE 1528 are derived from the tissue dielectric parameters computed from the 4-Cole-Cole equations described in Reference [12] and extrapolated according to the head parameters specified in IEEE 1528.

Target Frequency (MHz)	head		body	
	ϵ_r	σ (S/m)	ϵ_r	σ (S/m)
300	45.3	0.87	58.2	0.92
450	43.5	0.87	56.7	0.94
835	41.5	0.90	55.2	0.97
900	41.5	0.97	55.0	1.05
915	41.5	1.01	55.0	1.06
1450	40.5	1.20	54.0	1.30
1610	40.3	1.29	53.8	1.40
1800 – 2000	40.0	1.40	53.3	1.52
2450	39.2	1.80	52.7	1.95
3000	38.5	2.40	52.0	2.73

(ϵ_r = relative permittivity, σ = conductivity and $\rho = 1000 \text{ kg/m}^3$)

The results shown in this test report refer only to the sample(s) tested unless otherwise stated and the sample(s) are retained for 30 days only. The document is issued by AGC, this document cannot be reproduced except in full with our prior written permission. The more details and the authenticity of the report will be confirmed at <http://www.agc-cert.com>.

5.3. Tissue Calibration Result

The dielectric parameters of the liquids were verified prior to the SAR evaluation using SATIMO Dielectric Probe Kit and R&S Network Analyzer ZVL6.

Tissue Stimulant Measurement for 835MHz					
	Fr. (MHz)	Dielectric Parameters ($\pm 5\%$)		Tissue Temp [°C]	Test time
		ϵ_r 41.5 (39.425-43.575)	δ [s/m] 0.90(0.855-0.945)		
Head	824.2	42.06	0.88	22.1	May 02,2019
	826.4	41.83	0.90		
	835	40.69	0.92		
	836.6	40.53	0.93		
	846.6	39.88	0.93		
	848.8	39.67	0.94		
			Dielectric Parameters ($\pm 5\%$)		
		ϵ_r 55.20(52.44-57.96)	δ [s/m]0.97(0.9215-1.0185)		
Body	824.2	55.58	0.95	22.0	May 02,2019
	826.4	54.62	0.96		
	835	53.68	0.99		
	836.6	53.29	0.99		
	846.6	52.98	1.00		
	848.8	52.56	1.01		

Tissue Stimulant Measurement for 1900MHz					
	Fr. (MHz)	Dielectric Parameters ($\pm 5\%$)		Tissue Temp [°C]	Test time
		ϵ_r 40.00(38.00-42.00)	δ [s/m]1.40(1.33-1.47)		
Head	1850.2	41.03	1.35	21.6	May 05,2019
	1852.4	40.28	1.38		
	1880	39.86	1.40		
	1900	39.47	1.41		
	1907.6	38.61	1.43		
	1909.8	38.42	1.45		
			Dielectric Parameters ($\pm 5\%$)		
		ϵ_r 53.30(50.635-55.965)	δ [s/m]1.52(1.444-1.596)		
Body	1850.2	54.06	1.45	21.7	May 05,2019
	1852.4	53.70	1.46		
	1880	52.86	1.47		
	1900	52.63	1.49		
	1907.6	51.21	1.50		
	1909.8	50.89	1.52		

The results shown in this test report refer only to the sample(s) tested unless otherwise stated and the sample(s) are retained for 30 days only. The document is issued by AGC, this document cannot be reproduced except in full with our prior written permission. The more details and the authenticity of the report will be confirmed at <http://www.agc-cert.com>.

Tissue Stimulant Measurement for 2450MHz					
	Fr. (MHz)	Dielectric Parameters ($\pm 5\%$)		Tissue Temp [°C]	Test time
		$\epsilon_r 39.2(37.24-41.16)$	$\delta[s/m] 1.80(1.71-1.89)$		
Head	2412	39.27	1.73	21.6	May 06,2019
	2437	38.92	1.75		
	2450	38.69	1.77		
	2462	37.81	1.79		
	Fr. (MHz)	Dielectric Parameters ($\pm 5\%$)		Tissue Temp [°C]	Test time
		$\epsilon_r 52.7(50.065-55.335)$	$\delta[s/m] 1.95(1.8525-2.0475)$		
Body	2412	54.20	1.95	21.5	May 06,2019
	2437	53.87	1.98		
	2450	53.21	1.99		
	2462	52.62	1.99		

The results shown in this test report refer only to the sample(s) tested unless otherwise stated and the sample(s) are retained for 30 days only. The document is issued by AGC, this document cannot be reproduced except in full with our prior written permission. The more details and the authenticity of the report will be confirmed at <http://www.agc-cert.com>.

6. SAR SYSTEM CHECK PROCEDURE

6.1. SAR System Check Procedures

SAR system check is required to confirm measurement accuracy, according to the tissue dielectric media, probe calibration points and other system operating parameters required for measuring the SAR of a test device. The system verification must be performed for each frequency band and within the valid range of each probe calibration point required for testing the device. The same SAR probe(s) and tissue-equivalent media combinations used with each specific SAR system for system verification must be used for device testing. When multiple probe calibration points are required to cover substantially large transmission bands, independent system verifications are required for each probe calibration point. A system verification must be performed before each series of SAR measurements using the same probe calibration point and tissue-equivalent medium. Additional system verification should be considered according to the conditions of the tissue-equivalent medium and measured tissue dielectric parameters, typically every three to four days when the liquid parameters are remeasured or sooner when marginal liquid parameters are used at the beginning of a series of measurements.

Each SATIMO system is equipped with one or more system check kits. These units, together with the predefined measurement procedures within the SATIMO software, enable the user to conduct the system check and system validation. System kit includes a dipole, and dipole device holder.

The system check verifies that the system operates within its specifications. It's performed daily or before every SAR measurement. The system check uses normal SAR measurement in the flat section of the phantom with a matched dipole at a specified distance. The system check setup is shown as below.

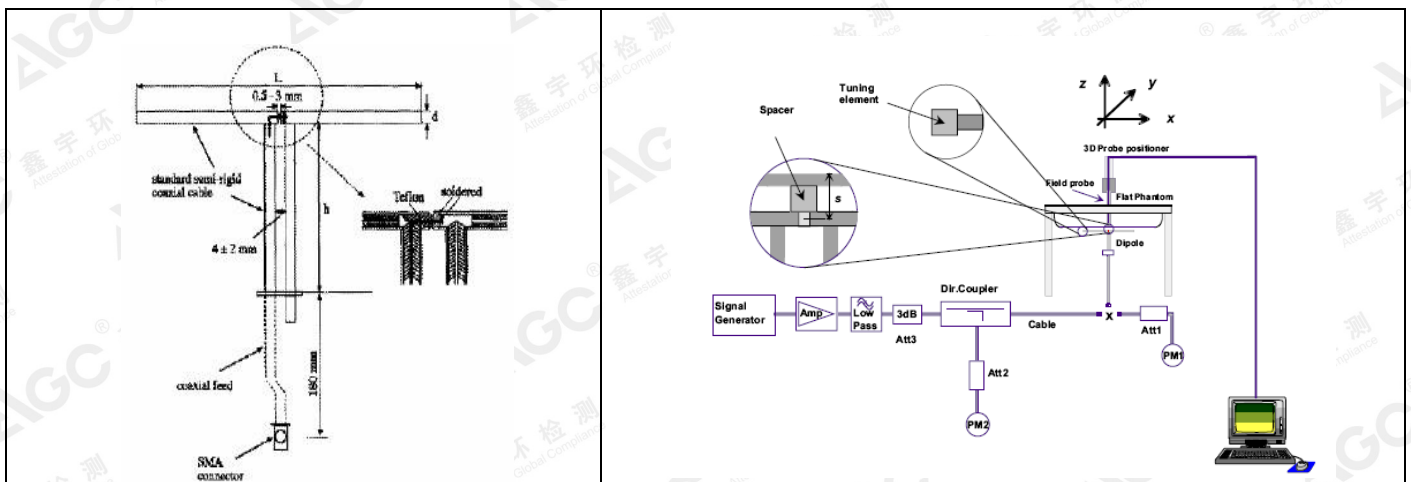

The results shown in this test report refer only to the sample(s) tested unless otherwise stated and the sample(s) are retained for 30 days only. The document is issued by AGC, this document cannot be reproduced except in full with our prior written permission. The more details and the authenticity of the report will be confirmed at <http://www.agc-cert.com>.

6.2. SAR System Check
6.2.1. Dipoles

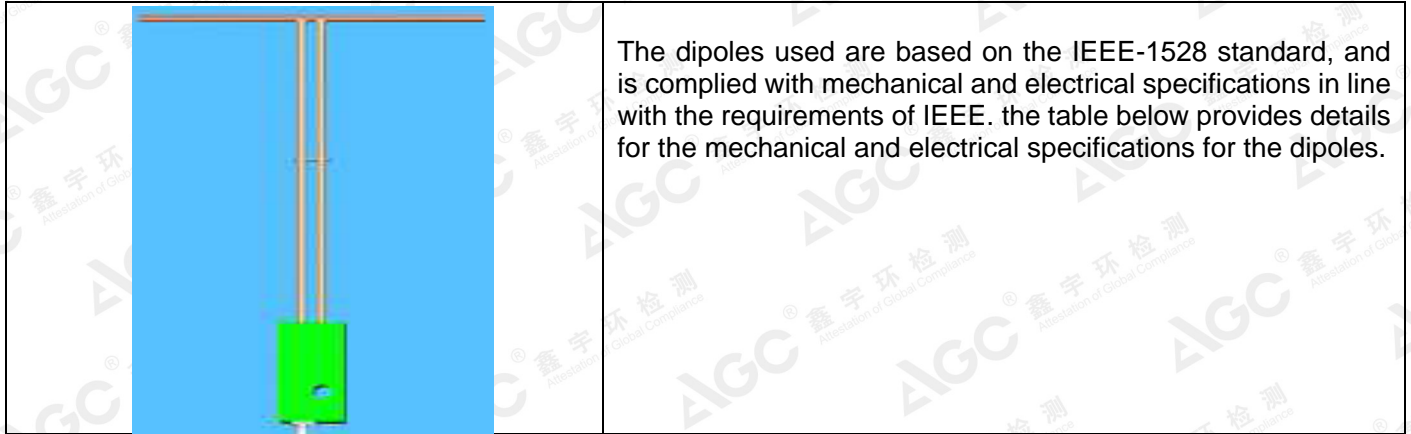

The dipoles used are based on the IEEE-1528 standard, and is complied with mechanical and electrical specifications in line with the requirements of IEEE. the table below provides details for the mechanical and electrical specifications for the dipoles.

Frequency	L (mm)	h (mm)	d (mm)
835MHz	161.0	89.8	3.6
1900MHz	68	39.5	3.6
2450MHz	51.5	30.4	3.6

6.2.2. System Check Result

System Performance Check at 835MHz&1900MHz &2450MHz for Head								
Validation Kit: SN29/15 DIP 0G835-383&SN 29/15 DIP 1G900-389& SN 29/15DIP 2G450-393								
Frequency [MHz]	Target Value(W/Kg)		Reference Result (± 10%)		Tested Value(W/Kg)		Tissue Temp. [°C]	Test time
	1g	10g	1g	10g	1g	10g		
835	10.04	6.43	9.036-11.044	5.787 -7.073	10.33	6.25	22.1	May 02,2019
1900	41.44	21.33	37.296-45.584	19.197-23.463	39.85	20.41	21.6	May 05,2019
2450	54.53	24.30	49.077-59.983	21.87-26.730	51.71	24.06	21.6	May 06,2019

System Performance Check at 835 MHz &1900MHz & 2450MHz for Body								
Frequency [MHz]	Target Value(W/Kg)		Reference Result (± 10%)		Tested Value(W/Kg)		Tissue Temp. [°C]	Test time
	1g	10g	1g	10g	1g	10g		
835	9.85	6.45	8.865-10.835	5.805-7.095	10.35	6.27	22.0	May 02,2019
1900	39.38	20.86	35.442-43.318	18.774-22.946	37.83	19.41	21.7	May 05,2019
2450	49.92	23.16	44.928-54.912	20.844-25.476	51.06	23.73	21.5	May 06,2019

Note:

(1) We use a CW signal of 18dBm for system check, and then all SAR values are normalized to 1W forward power. The result must be within ±10% of target value.

The results shown in this test report refer only to the sample(s) tested unless otherwise stated and the sample(s) are retained for 30 days only. The document is issued by AGC, this document cannot be reproduced except in full with our prior written permission. The more details and the authenticity of the report will be confirmed at <http://www.agc-cert.com>.

7. EUT TEST POSITION

This EUT was tested in **Right Cheek, Right Tilted, Left Cheek, Left Tilted, Body back, Body front and 4 edges.**

7.1. Define Two Imaginary Lines on the Handset

- (1) The vertical centerline passes through two points on the front side of the handset: the midpoint of the width w_t of the handset at the level of the acoustic output, and the midpoint of the width w_b of the handset.
- (2) The horizontal line is perpendicular to the vertical centerline and passes through the center of the acoustic output. The horizontal line is also tangential to the face of the handset at point A.
- (3) The two lines intersect at point A. Note that for many handsets, point A coincides with the center of the acoustic output; however, the acoustic output may be located elsewhere on the horizontal line. Also note that the vertical centerline is not necessarily to the front face of the handset, especially for clamshell handsets, handsets with flip covers, and other irregularly shaped handsets.

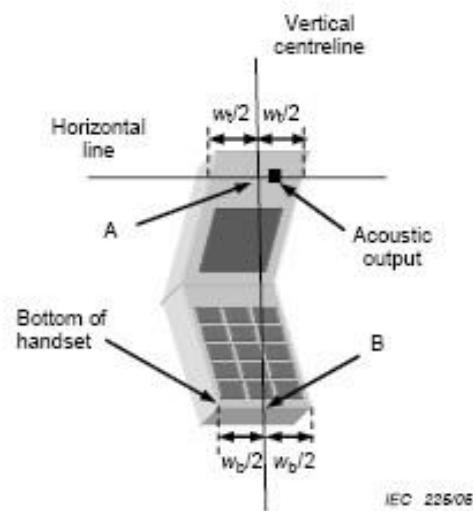
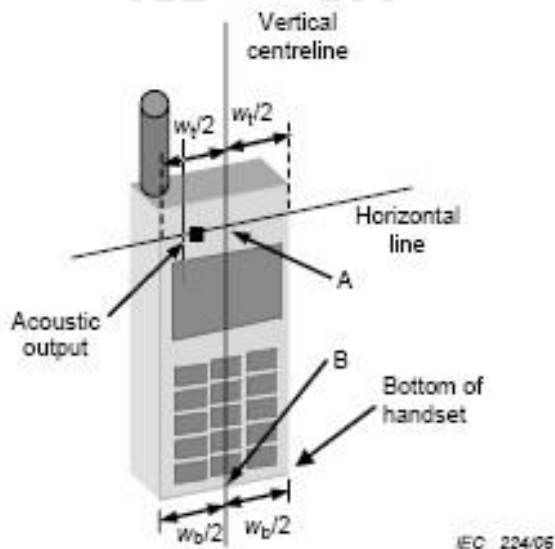

The results shown in this test report refer only to the sample(s) tested unless otherwise stated and the sample(s) are retained for 30 days only. The document is issued by AGC, this document cannot be reproduced except in full with our prior written permission. The more details and the authenticity of the report will be confirmed at <http://www.agc-cert.com>.

7.2. Cheek Position

- (1) To position the device with the vertical center line of the body of the device and the horizontal line crossing the center piece in a plane parallel to the sagittal plane of the phantom. While maintaining the device in this plane, align the vertical center line with the reference plane containing the ear and mouth reference point (M: Mouth, RE: Right Ear, and LE: Left Ear) and align the center of the ear piece with the line RE-LE.
- (2) To move the device towards the phantom with the ear piece aligned with the the line LE-RE until the phone touched the ear. While maintaining the device in the reference plane and maintaining the phone contact with ear, move the bottom of the phone until any point on the front side is in contact with the cheek of the phantom or until contact with the ear is lost



7.3. Tilt Position

- (1) To position the device in the “cheek” position described above.
- (2) While maintaining the device in the reference plane described above and pivoting against the ear, moves it outward away from the mouth by an angle of 15 degrees or until with the ear is lost.



The results shown in this test report refer only to the sample(s) tested unless otherwise stated and the sample(s) are retained for 30 days only. The document is issued by AGC, this document cannot be reproduced except in full with our prior written permission. The more details and the authenticity of the report will be confirmed at <http://www.agc-cert.com>.

7.4. Body Worn Position

- (1) To position the EUT parallel to the phantom surface.
- (2) To adjust the EUT parallel to the flat phantom.
- (3) To adjust the distance between the EUT surface and the flat phantom to **5mm**.

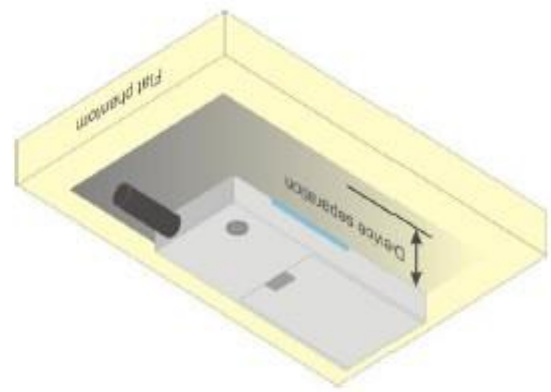
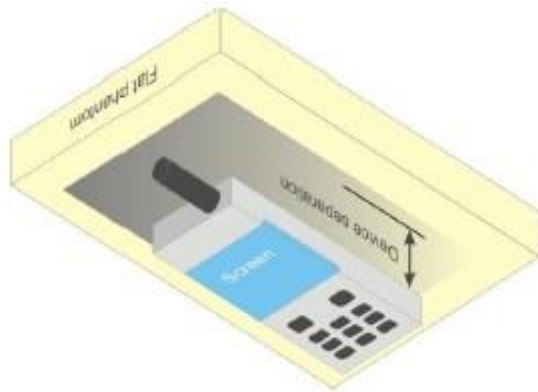

The results shown in this test report refer only to the sample(s) tested unless otherwise stated and the sample(s) are retained for 30 days only. The document is issued by AGC, this document cannot be reproduced except in full with our prior written permission. The more details and the authenticity of the report will be confirmed at <http://www.agc-cert.com>.

8. SAR EXPOSURE LIMITS

Limits for General Population/Uncontrolled Exposure (W/kg)

Type Exposure	Uncontrolled Environment Limit (W/kg)
Spatial Peak SAR (1g cube tissue for brain or body)	1.60
Spatial Average SAR (Whole body)	0.08
Spatial Peak SAR (Limbs)	4.0

The results shown in this test report refer only to the sample(s) tested and unless otherwise stated and the sample(s) are retained for 30 days only. The document is issued by AGC, this document cannot be reproduced except in full with our prior written permission. The more details and the authenticity of the report will be confirmed at <http://www.agc-cert.com>.

9. TEST FACILITY

Test Site	Attestation of Global Compliance (Shenzhen) Co., Ltd
Location	1-2/F, Building 19, Junfeng Industrial Park, Chongqing Road, Heping Community, Fuhai Street, Bao'an District, Shenzhen, Guangdong, China
Designation Number	CN1259
FCC Test Firm Registration Number	975832
A2LA Cert. No.	5054.02
Description	Attestation of Global Compliance(Shenzhen) Co., Ltd is accredited by A2LA

The results shown in this test report refer only to the sample(s) tested unless otherwise stated and the sample(s) are retained for 30 days only. The document is issued by AGC, this document cannot be reproduced except in full with our prior written permission. The more details and the authenticity of the report will be confirmed at <http://www.agc-cert.com>.

10. TEST EQUIPMENT LIST

Equipment description	Manufacturer/ Model	Identification No.	Current calibration date	Next calibration date
SAR Probe	MVG	SN 22/12 EP159	Aug. 08,2018	Aug. 07,2019
Phantom	SATIMO	SN_4511_SAM90	Validated. No cal required.	Validated. No cal required.
Liquid	SATIMO	-	Validated. No cal required.	Validated. No cal required.
Comm Tester	Agilent-8960	GB46310822	Feb. 27,2019	Feb. 26,2020
Multimeter	Keithley 2000	4114939	Sep. 20,2018	Sep. 19,2019
Dipole	SATIMO SID835	SN29/15 DIP 0G835-383	July 05,2016	July 04,2019
Dipole	SATIMO SID1900	SN 29/15 DIP 1G900-389	July 05,2016	July 04,2019
Dipole	SATIMO SID2450	SN29/15 DIP 2G450-393	July 05,2016	July 04,2019
Signal Generator	Agilent-E4438C	US41461365	Nov. 01,2018	Oct. 31,2019
Vector Analyzer	Agilent / E4440A	US41421290	Feb. 27,2019	Feb. 26,2020
Network Analyzer	Rhode & Schwarz ZVL6	SN101443	Nov. 01,2018	Oct. 31,2019
Attenuator	Warison /WATT-6SR1211	N/A	N/A	N/A
Attenuator	Mini-circuits / VAT-10+	N/A	N/A	N/A
Amplifier	EM30180	SN060552	Feb. 27,2019	Feb. 26,2020
Directional Couple	Werlatone/ C5571-10	SN99463	June 12,2018	June 11,2019
Directional Couple	Werlatone/ C6026-10	SN99482	June 12,2018	June 11,2019
Power Sensor	NRP-Z21	1137.6000.02	Sep. 20,2018	Sep. 19,2019
Power Sensor	NRP-Z23	US38261498	Feb. 19,2019	Feb. 18,2020
Power Viewer	R&S	V2.3.1.0	N/A	N/A

Note: Per KDB 865664 Dipole SAR Validation, AGC Lab has adopted 3 years calibration intervals. On annual basis, every measurement dipole has been evaluated and is in compliance with the following criteria:

1. There is no physical damage on the dipole;
2. System validation with specific dipole is within 10% of calibrated value;
3. Return-loss is within 20% of calibrated measurement;
4. Impedance is within 5Ω of calibrated measurement.

The results shown in this test report refer only to the sample(s) tested unless otherwise stated and the sample(s) are retained for 30 days only. The document is issued by AGC, this document cannot be reproduced except in full with our prior written permission. The more details and the authenticity of the report will be confirmed at <http://www.agc-cert.com>.

11. MEASUREMENT UNCERTAINTY

Measurement uncertainty for Dipole averaged over 1 gram / 10 gram.									
a	b	c	d	^e f(d,k)	f	g	^h cx _f /e	ⁱ cx _g /e	k
Uncertainty Component	Sec.	Tol (± %)	Prob. Dist.	Div.	Ci (1g)	Ci (10g)	1g Ui (±%)	10g Ui (±%)	vi
Measurement System									
Probe calibration	E.2.1	5.831	N	1	1	1	5.83	5.83	∞
Axial Isotropy	E.2.2	0.579	R	√3	√0.5	√0.5	0.24	0.24	∞
Hemispherical Isotropy	E.2.2	0.813	R	√3	√0.5	√0.5	0.33	0.33	∞
Boundary effect	E.2.3	1.0	R	√3	1	1	0.58	0.58	∞
Linearity	E.2.4	1.26	R	√3	1	1	0.73	0.73	∞
System detection limits	E.2.4	1.0	R	√3	1	1	0.58	0.58	∞
Modulation response	E.2.5	3.0	R	√3	1	1	1.73	1.73	∞
Readout Electronics	E.2.6	0.021	N	1	1	1	0.021	0.021	∞
Response Time	E.2.7	0	R	√3	1	1	0	0	∞
Integration Time	E.2.8	1.4	R	√3	1	1	0.81	0.81	∞
RF ambient conditions-Noise	E.6.1	3.0	R	√3	1	1	1.73	1.73	∞
RF ambient conditions-reflections	E.6.1	3.0	R	√3	1	1	1.73	1.73	∞
Probe positioner mechanical tolerance	E.6.2	1.4	R	√3	1	1	0.81	0.81	∞
Probe positioning with respect to phantom shell	E.6.3	1.4	R	√3	1	1	0.81	0.81	∞
Extrapolation, interpolation, and integrations algorithms for max. SAR evaluation	E.5	2.3	R	√3	1	1	1.33	1.33	∞
Test sample Related									
Test sample positioning	E.4.2	2.6	N	1	1	1	2.6	2.6	∞
Device holder uncertainty	E.4.1	3	N	1	1	1	3	3	∞
Output power variation—SAR drift measurement	E.2.9	5	R	√3	1	1	2.89	2.89	∞
SAR scaling	E.6.5	5	R	√3	1	1	2.89	2.89	∞
Phantom and tissue parameters									
Phantom shell uncertainty—shape, thickness, and permittivity	E.3.1	4	R	√3	1	1	2.31	2.31	∞
Uncertainty in SAR correction for deviations in permittivity and conductivity	E.3.2	1.9	N	1	1	0.84	1.90	1.60	∞
Liquid conductivity measurement	E.3.3	4	N	1	0.78	0.71	3.12	2.84	M
Liquid permittivity measurement	E.3.3	5	N	1	0.23	0.26	1.15	1.30	M
Liquid conductivity—temperature uncertainty	E.3.4	2.5	R	√3	0.78	0.71	1.13	1.02	∞
Liquid permittivity—temperature uncertainty	E.3.4	2.5	R	√3	0.23	0.26	0.33	0.38	∞
Combined Standard Uncertainty			RSS				9.807	9.608	
Expanded Uncertainty			K=2				19.614	19.216	

The results shown in this test report refer only to the sample(s) tested unless otherwise stated and the sample(s) are retained for 30 days only. The document is issued by AGC, this document cannot be reproduced except in full with our prior written permission. The more details and the authenticity of the report will be confirmed at <http://www.agc-cert.com>.

(95% Confidence interval)									
---------------------------	--	--	--	--	--	--	--	--	--

System Validation uncertainty for Dipole averaged over 1 gram / 10 gram.									
a	b	c	d	e f(d,k)	f	g	h cx _f /e	i cx _g /e	k
Uncertainty Component	Sec.	Tol (±%)	Prob. Dist.	Div.	Ci (1g)	Ci (10g)	1g U _i (±%)	10g U _i (±%)	v _i
Measurement System									
Probe calibration	E.2.1	5.831	N	1	1	1	5.83	5.83	∞
Axial Isotropy	E.2.2	0.579	R	√3	1	1	0.33	0.33	∞
Hemispherical Isotropy	E.2.2	0.813	R	√3	0	0	0.00	0.00	∞
Boundary effect	E.2.3	1.0	R	√3	1	1	0.58	0.58	∞
Linearity	E.2.4	1.26	R	√3	1	1	0.73	0.73	∞
System detection limits	E.2.4	1.0	R	√3	1	1	0.58	0.58	∞
Modulation response	E.2.5	3.0	R	√3	0	0	0.00	0.00	∞
Readout Electronics	E.2.6	0.021	N	1	1	1	0.021	0.021	∞
Response Time	E.2.7	0.0	R	√3	0	0	0.00	0.00	∞
Integration Time	E.2.8	1.4	R	√3	0	0	0.00	0.00	∞
RF ambient conditions-Noise	E.6.1	3.0	R	√3	1	1	1.73	1.73	∞
RF ambient conditions-reflections	E.6.1	3.0	R	√3	1	1	1.73	1.73	∞
Probe positioner mechanical tolerance	E.6.2	1.4	R	√3	1	1	0.81	0.81	∞
Probe positioning with respect to phantom shell	E.6.3	1.4	R	√3	1	1	0.81	0.81	∞
Extrapolation, interpolation, and integrations algorithms for max. SAR evaluation	E.5	2.3	R	√3	1	1	1.33	1.33	∞
System check source (dipole)									
Deviation of experimental dipole from numerical dipole	E.6.4	5.0	N	1	1	1	5.00	5.00	∞
Input power and SAR drift measurement	8,6.6.4	5.0	R	√3	1	1	2.89	2.89	∞
Dipole axis to liquid distance	8,E.6.6	2.0	R	√3	1	1	1.15	1.15	∞
Phantom and tissue parameters									
Phantom shell uncertainty—shape, thickness, and permittivity	E.3.1	4.0	R	√3	1	1	2.31	2.31	∞
Uncertainty in SAR correction for deviations in permittivity and conductivity	E.3.2	1.9	N	1	1	0.84	1.90	1.60	∞
Liquid conductivity measurement	E.3.3	4.0	N	1	0.78	0.71	3.12	2.84	M
Liquid permittivity measurement	E.3.3	5.0	N	1	0.23	0.26	1.15	1.30	M
Liquid conductivity—temperature uncertainty	E.3.4	2.5	R	√3	0.78	0.71	1.13	1.02	∞
Liquid permittivity—temperature uncertainty	E.3.4	2.5	R	√3	0.23	0.26	0.33	0.38	∞
Combined Standard Uncertainty				RSS			9.735	9.534	
Expanded Uncertainty (95% Confidence interval)				K=2			19.470	19.069	

The results shown in this test report refer only to the sample(s) tested unless otherwise stated and the sample(s) are retained for 30 days only. The document is issued by AGC, this document cannot be reproduced except in full with our prior written permission. The more details and the authenticity of the report will be confirmed at <http://www.agc-cert.com>.

The results shown in this test report refer only to the sample(s) tested unless otherwise stated and the sample(s) are retained for 30 days only. The document is issued by AGC, this document cannot be reproduced except in full with our prior written permission. The more details and the authenticity of the report will be confirmed at <http://www.agc-cert.com>.

System check uncertainty for Dipole averaged over 1 gram / 10 gram.									
a	b	c	d	e f(d,k)	f	g	h cx _f /e	i cx _g /e	k
Uncertainty Component	Sec.	Tol (±%)	Prob. Dist.	Div.	Ci (1g)	Ci (10g)	1g U _i (±%)	10g U _i (±%)	v _i
Measurement System									
Probe calibration drift	E.2.1.3	0.5	N	1	1	1	0.50	0.50	∞
Axial Isotropy	E.2.2	0.579	R	√3	0	0	0.00	0.00	∞
Hemispherical Isotropy	E.2.2	0.813	R	√3	0	0	0.00	0.00	∞
Boundary effect	E.2.3	1.0	R	√3	0	0	0.00	0.00	∞
Linearity	E.2.4	1.26	R	√3	0	0	0.00	0.00	∞
System detection limits	E.2.4	1.0	R	√3	0	0	0.00	0.00	∞
Modulation response	E.2.5	3.0	R	√3	0	0	0.00	0.00	∞
Readout Electronics	E.2.6	0.021	N	1	0	0	0.00	0.00	∞
Response Time	E.2.7	0	R	√3	0	0	0.00	0.00	∞
Integration Time	E.2.8	1.4	R	√3	0	0	0.00	0.00	∞
RF ambient conditions-Noise	E.6.1	3.0	R	√3	0	0	0.00	0.00	∞
RF ambient conditions-reflections	E.6.1	3.0	R	√3	0	0	0.00	0.00	∞
Probe positioner mechanical tolerance	E.6.2	1.4	R	√3	1	1	0.81	0.81	∞
Probe positioning with respect to phantom shell	E.6.3	1.4	R	√3	1	1	0.81	0.81	∞
Extrapolation, interpolation, and integrations algorithms for max. SAR evaluation	E.5	2.3	R	√3	0	0	0.00	0.00	∞
System check source (dipole)									
Deviation of experimental dipoles	E.6.4	2	N	1	1	1	2	2	∞
Input power and SAR drift measurement	8,6.6.4	5	R	√3	1	1	2.89	2.89	∞
Dipole axis to liquid distance	8,E.6.6	2	R	√3	1	1	1.15	1.15	∞
Phantom and tissue parameters									
Phantom shell uncertainty—shape, thickness, and permittivity	E.3.1	4	R	√3	1	1	2.31	2.31	∞
Uncertainty in SAR correction for deviations in permittivity and conductivity	E.3.2	1.9	N	1	1	0.84	1.90	1.60	∞
Liquid conductivity measurement	E.3.3	4	N	1	0.78	0.71	3.12	2.84	M
Liquid permittivity measurement	E.3.3	5	N	1	0.23	0.26	1.15	1.30	M
Liquid conductivity—temperature uncertainty	E.3.4	2.5	R	√3	0.78	0.71	1.13	1.02	∞
Liquid permittivity—temperature uncertainty	E.3.4	2.5	R	√3	0.23	0.26	0.33	0.38	∞
Combined Standard Uncertainty				RSS			5.564	5.205	
Expanded Uncertainty (95% Confidence interval)				K=2			11.128	10.410	

The results shown in this test report refer only to the sample(s) tested unless otherwise stated and the sample(s) are retained for 30 days only. The document is issued by AGC, this document cannot be reproduced except in full with our prior written permission. The more details and the authenticity of the report will be confirmed at <http://www.agc-cert.com>.

12. CONDUCTED POWER MEASUREMENT

GSM BAND

Mode	Frequency(MHz)	Avg. Burst Power(dBm)	Duty cycle Factor(dBm)	Frame Power(dBm)
Maximum Power <1>				
GSM 850	824.2	32.46	-9	23.46
	836.6	32.38	-9	23.38
	848.8	32.09	-9	23.09
GPRS 850 (1 Slot)	824.2	31.08	-9	22.08
	836.6	31.44	-9	22.44
	848.8	31.02	-9	22.02
GPRS 850 (2 Slot)	824.2	28.36	-6	22.36
	836.6	28.42	-6	22.42
	848.8	28.33	-6	22.33
GPRS 850 (3 Slot)	824.2	27.19	-4.26	22.93
	836.6	27.29	-4.26	23.03
	848.8	27.35	-4.26	23.09
GPRS 850 (4 Slot)	824.2	25.46	-3	22.46
	836.6	25.74	-3	22.74
	848.8	25.39	-3	22.39
EGPRS 850 (1 Slot)	824.2	26.47	-9	17.47
	836.6	26.79	-9	17.79
	848.8	27.52	-9	18.52
EGPRS 850 (2 Slot)	824.2	26.13	-6	20.13
	836.6	26.22	-6	20.22
	848.8	26.34	-6	20.34
EGPRS 850 (3 Slot)	824.2	26.29	-4.26	22.03
	836.6	26.31	-4.26	22.05
	848.8	26.28	-4.26	22.02
EGPRS 850 (4 Slot)	824.2	24.26	-3	21.26
	836.6	24.39	-3	21.39
	848.8	24.45	-3	21.45

The results shown in this test report refer only to the sample(s) tested unless otherwise stated and the sample(s) are retained for 30 days only. The document is issued by AGC, this document cannot be reproduced except in full with our prior written permission. The more details and the authenticity of the report will be confirmed at <http://www.agc-cert.com>.

Mode	Frequency(MHz)	Avg. Burst Power(dBm)	Duty cycle Factor(dBm)	Frame Power(dBm)
Maximum Power <2>				
GSM 850	824.2	31.05	-9	22.05
	836.6	31.03	-9	22.03
	848.8	31.01	-9	22.01
GPRS 850 (1 Slot)	824.2	30.61	-9	21.61
	836.6	30.56	-9	21.56
	848.8	30.70	-9	21.70
GPRS 850 (2 Slot)	824.2	28.25	-6	22.25
	836.6	28.33	-6	22.33
	848.8	28.30	-6	22.30
GPRS 850 (3 Slot)	824.2	27.15	-4.26	22.89
	836.6	27.22	-4.26	22.96
	848.8	27.31	-4.26	23.05
GPRS 850 (4 Slot)	824.2	25.42	-3	22.42
	836.6	25.70	-3	22.70
	848.8	25.36	-3	22.36

The results shown in this test report refer only to the sample(s) tested unless otherwise stated and the sample(s) are retained for 30 days only. The document is issued by AGC, this document cannot be reproduced except in full with our prior written permission. The more details and the authenticity of the report will be confirmed at <http://www.agc-cert.com>.

GSM BAND CONTINUE

Mode	Frequency(MHz)	Avg. Burst Power(dBm)	Duty cycle Factor(dBm)	Frame Power(dBm)
Maximum Power <1>				
PCS1900	1850.2	31.71	-9	22.71
	1880	31.64	-9	22.64
	1909.8	31.59	-9	22.59
GPRS1900 (1 Slot)	1850.2	31.23	-9	22.23
	1880	31.41	-9	22.41
	1909.8	31.23	-9	22.23
GPRS1900 (2 Slot)	1850.2	28.05	-6	22.05
	1880	28.16	-6	22.16
	1909.8	28.11	-6	22.11
GPRS1900 (3 Slot)	1850.2	27.22	-4.26	22.96
	1880	27.24	-4.26	22.98
	1909.8	27.33	-4.26	23.07
GPRS1900 (4 Slot)	1850.2	25.05	-3	22.05
	1880	25.11	-3	22.11
	1909.8	25.18	-3	22.18
EGPRS1900 (1 Slot)	1850.2	28.45	-9	19.45
	1880	28.39	-9	19.39
	1909.8	28.44	-9	19.44
EGPRS1900 (2 Slot)	1850.2	27.12	-6	21.12
	1880	27.16	-6	21.16
	1909.8	27.23	-6	21.23
EGPRS1900 (3 Slot)	1850.2	26.22	-4.26	21.96
	1880	26.29	-4.26	22.03
	1909.8	25.31	-4.26	21.05
EGPRS1900 (4 Slot)	1850.2	24.25	-3	21.25
	1880	24.42	-3	21.42
	1909.8	24.37	-3	21.37

The results shown in this test report refer only to the sample(s) tested unless otherwise stated and the sample(s) are retained for 30 days only. The document is issued by AGC, this document cannot be reproduced except in full with our prior written permission. The more details and the authenticity of the report will be confirmed at <http://www.agc-cert.com>.

Mode	Frequency(MHz)	Avg. Burst Power(dBm)	Duty cycle Factor(dBm)	Frame Power(dBm)
Maximum Power <2>				
PCS1900	1850.2	30.79	-9	21.79
	1880	30.60	-9	21.60
	1909.8	30.51	-9	21.51
GPRS1900 (1 Slot)	1850.2	30.20	-9	21.20
	1880	30.36	-9	21.36
	1909.8	30.19	-9	21.19
GPRS1900 (2 Slot)	1850.2	28.02	-6	22.02
	1880	28.12	-6	22.12
	1909.8	28.08	-6	22.08
GPRS1900 (3 Slot)	1850.2	27.20	-4.26	22.94
	1880	27.18	-4.26	22.92
	1909.8	27.30	-4.26	23.04
GPRS1900 (4 Slot)	1850.2	25.02	-3	22.02
	1880	25.09	-3	22.09
	1909.8	25.11	-3	22.11

Note 1:

The Frame Power (Source-based time-averaged Power) is scaled the maximum burst average power based on time slots. The calculated methods are show as following:

Frame Power = Max burst power (1 Up Slot) – 9 dB

Frame Power = Max burst power (2 Up Slot) – 6 dB

Frame Power = Max burst power (3 Up Slot) – 4.26 dB

Frame Power = Max burst power (4 Up Slot) – 3 dB

The results shown in this test report refer only to the sample(s) tested unless otherwise stated and the sample(s) are retained for 30 days only. The document is issued by AGC, this document cannot be reproduced except in full with our prior written permission. The more details and the authenticity of the report will be confirmed at <http://www.agc-cert.com>.

UMTS BAND
HSDPA Setup Configuration:

- The EUT was connected to Base Station Agilent E5515C referred to the Setup Configuration.
- The RF path losses were compensated into the measurements.
- A call was established between EUT and Based Station with following setting:
 - (1) Set Gain Factors(β_c and β_d) parameters set according to each
 - (2) Set RMC 12.2Kbps+HSDPA mode.
 - (3) Set Cell Power=-86dBm
 - (4) Set HS-DSCH Configuration Type to FRC (H-set 1, QPSK)
 - (5) Select HSDPA Uplink Parameters
 - (6) Set Delta ACK, Delta NACK and Delta CQI=8
 - (7) Set Ack - Nack Repetition Factor to 3
 - (8) Set CQI Feedback Cycle (k) to 4ms
 - (9) Set CQI Repetition Factor to 2
 - (10) Power Ctrl Mode=All Up bits
- The transmitted maximum output power was recorded.

 Table C.10.2.4: β values for transmitter characteristics tests with HS-DPCCH

Sub-test	β_c (Note5)	β_d	β_d (SF)	β_c/β_d	β_{HS} (Note1, Note 2)	CM (dB) (Note 3)	MPR (dB) (Note 3)
1	2/15	15/15	64	2/15	4/15	0.0	0.0
2	12/15(Note 4)	15/15(Note 4)	64	12/15(Note 4)	24/15	1.0	0.0
3	15/15	8/15	64	15/8	30/15	1.5	0.5
4	15/15	4/15	64	15/4	30/15	1.5	0.5

Note 1: $\Delta ACK, \Delta NACK$ and $\Delta CQI = 30/15$ with $\beta_{hs} = 30/15 * \beta_c$.

Note 2: For the HS-DPCCH power mask requirement test in clause 5.2C, 5.7A, and the Error Vector Magnitude (EVM) with HS-DPCCH test in clause 5.13.1A, and HSDPA EVM with phase discontinuity in clause 5.13.1AA, ΔACK and $\Delta NACK = 30/15$ with $\beta_{hs} = 30/15 * \beta_c$, and $\Delta CQI = 24/15$ with $\beta_{hs} = 24/15 * \beta_c$.

Note 3: CM = 1 for $\beta_c/\beta_d = 12/15$, $h_s/c = 24/15$. For all other combinations of DPDCH, DPCCH and HS-DPCCH the MPR is based on the relative CM difference. This is applicable for only UEs that support HSDPA in release 6 and later releases.

Note 4: For subtest 2 the c/d ratio of 12/15 for the TFC during the measurement period (TF1, TF0) is achieved by setting the signalled gain factors for the reference TFC (TF1, TF1) to $c = 11/15$ and $d = 15/15$.

The results shown in this test report refer only to the sample(s) tested unless otherwise stated and the sample(s) are retained for 30 days only. The document is issued by AGC, this document cannot be reproduced except in full with our prior written permission. The more details and the authenticity of the report will be confirmed at <http://www.agc-cert.com>.

HSUPA Setup Configuration:

- The EUT was connected to Base Station Agilent E5515C referred to the Setup Configuration.
- The RF path losses were compensated into the measurements.
- A call was established between EUT and Base Station with following setting * :
 - (1) Call Configs = 5.2B, 5.9B, 5.10B, and 5.13.2B with QPSK
 - (2) Set the Gain Factors (β_c and β_d) and parameters (AG Index) were set according to each specific sub-test in the following table, C11.1.3, quoted from the TS 34.121
 - (3) Set Cell Power = -86 dBm
 - (4) Set Channel Type = 12.2k + HSPA
 - (5) Set UE Target Power
 - (6) Power Ctrl Mode= Alternating bits
 - (7) Set and observe the E-TFCI
 - (8) Confirm that E-TFCI is equal to the target E-TFCI of 75 for sub-test 1, and other subtest's E-TFCI
- The transmitted maximum output power was recorded.

 Table C.11.1.3: β values for transmitter characteristics tests with HS-DPCCH and E-DCH

Sub-test	β_c	β_d	β_d (SF)	β_c/β_d	β_{HS} (Note 1)	β_{ec}	β_{ed} (Note 4) (Note 5)	β_{ed} (SF)	β_{ed} (Code s)	CM (dB) (Note 2)	MPR (dB) (Note 2) (Note 6)	AG Index (Note 5)	E-TF CI
1	11/15 (Note 3)	15/15 (Note 3)	64	11/15 (Note 3)	22/15	209/225	1309/225	4	1	1.0	0.0	20	75
2	6/15	15/15	64	6/15	12/15	12/15	94/75	4	1	3.0	2.0	12	67
3	15/15	9/15	64	15/9	30/15	30/15	β_{ed1} : 47/15 β_{ed2} : 47/15	4	2	2.0	1.0	15	92
4	2/15	15/15	64	2/15	4/15	2/15	56/75	4	1	3.0	2.0	17	71
5	15/15	0	-	-	5/15	5/15	47/15	4	1	1.0	0.0	12	67

Note 1: For sub-test 1 to 4, ΔACK , $\Delta NACK$ and $\Delta CQI = 30/15$ with $\beta_{hs} = 30/15 * \beta_c$. For sub-test 5, ΔACK , $\Delta NACK$ and $\Delta CQI = 5/15$ with $\beta_{hs} = 5/15 * \beta_c$.

Note 2: CM = 1 for $\beta_c/\beta_d = 12/15$, $hs/c = 24/15$. For all other combinations of DPDCH, DPCCH, HS-DPCCH, E-DPDCH and E-DPCCH the MPR is based on the relative CM difference.

Note 3: For subtest 1 the c/d ratio of 11/15 for the TFC during the measurement period (TF1, TF0) is achieved by setting the signalled gain factors for the reference TFC (TF1, TF1) to $c = 10/15$ and $d = 15/15$.

Note 4: In case of testing by UE using E-DPDCH Physical Layer category 1, Sub-test 3 is omitted according to TS25.306 Table 5.1g.

Note 5: β_{ed} cannot be set directly; it is set by Absolute Grant Value.

Note 6: For subtests 2, 3 and 4, UE may perform E-DPDCH power scaling at max power which could results in slightly smaller MPR values.

The results shown in this test report refer only to the sample(s) tested unless otherwise stated and the sample(s) are retained for 30 days only. The document is issued by AGC, this document cannot be reproduced except in full with our prior written permission. The more details and the authenticity of the report will be confirmed at <http://www.agc-cert.com>.

UMTS BAND II

Mode	Frequency (MHz)	Avg. Burst Power (dBm)
WCDMA 1900 RMC	1852.4	23.74
	1880	23.67
	1907.6	23.61
WCDMA 1900 AMR	1852.4	23.25
	1880	23.12
	1907.6	23.66
HSDPA Subtest 1	1852.4	21.45
	1880	21.63
	1907.6	21.69
HSDPA Subtest 2	1852.4	21.66
	1880	21.60
	1907.6	21.87
HSDPA Subtest 3	1852.4	22.75
	1880	22.70
	1907.6	22.39
HSDPA Subtest 4	1852.4	21.68
	1880	21.63
	1907.6	21.67
HSUPA Subtest 1	1852.4	22.43
	1880	22.28
	1907.6	22.33
HSUPA Subtest 2	1852.4	21.69
	1880	21.74
	1907.6	21.72
HSUPA Subtest 3	1852.4	22.22
	1880	22.13
	1907.6	22.28
HSUPA Subtest 4	1852.4	22.33
	1880	22.40
	1907.6	22.45
HSUPA Subtest 5	1852.4	21.22
	1880	21.19
	1907.6	21.25

The results shown in this test report refer only to the sample(s) tested unless otherwise stated and the sample(s) are retained for 30 days only. The document is issued by AGC, this document cannot be reproduced except in full with our prior written permission. The more details and the authenticity of the report will be confirmed at <http://www.agc-cert.com>.

UMTS BAND V

Mode	Frequency (MHz)	Avg. Burst Power (dBm)
WCDMA 850 RMC	826.4	23.46
	836.6	23.55
	846.6	23.47
WCDMA 850 AMR	826.4	22.78
	836.6	22.36
	846.6	22.28
HSDPA Subtest 1	826.4	22.13
	836.6	22.23
	846.6	22.28
HSDPA Subtest 2	826.4	22.45
	836.6	22.33
	846.6	22.49
HSDPA Subtest 3	826.4	22.21
	836.6	22.13
	846.6	22.42
HSDPA Subtest 4	826.4	22.20
	836.6	22.21
	846.6	22.32
HSUPA Subtest 1	826.4	22.11
	836.6	22.19
	846.6	22.15
HSUPA Subtest 2	826.4	21.30
	836.6	21.38
	846.6	22.29
HSUPA Subtest 3	826.4	21.22
	836.6	22.23
	846.6	22.25
HSUPA Subtest 4	826.4	21.49
	836.6	22.53
	846.6	22.46
HSUPA Subtest 5	826.4	21.15
	836.6	21.26
	846.6	21.34

The results shown in this test report refer only to the sample(s) tested unless otherwise stated and the sample(s) are retained for 30 days only. The document is issued by AGC, this document cannot be reproduced except in full with our prior written permission. The more details and the authenticity of the report will be confirmed at <http://www.agc-cert.com>.

According to 3GPP 25.101 sub-clause 6.2.2 , the maximum output power is allowed to be reduced by following the table.

Table 6.1aA: UE maximum output power with HS-DPCCH and E-DCH

UE Transmit Channel Configuration	CM(db)	MPR(db)
For all combinations of ,DPDCH,DPCCH HS-DPDCH,E-DPDCH and E-DPCCH	$0 \leq CM \leq 3.5$	$MAX(CM-1,0)$

Note: CM=1 for $\beta_c/\beta_d=12/15$, $\beta_{hs}/\beta_c=24/15$. For all other combinations of DPDCH, DPCCH, HS-DPCCH, E-DPDCH and E-DPCCH the MPR is based on the relative CM difference.

The device supports MPR to solve linearity issues (ACLR or SEM) due to the higher peak-to average ratios (PAR) of the HSUPA signal. This prevents saturating the full range of the TX DAC inside of device and provides a reduced power output to the RF transceiver chip according to the Cubic Metric (a function of the combinations of DPDCH, DPCCH, HS-DPCCH, E-DPDCH and E-DPCCH).

When E-DPDCH channels are present the beta gains on those channels are reduced firsts to try to get the power under the allowed limit. If the beta gains are lowered as far as possible, then a hard limiting is applied at the maximum allowed level.

The SW currently recalculates the cubic metric every time the beta gains on the E-DPDCH are reduced. The cubic metric will likely get lower each time this is done .However, there is no reported reduction of maximum output power in the HSUPA mode since the device also provides a compensation for the power back-off by increasing the gain of TX_AGC in the transceiver (PA) device.

The end effect is that the DUT output power is identical to the case where there is no MPR in the device.

The results shown in this test report refer only to the sample(s) tested unless otherwise stated and the sample(s) are retained for 30 days only. The document is issued by AGC, this document cannot be reproduced except in full with our prior written permission. The more details and the authenticity of the report will be confirmed at <http://www.agc-cert.com>.

WIFI

Mode	Data Rate (Mbps)	Channel	Frequency(MHz)	Avg. Burst Power(dBm)
802.11b	1	01	2412	11.69
		06	2437	11.60
		11	2462	11.79
802.11g	6	01	2412	7.70
		06	2437	9.52
		11	2462	9.66
802.11n(20)	6.5	01	2412	7.63
		06	2437	9.65
		11	2462	9.57
802.11n(40)	13.5	03	2422	7.89
		06	2437	9.19
		09	2452	6.77

Bluetooth_(BR/EDR)

Modulation	Channel	Frequency(MHz)	Peak Power (dBm)
GFSK	0	2402	-0.652
	39	2441	0.302
	78	2480	0.969
π /4-DQPSK	0	2402	-1.617
	39	2441	-0.692
	78	2480	-0.022
8-DPSK	0	2402	-1.627
	39	2441	-0.768
	78	2480	-0.059

Bluetooth_(BLE)

Modulation	Channel	Frequency(MHz)	Peak Power (dBm)
GFSK	0	2402	-0.512
	19	2440	0.448
	39	2480	1.065

The results shown in this test report refer only to the sample(s) tested unless otherwise stated and the sample(s) are retained for 30 days only. The document is issued by AGC, this document cannot be reproduced except in full with our prior written permission. The more details and the authenticity of the report will be confirmed at <http://www.agc-cert.com>.

13. TEST RESULTS

13.1. SAR Test Results Summary

13.1.1. Test position and configuration

Head SAR was performed with the device configured in the positions according to IEEE 1528-2013, Body-worn and 4 Edges SAR was performed with the device 5mm from the phantom.

13.1.2. Operation Mode

1. Per KDB 447498 D01 v06 ,for each exposure position, if the highest 1-g SAR is ≤ 0.8 W/kg, testing for low and high channel is optional.
2. Per KDB 865664 D01 v01r04,for each frequency band, if the measured SAR is ≥ 0.8 W/Kg, testing for repeated SAR measurement is required , that the highest measured SAR is only to be tested. When the SAR results are near the limit, the following procedures are required for each device to verify these types of SAR measurement related variation concerns by repeating the highest measured SAR configuration in each frequency band.
 - (1) When the original highest measured SAR is ≥ 0.8 W/Kg, repeat that measurement once.
 - (2) Perform a second repeated measurement only if the ratio of largest to smallest SAR for the original and first repeated measurements is >1.20 or when the original or repeated measurement is ≥ 1.45 W/Kg.
 - (3) Perform a third repeated measurement only if the original, first and second repeated measurement is ≥ 1.5 W/Kg and ratio of largest to smallest SAR for the original, first and second measurement is ≥ 1.20 .
3. Body-worn exposure conditions are intended to voice call operations, therefore GSM voice call mode is selected to be test.
4. Per KDB 648474 D04 v01r03,when the reported SAR for a body-worn accessory measured without a headset connected to the handset is ≤ 1.2 W/Kg, SAR testing with a headset connected is not required.
5. Per KDB 248227 D01v02r02,for 2.4GHz 802.11g/n SAR testing is not required when the highest reported SAR for DSSS is adjusted by the ratio of OFDM to DSSS specified maximum output power and the adjusted SAR is ≤ 1.2 W/kg.
6. Per KDB 941225 D06 V02r01, when the same wireless mode transmission configurations for voice and data are required for SAR measurements, the more conservative configuration with a smaller separation distance should be tested for the overlapping SAR configurations.
7. Maximum Scaling SAR in order to calculate the Maximum SAR values to test under the standard Peak Power, Calculation method is as follows:
Maximum Scaling SAR =tested SAR (Max.) \times [maximum turn-up power (mw)/ maximum measurement output power(mw)]
8. Proximity sensor, just for avoiding the wrong operation in the phone screen when call, and has no influence on output power or SAR result

The results shown in this test report refer only to the sample(s) tested unless otherwise stated and the sample(s) are retained for 30 days only. The document is issued by AGC, this document cannot be reproduced except in full with our prior written permission. The more details and the authenticity of the report will be confirmed at <http://www.agc-cert.com>.

13.1.3. Test Result

SAR MEASUREMENT									
Depth of Liquid (cm):>15					Relative Humidity (%): 55.2				
Product: Smart phone									
Test Mode: GSM850 with GMSK modulation									
Position	Mode	Ch.	Fr. (MHz)	Power Drift (<±5%)	SAR (1g) (W/kg)	Max. Tune-up Power (dBm)	Meas. output Power (dBm)	Scaled SAR (W/Kg)	Limit (W/kg)
SIM 1 Card									
Left Cheek	voice	190	836.6	-0.12	0.239	32.50	32.38	0.246	1.6
Left Tilt	voice	190	836.6	-0.05	0.156	32.50	32.38	0.160	1.6
Right Cheek	voice	190	836.6	0.26	0.272	32.50	32.38	0.280	1.6
Right Tilt	voice	190	836.6	-0.34	0.164	32.50	32.38	0.169	1.6
Body back	voice	190	836.6	0.18	0.625	32.50	32.38	0.643	1.6
Body front	voice	190	836.6	0.20	0.347	32.50	32.38	0.357	1.6
Body back	GPRS-3 slot	128	824.2	-0.18	0.923	27.50	27.19	0.991	1.6
Body back	GPRS-3 slot	190	836.6	-0.73	0.852	27.50	27.29	0.894	1.6
Body back	GPRS-3 slot	251	848.8	-1.27	1.044	27.50	27.35	1.081	1.6
Body front	GPRS-3 slot	190	836.6	-1.15	0.478	27.50	27.29	0.502	1.6
Edge 2(Right)	GPRS-3 slot	190	836.6	0.32	0.259	27.50	27.29	0.272	1.6
Edge 3(Bottom)	GPRS-3 slot	190	836.6	-0.06	0.325	27.50	27.29	0.341	1.6
Edge 4(Left)	GPRS-3 slot	190	836.6	0.36	0.279	27.50	27.29	0.293	1.6

Note:

- When the 1-g Reported SAR is ≤ 0.8 W/kg, testing for low and high channel is optional. Refer to KDB 447498.
- The test separation for body back, body front and 4 Edges is 5mm of all above table.

The results shown in this test report refer only to the sample(s) tested unless otherwise stated and the sample(s) are retained for 30 days only. The document is issued by AGC, this document cannot be reproduced except in full with our prior written permission. The more details and the authenticity of the report will be confirmed at <http://www.agc-cert.com>.

SAR MEASUREMENT									
Depth of Liquid (cm):>15					Relative Humidity (%): 54.2				
Product: Smart phone									
Test Mode: PCS1900 with GMSK modulation									
Position	Mode	Ch.	Fr. (MHz)	Power Drift ($\leq \pm 5\%$)	SAR (1g) (W/kg)	Max. Tune-up Power (dBm)	Meas. output Power (dBm)	Scaled SAR (W/Kg)	Limit (W/kg)
SIM 1 Card									
Left Cheek	voice	661	1880.0	-0.33	0.017	31.80	31.64	0.018	1.6
Left Tilt	voice	661	1880.0	-0.26	0.006	31.80	31.64	0.006	1.6
Right Cheek	voice	661	1880.0	-0.58	0.015	31.80	31.64	0.016	1.6
Right Tilt	voice	661	1880.0	0.27	0.004	31.80	31.64	0.004	1.6
Body back	voice	661	1880.0	-0.46	0.263	31.80	31.64	0.273	1.6
Body front	voice	661	1880.0	0.52	0.039	31.80	31.64	0.040	1.6
Body back	GPRS-3 slot	661	1880.0	-0.76	0.681	27.50	27.24	0.723	1.6
Body front	GPRS-3 slot	661	1880.0	0.27	0.111	27.50	27.24	0.118	1.6
Edge 2(Right)	GPRS-3 slot	661	1880.0	-0.18	0.018	27.50	27.24	0.019	1.6
Edge 3(Bottom)	GPRS-3 slot	661	1880.0	-0.65	0.172	27.50	27.24	0.183	1.6
Edge 4(Left)	GPRS-3 slot	661	1880.0	0.52	0.018	27.50	27.24	0.019	1.6

Note:

- When the 1-g Reported SAR is ≤ 0.8 W/kg, testing for low and high channel is optional. Refer to KDB 447498.
- The test separation for body back, body front and 4 Edges is 5mm of all above table.

The results shown in this test report refer only to the sample(s) tested unless otherwise stated and the sample(s) are retained for 30 days only. The document is issued by AGC, this document cannot be reproduced except in full with our prior written permission. The more details and the authenticity of the report will be confirmed at <http://www.agc-cert.com>.

SAR MEASUREMENT									
Depth of Liquid (cm):>15					Relative Humidity (%): 54.2				
Product: Smart phone									
Test Mode: WCDMA Band II with QPSK modulation									
Position	Mode	Ch.	Fr. (MHz)	Power Drift ($\pm 5\%$)	SAR (1g) (W/kg)	Max. Tune-up Power (dBm)	Meas. output Power (dBm)	Scaled SAR (W/Kg)	Limit (W/kg)
Left Cheek	RMC 12.2kbps	9400	1880	-0.35	0.030	23.80	23.67	0.031	1.6
Left Tilt	RMC 12.2kbps	9400	1880	0.28	0.011	23.80	23.67	0.011	1.6
Right Cheek	RMC 12.2kbps	9400	1880	-0.42	0.029	23.80	23.67	0.030	1.6
Right Tilt	RMC 12.2kbps	9400	1880	-0.16	0.009	23.80	23.67	0.009	1.6
Body back	RMC 12.2kbps	9400	1880	1.34	0.535	23.80	23.67	0.551	1.6
Body front	RMC 12.2kbps	9400	1880	-0.15	0.085	23.80	23.67	0.088	1.6
Edge 2(Right)	RMC 12.2kbps	9400	1880	0.23	0.016	23.80	23.67	0.016	1.6
Edge 3(Bottom)	RMC 12.2kbps	9400	1880	-0.05	0.118	23.80	23.67	0.122	1.6
Edge 4(Left)	RMC 12.2kbps	9400	1880	0.27	0.013	23.80	23.67	0.013	1.6

Note:

- When the 1-g Reported SAR is ≤ 0.8 W/kg, testing for low and high channel is optional. Refer to KDB 447498.
- The test separation for body back, body front and 4 Edges is 5mm of all above table.

The results shown in this test report refer only to the sample(s) tested unless otherwise stated and the sample(s) are retained for 30 days only. The document is issued by AGC, this document cannot be reproduced except in full with our prior written permission. The more details and the authenticity of the report will be confirmed at <http://www.agc-cert.com>.

SAR MEASUREMENT									
Depth of Liquid (cm):>15					Relative Humidity (%): 55.2				
Product: Smart phone									
Test Mode: WCDMA Band V with QPSK modulation									
Position	Mode	Ch.	Fr. (MHz)	Power Drift (<±5%)	SAR (1g) (W/kg)	Max. Tune-up Power (dBm)	Meas. output Power (dBm)	Scaled SAR (W/Kg)	Limit (W/kg)
Left Cheek	RMC 12.2kbps	4183	836.6	-0.36	0.048	23.60	23.55	0.049	1.6
Left Tilt	RMC 12.2kbps	4183	836.6	-0.27	0.033	23.60	23.55	0.033	1.6
Right Cheek	RMC 12.2kbps	4183	836.6	0.51	0.049	23.60	23.55	0.050	1.6
Right Tilt	RMC 12.2kbps	4183	836.6	-0.28	0.039	23.60	23.55	0.039	1.6
Body back	RMC 12.2kbps	4183	836.6	-0.46	0.252	23.60	23.55	0.255	1.6
Body front	RMC 12.2kbps	4183	836.6	-0.58	0.088	23.60	23.55	0.089	1.6
Edge 2(Right)	RMC 12.2kbps	4183	836.6	0.57	0.040	23.60	23.55	0.040	1.6
Edge 3(Bottom)	RMC 12.2kbps	4183	836.6	-0.46	0.129	23.60	23.55	0.130	1.6
Edge 4(Left)	RMC 12.2kbps	4183	836.6	0.32	0.059	23.60	23.55	0.060	1.6

Note:

- When the 1-g Reported SAR is ≤ 0.8 W/kg, testing for low and high channel is optional. Refer to KDB 447498.
- The test separation for body back, body front and 4 Edges is 5mm of all above table.

The results shown in this test report refer only to the sample(s) tested unless otherwise stated and the sample(s) are retained for 30 days only. The document is issued by AGC, this document cannot be reproduced except in full with our prior written permission. The more details and the authenticity of the report will be confirmed at <http://www.agc-cert.com>.

SAR MEASUREMENT									
Depth of Liquid (cm):>15					Relative Humidity (%): 51.8				
Product: Smart phone									
Test Mode:802.11b									
Position	Mode	Ch.	Fr. (MHz)	Power Drift (<±5%)	SAR (1g) (W/kg)	Max. Tune-up Power (dBm)	Meas. output Power (dBm)	Scaled SAR (W/Kg)	Limit (W/kg)
Left Cheek	DTS	6	2437	-0.39	0.151	11.79	11.60	0.158	1.6
Left Tilt	DTS	6	2437	-0.35	0.146	11.79	11.60	0.153	1.6
Right Cheek	DTS	6	2437	0.27	0.288	11.79	11.60	0.301	1.6
Right Tilt	DTS	6	2437	-0.46	0.182	11.79	11.60	0.190	1.6
Body back	DTS	6	2437	-0.52	0.163	11.79	11.60	0.170	1.6
Body front	DTS	6	2437	-0.27	0.153	11.79	11.60	0.160	1.6
Edge 1 (Top)	DTS	6	2437	0.17	0.201	11.79	11.60	0.210	1.6
Edge 4(Left)	DTS	6	2437	0.33	0.171	11.79	11.60	0.179	1.6

Note:

- According to KDB248227, SAR is not required for 802.11n HT20/HT40 channels when the maximum average output power is less than 1/4 dB higher than that measured on the corresponding 802.11a/b channels.
- All of above "DTS" means data transmitters.
- The test separation for body back, body front and 4 Edges is 5mm of all above table.

Repeated SAR										
Product: Smart phone										
Test Mode: GSM850										
Position	Mode	Ch.	Fr. (MHz)	Power Drift (<±5%)	Once SAR (1g) (W/kg)	Power Drift (<±5%)	Twice SAR (1g) (W/kg)	Power Drift (<±5%)	Third SAR (1g) (W/kg)	Limit (W/kg)
Body back	GPRS-3 slot	251	848.8	0.02	1.033	--	--	--	--	1.6
--	--	--	--	--	--	--	--	--	--	1.6

The results shown in this test report refer only to the sample(s) tested unless otherwise stated and the sample(s) are retained for 30 days only. The document is issued by AGC, this document cannot be reproduced except in full with our prior written permission. The more details and the authenticity of the report will be confirmed at <http://www.agc-cert.com>.

Simultaneous Multi-band Transmission Evaluation:
Application Simultaneous Transmission information:

NO	Simultaneous state	Portable Handset		
		Head	Body-worn	Hotspot
1	GSM(voice)+WLAN 2.4GHz (data)	Yes	Yes	-
2	GSM(voice)+Bluetooth(data)	-	Yes	-
3	GSM (Data) + WLAN 2.4GHz (data)	-	Yes	Yes
4	GSM (Data) + Bluetooth(data)	-	Yes	Yes
5	WCDMA+WLAN 2.4GHz (data)	Yes	Yes	Yes
6	WCDMA+Bluetooth(data)	-	Yes	Yes

NOTE:

1. WIFI and BT share the same antenna, and cannot transmit simultaneously.
2. Simultaneous with every transmitter must be the same test position.
3. KDB 447498 D01, BT SAR is excluded as below table.
4. KDB 447498 D01, for handsets the test separation distance is determined by the smallest distance between the outer surface of the device and the user; which is 0mm for head SAR and 5mm for body-worn SAR.
5. According to KDB 447498 D01 4.3.1, Standalone SAR test exclusion is as follow:
 For 100 MHz to 6 GHz and test separation distances ≤ 50 mm, the 1-g and 10-g SAR test exclusion thresholds are determined by the following:
 $[(\text{max. power of channel, including tune-up tolerance, mW}) / (\text{min. test separation distance, mm})] \cdot [\sqrt{f(\text{GHz})}] \leq 3.0$ for 1-g SAR, and ≤ 7.5 for 10-g extremity SAR³⁰, where
 - f(GHz) is the RF channel transmit frequency in GHz
 - Power and distance are rounded to the nearest mW and mm before calculation³¹
 - The result is rounded to one decimal place for comparison
 - The values 3.0 and 7.5 are referred to as numeric thresholds in step b) below
 The test exclusions are applicable only when the minimum test separation distance is ≤ 50 mm, and for transmission frequencies between 100 MHz and 6 GHz. When the minimum test separation distance is < 5 mm, a distance of 5 mm according to 4.1 f) is applied to determine SAR test exclusion.
6. If the test separation distance is < 5 mm, 5mm is used for excluded SAR calculation.
7. According to KDB 447498 D01 4.3.2, simultaneous transmission SAR test exclusion is as follow:
 - (1) Simultaneous transmission SAR test exclusion is determined for each operating configuration and exposure condition according to the reported standalone SAR of each applicable simultaneous transmitting antenna.
 - (2) Any transmitters and antennas should be considered when calculating simultaneous mode.
 - (3) For mobile phone and PC, it's the sum of all transmitters and antennas at the same mode with same position in each applicable exposure condition
 - (4) When the standalone SAR test exclusion of section 4.3.2 is applied to an antenna that transmits simultaneously with other antennas, the standalone SAR must be estimated according to the following to det
 $(\text{max. power of channel, including tune-up tolerance, mW}) / (\text{min. test separation distance, mm}) \cdot [\sqrt{f(\text{GHz})} / x] \text{ W/kg}$ for test separation distances ≤ 50 mm;
 where $x = 7.5$ for 1-g SAR, and $x = 18.75$ for 10-g SAR.

The results shown in this test report refer only to the sample(s) tested unless otherwise stated and the sample(s) are retained for 30 days only. The document is issued by AGC, this document cannot be reproduced except in full with our prior written permission. The more details and the authenticity of the report will be confirmed at <http://www.agc-cert.com>.

8. When the sum of SAR is larger than the limit, SAR test exclusion is determined by the SAR to peak location separation ratio. The simultaneous transmitting antennas in each operating mode and exposure condition combination must be considered one pair at a time to determine the SAR to peak location separation ratio to qualify for test exclusion. The ratio is determined by $(SAR1 + SAR2)1.5/R_i$, rounded to two decimal digits, and must be ≤ 0.04 for all antenna pairs in the configuration to qualify for 1-g SAR test exclusion.

Estimated SAR		Max Power including Tune-up Tolerance		Separation Distance (mm)	Estimated SAR (W/kg)
		dBm	mW		
BT	Head	2	1.585	0	0.067
	Body	2	1.585	10	0.033

The results shown in this test report refer only to the sample(s) tested unless otherwise stated and the sample(s) are retained for 30 days only. The document is issued by AGC, this document cannot be reproduced except in full with our prior written permission. The more details and the authenticity of the report will be confirmed at <http://www.agc-cert.com>.

Sum of the SAR for GSM 850 & Wi-Fi & BT:

RF Exposure Conditions	Test Position	Simultaneous Transmission Scenario			Σ1-g SAR (W/Kg)	SPLSR (Yes/No)
		GSM 850	Wi-Fi DTS Band	Bluetooth		
Head (voice)	Left Touch	0.246	0.158		0.404	No
	Left Tilt	0.160	0.153		0.313	No
	Right Touch	0.280	0.301		0.581	No
	Right Tilt	0.169	0.190		0.359	No
Body-worn (voice)	Rear	0.643	0.170		0.813	No
		0.643		0.033	0.676	No
	Front	0.357	0.160		0.517	No
		0.357		0.033	0.390	No
Body-worn (Data)	Rear	1.081		0.033	1.114	No
		1.081	0.170		1.251	No
	Front	0.502		0.033	0.535	No
		0.502	0.160		0.662	No
Body-worn (Hotspot)	Edge 4	0.293	0.179		0.472	No
	Edge 4	0.293		0.033	0.326	No

Note:

- According to KDB 447498 D01 General RF Exposure Guidance, when the simultaneous transmission SAR is less than 1.6 W/Kg, SPLSR assessment is not required.
- SPLSR mean is "The SAR to Peak Location Separation Ratio"

The results shown in this test report refer only to the sample(s) tested unless otherwise stated and the sample(s) are retained for 30 days only. The document is issued by AGC, this document cannot be reproduced except in full with our prior written permission. The more details and the authenticity of the report will be confirmed at <http://www.agc-cert.com>.

Sum of the SAR for PCS 1900 & Wi-Fi & BT:

RF Exposure Conditions	Test Position	Simultaneous Transmission Scenario			Σ1-g SAR (W/Kg)	SPLSR (Yes/No)
		GSM 1900	Wi-Fi DTS Band	Bluetooth		
Head (voice)	Left Touch	0.018	0.158		0.176	No
	Left Tilt	0.006	0.153		0.159	No
	Right Touch	0.016	0.301		0.317	No
	Right Tilt	0.004	0.190		0.194	No
Body-worn (voice)	Rear	0.273	0.170		0.443	No
		0.273		0.033	0.306	No
	Front	0.040	0.160		0.200	No
		0.040		0.033	0.073	No
Body-worn (Data)	Rear	0.723		0.033	0.756	No
		0.723	0.170		0.893	No
	Front	0.118		0.033	0.151	No
		0.118	0.160		0.278	No
Body-worn (Hotspot)	Edge 4	0.019	0.179		0.198	No
	Edge 4	0.019		0.033	0.052	No

Note:

- According to KDB 447498 D01 General RF Exposure Guidance, when the simultaneous transmission SAR is less than 1.6 W/Kg, SPLSR assessment is not required.
- SPLSR mean is "The SAR to Peak Location Separation Ratio"

The results shown in this test report refer only to the sample(s) tested unless otherwise stated and the sample(s) are retained for 30 days only. The document is issued by AGC, this document cannot be reproduced except in full with our prior written permission. The more details and the authenticity of the report will be confirmed at <http://www.agc-cert.com>.

Sum of the SAR for WCDMA Band II & Wi-Fi & BT:

RF Exposure Conditions	Test Position	Simultaneous Transmission Scenario			Σ1-g SAR (W/Kg)	SPLSR (Yes/No)
		WCDMA Band II	Wi-Fi DTS Band	Bluetooth		
Head	Left Touch	0.031	0.158		0.189	No
	Left Tilt	0.011	0.153		0.164	No
	Right Touch	0.030	0.301		0.331	No
	Right Tilt	0.009	0.190		0.199	No
Body-worn	Rear	0.551	0.170		0.721	No
	Front	0.088	0.160		0.248	No
	Edge 4	0.013	0.179		0.192	No
	Rear	0.551		0.033	0.584	No
	Front	0.088		0.033	0.121	No
	Edge 4	0.013		0.033	0.046	No

Note:

- According to KDB 447498 D01 General RF Exposure Guidance, when the simultaneous transmission SAR is less than 1.6 W/Kg, SPLSR assessment is not required.
- SPLSR mean is "The SAR to Peak Location Separation Ratio "

The results shown in this test report refer only to the sample(s) tested unless otherwise stated and the sample(s) are retained for 30 days only. The document is issued by AGC, this document cannot be reproduced except in full with our prior written permission. The more details and the authenticity of the report will be confirmed at <http://www.agc-cert.com>.

Sum of the SAR for WCDMA Band V & Wi-Fi & BT:

RF Exposure Conditions	Test Position	Simultaneous Transmission Scenario			Σ1-g SAR (W/Kg)	SPLSR (Yes/No)
		WCDMA Band V	Wi-Fi DTS Band	Bluetooth		
Head	Left Touch	0.049	0.158		0.207	No
	Left Tilt	0.033	0.153		0.186	No
	Right Touch	0.050	0.301		0.351	No
	Right Tilt	0.039	0.190		0.229	No
Body-worn	Rear	0.255	0.170		0.425	No
	Front	0.089	0.160		0.249	No
	Edge 4	0.060	0.179		0.239	No
	Rear	0.255		0.033	0.288	No
	Front	0.089		0.033	0.122	No
	Edge 4	0.060		0.033	0.093	No

Note:

- According to KDB 447498 D01 General RF Exposure Guidance, when the simultaneous transmission SAR is less than 1.6 W/Kg, SPLSR assessment is not required.
- SPLSR mean is "The SAR to Peak Location Separation Ratio "

The results shown in this test report refer only to the sample(s) tested unless otherwise stated and the sample(s) are retained for 30 days only. The document is issued by AGC, this document cannot be reproduced except in full with our prior written permission. The more details and the authenticity of the report will be confirmed at <http://www.agc-cert.com>.

APPENDIX A. SAR SYSTEM CHECK DATA

Test Laboratory: AGC Lab

Date: May 02,2019

System Check Head 835 MHz

DUT: Dipole 835 MHz Type: SID 835

Communication System CW; Communication System Band: D835 (835.0 MHz); Duty Cycle: 1:1; Conv.F=5.29

Frequency: 835 MHz; Medium parameters used: $f = 835$ MHz; $\sigma = 0.92$ mho/m; $\epsilon_r = 40.69$; $\rho = 1000$ kg/m³ ;

Phantom section: Flat Section; Input Power=18dBm

Ambient temperature (°C):22.4, Liquid temperature (°C): 22.1

SATIMO Configuration

- Probe: SSE5; Calibrated: Aug. 08,2018; Serial No.: SN 22/12 EP159
- Sensor-Surface: 4mm (Mechanical Surface Detection)
- Phantom: SAM twin phantom
- Measurement SW: OpenSAR V4_02_35

Configuration/System Check 835MHz Head/Area Scan: Measurement grid: dx=8mm, dy=8mm

Configuration/System Check 835MHz Head/Zoom Scan: Measurement grid: dx=8mm,dy=8mm, dz=5mm

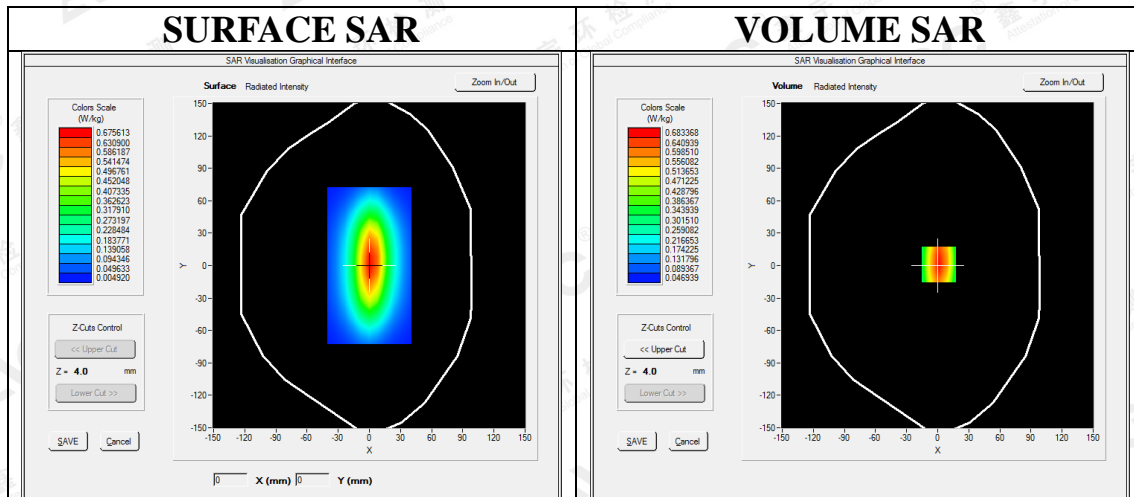

Maximum location: X=1.00, Y=1.00

SAR Peak: 1.00 W/kg

SAR 10g (W/Kg)	0.394289
SAR 1g (W/Kg)	0.651528

The results shown in this test report refer only to the sample(s) tested unless otherwise stated and the sample(s) are retained for 30 days only. The document is issued by AGC, this document cannot be reproduced except in full with our prior written permission. The more details and the authenticity of the report will be confirmed at <http://www.agc-cert.com>.

Z (mm)	0.00	4.00	9.00	14.00	19.00	24.00	29.00
SAR (W/Kg)	1.0082	0.6856	0.4228	0.2751	0.1849	0.1263	0.0874

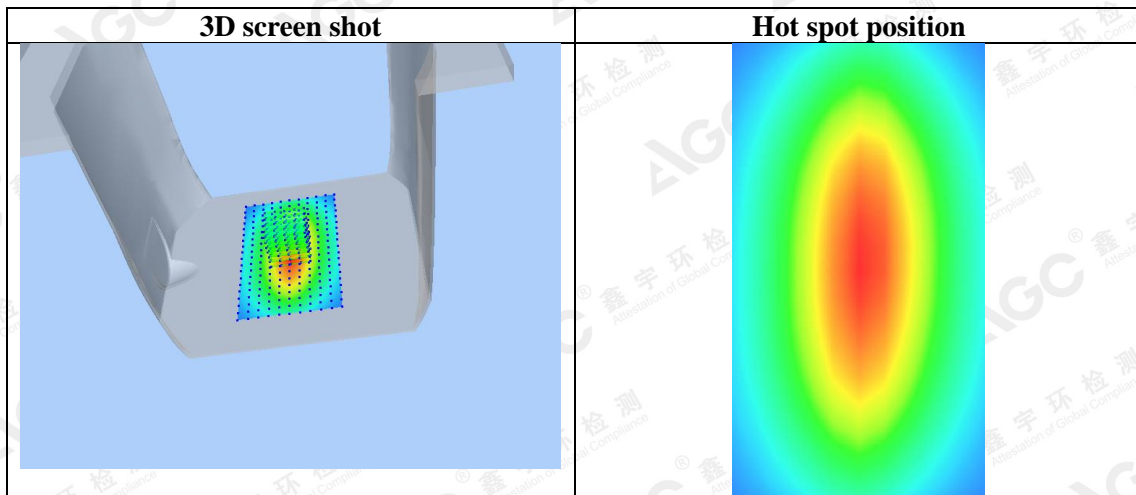
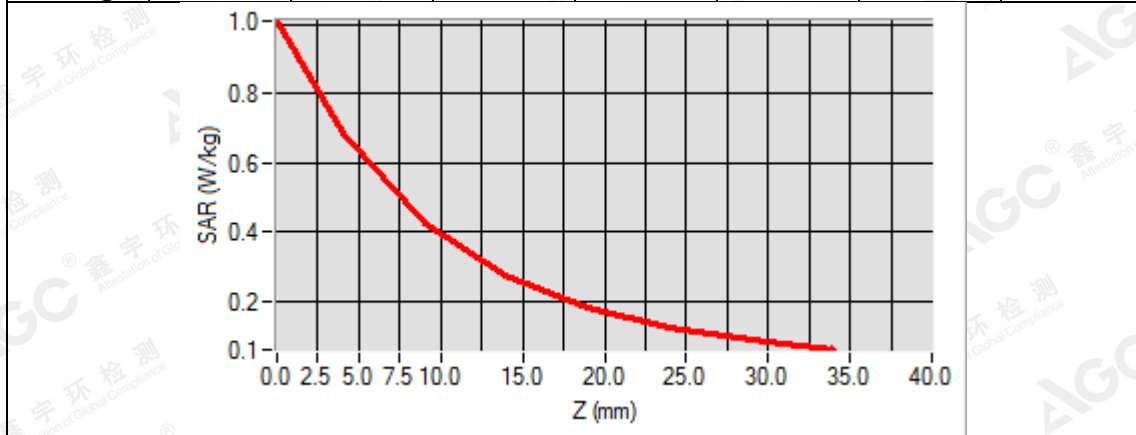

The results shown in this test report refer only to the sample(s) tested otherwise stated and the sample(s) are retained for 30 days only. The document is issued by AGC, this document cannot be reproduced except in full with our prior written permission. The more details and the authenticity of the report will be confirmed at <http://www.agc-cert.com>.

Test Laboratory: AGC Lab

Date: May 02, 2019

System Check Body 835 MHz

DUT: Dipole 835 MHz Type: SID 835

Communication System CW; Communication System Band: D835 (835.0 MHz); Duty Cycle: 1:1; Conv.F=5.49

Frequency: 835 MHz; Medium parameters used: $f = 835$ MHz; $\sigma = 0.99$ mho/m; $\epsilon_r = 53.68$; $\rho = 1000$ kg/m³ ;

Phantom section: Flat Section; Input Power=18dBm

Ambient temperature (°C):22.4, Liquid temperature (°C): 22.0

SATIMO Configuration

- Probe: SSE5; Calibrated: Aug. 08,2018; Serial No.: SN 22/12 EP159
- Sensor-Surface: 4mm (Mechanical Surface Detection)
- Phantom: SAM twin phantom
- Measurement SW: OpenSAR V4_02_35

Configuration/System Check 835MHz Body/Area Scan: Measurement grid: dx=8mm, dy=8mm

Configuration/System Check 835MHz Body/Zoom Scan: Measurement grid: dx=8mm,dy=8mm, dz=5mm

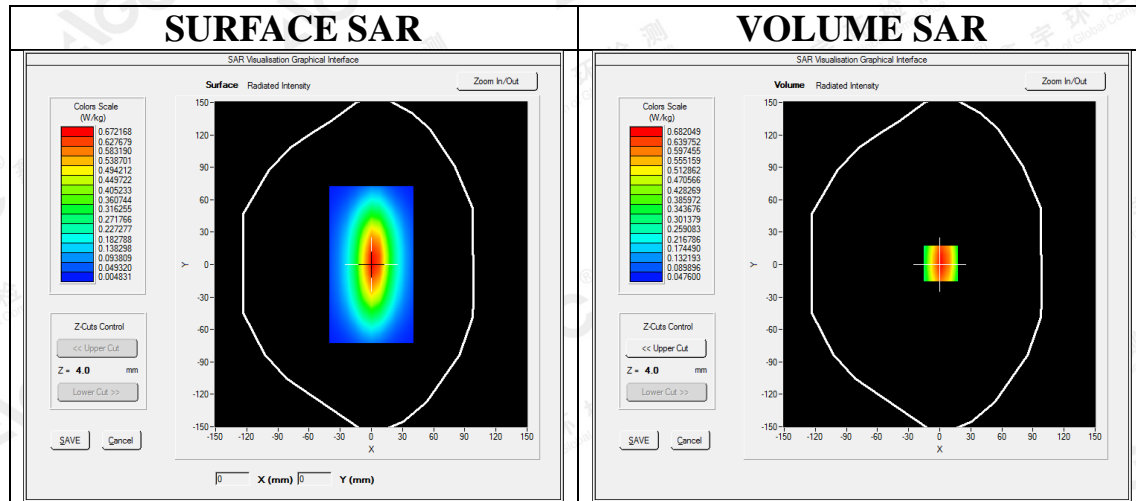

Maximum location: X=1.00, Y=1.00

SAR Peak: 1.00 W/kg

SAR 10g (W/Kg)	0.395816
SAR 1g (W/Kg)	0.652841

The results shown in this test report refer only to the sample(s) tested unless otherwise stated and the sample(s) are retained for 30 days only. The document is issued by AGC, this document cannot be reproduced except in full with our prior written permission. The more details and the authenticity of the report will be confirmed at <http://www.agc-cert.com>.

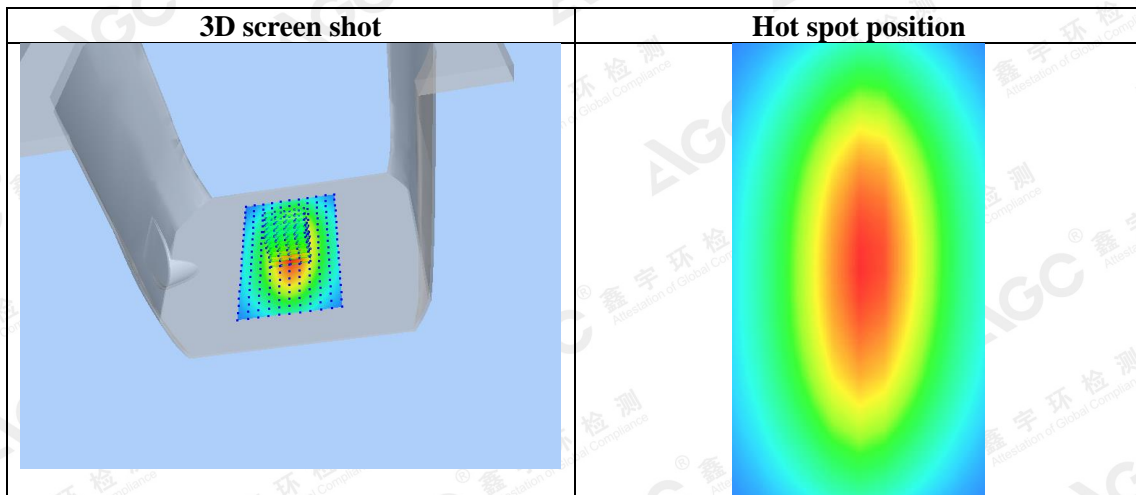
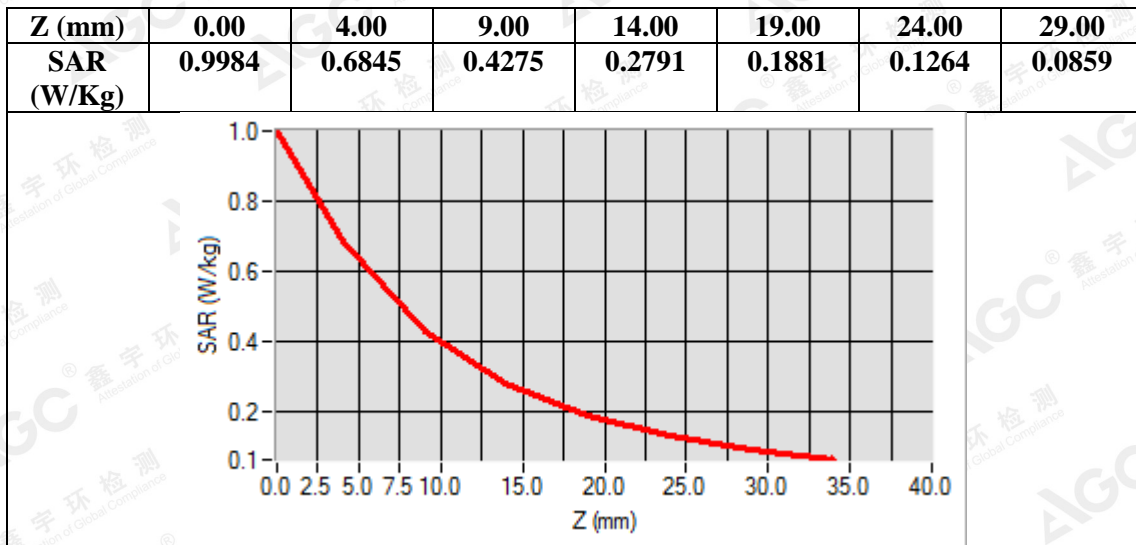

The results shown in this test report refer only to the sample(s) tested otherwise stated and the sample(s) are retained for 30 days only. The document is issued by AGC, this document cannot be reproduced except in full with our prior written permission. The more details and the authenticity of the report will be confirmed at <http://www.agc-cert.com>.

Test Laboratory: AGC Lab

Date: May 05,2019

System Check Head 1900MHz

DUT: Dipole 1900 MHz; Type: SID 1900

Communication System: CW; Communication System Band: D1900 (1900.0 MHz); Duty Cycle:1:1; Conv.F=5.24

Frequency: 1900 MHz; Medium parameters used: $f = 1850$ MHz; $\sigma = 1.41$ mho/m; $\epsilon_r = 39.47$; $\rho = 1000$ kg/m³ ;

Phantom section: Flat Section; Input Power=18dBm

Ambient temperature (°C):22.0, Liquid temperature (°C): 21.6

SATIMO Configuration:

- Probe: SSE5; Calibrated: Aug. 08,2018; Serial No.: SN 22/12 EP159
- Sensor-Surface: 4mm (Mechanical Surface Detection)
- Phantom: SAM twin phantom
- Measurement SW: OpenSAR V4_02_35

Configuration/System Check 1900MHz Head/Area Scan: Measurement grid: dx=8mm, dy=8mm

Configuration/System Check 1900MHz Head/Zoom Scan: Measurement grid: dx=8mm,dy=8mm, dz=5mm

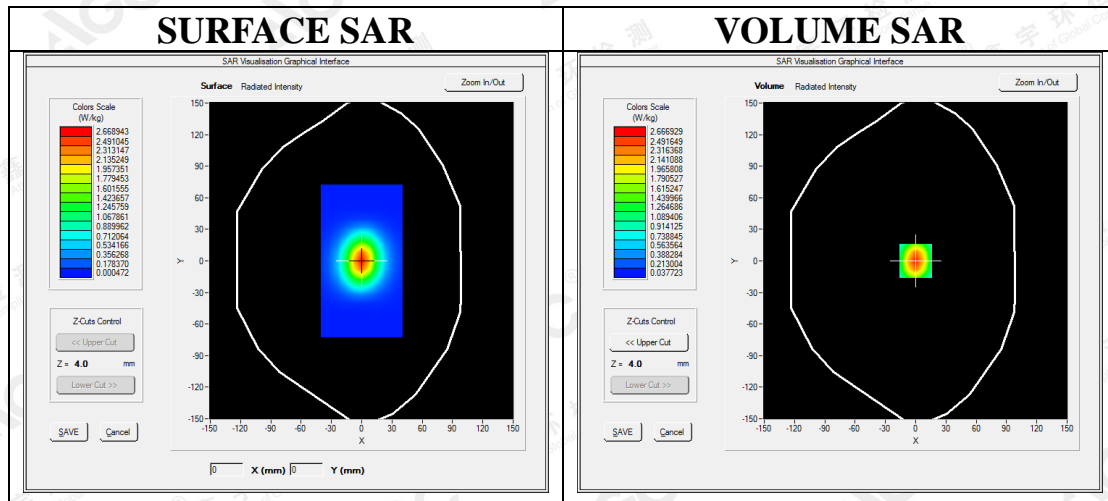

Maximum location: X=0.00, Y=0.00

SAR Peak: 4.29 W/kg

SAR 10g (W/Kg)	1.287581
SAR 1g (W/Kg)	2.514397

The results shown in this test report refer only to the sample(s) tested unless otherwise stated and the sample(s) are retained for 30 days only. The document is issued by AGC, this document cannot be reproduced except in full with our prior written permission. The more details and the authenticity of the report will be confirmed at <http://www.agc-cert.com>.

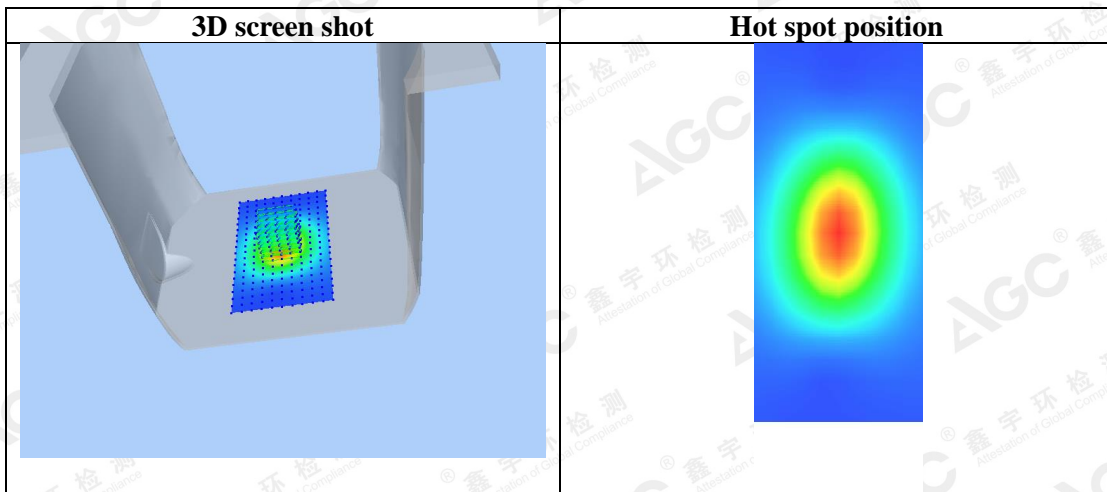
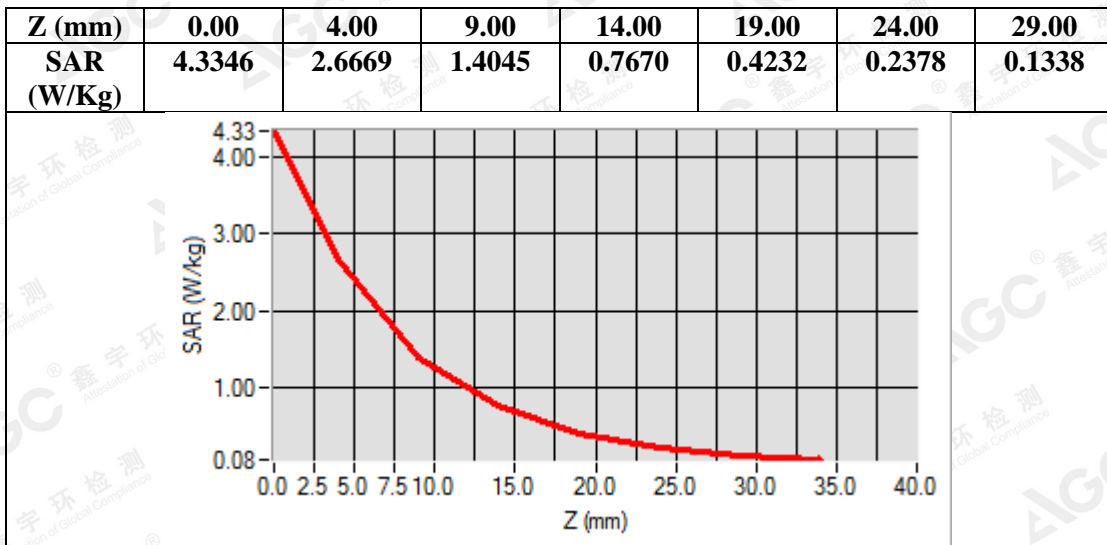

The results shown in this test report refer only to the sample(s) tested unless otherwise stated and the sample(s) are retained for 30 days only. The document is issued by AGC, this document cannot be reproduced except in full with our prior written permission. The more details and the authenticity of the report will be confirmed at <http://www.agc-cert.com>.

Test Laboratory: AGC Lab

Date: May 05,2019

System Check Body 1900MHz

DUT: Dipole 1900 MHz; Type: SID 1900

Communication System: CW; Communication System Band: D1900 (1900.0 MHz); Duty Cycle:1:1; Conv.F=5.39

Frequency: 1900 MHz; Medium parameters used: $f = 1850$ MHz; $\sigma = 1.49$ mho/m; $\epsilon_r = 52.63$; $\rho = 1000$ kg/m³ ;

Phantom section: Flat Section; Input Power=18dBm

Ambient temperature (°C):22.0, Liquid temperature (°C): 21.7

SATIMO Configuration:

- Probe: SSE5; Calibrated: Aug. 08,2018; Serial No.: SN 22/12 EP159
- Sensor-Surface: 4mm (Mechanical Surface Detection)
- Phantom: SAM twin phantom
- Measurement SW: OpenSAR V4_02_35

Configuration/System Check 1900MHz Body/Area Scan: Measurement grid: dx=8mm, dy=8mm

Configuration/System Check 1900MHz Body/Zoom Scan: Measurement grid: dx=8mm,dy=8mm, dz=5mm

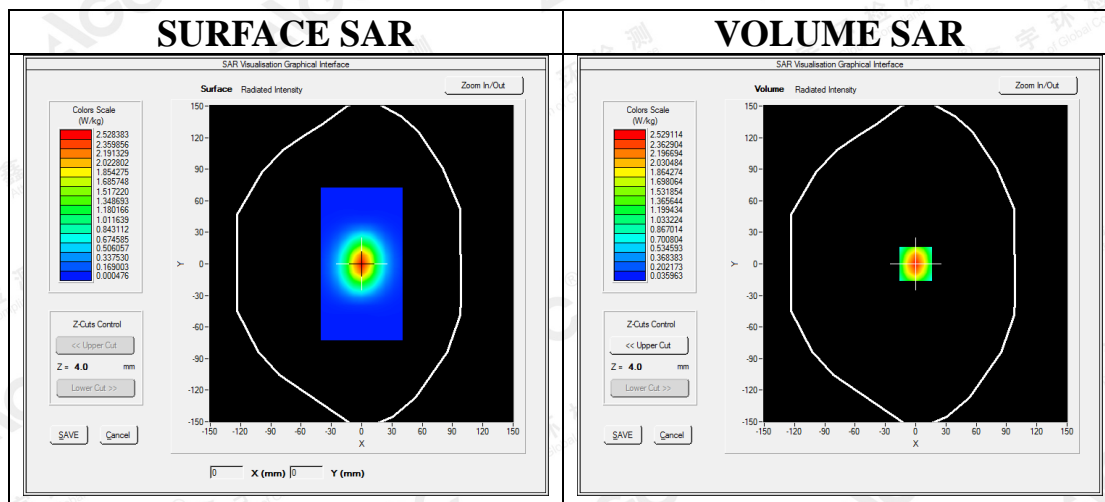

Maximum location: X=0.00, Y=0.00

SAR Peak: 4.08 W/kg

SAR 10g (W/Kg)	1.224921
SAR 1g (W/Kg)	2.386927

The results shown in this test report refer only to the sample(s) tested unless otherwise stated and the sample(s) are retained for 30 days only. The document is issued by AGC, this document cannot be reproduced except in full with our prior written permission. The more details and the authenticity of the report will be confirmed at <http://www.agc-cert.com>.

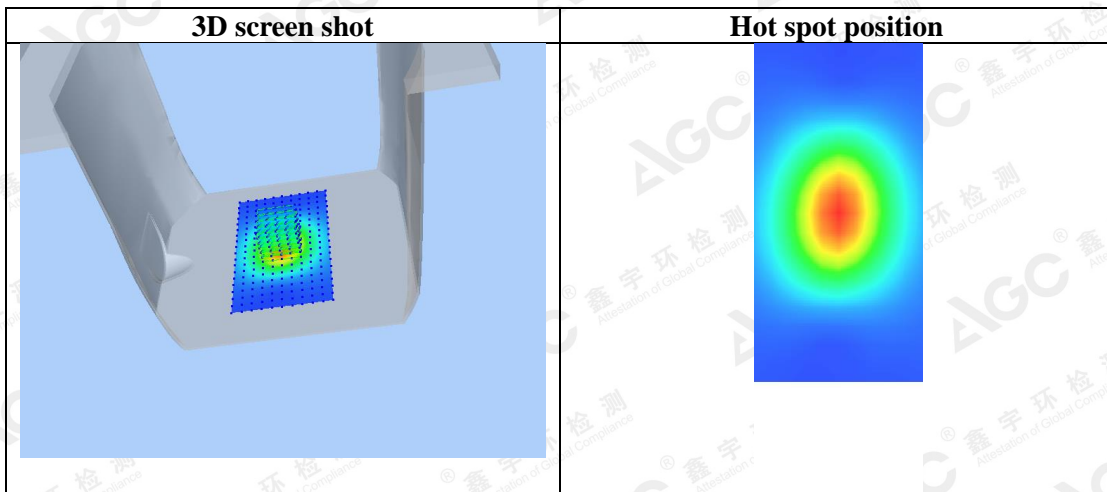
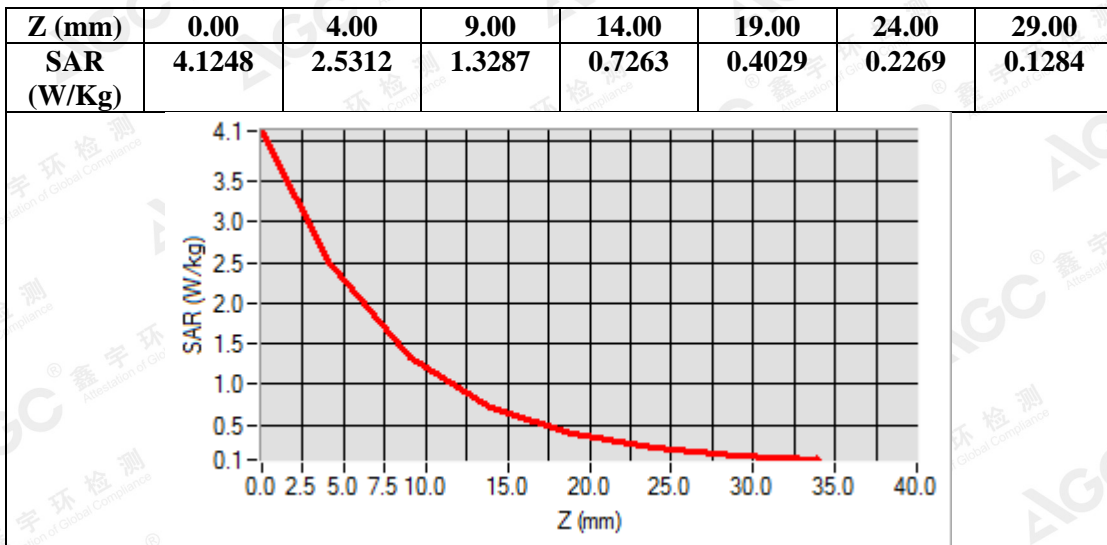

The results shown in this test report refer only to the sample(s) tested unless otherwise stated and the sample(s) are retained for 30 days only. The document is issued by AGC, this document cannot be reproduced except in full with our prior written permission. The more details and the authenticity of the report will be confirmed at <http://www.agc-cert.com>.

Test Laboratory: AGC Lab

Date: May 06,2019

System Check Head 2450 MHz

DUT: Dipole 2450 MHz Type: SID 2450

Communication System CW; Communication System Band: D2450 (2450.0 MHz); Duty Cycle: 1:1; Conv.F=4.90

Frequency: 2450 MHz; Medium parameters used: $f = 2450$ MHz; $\sigma = 1.77$ mho/m; $\epsilon_r = 38.69$; $\rho = 1000$ kg/m³ ;

Phantom section: Flat Section; Input Power=18dBm

Ambient temperature (°C):21.9, Liquid temperature (°C): 21.6

SATIMO Configuration

- Probe: SSE5; Calibrated: Aug. 08,2018; Serial No.: SN 22/12 EP159
- Sensor-Surface: 4mm (Mechanical Surface Detection)
- Phantom: SAM twin phantom
- Measurement SW: OpenSAR V4_02_35

Configuration/System Check 2450MHz Head/Area Scan: Measurement grid: dx=8mm, dy=8mm

Configuration/System Check 2450MHz Head/Zoom Scan: Measurement grid: dx=5mm,dy=5mm, dz=5mm

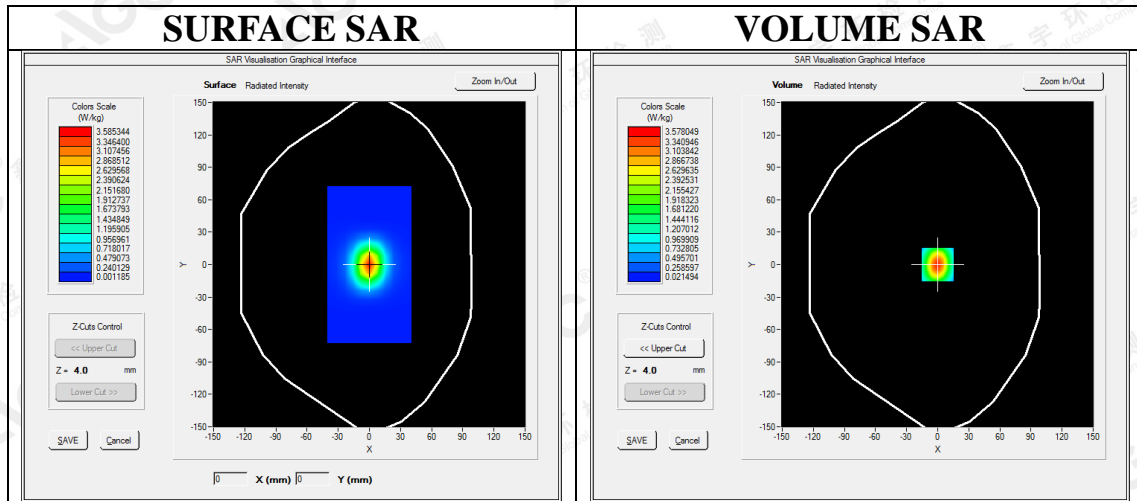

Maximum location: X=0.00, Y=0.00
SAR Peak: 5.99 W/kg

SAR 10g (W/Kg)	1.518265
SAR 1g (W/Kg)	3.262483

The results shown in this test report refer only to the sample(s) tested unless otherwise stated and the sample(s) are retained for 30 days only. The document is issued by AGC, this document cannot be reproduced except in full with our prior written permission. The more details and the authenticity of the report will be confirmed at <http://www.agc-cert.com>.

Z (mm)	0.00	4.00	9.00	14.00	19.00	24.00	29.00
SAR (W/Kg)	6.0626	3.5745	1.7429	0.8641	0.4326	0.2203	0.1118

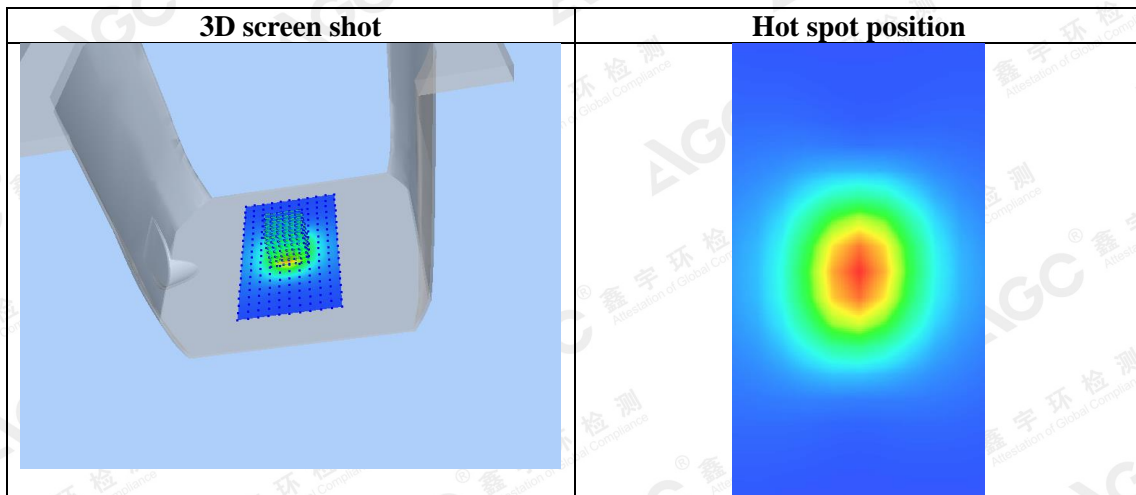
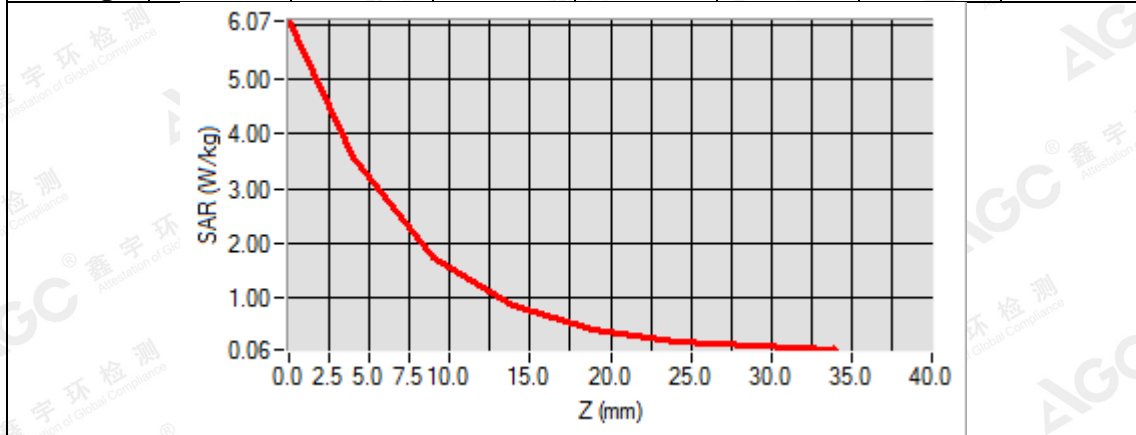

The results shown in this test report refer only to the sample(s) tested otherwise stated and the sample(s) are retained for 30 days only. The document is issued by AGC, this document cannot be reproduced except in full with our prior written permission. The more details and the authenticity of the report will be confirmed at <http://www.agc-cert.com>.

Test Laboratory: AGC Lab

Date: May 06,2019

System Check Body 2450 MHz

DUT: Dipole 2450 MHz Type: SID 2450

Communication System CW; Communication System Band: D2450 (2450.0 MHz); Duty Cycle: 1:1; Conv.F=5.04

Frequency: 2450 MHz; Medium parameters used: $f = 2450$ MHz; $\sigma = 1.99$ mho/m; $\epsilon_r = 53.21$; $\rho = 1000$ kg/m³ ;

Phantom section: Flat Section; Input Power=18dBm

Ambient temperature (°C):21.9, Liquid temperature (°C): 21.5

SATIMO Configuration

- Probe: SSE5; Calibrated: Aug. 08,2018; Serial No.: SN 22/12 EP159
- Sensor-Surface: 4mm (Mechanical Surface Detection)
- Phantom: SAM twin phantom
- Measurement SW: OpenSAR V4_02_35

Configuration/System Check 2450MHz Body/Area Scan: Measurement grid: dx=8mm, dy=8mm

Configuration/System Check 2450MHz Body/Zoom Scan: Measurement grid: dx=5mm,dy=5mm, dz=5mm

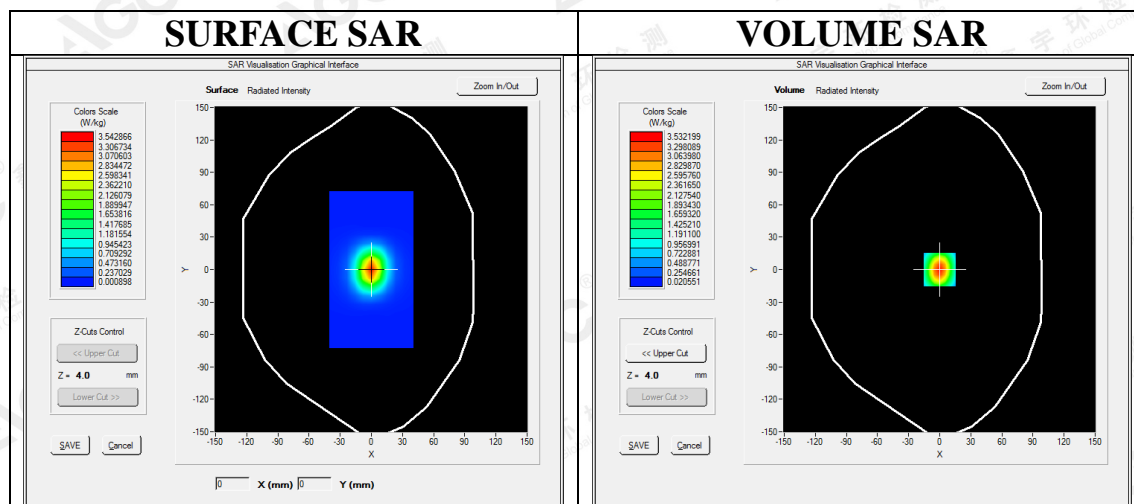

Maximum location: X=0.00, Y=0.00

SAR Peak: 5.93 W/kg

SAR 10g (W/Kg)	1.497521
SAR 1g (W/Kg)	3.221685

The results shown in this test report refer only to the sample(s) tested unless otherwise stated and the sample(s) are retained for 30 days only. The document is issued by AGC, this document cannot be reproduced except in full with our prior written permission. The more details and the authenticity of the report will be confirmed at <http://www.agc-cert.com>.

Z (mm)	0.00	4.00	9.00	14.00	19.00	24.00	29.00
SAR (W/Kg)	5.9935	3.5312	1.7156	0.8452	0.4232	0.2156	0.1061

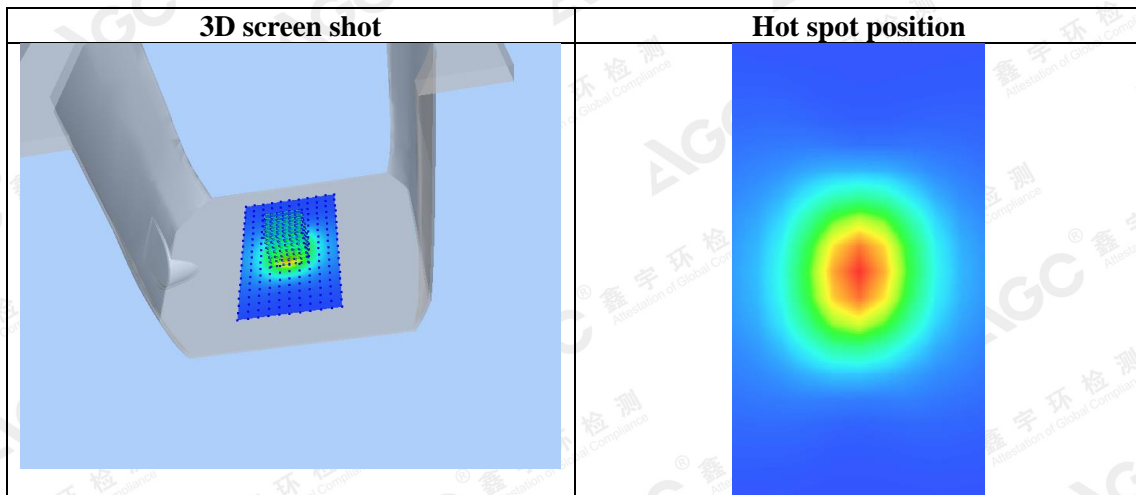
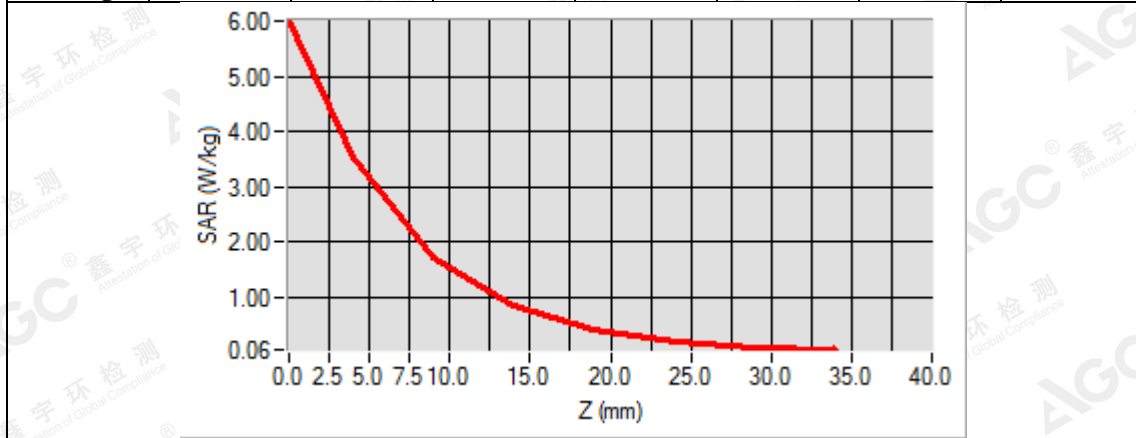

The results shown in this test report refer only to the sample(s) tested otherwise stated and the sample(s) are retained for 30 days only. The document is issued by AGC, this document cannot be reproduced except in full with our prior written permission. The more details and the authenticity of the report will be confirmed at <http://www.agc-cert.com>.

APPENDIX B. SAR MEASUREMENT DATA

Test Laboratory: AGC Lab
GSM 850 Mid-Touch-Right <SIM 1>
DUT: Smart phone; Type: 4GO

Date: May 02,2019

Communication System: Generic GSM; Communication System Band: GSM 850; Duty Cycle: 1:8.3; Conv.F=5.29;
Frequency: 836.6 MHz; Medium parameters used: $f = 835$ MHz; $\sigma = 0.93$ mho/m; $\epsilon r = 40.53$; $\rho = 1000$ kg/m³ ;
Phantom section: Right Section
Ambient temperature (°C): 22.4, Liquid temperature (°C): 22.1

SATIMO Configuration:

- Probe: SSE5; Calibrated: Aug. 08,2018; Serial No.: SN 22/12 EP159
- Sensor-Surface: 4mm (Mechanical Surface Detection)
- Phantom: SAM twin phantom
- Measurement SW: OpenSAR V4_02_35

Configuration/GSM 850 Mid-Touch-Right/Area Scan: Measurement grid: dx=8mm, dy=8mm
Configuration/GSM 850 Mid-Touch-Right/Zoom Scan: Measurement grid: dx=8mm,dy=8mm, dz=5mm;

Area Scan	dx=8mm dy=8mm, h= 5.00 mm
ZoomScan	5x5x7,dx=8mm dy=8mm dz=5mm,Complete
Phantom	Right head
Device Position	Cheek
Band	GSM 850
Channels	Middle
Signal	TDMA (Crest factor: 8.0)

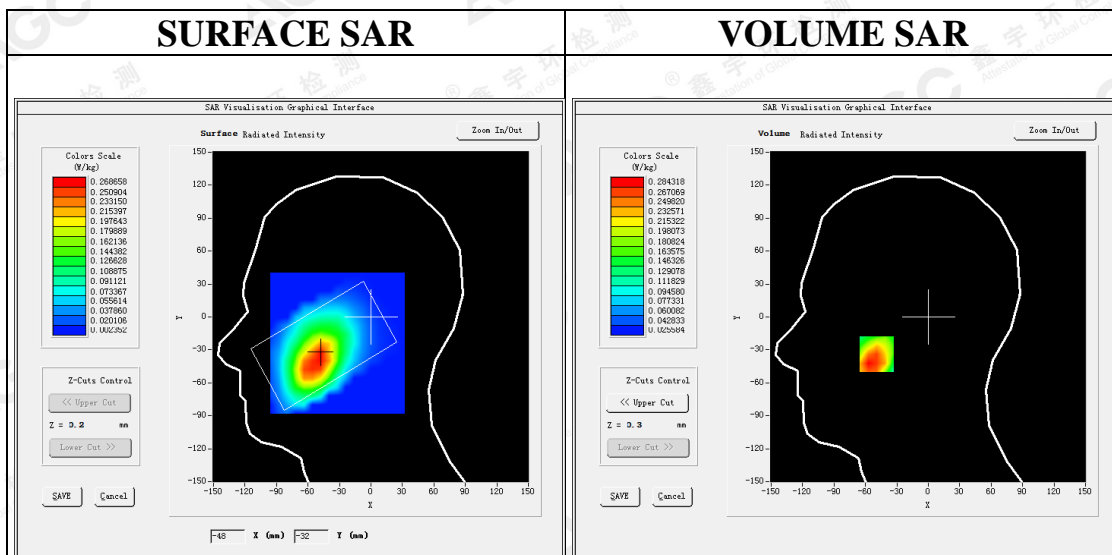

Maximum location: X=-49.00, Y=-34.00
SAR Peak: 0.38 W/kg

SAR 10g (W/Kg)	0.184822
SAR 1g (W/Kg)	0.271518

The results shown in this test report refer only to the sample(s) tested unless otherwise stated and the sample(s) are retained for 30 days only. The document is issued by AGC, this document cannot be reproduced except in full with our prior written permission. The more details and the authenticity of the report will be confirmed at <http://www.agc-cert.com>.

Z (mm)	0.00	4.00	9.00	14.00	19.00	24.00	29.00
SAR (W/Kg)	0.4793	0.2843	0.1557	0.1542	0.1002	0.0853	0.0620

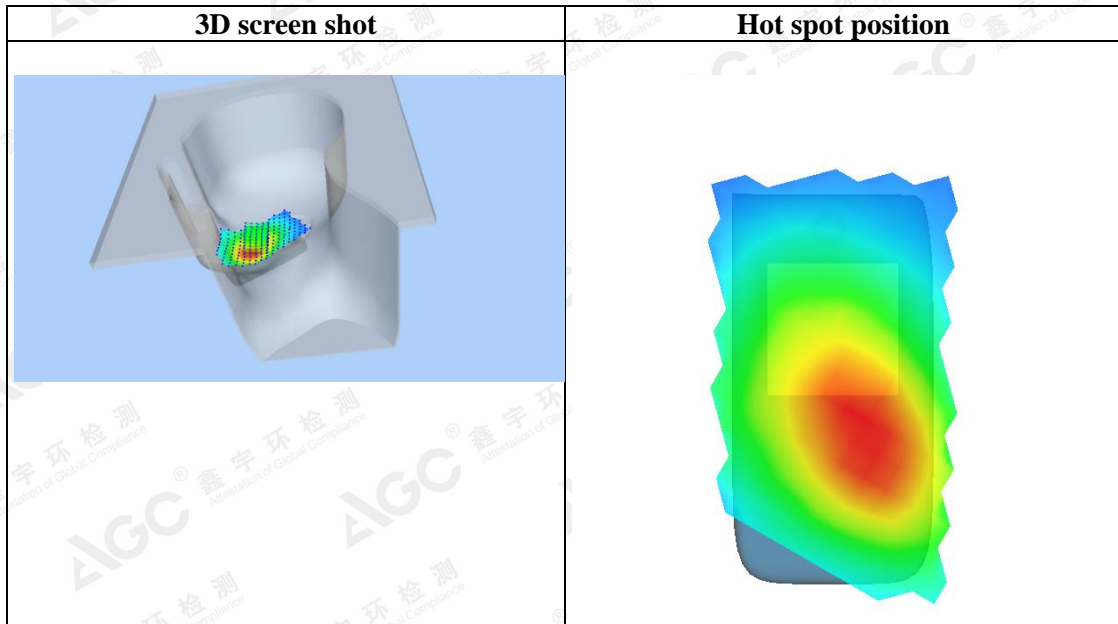
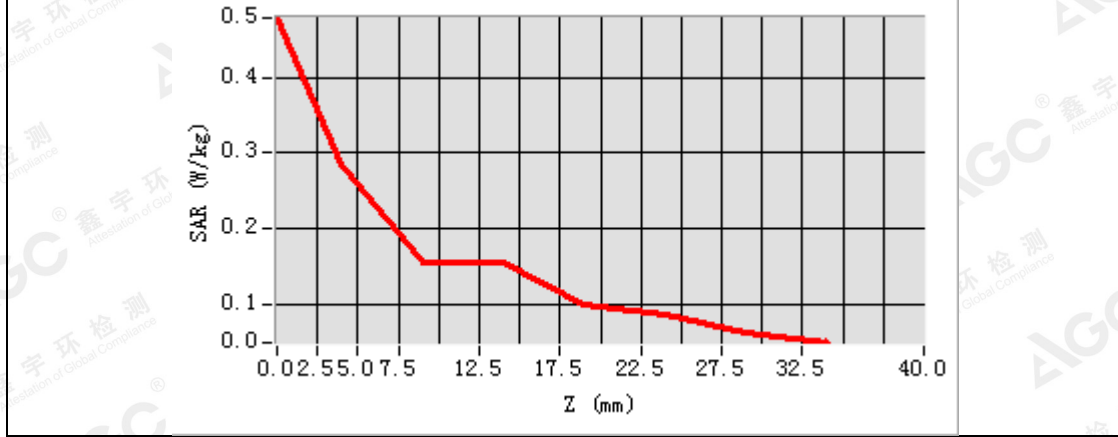

The results shown in this test report refer only to the sample(s) tested unless otherwise stated and the sample(s) are retained for 30 days only. The document is issued by AGC, this document cannot be reproduced except in full with our prior written permission. The more details and the authenticity of the report will be confirmed at <http://www.agc-cert.com>.

Test Laboratory: AGC Lab
GSM 850 Mid- Body- Back (MS)<SIM 1>
DUT: Smart phone; Type: 4GO

Date: May 02,2019

Communication System: Generic GSM; Communication System Band: GSM 850; Duty Cycle: 1:8.3; Conv.F=5.49;
Frequency: 836.6 MHz; Medium parameters used: $f = 835$ MHz; $\sigma = 0.99$ mho/m; $\epsilon_r = 53.29$; $\rho = 1000$ kg/m³ ;
Phantom section: Flat Section
Ambient temperature (°C): 22.4, Liquid temperature (°C): 22.0

SATIMO Configuration:

- Probe: SSE5; Calibrated: Aug. 08,2018; Serial No.: SN 22/12 EP159
- Sensor-Surface: 4mm (Mechanical Surface Detection)
- Phantom: SAM twin phantom
- Measurement SW: OpenSAR V4_02_35

Configuration/GSM 850 Mid-Body-Back/Area Scan: Measurement grid: dx=10mm, dy=10mm
Configuration/GSM 850 Mid-Body-Back/Zoom Scan: Measurement grid: dx=8mm,dy=8mm, dz=5mm;

Area Scan	surf_sam_plan.txt, h= 5.00 mm
ZoomScan	5x5x7,dx=8mm dy=8mm dz=5mm,Complete
Phantom	Validation plane
Device Position	Body Back
Band	GSM 850
Channels	Middle
Signal	TDMA (Crest factor: 8.0)

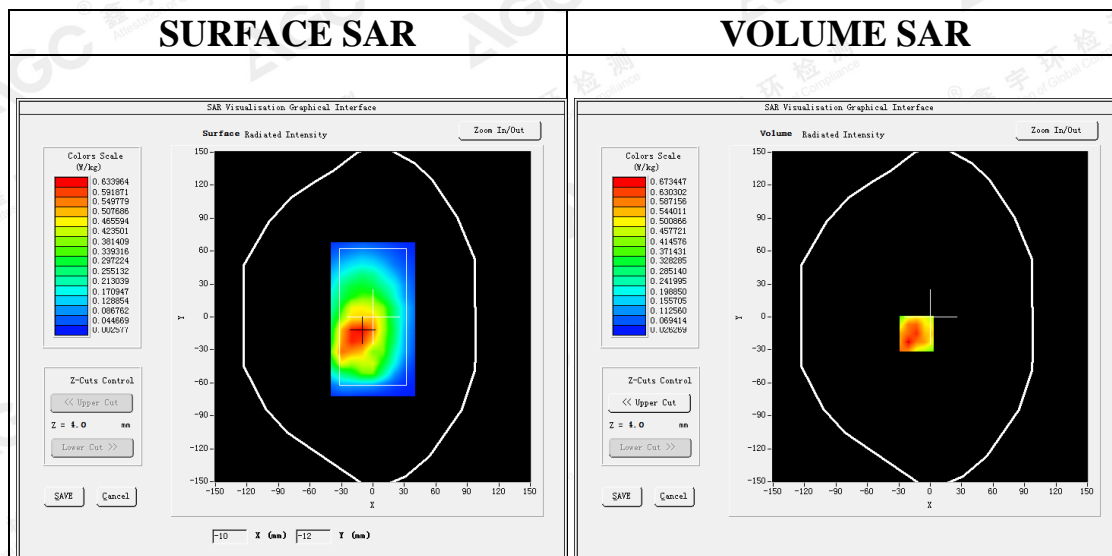

Maximum location: X=-13.00, Y=-15.00
SAR Peak: 0.94 W/kg

SAR 10g (W/Kg)	0.410416
SAR 1g (W/Kg)	0.624700

The results shown in this test report refer only to the sample(s) tested unless otherwise stated and the sample(s) are retained for 30 days only. The document is issued by AGC, this document cannot be reproduced except in full with our prior written permission. The more details and the authenticity of the report will be confirmed at <http://www.agc-cert.com>.

Z (mm)	0.00	4.00	9.00	14.00	19.00	24.00	29.00
SAR (W/Kg)	1.0108	0.6734	0.4075	0.3406	0.2200	0.1484	0.1195

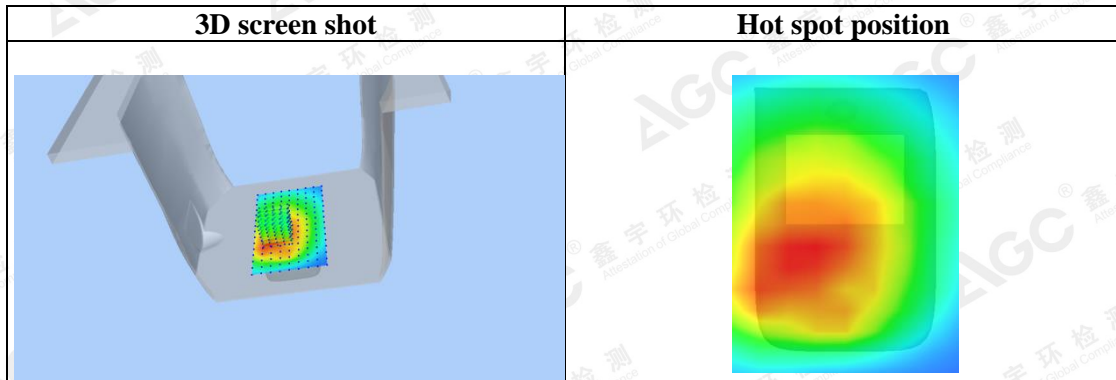
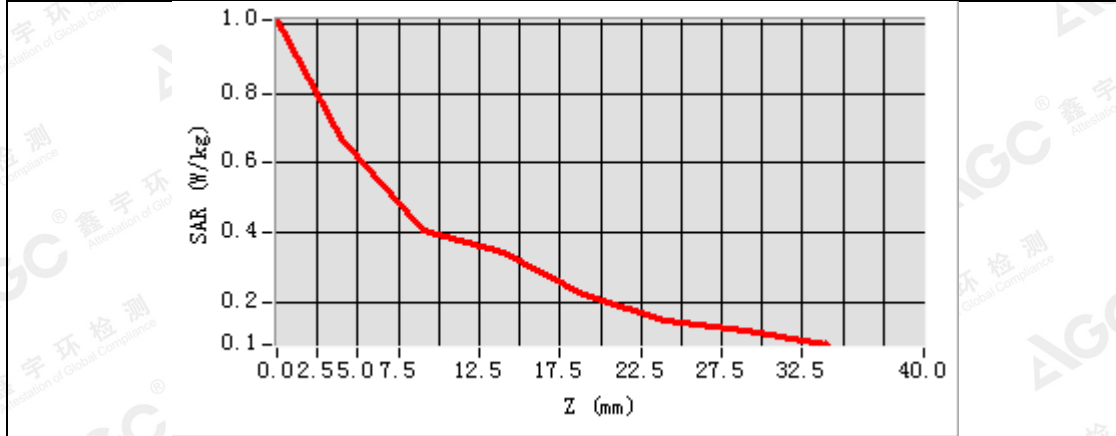

The results shown in this test report refer only to the sample(s) tested unless otherwise stated and the sample(s) are retained for 30 days only. The document is issued by AGC, this document cannot be reproduced except in full with our prior written permission. The more details and the authenticity of the report will be confirmed at <http://www.agc-cert.com>.

Test Laboratory: AGC Lab
GPRS 850 High- Body- Back (3up)
DUT: Smart phone; Type: 4G0

Date: May 02,2019

Communication System: GPRS-3 Slot; Communication System Band: GSM 850; Duty Cycle: 1:2.7; Conv.F=5.49;
Frequency: 848.8 MHz; Medium parameters used: $f = 835$ MHz; $\sigma = 1.01$ mho/m; $\epsilon_r = 52.56$; $\rho = 1000$ kg/m³ ;
Phantom section: Flat Section
Ambient temperature (°C): 22.4, Liquid temperature (°C): 22.0

SATIMO Configuration:

- Probe: SSE5; Calibrated: Aug. 08,2018; Serial No.: SN 22/12 EP159
- Sensor-Surface: 4mm (Mechanical Surface Detection)
- Phantom: SAM twin phantom
- Measurement SW: OpenSAR V4_02_35

Configuration/GPRS 850 High-Body-Back/Area Scan: Measurement grid: dx=10mm, dy=10mm
Configuration/GPRS 850 High-Body-Back/Zoom Scan: Measurement grid: dx=8mm,dy=8mm, dz=5mm;

Area Scan	surf_sam_plan.txt, h= 5.00 mm
Zoom Scan	5x5x7,dx=8mm dy=8mm dz=5mm,Complete
Phantom	Validation plane
Device Position	Body Back
Band	GSM 850
Channels	High
Signal	TDMA (Crest factor: 2.7)

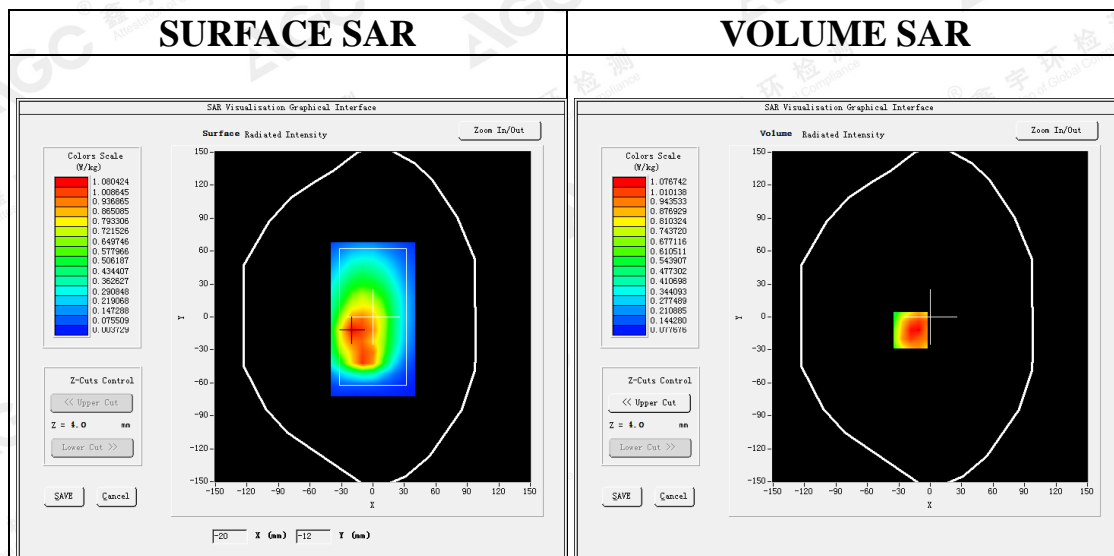

Maximum location: X=-19.00, Y=-12.00
SAR Peak: 1.50 W/kg

SAR 10g (W/Kg)	0.703738
SAR 1g (W/Kg)	1.043677

The results shown in this test report refer only to the sample(s) tested unless otherwise stated and the sample(s) are retained for 30 days only. The document is issued by AGC, this document cannot be reproduced except in full with our prior written permission. The more details and the authenticity of the report will be confirmed at <http://www.agc-cert.com>.

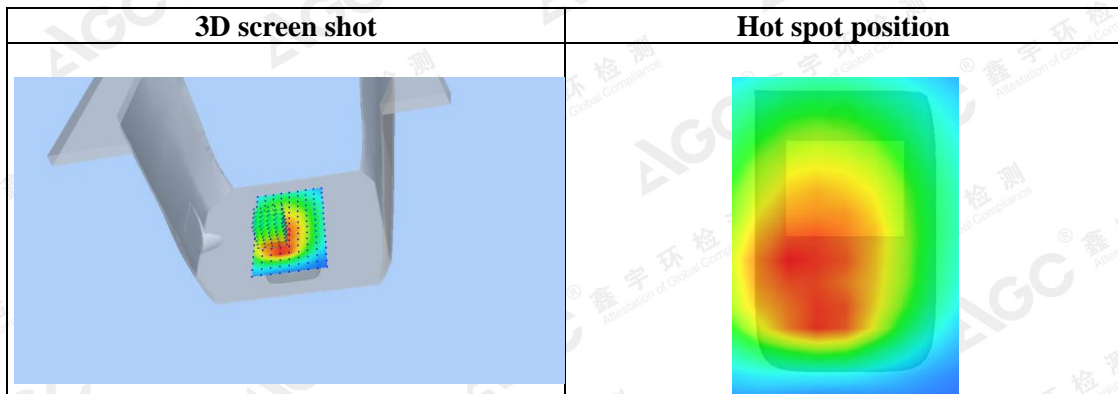
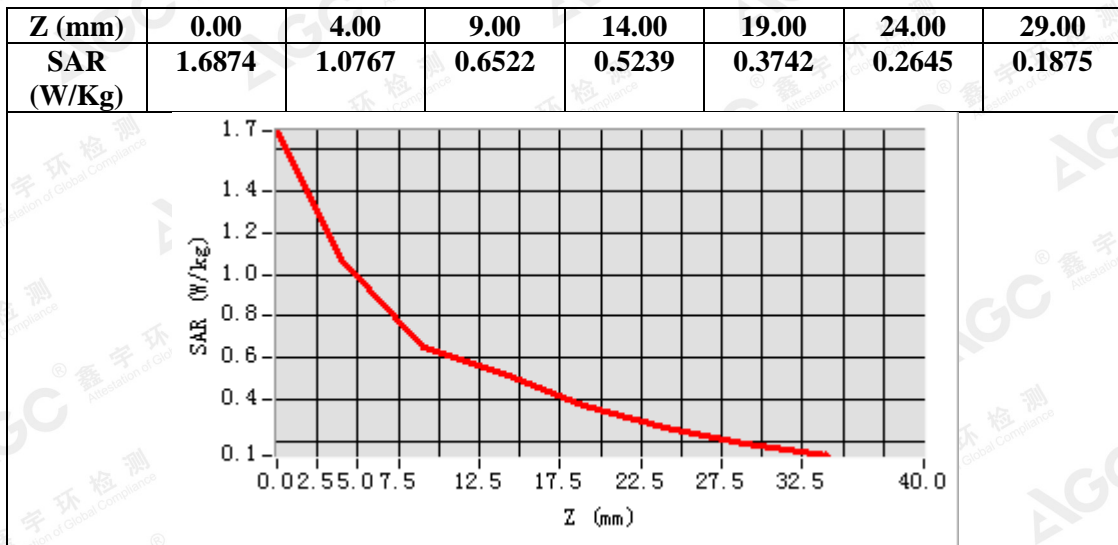

The results shown in this test report refer only to the sample(s) tested unless otherwise stated and the sample(s) are retained for 30 days only. The document is issued by AGC, this document cannot be reproduced except in full with our prior written permission. The more details and the authenticity of the report will be confirmed at <http://www.agc-cert.com>.

Test Laboratory: AGC Lab
PCS 1900 Mid-Touch- Left <SIM 1>
DUT: Smart phone; Type: 4GO

Date: May 05,2019

Communication System: Generic GSM; Communication System Band: PCS 1900; Duty Cycle: 1:8.3; Conv.F=5.24;
Frequency: 1880 MHz; Medium parameters used: $f = 1850$ MHz; $\sigma = 1.40$ mho/m; $\epsilon r = 39.86$; $\rho = 1000$ kg/m³ ;
Phantom section: Left Section
Ambient temperature (°C): 22.0, Liquid temperature (°C): 21.6

SATIMO Configuration:

- Probe: SSE5; Calibrated: Aug. 08,2018; Serial No.: SN 22/12 EP159
- Sensor-Surface: 4mm (Mechanical Surface Detection)
- Phantom: SAM twin phantom
- Measurement SW: OpenSAR V4_02_35

Configuration/PCS1900 Mid-Touch-Left/Area Scan: Measurement grid: dx=8mm, dy=8mm
Configuration/PCS1900 Mid-Touch-Left/Zoom Scan: Measurement grid: dx=8mm,dy=8mm, dz=5mm;

Area Scan	dx=8mm dy=8mm, h= 5.00 mm
ZoomScan	5x5x7,dx=8mm dy=8mm dz=5mm,Complete
Phantom	Left head
Device Position	Cheek
Band	PCS 1900
Channels	Middle
Signal	TDMA (Crest factor: 8.0)

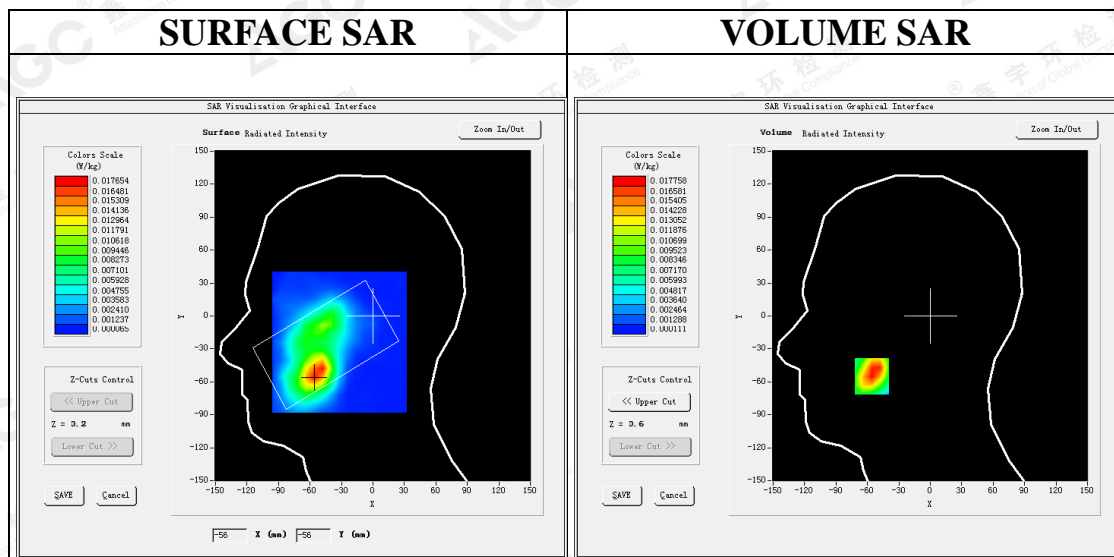

Maximum location: X=-56.00, Y=-55.00
SAR Peak: 0.03 W/kg

SAR 10g (W/Kg)	0.009766
SAR 1g (W/Kg)	0.017163

The results shown in this test report refer only to the sample(s) tested unless otherwise stated and the sample(s) are retained for 30 days only. The document is issued by AGC, this document cannot be reproduced except in full with our prior written permission. The more details and the authenticity of the report will be confirmed at <http://www.agc-cert.com>.

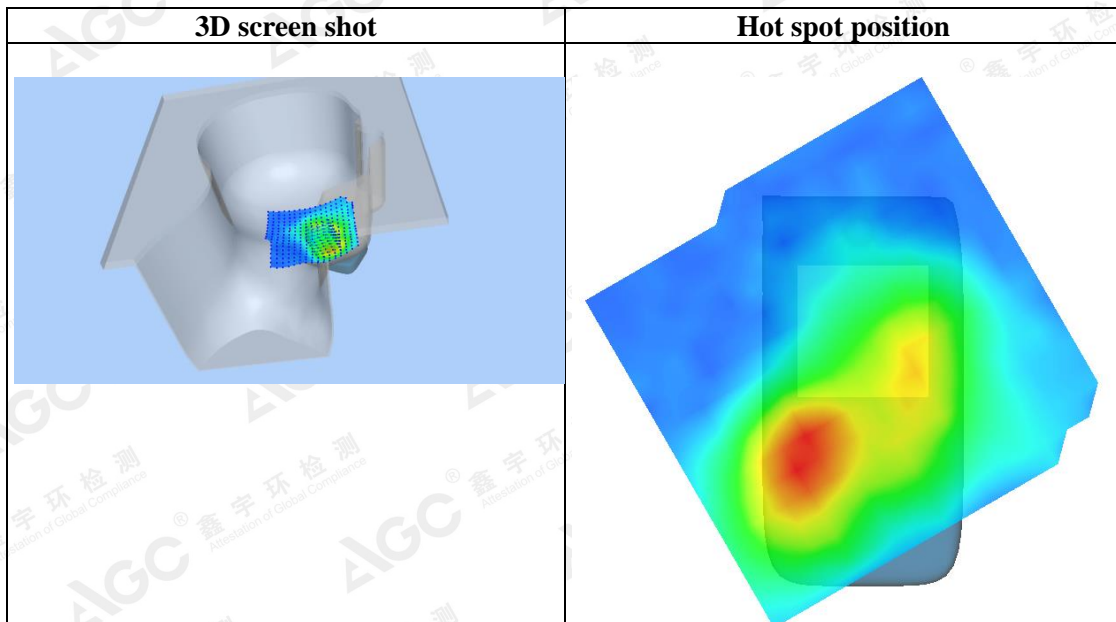
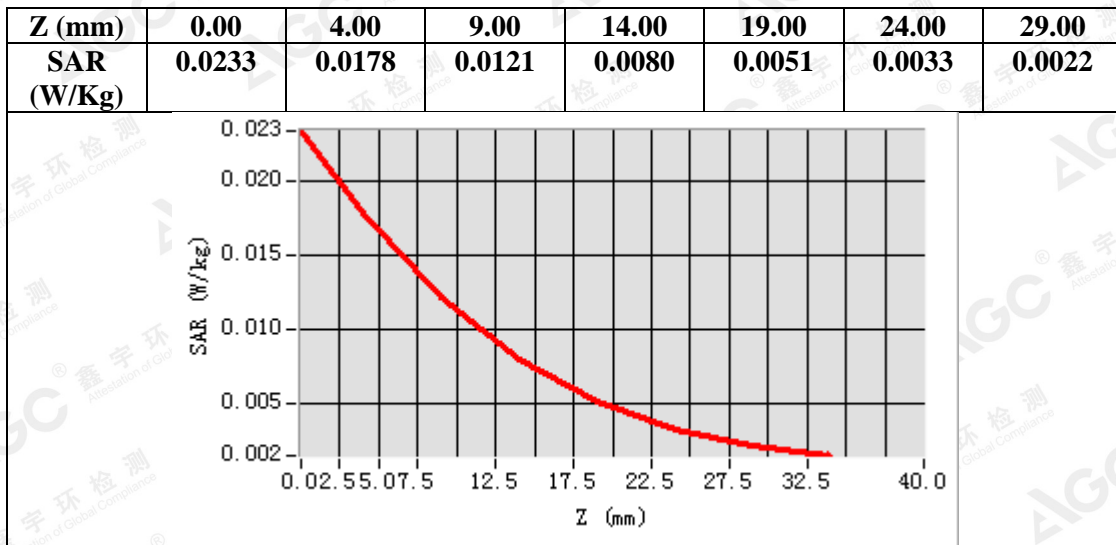

The results shown in this test report refer only to the sample(s) tested unless otherwise stated and the sample(s) are retained for 30 days only. The document is issued by AGC, this document cannot be reproduced except in full with our prior written permission. The more details and the authenticity of the report will be confirmed at <http://www.agc-cert.com>.

Test Laboratory: AGC Lab
PCS 1900 Mid-Body-Back (MS)<SIM 1>
DUT: Smart phone; Type: 4GO

Date: May 05,2019

Communication System: Generic GSM; Communication System Band: PCS 1900; Duty Cycle: 1:8.3; Conv.F=5.39;
Frequency: 1880 MHz; Medium parameters used: $f = 1850$ MHz; $\sigma = 1.47$ mho/m; $\epsilon r = 52.86$; $\rho = 1000$ kg/m³ ;
Phantom section: Flat Section
Ambient temperature (°C): 22.0, Liquid temperature (°C): 21.7

SATIMO Configuration:

- Probe: SSE5; Calibrated: Aug. 08,2018; Serial No.: SN 22/12 EP159
- Sensor-Surface: 4mm (Mechanical Surface Detection)
- Phantom: SAM twin phantom
- Measurement SW: OpenSAR V4_02_35

Configuration/PCS1900 Mid-Body-Back/Area Scan: Measurement grid: dx=10mm, dy=10mm
Configuration/PCS1900 Mid-Body-Back/Zoom Scan: Measurement grid: dx=8mm,dy=8mm, dz=5mm;

Area Scan	surf_sam_plan.txt, h= 5.00 mm
ZoomScan	5x5x7,dx=8mm dy=8mm dz=5mm,Complete
Phantom	Validation plane
Device Position	Body Back
Band	PCS 1900
Channels	Middle
Signal	TDMA (Crest factor: 8.0)

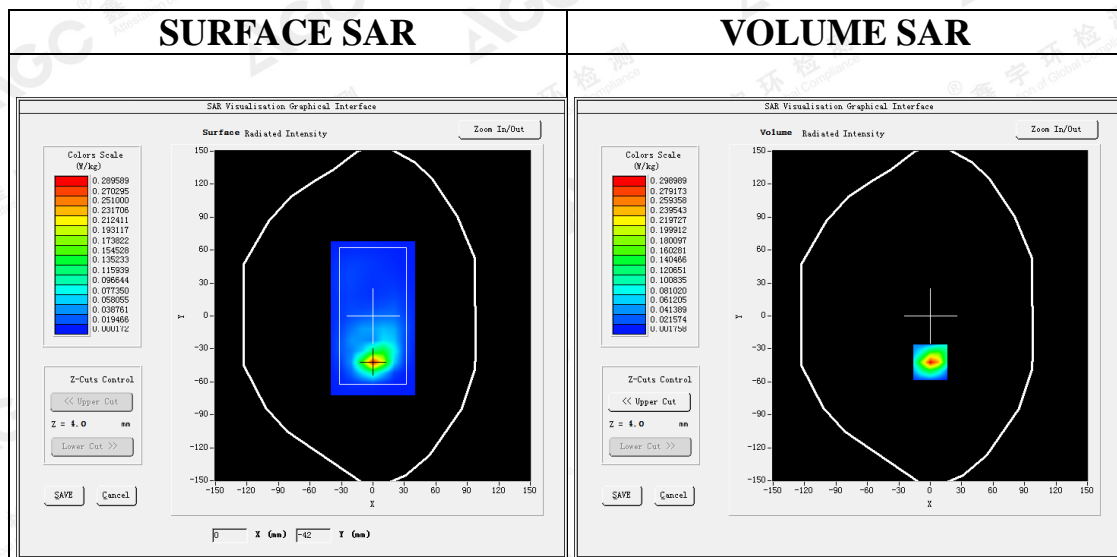

Maximum location: X=0.00, Y=-42.00
SAR Peak: 0.47 W/kg

SAR 10g (W/Kg)	0.114271
SAR 1g (W/Kg)	0.263114

The results shown in this test report refer only to the sample(s) tested unless otherwise stated and the sample(s) are retained for 30 days only. The document is issued by AGC, this document cannot be reproduced except in full with our prior written permission. The more details and the authenticity of the report will be confirmed at <http://www.agc-cert.com>.

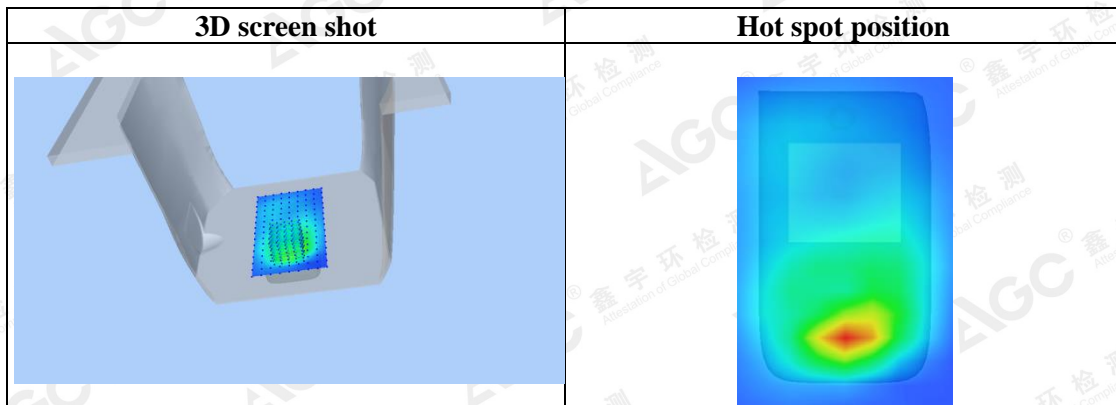
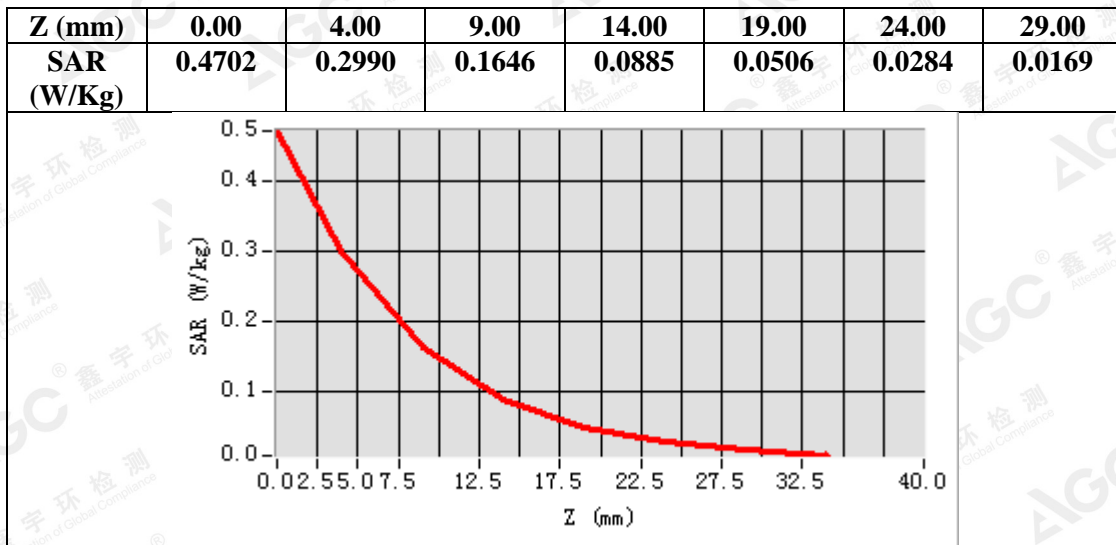

The results shown in this test report refer only to the sample(s) tested unless otherwise stated and the sample(s) are retained for 30 days only. The document is issued by AGC, this document cannot be reproduced except in full with our prior written permission. The more details and the authenticity of the report will be confirmed at <http://www.agc-cert.com>.

Test Laboratory: AGC Lab
GPRS 1900 Mid-Body-Back (3up)
DUT: Smart phone; Type: 4G0

Date: May 05,2019

Communication System: GPRS-3Slot; Communication System Band: PCS 1900; Duty Cycle: 1:2.7; Conv.F=5.39; Frequency: 1880 MHz; Medium parameters used: $f = 1850$ MHz; $\sigma = 1.47$ mho/m; $\epsilon r = 52.86$; $\rho = 1000$ kg/m³; Phantom section: Flat Section
Ambient temperature (°C): 22.0, Liquid temperature (°C): 21.7

SATIMO Configuration:

- Probe: SSE5; Calibrated: Aug. 08,2018; Serial No.: SN 22/12 EP159
- Sensor-Surface: 4mm (Mechanical Surface Detection)
- Phantom: SAM twin phantom
- Measurement SW: OpenSAR V4_02_35

Configuration/GPRS1900 Mid-Body-Back/Area Scan: Measurement grid: dx=10mm, dy=10mm
Configuration/GPRS1900 Mid-Body-Back/Zoom Scan: Measurement grid: dx=8mm,dy=8mm, dz=5mm;

Area Scan	surf_sam_plan.txt, h= 5.00 mm
Zoom Scan	5x5x7,dx=8mm dy=8mm dz=5mm,Complete
Phantom	Validation plane
Device Position	Body Back
Band	PCS 1900
Channels	Middle
Signal	TDMA (Crest factor: 2.7)

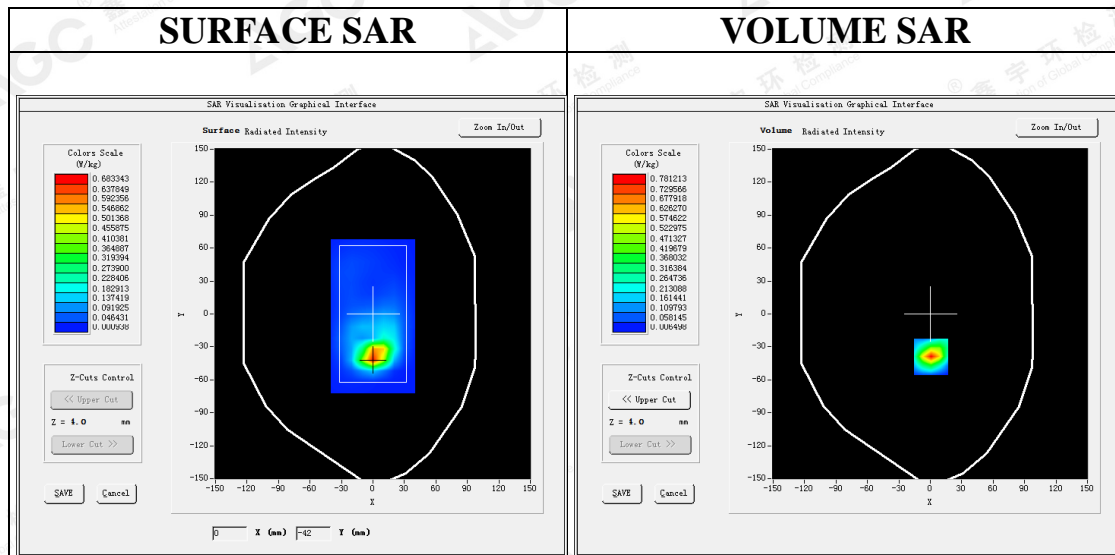

Maximum location: X=1.00, Y=-39.00
SAR Peak: 1.16 W/kg

SAR 10g (W/Kg)	0.312268
SAR 1g (W/Kg)	0.680679

The results shown in this test report refer only to the sample(s) tested unless otherwise stated and the sample(s) are retained for 30 days only. The document is issued by AGC, this document cannot be reproduced except in full with our prior written permission. The more details and the authenticity of the report will be confirmed at <http://www.agc-cert.com>.

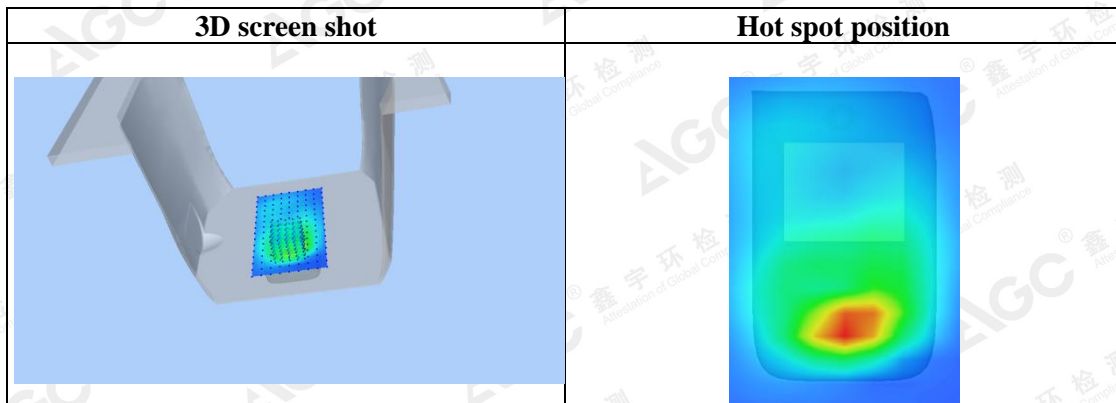
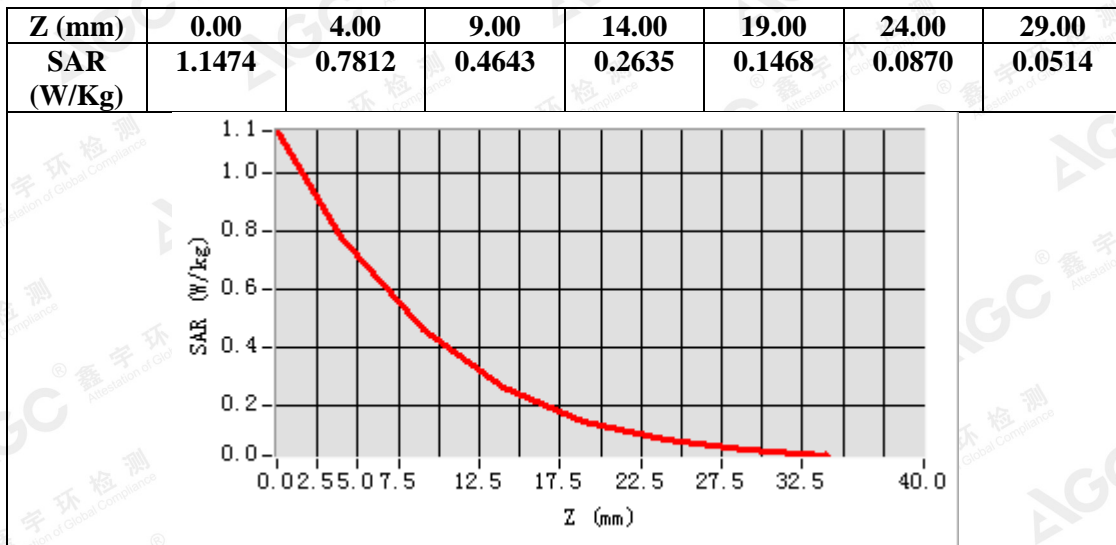

The results shown in this test report refer only to the sample(s) tested unless otherwise stated and the sample(s) are retained for 30 days only. The document is issued by AGC, this document cannot be reproduced except in full with our prior written permission. The more details and the authenticity of the report will be confirmed at <http://www.agc-cert.com>.

Test Laboratory: AGC Lab
WCDMA Band II Mid-Touch-Left (RMC)
DUT: Smart phone; Type: 4GO

Date: May 05,2019

Communication System: UMTS; Communication System Band: Band II UTRA/FDD ;Duty Cycle:1:1; Conv.F=5.24;
Frequency: 1880 MHz; Medium parameters used: $f = 1850$ MHz; $\sigma = 1.40$ mho/m; $\epsilon r = 39.86$; $\rho = 1000$ kg/m³ ;
Phantom section: Left Section
Ambient temperature (°C): 22.0, Liquid temperature (°C): 21.6

SATIMO Configuration:

- Probe: SSE5; Calibrated: Aug. 08,2018; Serial No.: SN 22/12 EP159
- Sensor-Surface: 4mm (Mechanical Surface Detection)
- Phantom: SAM twin phantom
- Measurement SW: OpenSAR V4_02_35

Configuration/ WCDMA Band II Mid-Touch-Left/Area Scan: Measurement grid: dx=8mm, dy=8mm
Configuration/ WCDMA Band II Mid-Touch-Left/Zoom Scan: Measurement grid:dx=8mm,dy=8mm,dz=5mm;

Area Scan	dx=8mm dy=8mm, h= 5.00 mm
ZoomScan	5x5x7,dx=8mm dy=8mm dz=5mm,Complete
Phantom	Left head
Device Position	Cheek
Band	WCDMA Band II
Channels	Middle
Signal	CDMA (Crest factor: 1.0)

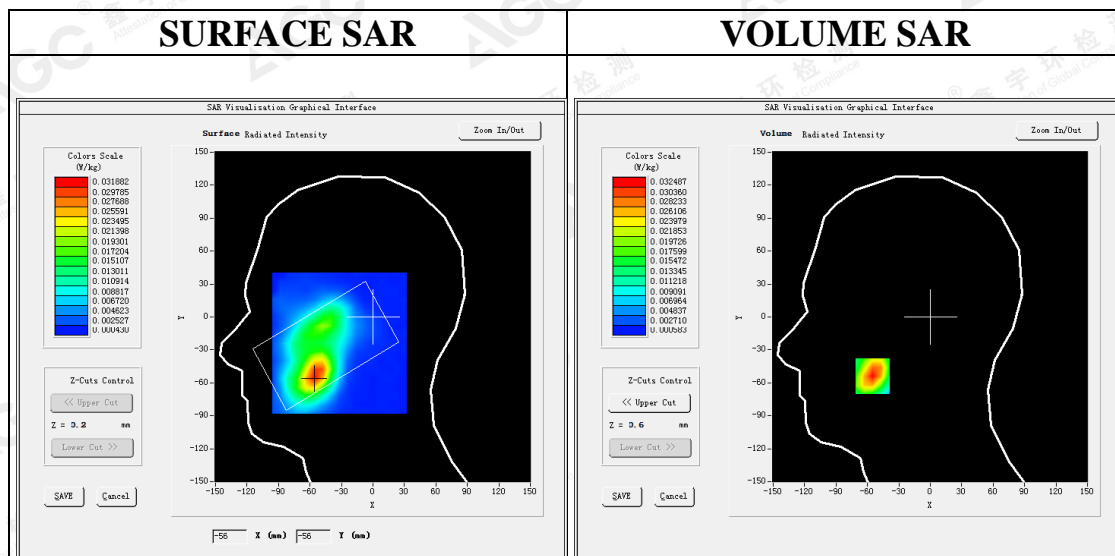

Maximum location: X=-55.00, Y=-54.00
SAR Peak: 0.04 W/kg

SAR 10g (W/Kg)	0.018103
SAR 1g (W/Kg)	0.030179

The results shown in this test report refer only to the sample(s) tested unless otherwise stated and the sample(s) are retained for 30 days only. The document is issued by AGC, this document cannot be reproduced except in full with our prior written permission. The more details and the authenticity of the report will be confirmed at <http://www.agc-cert.com>.

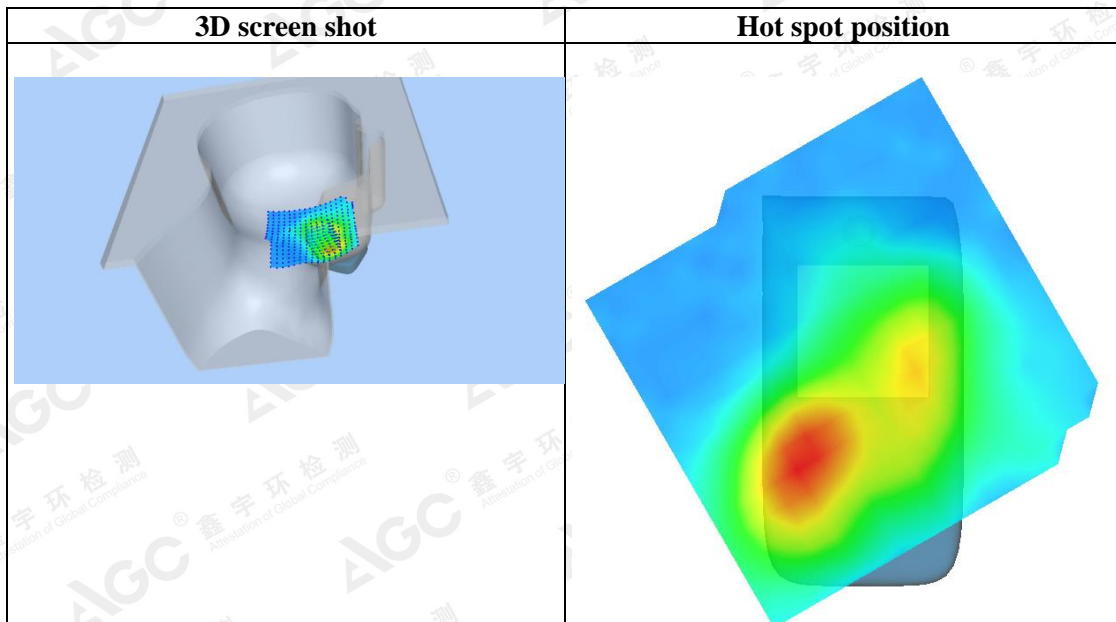
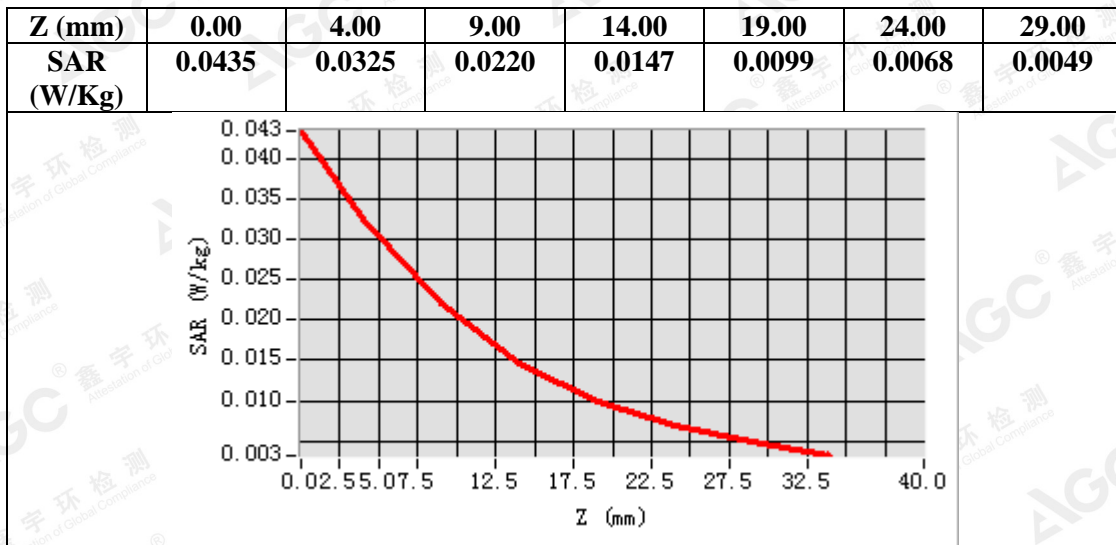

The results shown in this test report refer only to the sample(s) tested unless otherwise stated and the sample(s) are retained for 30 days only. The document is issued by AGC, this document cannot be reproduced except in full with our prior written permission. The more details and the authenticity of the report will be confirmed at <http://www.agc-cert.com>.

Test Laboratory: AGC Lab
WCDMA Band II Mid-Body-Towards Grounds (RMC 12.2kbps)
DUT: Smart phone; Type: 4GO

Date: May 05,2019

Communication System: UMTS; Communication System Band: Band II UTRA/FDD ;Duty Cycle:1:1; Conv.F=5.39;
Frequency: 1880 MHz; Medium parameters used: $f = 1850$ MHz; $\sigma = 1.47$ mho/m; $\epsilon_r = 52.86$; $\rho = 1000$ kg/m³ ;
Phantom section: Flat Section
Ambient temperature (°C): 22.0, Liquid temperature (°C): 21.7

SATIMO Configuration:

- Probe: SSE5; Calibrated: Aug. 08,2018; Serial No.: SN 22/12 EP159
- Sensor-Surface: 4mm (Mechanical Surface Detection)
- Phantom: SAM twin phantom
- Measurement SW: OpenSAR V4_02_35

Configuration/ WCDMA band II Mid-Body-back/Area Scan: Measurement grid: dx=10mm, dy=10mm
Configuration/ WCDMA band II Mid-Body-back/Zoom Scan: Measurement grid: dx=8mm,dy=8mm, dz=5mm;

Area Scan	surf_sam_plan.txt, h= 5.00 mm
ZoomScan	5x5x7,dx=8mm dy=8mm dz=5mm,Complete
Phantom	Validation plane
Device Position	Body Back
Band	WCDMA band II
Channels	Middle
Signal	CDMA (Crest factor: 1.0)

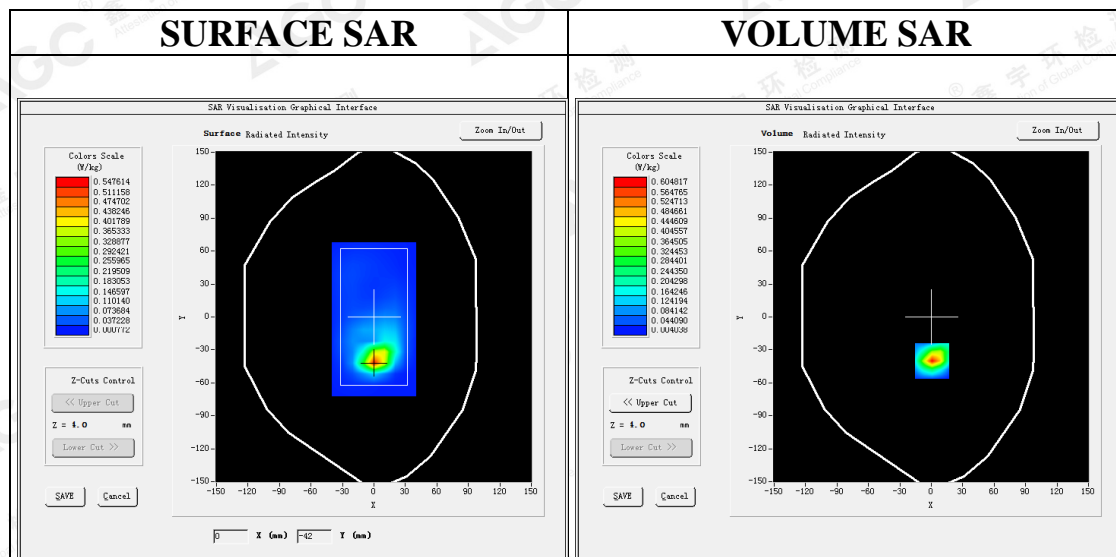

Maximum location: X=1.00, Y=-40.00
SAR Peak: 0.97 W/kg

SAR 10g (W/Kg)	0.233084
SAR 1g (W/Kg)	0.534876

The results shown in this test report refer only to the sample(s) tested unless otherwise stated and the sample(s) are retained for 30 days only. The document is issued by AGC, this document cannot be reproduced except in full with our prior written permission. The more details and the authenticity of the report will be confirmed at <http://www.agc-cert.com>.

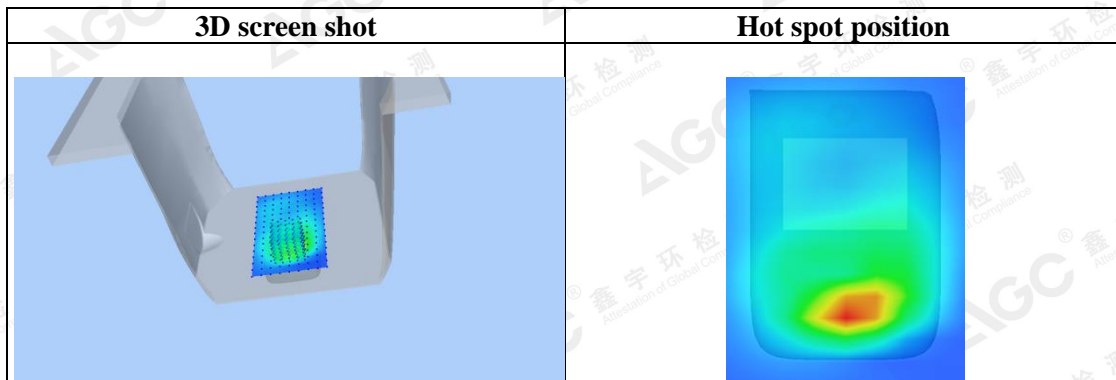
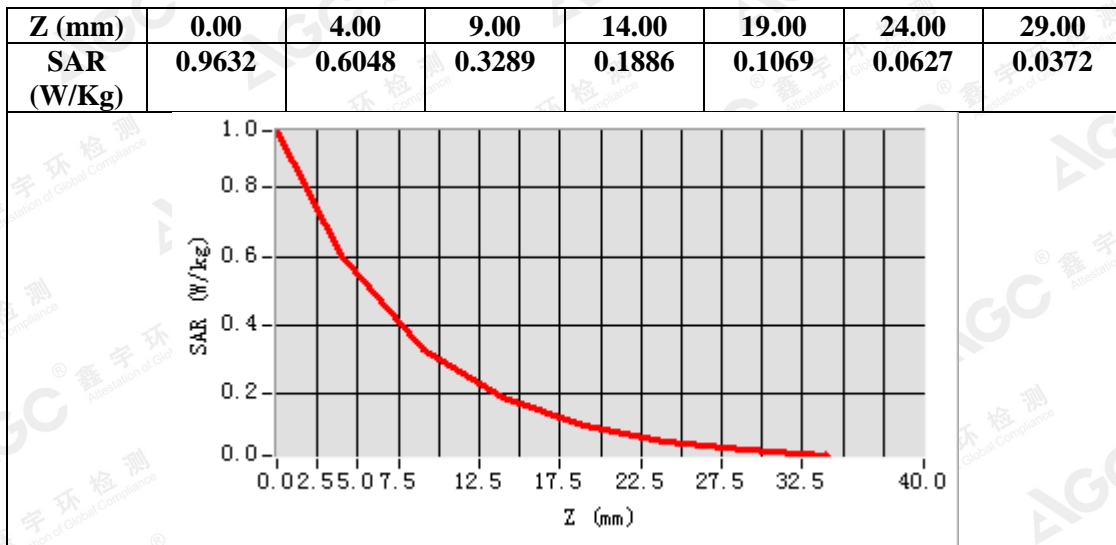

The results shown in this test report refer only to the sample(s) tested unless otherwise stated and the sample(s) are retained for 30 days only. The document is issued by AGC, this document cannot be reproduced except in full with our prior written permission. The more details and the authenticity of the report will be confirmed at <http://www.agc-cert.com>.

Test Laboratory: AGC Lab
WCDMA Band V Mid- Touch-Right (RMC)
DUT: Smart phone; Type: 4GO

Date: May 02,2019

Communication System: UMTS; Communication System Band: BAND V UTRA/FDD ; Duty Cycle:1: 1; Conv.F=5.29;
Frequency: 836.6 MHz; Medium parameters used: f = 835MHz; $\sigma = 0.93$ mho/m; $\epsilon r = 40.53$; $\rho = 1000$ kg/m³ ;
Phantom section: Right Section
Ambient temperature (°C): 22.4, Liquid temperature (°C): 22.1

SATIMO Configuration:

- Probe: SSE5; Calibrated: Aug. 08,2018; Serial No.: SN 22/12 EP159
- Sensor-Surface: 4mm (Mechanical Surface Detection)
- Phantom: SAM twin phantom
- Measurement SW: OpenSAR V4_02_35

Configuration/ WCDMA Band V Mid-Touch-Right/Area Scan: Measurement grid: dx=8mm, dy=8mm
Configuration/ WCDMA Band V Mid-Touch-Right/Zoom Scan: Measurement grid: dx=8mm,dy=8mm, dz=5mm;

Area Scan	dx=8mm dy=8mm, h= 5.00 mm
ZoomScan	5x5x7,dx=8mm dy=8mm dz=5mm,Complete
Phantom	Right head
Device Position	Cheek
Band	WCDMA Band V
Channels	Middle
Signal	CDMA (Crest factor: 1.0)

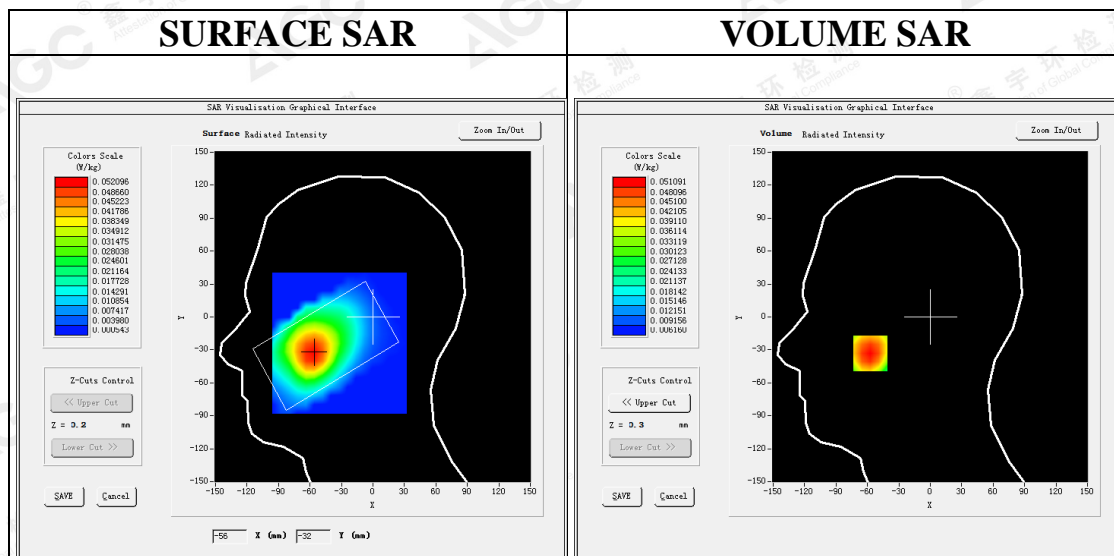

Maximum location: X=-57.00, Y=-33.00
SAR Peak: 0.06 W/kg

SAR 10g (W/Kg)	0.036884
SAR 1g (W/Kg)	0.049449

The results shown in this test report refer only to the sample(s) tested unless otherwise stated and the sample(s) are retained for 30 days only. The document is issued by AGC, this document cannot be reproduced except in full with our prior written permission. The more details and the authenticity of the report will be confirmed at <http://www.agc-cert.com>.

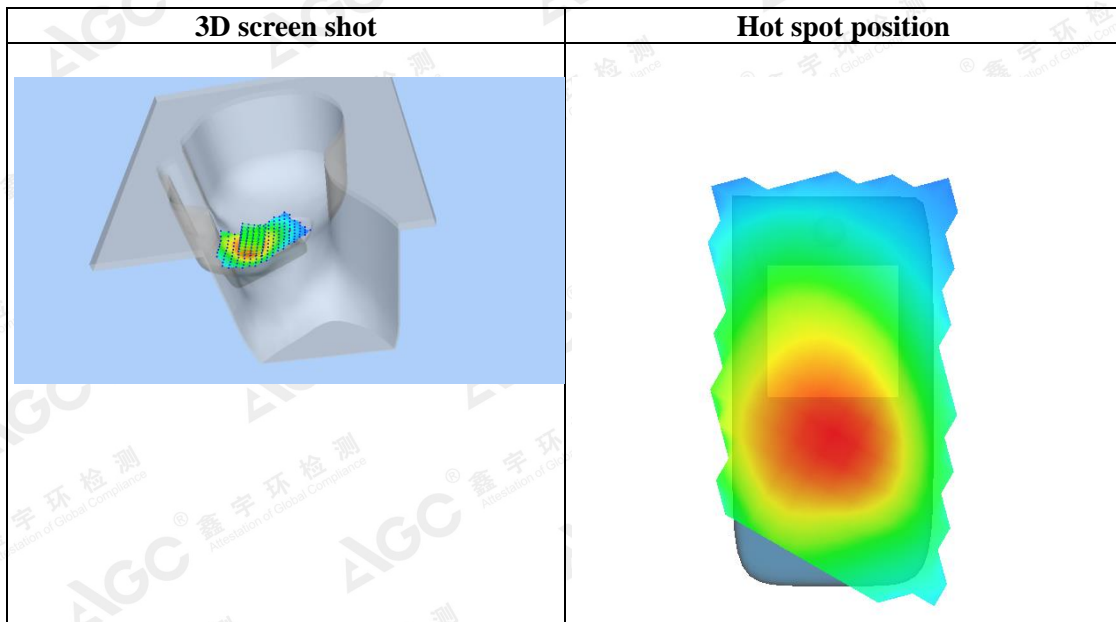
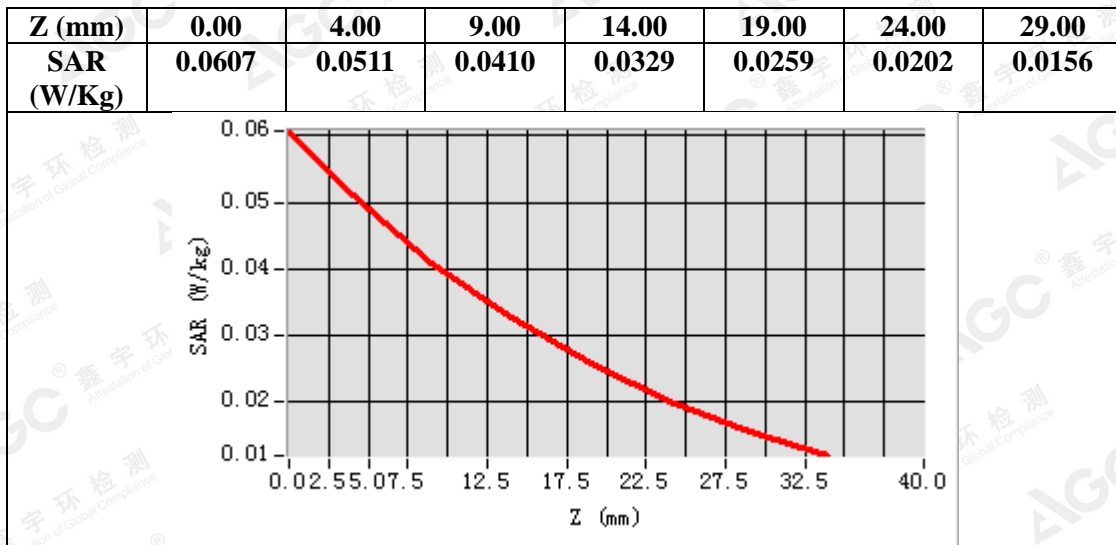

The results shown in this test report refer only to the sample(s) tested otherwise stated and the sample(s) are retained for 30 days only. The document is issued by AGC, this document cannot be reproduced except in full with our prior written permission. The more details and the authenticity of the report will be confirmed at <http://www.agc-cert.com>.

Test Laboratory: AGC Lab
WCDMA Band V Mid-Body-Towards Grounds (RMC)
DUT: Smart phone; Type: 4GO

Date: May 02,2019

Communication System: UMTS; Communication System Band: BAND V UTRA/FDD; Duty Cycle:1: 1; Conv.F=5.49;
Frequency: 836.6 MHz; Medium parameters used: $f = 835\text{MHz}$; $\sigma = 0.99 \text{ mho/m}$; $\epsilon r = 53.29$; $\rho = 1000 \text{ kg/m}^3$;
Phantom section: Flat Section
Ambient temperature ($^{\circ}\text{C}$): 22.4, Liquid temperature ($^{\circ}\text{C}$): 22.0

SATIMO Configuration:

- Probe: SSE5; Calibrated: Aug. 08,2018; Serial No.: SN 22/12 EP159
- Sensor-Surface: 4mm (Mechanical Surface Detection)
- Phantom: SAM twin phantom
- Measurement SW: OpenSAR V4_02_35

Configuration/ WCDMA Band V Mid-Body-Back/Area Scan: Measurement grid: dx=10mm, dy=10mm
Configuration/ WCDMA Band V Mid-Body-Back/Zoom Scan: Measurement grid: dx=8mm,dy=8mm, dz=5mm;

Area Scan	surf_sam_plan.txt, h= 5.00 mm
ZoomScan	5x5x7,dx=8mm dy=8mm dz=5mm,Complete
Phantom	Validation plane
Device Position	Body Back
Band	WCDMA Band V
Channels	Middle
Signal	CDMA (Crest factor: 1.0)

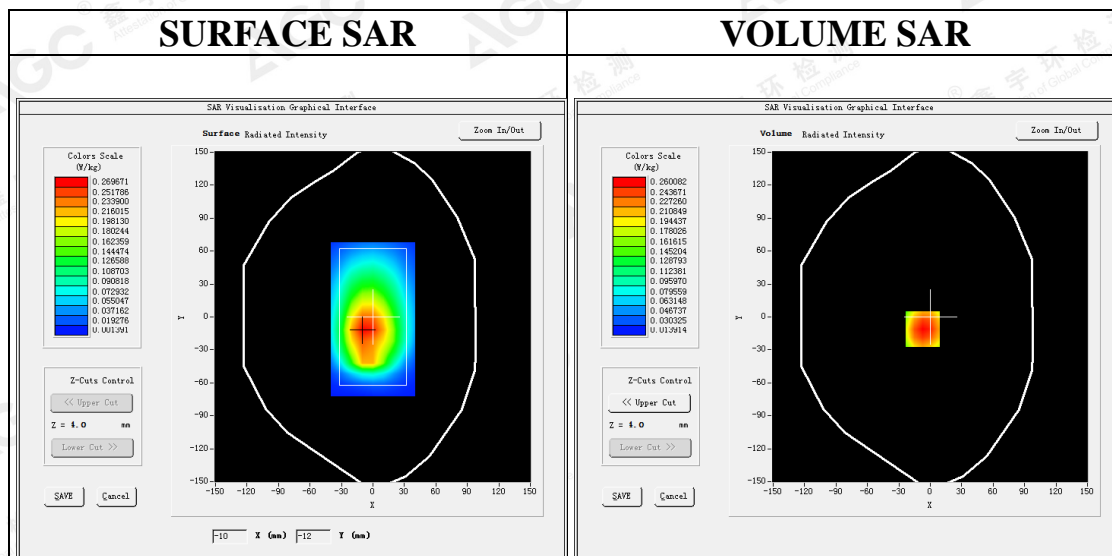

Maximum location: X=-7.00, Y=-11.00
SAR Peak: 0.35 W/kg

SAR 10g (W/Kg)	0.172281
SAR 1g (W/Kg)	0.252009

The results shown in this test report refer only to the sample(s) tested unless otherwise stated and the sample(s) are retained for 30 days only. The document is issued by AGC, this document cannot be reproduced except in full with our prior written permission. The more details and the authenticity of the report will be confirmed at <http://www.agc-cert.com>.

Z (mm)	0.00	4.00	9.00	14.00	19.00	24.00	29.00
SAR (W/Kg)	0.3370	0.2601	0.1862	0.1324	0.0932	0.0657	0.0461

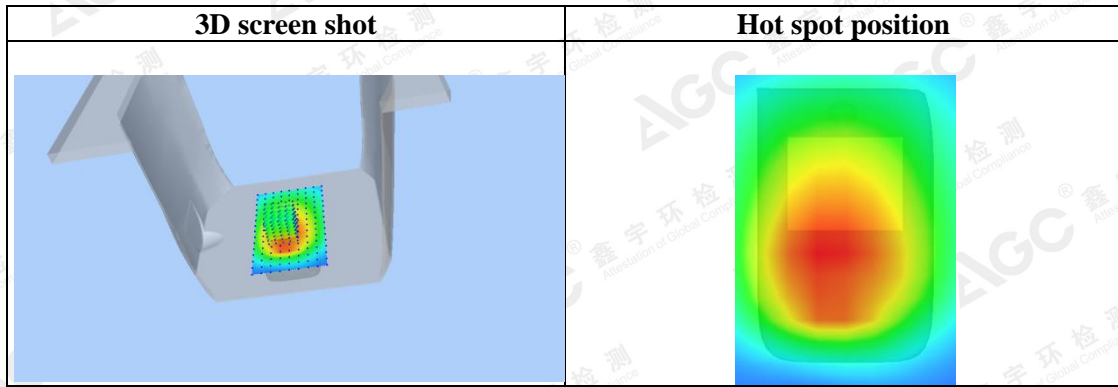
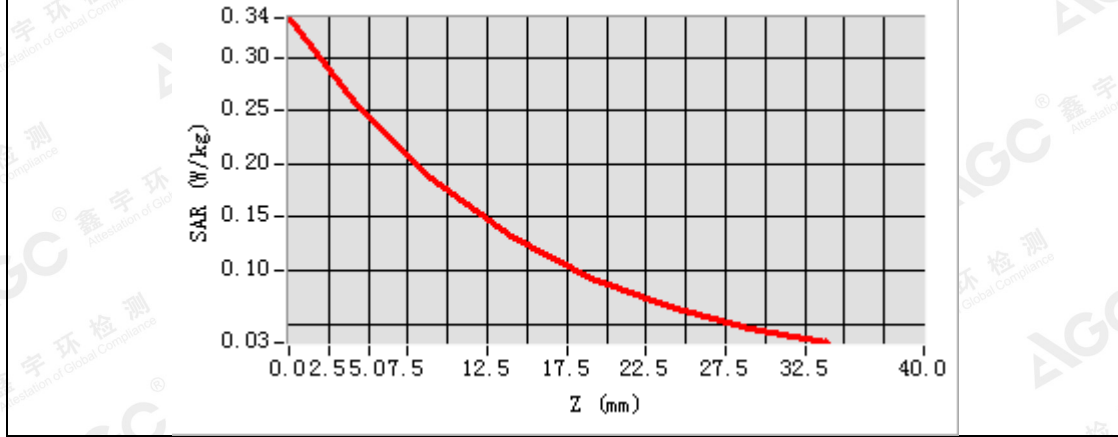

The results shown in this test report refer only to the sample(s) tested unless otherwise stated and the sample(s) are retained for 30 days only. The document is issued by AGC, this document cannot be reproduced except in full with our prior written permission. The more details and the authenticity of the report will be confirmed at <http://www.agc-cert.com>.

WIFI MODE

Test Laboratory: AGC Lab
802.11b Mid- Touch-Right
DUT: Smart phone; Type: 4GO

Date: May 06,2019

Communication System: Wi-Fi; Communication System Band: 802.11b; Duty Cycle: 1:1; Conv.F=4.90;
Frequency: 2437 MHz; Medium parameters used: $f = 2450$ MHz; $\sigma = 1.75$ mho/m; $\epsilon_r = 38.92$; $\rho = 1000$ kg/m³ ;
Phantom section: Right Section
Ambient temperature (°C):21.9, Liquid temperature (°C): 21.6

SATIMO Configuration:

- Probe: SSE5; Calibrated: Aug. 08,2018; Serial No.: SN 22/12 EP159
- Sensor-Surface: 4mm (Mechanical Surface Detection)
- Phantom: SAM twin phantom
- Measurement SW: OpenSAR V4_02_35

Configuration/802.11b Mid- Touch-Right /Area Scan: Measurement grid: dx=8mm, dy=8mm
Configuration/802.11b Mid- Touch-Right /Zoom Scan: Measurement grid: dx=5mm,dy=5mm, dz=5mm;

Area Scan	dx=8mm dy=8mm, h= 5.00 mm
ZoomScan	7x7x7,dx=5mm dy=5mm dz=5mm
Phantom	Right head
Device Position	Cheek
Band	2450MHz
Channels	Middle
Signal	Crest factor: 1.0

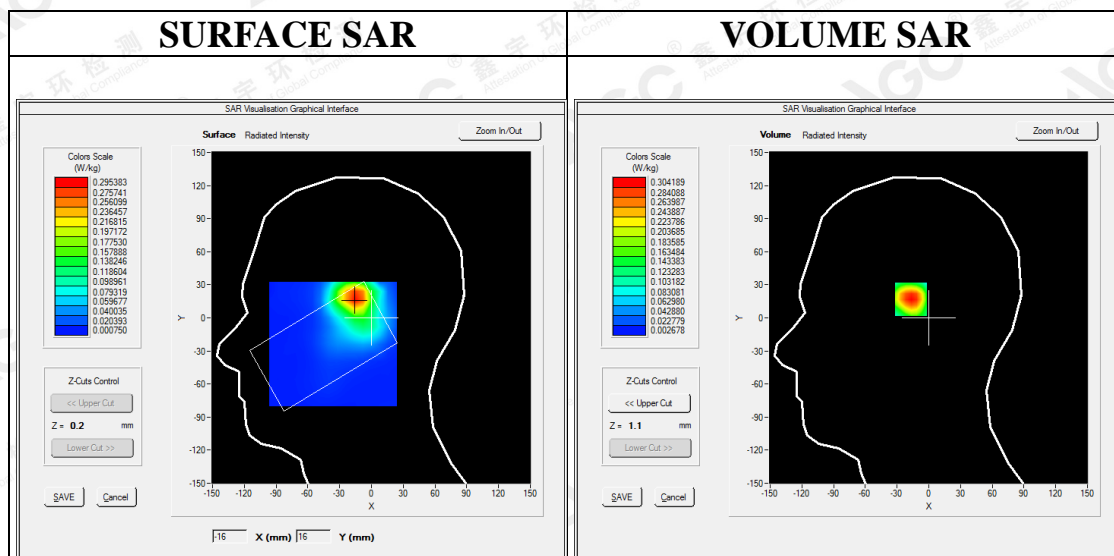

Maximum location: X=-15.00, Y=18.00

SAR Peak: 0.53 W/kg

SAR 10g (W/Kg)	0.137529
SAR 1g (W/Kg)	0.288492

The results shown in this test report refer only to the sample(s) tested unless otherwise stated and the sample(s) are retained for 30 days only. The document is issued by AGC, this document cannot be reproduced except in full with our prior written permission. The more details and the authenticity of the report will be confirmed at <http://www.agc-cert.com>.

Z (mm)	0.00	4.00	9.00	14.00	19.00	24.00	29.00
SAR (W/Kg)	0.5359	0.3042	0.1386	0.0640	0.0303	0.0147	0.0075

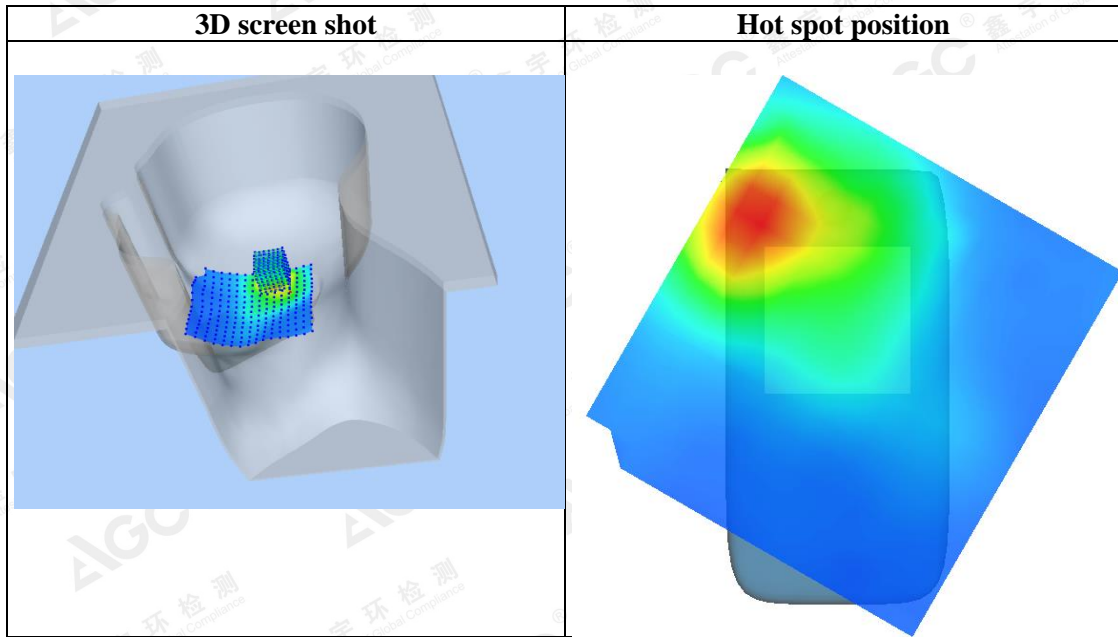
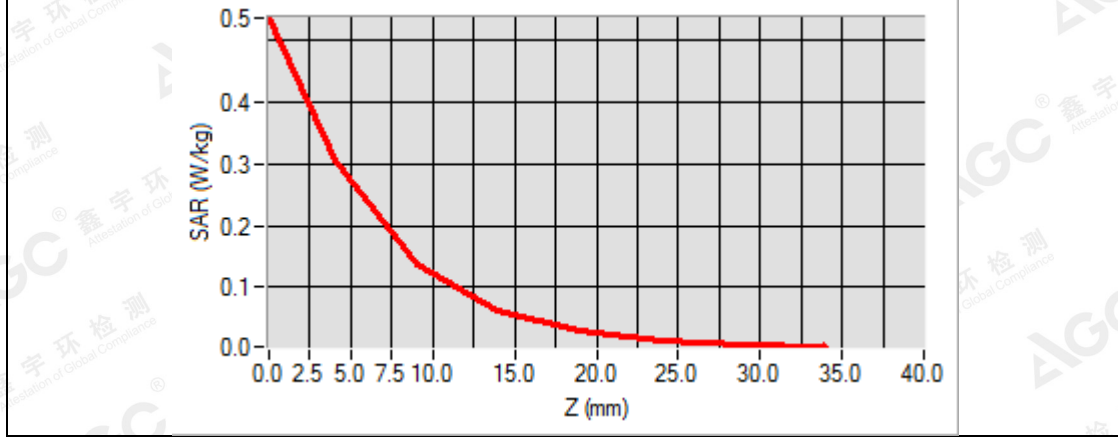

The results shown in this test report refer only to the sample(s) tested unless otherwise stated and the sample(s) are retained for 30 days only. The document is issued by AGC, this document cannot be reproduced except in full with our prior written permission. The more details and the authenticity of the report will be confirmed at <http://www.agc-cert.com>.

Test Laboratory: AGC Lab
802.11b Mid-Edge1 (DTS)
DUT: Smart phone; Type: 4GO

Date: May 06,2019

Communication System: Wi-Fi; Communication System Band: 802.11b; Duty Cycle: 1:1; Conv.F=5.04;
Frequency: 2437 MHz; Medium parameters used: $f = 2450$ MHz; $\sigma = 1.98$ mho/m; $\epsilon r = 53.87$; $\rho = 1000$ kg/m³ ;
Phantom section: Flat Section
Ambient temperature (°C):21.9, Liquid temperature (°C): 21.5

SATIMO Configuration:

- Probe: SSE5; Calibrated: Aug. 08,2018; Serial No.: SN 22/12 EP159
- Sensor-Surface: 4mm (Mechanical Surface Detection)
- Phantom: SAM twin phantom
- Measurement SW: OpenSAR V4_02_35

Configuration/802.11b Mid- Edge1 /Area Scan: Measurement grid: dx=10mm, dy=10mm
Configuration/802.11b Mid- Edge1 /Zoom Scan: Measurement grid: dx=5mm,dy=5mm, dz=5mm;

Area Scan	surf_sam_plan.txt, h= 5.00 mm
ZoomScan	7x7x7,dx=5mm dy=5mm dz=5mm
Phantom	Validation plane
Device Position	Edge1
Band	2450MHz
Channels	Middle
Signal	Crest factor: 1.0

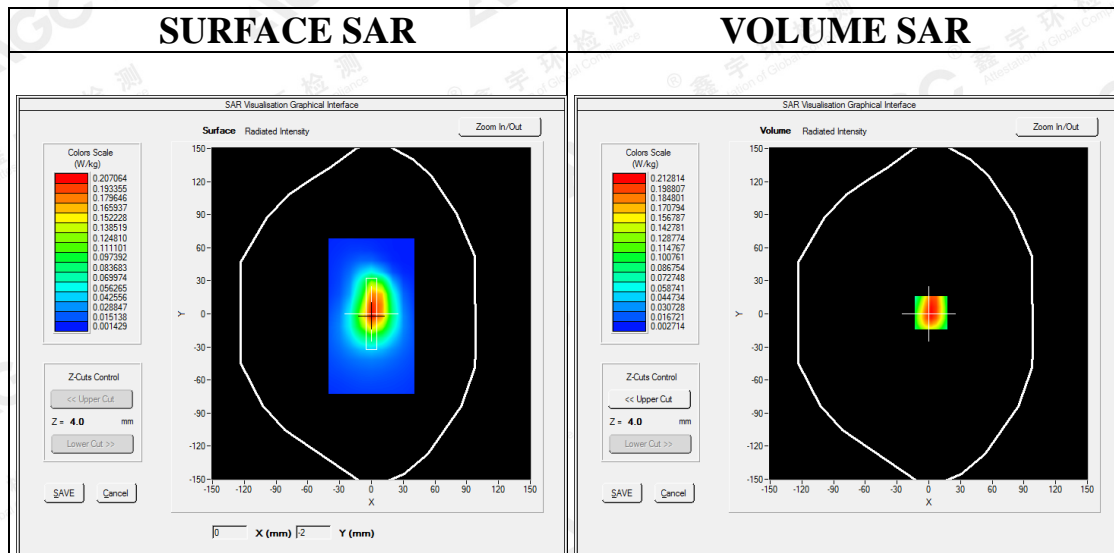

Maximum location: X=2.00, Y=1.00
SAR Peak: 0.35 W/kg

SAR 10g (W/Kg)	0.103777
SAR 1g (W/Kg)	0.201417

The results shown in this test report refer only to the sample(s) tested unless otherwise stated and the sample(s) are retained for 30 days only. The document is issued by AGC, this document cannot be reproduced except in full with our prior written permission. The more details and the authenticity of the report will be confirmed at <http://www.agc-cert.com>.

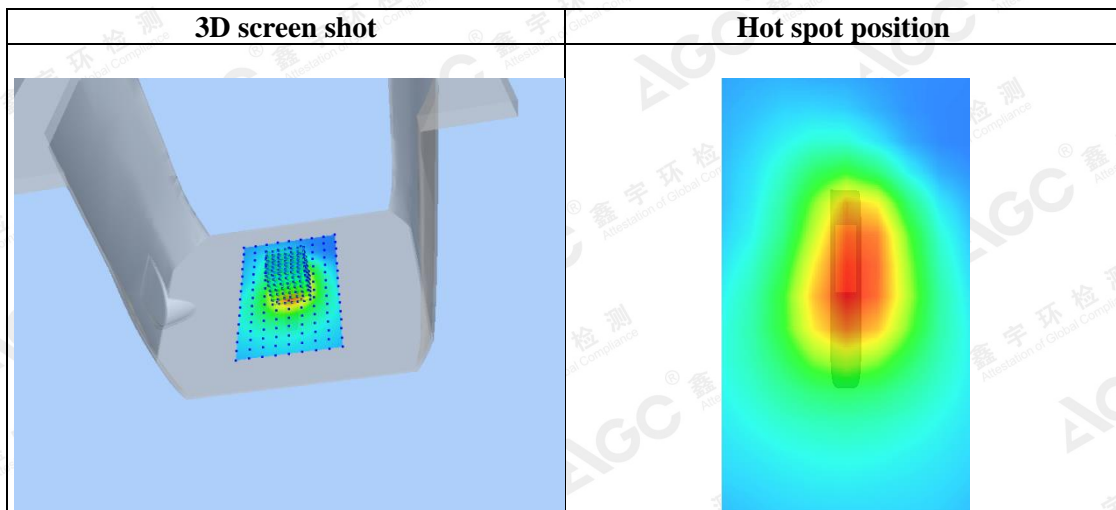
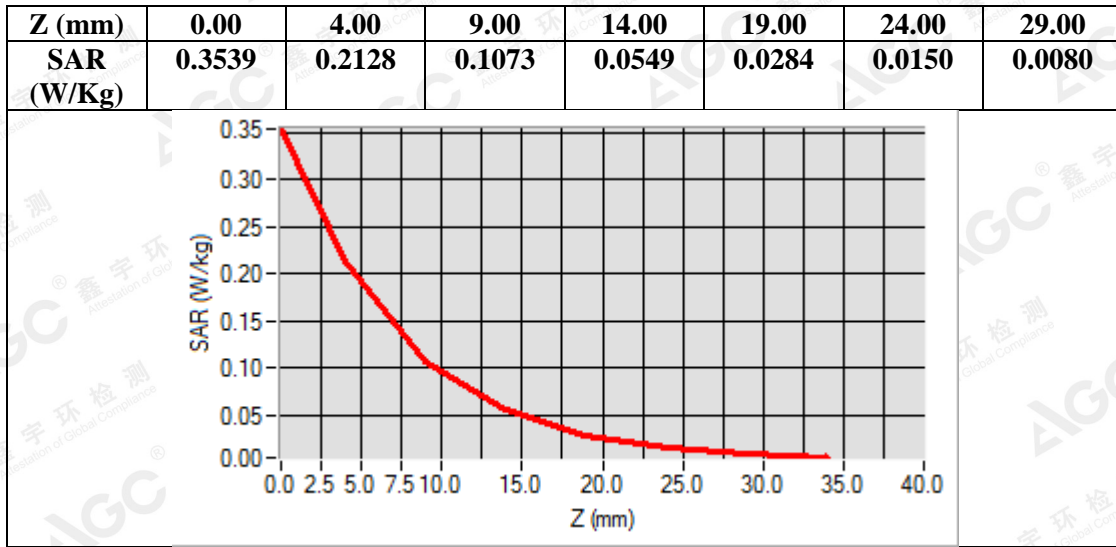

The results shown in this test report refer only to the sample(s) tested unless otherwise stated and the sample(s) are retained for 30 days only. The document is issued by AGC, this document cannot be reproduced except in full with our prior written permission. The more details and the authenticity of the report will be confirmed at <http://www.agc-cert.com>.

Repeated SAR

Test Laboratory: AGC Lab
GPRS 850 High- Body- Back (3up)
DUT: Smart phone; Type: 4GO

Date: May 02,2019

Communication System: GPRS-3 Slot; Communication System Band: GSM 850; Duty Cycle: 1:2.7; Conv.F=5.49;
Frequency: 848.8 MHz; Medium parameters used: $f = 835$ MHz; $\sigma = 1.01$ mho/m; $\epsilon_r = 52.56$; $\rho = 1000$ kg/m³ ;
Phantom section: Flat Section
Ambient temperature (°C): 22.4, Liquid temperature (°C): 22.0

SATIMO Configuration:

- Probe: SSE5; Calibrated: Aug. 08,2018; Serial No.: SN 22/12 EP159
- Sensor-Surface: 4mm (Mechanical Surface Detection)
- Phantom: SAM twin phantom
- Measurement SW: OpenSAR V4_02_35

Configuration/GPRS 850 High-Body-Back/Area Scan: Measurement grid: dx=8mm, dy=8mm
Configuration/GPRS 850 High-Body-Back/Zoom Scan: Measurement grid: dx=8mm,dy=8mm, dz=5mm;

Area Scan	surf_sam_plan.txt, h= 5.00 mm
Zoom Scan	5x5x7,dx=8mm dy=8mm dz=5mm,Complete
Phantom	Validation plane
Device Position	Body Back
Band	GSM 850
Channels	High
Signal	TDMA (Crest factor: 2.7)

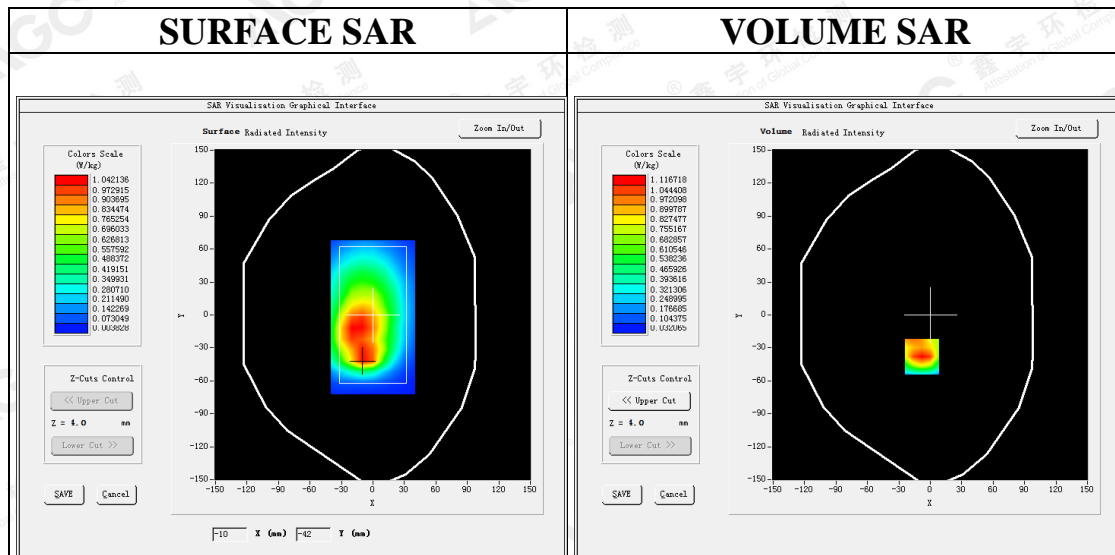

Maximum location: X=-8.00, Y=-38.00
SAR Peak: 1.67 W/kg

SAR 10g (W/Kg)	0.598025
SAR 1g (W/Kg)	1.032712

The results shown in this test report refer only to the sample(s) tested unless otherwise stated and the sample(s) are retained for 30 days only. The document is issued by AGC, this document cannot be reproduced except in full with our prior written permission. The more details and the authenticity of the report will be confirmed at <http://www.agc-cert.com>.

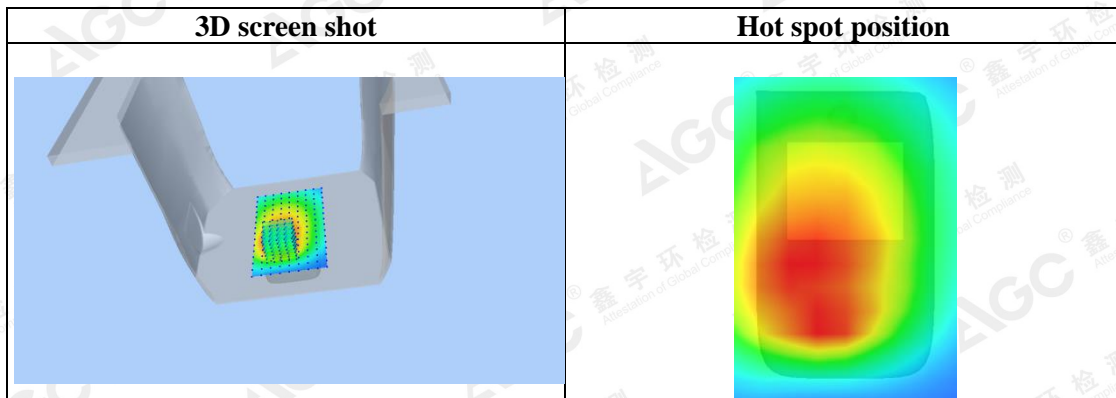
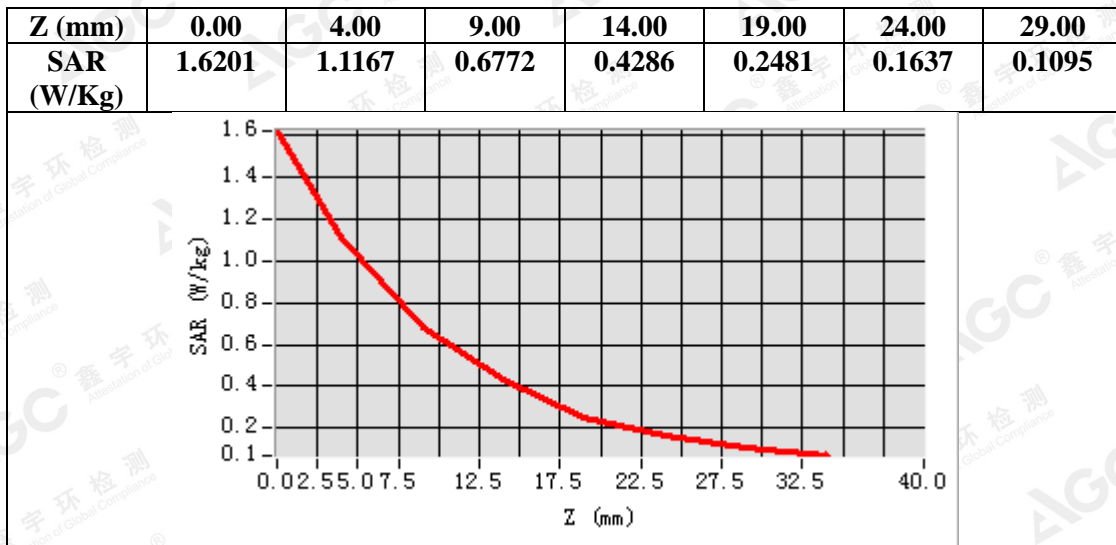

The results shown in this test report refer only to the sample(s) tested unless otherwise stated and the sample(s) are retained for 30 days only. The document is issued by AGC, this document cannot be reproduced except in full with our prior written permission. The more details and the authenticity of the report will be confirmed at <http://www.agc-cert.com>.

APPENDIX C. TEST SETUP PHOTOGRAPHS
LEFT- CHEEK TOUCH

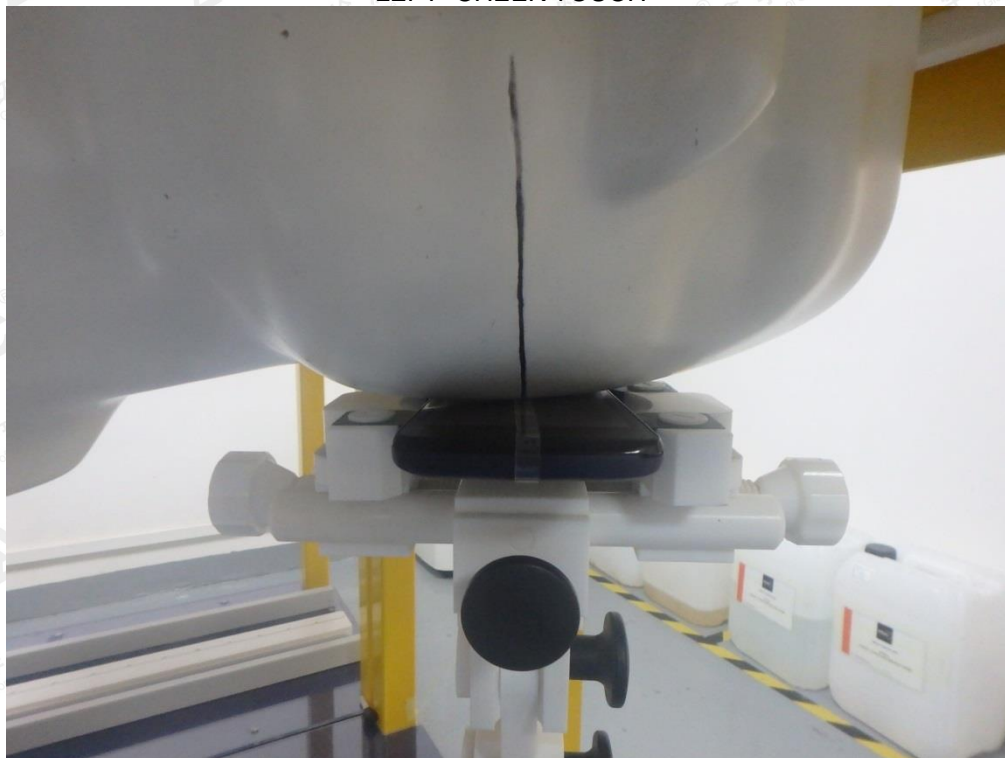

LEFT-TILT 15°



The results shown in this test report refer only to the sample(s) tested unless otherwise stated and the sample(s) are retained for 30 days only. The document is issued by AGC, this document cannot be reproduced except in full with our prior written permission. The more details and the authenticity of the report will be confirmed at <http://www.agc-cert.com>.

RIGHT- CHEEK TOUCH

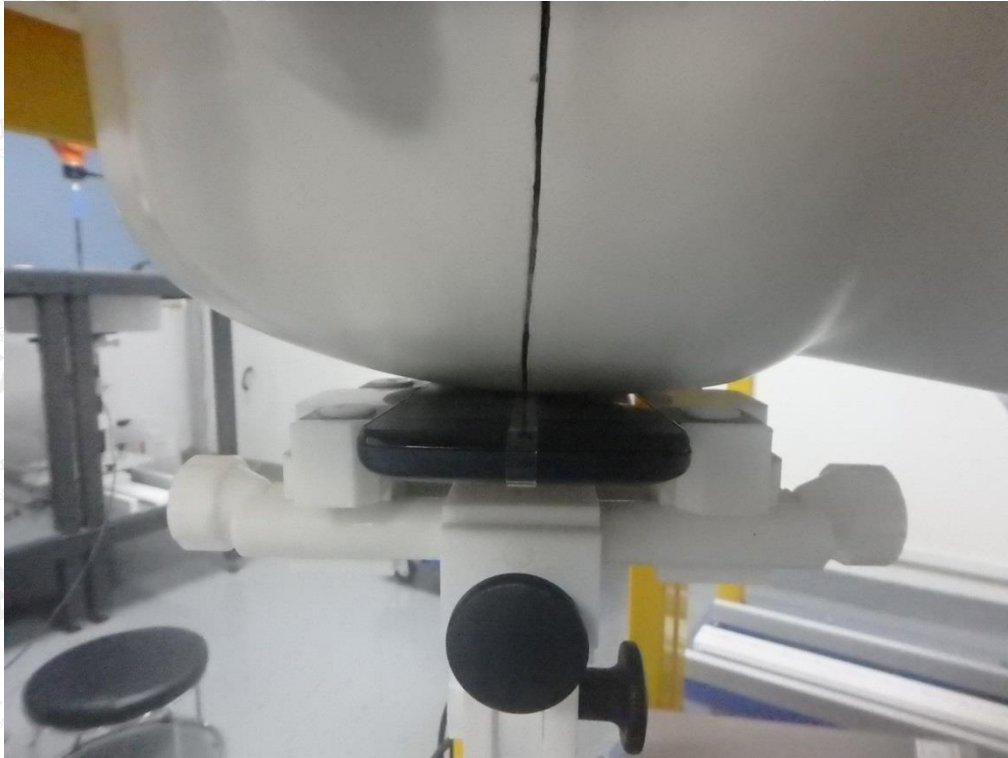

RIGHT-TILT 15°

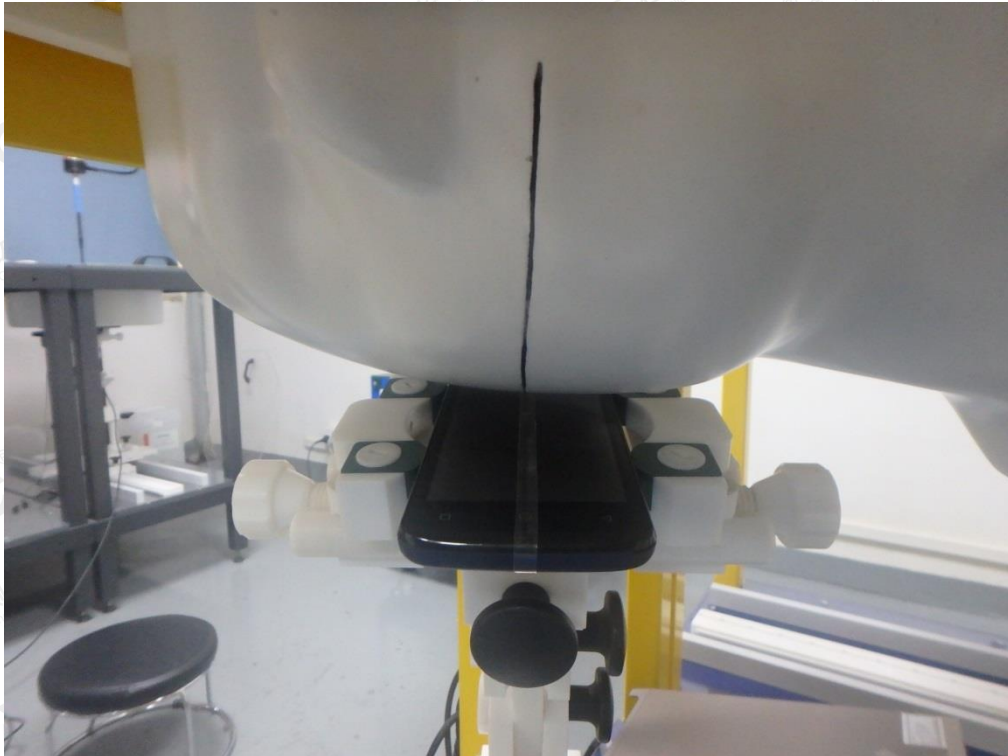

The results shown in this test report refer only to the sample(s) tested unless otherwise stated and the sample(s) are retained for 30 days only. The document is issued by AGC, this document cannot be reproduced except in full with our prior written permission. The more details and the authenticity of the report will be confirmed at <http://www.agc-cert.com>.

Body Back 5mm

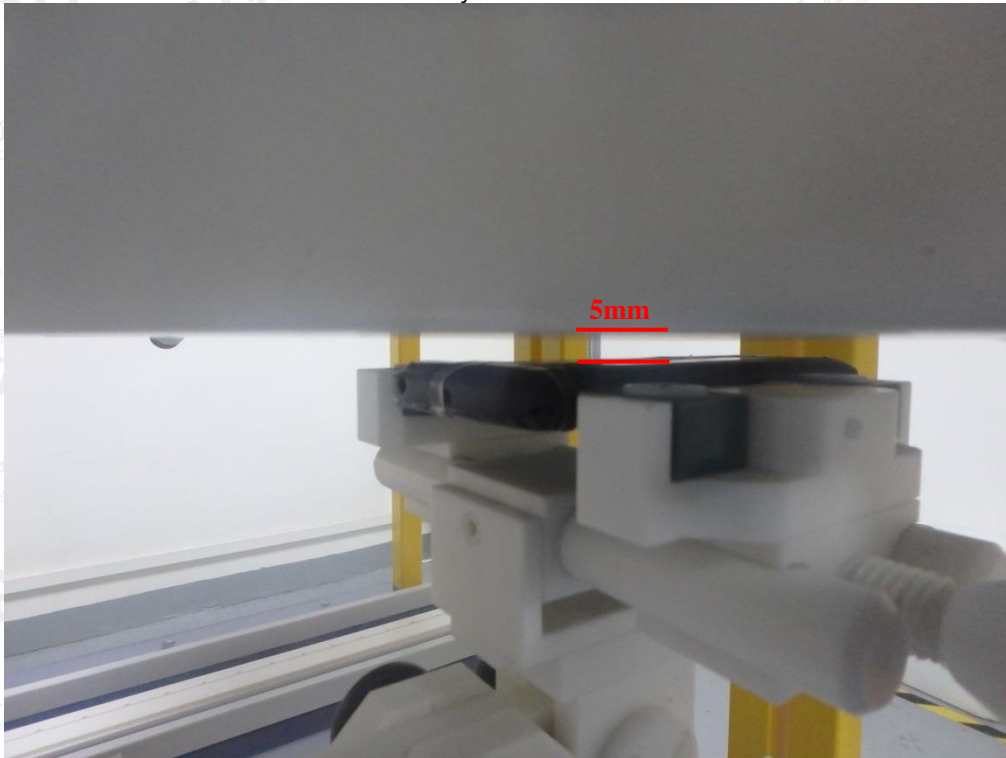

Body Front 5mm

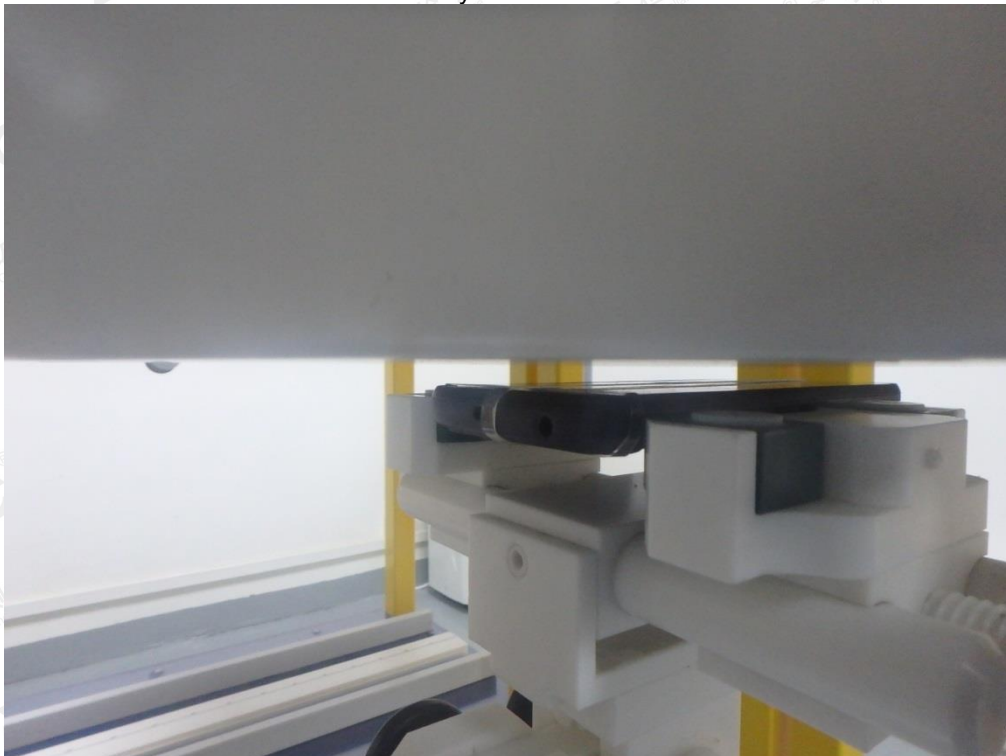

The results shown in this test report refer only to the sample(s) tested unless otherwise stated and the sample(s) are retained for 30 days only. The document is issued by AGC, this document cannot be reproduced except in full with our prior written permission. The more details and the authenticity of the report will be confirmed at <http://www.agc-cert.com>.

Edge 1(Top) 5mm



Edge 2(Right) 5mm



The results shown in this test report refer only to the sample(s) tested unless otherwise stated and the sample(s) are retained for 30 days only. The document is issued by AGC, this document cannot be reproduced except in full with our prior written permission. The more details and the authenticity of the report will be confirmed at <http://www.agc-cert.com>.

Edge 3(Bottom) 5mm



Edge 4(Left) 5mm



The results shown in this test report refer only to the sample(s) tested unless otherwise stated and the sample(s) are retained for 30 days only. The document is issued by AGC, this document cannot be reproduced except in full with our prior written permission. The more details and the authenticity of the report will be confirmed at <http://www.agc-cert.com>.

DEPTH OF THE LIQUID IN THE PHANTOM—ZOOM IN

Note : The position used in the measurement were according to IEEE 1528-2013

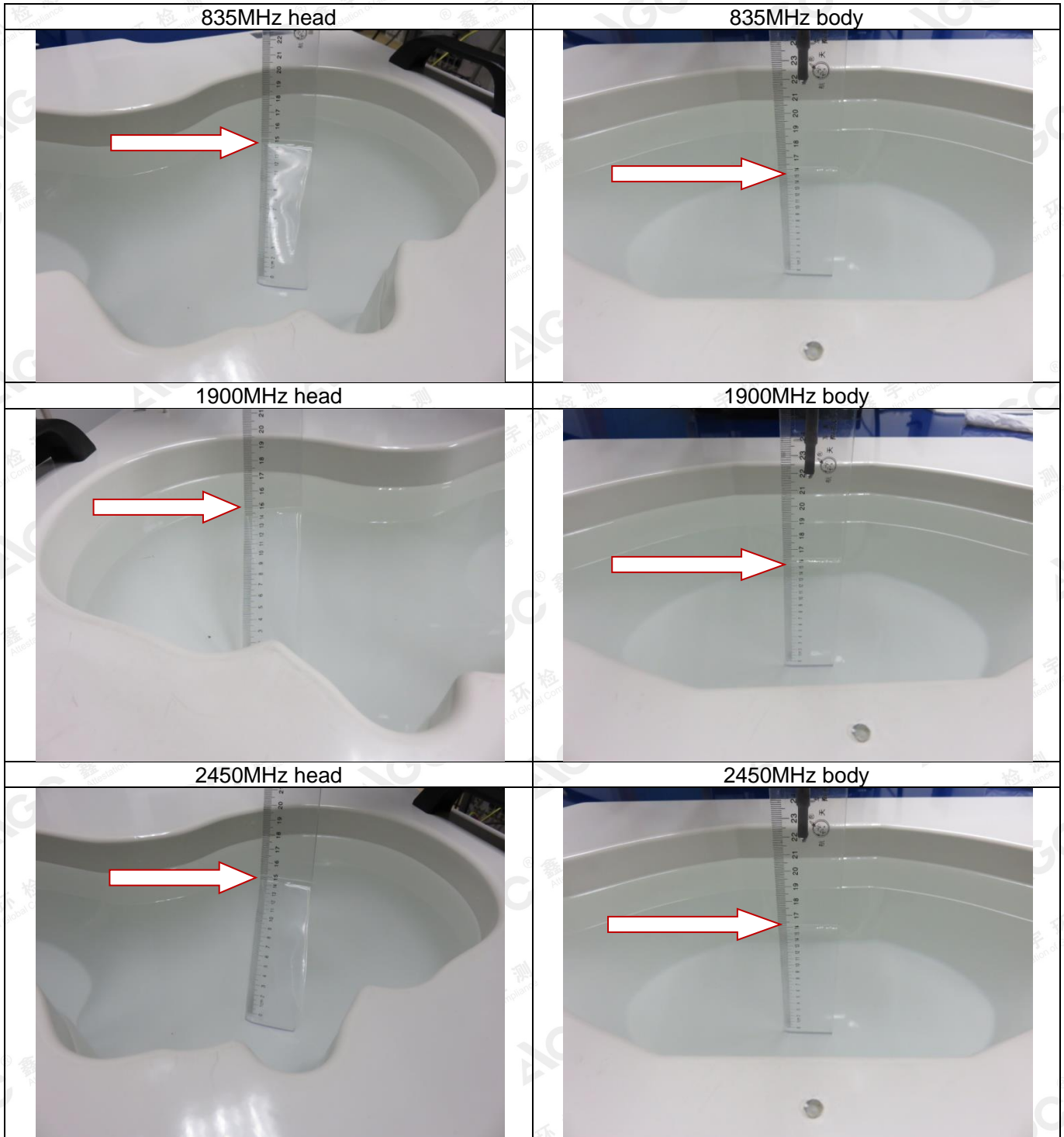

The results shown in this test report refer only to the sample(s) tested unless otherwise stated and the sample(s) are retained for 30 days only. The document is issued by AGC, this document cannot be reproduced except in full with our prior written permission. The more details and the authenticity of the report will be confirmed at <http://www.agc-cert.com>.

APPENDIX D. CALIBRATION DATA

Refer to Attached files.

The results shown in this test report refer only to the sample(s) tested unless otherwise stated and the sample(s) are retained for 30 days only. The document is issued by AGC, this document cannot be reproduced except in full with our prior written permission. The more details and the authenticity of the report will be confirmed at <http://www.agc-cert.com>.