

# FCC Test Report

Report No.: AGC00767190402FE01

**FCC ID** : 2ALTA4G001X  
**APPLICATION PURPOSE** : Original Equipment  
**PRODUCT DESIGNATION** : Smart phone  
**BRAND NAME** : Avvio, Mint  
**MODEL NAME** : 4G0, 4G0+, M342  
**CLIENT** : Planet Avvio LLC  
**DATE OF ISSUE** : May 15, 2019  
**STANDARD(S)** : FCC Part 15B Rules  
**REPORT VERSION** : V1.0

Attestation of Global Compliance (Shenzhen) Co., Ltd

**CAUTION:**

This report shall not be reproduced except in full without the written permission of the test laboratory and shall not be quoted out of context.



The results shown in this test report refer only to the sample(s) tested unless otherwise stated and the sample(s) are retained for 30 days only. The document is issued by AGC, this document cannot be reproduced except in full with our prior written permission. The more details and the authenticity of the report will be confirmed at <http://www.agc-cert.com>.

**Report Revise Record**

Report Version	Revise Time	Issued Date	Valid Version	Notes
V1.0	/	May 15, 2019	Valid	Initial Release

The results shown in this test report refer only to the sample(s) tested unless otherwise stated and the sample(s) are retained for 30 days only. The document is issued by AGC, this document cannot be reproduced except in full with our prior written permission. The more details and the authenticity of the report will be confirmed at <http://www.agc-cert.com>.

**TABLE OF CONTENTS**

**1. SYSTEM DESCRIPTION ..... 5**

**2. MEASUREMENT UNCERTAINTY ..... 6**

**3. PRODUCT INFORMATION..... 7**

**4. SUPPORT EQUIPMENT ..... 8**

**5. TEST FACILITY ..... 9**

**6. TEST ITEMS AND THE RESULTS ..... 10**

**7. FCCLINE CONDUCTED EMISSION TEST ..... 11**

    7.1. LIMITS OF LINE CONDUCTED EMISSION TEST .....11

    7.2. BLOCK DIAGRAM OF TEST SETUP .....11

    7.3. PROCEDURE OF LINE CONDUCTED EMISSION TEST ..... 12

    7.4. TEST RESULT OF LINE CONDUCTED EMISSION TEST ..... 13

**8. FCC RADIATED EMISSION TEST ..... 15**

    8.1. EXCEPT FOR CLASS A DIGITAL DEVICES, THE FIELD STRENGTH OF RADIATED EMISSIONS FROM UNINTENTIONAL RADIATORS AT A DISTANCE OF 3 METERS SHALL NOT EXCEED THE FOLLOWING VALUES: ..... 15

    8.2. BLOCK DIAGRAM OF TEST SETUP ..... 16

    8.3. PROCEDURE OF RADIATED EMISSION TEST ..... 17

    8.4. TEST RESULT OF RADIATED EMISSION TEST ..... 18

**APPENDIX A: PHOTOGRAPHS OF TEST SETUP ..... 22**

The results shown in this test report refer only to the sample(s) tested unless otherwise stated and the sample(s) are retained for 30 days only. The document is issued by AGC, this document cannot be reproduced except in full with our prior written permission. The more details and the authenticity of the report will be confirmed at <http://www.agc-cert.com>.



**1. VERIFICATION OF CONFORMITY**

<b>Applicant</b>	Planet Avvio LLC
<b>Address</b>	9725 NW 117th Ave, Medley, Florida , 33178 United States
<b>Manufacturer</b>	LAAGIN COMPANY LIMITED
<b>Address</b>	RM 1905 NAN FUNG CENTRE,264-298 CASTLE PEAK ROAD,TSUEN WAN, HONG KONG 518000
<b>Factory</b>	Shenzhen Tensen Technology Co., LTD.
<b>Address</b>	4th Floor,Yufeng Building, Jinhai Road No.6-9, Xixiang Street Bao'an District, Shenzhen
<b>Product Designation</b>	Smart phone
<b>Brand Name</b>	Avvio, Mint
<b>Test Model</b>	4GO
<b>Series Model</b>	4GO+, M342
<b>Difference description</b>	a) All the same except for brand name and model name, the corresponding relationship are as follow: b) <b>Avvio</b> is corresponding <b>4GO, 4GO+;</b> <b>Mint</b> is corresponding <b>M342;</b>
<b>Date of test</b>	Apr. 16, 2019~May 12, 2019
<b>Deviation</b>	None
<b>Condition of Test Sample</b>	Normal
<b>Report Template</b>	AGCRT-US-IT/AC

The above equipment was tested by Attestation of Global Compliance (Shenzhen) Co., Ltd. for compliance with the requirements set forth in the FCC Rules and Regulations Part 15, the measurement procedure according to ANSI C63.4:2014. This said equipment in the configuration described in this report shows the maximum emission levels emanating from equipment are within the compliance requirements.

The test results of this report relate only to the tested sample identified in this report.

Tested By



 Donjon Huang(Huang  
dongyang)

May 12, 2019

Reviewed By



Max Zhang(Zhang Yi)

May 15, 2019

Approved By



 Forrest Lei(Lei Yonggang)  
 Authorized Officer

May 15, 2019

The results shown in this test report refer only to the sample(s) tested unless otherwise stated and the sample(s) are retained for 30 days only. The document is issued by AGC, this document cannot be reproduced except in full with our prior written permission. The more details and the authenticity of the report will be confirmed at <http://www.agc-cert.com>.

## 2. SYSTEM DESCRIPTION

### EUT test procedure:

1. Connect EUT and peripheral devices (PC) through USB port.
2. Power on the EUT, use the software to transfer data between EUT and PC.
3. Make sure the EUT operates normally during the test.

### Test Mode

TEST MODE DESCRIPTION		
NO.	TEST MODE DESCRIPTION	WORST
1	USB (connection for data transferring)	V
Note: 1. V means EMI worst mode 2. USB cable is provided by AGC-Lab.		

The results shown in this test report refer only to the sample(s) tested unless otherwise stated and the sample(s) are retained for 30 days only. The document is issued by AGC, this document cannot be reproduced except in full with our prior written permission. The more details and the authenticity of the report will be confirmed at <http://www.agc-cert.com>.

### 3. MEASUREMENT UNCERTAINTY

Test	Measurement Uncertainty	Notes
Transmitter power conducted	±0.57 dB	(1)
Transmitter power Radiated	±2.20 dB	(1)
Conducted spurious emission 9KHz-40 GHz	±2.20 dB	(1)
Occupied Bandwidth	±0.01ppm	(1)
Radiated Emission 30~1000MHz	±4.10dB	(1)
Radiated Emission Above 1GHz	±4.32dB	(1)
Conducted Disturbance0.15~30MHz	±3.20dB	(1)

Note: This uncertainty represents an expanded uncertainty expressed at approximately the 95% confidence level using a coverage factor of k=2.

The results shown in this test report refer only to the sample(s) tested unless otherwise stated and the sample(s) are retained for 30 days only. The document is issued by AGC, this document cannot be reproduced except in full with our prior written permission. The more details and the authenticity of the report will be confirmed at <http://www.agc-cert.com>.



**4. PRODUCT INFORMATION**

<b>Housing Type</b>	Plastic and metal
<b>Hardware Version</b>	K200-PW-V2.0
<b>Software Version</b>	Avvio_4GO_Claro_v2.00
<b>EUT Input Rating</b>	DC 3.7V by Built-in Li-ion Battery

**I/O Port Information (Applicable Not Applicable)**

I/O Port of EUT			
I/O Port Type	Number	Specific	Tested With
USB Port	1	0.8 Unshielded	1

The results shown in this test report refer only to the sample(s) tested unless otherwise stated and the sample(s) are retained for 30 days only. The document is issued by AGC, this document cannot be reproduced except in full with our prior written permission. The more details and the authenticity of the report will be confirmed at <http://www.agc-cert.com>.

**5. SUPPORT EQUIPMENT**

Device Type	Manufacturer	Model Name	Serial No.	Data Cable	Power Cable
PC	Xiaomi Inc.	--	--	--	--
Adapter	Xiaomi Inc.	--	--	--	1.25m Unshielded

**Note:** All the above equipment/cables were placed in worse case positions to maximize emission signals during emission test.

The results shown in this test report refer only to the sample(s) tested unless otherwise stated and the sample(s) are retained for 30 days only. The document is issued by AGC, this document cannot be reproduced except in full with our prior written permission. The more details and the authenticity of the report will be confirmed at <http://www.agc-cert.com>.



**6. TEST FACILITY**

<b>Test Site</b>	Attestation of Global Compliance (Shenzhen) Co., Ltd
<b>Location</b>	1-2/F, Building 19, Junfeng Industrial Park, Chongqing Road, Heping Community, Fuhai Street, Bao'an District, Shenzhen, Guangdong, China
<b>Designation Number</b>	CN1259
<b>FCC Test Firm Registration Number</b>	975832
<b>A2LA Cert. No.</b>	5054.02
<b>Description</b>	Attestation of Global Compliance(Shenzhen) Co., Ltd is accredited by A2LA

**TEST EQUIPMENT OF CONDUCTED EMISSION TEST**

Equipment	Manufacturer	Model	S/N	Cal. Date	Cal. Due
TEST RECEIVER	R&S	ESPI	101206	Jun.18, 2018	Jun.17, 2019
LISN	R&S	ESH2-Z5	100086	Aug.19, 2018	Aug.18, 2019

**TEST EQUIPMENT OF RADIATED EMISSION TEST**

Equipment	Manufacturer	Model	S/N	Cal. Date	Cal. Due
TEST RECEIVER	R&S	ESCI	10096	Jun.18, 2018	Jun.17, 2019
EXA Signal Analyzer	Aglient	N9010A	MY53470504	Dec.06, 2018	Dec.05, 2019
Horn antenna	SCHWARZBECK	BBHA 9170	#768	Sep.20, 2018	Sep.19, 2020
preamplifier	ChengYi	EMC184045SE	980508	Sep.20, 2018	Sep.19, 2020
Double-Ridged Waveguide Horn	ETS LINDGREN	3117	00034609	May.18, 2017	May.17, 2019
Broadband Preamplifier	SCHWARZBECK	BBV 9718	9718-205	Jun.18, 2018	Jun.17, 2019
ANTENNA	SCHWARZBECK	VULB9168	D69250	Sep.20, 2018	Sep.19, 2020

The results shown in this test report refer only to the sample(s) tested unless otherwise stated and the sample(s) are retained for 30 days only. The document is issued by AGC, this document cannot be reproduced except in full with our prior written permission. The more details and the authenticity of the report will be confirmed at <http://www.agc-cert.com>.

**6. TEST ITEMS AND THE RESULTS**

Test item	Test Requirement	Test Method	Class/Severity	Result
CONDUCTED EMISSION	FCC Part 15.107 Rules	ANSI C63.4:2014	Class B	Pass
RADIATED EMISSION	FCC Part 15.109 Rules	ANSI C63.4:2014	Class B	Pass

The results shown in this test report refer only to the sample(s) tested unless otherwise stated and the sample(s) are retained for 30 days only. The document is issued by AGC, this document cannot be reproduced except in full with our prior written permission. The more details and the authenticity of the report will be confirmed at <http://www.agc-cert.com>.

## 7. FCCLINE CONDUCTED EMISSION TEST

### 7.1. LIMITS OF LINE CONDUCTED EMISSION TEST

Frequency	Maximum RF Line Voltage	
	Q.P.( dBuV)	Average( dBuV)
150kHz-500kHz	66-56	56-46
500kHz-5MHz	56	46
5MHz-30MHz	60	50

**Note:**

1. The lower limit shall apply at the transition frequency.
2. The limit decreases linearly with the logarithm of the frequency in the range 0.15 MHz to 0.50MHz.

### 7.2. BLOCK DIAGRAM OF TEST SETUP

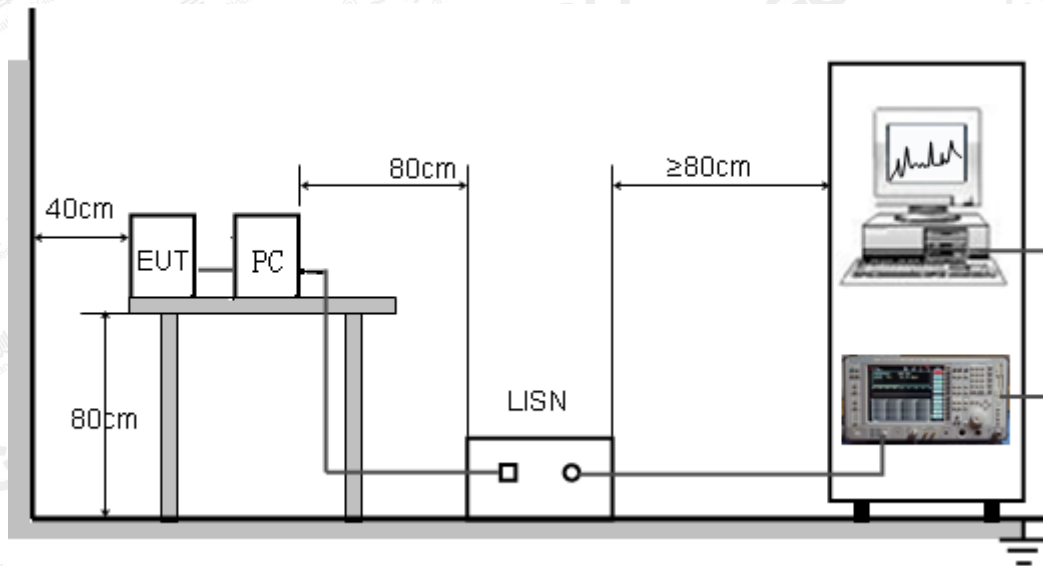

The results shown in this test report refer only to the sample(s) tested unless otherwise stated and the sample(s) are retained for 30 days only. The document is issued by AGC, this document cannot be reproduced except in full with our prior written permission. The more details and the authenticity of the report will be confirmed at <http://www.agc-cert.com>.



### 7.3. PROCEDURE OF LINE CONDUCTED EMISSION TEST

- (1) The equipment was set up as per the test configuration to simulate typical actual usage per the user's manual. When the EUT is a tabletop system, a wooden table with a height of 0.8 meters is used and is placed on the ground plane as per ANSI C63.4 (see Test Facility for the dimensions of the ground plane used). When the EUT is a floor-standing equipment, it is placed on the ground plane which has a 3-12 mm non-conductive covering to insulate the EUT from the ground plane.
- (2) Support equipment, if needed, was placed as per ANSI C63.4.
- (3) All I/O cables were positioned to simulate typical actual usage as per ANSI C63.4.
- (4) The EUT received DC5V power from PC with receive AC120V/60Hz power from a LISN.
- (5) The EUT test program was started. Emissions were measured on each current carrying line of the EUT using a spectrum Analyzer / Receiver connected to the LISN powering the EUT. The LISN has two monitoring points: Line 1 (Hot Side) and Line 2 (Neutral Side). Two scans were taken: one with Line 1 connected to Analyzer / Receiver and Line 2 connected to a 50 ohm load; the second scan had Line 1 connected to a 50 ohm load and Line 2 connected to the Analyzer / Receiver.
- (6) Analyzer / Receiver scanned from 150 kHz to 30MHz for emissions in each of the test modes.
- (7) During the above scans, the emissions were maximized by cable manipulation.
- (8) A scan was taken on both power lines, Line 1 and Line 2, recording at least the six highest emissions.
- (9) Emission frequency and amplitude were recorded into a computer in which correction factors were used to calculate the emission level and compare reading to the applicable limit. If EUT emission level was less -2dB to the A.V. limit in Peak mode, then the emission signal was re-checked using Q.P and Average detector.

The test data of the worst case condition (mode 1) was reported on the Summary Data page.

The results shown in this test report refer only to the sample(s) tested unless otherwise stated and the sample(s) are retained for 30 days only. The document is issued by AGC, this document cannot be reproduced except in full with our prior written permission. The more details and the authenticity of the report will be confirmed at <http://www.agc-cert.com>.

**7.4. TEST RESULT OF LINE CONDUCTED EMISSION TEST**

**LINE CONDUCTED EMISSION TEST-L**

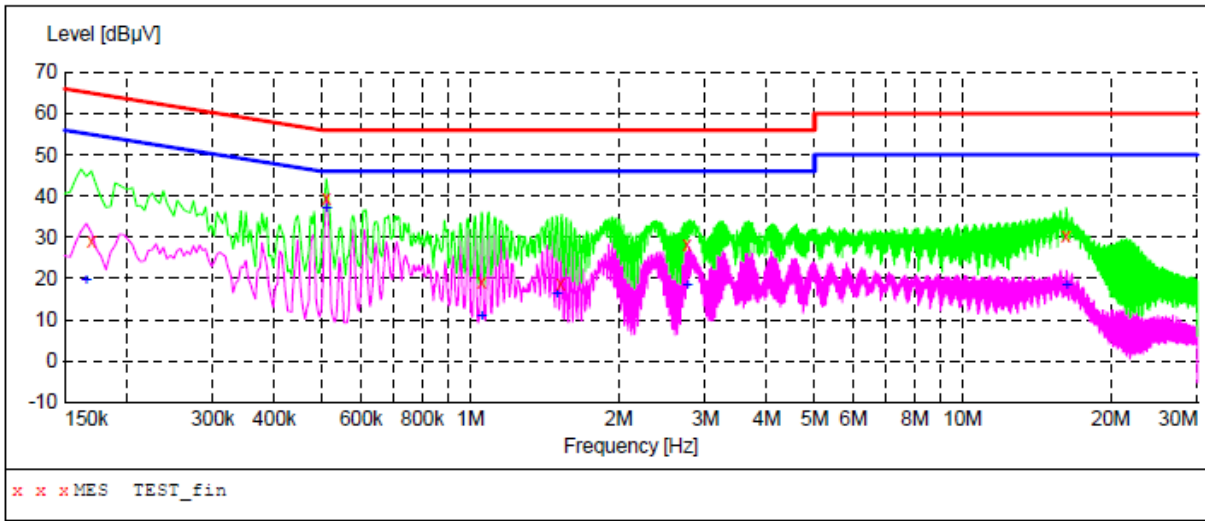

**MEASUREMENT RESULT: "TEST\_fin"**

Frequency MHz	Level dBµV	Transd dB	Limit dBµV	Margin dB	Detector	Line	PE
0.170000	29.10	10.3	65	35.9	QP	L1	FLO
0.510000	39.50	10.3	56	16.5	QP	L1	FLO
1.054000	19.10	10.4	56	36.9	QP	L1	FLO
1.530000	18.60	10.4	56	37.4	QP	L1	FLO
2.754000	28.40	10.4	56	27.6	QP	L1	FLO
16.190000	30.20	10.9	60	29.8	QP	L1	FLO

**MEASUREMENT RESULT: "TEST\_fin2"**

Frequency MHz	Level dBµV	Transd dB	Limit dBµV	Margin dB	Detector	Line	PE
0.166000	19.40	10.3	55	35.8	AV	L1	FLO
0.510000	36.80	10.3	46	9.2	AV	L1	FLO
1.054000	10.90	10.4	46	35.1	AV	L1	FLO
1.498000	16.30	10.4	46	29.7	AV	L1	FLO
2.754000	18.30	10.4	46	27.7	AV	L1	FLO
16.262000	18.20	10.9	50	31.8	AV	L1	FLO

The results shown in this test report refer only to the sample(s) tested unless otherwise stated and the sample(s) are retained for 30 days only. The document is issued by AGC, this document cannot be reproduced except in full with our prior written permission. The more details and the authenticity of the report will be confirmed at <http://www.agc-cert.com>.

LINE CONDUCTED EMISSION TEST-N

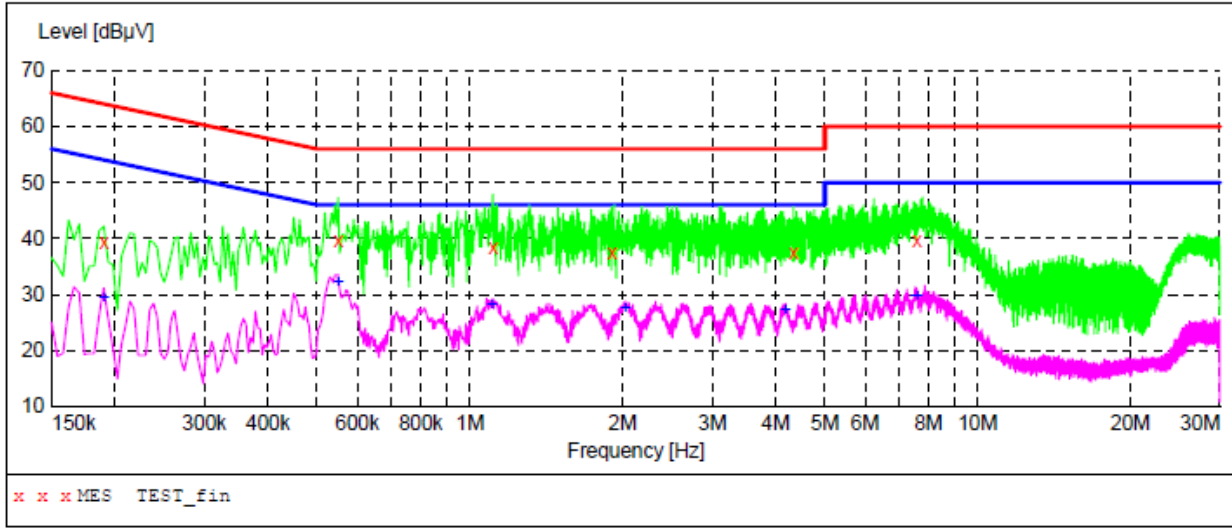

**MEASUREMENT RESULT: "TEST\_fin"**

Frequency MHz	Level dBµV	Transd dB	Limit dBµV	Margin dB	Detector	Line	PE
0.190000	39.20	10.3	64	24.8	QP	N	FLO
0.550000	39.50	10.3	56	16.5	QP	N	FLO
1.110000	38.50	10.4	56	17.5	QP	N	FLO
1.902000	37.60	10.4	56	18.4	QP	N	FLO
4.338000	37.30	10.4	56	18.7	QP	N	FLO
7.590000	39.70	10.6	60	20.3	QP	N	FLO

**MEASUREMENT RESULT: "TEST\_fin2"**

Frequency MHz	Level dBµV	Transd dB	Limit dBµV	Margin dB	Detector	Line	PE
0.190000	29.40	10.3	54	24.6	AV	N	FLO
0.550000	32.30	10.3	46	13.7	AV	N	FLO
1.102000	28.20	10.4	46	17.8	AV	N	FLO
2.022000	27.50	10.4	46	18.5	AV	N	FLO
4.174000	27.10	10.4	46	18.9	AV	N	FLO
7.590000	29.60	10.6	50	20.4	AV	N	FLO

**RESULT: PASS**

The results shown in this test report refer only to the sample(s) tested unless otherwise stated and the sample(s) are retained for 30 days only. The document is issued by AGC, this document cannot be reproduced except in full with our prior written permission. The more details and the authenticity of the report will be confirmed at <http://www.agc-cert.com>.



## 8. FCC RADIATED EMISSION TEST

8.1. EXCEPT FOR CLASS A DIGITAL DEVICES, THE FIELD STRENGTH OF RADIATED EMISSIONS FROM UNINTENTIONAL RADIATORS AT A DISTANCE OF 3 METERS SHALL NOT EXCEED THE FOLLOWING VALUES:

Frequency (MHz)	Distance (m)	Maximum Field Strength Limit (dBuV/m/ Q.P.)
30~88	3	40.0
88~216	3	43.5
216~960	3	46.0
Above 960	3	54.0

Note: The lower limit shall apply at the transition frequency.

8.1.1 The following table is the setting of spectrum analyzer and receiver:

Spectrum Parameter	Setting
Start ~Stop Frequency	9KHz~150KHz/RB 200Hz for QP
Start ~Stop Frequency	150KHz~30MHz/RB 9KHz for QP
Start ~Stop Frequency	30MHz~1000MHz/RB 120KHz for QP
Start ~Stop Frequency	1GHz~26.5GHz 1MHz/1MHz for Peak, 1MHz/10Hz for Average

Receiver Parameter	Setting
Start ~Stop Frequency	9KHz~150KHz/RB 200Hz for QP
Start ~Stop Frequency	150KHz~30MHz/RB 9KHz for QP
Start ~Stop Frequency	30MHz~1000MHz/RB 120KHz for QP

The results shown in this test report refer only to the sample(s) tested unless otherwise stated and the sample(s) are retained for 30 days only. The document is issued by AGC, this document cannot be reproduced except in full with our prior written permission. The more details and the authenticity of the report will be confirmed at <http://www.agc-cert.com>.

**8.2. BLOCK DIAGRAM OF TEST SETUP**

System Diagram of Connections between EUT and Simulators

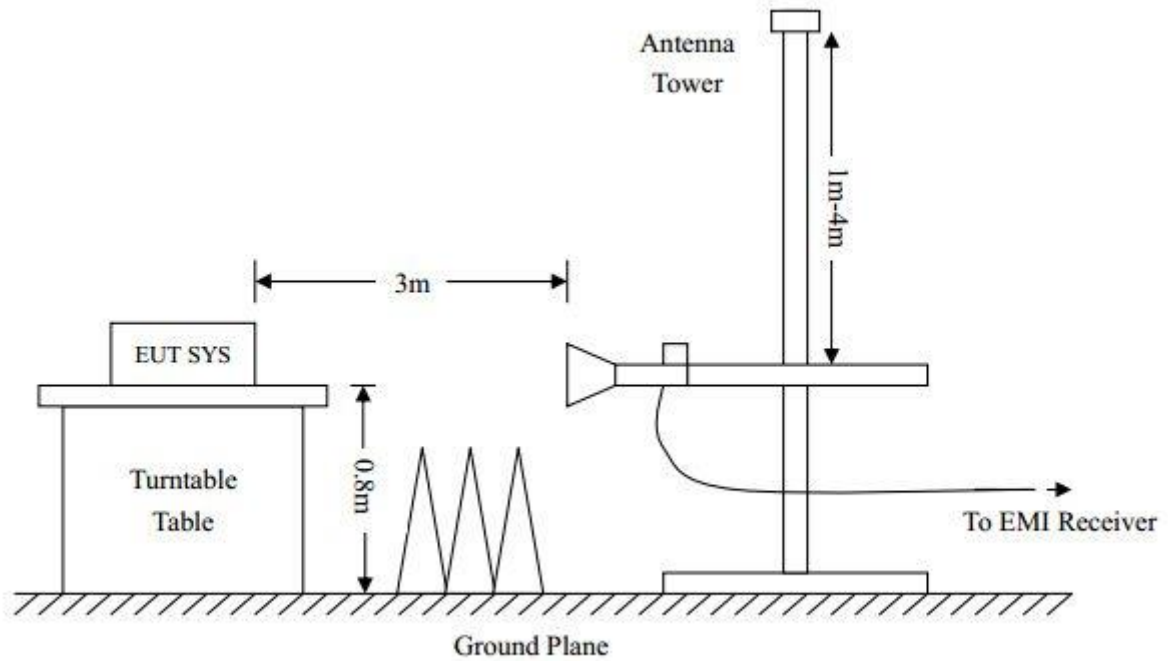
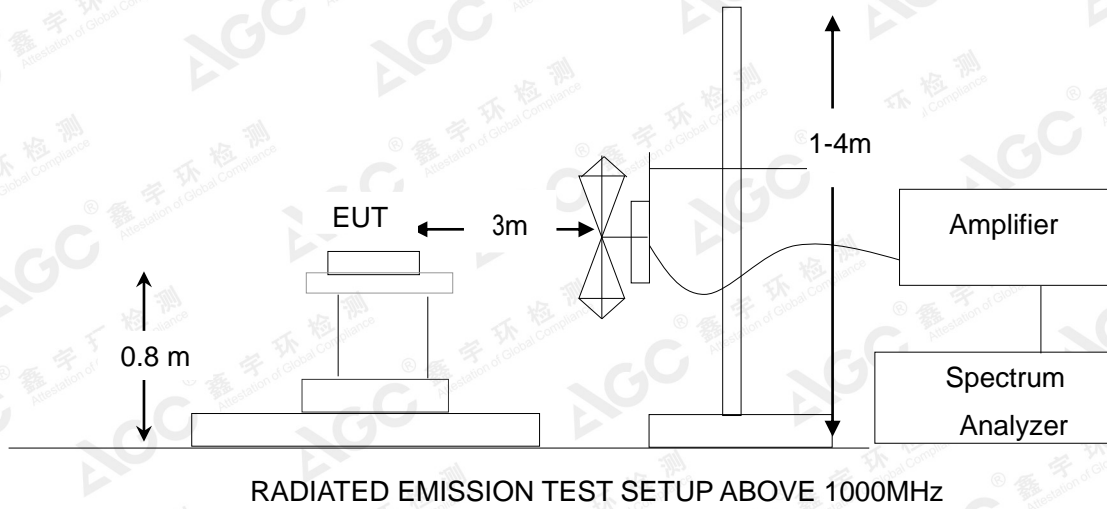

The results shown in this test report refer only to the sample(s) tested unless otherwise stated and the sample(s) are retained for 30 days only. The document is issued by AGC, this document cannot be reproduced except in full with our prior written permission. The more details and the authenticity of the report will be confirmed at <http://www.agc-cert.com>.



### 8.3. PROCEDURE OF RADIATED EMISSION TEST

1. Configure the EUT according to ANSI C63.4. The EUT was placed on the top of the turntable 0.8 meter above ground. The phase center of the receiving antenna mounted on the top of a height-variable antenna tower was placed 3 meters far away from the turntable.
2. Power on the EUT and all the supporting units. The turntable was rotated by 360 degrees to determine the position of the highest radiation.
3. The height of the broadband receiving antenna was varied between one meter and four meters above ground to find the maximum emissions field strength of both horizontal and vertical polarization.
4. For each suspected emissions, the antenna tower was scan (from 1 M to 4 M) and then the turntable was rotated (from 0 degree to 360 degrees) to find the maximum reading.
5. Set the test-receiver system to Peak or CISPR quasi-peak Detect Function with specified bandwidth under Maximum Hold Mode.
6. For emissions above 1GHz, use 1MHz RBW and 3MHz VBW for peak reading. Then 1MHz RBW and 3MHz VBW for average reading in spectrum analyzer. The EUT was placed on the top of the turntable 0.8 meter above ground. The phase center of the receiving antenna mounted on the top of a height-variable antenna tower was placed 3 meters far away from the turntable.
7. When the radiated emissions limits are expressed in terms of the average value of the emissions, and pulsed operation is employed, the measurement field strength shall be determined by averaging over one complete pulse train, including blanking intervals, as long as the pulse train does not exceed 0.1 seconds. As an alternative (provided the transmitter operates for longer than 0.1 seconds) or in cases where the pulse train exceeds 0.1 seconds, the measured field strength shall be determined from the average absolute voltage during a 0.1 second interval during which the field strength is at its maximum values.
8. If the emissions level of the EUT in peak mode was 3 dB lower than the average limit specified, then testing will be stopped and peak values of EUT will be reported, otherwise, the emissions which do not have 3 dB margin will be repeated one by one using the quasi-peak method for below 1GHz.
9. If the emission level of the EUT in peak mode was 10 dB lower than the limit specified, then testing could be stopped and the peak values of the EUT would be reported. Otherwise the emissions that did not have 10 dB margin would be re-tested one by one using peak, quasi-peak or average method as specified and then reported in a data sheet.
10. In case the emission is lower than 30MHz, loop antenna has to be used for measurement and the recorded data should be QP measured by receiver. High - Low scan is not required in this case.
11. The test data of the worst case condition (mode 1) was reported on the Summary Data page.

The results shown in this test report refer only to the sample(s) tested unless otherwise stated and the sample(s) are retained for 30 days only. The document is issued by AGC, this document cannot be reproduced except in full with our prior written permission. The more details and the authenticity of the report will be confirmed at <http://www.agc-cert.com>.



**8.4. TEST RESULT OF RADIATED EMISSION TEST**  
**RADIATED EMISSION TEST AT 3M DISTANCE-HORIZONTAL**

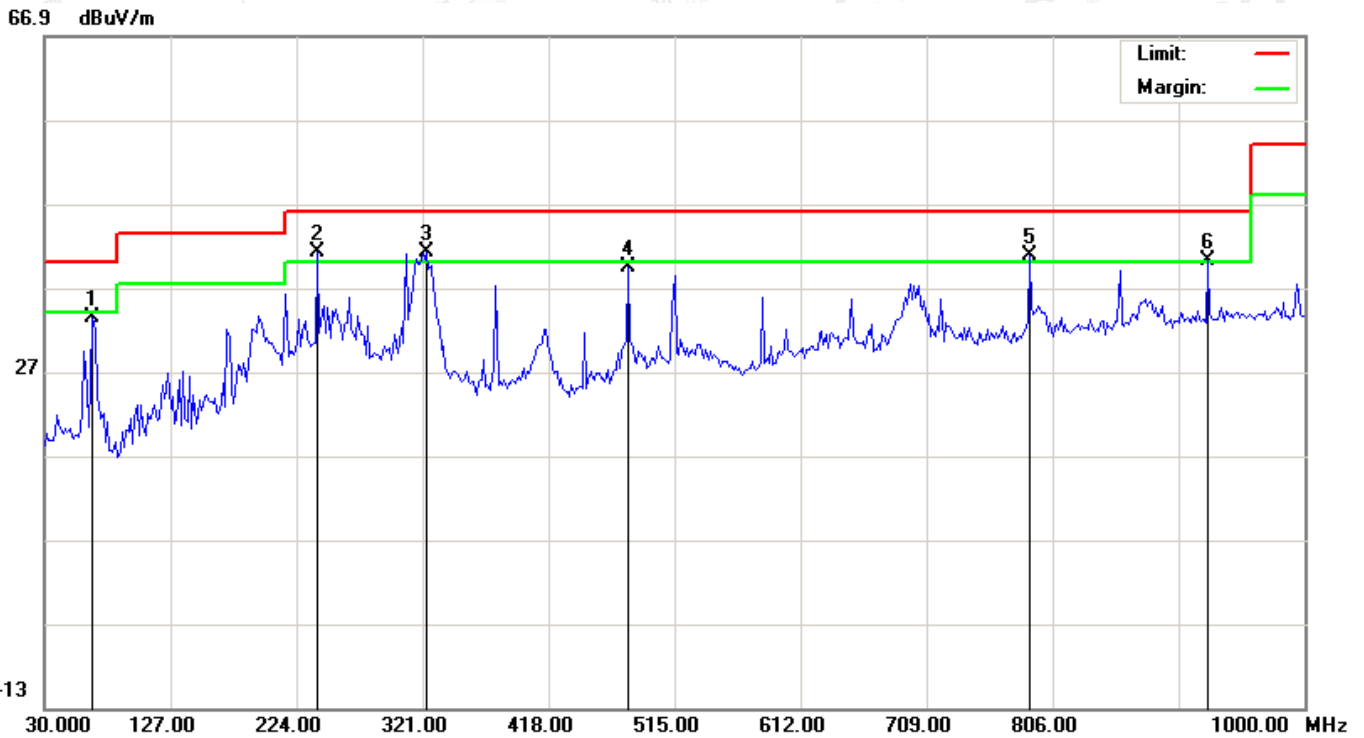

No.	Mk	Freq.	Reading	Factor	Measurement	Limit	Over	Detector	Antenna Height	Table Degree	Comment
		MHz	dBuV	dB/m	dBuV/m	dBuV/m	dB		cm	degree	
1		67.1833	15.87	17.61	33.48	40.00	-6.52	peak			
2	!	240.1666	22.59	18.66	41.25	46.00	-4.75	peak			
3	*	324.2332	20.96	20.32	41.28	46.00	-4.72	peak			
4		479.4332	14.75	24.58	39.33	46.00	-6.67	peak			
5	!	788.2166	10.74	30.14	40.88	46.00	-5.12	peak			
6	!	925.6332	8.21	31.92	40.13	46.00	-5.87	peak			

**RESULT: PASS**

The results shown in this test report refer only to the sample(s) tested unless otherwise stated and the sample(s) are retained for 30 days only. The document is issued by AGC, this document cannot be reproduced except in full with our prior written permission. The more details and the authenticity of the report will be confirmed at <http://www.agc-cert.com>.

RADIATED EMISSION TEST AT 3M DISTANCE-VERTICAL

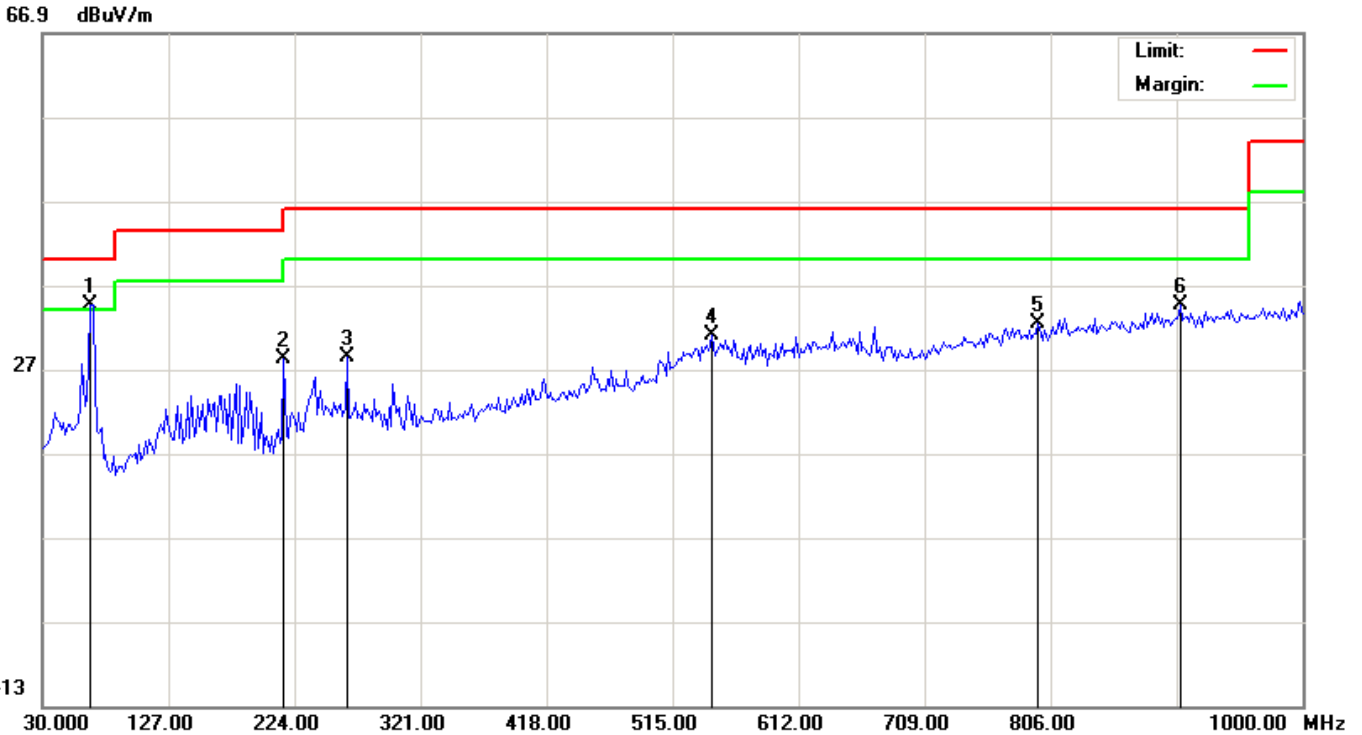

No.	Mk	Freq.	Reading	Factor	Measurement	Limit	Over	Detector	Antenna Height	Table Degree	Comment
		MHz	dBuV	dB/m	dBuV/m	dBuV/m	dB		cm	degree	
1	*	67.1833	17.02	17.61	34.63	40.00	-5.37	peak			
2		215.9167	11.30	17.00	28.30	43.50	-15.20	peak			
3		264.4166	9.80	18.67	28.47	46.00	-17.53	peak			
4		545.7167	5.10	25.89	30.99	46.00	-15.01	peak			
5		796.3000	2.12	30.33	32.45	46.00	-13.55	peak			
6		906.2333	2.78	31.75	34.53	46.00	-11.47	peak			

**RESULT: PASS**

Note: 1.Measurement = Reading + Factor, Over = Measurement – Limit.

2. The “Factor” value can be calculated automatically by software of measurement system.

The results shown in this test report refer only to the sample(s) tested unless otherwise stated and the sample(s) are retained for 30 days only. The document is issued by AGC, this document cannot be reproduced except in full with our prior written permission. The more details and the authenticity of the report will be confirmed at <http://www.agc-cert.com>.

RADIATED EMISSION ABOVE 1GHZ TEST AT 3M DISTANCE –HORIZONTAL

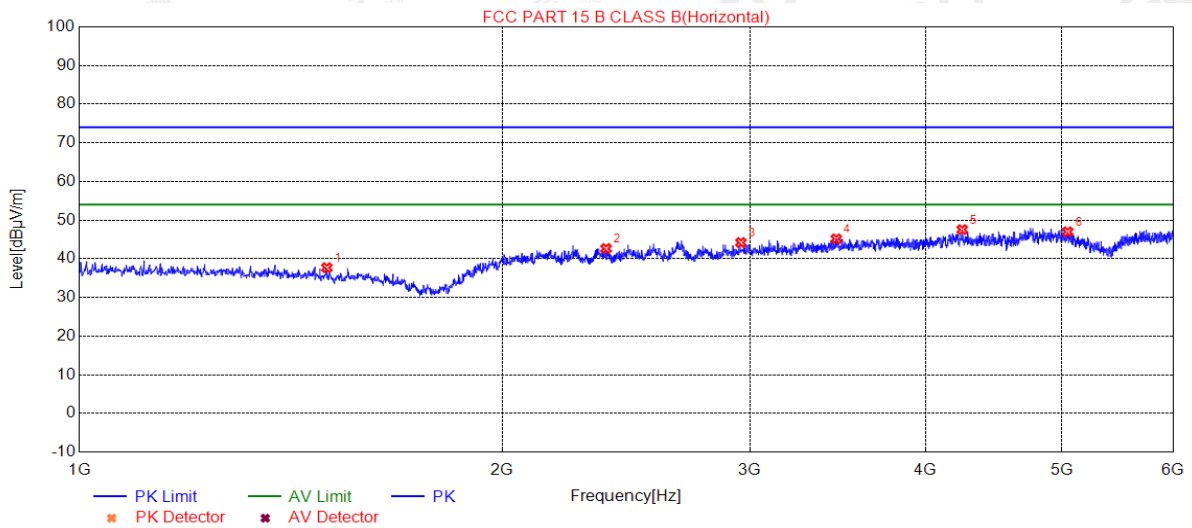

NO.	Freq. [MHz]	Level [dBµV/m]	Factor [dB]	Limit [dBµV/m]	Margin [dB]	Height [cm]	Angle [°]	Polarity
1	1500.1000	37.69	-17.13	74.00	36.31	150	10	Horizontal
2	2370.2741	42.63	-10.26	74.00	31.37	200	50	Horizontal
3	2956.3913	44.18	-9.36	74.00	29.82	200	130	Horizontal
4	3456.4913	45.15	-7.75	74.00	28.85	100	340	Horizontal
5	4248.6497	47.54	-5.85	74.00	26.46	100	250	Horizontal
6	5050.8102	46.97	-4.78	74.00	27.03	150	20	Horizontal

The results shown in this test report refer only to the sample(s) tested unless otherwise stated and the sample(s) are retained for 30 days only. The document is issued by AGC, this document cannot be reproduced except in full with our prior written permission. The more details and the authenticity of the report will be confirmed at <http://www.agc-cert.com>.



RADIATED EMISSION ABOVE 1GHZ TEST AT 3M DISTANCE –VERTICAL

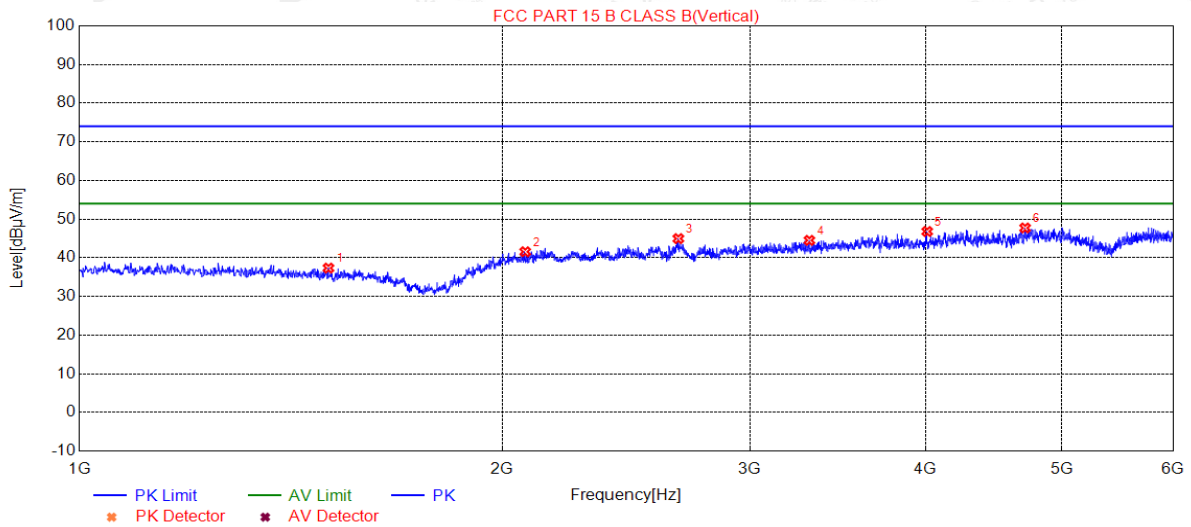

NO.	Freq. [MHz]	Level [dBµV/m]	Factor [dB]	Limit [dBµV/m]	Margin [dB]	Height [cm]	Angle [°]	Polarity
1	1504.1008	37.33	-17.09	74.00	36.67	200	320	Vertical
2	2076.2152	41.55	-11.50	74.00	32.45	100	300	Vertical
3	2668.3337	44.95	-9.59	74.00	29.05	200	340	Vertical
4	3307.4615	44.50	-8.27	74.00	29.50	100	220	Vertical
5	4011.6023	46.80	-6.47	74.00	27.20	150	340	Vertical
6	4709.7419	47.71	-5.00	74.00	26.29	150	90	Vertical

- Note:** 1. Emissions range from 6GHz to 12.5GHz have 20dB margin. No recording in the test report.  
 2. Factor=Antenna Factor + Cable loss - Amplifier gain, Margin=Measurement-Limit.  
 3. The "Factor" value can be calculated automatically by software of measurement system.

The results shown in this test report refer only to the sample(s) tested unless otherwise stated and the sample(s) are retained for 30 days only. The document is issued by AGC, this document cannot be reproduced except in full with our prior written permission. The more details and the authenticity of the report will be confirmed at <http://www.agc-cert.com>.

**APPENDIX A: PHOTOGRAPHS OF TEST SETUP**  
**FCC LINE CONDUCTED EMISSION TEST SETUP**



**FCC RADIATED EMISSION TEST SETUP**

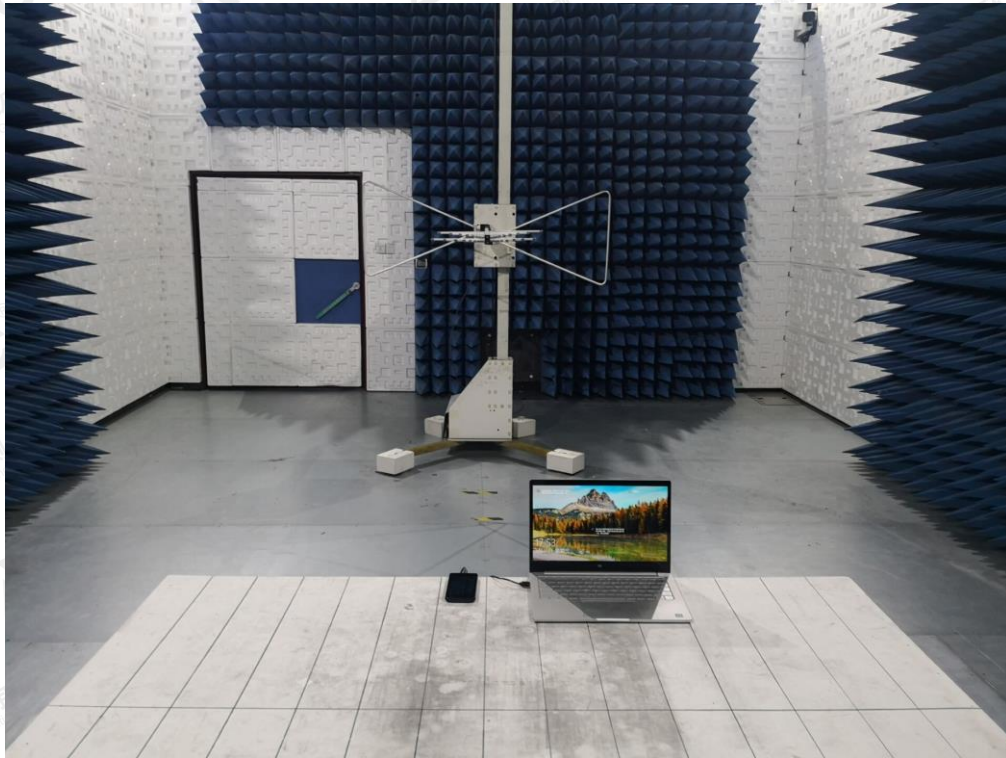

The results shown in this test report refer only to the sample(s) tested unless otherwise stated and the sample(s) are retained for 30 days only. The document is issued by AGC, this document cannot be reproduced except in full with our prior written permission. The more details and the authenticity of the report will be confirmed at <http://www.agc-cert.com>.



FCC RADIATED EMISSION TEST SETUP

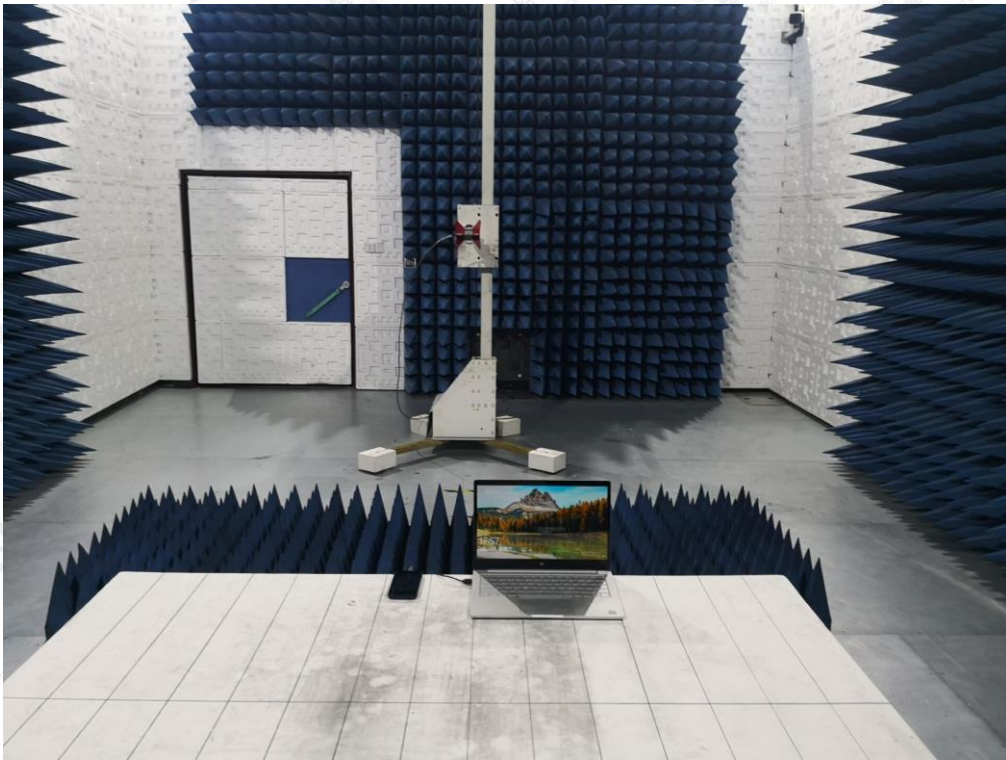

-----END OF REPORT-----

The results shown in this test report refer only to the sample(s) tested unless otherwise stated and the sample(s) are retained for 30 days only. The document is issued by AGC, this document cannot be reproduced except in full with our prior written permission. The more details and the authenticity of the report will be confirmed at <http://www.agc-cert.com>.