



FCC RF Test Report

APPLICANT : Planet Avvio LLC
EQUIPMENT : Mobile phone
BRAND NAME : Avvio
MODEL NAME : 362
FCC ID : 2ALTA362X
STANDARD : FCC 47 CFR Part 2, 22(H), 24(E)
CLASSIFICATION : PCS Licensed Transmitter Held to Ear (PCE)

The product was received on Oct. 17, 2017 and testing was completed on Oct. 23, 2017. We, Sporton International (Shenzhen) Inc., would like to declare that the tested sample has been evaluated in accordance with the test procedures given in ANSI / TIA / EIA-603-D-2010 and has been in compliance with the applicable technical standards.

The test results in this report apply exclusively to the tested model / sample. Without written approval of Sporton International (Shenzhen) Inc., the test report shall not be reproduced except in full.



Approved by: Eric Shih / Manager

Sporton International (Shenzhen) Inc.

**1/F, 2/F, Bldg 5, Shiling Industrial Zone, Xinwei Village, Xili, Nanshan Shenzhen City
Guangdong Province 518055 China**



TABLE OF CONTENTS

- 1 GENERAL DESCRIPTION 5**
 - 1.1 Applicant..... 5
 - 1.2 Manufacturer 5
 - 1.3 Product Feature of Equipment Under Test 5
 - 1.4 Product Specification of Equipment Under Test 6
 - 1.5 Modification of EUT 6
 - 1.6 Maximum ERP/EIRP Power, Frequency Tolerance, and Emission Designator 7
 - 1.7 Testing Location 7
 - 1.8 Applicable Standards 8
- 2 TEST CONFIGURATION OF EQUIPMENT UNDER TEST 9**
 - 2.1 Test Mode..... 9
 - 2.2 Connection Diagram of Test System 10
 - 2.3 Support Unit used in test configuration 10
 - 2.4 Measurement Results Explanation Example 10
- 3 CONDUCTED TEST RESULT 11**
 - 3.1 Measuring Instruments..... 11
 - 3.2 Test Setup 11
 - 3.3 Test Result of Conducted Test..... 11
 - 3.4 Conducted Output Power and ERP/EIRP 12
 - 3.5 Peak-to-Average Ratio 13
 - 3.6 99% Occupied Bandwidth and 26dB Bandwidth Measurement..... 14
 - 3.7 Conducted Band Edge 15
 - 3.8 Conducted Spurious Emission 16
 - 3.9 Frequency Stability..... 17
- 4 RADIATED TEST ITEMS 18**
 - 4.1 Measuring Instruments..... 18
 - 4.2 Test Setup 18
 - 4.3 Test Result of Radiated Test..... 18
 - 4.4 Field Strength of Spurious Radiation Measurement 19
- 5 LIST OF MEASURING EQUIPMENT 20**
- 6 UNCERTAINTY OF EVALUATION 21**

APPENDIX A. TEST RESULTS OF CONDUCTED TEST

APPENDIX B. TEST RESULTS OF RADIATED TEST

APPENDIX C. TEST SETUP PHOTOGRAPHS



REVISION HISTORY

REPORT NO.	VERSION	DESCRIPTION	ISSUED DATE
FG701703	Rev. 01	Initial issue of report	Nov. 07, 2017



SUMMARY OF TEST RESULT

Report Section	FCC Rule	Description	Limit	Result	Remark
3.4	§2.1046	Conducted Output Power	Reporting Only	PASS	-
	§22.913(a)(2)	Effective Radiated Power	< 7 Watts	PASS	-
	§24.232(c)	Equivalent Isotropic Radiated Power	< 2 Watts	PASS	-
3.5	§24.232(d)	Peak-to-Average Ratio	< 13 dB	PASS	-
3.6	§2.1049 §22.917(b) §24.238(b)	Occupied Bandwidth	Reporting Only	PASS	-
3.7	§2.1051 §22.917(a) §24.238(a)	Band Edge Measurement	< 43+10log ₁₀ (P[Watts])	PASS	-
3.8	§2.1051 §22.917(a) §24.238(a)	Conducted Emission	< 43+10log ₁₀ (P[Watts])	PASS	-
3.9	§2.1055 §22.355	Frequency Stability for Temperature & Voltage	< 2.5 ppm for Part 22H	PASS	-
	§2.1055 §24.235		Within Authorized Band		
4.4	§2.1053 §22.917(a) §24.238(a)	Field Strength of Spurious Radiation	< 43+10log ₁₀ (P[Watts])	PASS	Under limit 31.86 dB at 3760.00 MHz



1 General Description

1.1 Applicant

Planet Avvio LLC
9725 NW 117th Ave.,Medley,FL 33178, United States

1.2 Manufacturer

UTIME TECHNOLOGY (HK) COMPANY LIMITED
7/F.,5-A Building, Software Industrial Base, No.1006 Keyuan Road, Nanshan District, Shenzhen, P.R.China

1.3 Product Feature of Equipment Under Test

Product Feature	
Equipment	Mobile phone
Brand Name	Avvio
Model Name	362
FCC ID	2ALTA362X
EUT supports Radios application	GSM/GPRS/EDGE(downlink only)/WCDMA/HSPA Bluetooth V2.1+EDR
IMEI Code	Conducted: 356778670090015 Radiation: 356778670090015
HW Version	V0.2
SW Version	Avvio362_PuertoRico_Claro_V01
EUT Stage	Identical Prototype

Remark: The above EUT's information was declared by manufacturer. Please refer to the specifications or user's manual for more detailed description.

1.4 Product Specification of Equipment Under Test

Standards-related Product Specification	
Tx Frequency	GSM/GPRS/ EDGE(Downlink only):: 850: 824.2 MHz ~ 848.8 MHz 1900: 1850.2 MHz ~ 1909.8MHz WCDMA: Band V: 826.4 MHz ~ 846.6 MHz Band II: 1852.4 MHz ~ 1907.6 MHz
Rx Frequency	GSM/GPRS/EDGE(Downlink only): 850: 869.2 MHz ~ 893.8 MHz 1900: 1930.2 MHz ~ 1989.8 MHz WCDMA: Band V: 871.4 MHz ~ 891.6 MHz Band II: 1932.4 MHz ~ 1987.6 MHz
Maximum Output Power to Antenna	GSM/GPRS/ EDGE(Downlink only):: 850: 32.22 dBm 1900: 29.24 dBm WCDMA: Band V: 22.68 dBm Band II: 22.41 dBm
Antenna Type	PIFA Antenna
Antenna Gain	Cellular Band: 0.60 dBi PCS Band: 1.30 dBi
Type of Modulation	GSM: GMSK GPRS: GMSK EDGE: GMSK / 8PSK(Downlink only) WCDMA : BPSK (Uplink) HSDPA : QPSK (Uplink) HSUPA : QPSK (Uplink)

1.5 Modification of EUT

No modifications are made to the EUT during all test items.



1.6 Maximum ERP/EIRP Power, Frequency Tolerance, and Emission Designator

FCC Rule	System	Type of Modulation	Maximum ERP/EIRP (W)	Frequency Tolerance (ppm)	Emission Designator
Part 22H	GSM850 GSM	GMSK	1.1668	0.0407 ppm	244KGXW
Part 22H	WCDMA Band V RMC 12.2Kbps	BPSK	0.1297	0.0203 ppm	4M11F9W
Part 24E	GSM1900 GSM	GMSK	1.1324	0.0229 ppm	244KGXW
Part 24E	WCDMA Band II RMC 12.2Kbps	BPSK	0.2350	0.0069 ppm	4M11F9W

1.7 Testing Location

Sporton Lab is accredited to ISO 17025 by National Voluntary Laboratory Accreditation Program (NVLAP code: 600156-0) and the FCC designation No are CN5018 and CN5019.

Test Site	Sporton International (Shenzhen) Inc.	
Test Site Location	1/F, 2/F, Bldg 5, Shiling Industrial Zone, Xinwei Village, Xili, Nanshan Shenzhen City Guangdong Province 518055 China TEL: +86-755-8637-9589 FAX: +86-755-8637-9595	
Test Site No.	Sporton Site No.	FCC Test Firm Registration No.
	TH01-SZ	251365

Test Site	Sporton International (Shenzhen) Inc.	
Test Site Location	No. 3 Bldg the third floor of south, Shahe River west, Fengzeyuan Warehouse, Nanshan District Shenzhen City Guangdong Province 518055 China TEL: +86-755-3320-2398	
Test Site No.	Sporton Site No.	FCC Test Firm Registration No.
	03CH01-SZ	577730

Note: The test site complies with ANSI C63.4 2014 requirement.



1.8 Applicable Standards

According to the specifications of the manufacturer, the EUT must comply with the requirements of the following standards:

- ♦ 47 CFR Part 2, 22(H), 24(E)
- ♦ ANSI / TIA / EIA-603-D-2010
- ♦ FCC KDB 971168 D01 Power Meas. License Digital Systems v02r02
- ♦ FCC KDB 412172 D01 Determining ERP and EIRP v01r01

Remark:

1. All test items were verified and recorded according to the standards and without any deviation during the test.
2. This EUT has also been tested and complied with the requirements of FCC Part 15, Subpart B, recorded in a separate test report.



2 Test Configuration of Equipment Under Test

2.1 Test Mode

Antenna port conducted and radiated test items were performed according to KDB 971168 D01 Power Meas. License Digital Systems v02r02 with maximum output power.

Radiated measurements were performed with rotating EUT in different three orthogonal test planes to find the maximum emission.

Radiated emissions were investigated as following frequency range:

1. 30 MHz to 10th harmonic for GSM850 and WCDMA Band V.
2. 30 MHz to 10th harmonic for GSM1900 and WCDMA Band II.

All modes and data rates and positions were investigated.

Test modes are chosen to be reported as the worst case configuration below:

Test Modes		
Band	Radiated TCs	Conducted TCs
GSM 850	■ GSM Link	■ GSM Link
GSM 1900	■ GSM Link	■ GSM Link
WCDMA Band V	■ RMC 12.2Kbps Link	■ RMC 12.2Kbps Link
WCDMA Band II	■ RMC 12.2Kbps Link	■ RMC 12.2Kbps Link

2.2 Connection Diagram of Test System

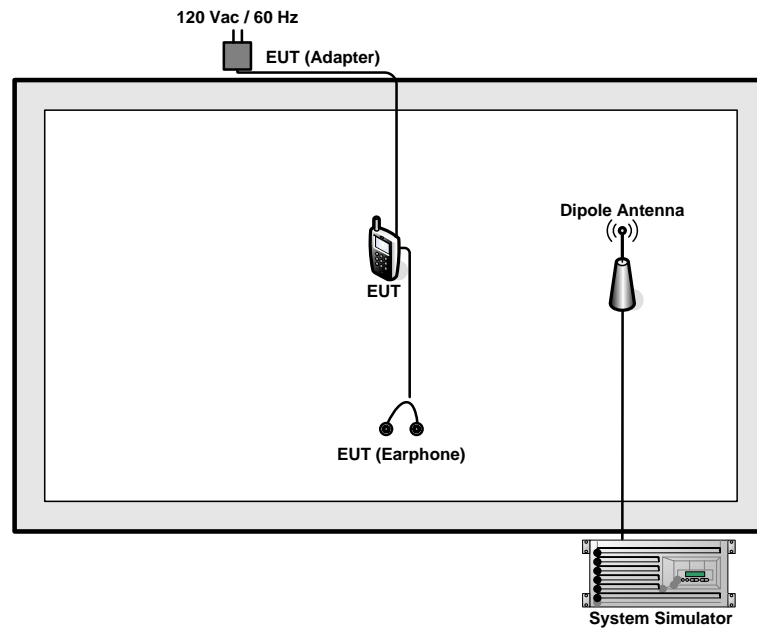

2.3 Support Unit used in test configuration

Item	Equipment	Trade Name	Model No.	FCC ID	Data Cable	Power Cord
1.	System Simulator	R&S	CMU 200	N/A	N/A	Unshielded, 1.8 m
2.	DC Power Supply	GWINSTEK	GPS-3030D	N/A	N/A	Unshielded, 1.8 m

2.4 Measurement Results Explanation Example

For all conducted test items:

The offset level is set in the spectrum analyzer to compensate the RF cable loss and attenuator factor between RF conducted output port and spectrum analyzer. With the offset compensation, the spectrum analyzer reading level will be exactly the RF output level.

The spectrum analyzer offset is derived from RF cable loss and attenuator factor.

$$\text{Offset} = \text{RF cable loss} + \text{attenuator factor}.$$

The following shows an offset computation example with RF cable loss 4.0 dB and a 10dB attenuator.

Example :

$$\begin{aligned} \text{Offset(dB)} &= \text{RF cable loss(dB)} + \text{attenuator factor(dB)}. \\ &= 4.0 + 10 = 14.0 \text{ (dB)} \end{aligned}$$

3 Conducted Test Result

3.1 Measuring Instruments

See list of measuring instruments of this test report.

3.2 Test Setup

3.2.1 Conducted Output Power

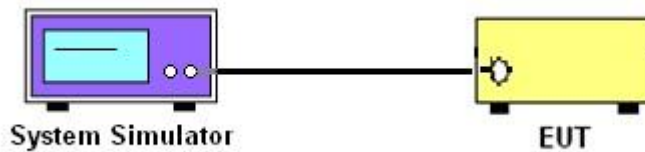

3.2.2 Peak-to-Average Ratio, Occupied Bandwidth, Conducted Band-Edge and Conducted Spurious Emission

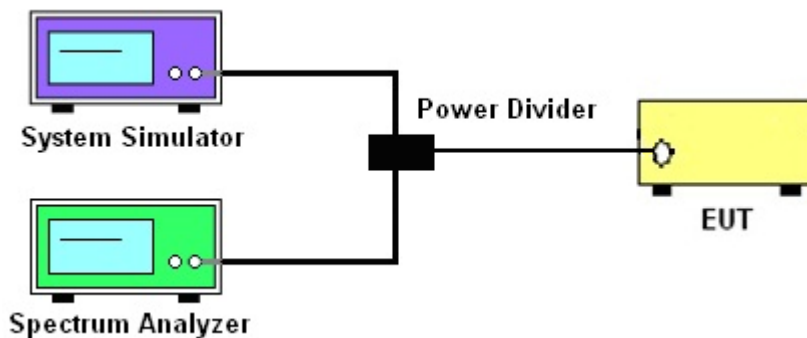

3.2.3 Frequency Stability

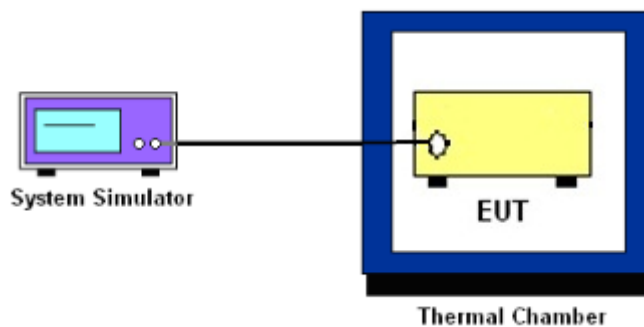

3.3 Test Result of Conducted Test

Please refer to Appendix A.



3.4 Conducted Output Power and ERP/EIRP

3.4.1 Description of the Conducted Output Power and ERP/EIRP

A system simulator was used to establish communication with the EUT. Its parameters were set to enforce EUT transmitting at the maximum power. The measured power in the radio frequency on the transmitter output terminals shall be reported.

The ERP of mobile transmitters must not exceed 7 Watts for band 850.

The EIRP of mobile transmitters must not exceed 2 Watts for band 1900.

According to KDB 412172 D01 Power Approach,

$EIRP = P_T + G_T - L_C$, $ERP = EIRP - 2.15$, where

P_T = transmitter output power in dBm

G_T = gain of the transmitting antenna in dBi

L_C = signal attenuation in the connecting cable between the transmitter and antenna in dB

3.4.2 Test Procedures

1. The transmitter output port was connected to the system simulator.
2. Set EUT at maximum power through system simulator.
3. Select lowest, middle, and highest channels for each band and different modulation.
4. Measure the maximum burst average power for GSM/WCDMA and maximum average power for other modulation signal.



3.5 Peak-to-Average Ratio

3.5.1 Description of the PAR Measurement

The peak-to-average ratio (PAR) of the transmission may not exceed 13 dB.

3.5.2 Test Procedures

1. The testing follows FCC KDB 971168 D01 v02r02 Section 5.7.1.
2. The EUT was connected to spectrum analyzer and system simulator via a power divider.
3. Set EUT to transmit at maximum output power.
4. When the duty cycle is less than 98%, then signal gating will be implemented on the spectrum analyzer by triggering from the system simulator.
5. Set the CCDF (Complementary Cumulative Distribution Function) option of the spectrum analyzer.
Record the maximum PAPR level associated with a probability of 0.1%.



3.6 99% Occupied Bandwidth and 26dB Bandwidth Measurement

3.6.1 Description of 99% Occupied Bandwidth and 26dB Bandwidth Measurement

The occupied bandwidth is the width of a frequency band such that, below the lower and above the upper frequency limits, the mean powers emitted are each equal to a specified percentage 0.5% of the total mean transmitted power.

The 26 dB emission bandwidth is defined as the frequency range between two points, one above and one below the carrier frequency, at which the spectral density of the emission is attenuated 26 dB below the maximum in-band spectral density of the modulated signal. Spectral density (power per unit bandwidth) is to be measured with a detector of resolution bandwidth equal to approximately 1.0% of the emission bandwidth.

3.6.2 Test Procedures

1. The testing follows FCC KDB 971168 v02r02 Section 4.2.
2. The EUT was connected to spectrum analyzer and system simulator via a power divider.
3. The spectrum analyzer center frequency is set to the nominal EUT channel center frequency. The span range for the spectrum analyzer shall be between two and five times the anticipated OBW.
4. The nominal resolution bandwidth (RBW) shall be in the range of 1 to 5 % of the anticipated OBW, and the VBW shall be at least 3 times the RBW.
5. Set the detection mode to peak, and the trace mode to max hold.
6. Determine the reference value: Set the EUT to transmit a modulated signal. Allow the trace to stabilize. Set the spectrum analyzer marker to the highest level of the displayed trace.
(this is the reference value)
7. Determine the “-26 dB down amplitude” as equal to (Reference Value – X).
8. Place two markers, one at the lowest and the other at the highest frequency of the envelope of the spectral display such that each marker is at or slightly below the “-X dB down amplitude” determined in step 6. If a marker is below this “-X dB down amplitude” value it shall be placed as close as possible to this value. The OBW is the positive frequency difference between the two markers.
9. Use the 99 % power bandwidth function of the spectrum analyzer and report the measured bandwidth.



3.7 Conducted Band Edge

3.7.1 Description of Conducted Band Edge Measurement

The power of any emission outside of the authorized operating frequency ranges must be lower than the transmitter power (P) by a factor of at least $43 + 10 \log (P)$ dB.

3.7.2 Test Procedures

1. The testing follows FCC KDB 971168 D01 v02r02 Section 6.0.
2. The EUT was connected to the spectrum analyzer and system simulator via a power divider.
3. The RF output of EUT was connected to the spectrum analyzer by an RF cable and attenuator. The path loss was compensated to the results for each measurement.
4. The band edges of low and high channels for the highest RF powers were measured.
5. The RF fundamental frequency should be excluded against the limit line in the operating frequency band.
6. The limit line is derived from $43 + 10\log(P)$ dB below the transmitter power P(Watts)
 $= P(W) - [43 + 10\log(P)]$ (dB)
 $= [30 + 10\log(P)]$ (dBm) - $[43 + 10\log(P)]$ (dB)
 $= -13\text{dBm}$.



3.8 Conducted Spurious Emission

3.8.1 Description of Conducted Spurious Emission Measurement

The power of any emission outside of the authorized operating frequency ranges must be lower than the transmitter power (P) by a factor of at least $43 + 10 \log (P)$ dB.

It is measured by means of a calibrated spectrum analyzer and scanned from 30 MHz up to a frequency including its 10th harmonic.

3.8.2 Test Procedures

1. The testing follows FCC KDB 971168 D01 v02r02 Section 6.0.
2. The EUT was connected to the spectrum analyzer and system simulator via a power divider.
3. The RF output of EUT was connected to the spectrum analyzer by an RF cable and attenuator. The path loss was compensated to the results for each measurement.
4. The middle channel for the highest RF power within the transmitting frequency was measured.
5. The conducted spurious emission for the whole frequency range was taken.
6. The RF fundamental frequency should be excluded against the limit line in the operating frequency band.
7. The limit line is derived from $43 + 10\log(P)$ dB below the transmitter power P(Watts)
= $P(W) - [43 + 10\log(P)]$ (dB)
= $[30 + 10\log(P)]$ (dBm) - $[43 + 10\log(P)]$ (dB)
= -13dBm.



3.9 Frequency Stability

3.9.1 Description of Frequency Stability Measurement

The frequency stability shall be measured by variation of ambient temperature and variation of primary supply voltage to ensure that the fundamental emission stays within the authorized frequency block. The frequency stability of the transmitter shall be maintained within $\pm 0.00025\%$ ($\pm 2.5\text{ppm}$) of the center frequency.

3.9.2 Test Procedures for Temperature Variation

1. The testing follows FCC KDB 971168 D01 v02r02 Section 9.0.
2. The EUT was set up in the thermal chamber and connected with the system simulator.
3. With power OFF, the temperature was decreased to -30°C and the EUT was stabilized before testing. Power was applied and the maximum change in frequency was recorded within one minute.
4. With power OFF, the temperature was raised in 10°C steps up to 50°C . The EUT was stabilized at each step for at least half an hour. Power was applied and the maximum frequency change was recorded within one minute.

3.9.3 Test Procedures for Voltage Variation

1. The testing follows FCC KDB 971168 D01 v02r02 Section 9.0.
2. The EUT was placed in a temperature chamber at $20\pm 5^{\circ}\text{C}$ and connected with the system simulator.
3. The power supply voltage to the EUT was varied from 85% to 115% of the nominal value measured at the input to the EUT.
4. The variation in frequency was measured for the worst case.

4 Radiated Test Items

4.1 Measuring Instruments

See list of measuring instruments of this test report.

4.2 Test Setup

4.2.1 For radiated test from 30MHz to 1GHz

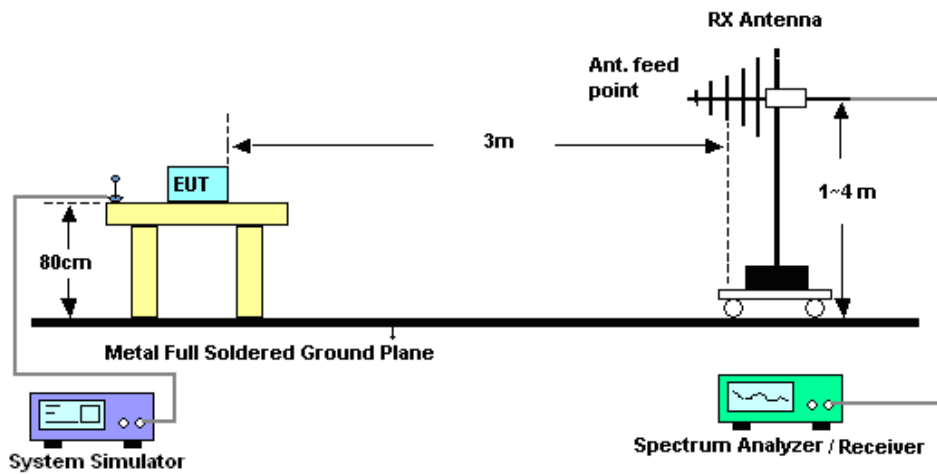

4.2.2 For radiated test above 1GHz

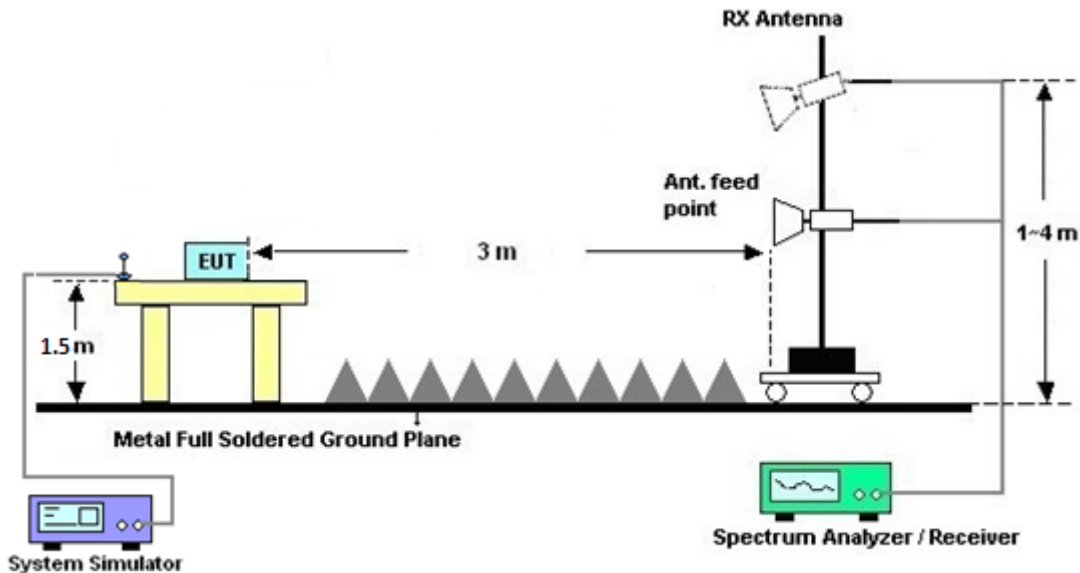

4.3 Test Result of Radiated Test

Please refer to Appendix B.



4.4 Field Strength of Spurious Radiation Measurement

4.4.1 Description of Field Strength of Spurious Radiated Measurement

The power of any emission outside of the authorized operating frequency ranges must be attenuated below the transmitter power (P) by a factor of at least $43 + 10 \log (P)$ dB. The spectrum is scanned from 30 MHz up to a frequency including its 10th harmonic.

4.4.2 Test Procedures

1. The testing follows FCC KDB 971168 D01 v02r02 Section 5.8 and ANSI / TIA-603-D-2010 Section 2.2.12.
2. The EUT was placed on a rotatable wooden table 0.8 meters for frequency below 1GHz and 1.5 meter for frequency above 1GHz above the ground.
3. The EUT was set 3 meters from the receiving antenna, which was mounted on the antenna tower.
4. The table was rotated 360 degrees to determine the position of the highest spurious emission.
5. The height of the receiving antenna is varied between one meter and four meters to search for the maximum spurious emission for both horizontal and vertical polarizations.
6. Make the measurement with the spectrum analyzer's RBW = 1MHz, VBW = 3MHz, taking record of maximum spurious emission.
7. A horn antenna was substituted in place of the EUT and was driven by a signal generator.
8. Tune the output power of signal generator to the same emission level with EUT maximum spurious emission.
9. Taking the record of output power at antenna port.
10. Repeat step 7 to step 8 for another polarization.
11. $EIRP \text{ (dBm)} = S.G. \text{ Power} - Tx \text{ Cable Loss} + Tx \text{ Antenna Gain}$
12. $ERP \text{ (dBm)} = EIRP - 2.15$
13. The RF fundamental frequency should be excluded against the limit line in the operating frequency band.
14. The limit line is derived from $43 + 10\log(P)$ dB below the transmitter power P(Watts)
 $= P(W) - [43 + 10\log(P)] \text{ (dB)}$
 $= [30 + 10\log(P)] \text{ (dBm)} - [43 + 10\log(P)] \text{ (dB)}$
 $= -13\text{dBm}.$



5 List of Measuring Equipment

Instrument	Manufacturer	Model No.	Serial No.	Characteristics	Calibration Date	Test Date	Due Date	Remark
Spectrum Analyzer	R&S	FSV40	101078	9kHz~40GHz	Apr. 20, 2017	Oct. 20, 2017	Apr.19, 2018	Conducted (TH01-SZ)
Thermal Chamber	Ten Billion Hongzhangroup	LP-150U	H2014081803	-40~+150°C	Jul. 20, 2017	Oct. 20, 2017	Jul. 19, 2018	Conducted (TH01-SZ)
Radio communication analyzer	Anritsu	MT8820C	6201300652	2G/3G/LTE_ full band	Aug. 08, 2017	Oct. 20, 2017	Aug. 07, 2018	Conducted (TH01-KS)
EMI Test Receiver&SA	Agilent	N9038A	MY52260185	20Hz~26.5GHz	Apr. 20, 2017	Oct. 23, 2017	Apr. 19, 2018	Radiation (03CH01-SZ)
Bilog Antenna	TeseQ	CBL6112D	23188	30MHz-2GHz	Apr. 25, 2017	Oct. 23, 2017	Apr. 24, 2018	Radiation (03CH01-SZ)
Double Ridge Horn Antenna	ETS Lindgren	3117	00119436	1GHz~18GHz	Nov. 19, 2016	Oct. 23, 2017	Nov. 18, 2017	Radiation (03CH01-SZ)
SHF-EHF Horn	com-power	AH-840	101071	18Ghz-40GHz	Jun.16, 2017	Oct. 23, 2017	Jun.15, 2018	Radiation (03CH01-SZ)
LF Amplifier	Burgeon	BPA-530	102209	0.01~3000Mhz	Apr. 20, 2017	Oct. 23, 2017	Apr.19, 2018	Radiation (03CH01-SZ)
HF Amplifier	MITEQ	AMF-7D-00101800-30-10 P-R	1707137	1GHz~18GHz	Oct.19, 2017	Oct. 23, 2017	Oct 18, 2018	Radiation (03CH01-SZ)
HF Amplifier	KEYSIGHT	83017A	MY53270104	0.5GHz~26.5GHz	Oct.19, 2017	Oct. 23, 2017	Oct 18, 2018	Radiation (03CH01-SZ)
AC Power Source	Chroma	61601	616010001985	N/A	NCR	Oct. 23, 2017	N/A	Radiation (03CH01-SZ)
Turn Table	EM	EM1000	N/A	0~360 degree	NCR	Oct. 23, 2017	NCR	Radiation (03CH01-SZ)
Antenna Mast	EM	EM1000	N/A	1 m~4 m	NCR	Oct. 23, 2017	NCR	Radiation (03CH01-SZ)

NCR: No Calibration Required



6 Uncertainty of Evaluation

Uncertainty of Radiated Emission Measurement (30 MHz ~ 1000 MHz)

Measuring Uncertainty for a Level of Confidence of 95% ($U = 2Uc(y)$)	2.5 dB
---	--------

Uncertainty of Radiated Emission Measurement (1 GHz ~ 18 GHz)

Measuring Uncertainty for a Level of Confidence of 95% ($U = 2Uc(y)$)	3.5 dB
---	--------

Uncertainty of Radiated Emission Measurement (18 GHz ~ 40 GHz)

Measuring Uncertainty for a Level of Confidence of 95% ($U = 2Uc(y)$)	4.0 dB
---	--------



Appendix A. Test Results of Conducted Test

Conducted Output Power(Average power)

Conducted Power (*Unit: dBm)						
Band	GSM850			GSM1900		
Channel	128	189	251	512	661	810
Frequency	824.2	836.4	848.8	1850.2	1880.0	1909.8
GSM	32.22	32.05	32.01	29.24	29.05	29.15
GPRS class 8	32.21	32.00	32.02	29.23	29.00	29.14
GPRS class 10	30.58	30.54	30.52	27.44	27.23	27.08
GPRS class 11	28.68	28.75	28.74	25.91	25.72	25.56
GPRS class 12	26.65	26.66	26.64	23.82	23.66	23.50

Conducted Power (*Unit: dBm)						
Band	WCDMA Band V			WCDMA Band II		
Channel	4132	4182	4233	9262	9400	9538
Frequency	826.4	836.4	846.6	1852.4	1880	1907.6
AMR 12.2Kbps	22.66	22.60	22.60	22.32	22.40	22.33
RMC 12.2Kbps	22.68	22.62	22.63	22.33	22.41	22.35
HSDPA Subtest-1	22.62	22.32	22.54	22.25	22.40	22.34
HSDPA Subtest-2	22.63	22.27	22.54	22.18	22.36	22.37
HSDPA Subtest-3	22.62	22.27	22.55	22.18	22.34	22.32
HSDPA Subtest-4	22.58	22.23	22.47	22.12	22.29	22.38
HSUPA Subtest-1	21.24	20.89	21.13	21.47	20.98	21.25
HSUPA Subtest-2	22.01	21.79	21.86	21.36	21.74	21.78
HSUPA Subtest-3	22.10	21.77	22.01	21.63	21.82	21.95
HSUPA Subtest-4	22.29	21.91	22.22	21.78	21.85	22.14
HSUPA Subtest-5	22.30	22.00	22.20	22.10	22.00	22.10



ERP/EIRP

GSM850 (G_T - LC= 0.60 dBi)			
Channel	128	189	251
	(Low)	(Mid)	(High)
Frequency	824.2	836.4	848.8
(MHz)			
Conducted Power (dBm)	32.22	32.05	32.01
Conducted Power (Watts)	1.6672	1.6032	1.5885
ERP(dBm)	30.67	30.50	30.46
ERP(Watts)	1.1668	1.1220	1.1117

GSM1900 (G_T - LC= 1.30 dBi)			
Channel	512	661	810
	(Low)	(Mid)	(High)
Frequency	1850.2	1880	1909.8
(MHz)			
Conducted Power (dBm)	29.24	29.05	29.15
Conducted Power (Watts)	0.8395	0.8035	0.8222
EIRP(dBm)	30.54	30.35	30.45
EIRP(Watts)	1.1324	1.0839	1.1092



WCDMA Band V ($G_T - L_C = 0.60$ dB)			
Channel	4132	4182	4233
	(Low)	(Mid)	(High)
Frequency	826.4	836.4	846.6
(MHz)			
Conducted Power (dBm)	22.68	22.62	22.63
Conducted Power (Watts)	0.1854	0.1828	0.1832
ERP(dBm)	21.13	21.07	21.08
ERP(Watts)	0.1297	0.1279	0.1282

WCDMA Band II ($G_T - L_C = 1.30$ dB)			
Channel	9262	9400	9538
	(Low)	(Mid)	(High)
Frequency	1852.4	1880	1907.6
(MHz)			
Conducted Power (dBm)	22.33	22.41	22.35
Conducted Power (Watts)	0.1710	0.1742	0.1718
EIRP(dBm)	23.63	23.71	23.65
EIRP(Watts)	0.2307	0.2350	0.2317



Peak-to-Average Ratio

Mode	GSM850(dB)	GSM1900(dB)	Limit: 13dB
Mod.	GSM	GSM	Result
Lowest CH	0.12	0.12	PASS
Middle CH	0.12	0.12	
Highest CH	0.20	0.12	

Mode	WCDMA Band V(dB)	WCDMA Band II(dB)	Limit: 13dB
Mod.	RMC 12.2Kbps	RMC 12.2Kbps	Result
Lowest CH	3.28	3.16	PASS
Middle CH	3.16	2.93	
Highest CH	3.19	2.38	

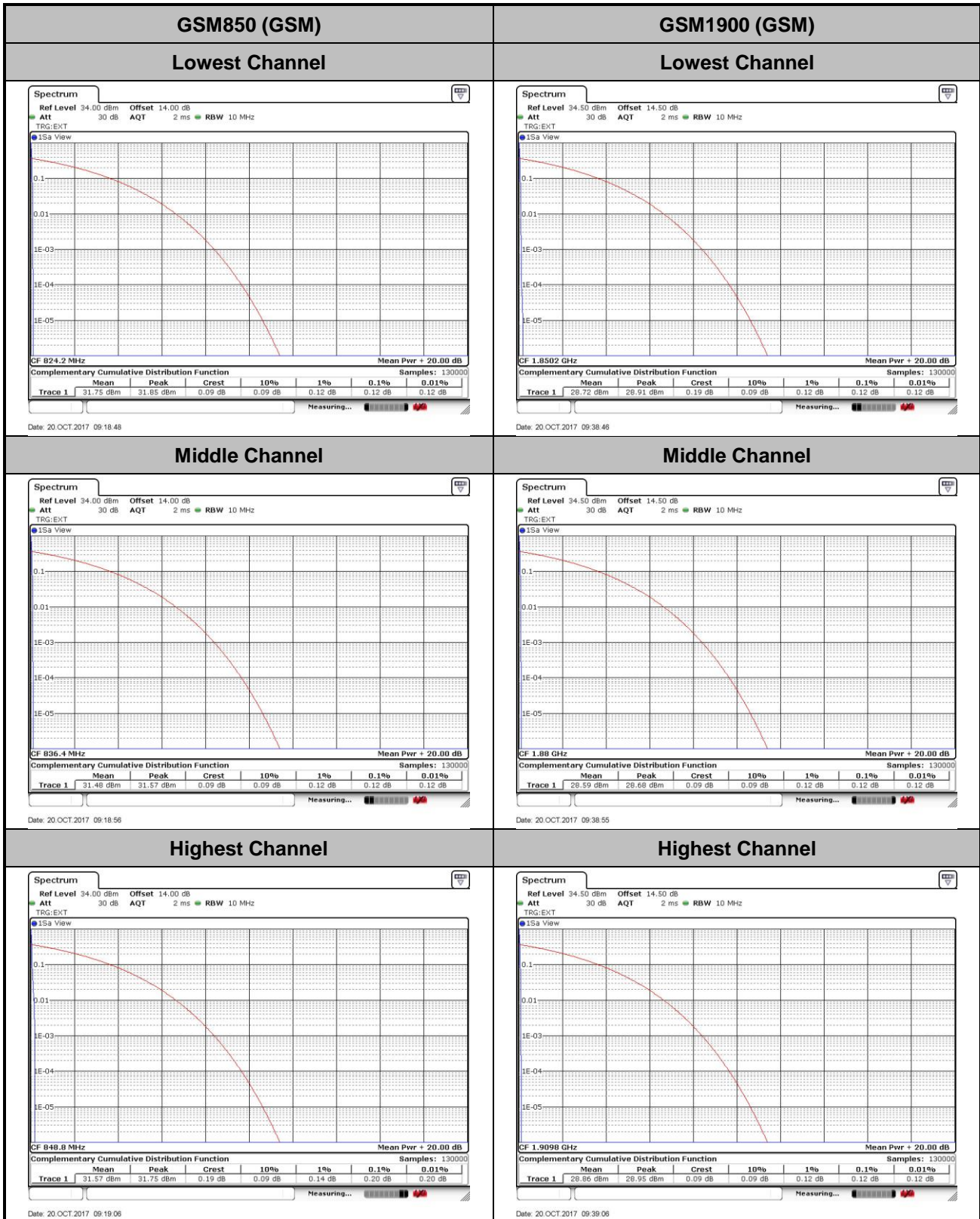

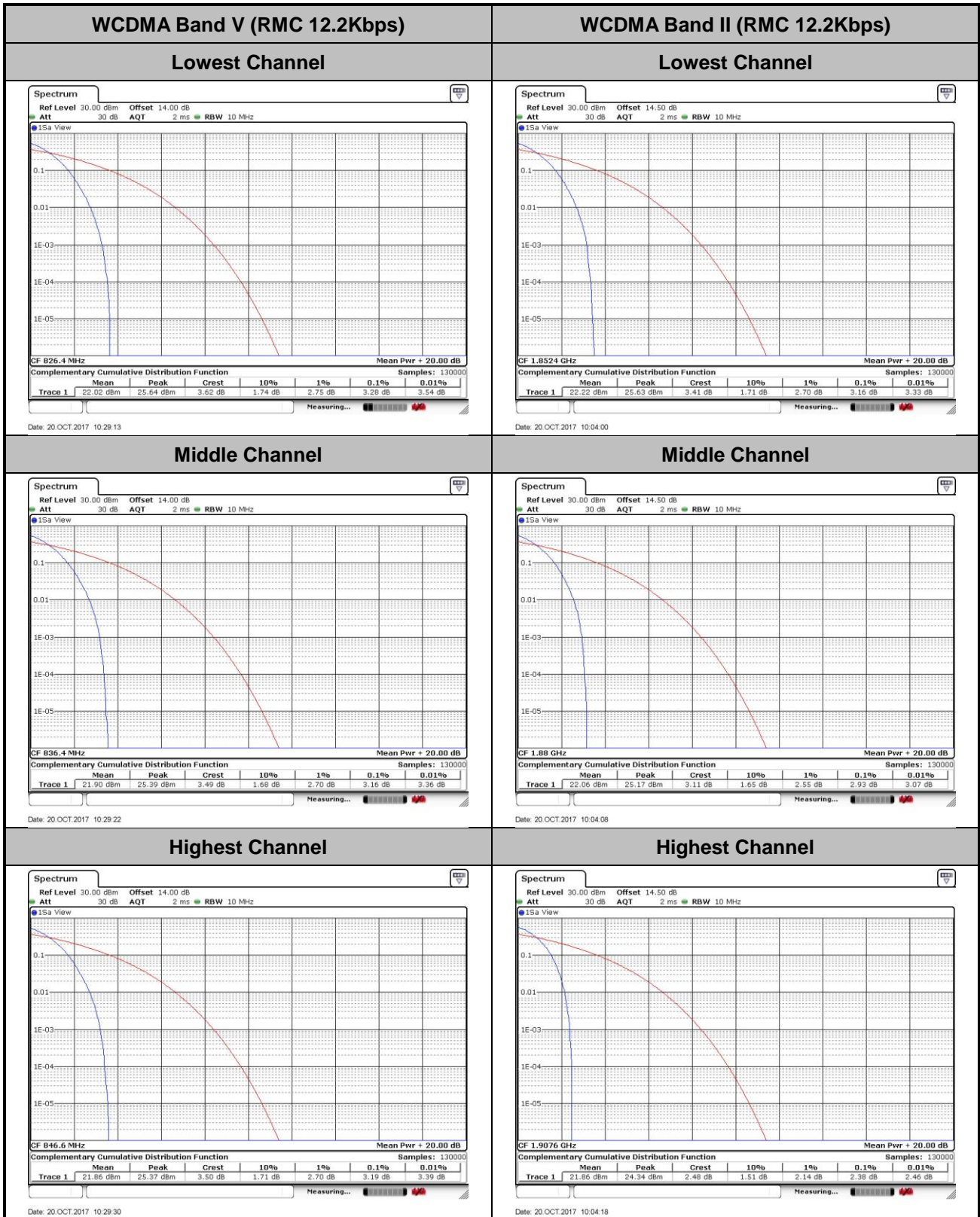



26dB Bandwidth

Mode	GSM850(MHz)	GSM1900(MHz)
Mod.	GSM	GSM
Lowest CH	0.315	0.312
Middle CH	0.315	0.315
Highest CH	0.316	0.315

Mode	WCDMA Band V(MHz)	WCDMA Band II(MHz)
Mod.	RMC 12.2Kbps	RMC 12.2Kbps
Lowest CH	4.67	4.66
Middle CH	4.67	4.66
Highest CH	4.66	4.69



GSM850 (GSM)

Lowest Channel

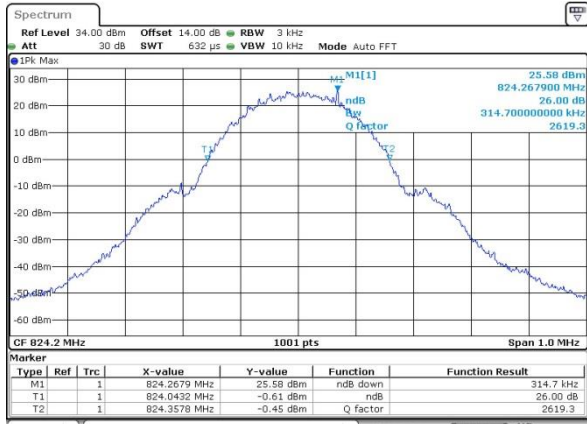

Date: 20.OCT.2017 09:40:59

GSM1900 (GSM)

Lowest Channel

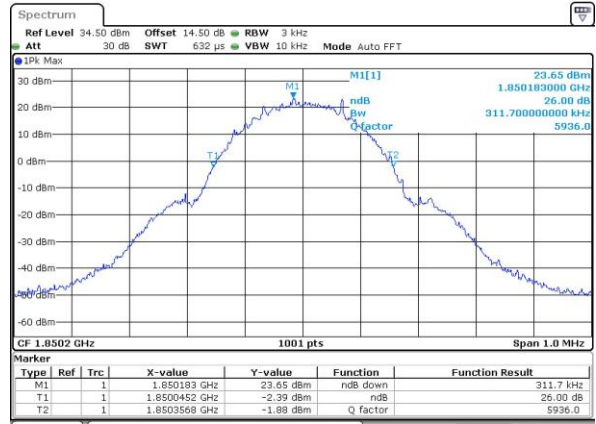

Date: 20.OCT.2017 09:27:45

Middle Channel

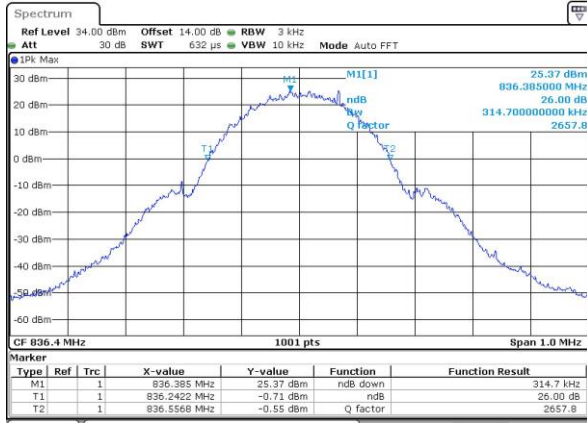

Date: 20.OCT.2017 09:41:27

Middle Channel

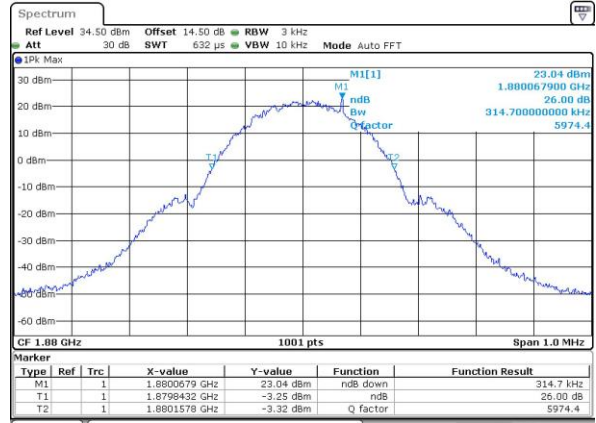

Date: 20.OCT.2017 09:28:13

Highest Channel

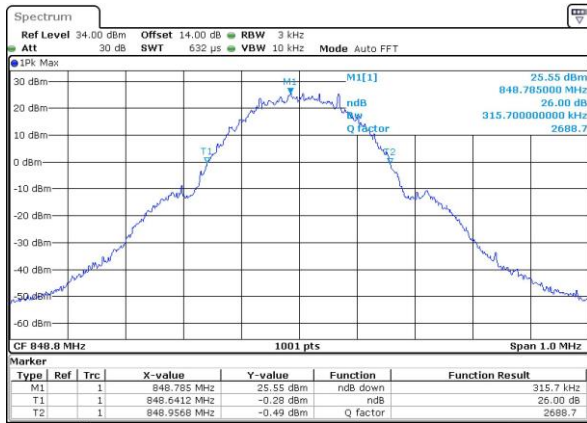

Date: 20.OCT.2017 09:41:55

Highest Channel

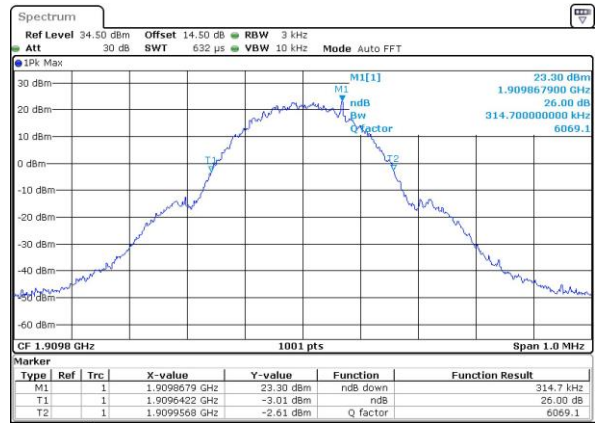

Date: 20.OCT.2017 09:28:41



WCDMA Band V (RMC 12.2Kbps)

Lowest Channel

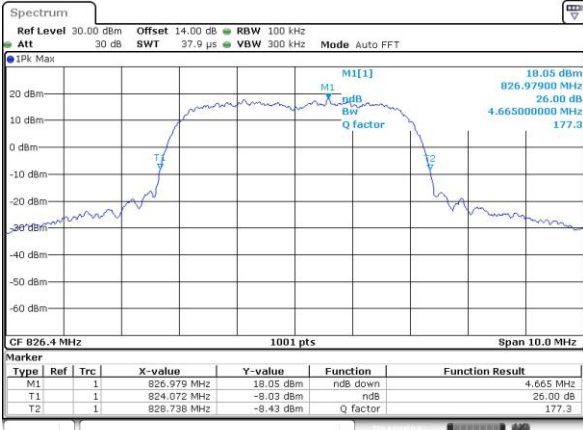

Date: 20 OCT.2017 10:05:38

WCDMA Band II (RMC 12.2Kbps)

Lowest Channel



Date: 20 OCT.2017 09:49:59

Middle Channel

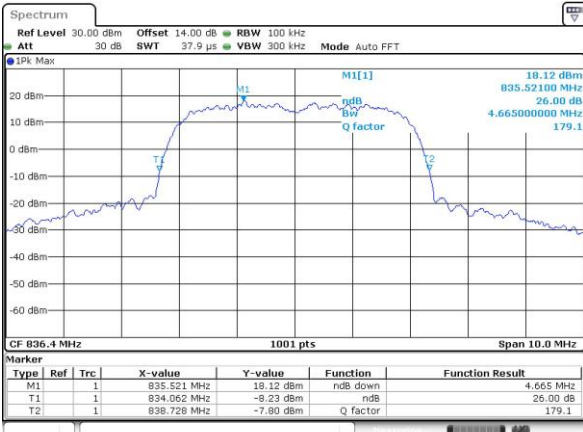

Date: 20 OCT.2017 10:06:06

Middle Channel

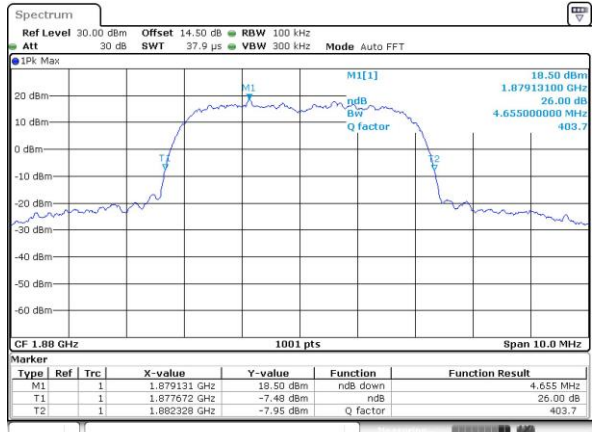

Date: 20 OCT.2017 09:50:27

Highest Channel

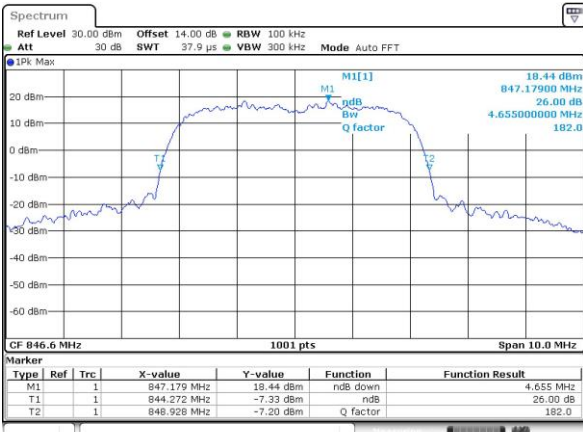

Date: 20 OCT.2017 10:06:34

Highest Channel

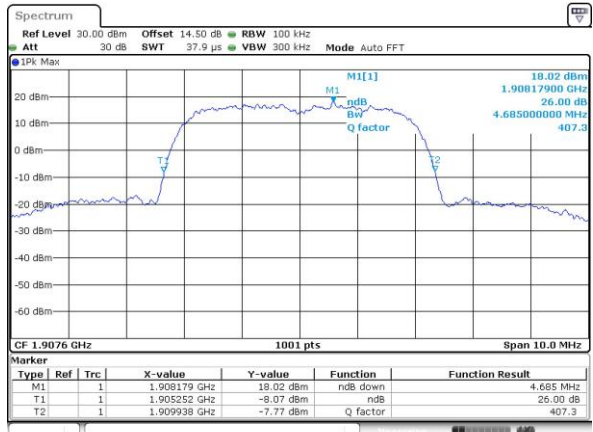

Date: 20 OCT.2017 09:50:55



Occupied Bandwidth

Mode	GSM850(MHz)	GSM1900(MHz)
Mod.	GSM	GSM
Lowest CH	0.244	0.244
Middle CH	0.244	0.243
Highest CH	0.243	0.244

Mode	WCDMA Band V(MHz)	WCDMA Band II(MHz)
Mod.	RMC 12.2Kbps	RMC 12.2Kbps
Lowest CH	4.10	4.11
Middle CH	4.10	4.10
Highest CH	4.11	4.10



GSM850 (GSM)

Lowest Channel

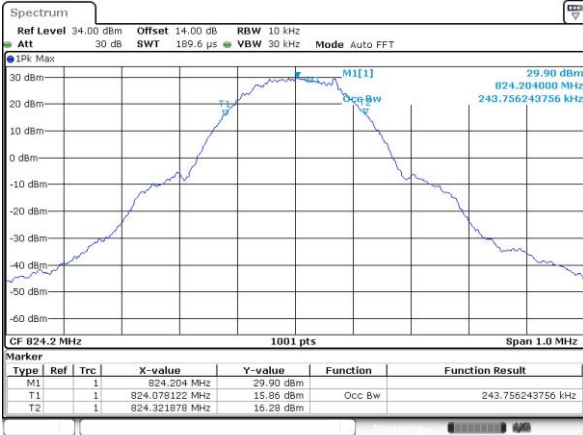

Date: 20.OCT.2017 09:08:03

GSM1900 (GSM)

Lowest Channel

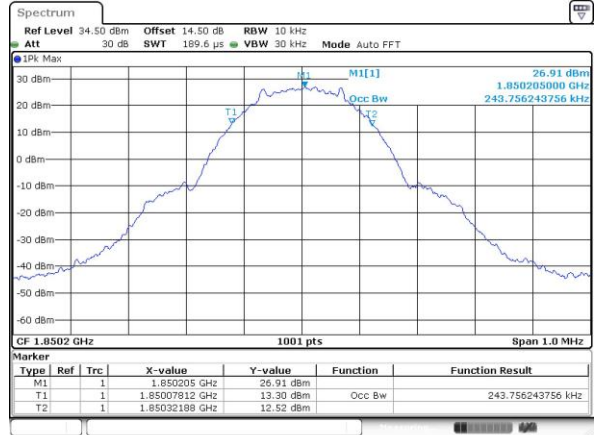

Date: 20.OCT.2017 09:29:14

Middle Channel

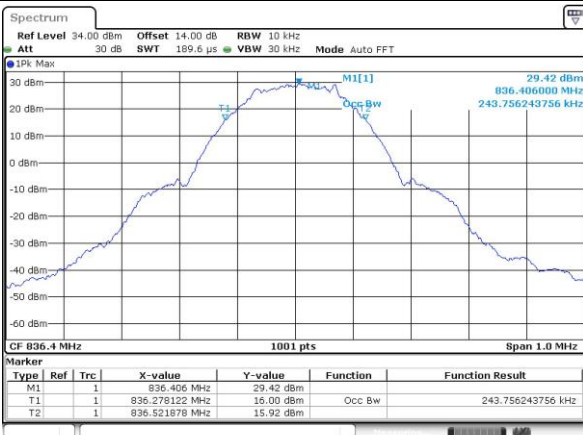

Date: 20.OCT.2017 09:08:31

Middle Channel

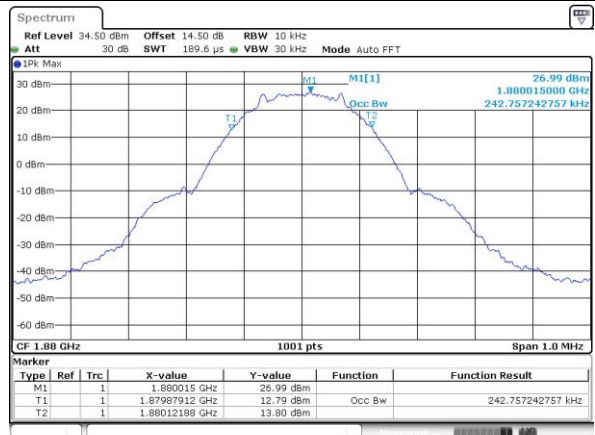

Date: 20.OCT.2017 09:29:42

Highest Channel

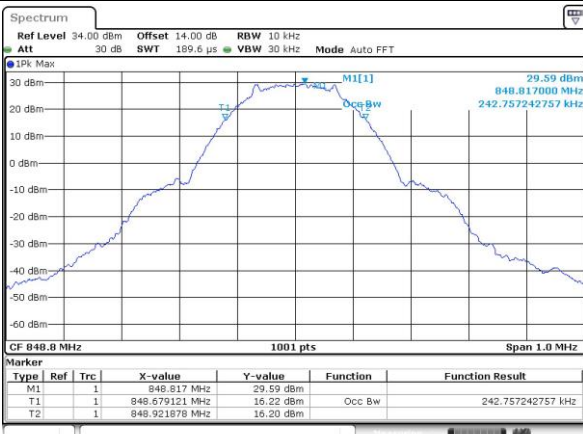

Date: 20.OCT.2017 09:08:59

Highest Channel

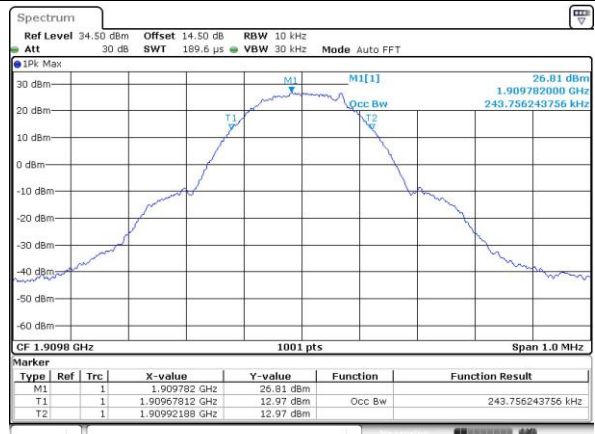

Date: 20.OCT.2017 09:30:10



WCDMA Band V (RMC 12.2Kbps)

Lowest Channel

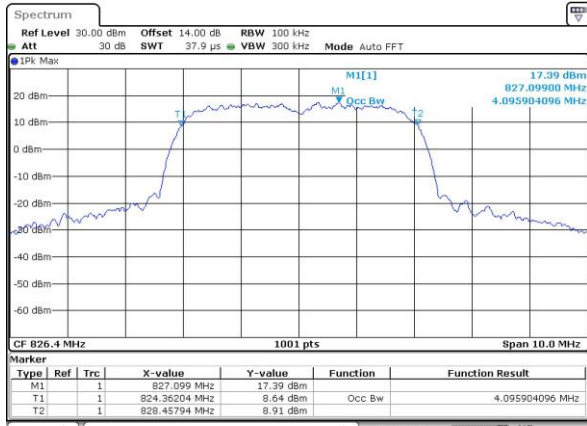

Date: 20.OCT.2017 10:07:07

WCDMA Band II (RMC 12.2Kbps)

Lowest Channel

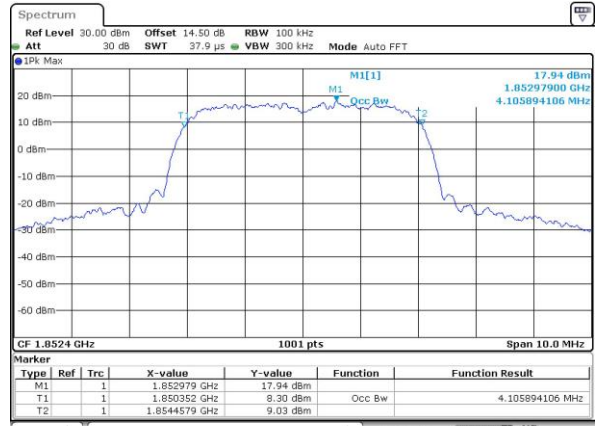

Date: 20.OCT.2017 09:51:40

Middle Channel

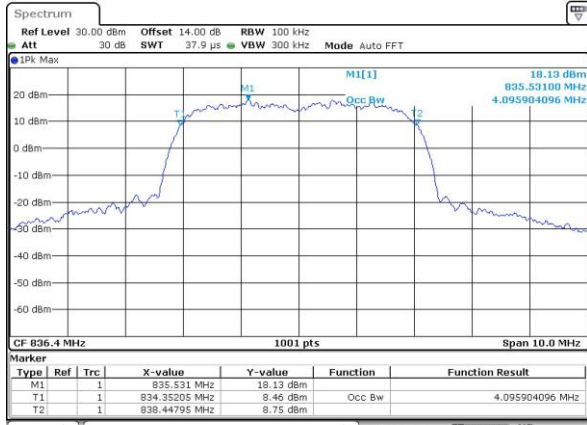

Date: 20.OCT.2017 10:07:35

Middle Channel

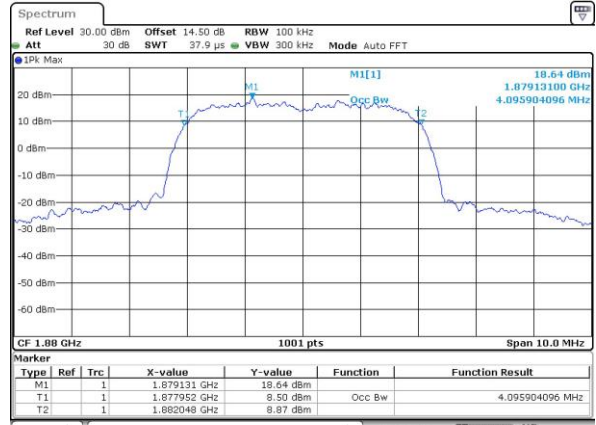

Date: 20.OCT.2017 09:52:08

Highest Channel

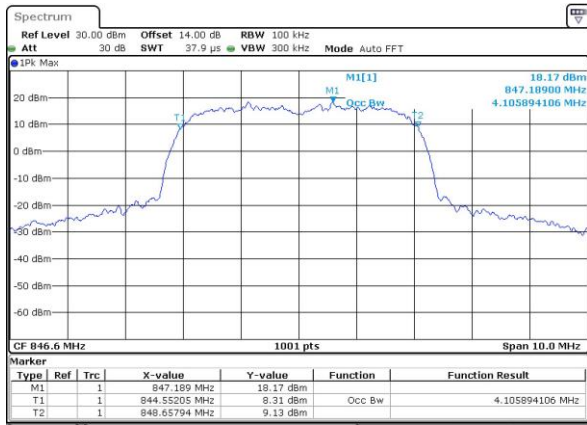

Date: 20.OCT.2017 10:08:03

Highest Channel

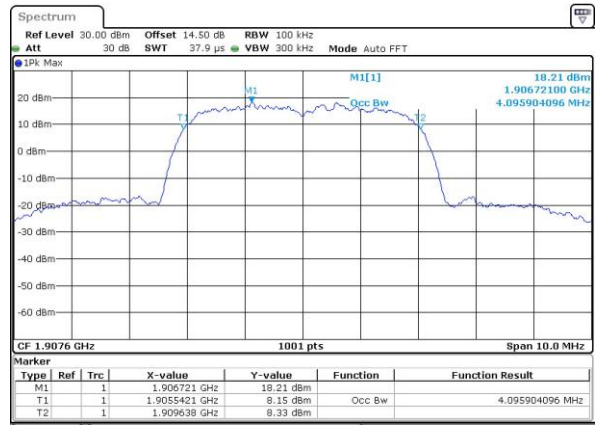

Date: 20.OCT.2017 09:52:36



Conducted Band Edge

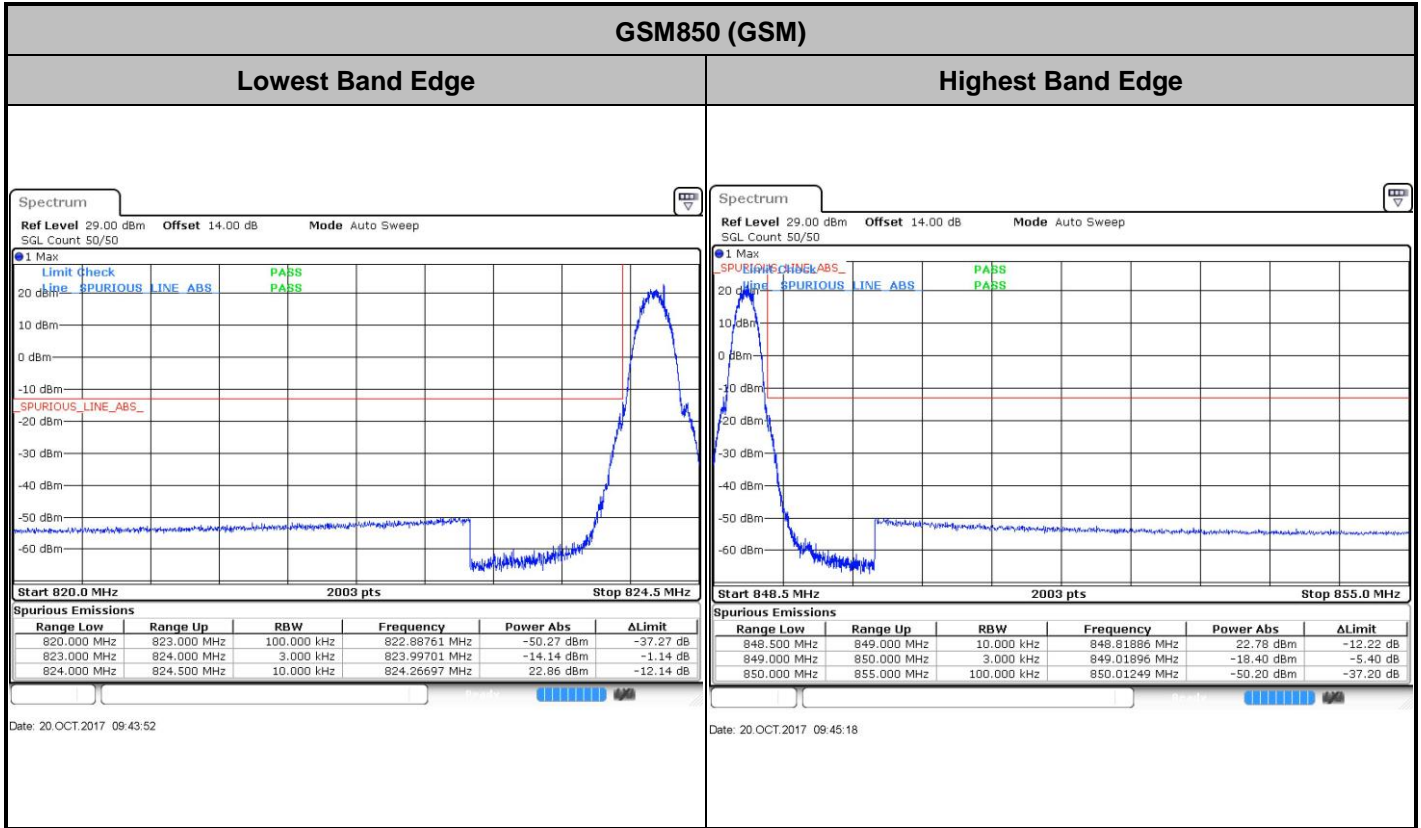

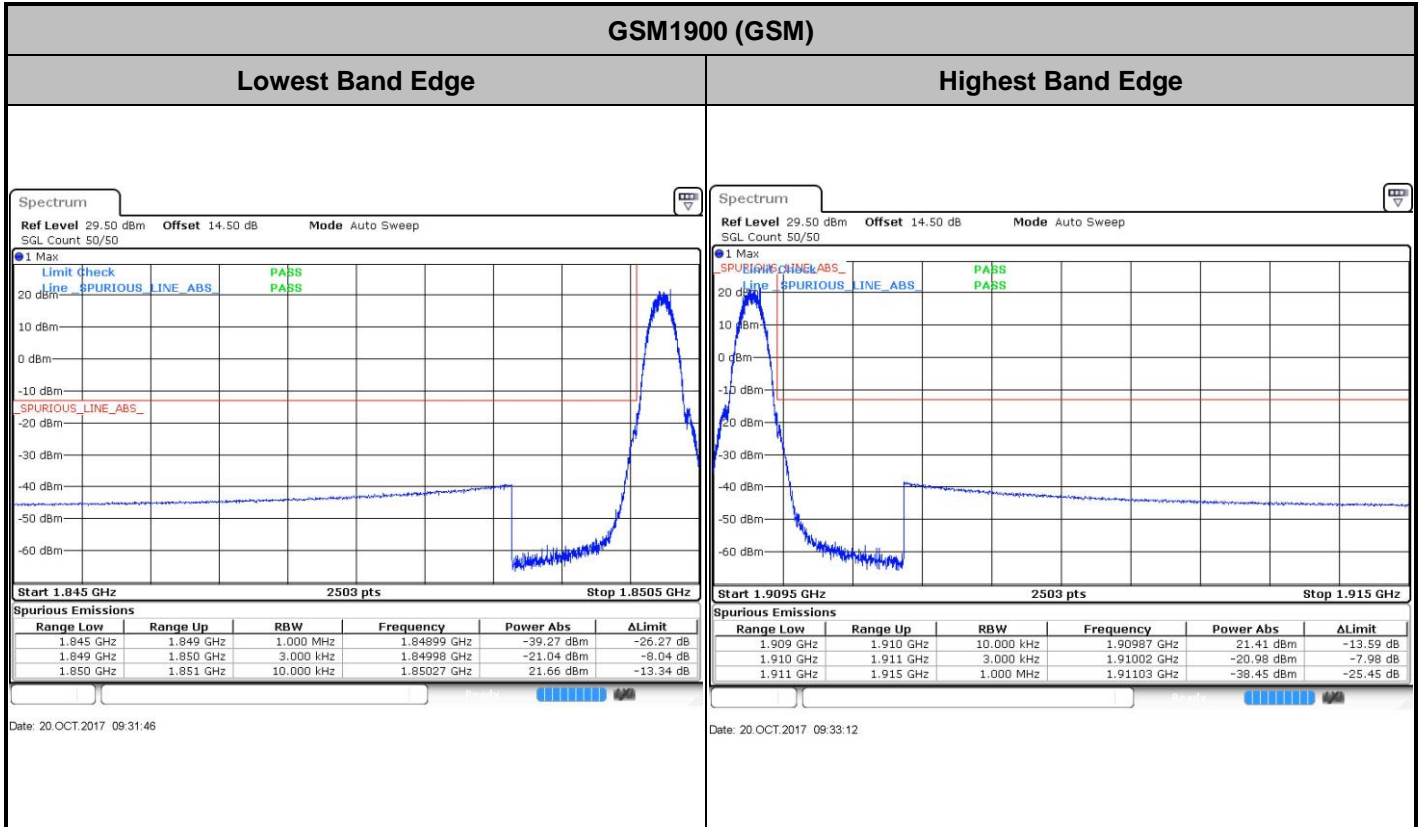

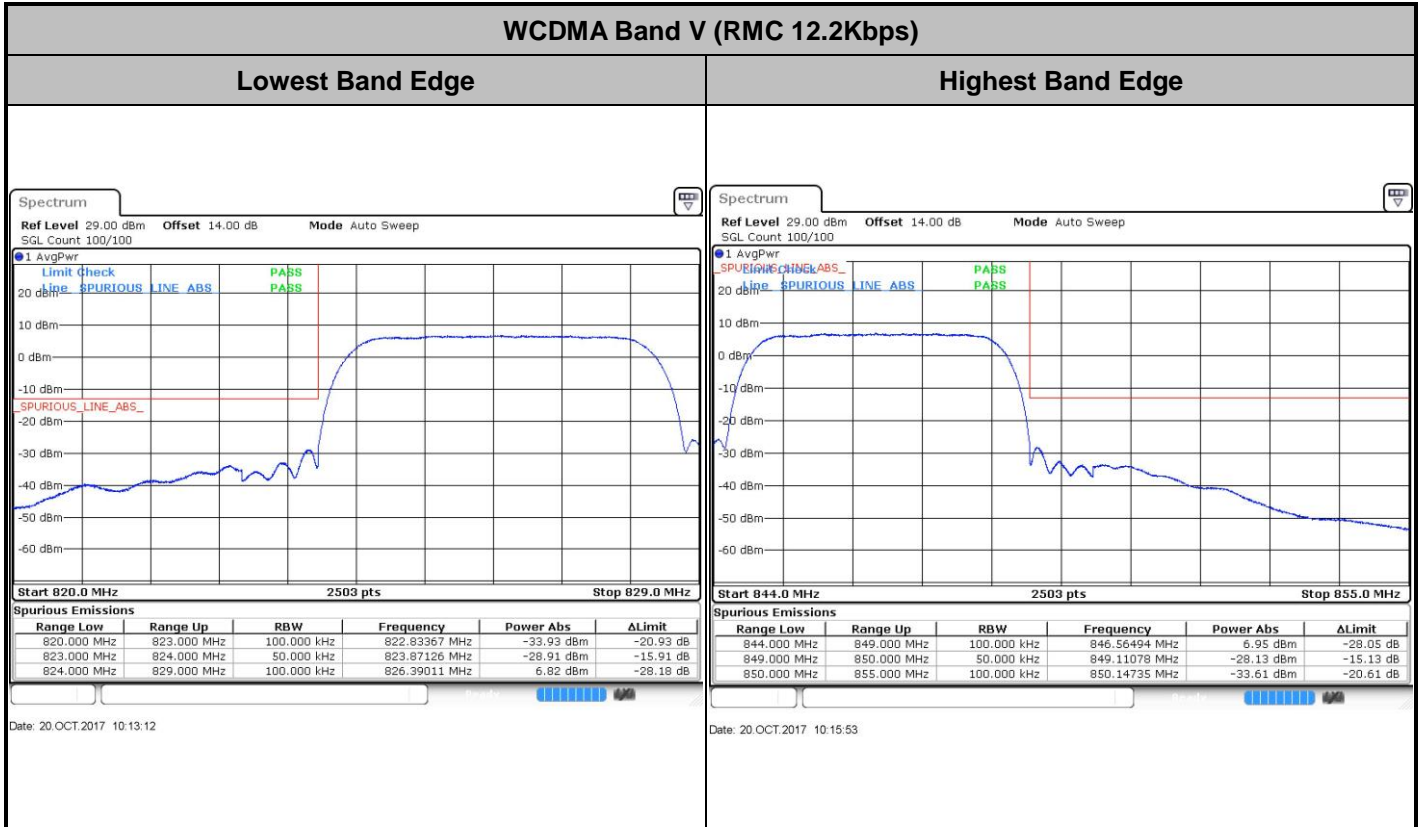

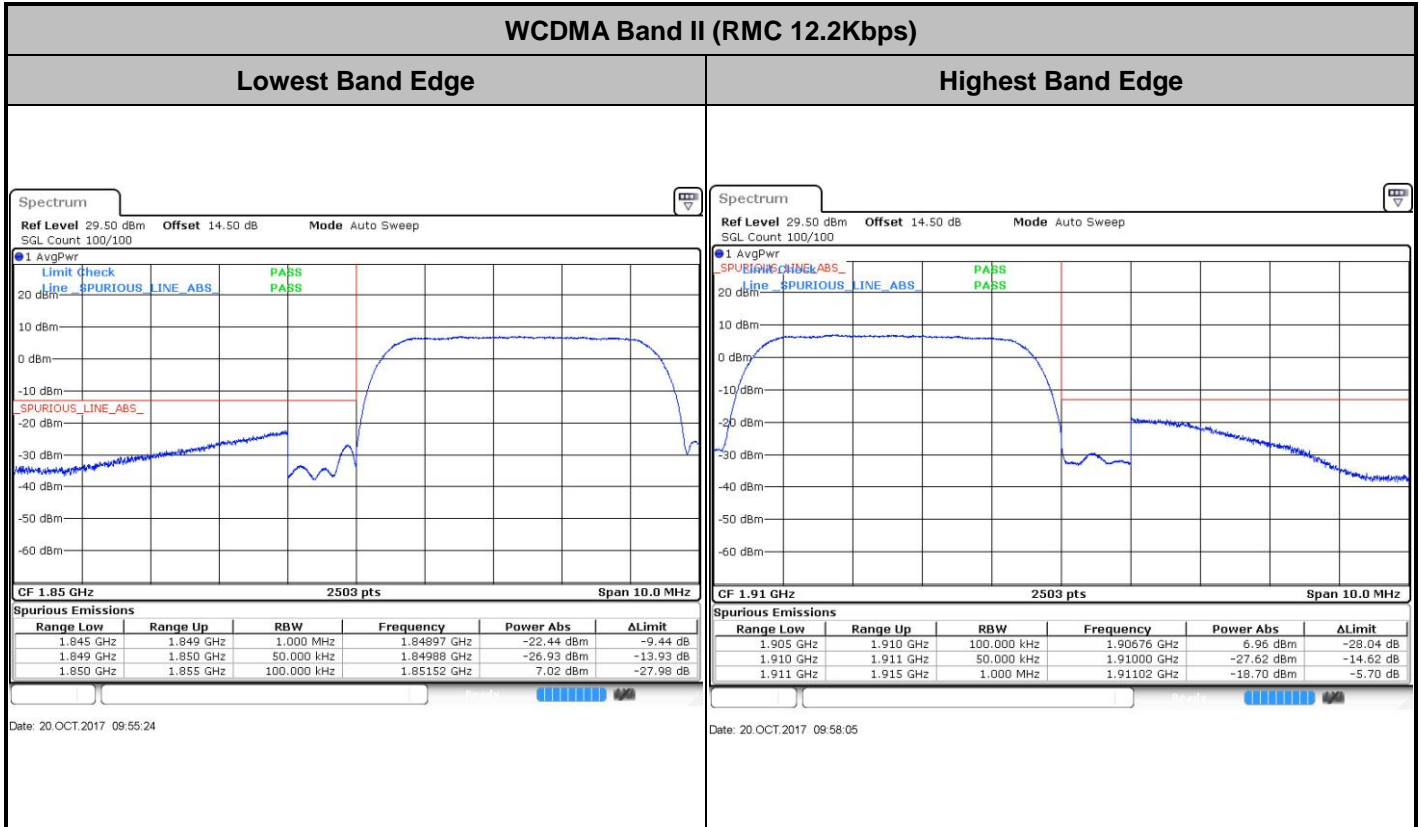



Conducted Spurious Emission

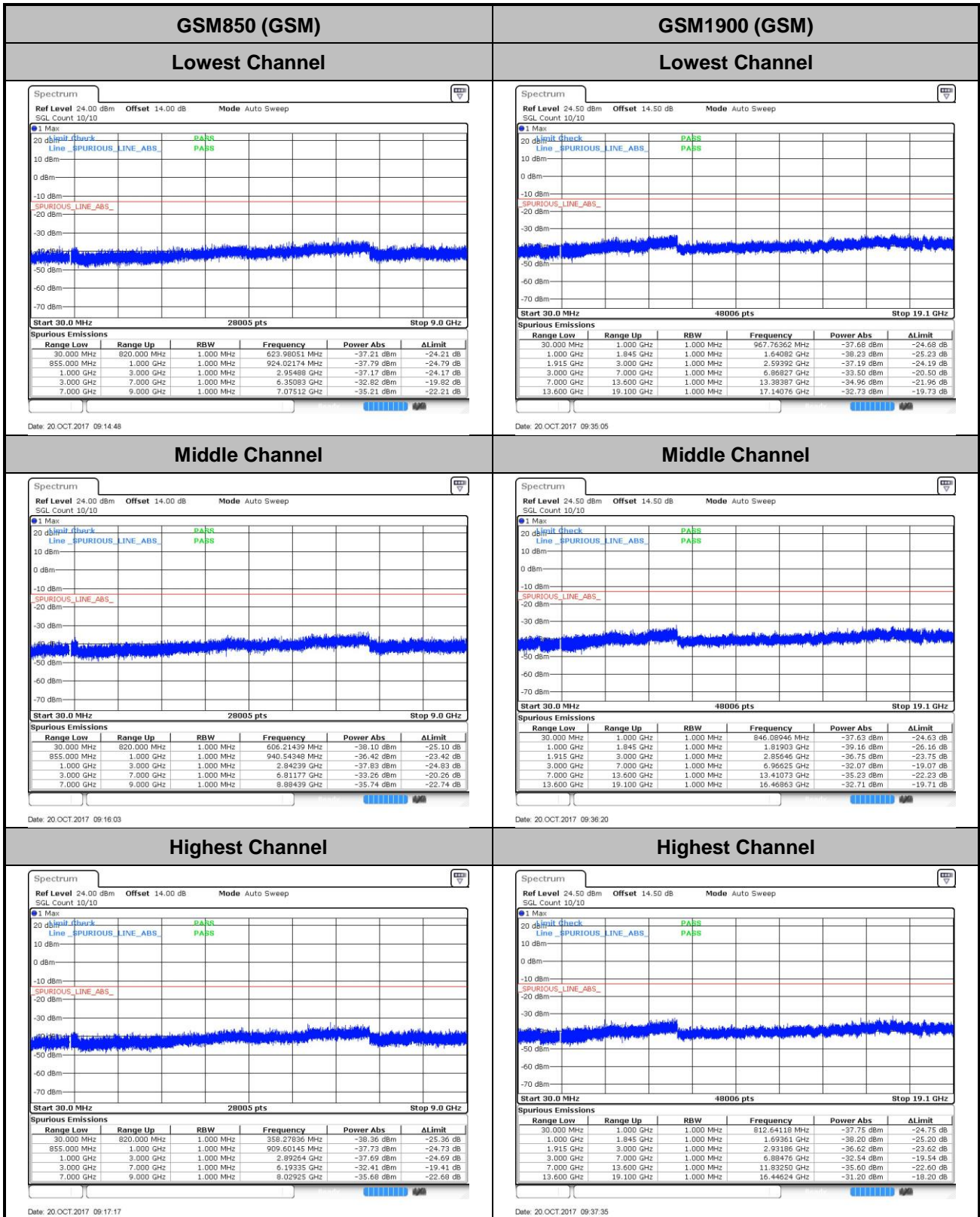



WCDMA Band V (RMC 12.2Kbps)

Lowest Channel

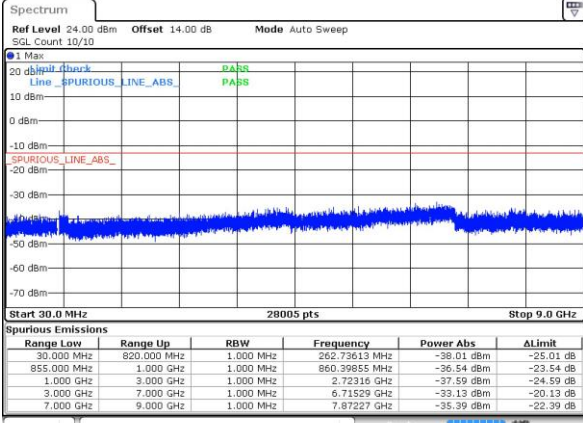

Date: 20.OCT.2017 10:17:57

WCDMA Band II (RMC 12.2Kbps)

Lowest Channel

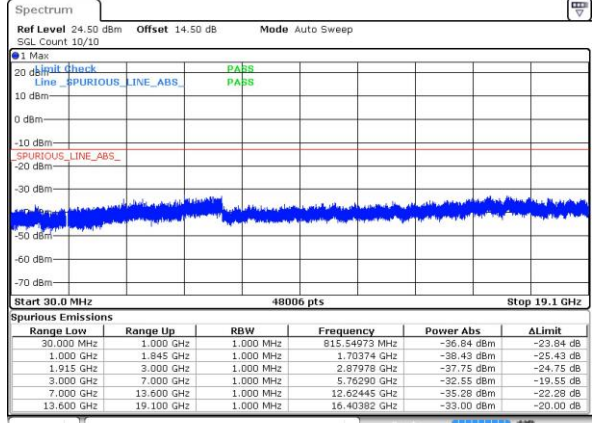

Date: 20.OCT.2017 10:00:22

Middle Channel

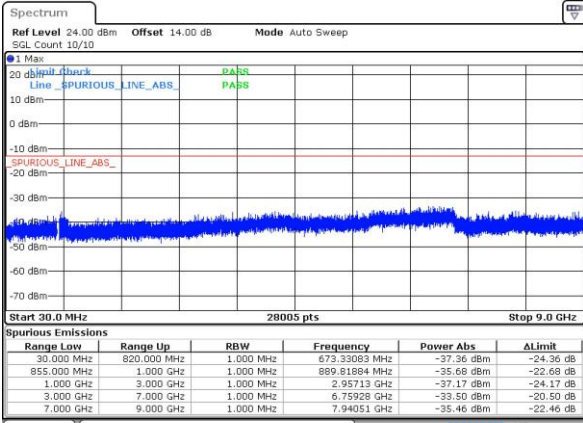

Date: 20.OCT.2017 10:19:12

Middle Channel

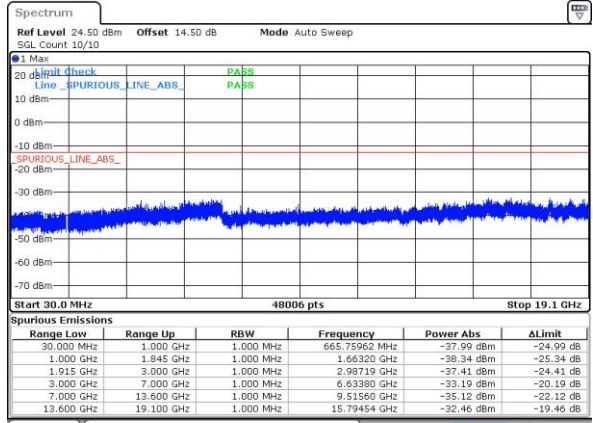

Date: 20.OCT.2017 10:01:37

Highest Channel

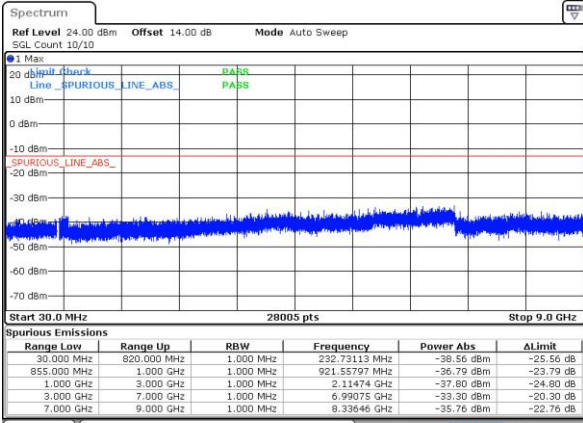

Date: 20.OCT.2017 10:20:26

Highest Channel

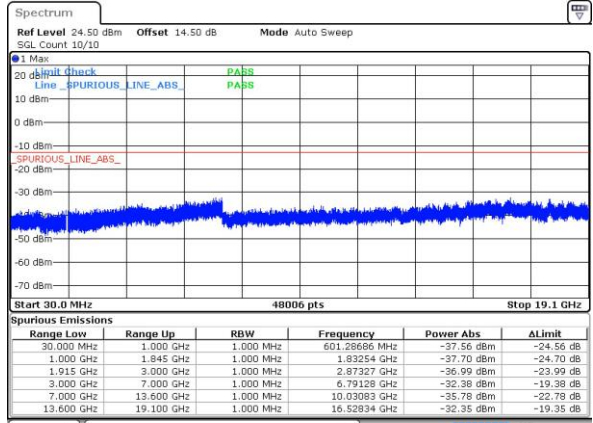

Date: 20.OCT.2017 10:02:52



Frequency Stability

Test Conditions	Middle Channel	GSM850 (GSM)	GSM1900 (GSM)	Limit 2.5ppm
Temperature (°C)	Voltage (Volt)	Deviation (ppm)		Result
50	Normal Voltage	0.0335	0.0064	PASS
40	Normal Voltage	0.0060	0.0096	
30	Normal Voltage	0.0179	0.0032	
20(Ref.)	Normal Voltage	0.0000	0.0000	
10	Normal Voltage	0.0191	0.0207	
0	Normal Voltage	0.0024	0.0160	
-10	Normal Voltage	0.0215	0.0186	
-20	Normal Voltage	0.0359	0.0213	
-30	Normal Voltage	0.0407	0.0229	
20	Maximum Voltage	0.0191	0.0090	
20	Normal Voltage	0.0000	0.0000	
20	Battery End Point	0.0120	0.0043	

Note:

1. Normal Voltage = 3.8V. ; Battery End Point (BEP) = 3.5 V. ; Maximum Voltage =4.2 V
2. The frequency fundamental emissions stay within the authorized frequency block based on the frequency deviation measured is small.



Test Conditions	Middle Channel	WCDMA Band V (RMC 12.2Kbps)	WCDMA Band II (RMC 12.2Kbps)	Limit 2.5ppm
Temperature (°C)	Voltage (Volt)	Deviation (ppm)		Result
50	Normal Voltage	0.0084	0.0037	PASS
40	Normal Voltage	0.0060	0.0016	
30	Normal Voltage	0.0012	0.0011	
20(Ref.)	Normal Voltage	0.0000	0.0000	
10	Normal Voltage	0.0024	0.0000	
0	Normal Voltage	0.0132	0.0037	
-10	Normal Voltage	0.0084	0.0059	
-20	Normal Voltage	0.0143	0.0000	
-30	Normal Voltage	0.0203	0.0016	
20	Maximum Voltage	0.0143	0.0069	
20	Normal Voltage	0.0000	0.0000	
20	Battery End Point	0.0036	0.0027	

Note:

- 1. Normal Voltage = 3.8V. ; Battery End Point (BEP) = 3.5 V. ; Maximum Voltage =4.2 V
- 2. The frequency fundamental emissions stay within the authorized frequency block based on the frequency deviation measured is small.



Radiated Spurious Emission

GSM850 (GSM)									
Channel	Frequency (MHz)	ERP (dBm)	Limit (dBm)	Over Limit (dB)	SPA Reading (dBm)	S.G. Power (dBm)	TX Cable loss (dB)	TX Antenna Gain (dBi)	Polarization (H/V)
Middle	1672	-45.42	-13	-32.42	-54.32	-49.83	2.84	9.40	H
	2512	-64.52	-13	-51.52	-74.94	-69.27	3.7	10.60	H
	3345.6	-62.19	-13	-49.19	-76.95	-68.27	4.37	12.60	H
	4182	-55.96	-13	-42.96	-73.53	-61.56	4.85	12.60	H
	5018.4	-53.99	-13	-40.99	-74.50	-59.60	4.94	12.70	H
	1672	-54.66	-13	-41.66	-59.48	-59.07	2.84	9.40	V
	2512	-66.50	-13	-53.50	-76.33	-71.25	3.70	10.60	V
	3345.6	-62.57	-13	-49.57	-76.14	-68.65	4.37	12.60	V
	4182	-52.45	-13	-39.45	-70.16	-58.05	4.85	12.60	V
	5018.4	-56.11	-13	-43.11	-76.09	-61.72	4.94	12.70	V

Remark: Spurious emissions within 30-1000MHz were found more than 20dB below limit line.

GSM1900 (GSM)									
Channel	Frequency (MHz)	EIRP (dBm)	Limit (dBm)	Over Limit (dB)	SPA Reading (dBm)	S.G. Power (dBm)	TX Cable loss (dB)	TX Antenna Gain (dBi)	Polarization (H/V)
Middle	3760	-44.86	-13	-31.86	-64.47	-52.61	4.85	12.60	H
	5640	-53.93	-13	-40.93	-77.38	-61.45	5.58	13.10	H
	7520	-60.13	-13	-47.13	-83.65	-64.87	6.56	11.30	H
	3760	-49.03	-13	-36.03	-69.42	-56.78	4.85	12.6	V
	5640	-53.29	-13	-40.29	-77.34	-60.81	5.58	13.1	V
	7520	-60.31	-13	-47.31	-83.85	-65.05	6.56	11.3	V

Remark: Spurious emissions within 30-1000MHz were found more than 20dB below limit line.



WCDMA Band II (RMC 12.2Kbps)									
Channel	Frequency (MHz)	EIRP (dBm)	Limit (dBm)	Over Limit (dB)	SPA Reading (dBm)	S.G. Power (dBm)	TX Cable loss (dB)	TX Antenna Gain (dBi)	Polarization (H/V)
Middle	3760	-61.40	-13	-48.40	-81.01	-69.15	4.85	12.60	H
	5640	-59.94	-13	-46.94	-83.39	-67.46	5.58	13.10	H
	7520	-60.17	-13	-47.17	-83.69	-64.91	6.56	11.30	H
	3760	-60.97	-13	-47.97	-81.36	-68.72	4.85	12.6	V
	5640	-58.90	-13	-45.90	-82.95	-66.42	5.58	13.1	V
	7520	-60.13	-13	-47.13	-83.67	-64.87	6.56	11.3	V

Remark: Spurious emissions within 30-1000MHz were found more than 20dB below limit line.

WCDMA Band V (RMC 12.2Kbps)									
Channel	Frequency (MHz)	ERP (dBm)	Limit (dBm)	Over Limit (dB)	SPA Reading (dBm)	S.G. Power (dBm)	TX Cable loss (dB)	TX Antenna Gain (dBi)	Polarization (H/V)
Middle	1673.04	-67.97	-13	-54.97	-73.53	-72.38	2.84	9.40	H
	2509.56	-67.69	-13	-54.69	-78.11	-72.44	3.7	10.60	H
	3346.08	-64.50	-13	-51.50	-79.26	-70.58	4.37	12.60	H
	4182.6	-61.23	-13	-48.23	-78.80	-66.83	4.85	12.60	H
	5019.12	-61.21	-13	-48.21	-81.72	-66.82	4.94	12.70	H
	1673.04	-67.16	-13	-54.16	-71.87	-71.57	2.84	9.40	V
	2509.56	-67.26	-13	-54.26	-77.09	-72.01	3.70	10.60	V
	3346.08	-66.07	-13	-53.07	-79.64	-72.15	4.37	12.60	V
	4182.6	-62.04	-13	-49.04	-79.75	-67.64	4.85	12.60	V
	5019.12	-61.96	-13	-48.96	-81.94	-67.57	4.94	12.70	V

Remark: Spurious emissions within 30-1000MHz were found more than 20dB below limit line.