

# FCC Radio Test Report

## FCC ID: 2ALSZ-CL3100N

**Report No.** : BTL-FCCP-2-2010T074  
**Equipment** : Photocontroller  
**Model Name** : ISLC3100-7P-N  
**Brand Name** : CIMCON  
**Applicant** : CIMCON Lighting, Inc.  
**Address** : 200 Summit Drive, Suite 500, South Tower, Burlington, Massachusetts,  
United States 01803

**Radio Function** : LTE Band 4, 12

**FCC Rule Part(s)** : 47 CFR FCC Part 27 Subpart H  
47 CFR FCC Part 27 Subpart L  
47 CFR FCC Part 2  
ANSI/TIA/EIA-603-E-2016  
FCC KDB 971168 D01 Power Meas License Digital Systems v03r01

**Measurement Procedure(s)** : ANSI C63.26-2015

**Date of Receipt** : 2020/10/22  
**Date of Test** : 2020/10/22 ~ 2020/11/20  
**Issued Date** : 2020/12/25

The above equipment has been tested and found in compliance with the requirement of the above standards by BTL Inc.

**Prepared by** :

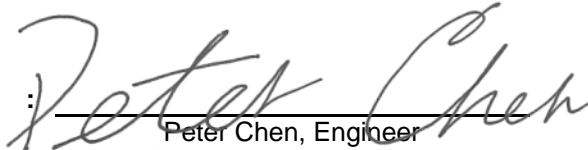
  
Peter Chen, Engineer



**Approved by** :

  
Scott Hsu, Manager

**BTL Inc.**

No.18, Ln. 171, Sec. 2, Jiuzong Rd., Neihu Dist., Taipei City 114, Taiwan

Tel: +886-2-2657-3299

Fax: +886-2-2657-3331

Web: [www.newbtl.com](http://www.newbtl.com)

**Declaration**

**BTL** represents to the client that testing is done in accordance with standard procedures as applicable and that test instruments used has been calibrated with standards traceable to international standard(s) and/or national standard(s).

**BTL's** reports apply only to the specific samples tested under conditions. It is manufacture's responsibility to ensure that additional production units of this model are manufactured with the identical electrical and mechanical components. **BTL** shall have no liability for any declarations, inferences or generalizations drawn by the client or others from **BTL** issued reports.

This report is the confidential property of the client. As a mutual protection to the clients, the public and ourselves, the test report shall not be reproduced, except in full, without our written approval.

**BTL's** laboratory quality assurance procedures are in compliance with the **ISO/IEC 17025** requirements, and accredited by the conformity assessment authorities listed in this test report.

**BTL** is not responsible for the sampling stage, so the results only apply to the sample as received.

The information, data and test plan are provided by manufacturer which may affect the validity of results, so it is manufacturer's responsibility to ensure that the apparatus meets the essential requirements of applied standards and in all the possible configurations as representative of its intended use.

**Limitation**

For the use of the authority's logo is limited unless the Test Standard(s)/Scope(s)/Item(s) mentioned in this test report is (are) included in the conformity assessment authorities acceptance respective.

Please note that the measurement uncertainty is provided for informational purpose only and are not use in determining the Pass/Fail results.

**CONTENTS**

REPORT ISSUED HISTORY	4
1 SUMMARY OF TEST RESULTS	5
1.1 TEST FACILITY	6
1.2 MEASUREMENT UNCERTAINTY	6
1.3 TEST ENVIRONMENT CONDITIONS	6
2 GENERAL INFORMATION	7
2.1 DESCRIPTION OF EUT	7
2.2 TEST MODES	7
2.3 BLOCK DIAGRAM SHOWING THE CONFIGURATION OF SYSTEM TESTED	8
2.4 SUPPORT UNITS	8
3 AC POWER LINE CONDUCTED EMISSIONS TEST	9
3.1 LIMIT	9
3.2 TEST PROCEDURE	9
3.3 DEVIATION FROM TEST STANDARD	9
3.4 TEST SETUP	10
3.5 TEST RESULT	10
4 RADIATED SPURIOUS EMISSIONS MEASUREMENT	11
4.1 LIMIT	11
4.2 TEST PROCEDURE	11
4.3 DEVIATION FROM TEST STANDARD	11
4.4 TEST SETUP	12
4.5 EUT OPERATING CONDITIONS	12
4.6 TEST RESULT	12
5 LIST OF MEASURING EQUIPMENTS	13
6 EUT TEST PHOTO	14
7 EUT PHOTOS	14
APPENDIX A AC POWER LINE CONDUCTED EMISSIONS	15
APPENDIX B RADIATED SPURIOUS EMISSIONS	20

### REPORT ISSUED HISTORY

Report Version	Description	Issued Date
R00	Original Issue.	2020/12/25

# 1 SUMMARY OF TEST RESULTS

Test procedures according to the technical standards.

FCC Clause No	Description	Test Result	Judgement	Remark
15.207	AC Power Line Conducted Emissions	APPENDIX A	Pass	-----
2.1053 27.53(g) 27.53(h)	Radiated Spurious Emissions	APPENDIX B	Pass	-----

**NOTE:**

- (1) "N/A" denotes test is not applicable in this Test Report.
- (2) The report format version is TP.1.1.1.
- (3) The spot check test channels were verified based on the worst channel results reported in the original FCC ID (XMR201707BG96) filing test report.  
Since the RF module has been certificated, after evaluation, above test items were criticized and reconfirmed in this report.
- (4) After spot check, this revision does not change original radio parameters.

### 1.1 TEST FACILITY

The test facilities used to collect the test data in this report:

No. 68-1, Ln. 169, Sec. 2, Datong Rd., Xizhi Dist., New Taipei City 221, Taiwan  
 The test sites and facilities are covered under FCC RN: 355421 and DN: TW1099.

C05     
  CB08     
  CB11     
  CB15     
  CB16

### 1.2 MEASUREMENT UNCERTAINTY

The reported uncertainty of measurement  $y \pm U$ , where expanded uncertainty  $U$  is based on a standard uncertainty multiplied by a coverage factor of  $k = 2$ , providing a level of confidence of approximately **95 %**. The measurement instrumentation uncertainty considerations contained in CISPR 16-4-2. The BTL measurement uncertainty is less than the CISPR 16-4-2  $U_{cispr}$  requirement.

#### A. AC power line conducted emissions test:

Test Site	Method	Measurement Frequency Range	U (dB)
C05	CISPR	150 kHz ~ 30MHz	3.44

#### B. Radiated emissions test :

Test Site	Measurement Frequency Range	U,(dB)
CB15	0.03 GHz ~ 0.2 GHz	4.17
	0.2 GHz ~ 1 GHz	4.72
	1 GHz ~ 6 GHz	5.21
	6 GHz ~ 18 GHz	5.51
	18 GHz ~ 26 GHz	3.69
	26 GHz ~ 40 GHz	4.23

#### NOTE:

Unless specifically mentioned, the uncertainty of measurement has not been taken into account to declare the compliance or non-compliance to the specification.

### 1.3 TEST ENVIRONMENT CONDITIONS

Test Item	Environment Condition	Test Voltage	Tested by
AC Power Line Conducted Emissions	23 °C, 65 %	AC 120V	Nero Hsieh
Radiated Spurious Emissions	Refer to data	AC 120V	Jay Kao

## 2 GENERAL INFORMATION

### 2.1 DESCRIPTION OF EUT

Equipment	Photocontroller		
Model Name	ISLC3100-7P-N		
Brand Name	CIMCON		
Model Difference	N/A		
Power Source	AC Mains.		
Power Rating	I/P: AC 100-277V, 50/60Hz		
Products Covered	N/A		
WWAN Module	Quectel / BG96		
Operation Frequency	Band	UL Frequency (MHz)	DL Frequency (MHz)
	LTE 4	1710 ~ 1755	2110 ~ 2155
	LTE 12	699 ~ 716	729 ~ 746
Modulation Type	UL:QPSK, BPSK DL:QPSK, BPSK		
Test Model	ISLC3100-7P-N		
Sample Status	Engineering Sample		
EUT Modification(s)	N/A		

**NOTE:**

(1) For a more detailed features description, please refer to the manufacturer's specifications or the user's manual.

(2) Table for Filed Antenna:

Antenna	Manufacture	P/N	Type	Connector	Gain (dBi)	Note
1		W3419BXXXX	FPC	I-PEX	4.68	LTE Band 4
					-3.66	LTE Band 12

### 2.2 TEST MODES

Test Items	Band	Test Mode	Note
AC Power Line Conducted Emissions	-	NB-IOT Normal/Idle	-
Radiated Spurious Emissions	LTE Band 4	NB-IOT TX Mode (CH 19957/20175/20392)	-
	LTE Band 12	NB-IOT TX Mode (CH 23017/23095/23173)	-

**NOTE:**

(1) The Radiated emissions test was verified based on the worst conducted power and Bandwidth test results reported in the original report.

(2) All X, Y and Z axes are evaluated, but only the worst case (X axis) is recorded.

### 2.3 BLOCK DIAGRAM SHOWING THE CONFIGURATION OF SYSTEM TESTED

Equipment letters and Cable numbers refer to item numbers described in the tables of clause 2.4.

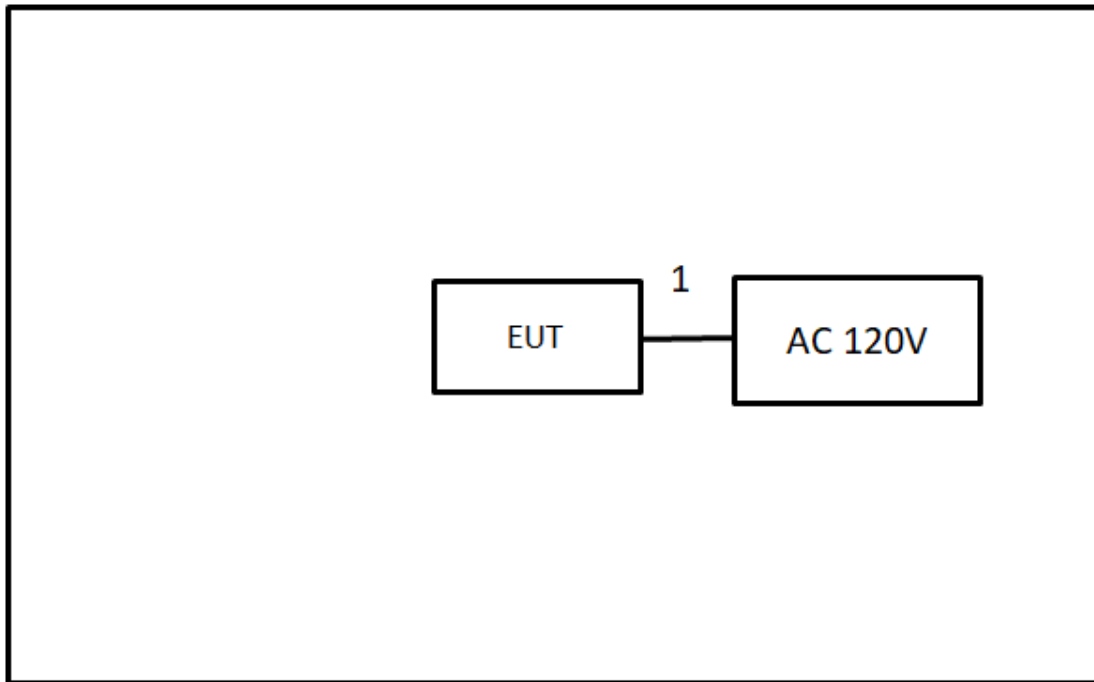

### 2.4 SUPPORT UNITS

Item	Equipment	Brand	Model No.	Series No.	Remarks
-	-	-	-	-	-

Item	Shielded	Ferrite Core	Length	Cable Type	Remarks
1	N/A	N/A	1.5m	Power Cord	Supplied by test requester



### 3 AC POWER LINE CONDUCTED EMISSIONS TEST

#### 3.1 LIMIT

Frequency (MHz)	Limit (dB $\mu$ V)	
	Quasi-peak	Average
0.15 - 0.5	66 - 56 *	56 - 46 *
0.50 - 5.0	56	46
5.0 - 30.0	60	50

**NOTE:**

- (1) The tighter limit applies at the band edges.
- (2) The limit of " \* " marked band means the limitation decreases linearly with the logarithm of the frequency in the range.
- (3) The test result calculated as following:  
 Measurement Value = Reading Level + Correct Factor  
 Correct Factor = Insertion Loss + Cable Loss + Attenuator Factor (if use)  
 Margin Level = Measurement Value – Limit Value  
 Calculation example:

Reading Level		Correct Factor		Measurement Value
38.22	+	3.45	=	41.67

Measurement Value		Limit Value		Margin Level
41.67	-	60	=	-18.33

The following table is the setting of the receiver.

Receiver Parameter	Setting
Attenuation	10 dB
Start Frequency	0.15 MHz
Stop Frequency	30 MHz
IF Bandwidth	9 KHz

#### 3.2 TEST PROCEDURE

- a. The EUT was placed 0.8 m above the horizontal ground plane with the EUT being connected to the power mains through a line impedance stabilization network (LISN).  
 All other support equipment were powered from an additional LISN(s).  
 The LISN provides 50 Ohm/50uH of impedance for the measuring instrument.
- b. Interconnecting cables that hang closer than 40 cm to the ground plane shall be folded back and forth in the center forming a bundle to keep the cable above 40 cm.
- c. Excess I/O cables that are not connected to a peripheral shall be bundled in the center.  
 The end of the cable will be terminated, using the correct terminating impedance.  
 The overall length shall not exceed 1 m.
- d. The LISN is spaced at least 80 cm from the nearest part of the EUT chassis.
- e. For the actual test configuration, please refer to the related Item - EUT TEST PHOTO.

**NOTE:**

- (1) In the results, each reading is marked as Peak, QP or AVG per the detector used.  
 BW=9 kHz (6 dB Bandwidth)
- (2) All readings are Peak unless otherwise stated QP or AVG in column of Note. Both the QP and the AVG readings must be less than the limit for compliance.

#### 3.3 DEVIATION FROM TEST STANDARD

No deviation.

### 3.4 TEST SETUP

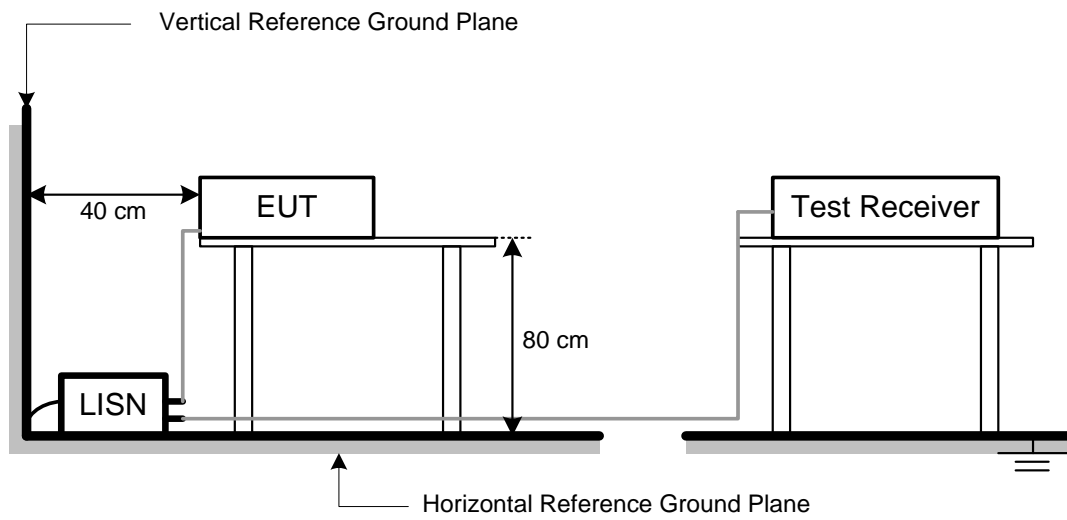

### 3.5 TEST RESULT

Please refer to the APPENDIX A.

## 4 RADIATED SPURIOUS EMISSIONS MEASUREMENT

### 4.1 LIMIT

The power of any emission outside of the authorized operating frequency ranges must be attenuated below the transmitting power (P) by a factor of at least  $43 + 10 \log(P)$  dB. The emission limit equal to -13dBm.

**NOTE:**

(1) The test result calculated as following:

Measurement Value = Reading Level + Correct Factor

Correct Factor = Antenna Factor + Cable Loss - Amplifier Gain(if use)

Margin Level = Measurement Value - Limit Value

Calculation example:

Reading Level		Correct Factor		Measurement Value
-50.43	+	-2.11	=	-52.54

Measurement Value		Limit Value		Margin Level
-52.54	-	-13	=	-39.54

### 4.2 TEST PROCEDURE

The testing follows FCC KDB 971168 v03r01 Section 6.2.

- In the semi-anechoic chamber, EUT placed on the 0.8m height of Turn Table, rotated the table around 360 degrees to search the maximum radiation power and receiver antenna shall be rotated vertical and horizontal polarization and moved height from 1m to 4m to find the maximum polar radiated power. The "Read Value" is the spectrum reading the maximum power value.
- The substitution horn antenna is substituted for EUT at the same position and signals generator export the CW signal to the substitution antenna via a TX cable. Rotated the Turn Table and moved receiving antenna to find the maximum radiation power. Adjust output power level of S.G to get a Value of spectrum reading equal to "Read Value " of step a. Record the power level of S.G
- $EIRP = \text{Output power level of S.G} - \text{TX cable loss} + \text{Antenna gain of substitution horn.}$
- ERP power can be calculated form EIRP power by subtracting the gain of dipole,  
 $ERP \text{ power} = EIRP \text{ power} - 2.15 \text{ dBi.}$
- The resolution bandwidth and video bandwidth of test receiver/spectrum analyzer is 1 MHz / 3 MHz.

### 4.3 DEVIATION FROM TEST STANDARD

No deviation.

## 4.4 TEST SETUP

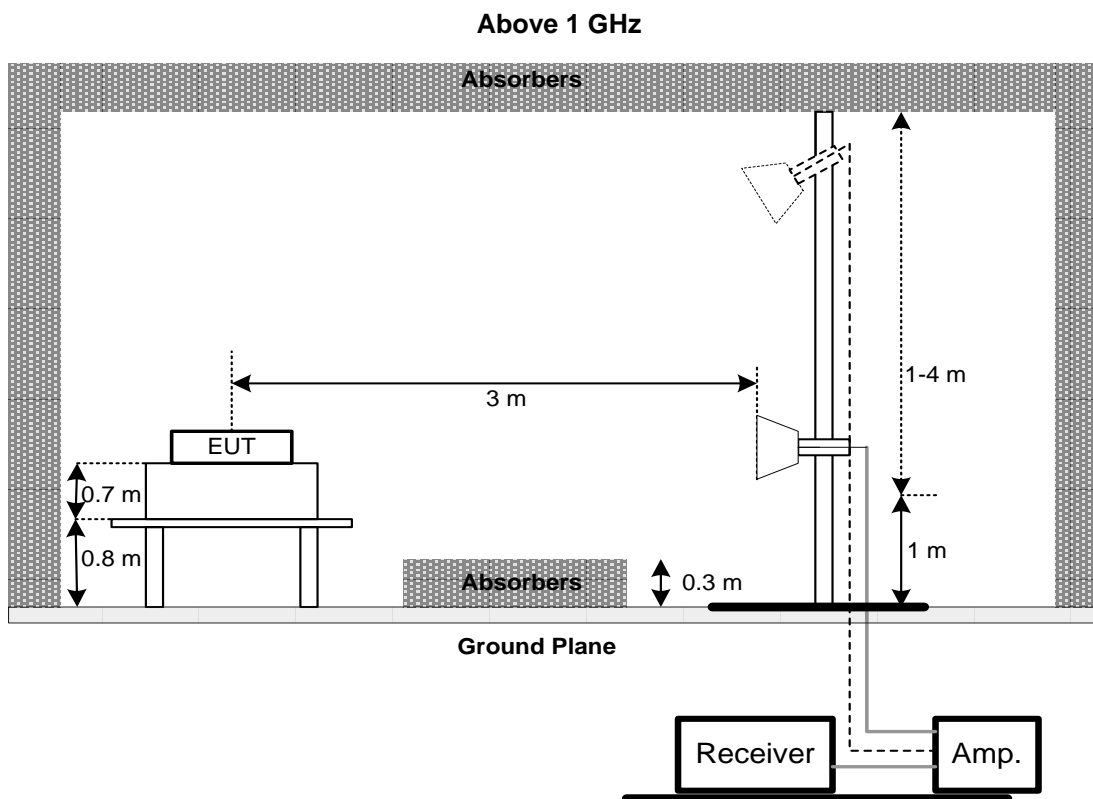
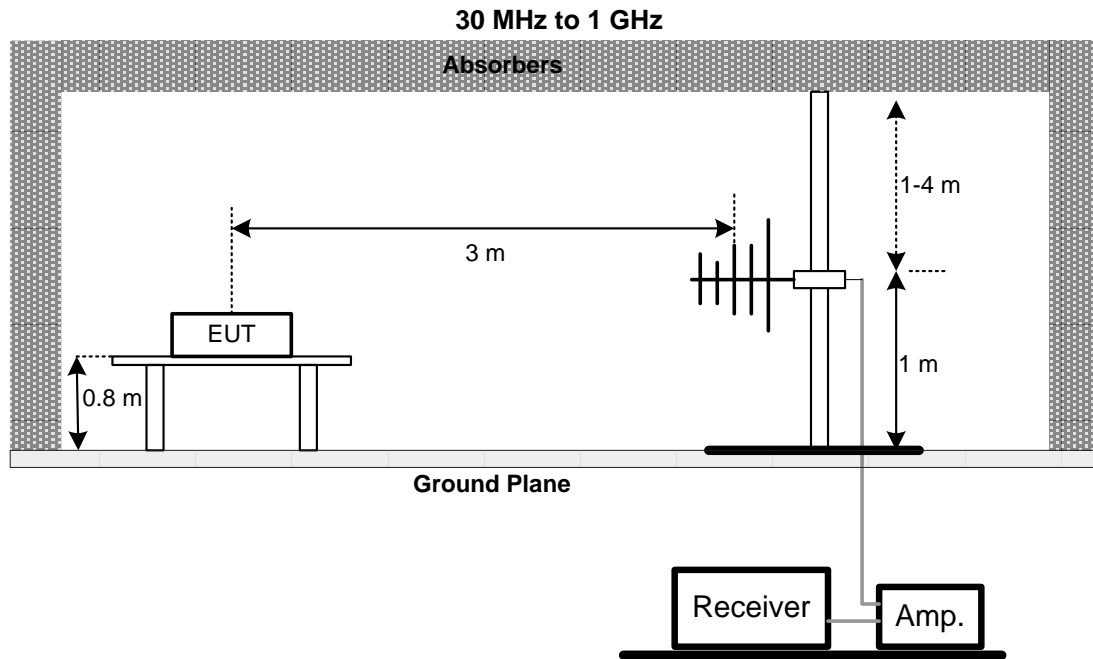

## 4.5 EUT OPERATING CONDITIONS

The EUT was programmed to be in continuously transmitting mode.

## 4.6 TEST RESULT

Please refer to the APPENDIX B

## 5 LIST OF MEASURING EQUIPMENTS

AC Power Line Conducted Emissions						
Item	Kind of Equipment	Manufacturer	Type No.	Serial No.	Calibrated Date	Calibrated Until
1	TWO-LINE V-NETWORK	R&S	ENV216	101050	2020/6/11	2021/6/10
2	Test Cable	EMCI	EMC400-BM-BM-5000	170501	2020/6/8	2021/6/7
3	EMI Test Receiver	R&S	ESR7	101433	2019/12/13	2020/12/12
4	Measurement Software	EZ	EZ EMC (Version NB-03A1-01)	N/A	N/A	N/A

Radiated Emissions						
Item	Kind of Equipment	Manufacturer	Type No.	Serial No.	Calibrated Date	Calibrated Until
1	Preamplifier	EMCI	EMC02325B	980217	2020/4/10	2021/4/9
2	Preamplifier	EMCI	EMC012645B	980267	2020/4/10	2021/4/9
3	Test Cable	EMCI	EMC-SM-SM-1000	180809	2020/4/10	2021/4/9
4	Test Cable	EMCI	EMC104-SM-SM-3000	151205	2020/4/10	2021/4/9
5	Test Cable	EMCI	EMC-SM-SM-7000	180408	2020/4/10	2021/4/9
6	MXE EMI Receiver	Agilent	N9038A	MY554200087	2020/6/10	2021/6/9
7	Signal Analyzer	Agilent	N9010A	MY56480554	2020/8/25	2021/8/24
8	Horn Ant	SCHWARZBECK	BBHA 9120D	9120D-1342	2020/6/12	2021/6/11
9	Trilog-Broadband Antenna	Schwarzbeck	VULB 9168	VULB 9168-352	2020/7/24	2021/7/23
10	5dB Attenuator	EMCI	EMCI-N-6-05	AT-N0625	2020/7/24	2021/7/23
11	Measurement Software	EZ	EZ EMC (Version NB-03A1-01)	N/A	N/A	N/A
12	Radio Communication Analyzer	Anritsu	MT8821C	6262044728	2019/12/3	2020/12/2

Remark: "N/A" denotes no model name, no serial no. or no calibration specified.  
All calibration period of equipment list is one year.

**6 EUT TEST PHOTO**

Please refer to document Appendix No.: TP-2010T074-FCCP-1 (APPENDIX-TEST PHOTOS).

**7 EUT PHOTOS**

Please refer to document Appendix No.: EP-2010T074-1 (APPENDIX-EUT PHOTOS).

## **APPENDIX A AC POWER LINE CONDUCTED EMISSIONS**

Test Mode	NB-IOT Normal	Tested Date	2020/11/13
Test Frequency	-	Phase	Line

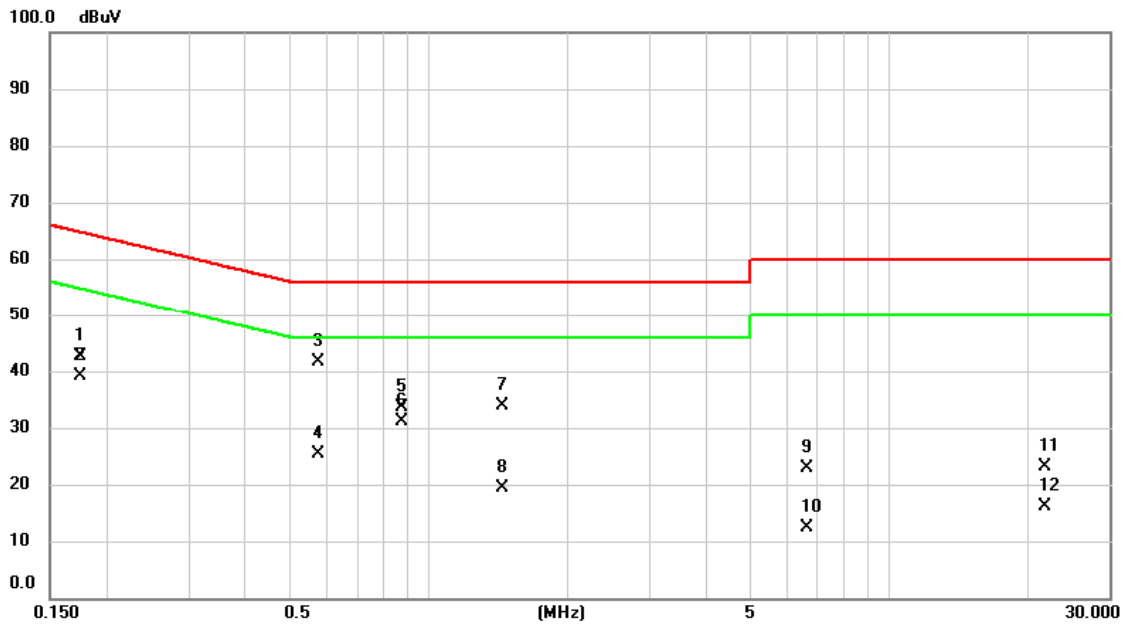

No.	Mk.	Freq. MHz	Reading Level dBuV	Correct Factor dB	Measure- ment dBuV	Limit dBuV	Over dB	Detector	Comment
1		0.1748	33.05	9.68	42.73	64.73	-22.00	QP	
2		0.1748	29.52	9.68	39.20	54.73	-15.53	AVG	
3	*	0.5775	31.87	9.68	41.55	56.00	-14.45	QP	
4		0.5775	15.81	9.68	25.49	46.00	-20.51	AVG	
5		0.8745	23.97	9.69	33.66	56.00	-22.34	QP	
6		0.8745	21.46	9.69	31.15	46.00	-14.85	AVG	
7		1.4415	24.07	9.71	33.78	56.00	-22.22	QP	
8		1.4415	9.62	9.71	19.33	46.00	-26.67	AVG	
9		6.6255	13.07	9.86	22.93	60.00	-37.07	QP	
10		6.6255	2.61	9.86	12.47	50.00	-37.53	AVG	
11		21.6780	13.23	9.95	23.18	60.00	-36.82	QP	
12		21.6780	6.18	9.95	16.13	50.00	-33.87	AVG	

**REMARKS:**

- (1) Measurement Value = Reading Level + Correct Factor.
- (2) Margin Level = Measurement Value - Limit Value.



Test Mode	NB-IOT Normal	Tested Date	2020/11/13
Test Frequency	-	Phase	Neutral

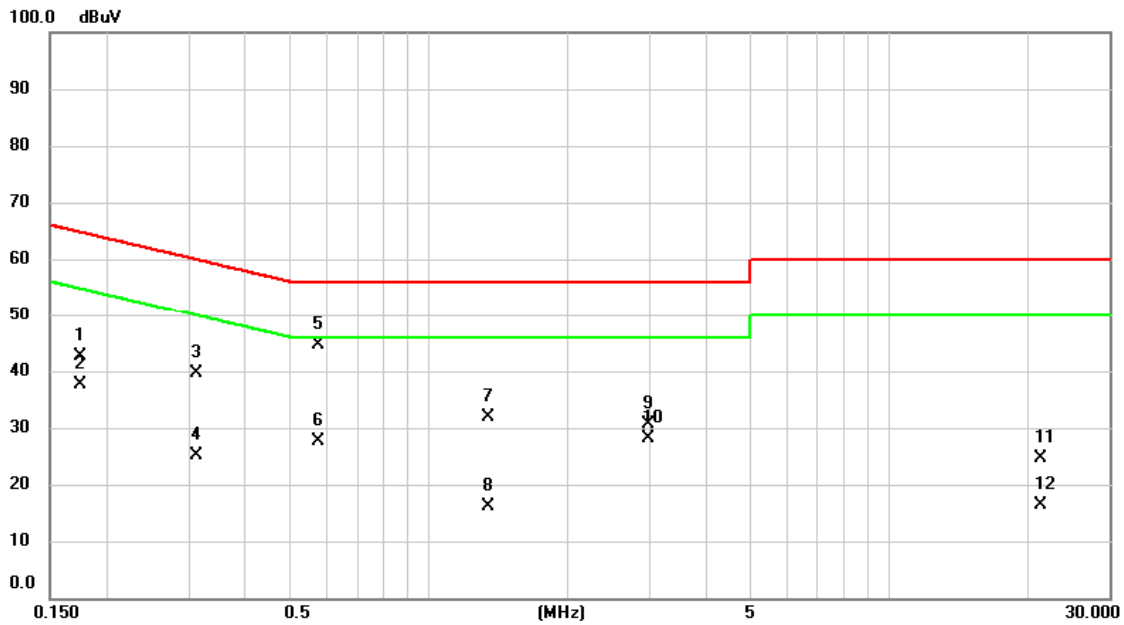

No.	Mk.	Freq. MHz	Reading Level dBuV	Correct Factor dB	Measure- ment dBuV	Limit dBuV	Over dB	Detector	Comment
1		0.1748	32.86	9.68	42.54	64.73	-22.19	QP	
2		0.1748	27.86	9.68	37.54	54.73	-17.19	AVG	
3		0.3120	29.94	9.68	39.62	59.92	-20.30	QP	
4		0.3120	15.37	9.68	25.05	49.92	-24.87	AVG	
5	*	0.5775	34.83	9.68	44.51	56.00	-11.49	QP	
6		0.5775	17.95	9.68	27.63	46.00	-18.37	AVG	
7		1.3448	22.27	9.70	31.97	56.00	-24.03	QP	
8		1.3448	6.37	9.70	16.07	46.00	-29.93	AVG	
9		2.9782	20.77	9.76	30.53	56.00	-25.47	QP	
10		2.9782	18.45	9.76	28.21	46.00	-17.79	AVG	
11		21.3698	14.72	9.95	24.67	60.00	-35.33	QP	
12		21.3698	6.44	9.95	16.39	50.00	-33.61	AVG	

**REMARKS:**

- (1) Measurement Value = Reading Level + Correct Factor.
- (2) Margin Level = Measurement Value - Limit Value.

Test Mode	NB-IOT Idle	Tested Date	2020/11/13
Test Frequency	-	Phase	Line

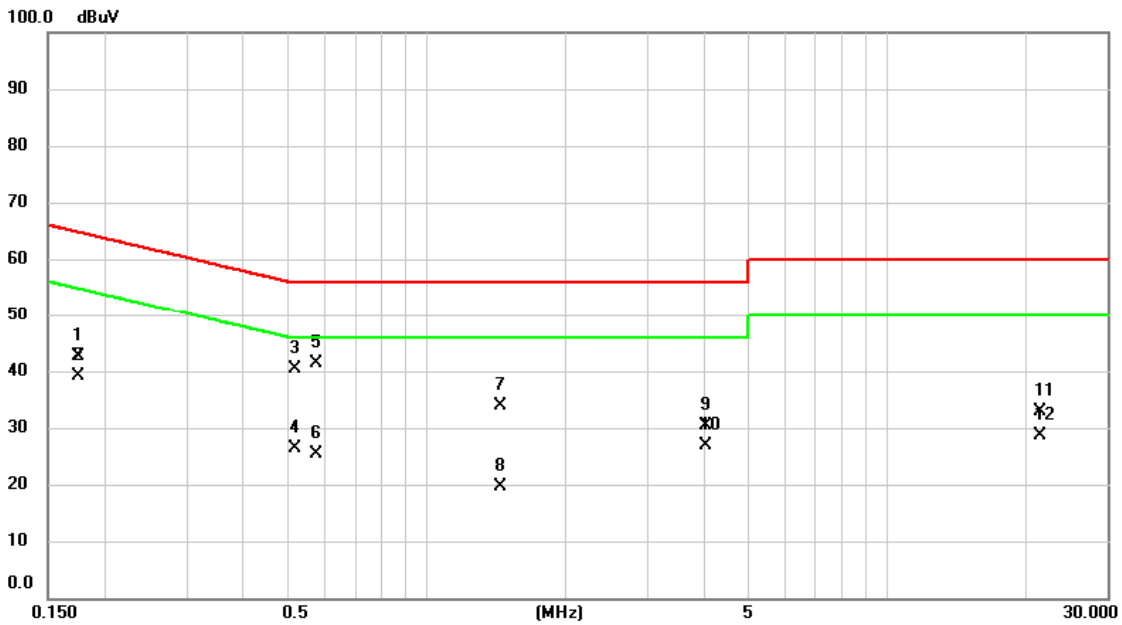

No.	Mk.	Freq. MHz	Reading Level dBuV	Correct Factor dB	Measure- ment dBuV	Limit dBuV	Over dB	Detector	Comment
1		0.1748	32.97	9.68	42.65	64.73	-22.08	QP	
2		0.1748	29.43	9.68	39.11	54.73	-15.62	AVG	
3		0.5190	30.79	9.68	40.47	56.00	-15.53	QP	
4		0.5190	16.58	9.68	26.26	46.00	-19.74	AVG	
5	*	0.5775	31.81	9.68	41.49	56.00	-14.51	QP	
6		0.5775	15.75	9.68	25.43	46.00	-20.57	AVG	
7		1.4415	24.12	9.71	33.83	56.00	-22.17	QP	
8		1.4415	9.88	9.71	19.59	46.00	-26.41	AVG	
9		4.0335	20.56	9.80	30.36	56.00	-25.64	QP	
10		4.0335	17.12	9.80	26.92	46.00	-19.08	AVG	
11		21.3990	22.91	9.95	32.86	60.00	-27.14	QP	
12		21.3990	18.70	9.95	28.65	50.00	-21.35	AVG	

**REMARKS:**

- (1) Measurement Value = Reading Level + Correct Factor.
- (2) Margin Level = Measurement Value - Limit Value.

Test Mode	NB-IOT Idle	Tested Date	2020/11/13
Test Frequency	-	Phase	Neutral

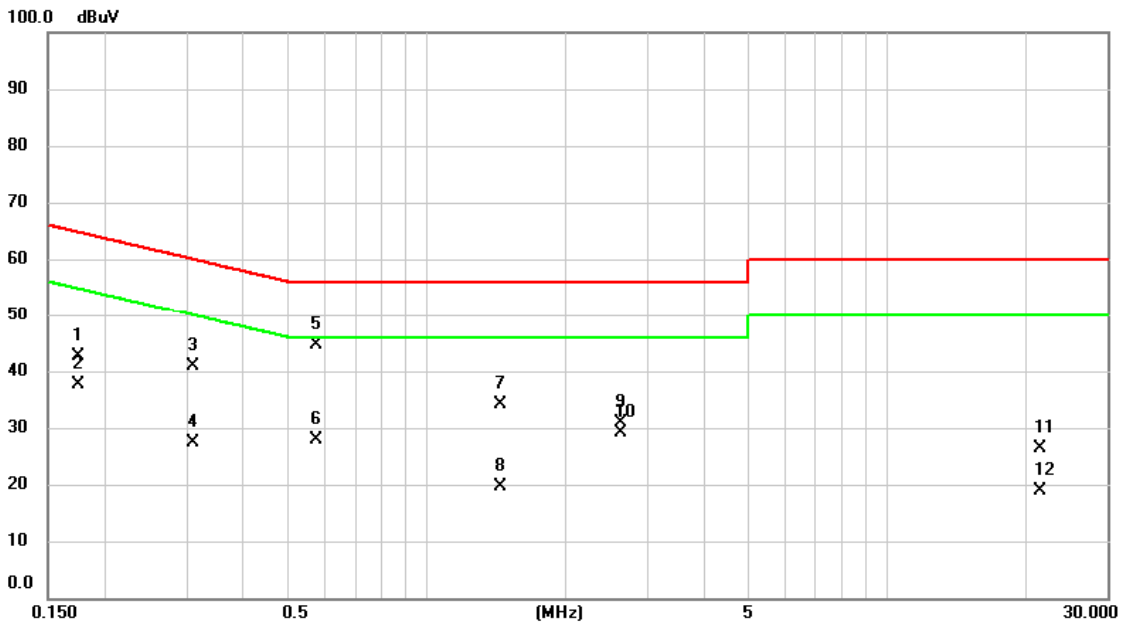

No.	Mk.	Freq. MHz	Reading Level dBuV	Correct Factor dB	Measure- ment dBuV	Limit dBuV	Over dB	Detector	Comment
1		0.1748	32.86	9.68	42.54	64.73	-22.19	QP	
2		0.1748	27.84	9.68	37.52	54.73	-17.21	AVG	
3		0.3097	31.28	9.68	40.96	59.98	-19.02	QP	
4		0.3097	17.68	9.68	27.36	49.98	-22.62	AVG	
5	*	0.5775	34.94	9.68	44.62	56.00	-11.38	QP	
6		0.5775	18.22	9.68	27.90	46.00	-18.10	AVG	
7		1.4415	24.48	9.71	34.19	56.00	-21.81	QP	
8		1.4415	10.03	9.71	19.74	46.00	-26.26	AVG	
9		2.6295	21.12	9.76	30.88	56.00	-25.12	QP	
10		2.6295	19.33	9.76	29.09	46.00	-16.91	AVG	
11		21.3855	16.52	9.95	26.47	60.00	-33.53	QP	
12		21.3855	8.88	9.95	18.83	50.00	-31.17	AVG	

**REMARKS:**

- (1) Measurement Value = Reading Level + Correct Factor.
- (2) Margin Level = Measurement Value - Limit Value.

## **APPENDIX B    RADIATED SPURIOUS EMISSIONS**

Test Mode	NB-IOT Band 4	Test Date	2020/11/10
Test Channel	CH20175	Polarization	Vertical
Temp	23°C	Hum.	64%
Modulation Type	QPSK	Sub-carrier Spacing	15KHz

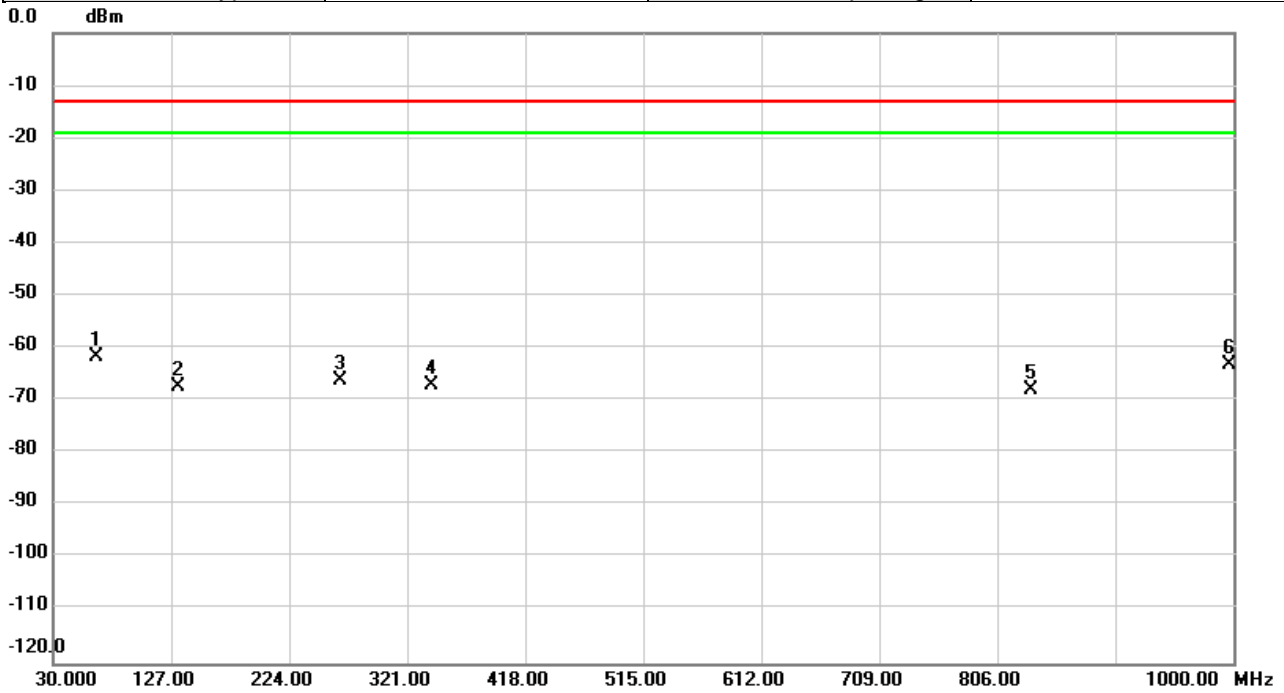

No.	Mk.	Freq. MHz	Reading Level dBm	Correct Factor dB	Measure- ment dBm	Limit dBm	Over dB	Detector	Comment
1	*	65.9547	-59.72	-1.98	-61.70	-13.00	-48.70	peak	
2		133.3697	-68.55	1.22	-67.33	-13.00	-54.33	peak	
3		266.0980	-73.83	7.69	-66.14	-13.00	-53.14	peak	
4		340.6263	-73.90	6.82	-67.08	-13.00	-54.08	peak	
5		834.2592	-77.47	9.59	-67.88	-13.00	-54.88	peak	
6		996.5080	-77.77	14.77	-63.00	-13.00	-50.00	peak	

**REMARKS:**

- (1) Measurement Value = Reading Level + Correct Factor.
- (2) Margin Level = Measurement Value - Limit Value.

Test Mode	NB-IOT Band 4	Test Date	2020/11/10
Test Channel	CH20175	Polarization	Horizontal
Temp	23°C	Hum.	64%
Modulation Type	QPSK	Sub-carrier Spacing	15KHz

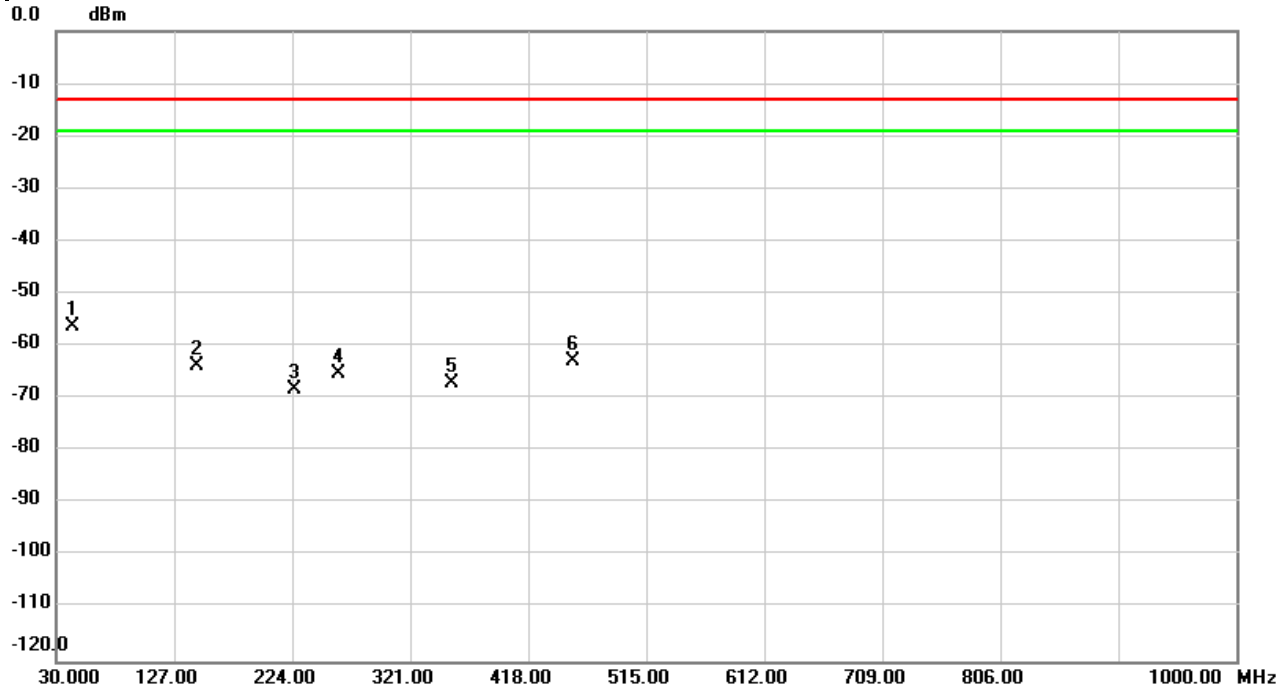

No.	Mk.	Freq. MHz	Reading Level dBm	Correct Factor dB	Measure- ment dBm	Limit dBm	Over dB	Detector	Comment
1	*	43.5477	-72.40	16.17	-56.23	-13.00	-43.23	peak	
2		145.7857	-66.58	2.81	-63.77	-13.00	-50.77	peak	
3		225.5520	-67.32	-0.79	-68.11	-13.00	-55.11	peak	
4		261.8947	-64.84	-0.33	-65.17	-13.00	-52.17	peak	
5		354.9176	-71.47	4.29	-67.18	-13.00	-54.18	peak	
6		455.1833	-75.12	12.39	-62.73	-13.00	-49.73	peak	

**REMARKS:**

- (1) Measurement Value = Reading Level + Correct Factor.
- (2) Margin Level = Measurement Value - Limit Value.

Test Mode	NB-IOT Band 4	Test Date	2020/11/10
Test Channel	CH19957	Polarization	Vertical
Temp	23°C	Hum.	64%
Modulation Type	QPSK	Sub-carrier Spacing	3.75KHz

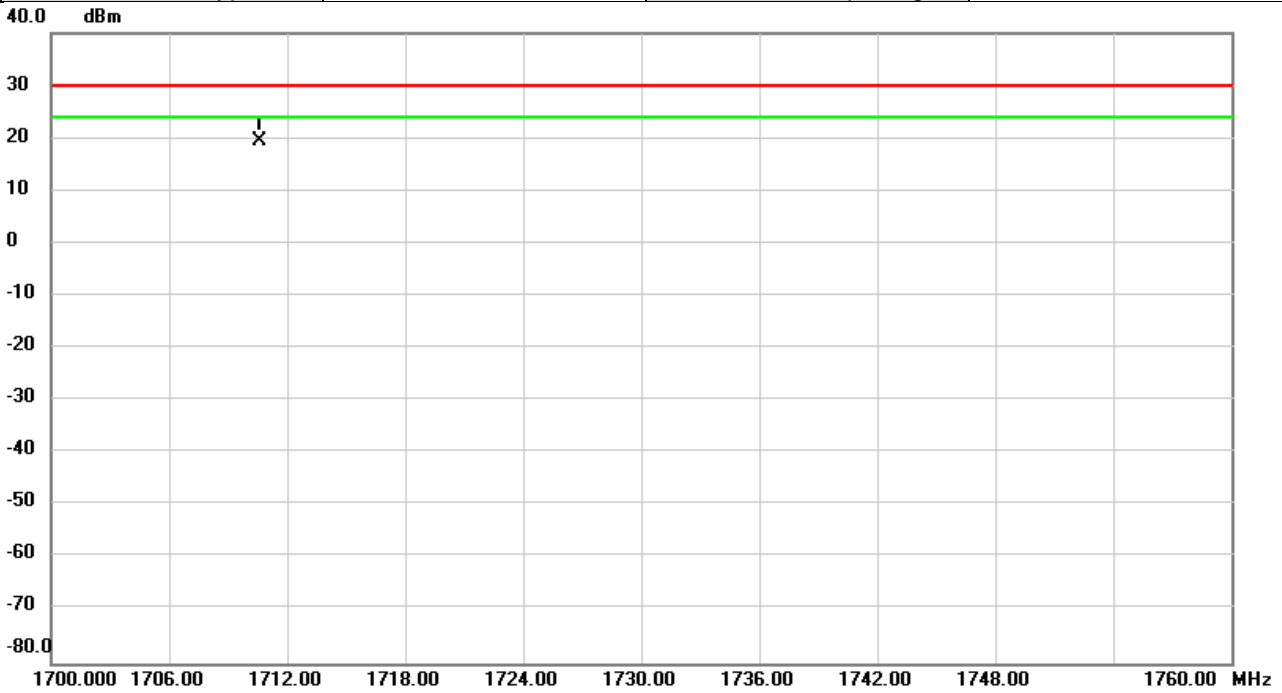

No.	Mk.	Freq. MHz	Reading Level dBm	Correct Factor dB	Measure- ment dBm	Limit dBm	Over dB	Detector	Comment
1	*	1710.626	26.20	-6.72	19.48	30.00	-10.52	peak	

REMARKS:

- (1) Measurement Value = Reading Level + Correct Factor.
- (2) Margin Level = Measurement Value - Limit Value.

Test Mode	NB-IOT Band 4	Test Date	2020/11/10
Test Channel	CH19957	Polarization	Horizontal
Temp	23°C	Hum.	64%
Modulation Type	QPSK	Sub-carrier Spacing	3.75KHz

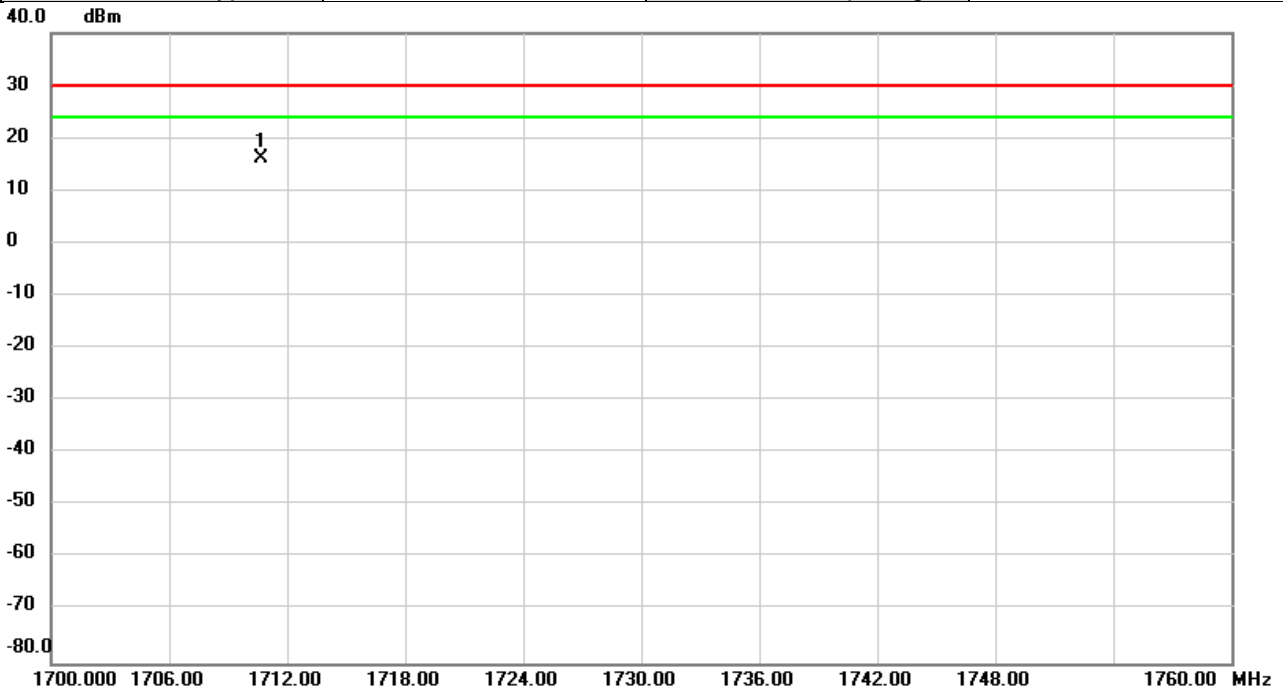

No.	Mk.	Freq.	Reading Level	Correct Factor	Measurement	Limit	Over	Detector	Comment
		MHz	dBm	dB	dBm	dBm	dB		
1	*	1710.684	24.23	-7.93	16.30	30.00	-13.70	peak	

**REMARKS:**

- (1) Measurement Value = Reading Level + Correct Factor.
- (2) Margin Level = Measurement Value - Limit Value.



Test Mode	NB-IOT Band 4	Test Date	2020/11/10
Test Channel	CH19957	Polarization	Vertical
Temp	23°C	Hum.	64%
Modulation Type	QPSK	Sub-carrier Spacing	15KHz

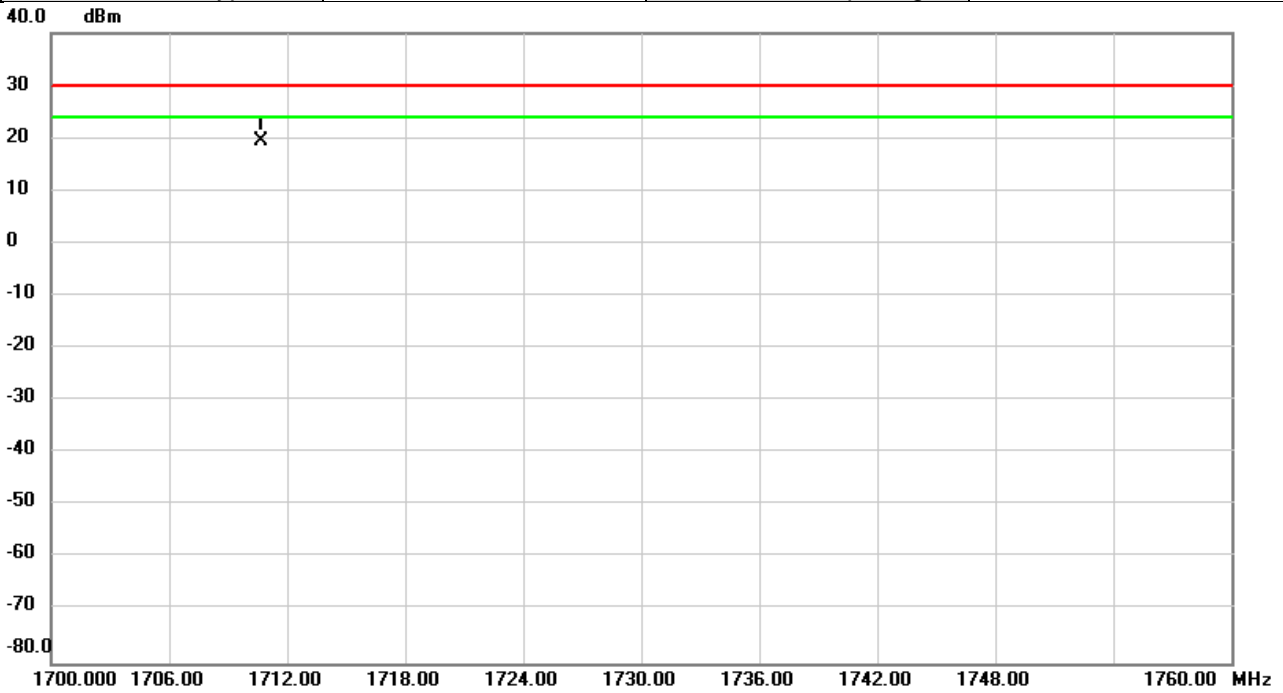

No.	Mk.	Freq. MHz	Reading Level dBm	Correct Factor dB	Measure- ment dBm	Limit dBm	Over dB	Detector	Comment
1	*	1710.656	26.21	-6.72	19.49	30.00	-10.51	peak	

**REMARKS:**

- (1) Measurement Value = Reading Level + Correct Factor.
- (2) Margin Level = Measurement Value - Limit Value.

Test Mode	NB-IOT Band 4	Test Date	2020/11/10
Test Channel	CH19957	Polarization	Horizontal
Temp	23°C	Hum.	64%
Modulation Type	QPSK	Sub-carrier Spacing	15KHz

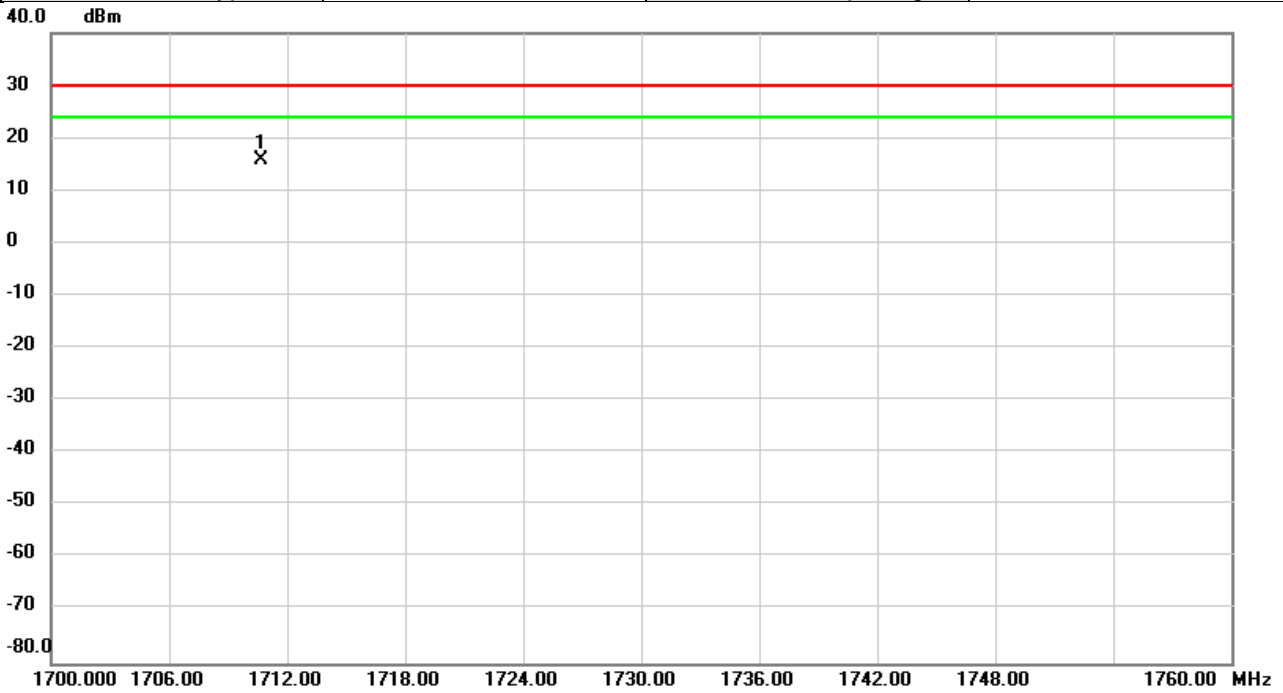

No.	Mk.	Freq.	Reading Level	Correct Factor	Measurement	Limit	Over	Detector	Comment
		MHz	dBm	dB	dBm	dBm	dB		
1	*	1710.672	23.90	-7.93	15.97	30.00	-14.03	peak	

**REMARKS:**

- (1) Measurement Value = Reading Level + Correct Factor.
- (2) Margin Level = Measurement Value - Limit Value.

Test Mode	NB-IOT Band 4	Test Date	2020/11/10
Test Channel	CH20175	Polarization	Vertical
Temp	23°C	Hum.	64%
Modulation Type	QPSK	Sub-carrier Spacing	3.75KHz

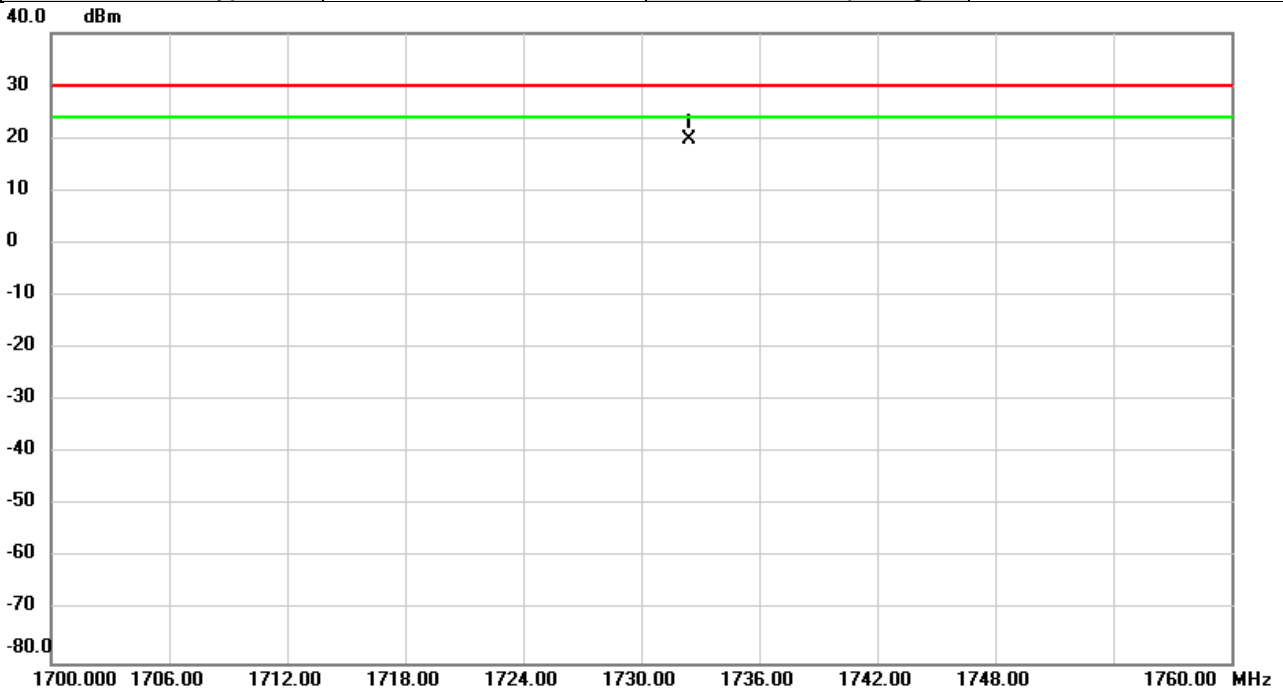

No.	Mk.	Freq.	Reading Level	Correct Factor	Measurement	Limit	Over	Detector	Comment
		MHz	dBm	dB	dBm	dBm	dB		
1	*	1732.442	26.56	-6.68	19.88	30.00	-10.12	peak	

REMARKS:

- (1) Measurement Value = Reading Level + Correct Factor.
- (2) Margin Level = Measurement Value - Limit Value.

Test Mode	NB-IOT Band 4	Test Date	2020/11/10
Test Channel	CH20175	Polarization	Horizontal
Temp	23°C	Hum.	64%
Modulation Type	QPSK	Sub-carrier Spacing	3.75KHz

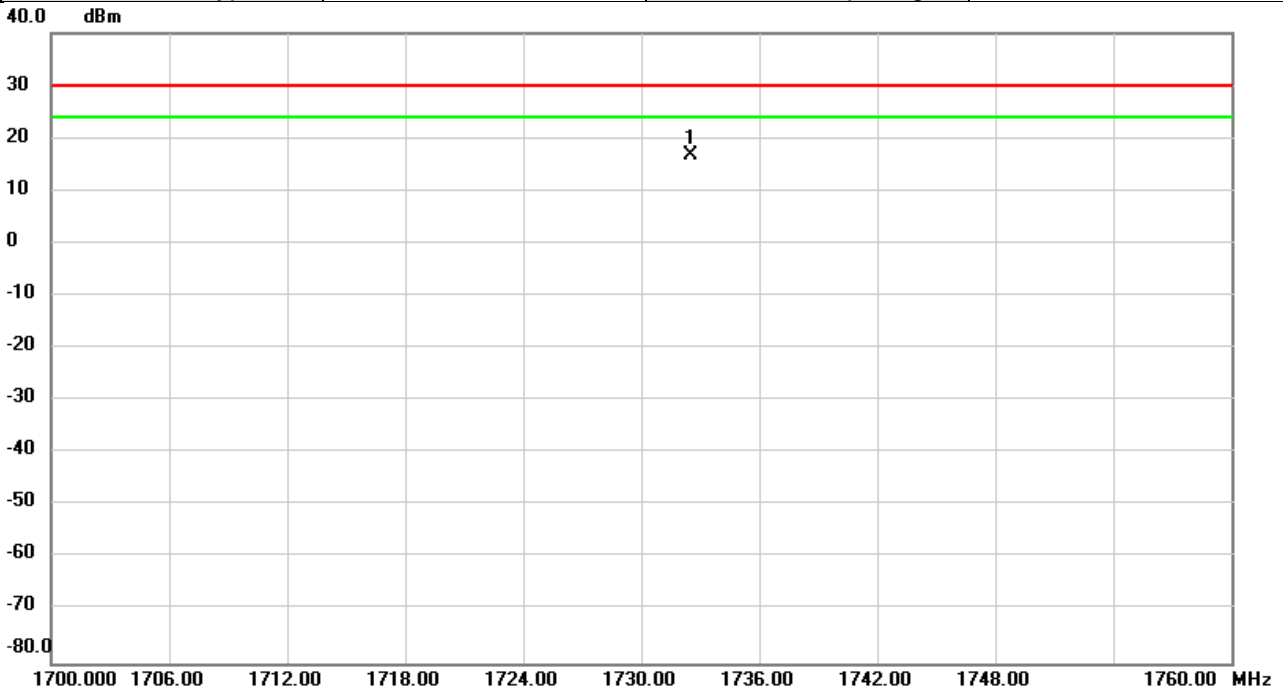

No.	Mk.	Freq.	Reading Level	Correct Factor	Measurement	Limit	Over	Detector	Comment
		MHz	dBm	dB	dBm	dBm	dB		
1	*	1732.496	24.62	-7.76	16.86	30.00	-13.14	peak	

REMARKS:

- (1) Measurement Value = Reading Level + Correct Factor.
- (2) Margin Level = Measurement Value - Limit Value.

Test Mode	NB-IOT Band 4	Test Date	2020/11/10
Test Channel	CH20175	Polarization	Vertical
Temp	23°C	Hum.	64%
Modulation Type	QPSK	Sub-carrier Spacing	15KHz

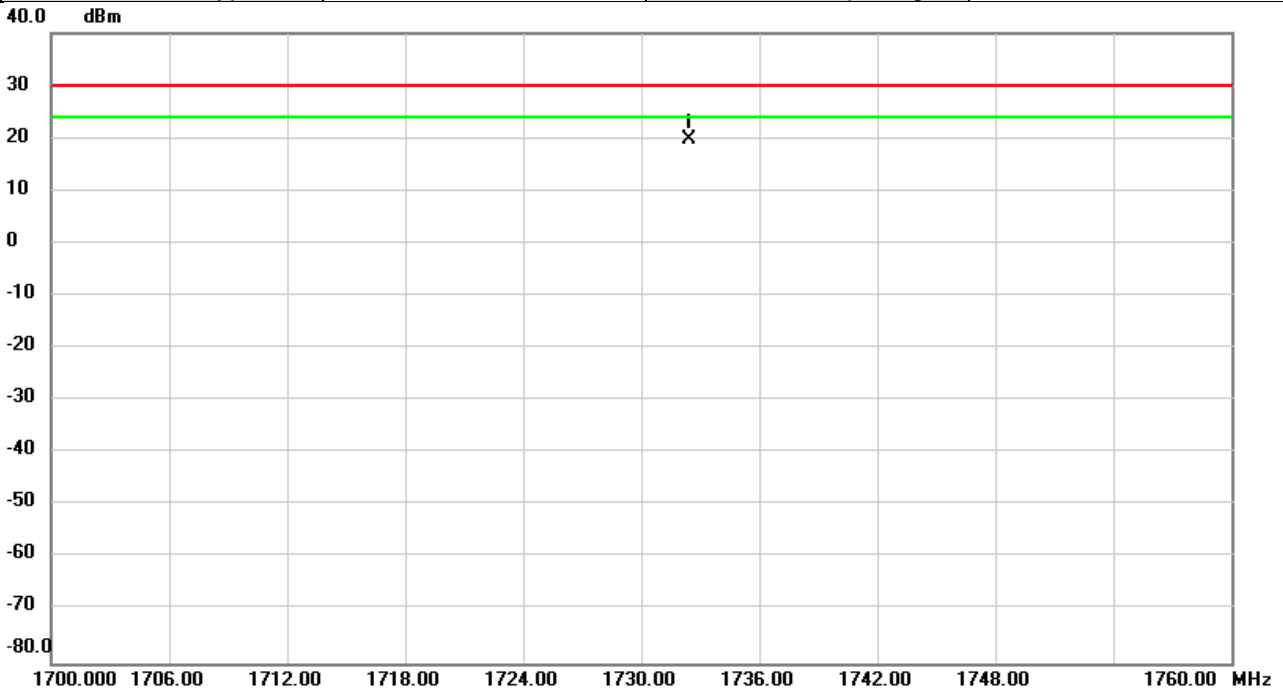

No.	Mk.	Freq.	Reading Level	Correct Factor	Measurement	Limit	Over	Detector	Comment
		MHz	dBm	dB	dBm	dBm	dB		
1	*	1732.462	26.50	-6.68	19.82	30.00	-10.18	peak	

**REMARKS:**

- (1) Measurement Value = Reading Level + Correct Factor.
- (2) Margin Level = Measurement Value - Limit Value.

Test Mode	NB-IOT Band 4	Test Date	2020/11/10
Test Channel	CH20175	Polarization	Horizontal
Temp	23°C	Hum.	64%
Modulation Type	QPSK	Sub-carrier Spacing	15KHz

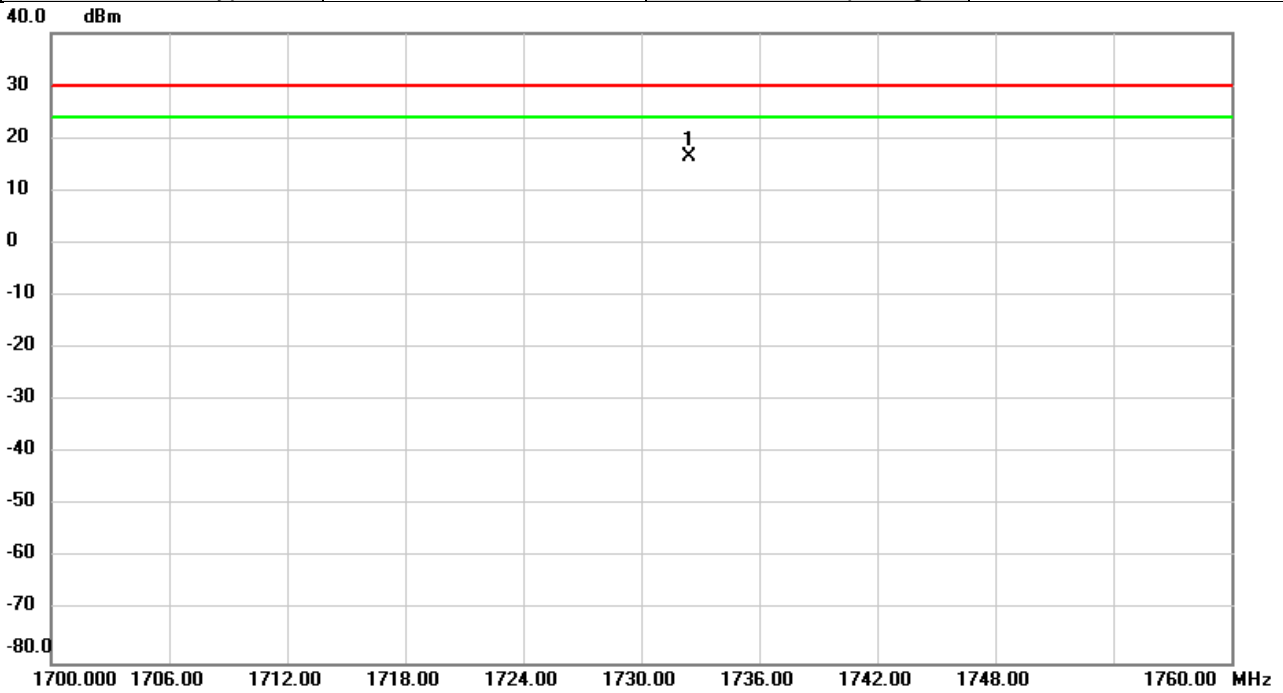

No.	Mk.	Freq.	Reading Level	Correct Factor	Measurement	Limit	Over	Detector	Comment
		MHz	dBm	dB	dBm	dBm	dB		
1	*	1732.460	24.19	-7.76	16.43	30.00	-13.57	peak	

REMARKS:

- (1) Measurement Value = Reading Level + Correct Factor.
- (2) Margin Level = Measurement Value - Limit Value.

Test Mode	NB-IOT Band 4	Test Date	2020/11/10
Test Channel	CH20392	Polarization	Vertical
Temp	23°C	Hum.	64%
Modulation Type	QPSK	Sub-carrier Spacing	3.75KHz

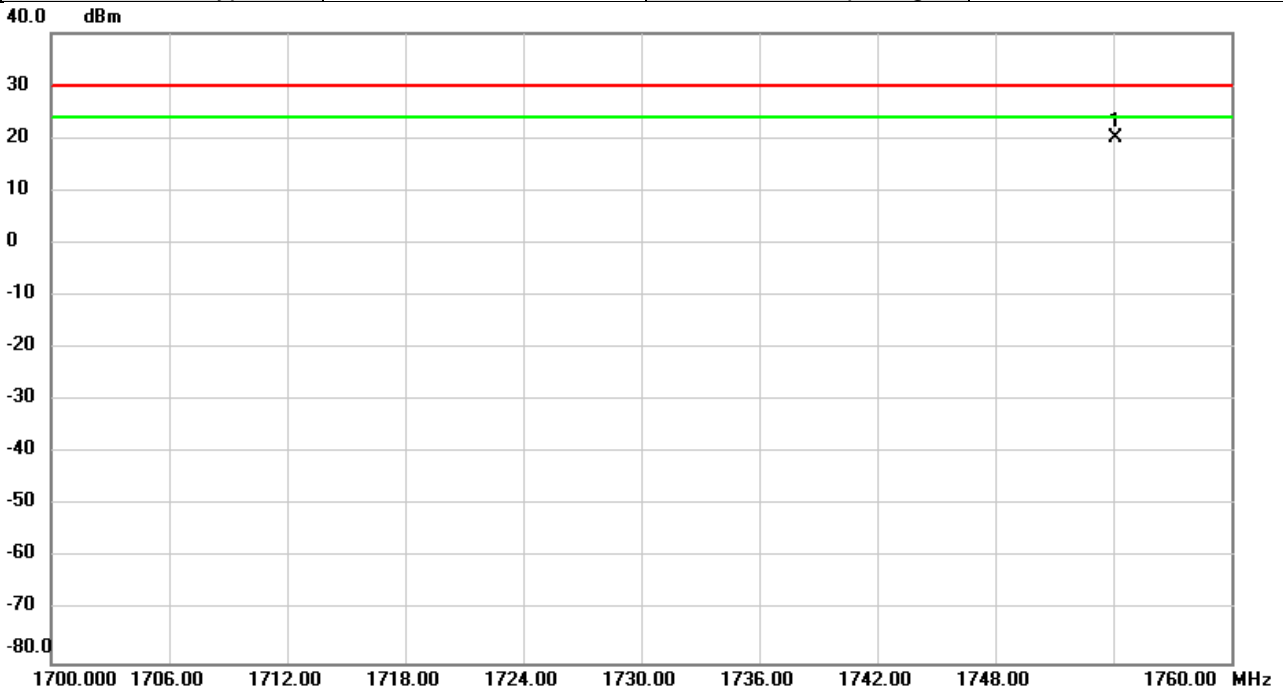

No.	Mk.	Freq.	Reading Level	Correct Factor	Measurement	Limit	Over	Detector	Comment
		MHz	dBm	dB	dBm	dBm	dB		
1	*	1754.142	26.61	-6.64	19.97	30.00	-10.03	peak	

**REMARKS:**

- (1) Measurement Value = Reading Level + Correct Factor.
- (2) Margin Level = Measurement Value - Limit Value.

Test Mode	NB-IOT Band 4	Test Date	2020/11/10
Test Channel	CH20392	Polarization	Horizontal
Temp	23°C	Hum.	64%
Modulation Type	QPSK	Sub-carrier Spacing	3.75KHz

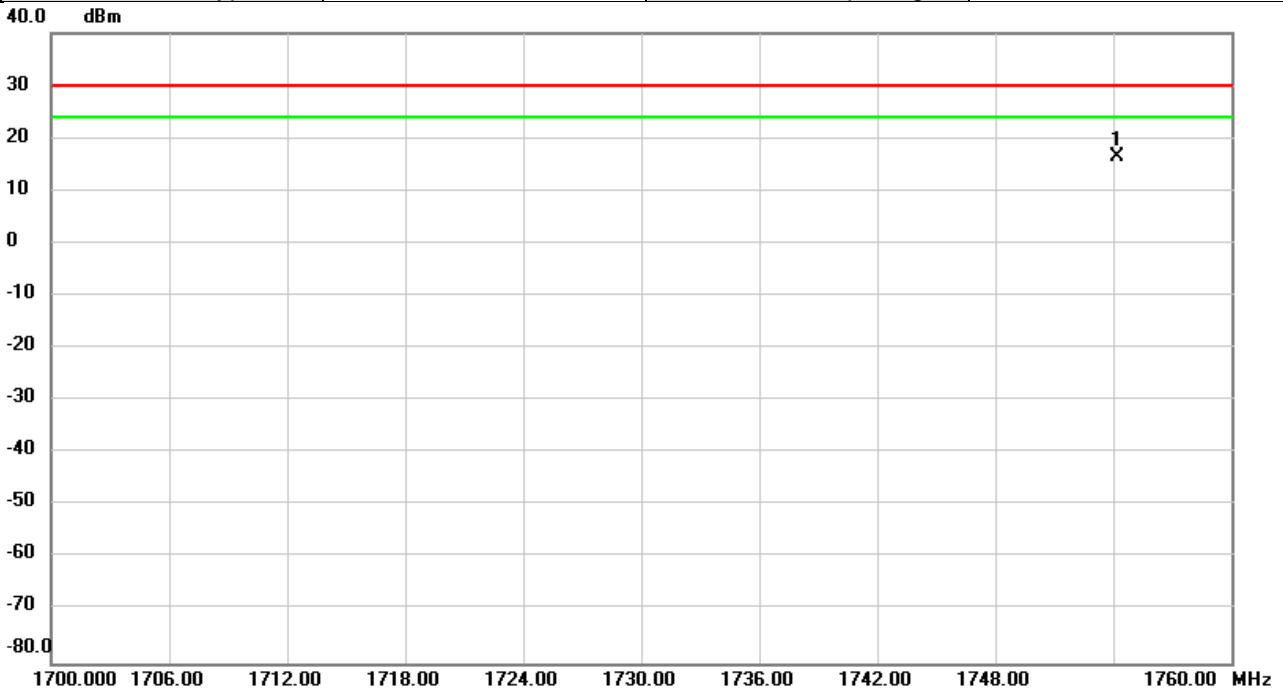

No.	Mk.	Freq. MHz	Reading Level dBm	Correct Factor dB	Measure- ment dBm	Limit dBm	Over dB	Detector	Comment
1	*	1754.218	24.17	-7.57	16.60	30.00	-13.40	peak	

REMARKS:

- (1) Measurement Value = Reading Level + Correct Factor.
- (2) Margin Level = Measurement Value - Limit Value.



Test Mode	NB-IOT Band 4	Test Date	2020/11/10
Test Channel	CH20392	Polarization	Vertical
Temp	23°C	Hum.	64%
Modulation Type	QPSK	Sub-carrier Spacing	15KHz

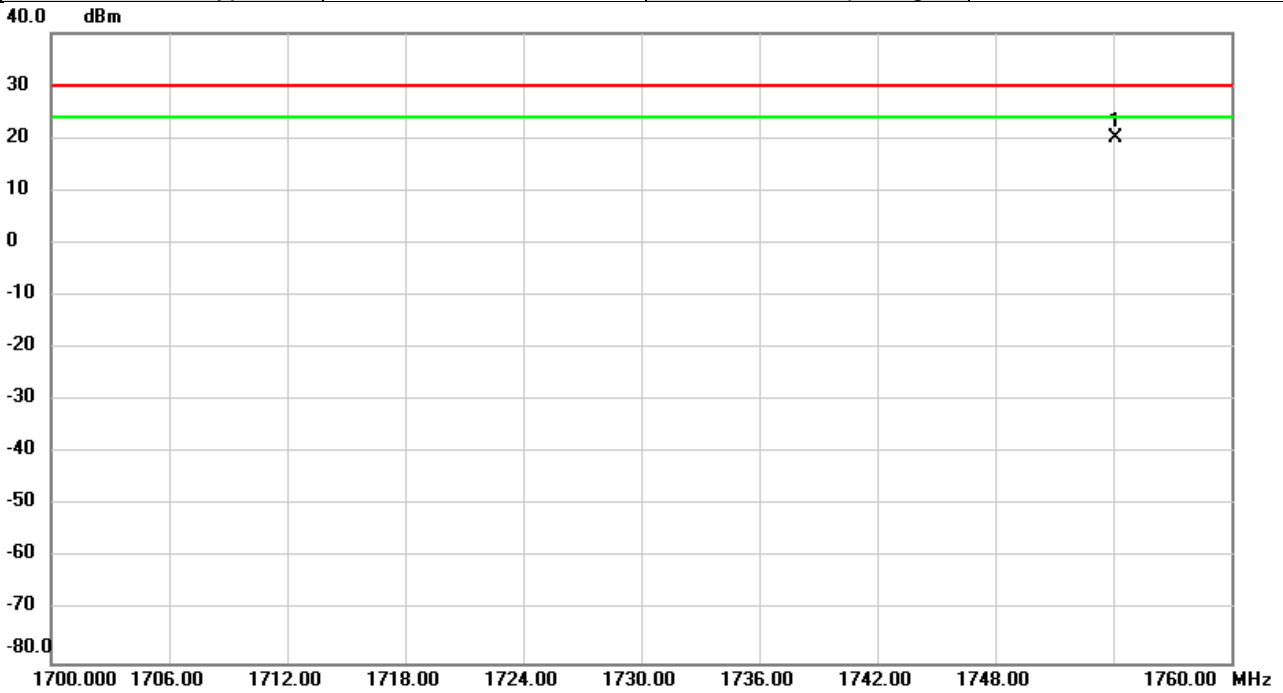

No.	Mk.	Freq. MHz	Reading Level dBm	Correct Factor dB	Measure- ment dBm	Limit dBm	Over dB	Detector	Comment
1	*	1754.146	26.65	-6.64	20.01	30.00	-9.99	peak	

**REMARKS:**

- (1) Measurement Value = Reading Level + Correct Factor.
- (2) Margin Level = Measurement Value - Limit Value.

Test Mode	NB-IOT Band 4	Test Date	2020/11/10
Test Channel	CH20392	Polarization	Horizontal
Temp	23°C	Hum.	64%
Modulation Type	QPSK	Sub-carrier Spacing	15KHz

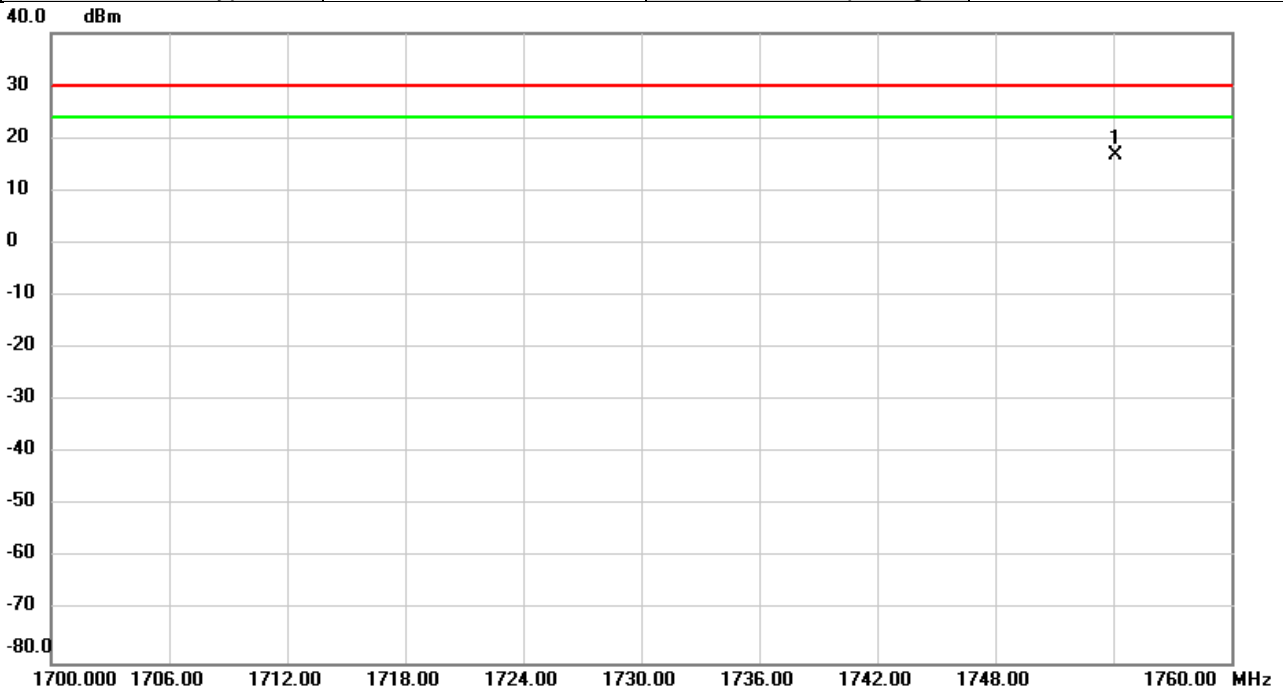

No.	Mk.	Freq.	Reading Level	Correct Factor	Measurement	Limit	Over	Detector	Comment
		MHz	dBm	dB	dBm	dBm	dB		
1	*	1754.140	24.39	-7.57	16.82	30.00	-13.18	peak	

REMARKS:

- (1) Measurement Value = Reading Level + Correct Factor.
- (2) Margin Level = Measurement Value - Limit Value.

Test Mode	NB-IOT Band 4	Test Date	2020/11/10
Test Channel	CH19957	Polarization	Vertical
Temp	23°C	Hum.	64%
Modulation Type	QPSK	Sub-carrier Spacing	3.75KHz

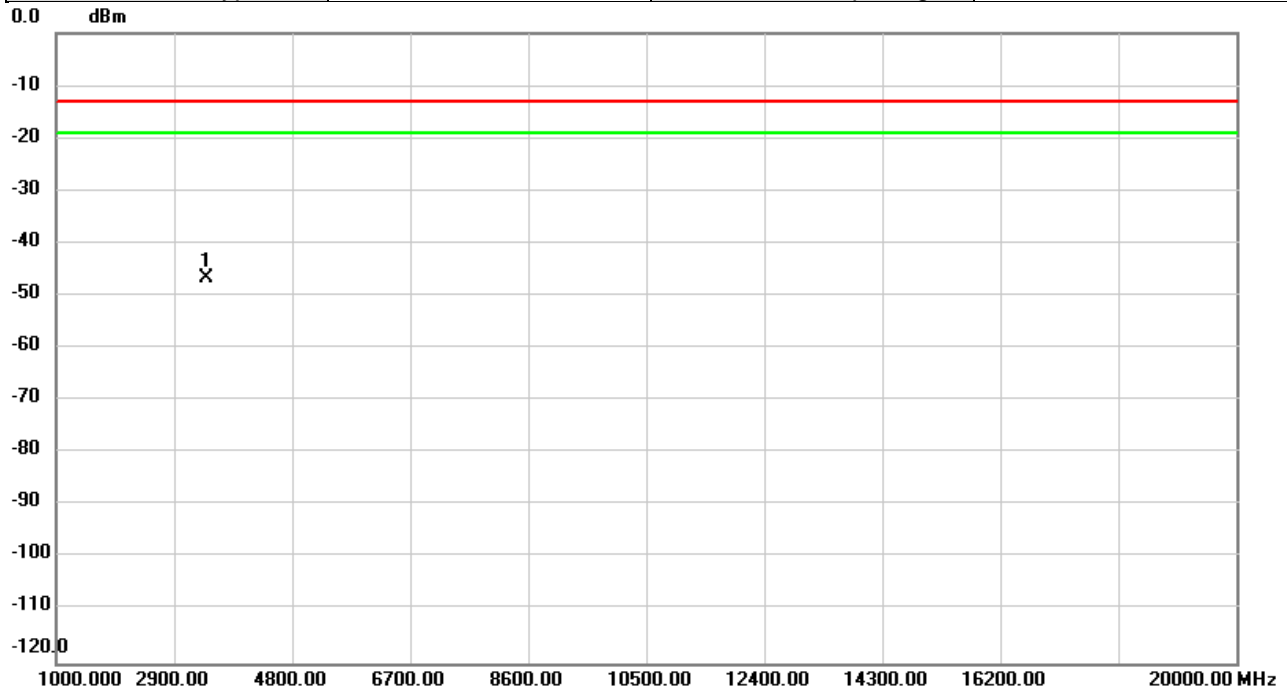

No.	Mk.	Freq.	Reading Level	Correct Factor	Measurement	Limit	Over	Detector	Comment
		MHz	dBm	dB	dBm	dBm	dB		
1	*	3421.233	-44.08	-2.43	-46.51	-13.00	-33.51	peak	

REMARKS:

- (1) Measurement Value = Reading Level + Correct Factor.
- (2) Margin Level = Measurement Value - Limit Value.

Test Mode	NB-IOT Band 4	Test Date	2020/11/10
Test Channel	CH19957	Polarization	Horizontal
Temp	23°C	Hum.	64%
Modulation Type	QPSK	Sub-carrier Spacing	3.75KHz

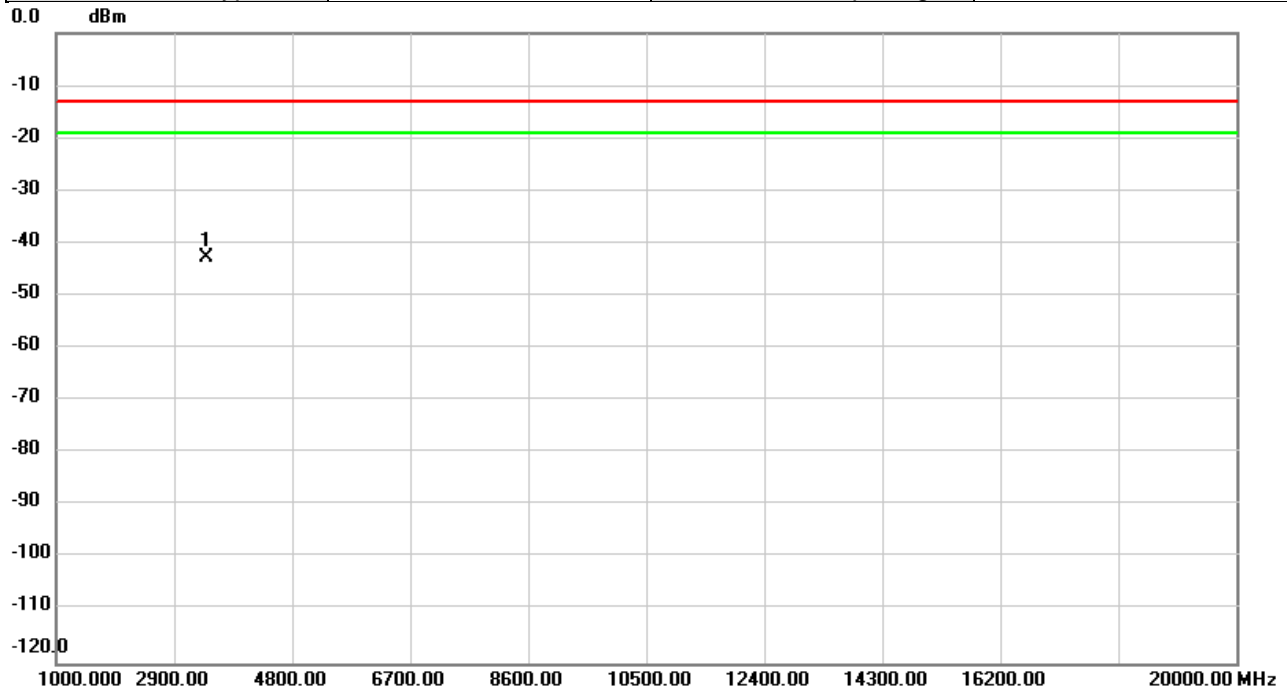

No.	Mk.	Freq.	Reading Level	Correct Factor	Measurement	Limit	Over	Detector	Comment
		MHz	dBm	dB	dBm	dBm	dB		
1	*	3421.233	-40.45	-2.21	-42.66	-13.00	-29.66	peak	

REMARKS:

- (1) Measurement Value = Reading Level + Correct Factor.
- (2) Margin Level = Measurement Value - Limit Value.

Test Mode	NB-IOT Band 4	Test Date	2020/11/10
Test Channel	CH19957	Polarization	Vertical
Temp	23°C	Hum.	64%
Modulation Type	QPSK	Sub-carrier Spacing	15KHz

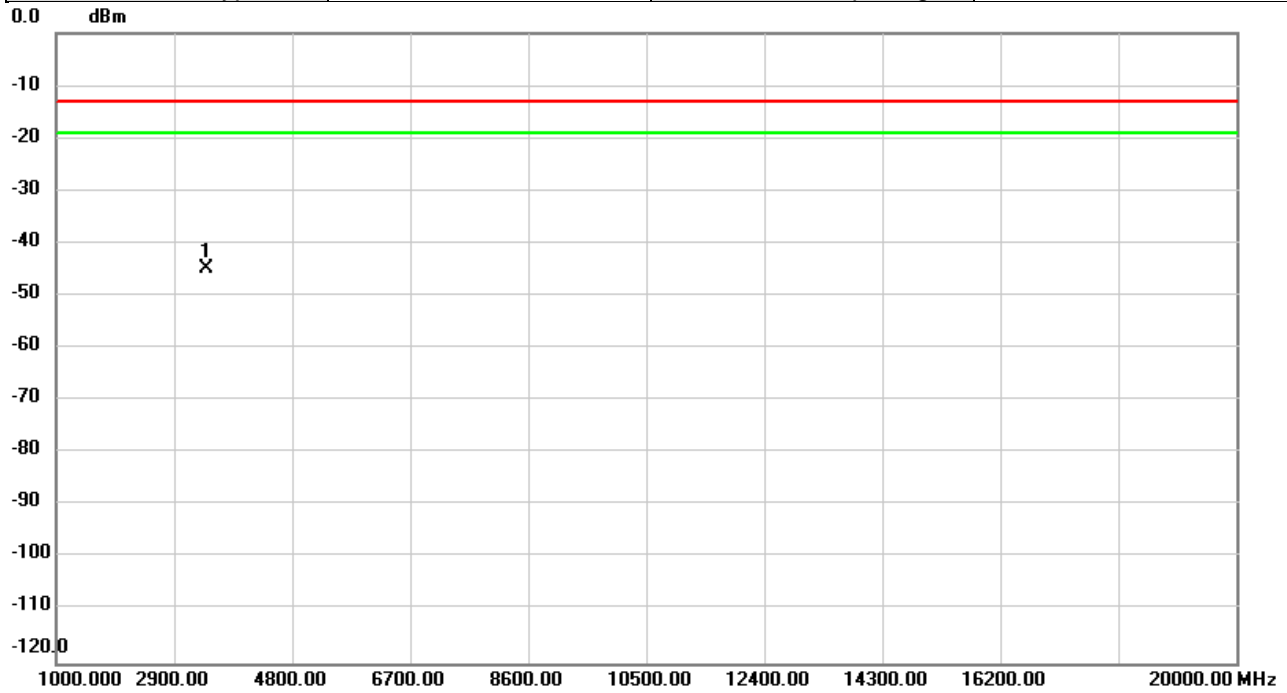

No.	Mk.	Freq.	Reading Level	Correct Factor	Measurement	Limit	Over	Detector	Comment
		MHz	dBm	dB	dBm	dBm	dB		
1	*	3421.233	-42.46	-2.43	-44.89	-13.00	-31.89	peak	

REMARKS:

- (1) Measurement Value = Reading Level + Correct Factor.
- (2) Margin Level = Measurement Value - Limit Value.

Test Mode	NB-IOT Band 4	Test Date	2020/11/10
Test Channel	CH19957	Polarization	Horizontal
Temp	23°C	Hum.	64%
Modulation Type	QPSK	Sub-carrier Spacing	15KHz

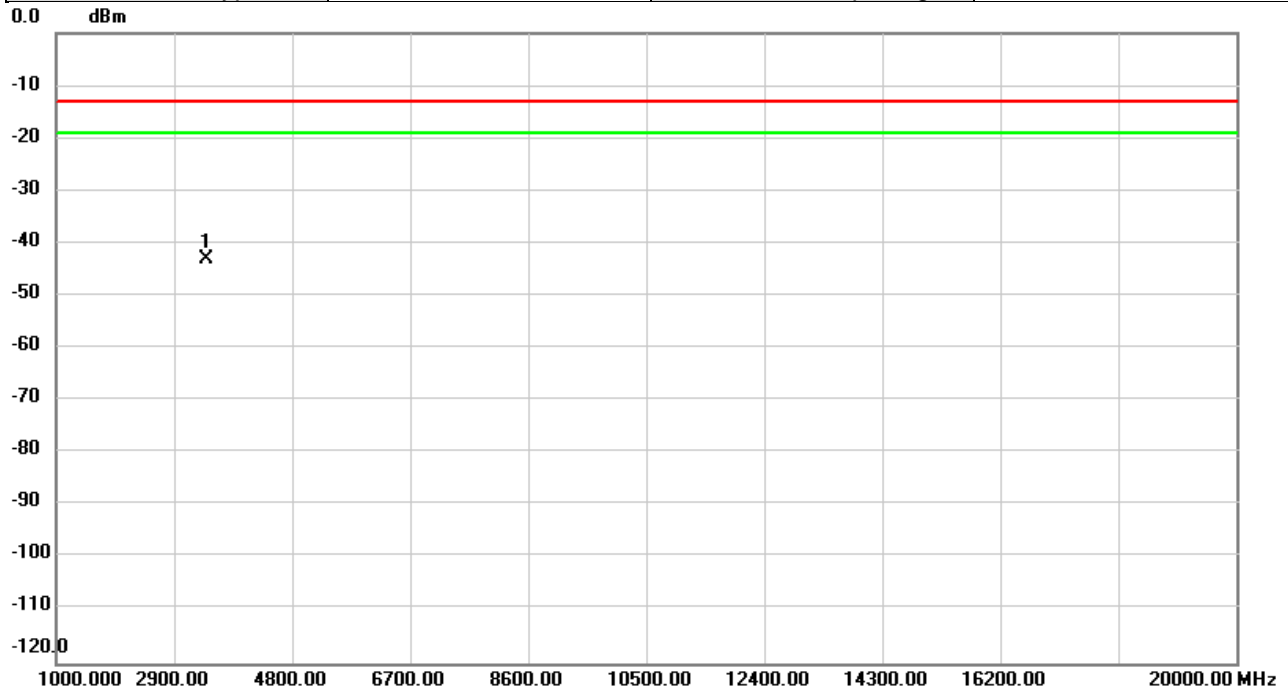

No.	Mk.	Freq.	Reading Level	Correct Factor	Measurement	Limit	Over	Detector	Comment
		MHz	dBm	dB	dBm	dBm	dB		
1	*	3421.867	-40.93	-2.20	-43.13	-13.00	-30.13	peak	

REMARKS:

- (1) Measurement Value = Reading Level + Correct Factor.
- (2) Margin Level = Measurement Value - Limit Value.

Test Mode	NB-IOT Band 4	Test Date	2020/11/10
Test Channel	CH20175	Polarization	Vertical
Temp	23°C	Hum.	64%
Modulation Type	QPSK	Sub-carrier Spacing	3.75KHz

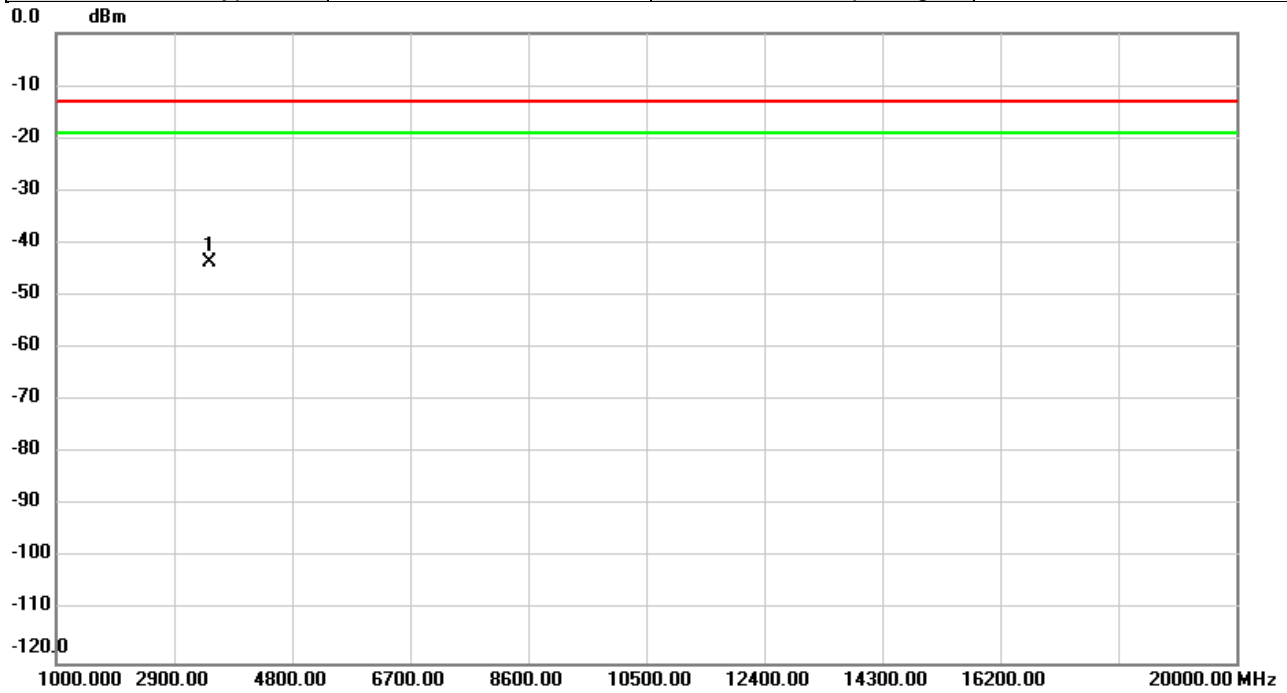

No.	Mk.	Freq.	Reading Level	Correct Factor	Measurement	Limit	Over	Detector	Comment
		MHz	dBm	dB	dBm	dBm	dB		
1	*	3464.933	-41.59	-1.99	-43.58	-13.00	-30.58	peak	

REMARKS:

- (1) Measurement Value = Reading Level + Correct Factor.
- (2) Margin Level = Measurement Value - Limit Value.

Test Mode	NB-IOT Band 4	Test Date	2020/11/10
Test Channel	CH20175	Polarization	Horizontal
Temp	23°C	Hum.	64%
Modulation Type	QPSK	Sub-carrier Spacing	3.75KHz

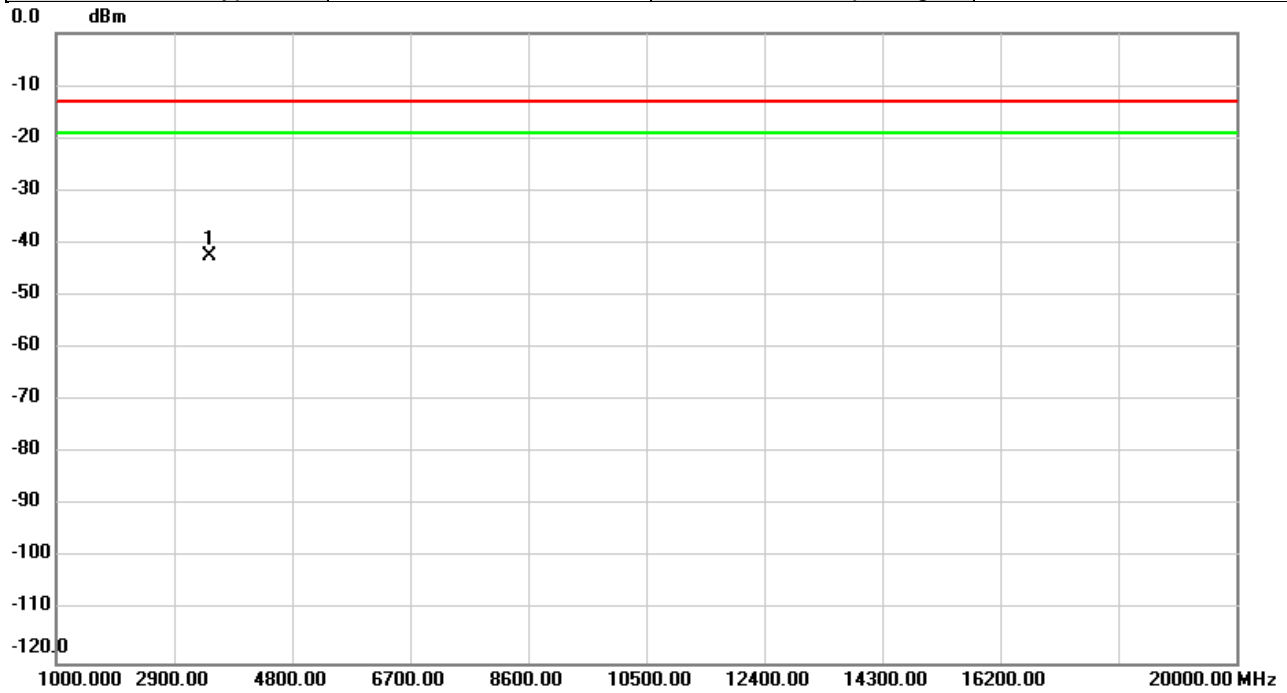

No.	Mk.	Freq. MHz	Reading Level dBm	Correct Factor dB	Measure- ment dBm	Limit dBm	Over dB	Detector	Comment
1	*	3464.933	-40.53	-1.91	-42.44	-13.00	-29.44	peak	

REMARKS:

- (1) Measurement Value = Reading Level + Correct Factor.
- (2) Margin Level = Measurement Value - Limit Value.



Test Mode	NB-IOT Band 4	Test Date	2020/11/10
Test Channel	CH20175	Polarization	Vertical
Temp	23°C	Hum.	64%
Modulation Type	QPSK	Sub-carrier Spacing	15KHz

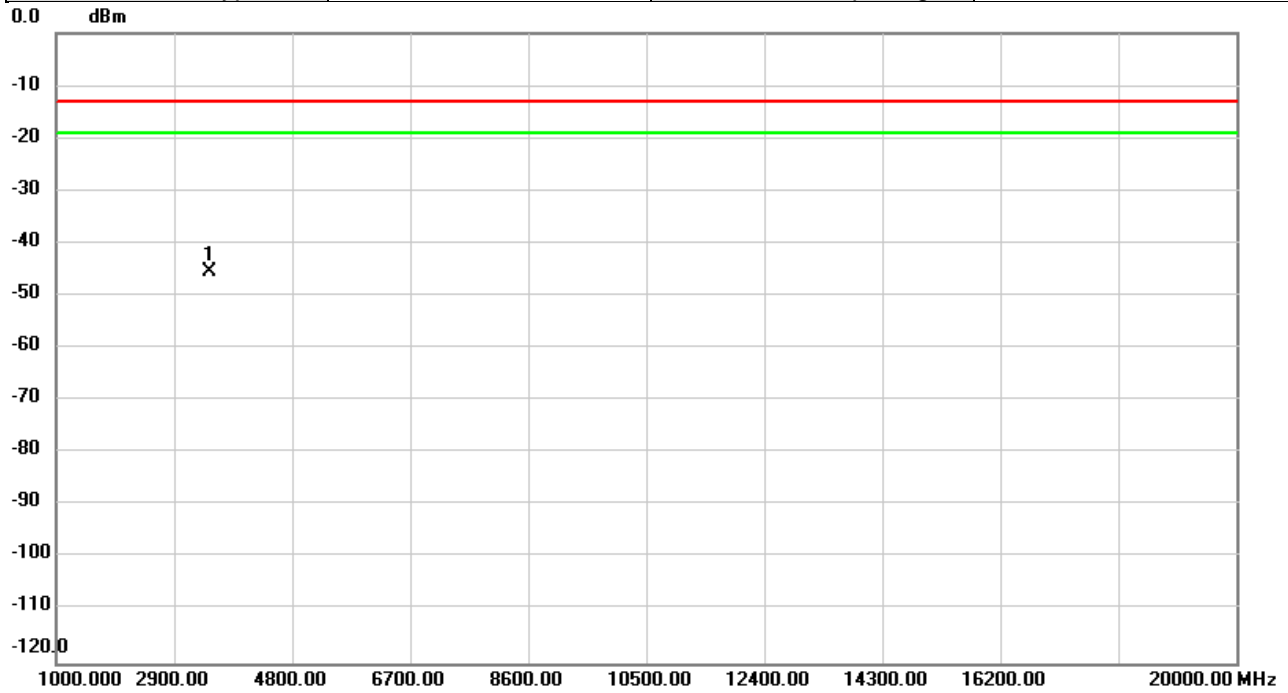

No.	Mk.	Freq.	Reading Level	Correct Factor	Measurement	Limit	Over	Detector	Comment
		MHz	dBm	dB	dBm	dBm	dB		
1	*	3464.933	-43.42	-1.99	-45.41	-13.00	-32.41	peak	

REMARKS:

- (1) Measurement Value = Reading Level + Correct Factor.
- (2) Margin Level = Measurement Value - Limit Value.

Test Mode	NB-IOT Band 4	Test Date	2020/11/10
Test Channel	CH20175	Polarization	Horizontal
Temp	23°C	Hum.	64%
Modulation Type	QPSK	Sub-carrier Spacing	15KHz

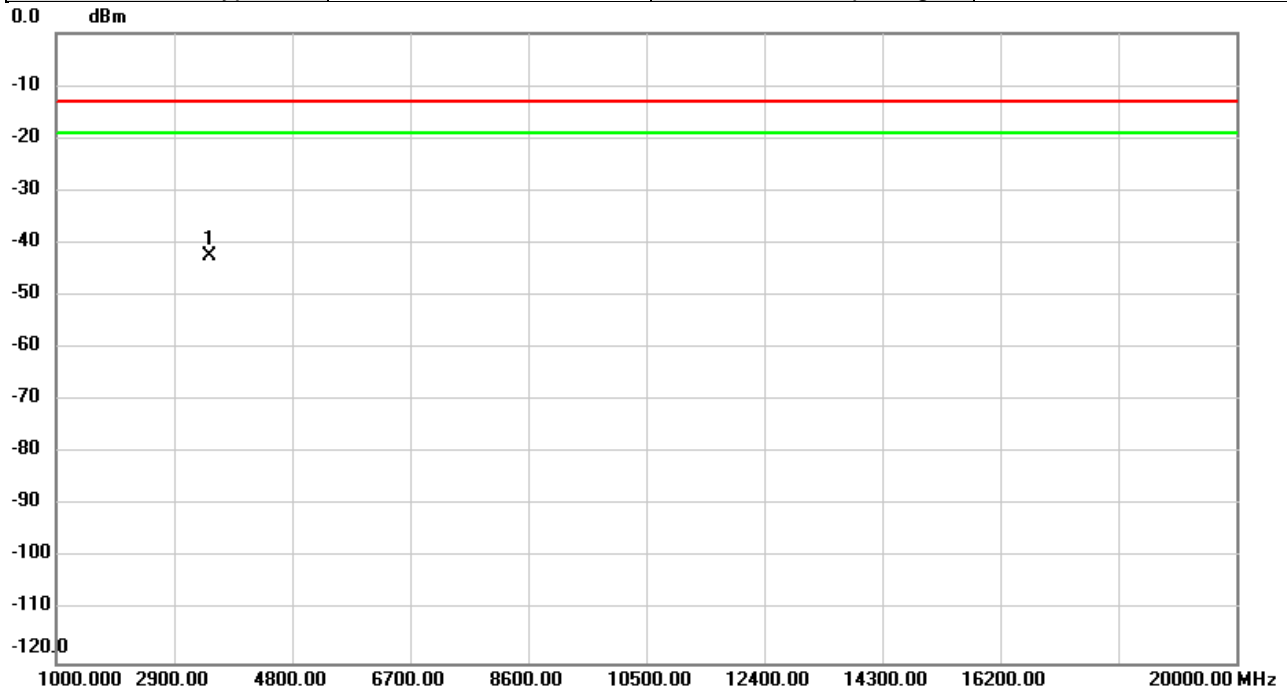

No.	Mk.	Freq. MHz	Reading Level dBm	Correct Factor dB	Measure- ment dBm	Limit dBm	Over dB	Detector	Comment
1	*	3464.933	-40.53	-1.91	-42.44	-13.00	-29.44	peak	

**REMARKS:**

- (1) Measurement Value = Reading Level + Correct Factor.
- (2) Margin Level = Measurement Value - Limit Value.

Test Mode	NB-IOT Band 4	Test Date	2020/11/10
Test Channel	CH20392	Polarization	Vertical
Temp	23°C	Hum.	64%
Modulation Type	QPSK	Sub-carrier Spacing	3.75KHz

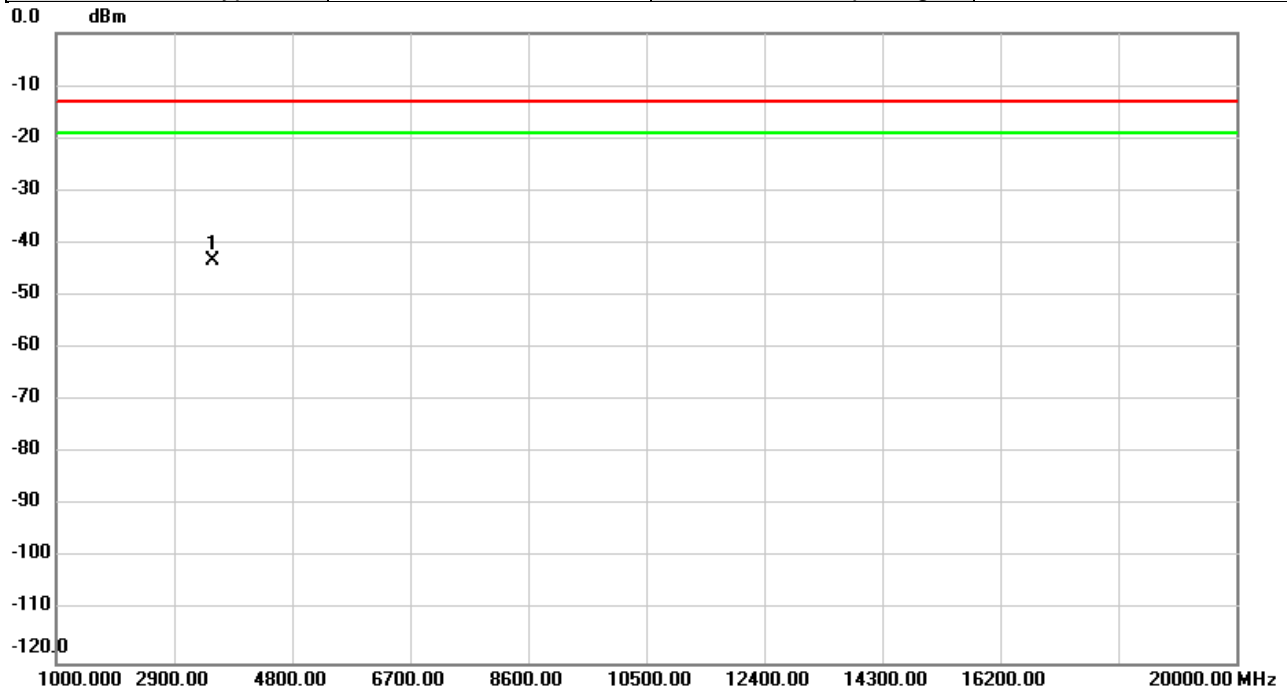

No.	Mk.	Freq.	Reading Level	Correct Factor	Measurement	Limit	Over	Detector	Comment
		MHz	dBm	dB	dBm	dBm	dB		
1	*	3508.633	-41.68	-1.61	-43.29	-13.00	-30.29	peak	

REMARKS:

- (1) Measurement Value = Reading Level + Correct Factor.
- (2) Margin Level = Measurement Value - Limit Value.

Test Mode	NB-IOT Band 4	Test Date	2020/11/10
Test Channel	CH20392	Polarization	Horizontal
Temp	23°C	Hum.	64%
Modulation Type	QPSK	Sub-carrier Spacing	3.75KHz

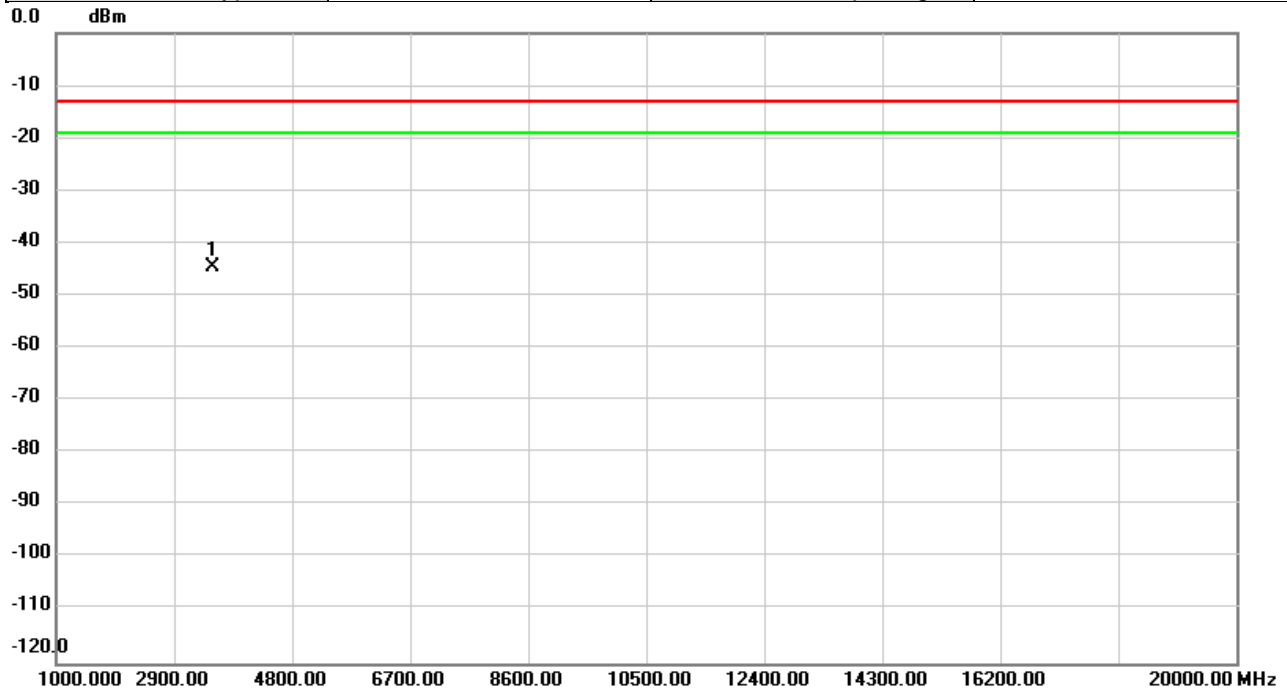

No.	Mk.	Freq.	Reading Level	Correct Factor	Measurement	Limit	Over	Detector	Comment
		MHz	dBm	dB	dBm	dBm	dB		
1	*	3510.511	-42.96	-1.52	-44.48	-13.00	-31.48	peak	

REMARKS:

- (1) Measurement Value = Reading Level + Correct Factor.
- (2) Margin Level = Measurement Value - Limit Value.

Test Mode	NB-IOT Band 4	Test Date	2020/11/10
Test Channel	CH20392	Polarization	Vertical
Temp	23°C	Hum.	64%
Modulation Type	QPSK	Sub-carrier Spacing	15KHz

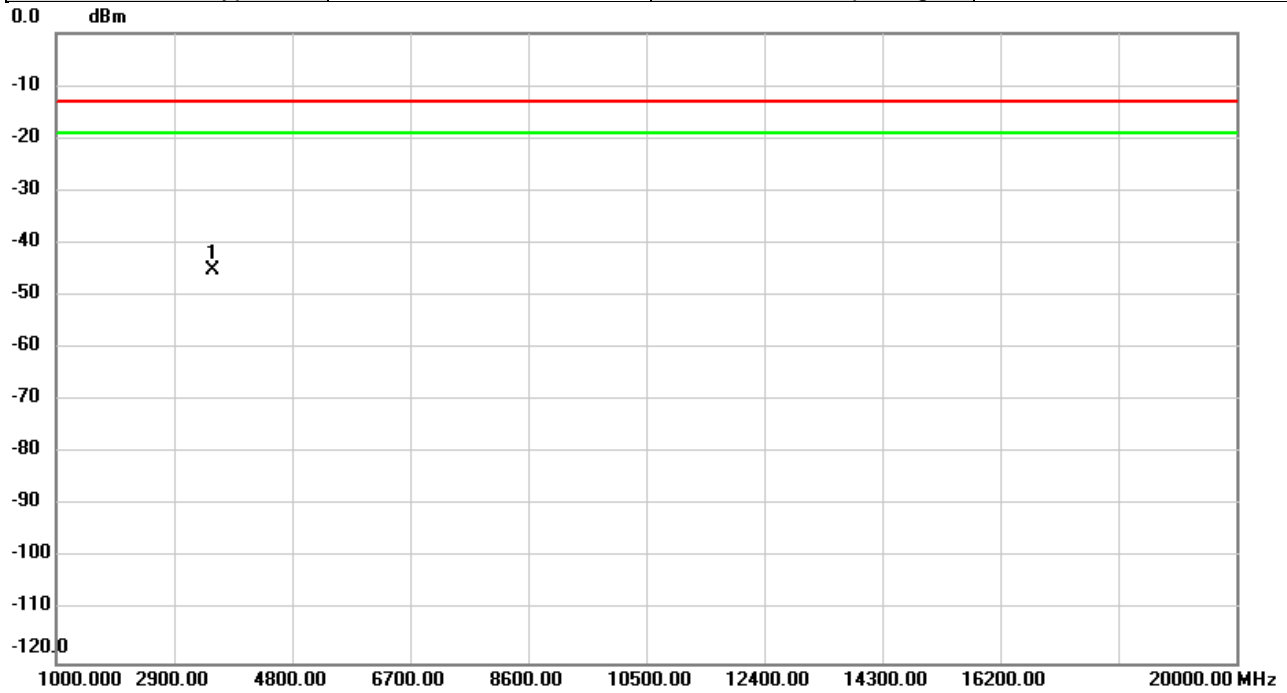

No.	Mk.	Freq.	Reading Level	Correct Factor	Measurement	Limit	Over	Detector	Comment
		MHz	dBm	dB	dBm	dBm	dB		
1	*	3508.633	-43.46	-1.61	-45.07	-13.00	-32.07	peak	

REMARKS:

- (1) Measurement Value = Reading Level + Correct Factor.
- (2) Margin Level = Measurement Value - Limit Value.

Test Mode	NB-IOT Band 4	Test Date	2020/11/10
Test Channel	CH20392	Polarization	Horizontal
Temp	23°C	Hum.	64%
Modulation Type	QPSK	Sub-carrier Spacing	15KHz

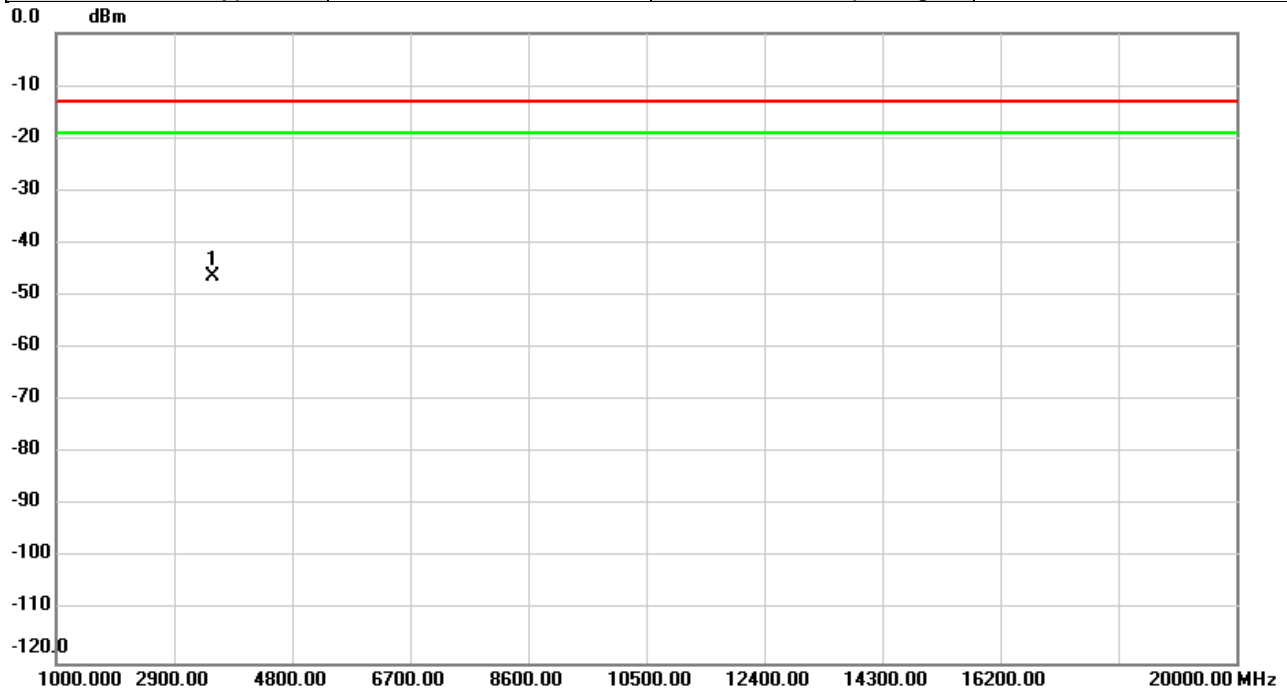

No.	Mk.	Freq.	Reading Level	Correct Factor	Measurement	Limit	Over	Detector	Comment
		MHz	dBm	dB	dBm	dBm	dB		
1	*	3508.633	-44.91	-1.53	-46.44	-13.00	-33.44	peak	

REMARKS:

- (1) Measurement Value = Reading Level + Correct Factor.
- (2) Margin Level = Measurement Value - Limit Value.

Test Mode	NB-IOT Band 4	Test Date	2020/11/10
Test Channel	CH20175	Polarization	Vertical
Temp	23°C	Hum.	64%
Modulation Type	BPSK	Sub-carrier Spacing	15KHz

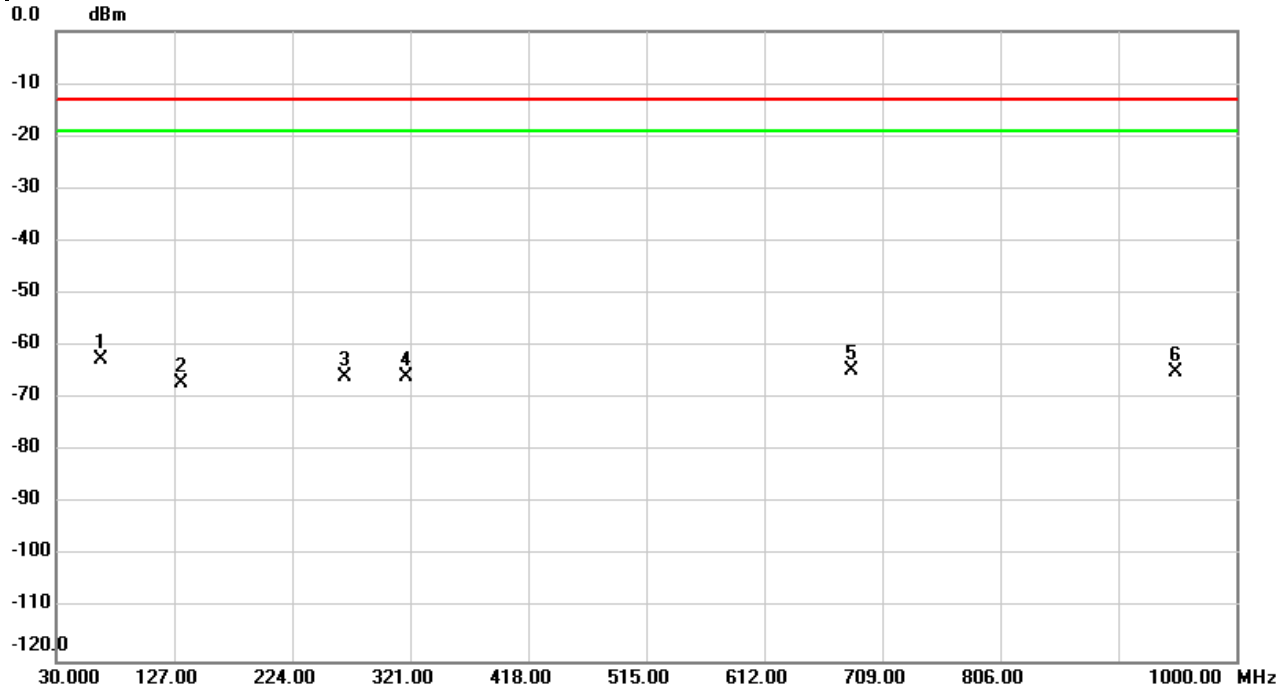

No.	Mk.	Freq.	Reading Level	Correct Factor	Measurement	Limit	Over	Detector	Comment
		MHz	dBm	dB	dBm	dBm	dB		
1	*	66.5043	-60.41	-2.04	-62.45	-13.00	-49.45	peak	
2		133.3697	-68.32	1.22	-67.10	-13.00	-54.10	peak	
3		266.9710	-73.61	7.69	-65.92	-13.00	-52.92	peak	
4		317.8960	-73.17	7.26	-65.91	-13.00	-52.91	peak	
5		683.4243	-77.40	12.67	-64.73	-13.00	-51.73	peak	
6		949.6570	-77.56	12.58	-64.98	-13.00	-51.98	peak	

REMARKS:  
 (1) Measurement Value = Reading Level + Correct Factor.  
 (2) Margin Level = Measurement Value - Limit Value.

Test Mode	NB-IOT Band 4	Test Date	2020/11/10
Test Channel	CH20175	Polarization	Horizontal
Temp	23°C	Hum.	64%
Modulation Type	BPSK	Sub-carrier Spacing	15KHz

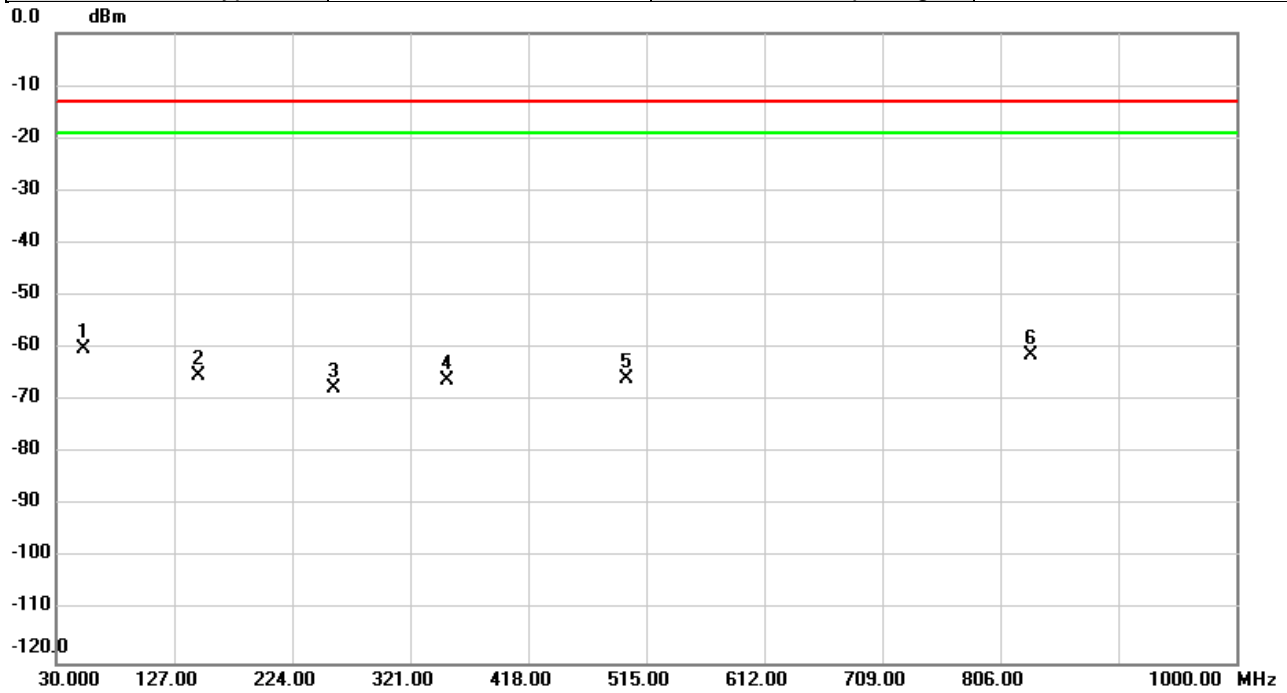

No.	Mk.	Freq. MHz	Reading Level dBm	Correct Factor dB	Measure- ment dBm	Limit dBm	Over dB	Detector	Comment
1	*	52.1160	-72.54	12.29	-60.25	-13.00	-47.25	peak	
2		146.9820	-68.09	2.84	-65.25	-13.00	-52.25	peak	
3		258.4997	-67.34	-0.43	-67.77	-13.00	-54.77	peak	
4		351.3933	-70.43	4.14	-66.29	-13.00	-53.29	peak	
5		498.8657	-76.88	10.90	-65.98	-13.00	-52.98	peak	
6		831.0260	-77.15	15.95	-61.20	-13.00	-48.20	peak	

REMARKS:  
 (1) Measurement Value = Reading Level + Correct Factor.  
 (2) Margin Level = Measurement Value - Limit Value.



Test Mode	NB-IOT Band 4	Test Date	2020/11/10
Test Channel	CH19957	Polarization	Vertical
Temp	23°C	Hum.	64%
Modulation Type	BPSK	Sub-carrier Spacing	3.75KHz

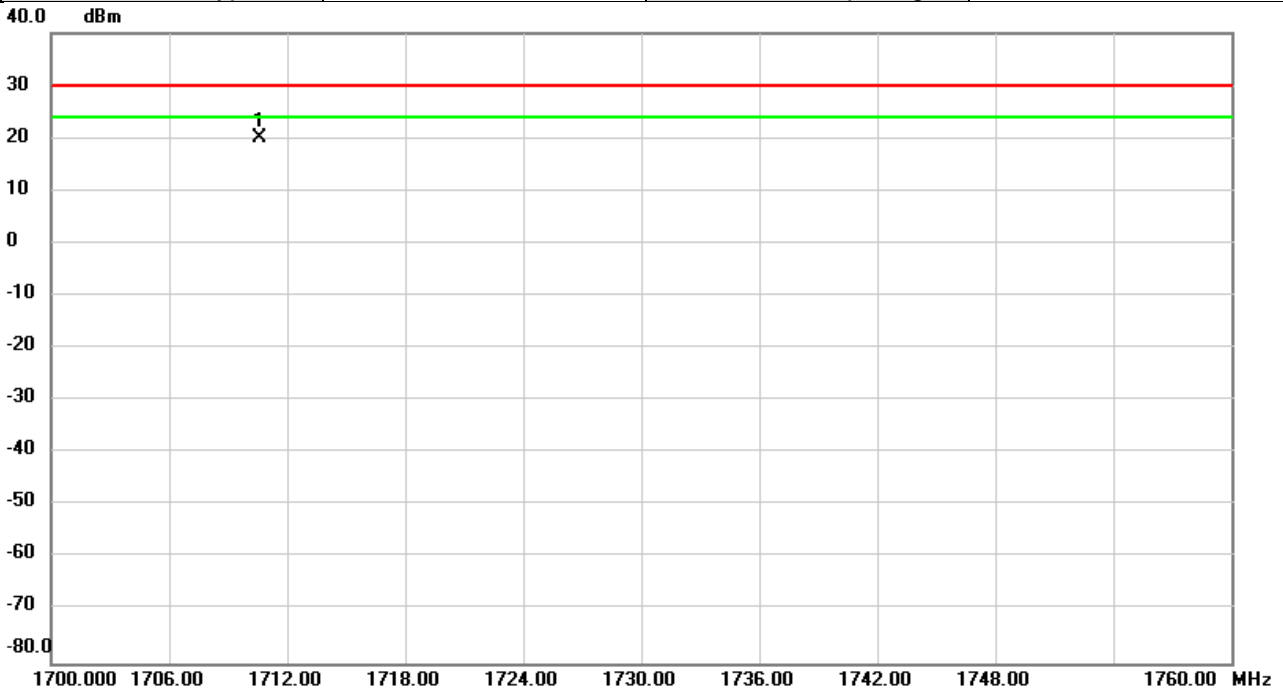

No.	Mk.	Freq.	Reading Level	Correct Factor	Measurement	Limit	Over	Detector	Comment
		MHz	dBm	dB	dBm	dBm	dB		
1	*	1710.612	26.82	-6.72	20.10	30.00	-9.90	peak	

REMARKS:

- (1) Measurement Value = Reading Level + Correct Factor.
- (2) Margin Level = Measurement Value - Limit Value.

Test Mode	NB-IOT Band 4	Test Date	2020/11/10
Test Channel	CH19957	Polarization	Horizontal
Temp	23°C	Hum.	64%
Modulation Type	BPSK	Sub-carrier Spacing	3.75KHz

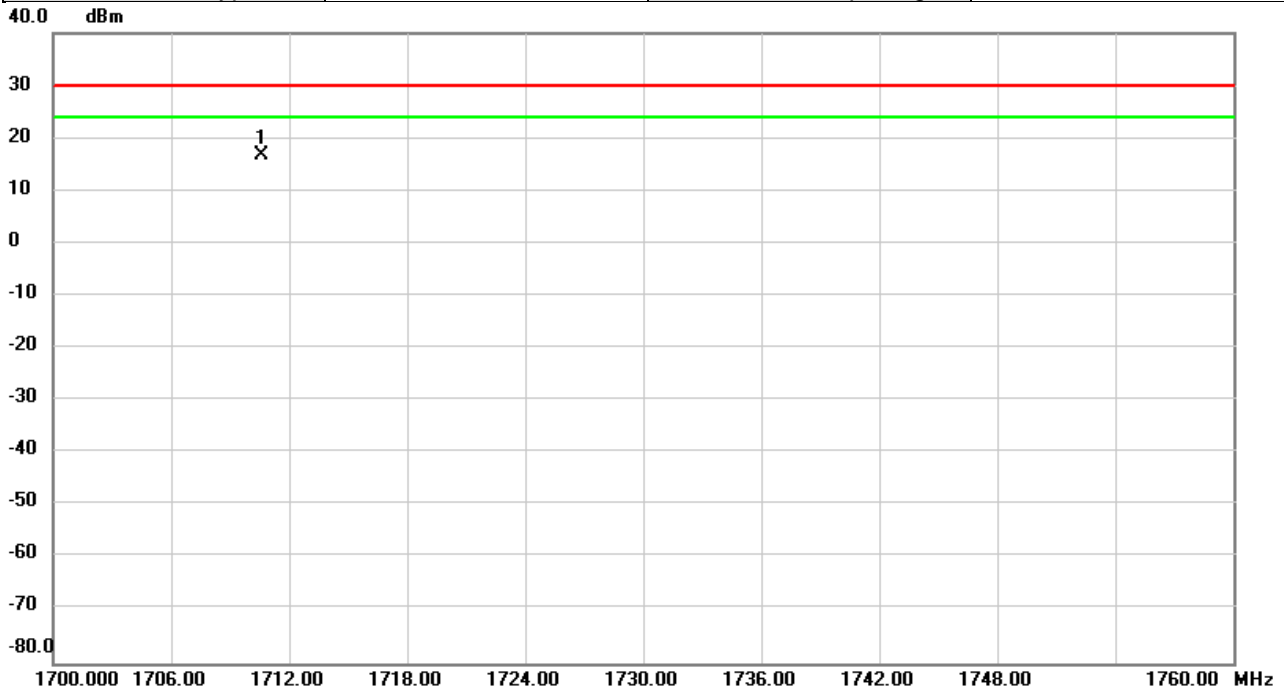

No.	Mk.	Freq.	Reading Level	Correct Factor	Measurement	Limit	Over	Detector	Comment
		MHz	dBm	dB	dBm	dBm	dB		
1	*	1710.622	24.59	-7.93	16.66	30.00	-13.34	peak	

**REMARKS:**

- (1) Measurement Value = Reading Level + Correct Factor.
- (2) Margin Level = Measurement Value - Limit Value.

Test Mode	NB-IOT Band 4	Test Date	2020/11/10
Test Channel	CH19957	Polarization	Vertical
Temp	23°C	Hum.	64%
Modulation Type	BPSK	Sub-carrier Spacing	15KHz

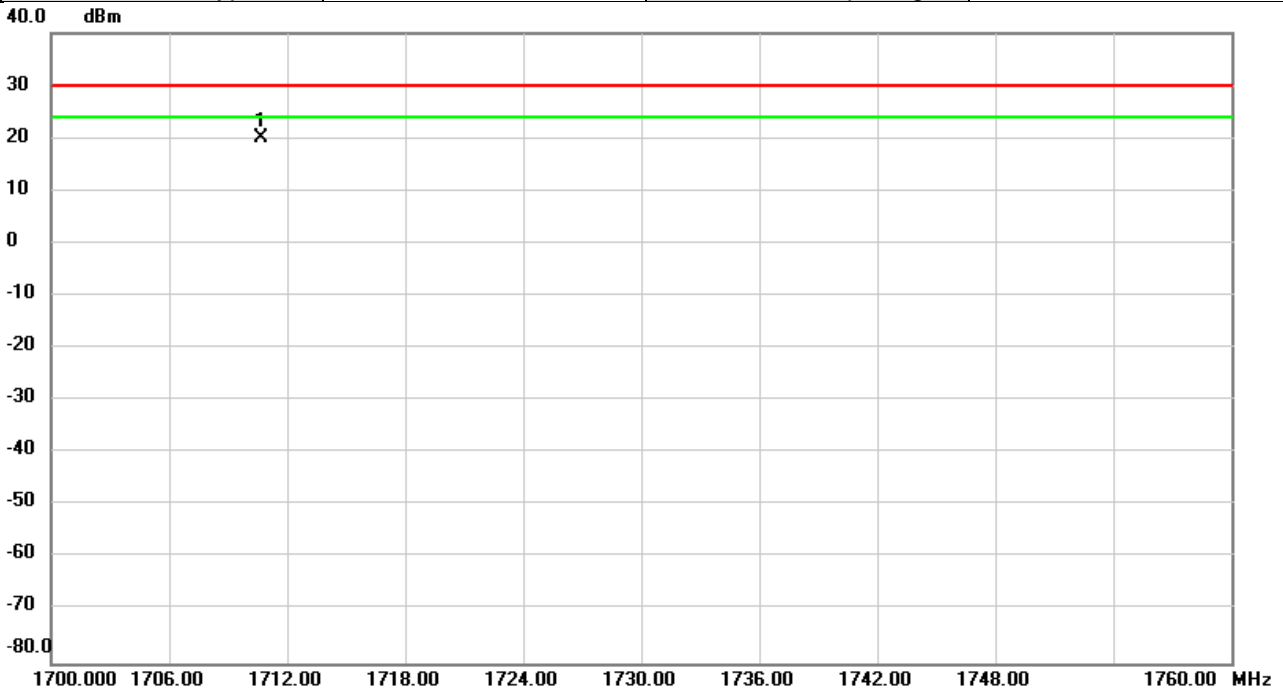

No.	Mk.	Freq.	Reading Level	Correct Factor	Measurement	Limit	Over	Detector	Comment
		MHz	dBm	dB	dBm	dBm	dB		
1	*	1710.652	26.84	-6.72	20.12	30.00	-9.88	peak	

**REMARKS:**

- (1) Measurement Value = Reading Level + Correct Factor.
- (2) Margin Level = Measurement Value - Limit Value.

Test Mode	NB-IOT Band 4	Test Date	2020/11/10
Test Channel	CH19957	Polarization	Horizontal
Temp	23°C	Hum.	64%
Modulation Type	BPSK	Sub-carrier Spacing	15KHz

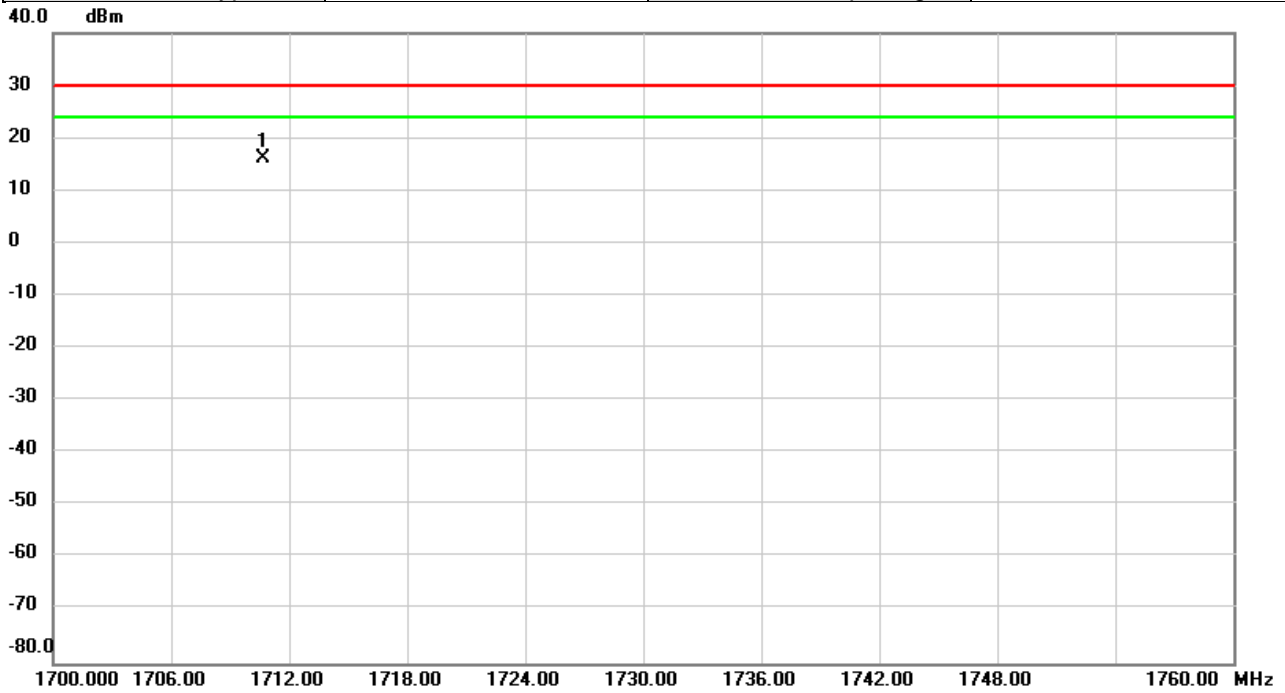

No.	Mk.	Freq.	Reading Level	Correct Factor	Measurement	Limit	Over	Detector	Comment
		MHz	dBm	dB	dBm	dBm	dB		
1	*	1710.690	24.18	-7.93	16.25	30.00	-13.75	peak	

**REMARKS:**

- (1) Measurement Value = Reading Level + Correct Factor.
- (2) Margin Level = Measurement Value - Limit Value.

Test Mode	NB-IOT Band 4	Test Date	2020/11/10
Test Channel	CH20175	Polarization	Vertical
Temp	23°C	Hum.	64%
Modulation Type	BPSK	Sub-carrier Spacing	3.75KHz

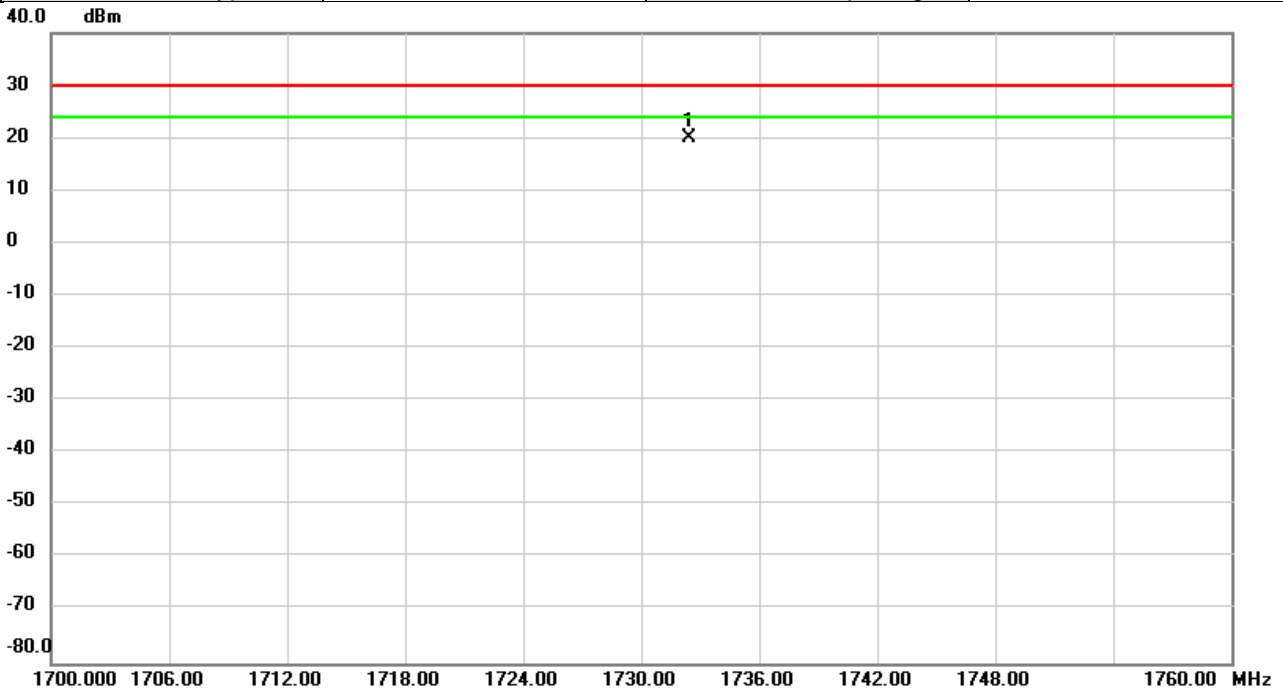

No.	Mk.	Freq.	Reading Level	Correct Factor	Measurement	Limit	Over	Detector	Comment
		MHz	dBm	dB	dBm	dBm	dB		
1	*	1732.476	26.82	-6.68	20.14	30.00	-9.86	peak	

**REMARKS:**

- (1) Measurement Value = Reading Level + Correct Factor.
- (2) Margin Level = Measurement Value - Limit Value.

Test Mode	NB-IOT Band 4	Test Date	2020/11/10
Test Channel	CH20175	Polarization	Horizontal
Temp	23°C	Hum.	64%
Modulation Type	BPSK	Sub-carrier Spacing	3.75KHz

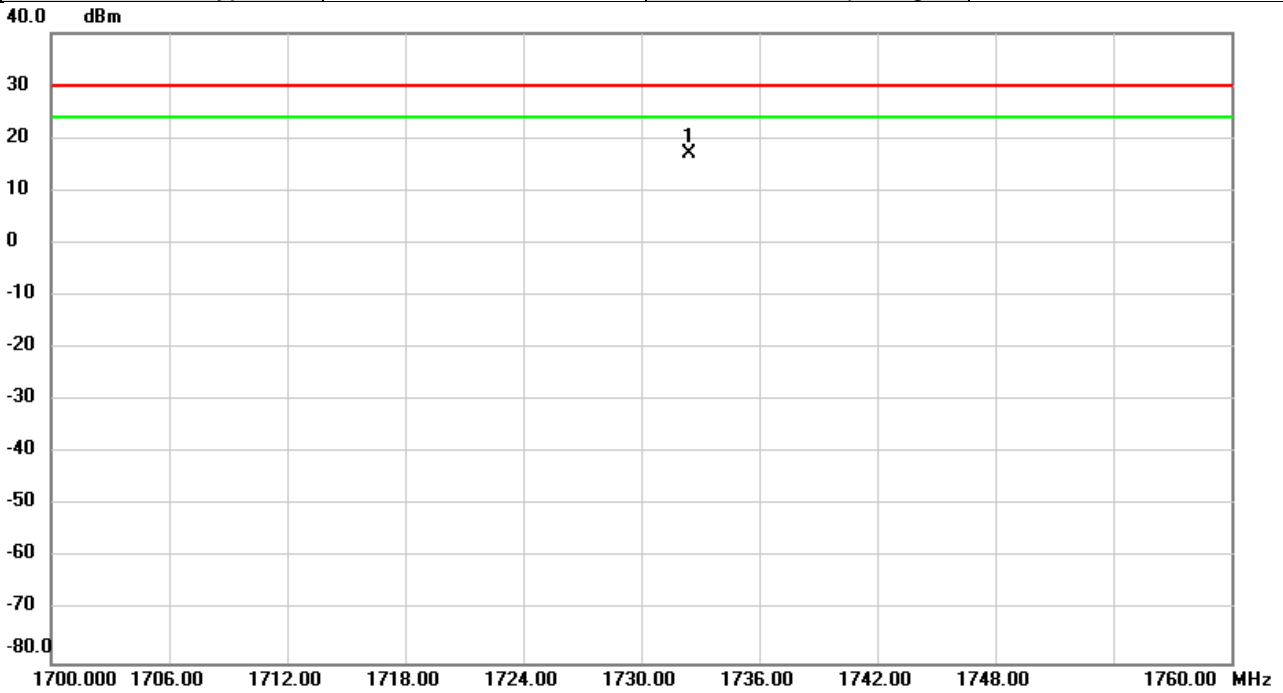

No.	Mk.	Freq.	Reading Level	Correct Factor	Measurement	Limit	Over	Detector	Comment
		MHz	dBm	dB	dBm	dBm	dB		
1	*	1732.410	24.84	-7.76	17.08	30.00	-12.92	peak	

**REMARKS:**

- (1) Measurement Value = Reading Level + Correct Factor.
- (2) Margin Level = Measurement Value - Limit Value.

Test Mode	NB-IOT Band 4	Test Date	2020/11/10
Test Channel	CH20175	Polarization	Vertical
Temp	23°C	Hum.	64%
Modulation Type	BPSK	Sub-carrier Spacing	15KHz

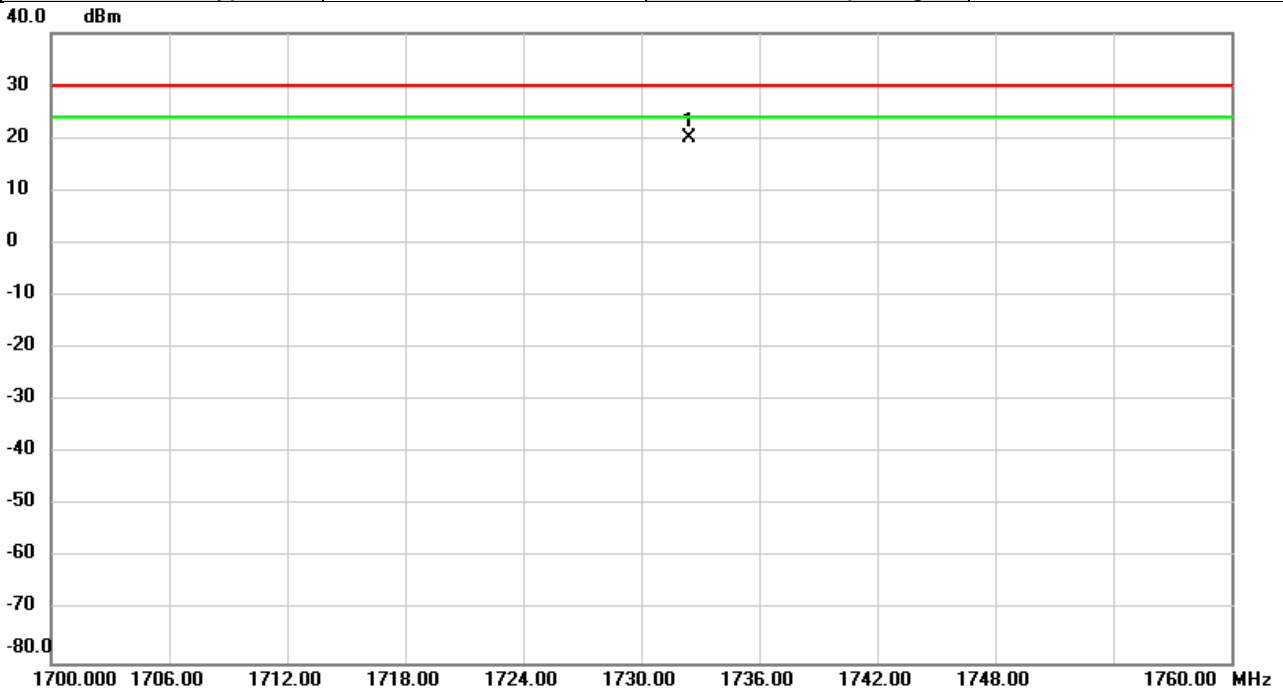

No.	Mk.	Freq.	Reading Level	Correct Factor	Measurement	Limit	Over	Detector	Comment
		MHz	dBm	dB	dBm	dBm	dB		
1	*	1732.458	26.77	-6.68	20.09	30.00	-9.91	peak	

REMARKS:

- (1) Measurement Value = Reading Level + Correct Factor.
- (2) Margin Level = Measurement Value - Limit Value.

Test Mode	NB-IOT Band 4	Test Date	2020/11/10
Test Channel	CH20175	Polarization	Horizontal
Temp	23°C	Hum.	64%
Modulation Type	BPSK	Sub-carrier Spacing	15KHz

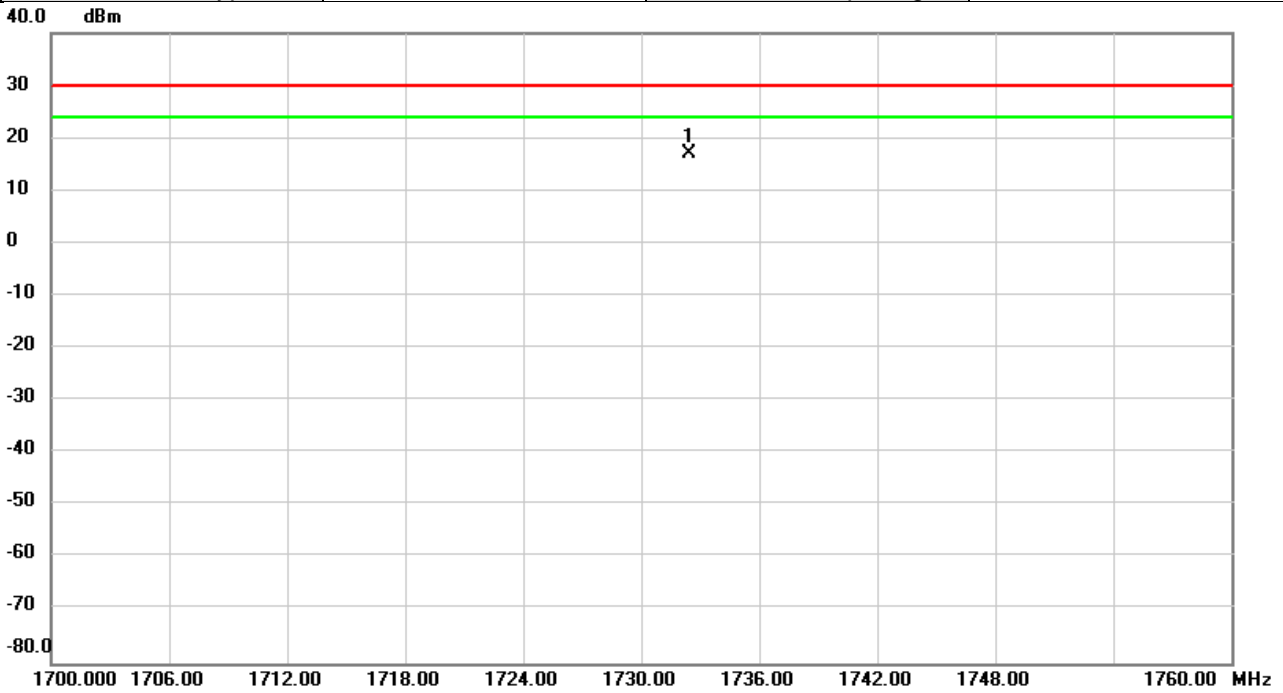

No.	Mk.	Freq.	Reading Level	Correct Factor	Measurement	Limit	Over	Detector	Comment
		MHz	dBm	dB	dBm	dBm	dB		
1	*	1732.470	24.81	-7.76	17.05	30.00	-12.95	peak	

**REMARKS:**

- (1) Measurement Value = Reading Level + Correct Factor.
- (2) Margin Level = Measurement Value - Limit Value.



Test Mode	NB-IOT Band 4	Test Date	2020/11/10
Test Channel	CH20392	Polarization	Vertical
Temp	23°C	Hum.	64%
Modulation Type	BPSK	Sub-carrier Spacing	3.75KHz

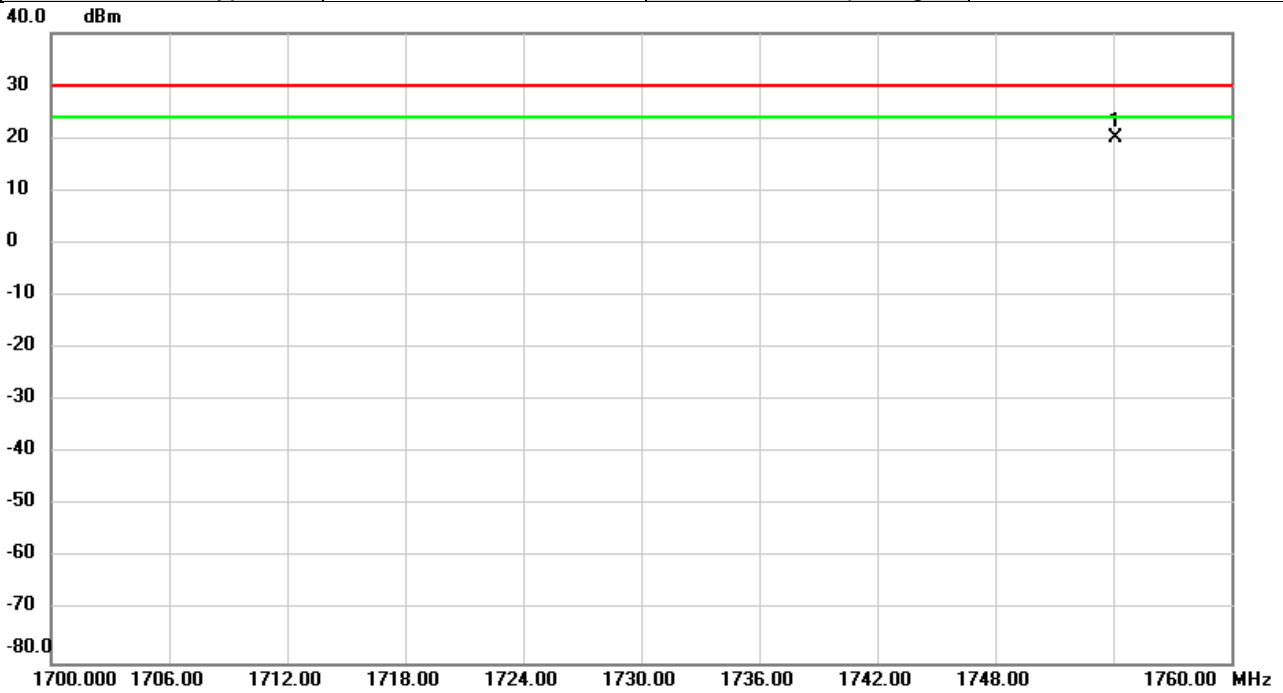

No.	Mk.	Freq.	Reading Level	Correct Factor	Measurement	Limit	Over	Detector	Comment
		MHz	dBm	dB	dBm	dBm	dB		
1	*	1754.144	26.69	-6.64	20.05	30.00	-9.95	peak	

**REMARKS:**

- (1) Measurement Value = Reading Level + Correct Factor.
- (2) Margin Level = Measurement Value - Limit Value.

Test Mode	NB-IOT Band 4	Test Date	2020/11/10
Test Channel	CH20392	Polarization	Horizontal
Temp	23°C	Hum.	64%
Modulation Type	BPSK	Sub-carrier Spacing	3.75KHz

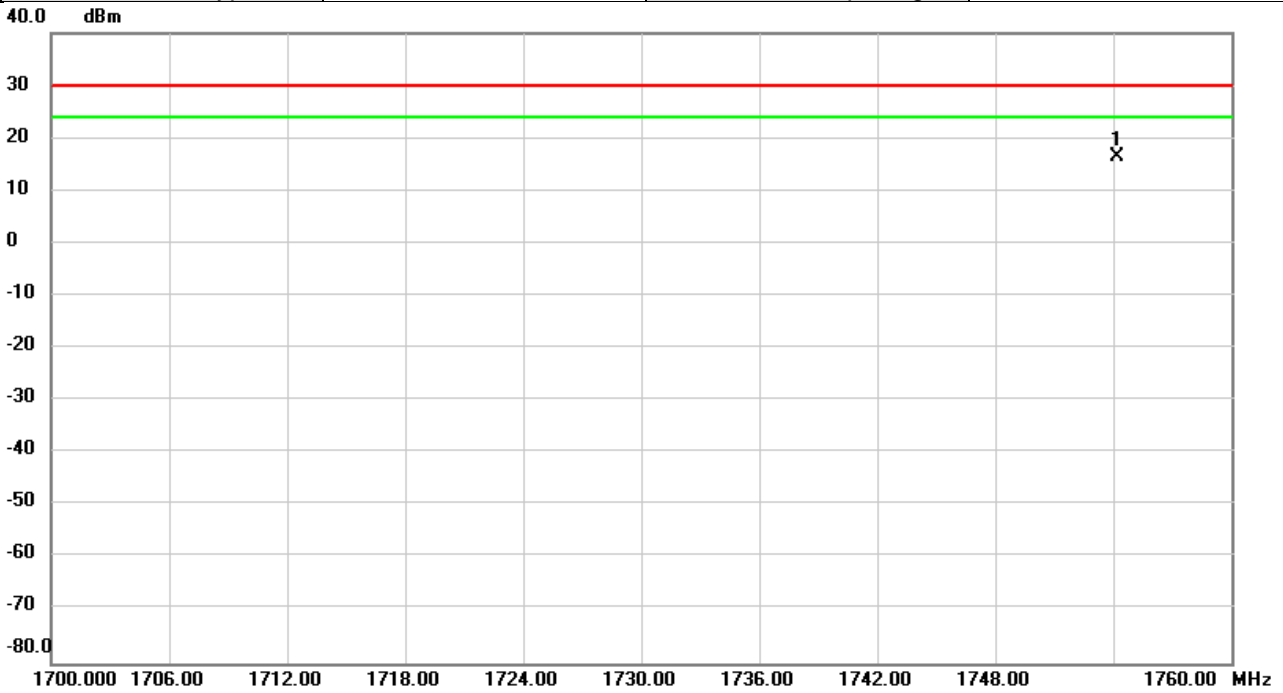

No.	Mk.	Freq.	Reading Level	Correct Factor	Measurement	Limit	Over	Detector	Comment
		MHz	dBm	dB	dBm	dBm	dB		
1	*	1754.194	24.06	-7.57	16.49	30.00	-13.51	peak	

**REMARKS:**

- (1) Measurement Value = Reading Level + Correct Factor.
- (2) Margin Level = Measurement Value - Limit Value.

Test Mode	NB-IOT Band 4	Test Date	2020/11/10
Test Channel	CH20392	Polarization	Vertical
Temp	23°C	Hum.	64%
Modulation Type	BPSK	Sub-carrier Spacing	15KHz

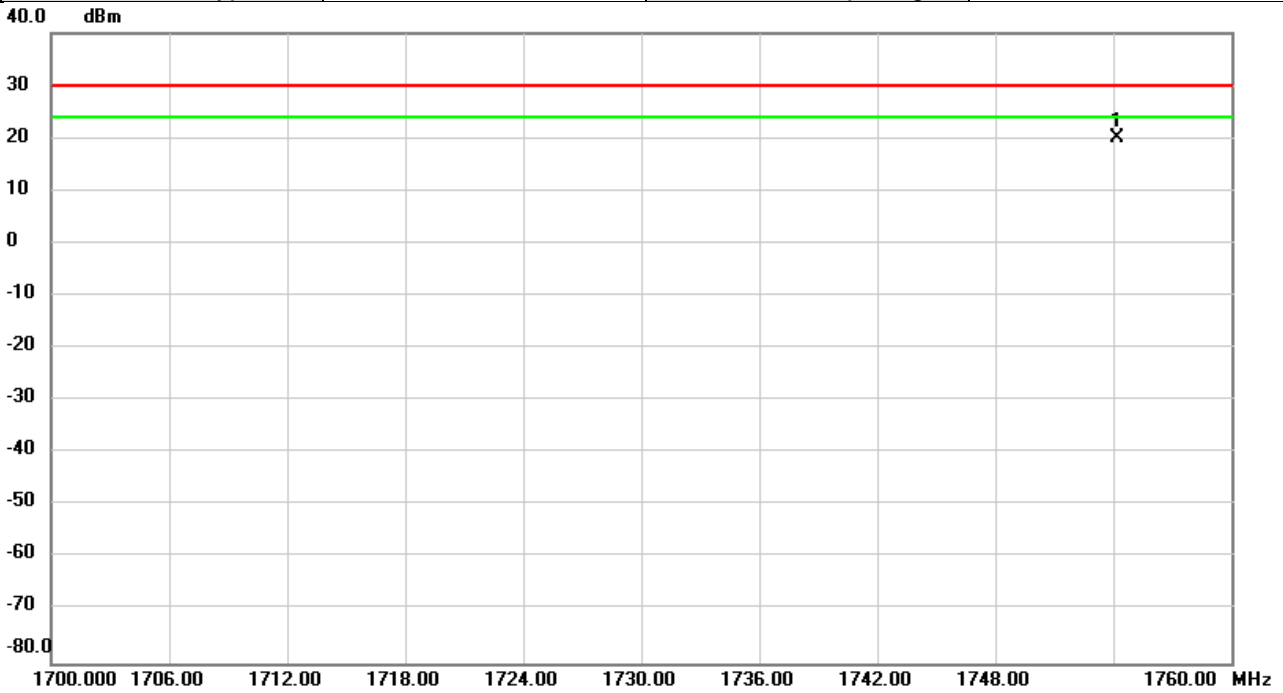

No.	Mk.	Freq.	Reading Level	Correct Factor	Measurement	Limit	Over	Detector	Comment
		MHz	dBm	dB	dBm	dBm	dB		
1	*	1754.184	26.64	-6.64	20.00	30.00	-10.00	peak	

**REMARKS:**

- (1) Measurement Value = Reading Level + Correct Factor.
- (2) Margin Level = Measurement Value - Limit Value.

Test Mode	NB-IOT Band 4	Test Date	2020/11/10
Test Channel	CH20392	Polarization	Horizontal
Temp	23°C	Hum.	64%
Modulation Type	BPSK	Sub-carrier Spacing	15KHz

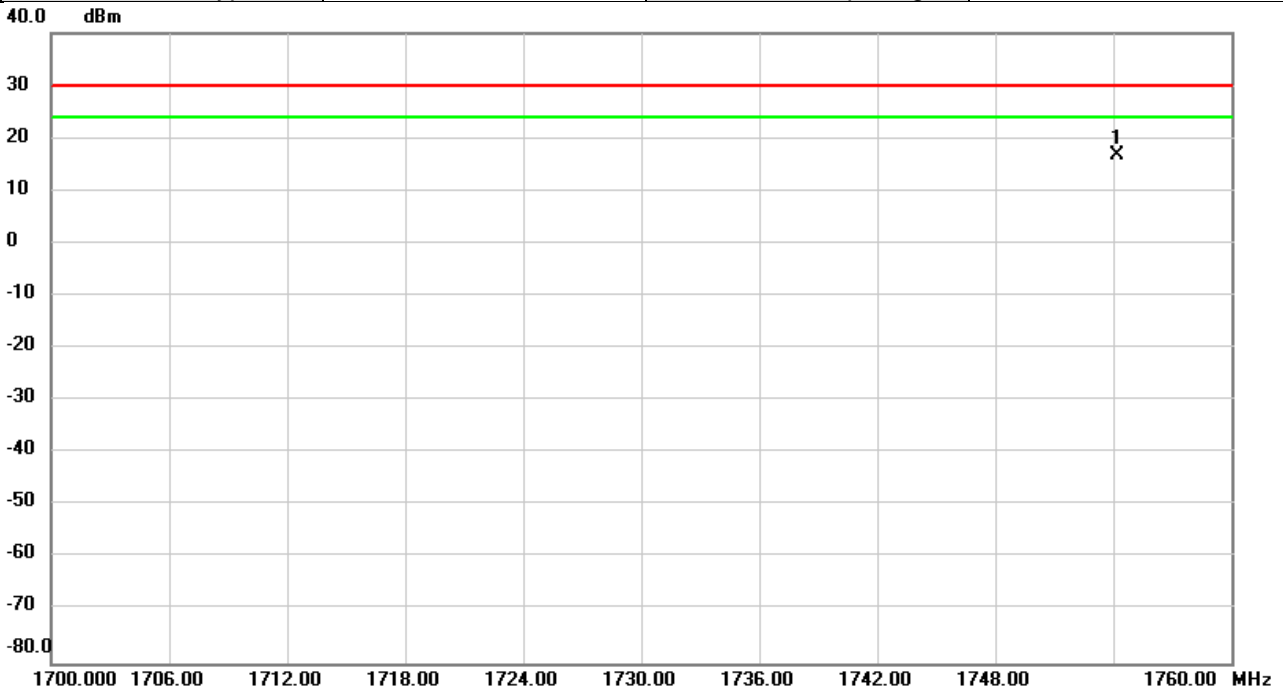

No.	Mk.	Freq. MHz	Reading Level dBm	Correct Factor dB	Measure- ment dBm	Limit dBm	Over dB	Detector	Comment
1	*	1754.216	24.40	-7.57	16.83	30.00	-13.17	peak	

**REMARKS:**

- (1) Measurement Value = Reading Level + Correct Factor.
- (2) Margin Level = Measurement Value - Limit Value.

Test Mode	NB-IOT Band 4	Test Date	2020/11/10
Test Channel	CH19957	Polarization	Vertical
Temp	23°C	Hum.	64%
Modulation Type	BPSK	Sub-carrier Spacing	3.75KHz

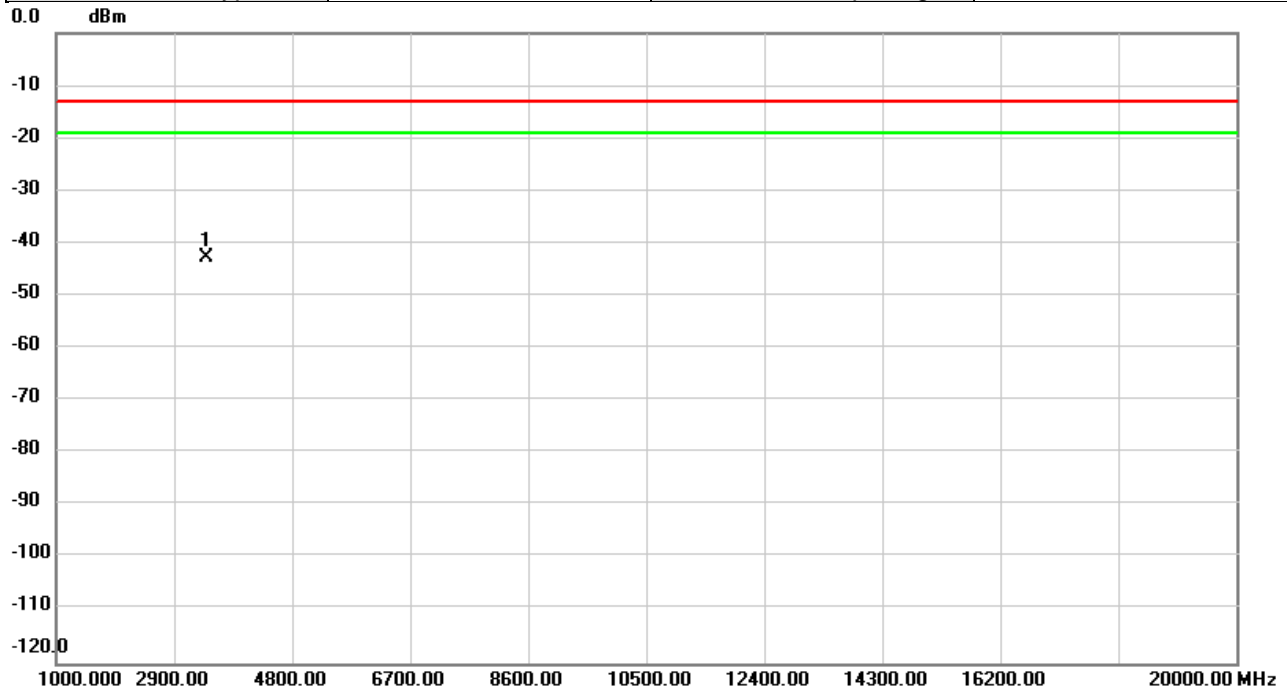

No.	Mk.	Freq.	Reading Level	Correct Factor	Measurement	Limit	Over	Detector	Comment
		MHz	dBm	dB	dBm	dBm	dB		
1	*	3421.233	-40.27	-2.43	-42.70	-13.00	-29.70	peak	

REMARKS:

- (1) Measurement Value = Reading Level + Correct Factor.
- (2) Margin Level = Measurement Value - Limit Value.

Test Mode	NB-IOT Band 4	Test Date	2020/11/10
Test Channel	CH19957	Polarization	Horizontal
Temp	23°C	Hum.	64%
Modulation Type	BPSK	Sub-carrier Spacing	3.75KHz

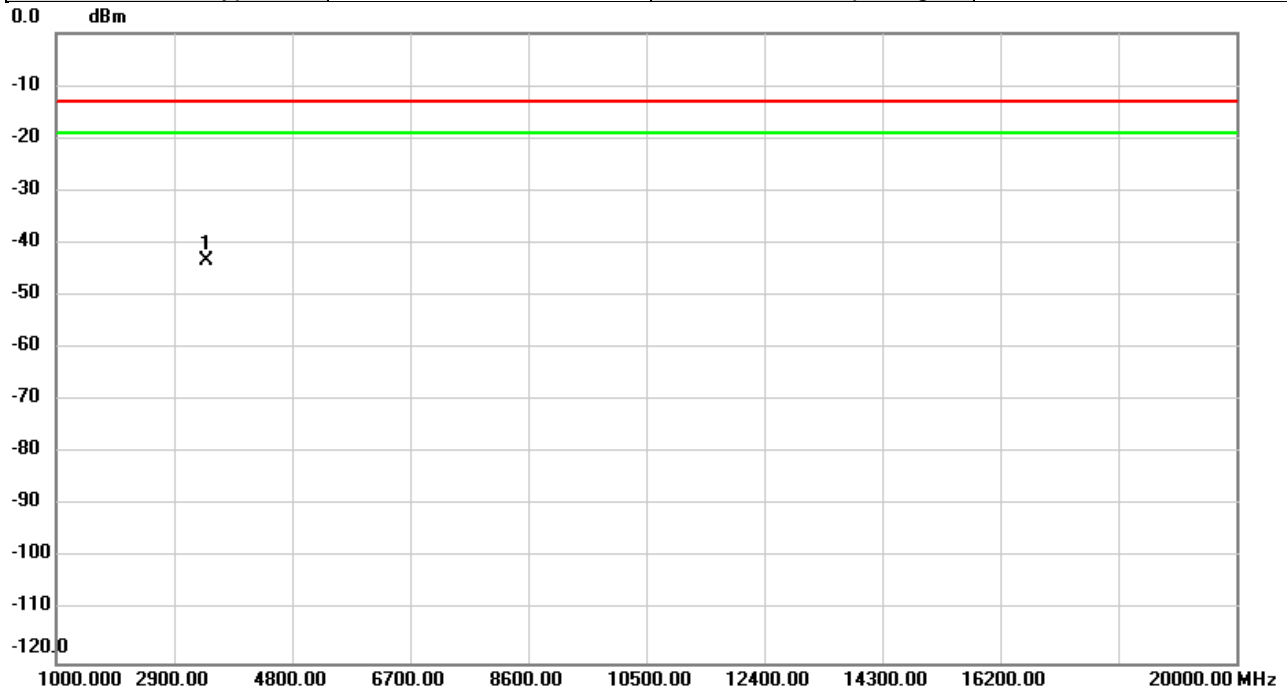

No.	Mk.	Freq.	Reading Level	Correct Factor	Measurement	Limit	Over	Detector	Comment
		MHz	dBm	dB	dBm	dBm	dB		
1	*	3421.233	-41.02	-2.21	-43.23	-13.00	-30.23	peak	

REMARKS:

- (1) Measurement Value = Reading Level + Correct Factor.
- (2) Margin Level = Measurement Value - Limit Value.

Test Mode	NB-IOT Band 4	Test Date	2020/11/10
Test Channel	CH19957	Polarization	Vertical
Temp	23°C	Hum.	64%
Modulation Type	BPSK	Sub-carrier Spacing	15KHz

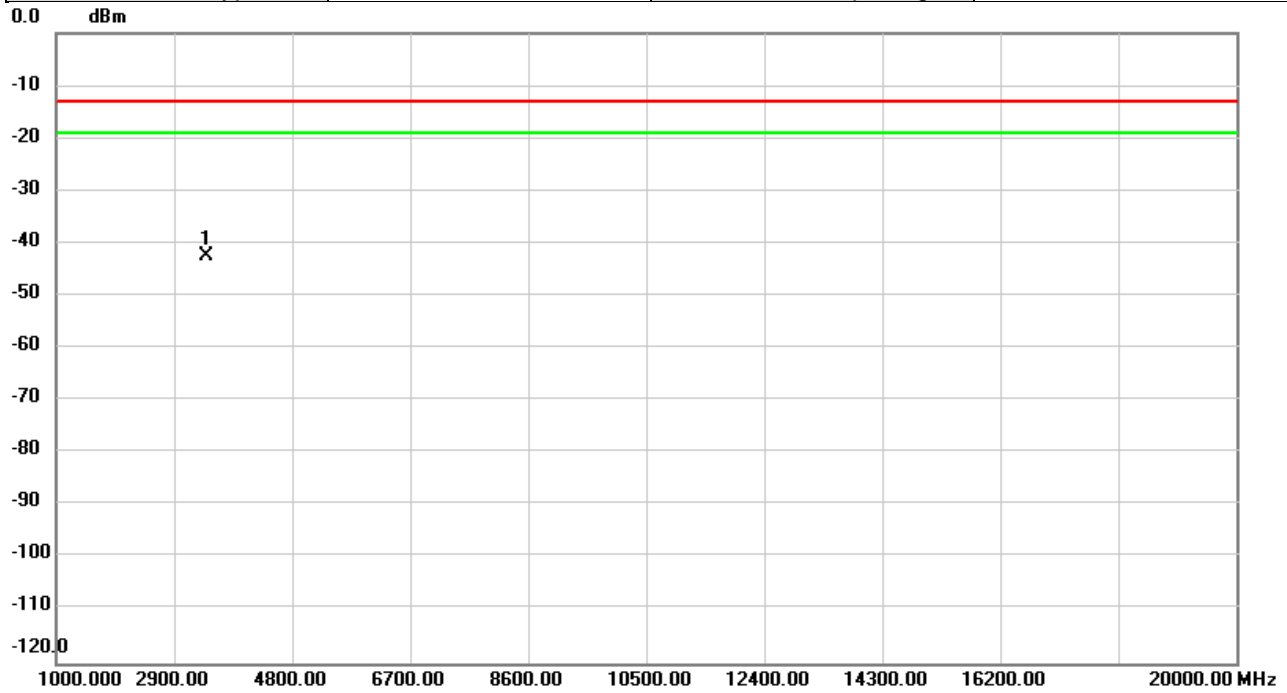

No.	Mk.	Freq.	Reading Level	Correct Factor	Measurement	Limit	Over	Detector	Comment
		MHz	dBm	dB	dBm	dBm	dB		
1	*	3421.233	-39.91	-2.43	-42.34	-13.00	-29.34	peak	

**REMARKS:**

- (1) Measurement Value = Reading Level + Correct Factor.
- (2) Margin Level = Measurement Value - Limit Value.

Test Mode	NB-IOT Band 4	Test Date	2020/11/10
Test Channel	CH19957	Polarization	Horizontal
Temp	23°C	Hum.	64%
Modulation Type	BPSK	Sub-carrier Spacing	15KHz

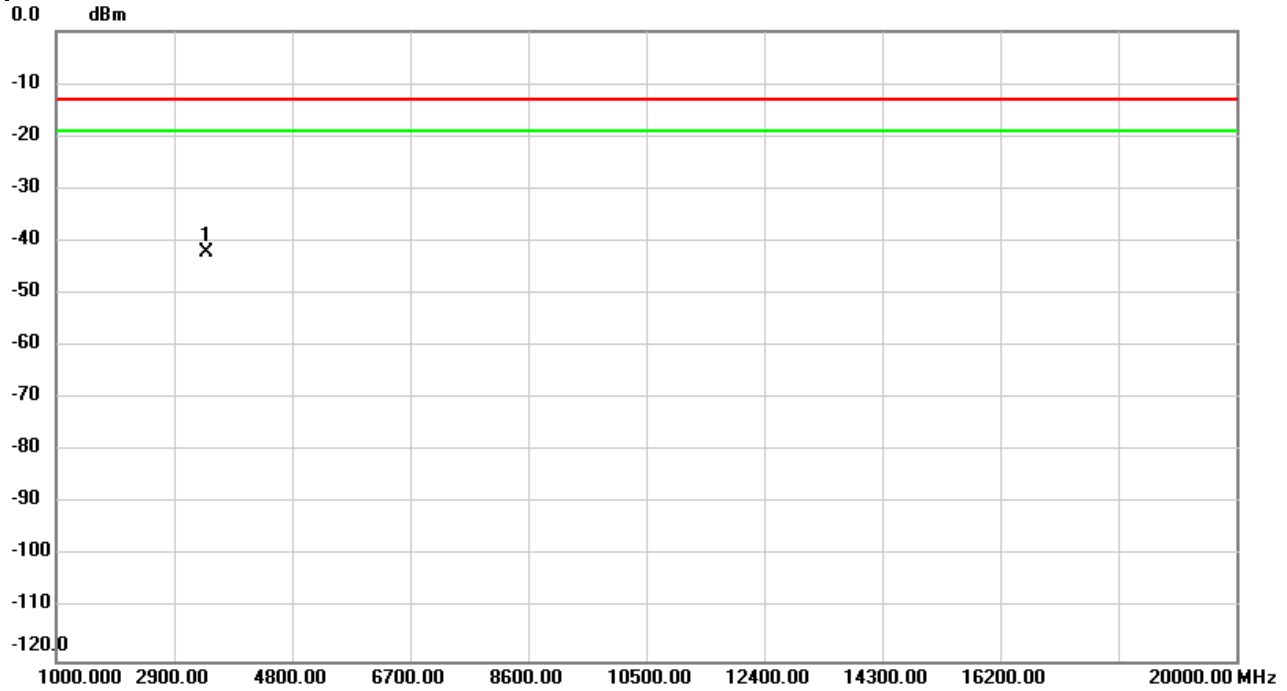

No.	Mk.	Freq.	Reading Level	Correct Factor	Measurement	Limit	Over	Detector	Comment
		MHz	dBm	dB	dBm	dBm	dB		
1	*	3421.233	-40.00	-2.21	-42.21	-13.00	-29.21	peak	

REMARKS:  
 (1) Measurement Value = Reading Level + Correct Factor.  
 (2) Margin Level = Measurement Value - Limit Value.



Test Mode	NB-IOT Band 4	Test Date	2020/11/10
Test Channel	CH20175	Polarization	Vertical
Temp	23°C	Hum.	64%
Modulation Type	BPSK	Sub-carrier Spacing	3.75KHz

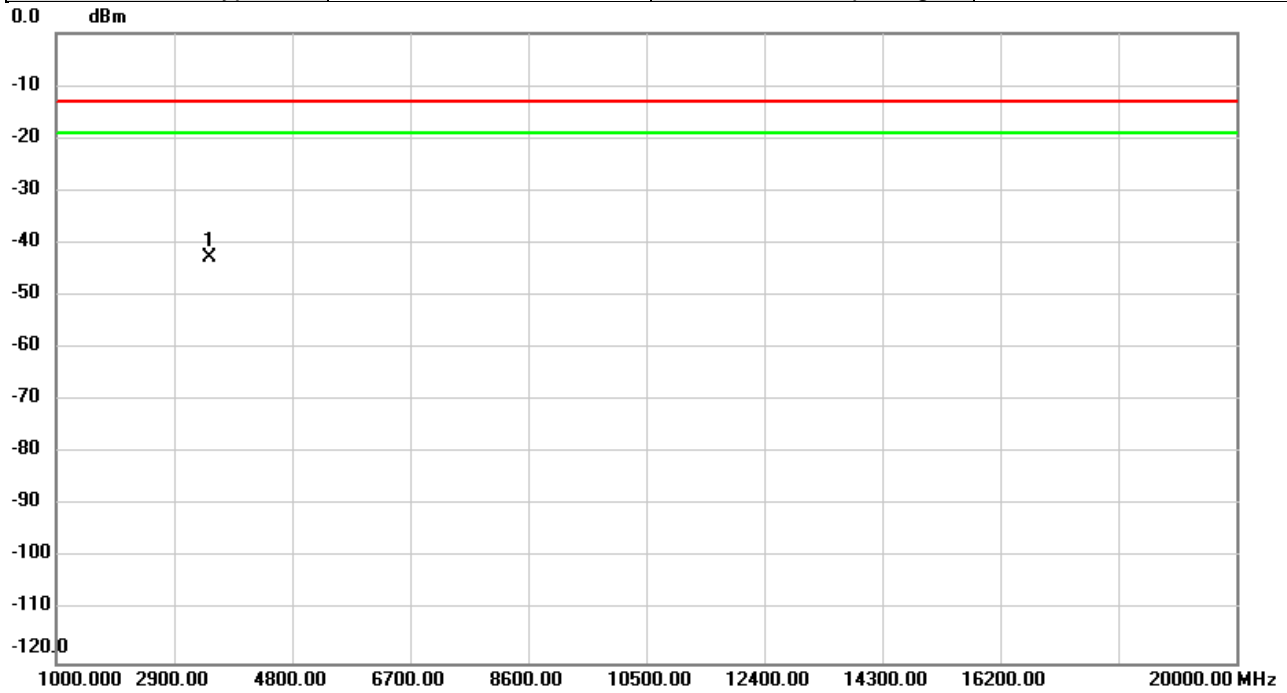

No.	Mk.	Freq.	Reading Level	Correct Factor	Measurement	Limit	Over	Detector	Comment
		MHz	dBm	dB	dBm	dBm	dB		
1	*	3464.933	-40.82	-1.99	-42.81	-13.00	-29.81	peak	

REMARKS:

- (1) Measurement Value = Reading Level + Correct Factor.
- (2) Margin Level = Measurement Value - Limit Value.

Test Mode	NB-IOT Band 4	Test Date	2020/11/10
Test Channel	CH20175	Polarization	Horizontal
Temp	23°C	Hum.	64%
Modulation Type	BPSK	Sub-carrier Spacing	3.75KHz

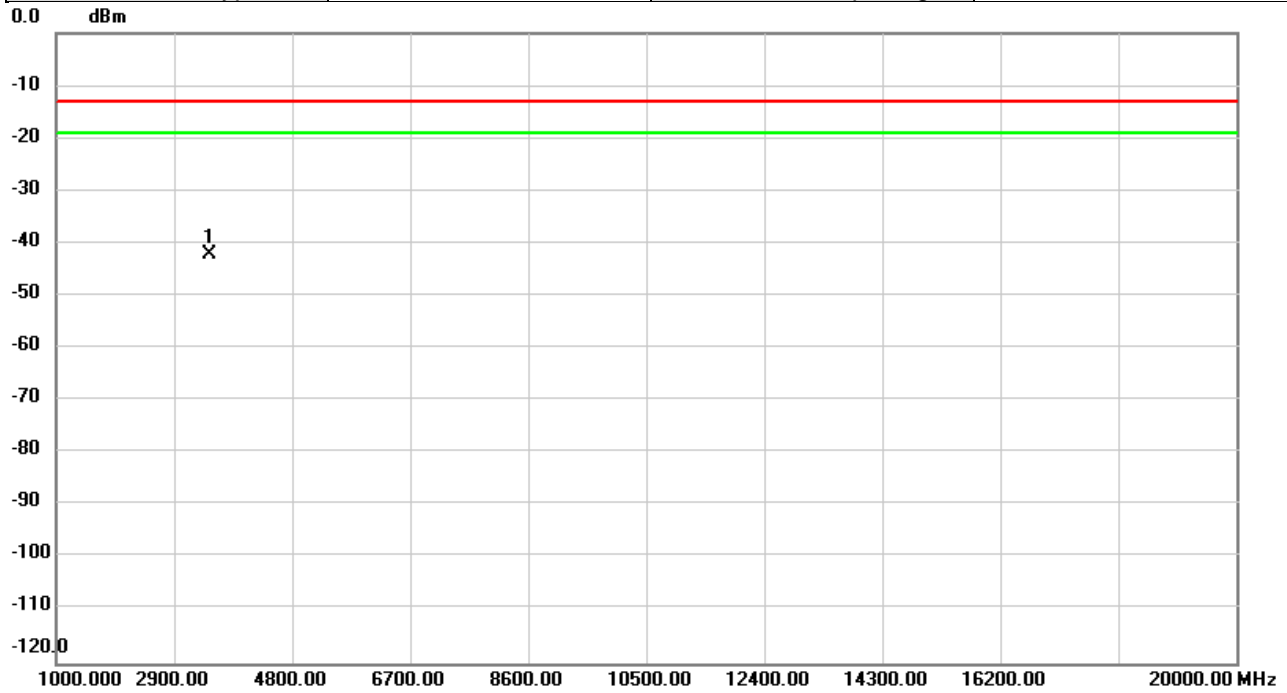

No.	Mk.	Freq.	Reading Level	Correct Factor	Measurement	Limit	Over	Detector	Comment
		MHz	dBm	dB	dBm	dBm	dB		
1	*	3464.933	-40.34	-1.91	-42.25	-13.00	-29.25	peak	

**REMARKS:**

- (1) Measurement Value = Reading Level + Correct Factor.
- (2) Margin Level = Measurement Value - Limit Value.

Test Mode	NB-IOT Band 4	Test Date	2020/11/10
Test Channel	CH20175	Polarization	Vertical
Temp	23°C	Hum.	64%
Modulation Type	BPSK	Sub-carrier Spacing	15KHz

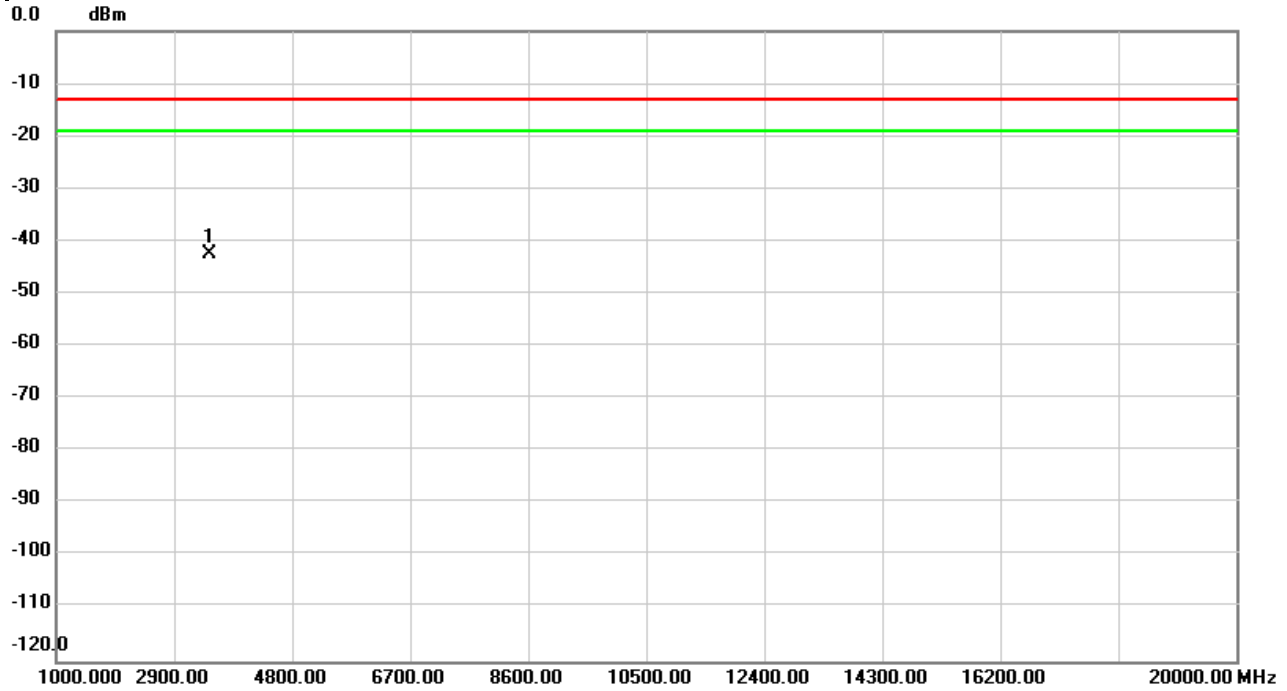

No.	Mk.	Freq.	Reading Level	Correct Factor	Measurement	Limit	Over	Detector	Comment
		MHz	dBm	dB	dBm	dBm	dB		
1	*	3464.933	-40.55	-1.99	-42.54	-13.00	-29.54	peak	

REMARKS:

- (1) Measurement Value = Reading Level + Correct Factor.
- (2) Margin Level = Measurement Value - Limit Value.

Test Mode	NB-IOT Band 4	Test Date	2020/11/10
Test Channel	CH20175	Polarization	Horizontal
Temp	23°C	Hum.	64%
Modulation Type	BPSK	Sub-carrier Spacing	15KHz

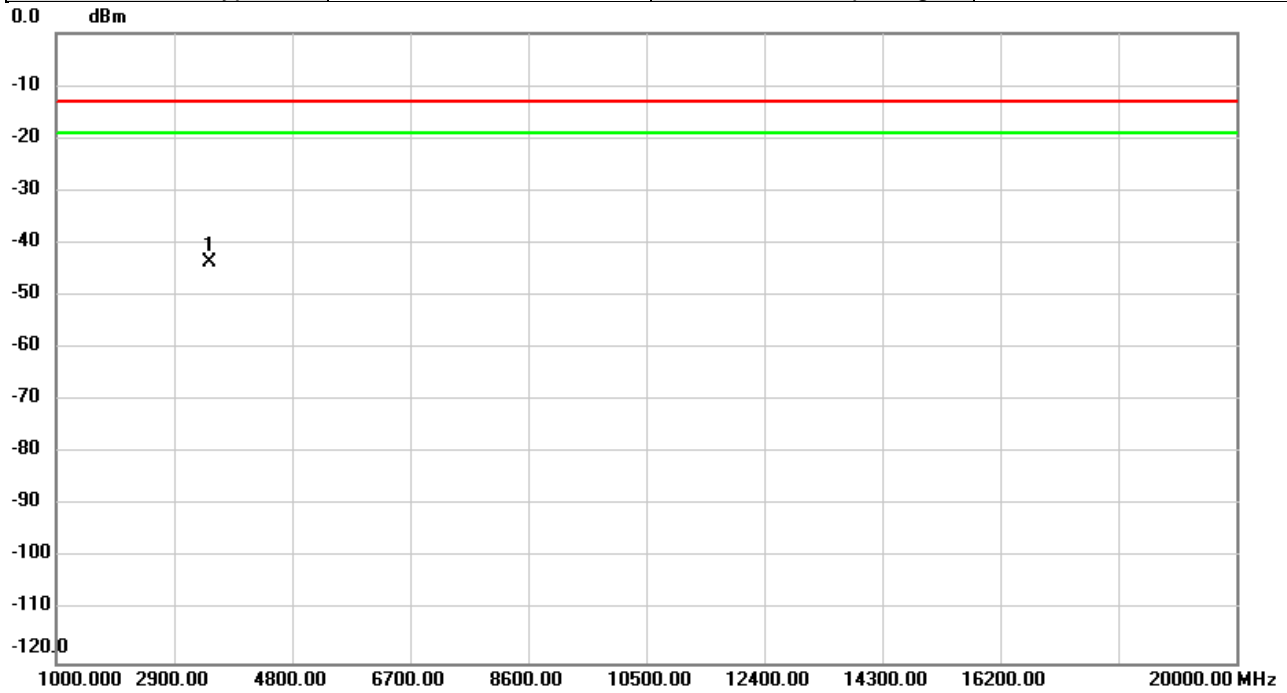

No.	Mk.	Freq.	Reading Level	Correct Factor	Measurement	Limit	Over	Detector	Comment
		MHz	dBm	dB	dBm	dBm	dB		
1	*	3464.933	-41.82	-1.91	-43.73	-13.00	-30.73	peak	

REMARKS:

- (1) Measurement Value = Reading Level + Correct Factor.
- (2) Margin Level = Measurement Value - Limit Value.

Test Mode	NB-IOT Band 4	Test Date	2020/11/10
Test Channel	CH20392	Polarization	Vertical
Temp	23°C	Hum.	64%
Modulation Type	BPSK	Sub-carrier Spacing	3.75KHz

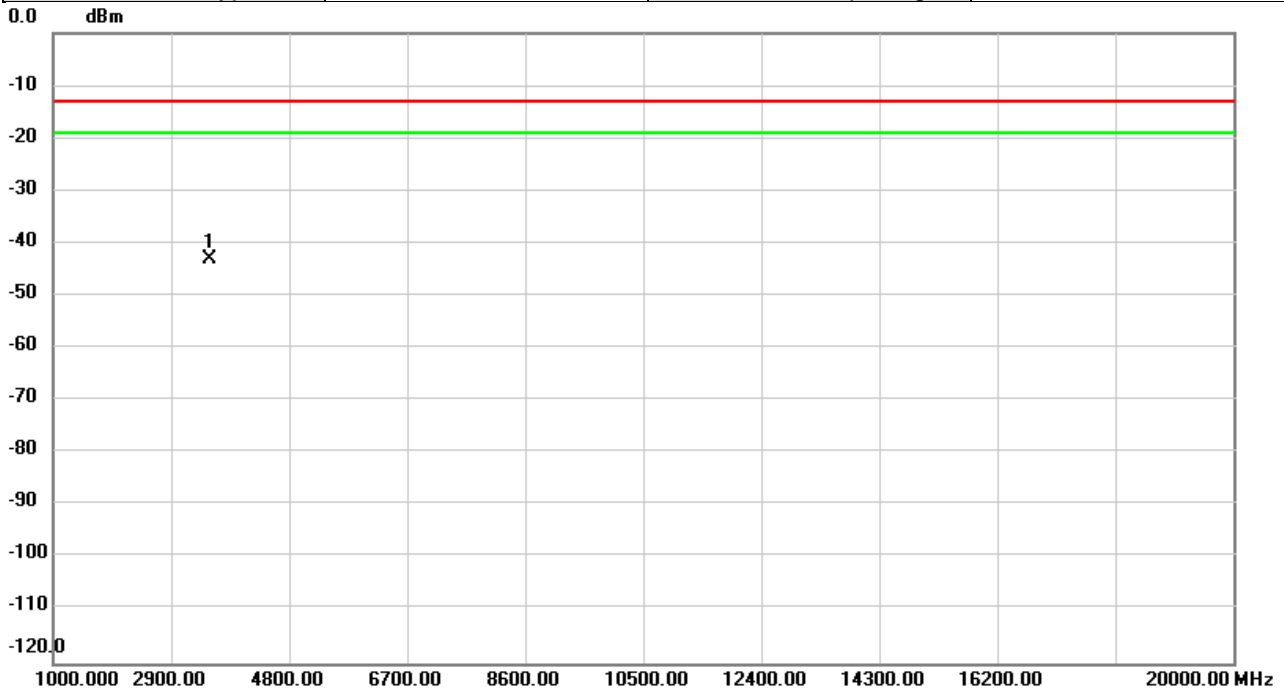

No.	Mk.	Freq.	Reading Level	Correct Factor	Measurement	Limit	Over	Detector	Comment
		MHz	dBm	dB	dBm	dBm	dB		
1	*	3508.633	-41.57	-1.61	-43.18	-13.00	-30.18	peak	

REMARKS:

- (1) Measurement Value = Reading Level + Correct Factor.
- (2) Margin Level = Measurement Value - Limit Value.

Test Mode	NB-IOT Band 4	Test Date	2020/11/10
Test Channel	CH20392	Polarization	Horizontal
Temp	23°C	Hum.	64%
Modulation Type	BPSK	Sub-carrier Spacing	3.75KHz

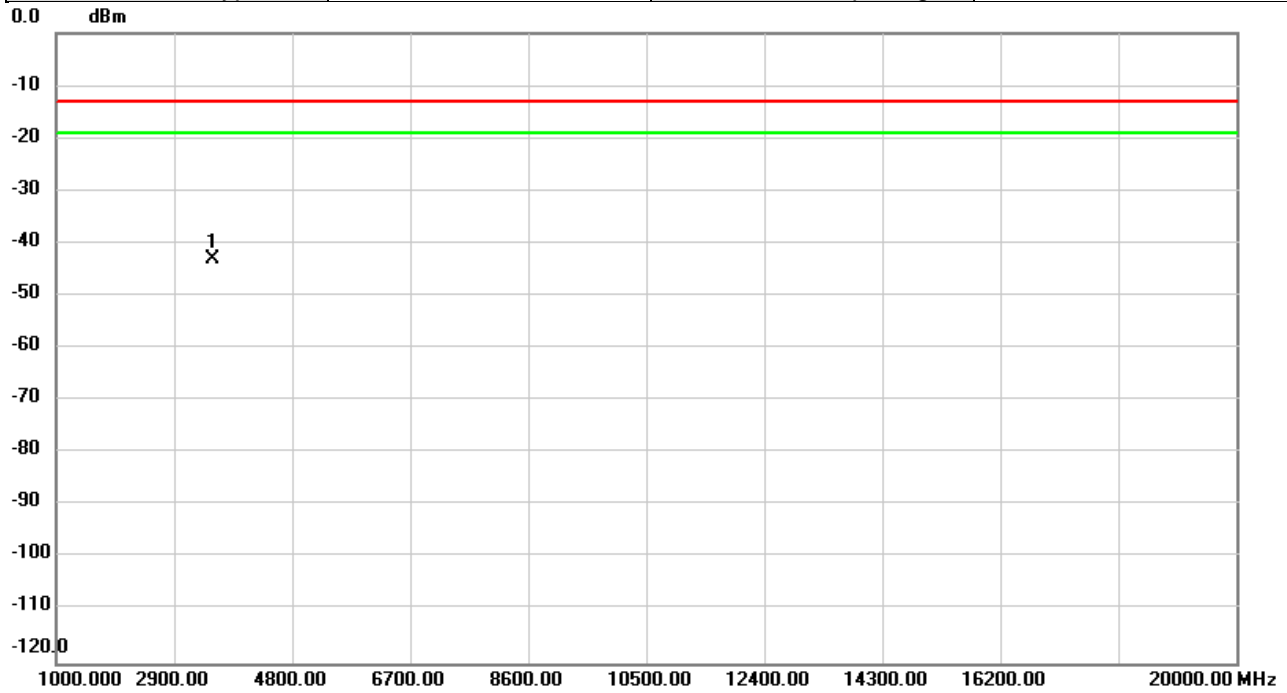

No.	Mk.	Freq.	Reading Level	Correct Factor	Measurement	Limit	Over	Detector	Comment
		MHz	dBm	dB	dBm	dBm	dB		
1	*	3508.000	-41.49	-1.54	-43.03	-13.00	-30.03	peak	

REMARKS:

- (1) Measurement Value = Reading Level + Correct Factor.
- (2) Margin Level = Measurement Value - Limit Value.

Test Mode	NB-IOT Band 4	Test Date	2020/11/10
Test Channel	CH20392	Polarization	Vertical
Temp	23°C	Hum.	64%
Modulation Type	BPSK	Sub-carrier Spacing	15KHz

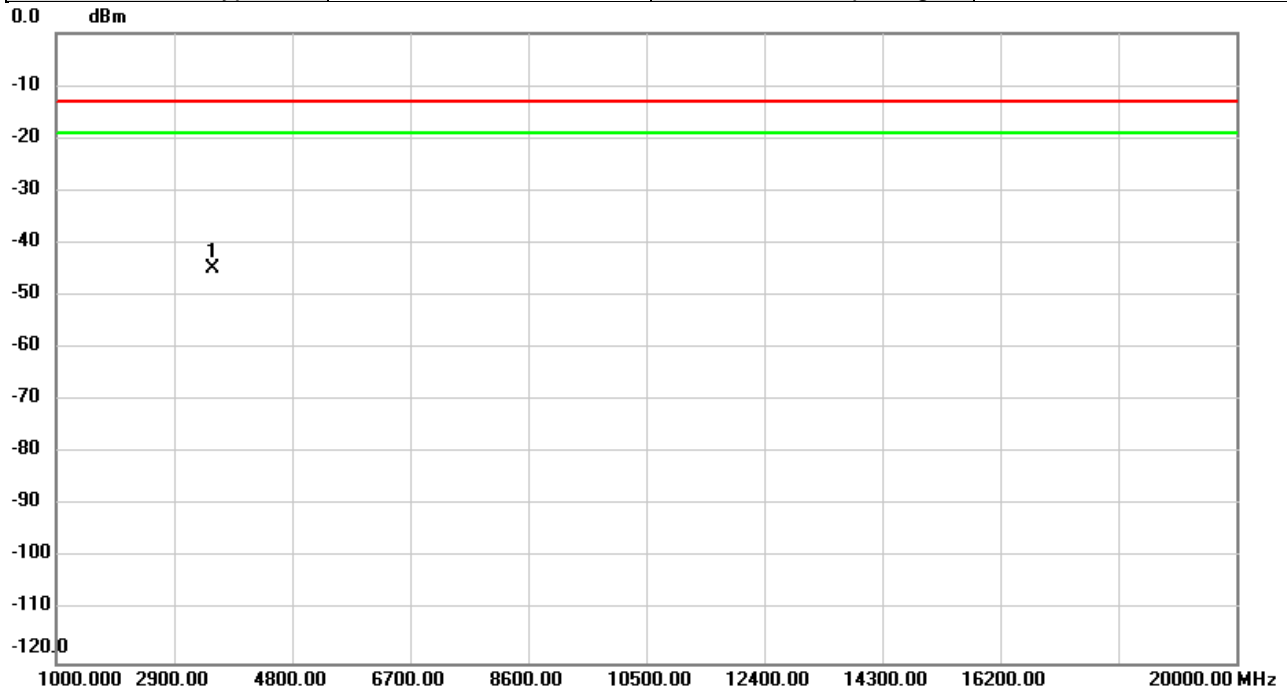

No.	Mk.	Freq.	Reading Level	Correct Factor	Measurement	Limit	Over	Detector	Comment
		MHz	dBm	dB	dBm	dBm	dB		
1	*	3508.633	-43.17	-1.61	-44.78	-13.00	-31.78	peak	

REMARKS:

- (1) Measurement Value = Reading Level + Correct Factor.
- (2) Margin Level = Measurement Value - Limit Value.

Test Mode	NB-IOT Band 4	Test Date	2020/11/10
Test Channel	CH20392	Polarization	Horizontal
Temp	23°C	Hum.	64%
Modulation Type	BPSK	Sub-carrier Spacing	15KHz

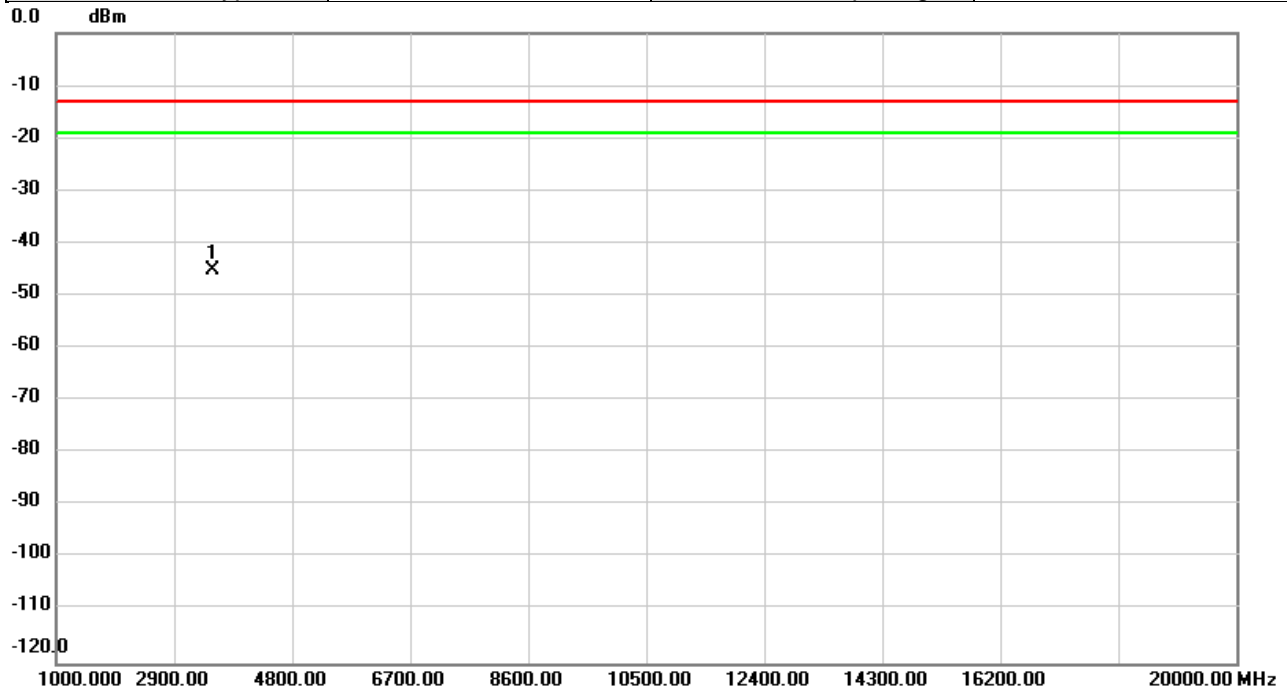

No.	Mk.	Freq.	Reading Level	Correct Factor	Measurement	Limit	Over	Detector	Comment
		MHz	dBm	dB	dBm	dBm	dB		
1	*	3508.000	-43.49	-1.54	-45.03	-13.00	-32.03	peak	

REMARKS:

- (1) Measurement Value = Reading Level + Correct Factor.
- (2) Margin Level = Measurement Value - Limit Value.



Test Mode	NB-IOT Band 12	Test Date	2020/11/10
Test Channel	CH23095	Polarization	Vertical
Temp	23°C	Hum.	64%
Modulation Type	QPSK	Sub-carrier Spacing	15KHz

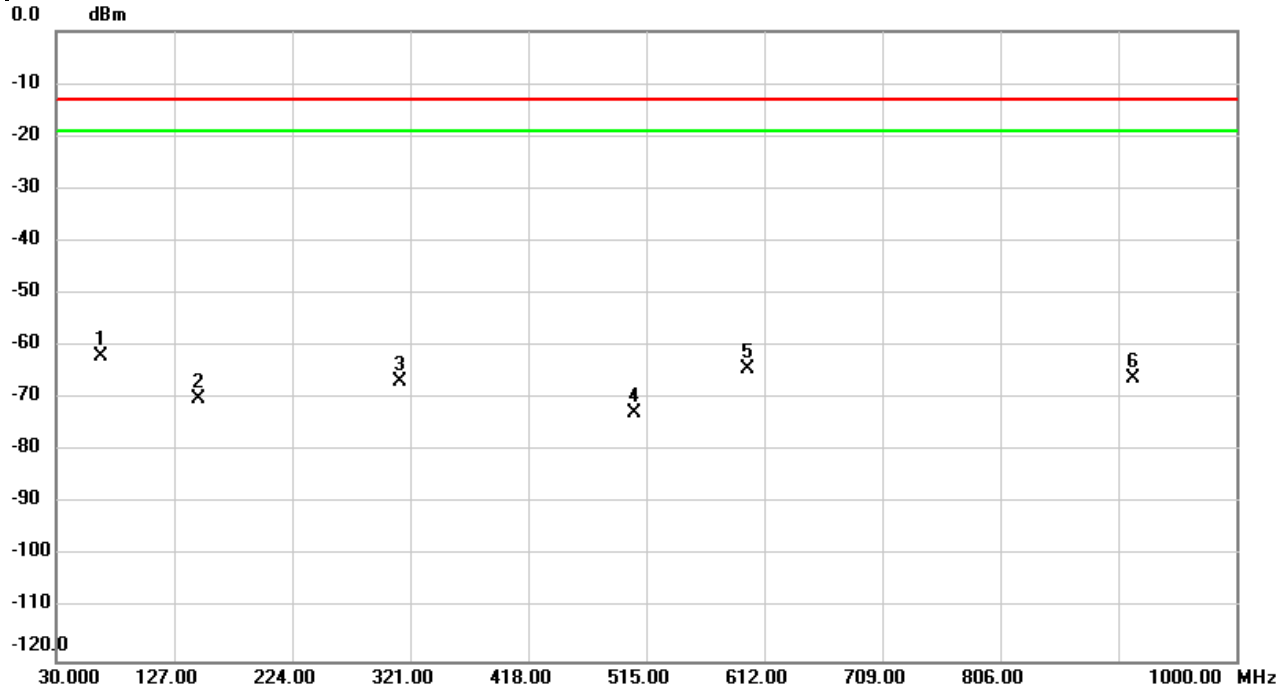

No.	Mk.	Freq. MHz	Reading Level dBm	Correct Factor dB	Measure- ment dBm	Limit dBm	Over dB	Detector	Comment
1	*	66.3103	-59.98	-2.02	-62.00	-13.00	-49.00	peak	
2		147.6610	-72.95	3.04	-69.91	-13.00	-56.91	peak	
3		312.2377	-74.17	7.37	-66.80	-13.00	-53.80	peak	
4		505.2353	-77.10	4.40	-72.70	-13.00	-59.70	peak	
5		598.7110	-76.30	12.07	-64.23	-13.00	-51.23	peak	
6		915.6423	-77.45	11.37	-66.08	-13.00	-53.08	peak	

REMARKS:  
 (1) Measurement Value = Reading Level + Correct Factor.  
 (2) Margin Level = Measurement Value - Limit Value.

Test Mode	NB-IOT Band 12	Test Date	2020/11/10
Test Channel	CH23095	Polarization	Horizontal
Temp	23°C	Hum.	64%
Modulation Type	QPSK	Sub-carrier Spacing	15KHz

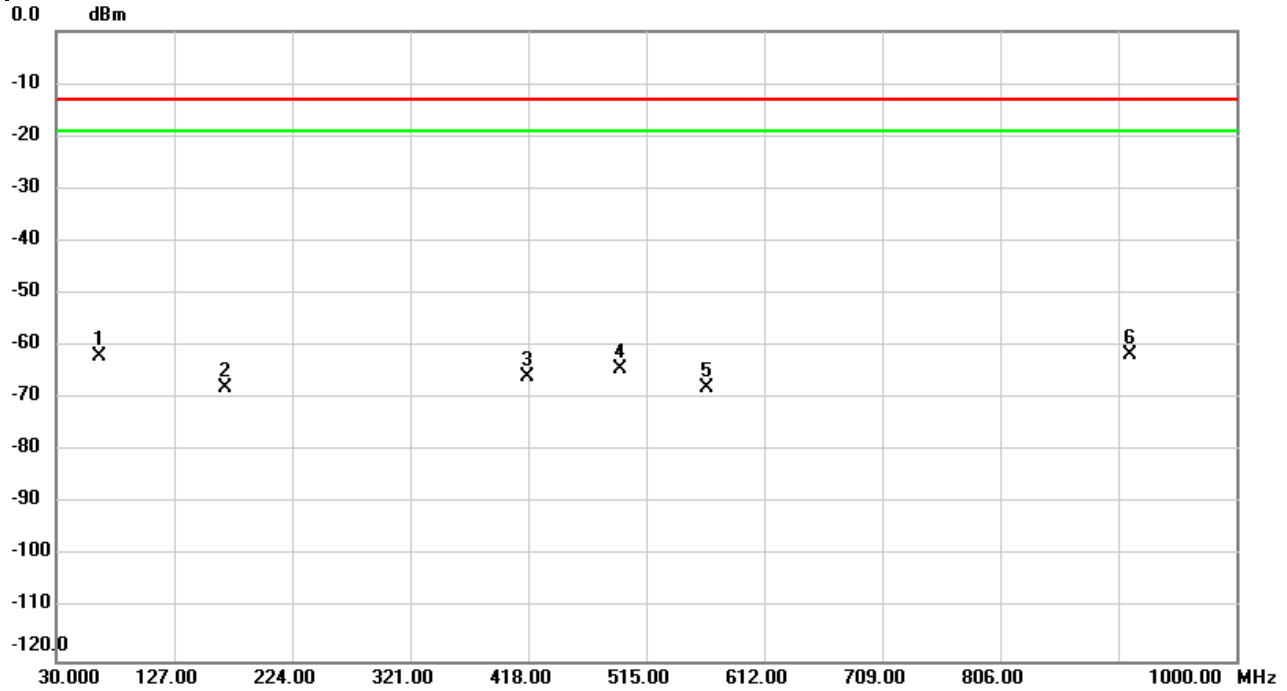

No.	Mk.	Freq. MHz	Reading Level dBm	Correct Factor dB	Measure- ment dBm	Limit dBm	Over dB	Detector	Comment
1		65.3403	-67.44	5.50	-61.94	-13.00	-48.94	peak	
2		169.4212	-70.19	2.19	-68.00	-13.00	-55.00	peak	
3		416.9653	-74.24	8.27	-65.97	-13.00	-52.97	peak	
4		493.6923	-75.52	11.12	-64.40	-13.00	-51.40	peak	
5		565.1813	-76.37	8.28	-68.09	-13.00	-55.09	peak	
6	*	912.9263	-76.64	14.98	-61.66	-13.00	-48.66	peak	

REMARKS:  
 (1) Measurement Value = Reading Level + Correct Factor.  
 (2) Margin Level = Measurement Value - Limit Value.

Test Mode	NB-IOT Band 12	Test Date	2020/11/10
Test Channel	CH23017	Polarization	Horizontal
Temp	23°C	Hum.	64%
Modulation Type	QPSK	Sub-carrier Spacing	3.75KHz

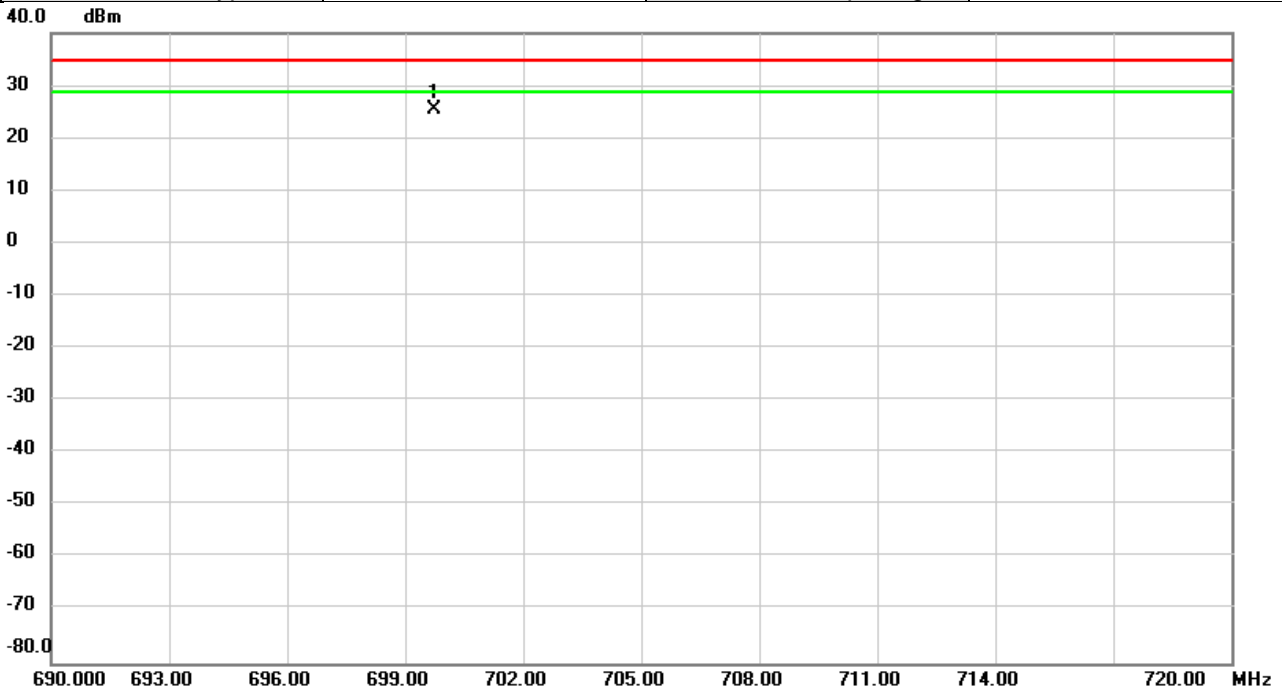

No.	Mk.	Freq.	Reading Level	Correct Factor	Measurement	Limit	Over	Detector	Comment
		MHz	dBm	dB	dBm	dBm	dB		
1	*	699.7540	14.08	11.52	25.60	34.77	-9.17	peak	

REMARKS:

- (1) Measurement Value = Reading Level + Correct Factor.
- (2) Margin Level = Measurement Value - Limit Value.

Test Mode	NB-IOT Band 12	Test Date	2020/11/10
Test Channel	CH23017	Polarization	Vertical
Temp	23°C	Hum.	64%
Modulation Type	QPSK	Sub-carrier Spacing	3.75KHz

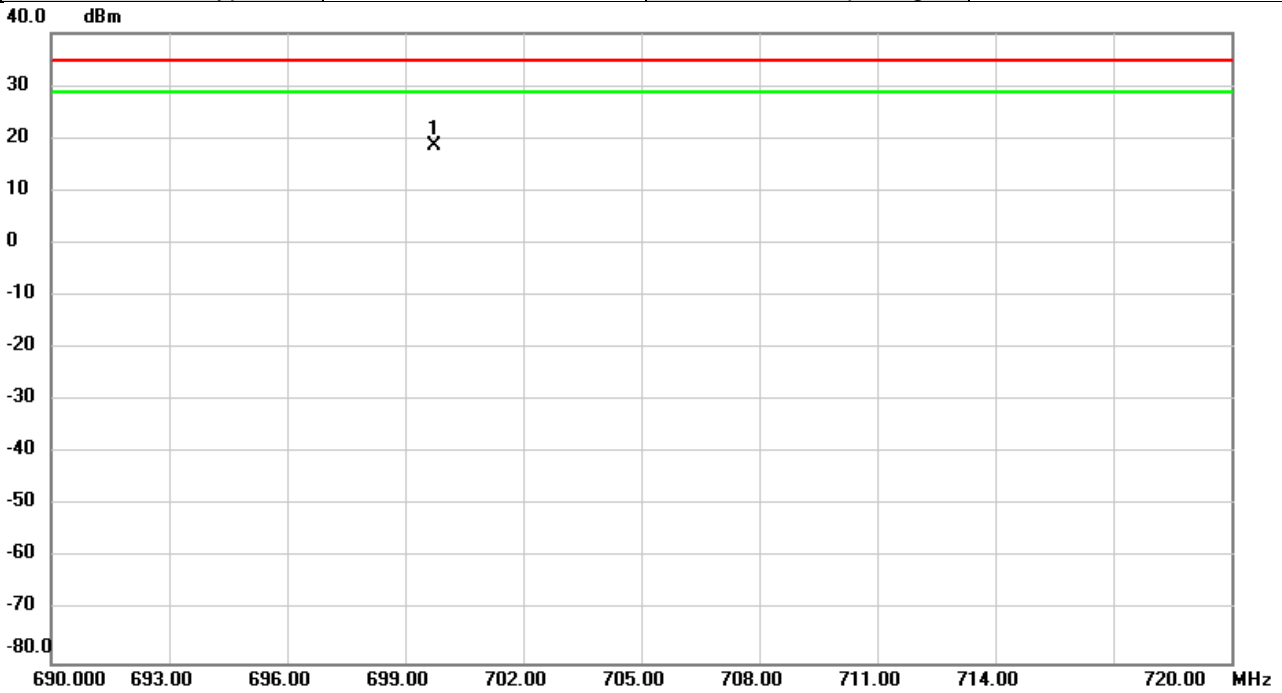

No.	Mk.	Freq.	Reading Level	Correct Factor	Measurement	Limit	Over	Detector	Comment
		MHz	dBm	dB	dBm	dBm	dB		
1	*	699.7580	3.77	14.81	18.58	34.77	-16.19	peak	

REMARKS:

- (1) Measurement Value = Reading Level + Correct Factor.
- (2) Margin Level = Measurement Value - Limit Value.

Test Mode	NB-IOT Band 12	Test Date	2020/11/10
Test Channel	CH23017	Polarization	Vertical
Temp	23°C	Hum.	64%
Modulation Type	QPSK	Sub-carrier Spacing	15KHz

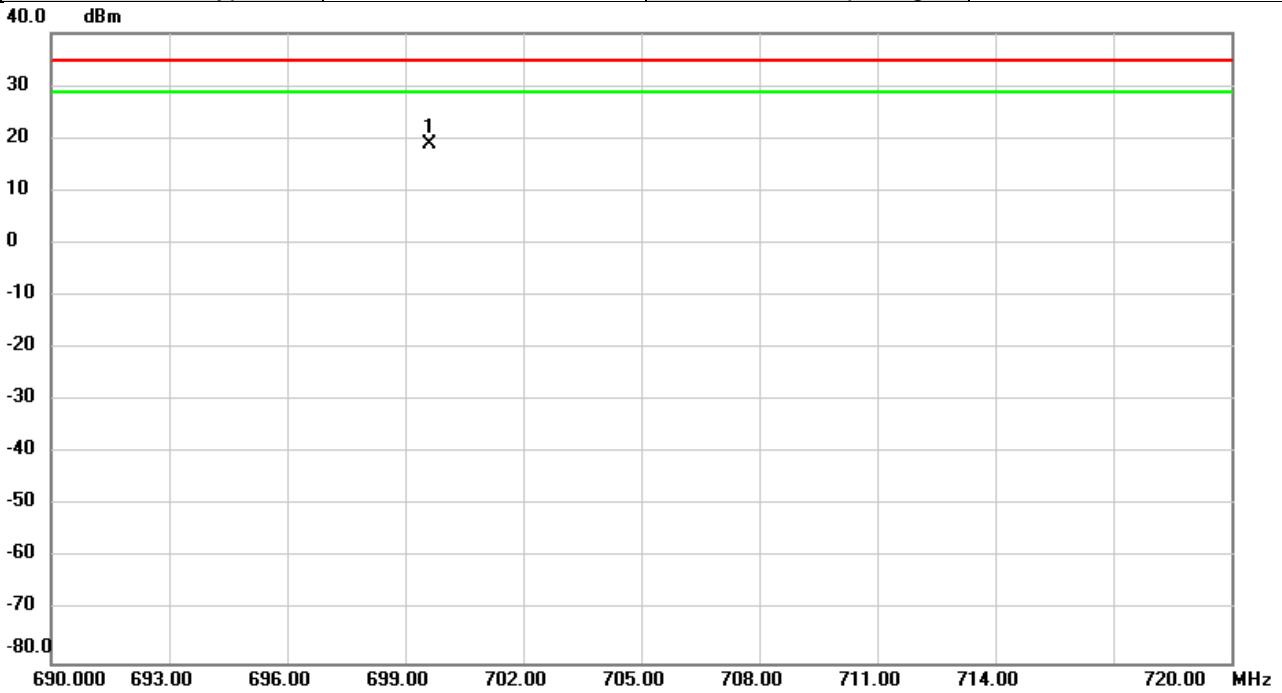

No.	Mk.	Freq.	Reading Level	Correct Factor	Measurement	Limit	Over	Detector	Comment
		MHz	dBm	dB	dBm	dBm	dB		
1	*	699.6210	3.91	14.81	18.72	34.77	-16.05	peak	

**REMARKS:**

- (1) Measurement Value = Reading Level + Correct Factor.
- (2) Margin Level = Measurement Value - Limit Value.

Test Mode	NB-IOT Band 12	Test Date	2020/11/10
Test Channel	CH23017	Polarization	Horizontal
Temp	23°C	Hum.	64%
Modulation Type	QPSK	Sub-carrier Spacing	15KHz

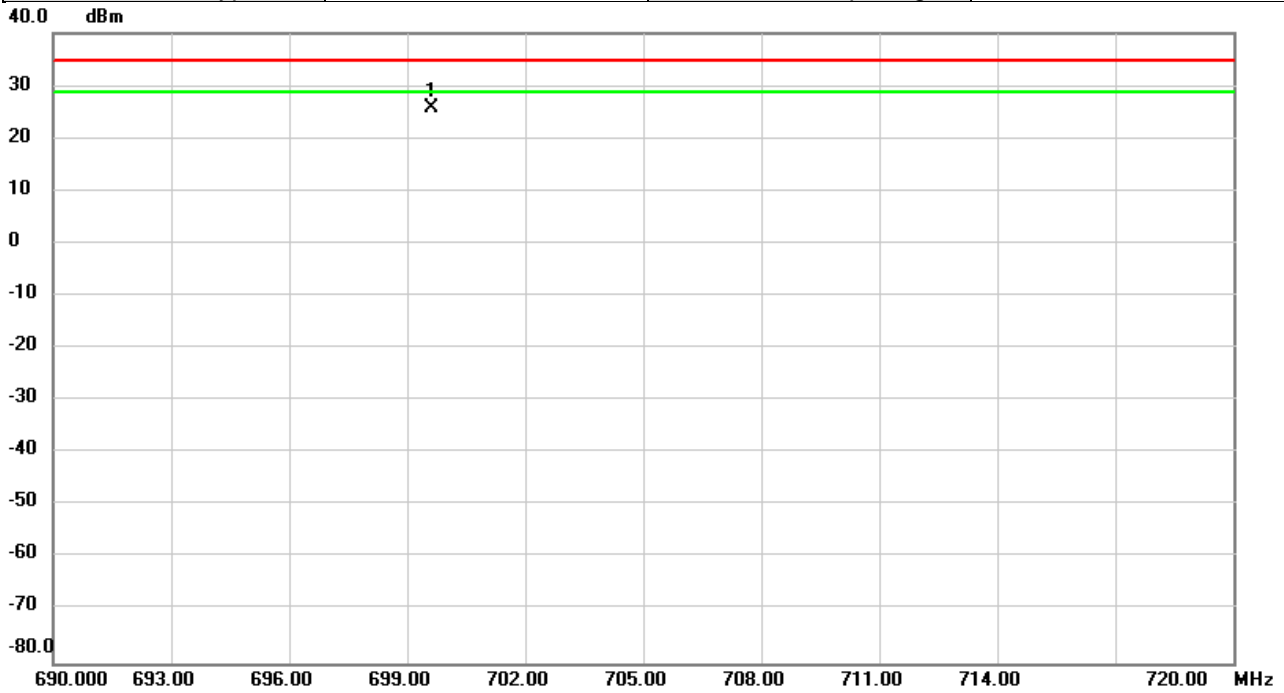

No.	Mk.	Freq.	Reading Level	Correct Factor	Measurement	Limit	Over	Detector	Comment
		MHz	dBm	dB	dBm	dBm	dB		
1	*	699.6320	14.38	11.51	25.89	34.77	-8.88	peak	

REMARKS:

- (1) Measurement Value = Reading Level + Correct Factor.
- (2) Margin Level = Measurement Value - Limit Value.

Test Mode	NB-IOT Band 12	Test Date	2020/11/10
Test Channel	CH23095	Polarization	Vertical
Temp	23°C	Hum.	64%
Modulation Type	QPSK	Sub-carrier Spacing	3.75KHz

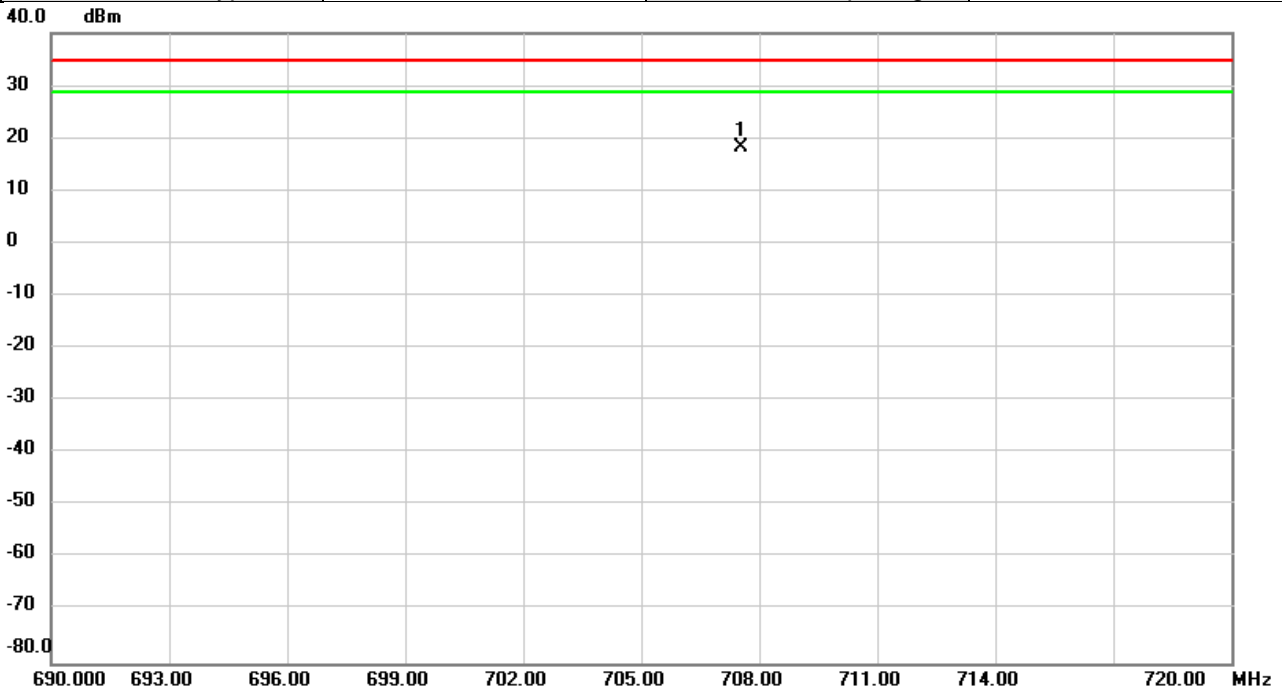

No.	Mk.	Freq. MHz	Reading Level dBm	Correct Factor dB	Measure- ment dBm	Limit dBm	Over dB	Detector	Comment
1	*	707.5580	3.72	14.64	18.36	34.77	-16.41	peak	

**REMARKS:**

- (1) Measurement Value = Reading Level + Correct Factor.
- (2) Margin Level = Measurement Value - Limit Value.

Test Mode	NB-IOT Band 12	Test Date	2020/11/10
Test Channel	CH23095	Polarization	Horizontal
Temp	23°C	Hum.	64%
Modulation Type	QPSK	Sub-carrier Spacing	3.75KHz

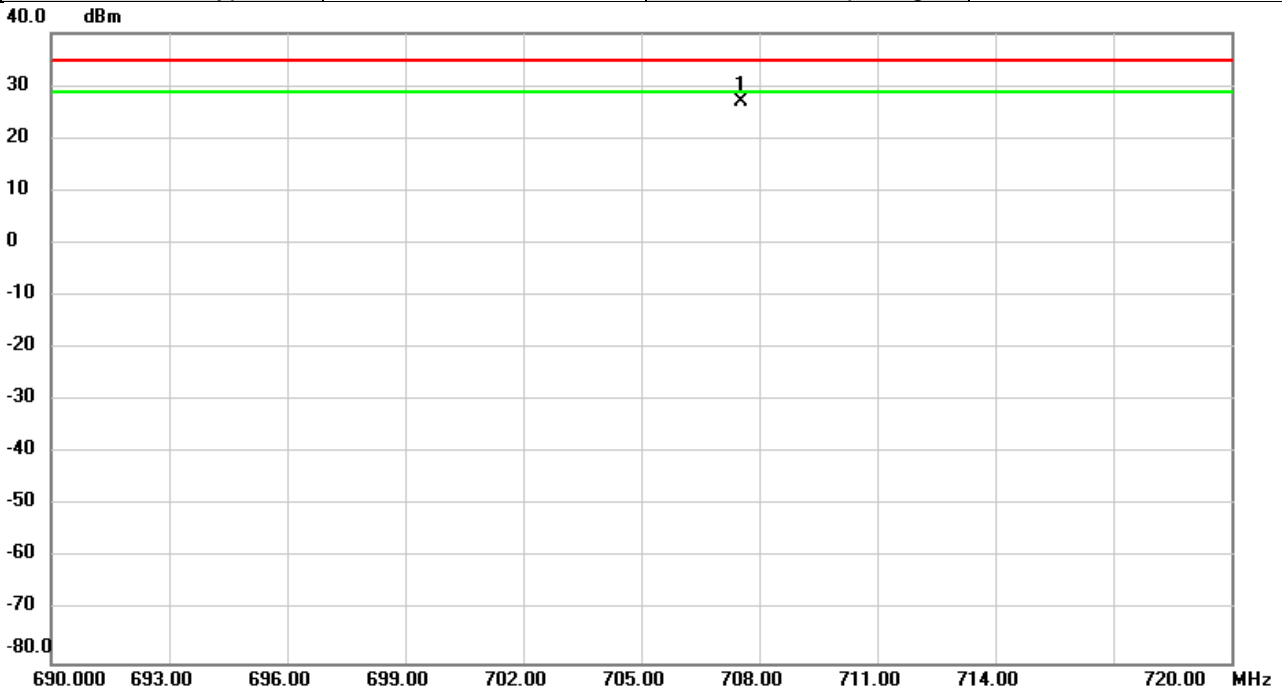

No.	Mk.	Freq.	Reading Level	Correct Factor	Measurement	Limit	Over	Detector	Comment
		MHz	dBm	dB	dBm	dBm	dB		
1	*	707.5540	14.94	12.04	26.98	34.77	-7.79	peak	

**REMARKS:**

- (1) Measurement Value = Reading Level + Correct Factor.
- (2) Margin Level = Measurement Value - Limit Value.



Test Mode	NB-IOT Band 12	Test Date	2020/11/10
Test Channel	CH23095	Polarization	Vertical
Temp	23°C	Hum.	64%
Modulation Type	QPSK	Sub-carrier Spacing	15KHz

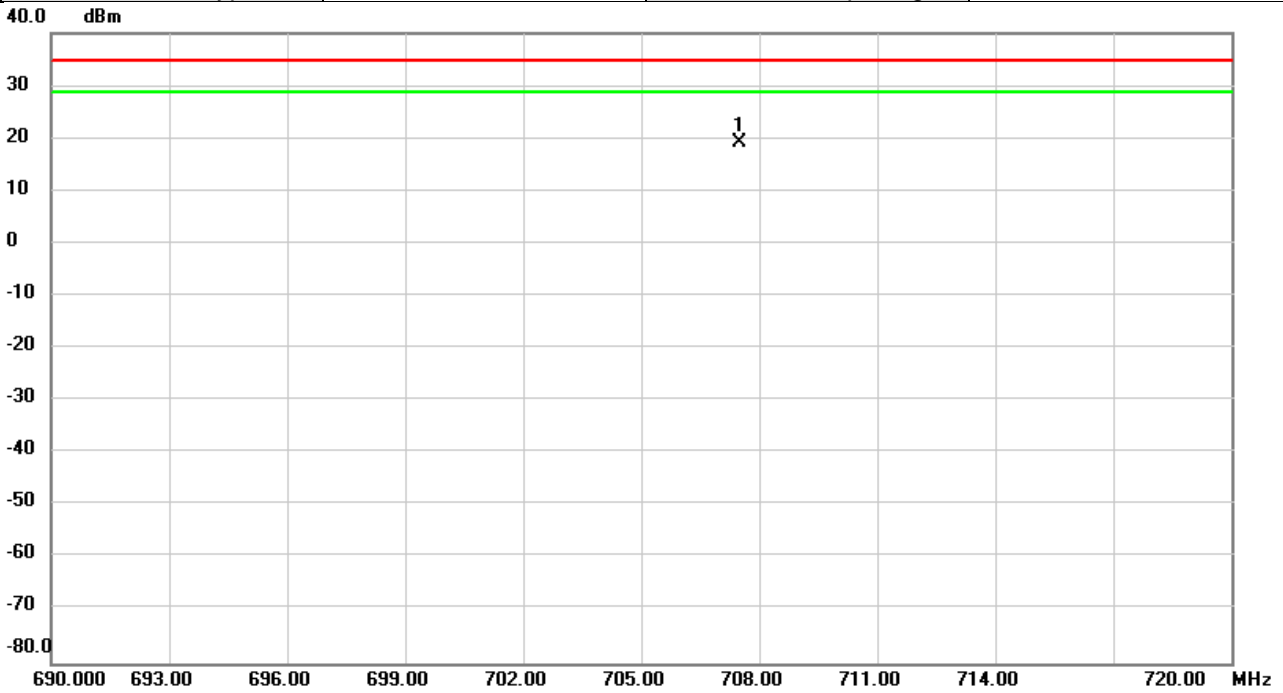

No.	Mk.	Freq.	Reading Level	Correct Factor	Measurement	Limit	Over	Detector	Comment
		MHz	dBm	dB	dBm	dBm	dB		
1	*	707.4870	4.46	14.65	19.11	34.77	-15.66	peak	

REMARKS:

- (1) Measurement Value = Reading Level + Correct Factor.
- (2) Margin Level = Measurement Value - Limit Value.

Test Mode	NB-IOT Band 12	Test Date	2020/11/10
Test Channel	CH23095	Polarization	Horizontal
Temp	23°C	Hum.	64%
Modulation Type	QPSK	Sub-carrier Spacing	15KHz

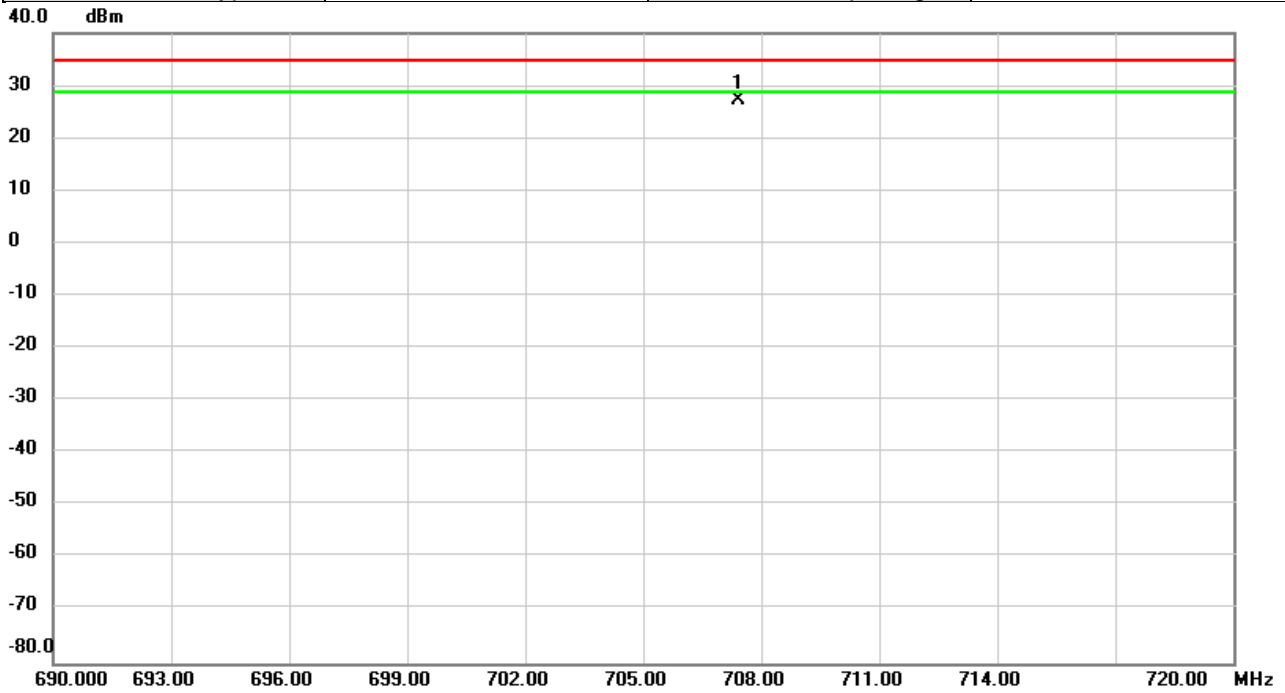

No.	Mk.	Freq.	Reading Level	Correct Factor	Measurement	Limit	Over	Detector	Comment
		MHz	dBm	dB	dBm	dBm	dB		
1	*	707.4280	15.17	12.03	27.20	34.77	-7.57	peak	

**REMARKS:**

- (1) Measurement Value = Reading Level + Correct Factor.
- (2) Margin Level = Measurement Value - Limit Value.

Test Mode	NB-IOT Band 12	Test Date	2020/11/10
Test Channel	CH23173	Polarization	Vertical
Temp	23°C	Hum.	64%
Modulation Type	QPSK	Sub-carrier Spacing	3.75KHz

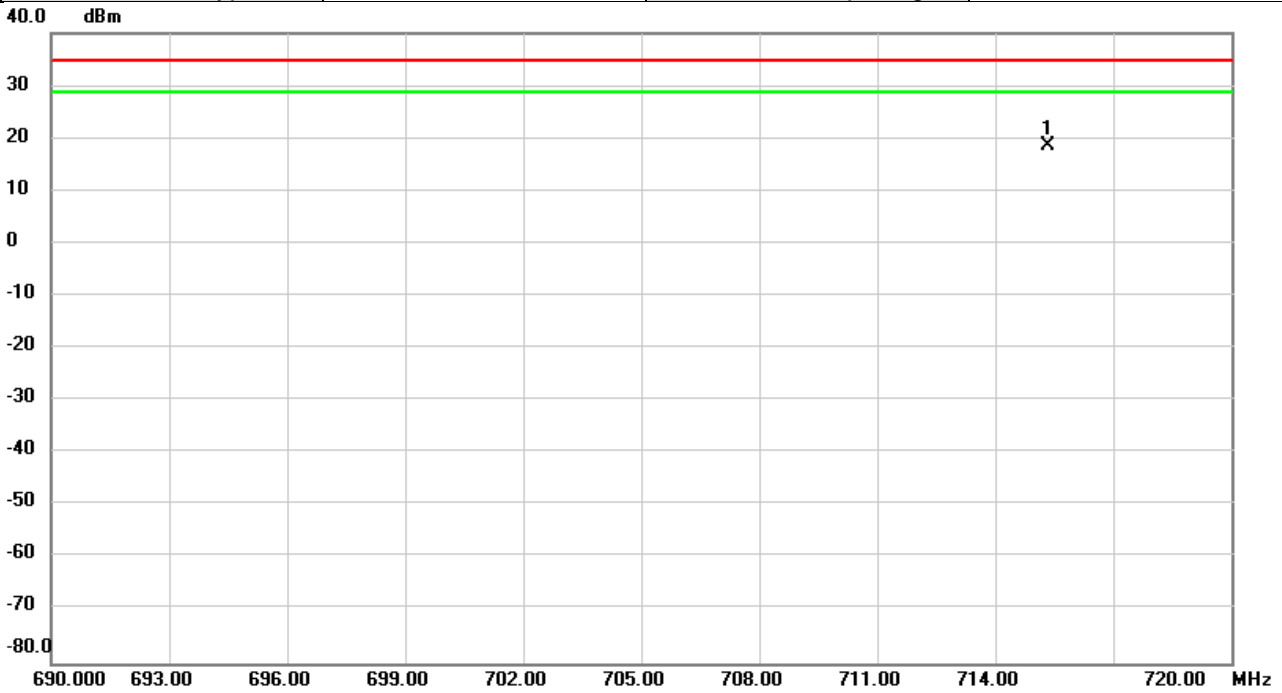

No.	Mk.	Freq. MHz	Reading Level dBm	Correct Factor dB	Measure- ment dBm	Limit dBm	Over dB	Detector	Comment
1	*	715.3590	4.12	14.47	18.59	34.77	-16.18	peak	

**REMARKS:**

- (1) Measurement Value = Reading Level + Correct Factor.
- (2) Margin Level = Measurement Value - Limit Value.

Test Mode	NB-IOT Band 12	Test Date	2020/11/10
Test Channel	CH23173	Polarization	Horizontal
Temp	23°C	Hum.	64%
Modulation Type	QPSK	Sub-carrier Spacing	3.75KHz

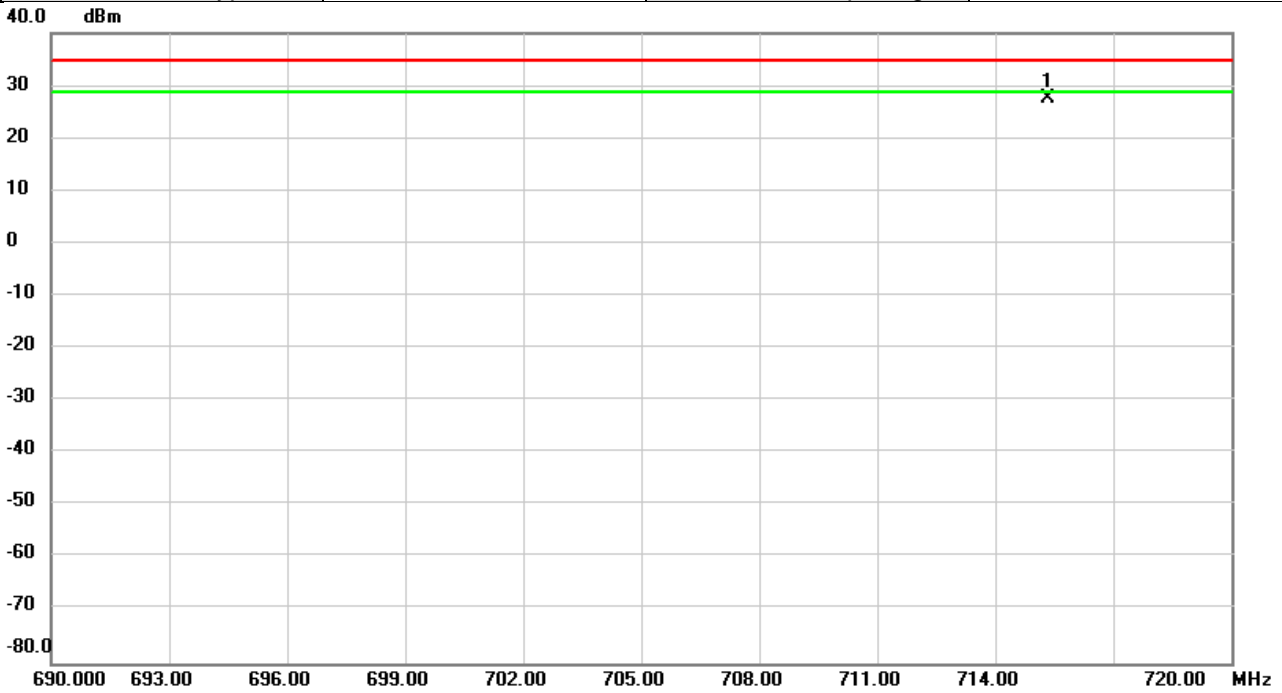

No.	Mk.	Freq.	Reading Level	Correct Factor	Measurement	Limit	Over	Detector	Comment
		MHz	dBm	dB	dBm	dBm	dB		
1	*	715.3490	14.97	12.57	27.54	34.77	-7.23	peak	

REMARKS:

- (1) Measurement Value = Reading Level + Correct Factor.
- (2) Margin Level = Measurement Value - Limit Value.

Test Mode	NB-IOT Band 12	Test Date	2020/11/10
Test Channel	CH23173	Polarization	Vertical
Temp	23°C	Hum.	64%
Modulation Type	QPSK	Sub-carrier Spacing	15KHz

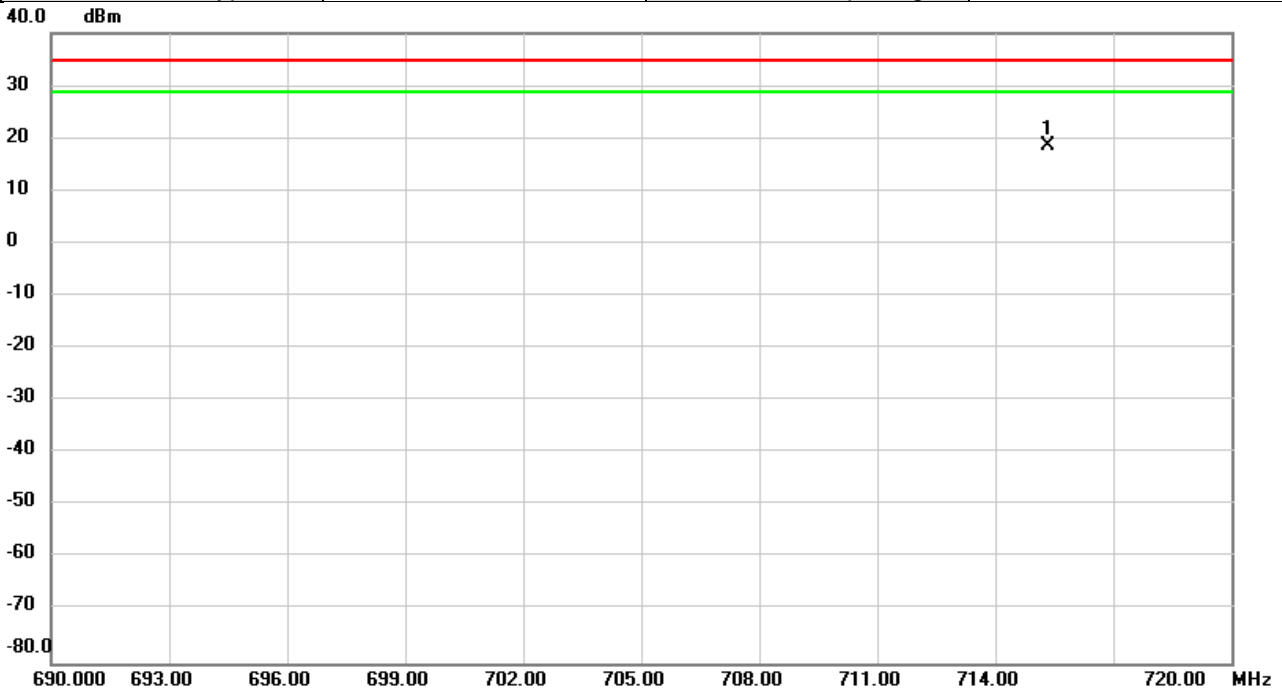

No.	Mk.	Freq. MHz	Reading Level dBm	Correct Factor dB	Measure- ment dBm	Limit dBm	Over dB	Detector	Comment
1	*	715.3590	4.12	14.47	18.59	34.77	-16.18	peak	

REMARKS:

- (1) Measurement Value = Reading Level + Correct Factor.
- (2) Margin Level = Measurement Value - Limit Value.

Test Mode	NB-IOT Band 12	Test Date	2020/11/10
Test Channel	CH23173	Polarization	Horizontal
Temp	23°C	Hum.	64%
Modulation Type	QPSK	Sub-carrier Spacing	15KHz

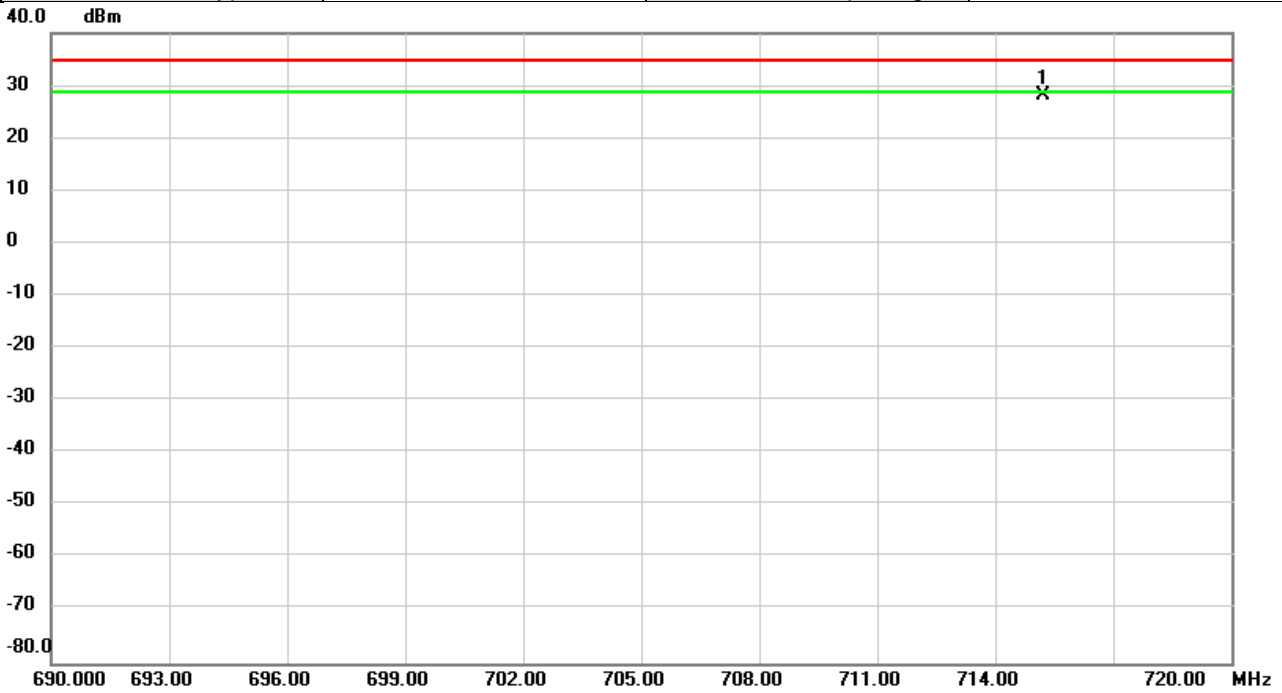

No.	Mk.	Freq.	Reading Level	Correct Factor	Measurement	Limit	Over	Detector	Comment
		MHz	dBm	dB	dBm	dBm	dB		
1	*	715.2080	15.53	12.56	28.09	34.77	-6.68	peak	

**REMARKS:**

- (1) Measurement Value = Reading Level + Correct Factor.
- (2) Margin Level = Measurement Value - Limit Value.

Test Mode	NB-IOT Band 12	Test Date	2020/11/10
Test Channel	CH23017	Polarization	Vertical
Temp	23°C	Hum.	64%
Modulation Type	QPSK	Sub-carrier Spacing	3.75KHz

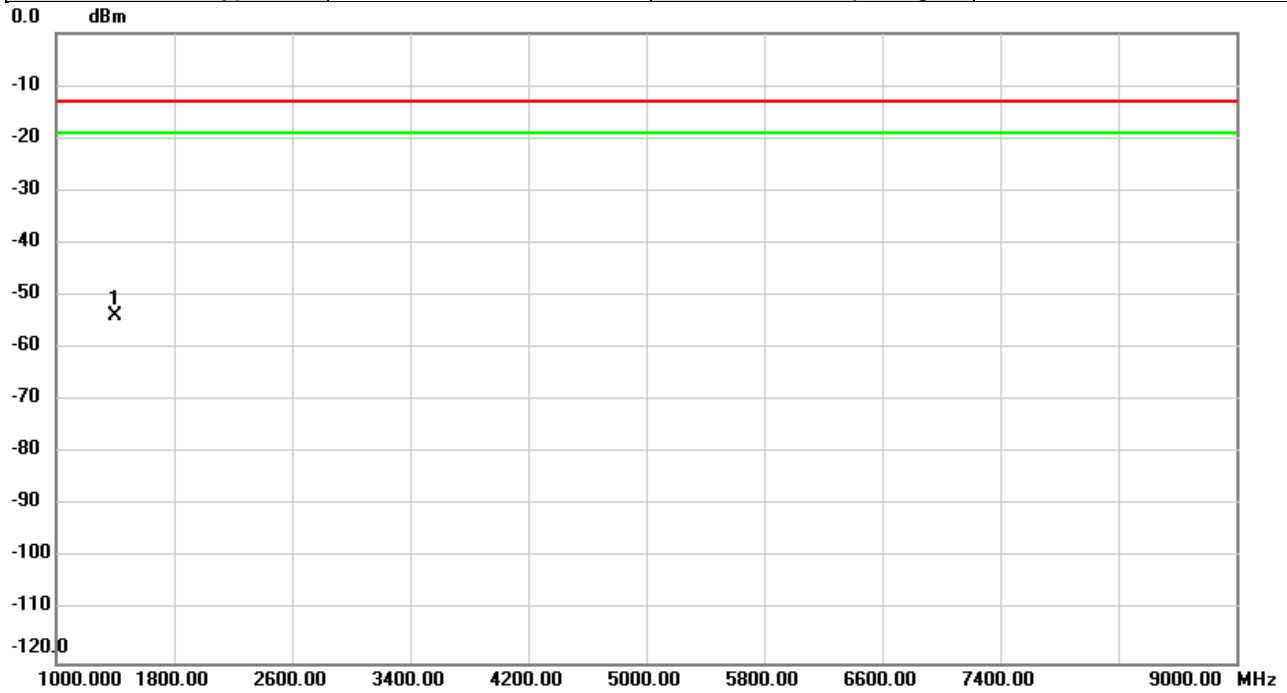

No.	Mk.	Freq.	Reading Level	Correct Factor	Measurement	Limit	Over	Detector	Comment
		MHz	dBm	dB	dBm	dBm	dB		
1	*	1399.200	-45.39	-8.51	-53.90	-13.00	-40.90	peak	

REMARKS:

- (1) Measurement Value = Reading Level + Correct Factor.
- (2) Margin Level = Measurement Value - Limit Value.

Test Mode	NB-IOT Band 12	Test Date	2020/11/10
Test Channel	CH23017	Polarization	Horizontal
Temp	23°C	Hum.	64%
Modulation Type	QPSK	Sub-carrier Spacing	3.75KHz

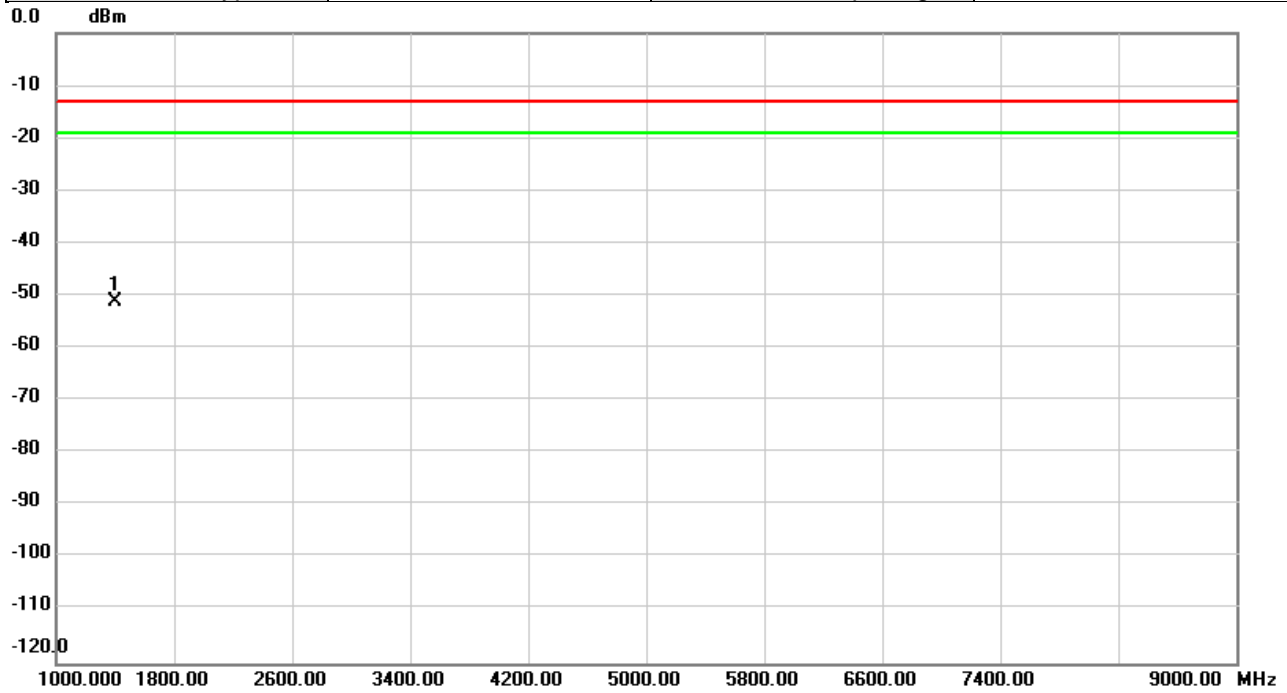

No.	Mk.	Freq.	Reading Level	Correct Factor	Measurement	Limit	Over	Detector	Comment
		MHz	dBm	dB	dBm	dBm	dB		
1	*	1399.467	-44.30	-6.96	-51.26	-13.00	-38.26	peak	

**REMARKS:**

- (1) Measurement Value = Reading Level + Correct Factor.
- (2) Margin Level = Measurement Value - Limit Value.



Test Mode	NB-IOT Band 12	Test Date	2020/11/10
Test Channel	CH23017	Polarization	Vertical
Temp	23°C	Hum.	64%
Modulation Type	QPSK	Sub-carrier Spacing	15KHz

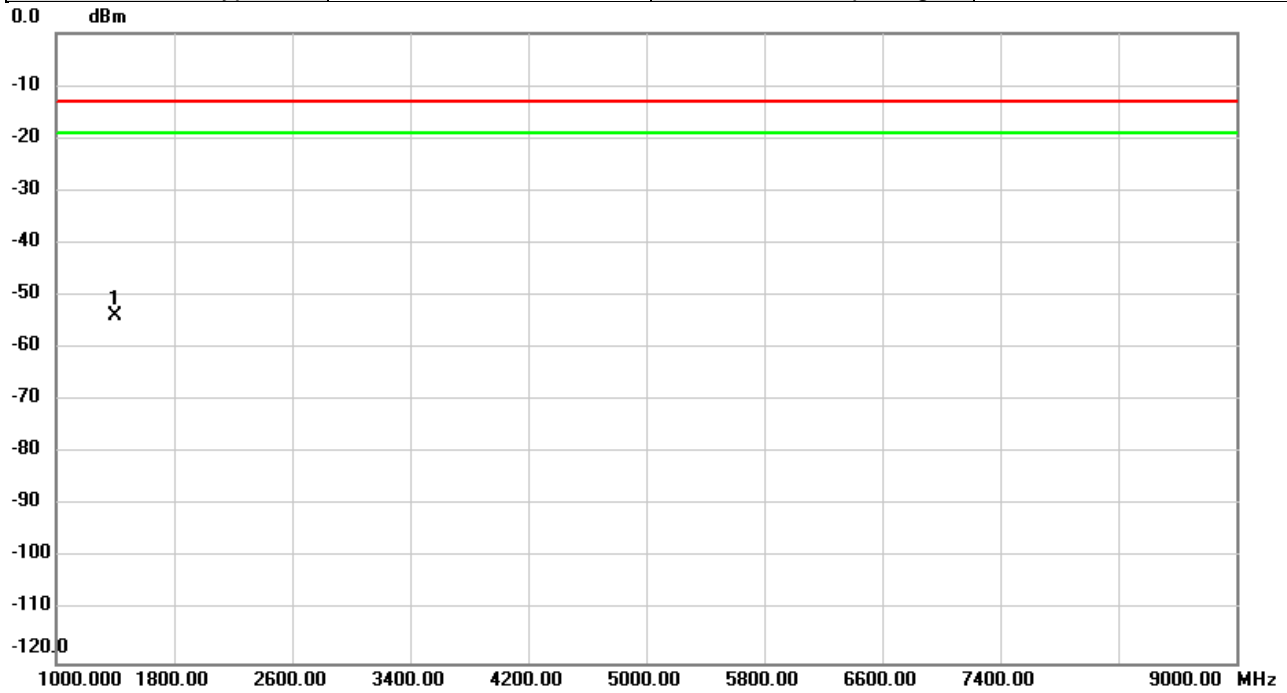

No.	Mk.	Freq.	Reading Level	Correct Factor	Measurement	Limit	Over	Detector	Comment
		MHz	dBm	dB	dBm	dBm	dB		
1	*	1399.200	-45.46	-8.51	-53.97	-13.00	-40.97	peak	

REMARKS:  
 (1) Measurement Value = Reading Level + Correct Factor.  
 (2) Margin Level = Measurement Value - Limit Value.

Test Mode	NB-IOT Band 12	Test Date	2020/11/10
Test Channel	CH23017	Polarization	Horizontal
Temp	23°C	Hum.	64%
Modulation Type	QPSK	Sub-carrier Spacing	15KHz

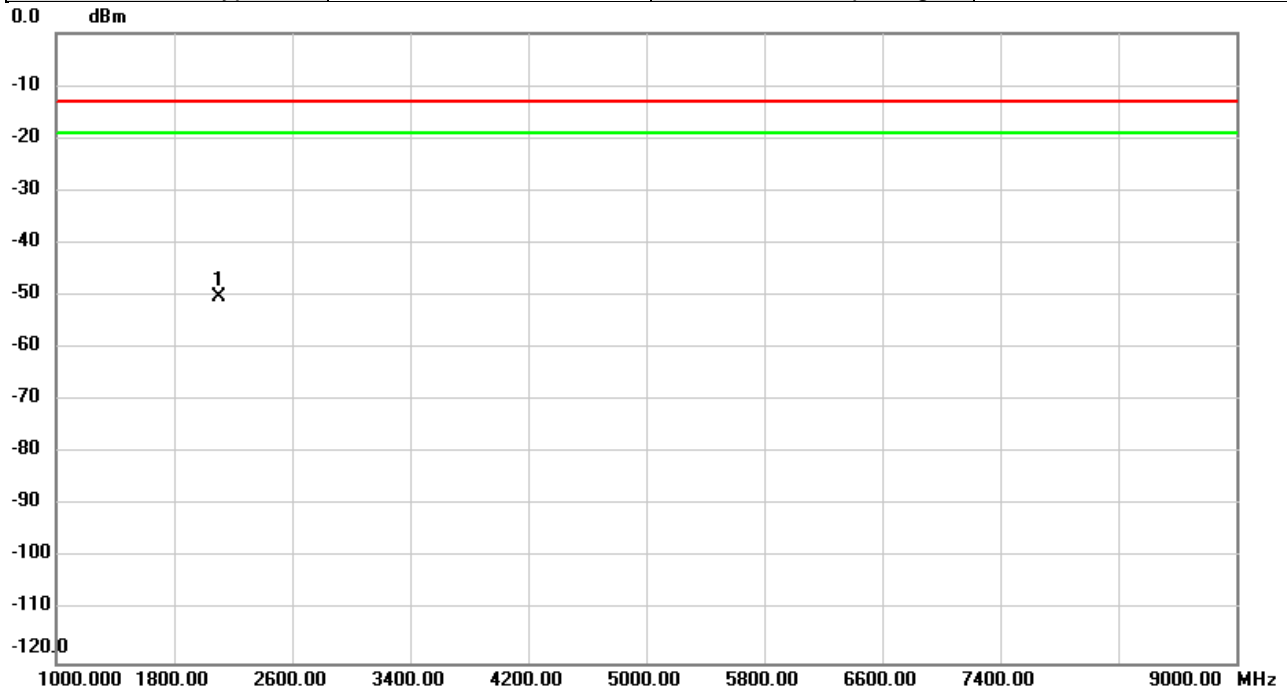

No.	Mk.	Freq.	Reading Level	Correct Factor	Measurement	Limit	Over	Detector	Comment
		MHz	dBm	dB	dBm	dBm	dB		
1	*	2099.200	-44.54	-5.65	-50.19	-13.00	-37.19	peak	

**REMARKS:**

- (1) Measurement Value = Reading Level + Correct Factor.
- (2) Margin Level = Measurement Value - Limit Value.

Test Mode	NB-IOT Band 12	Test Date	2020/11/10
Test Channel	CH23095	Polarization	Vertical
Temp	23°C	Hum.	64%
Modulation Type	QPSK	Sub-carrier Spacing	3.75KHz

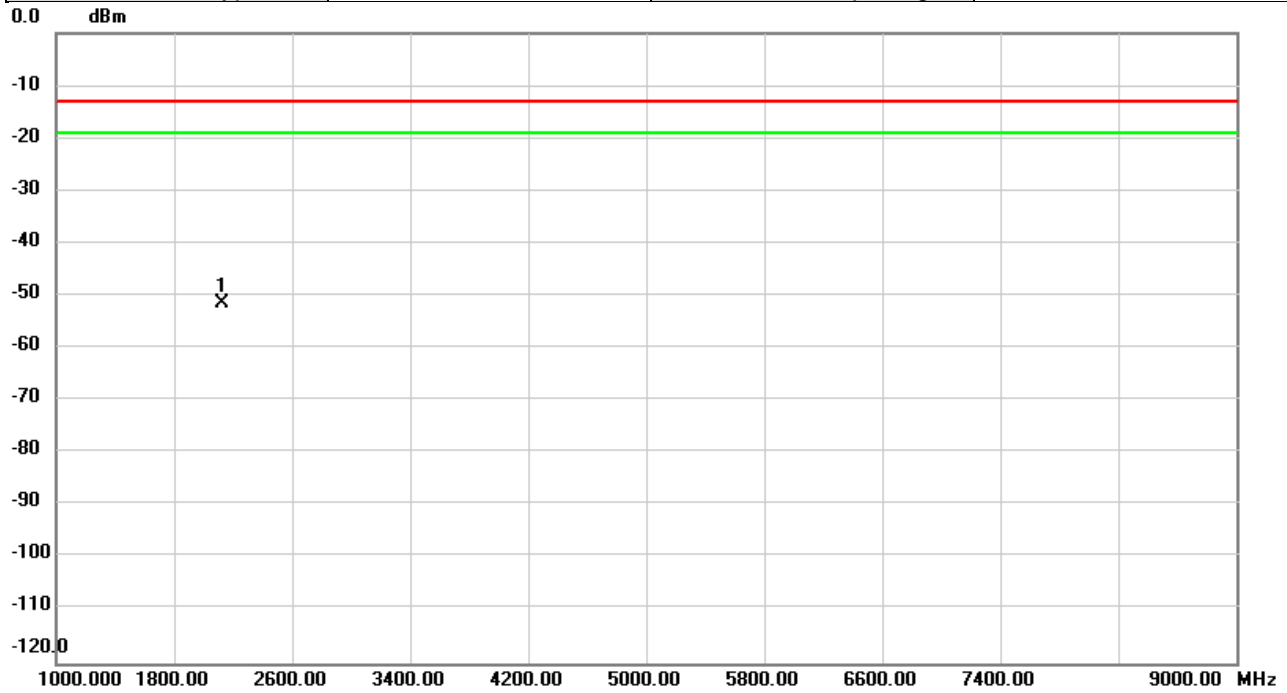

No.	Mk.	Freq.	Reading Level	Correct Factor	Measurement	Limit	Over	Detector	Comment
		MHz	dBm	dB	dBm	dBm	dB		
1	*	2122.133	-46.62	-4.96	-51.58	-13.00	-38.58	peak	

REMARKS:

- (1) Measurement Value = Reading Level + Correct Factor.
- (2) Margin Level = Measurement Value - Limit Value.

Test Mode	NB-IOT Band 12	Test Date	2020/11/10
Test Channel	CH23095	Polarization	Horizontal
Temp	23°C	Hum.	64%
Modulation Type	QPSK	Sub-carrier Spacing	3.75KHz

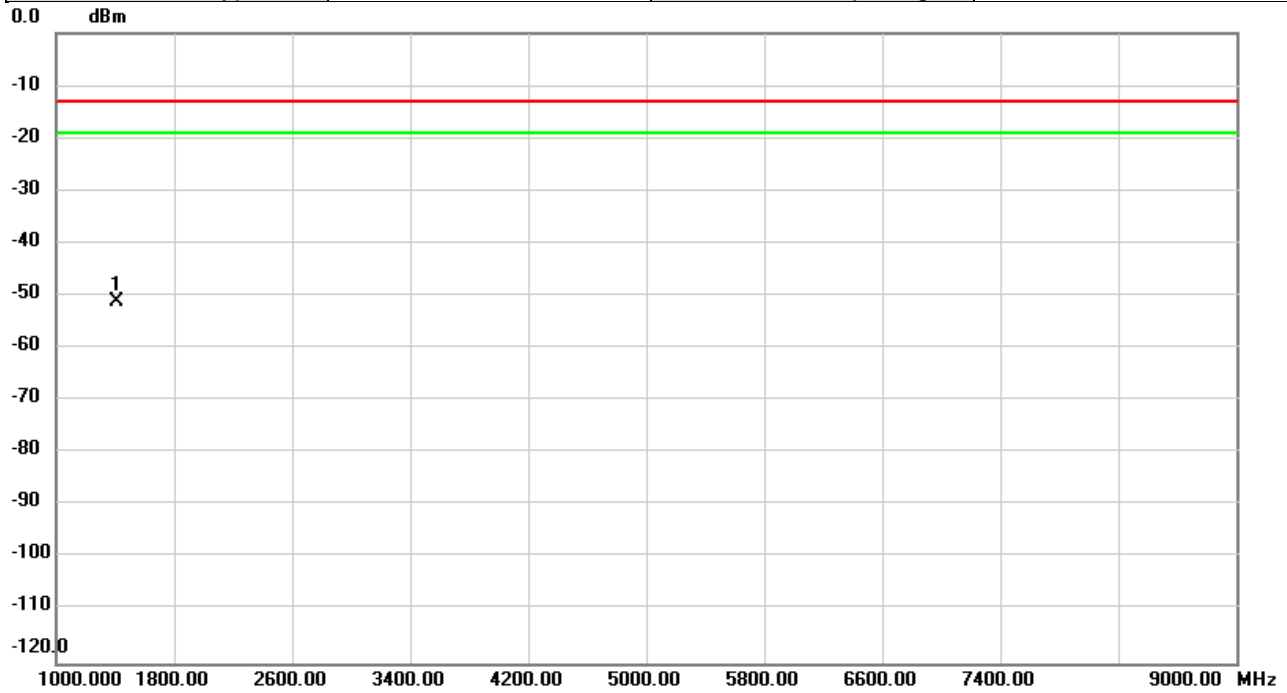

No.	Mk.	Freq.	Reading Level	Correct Factor	Measurement	Limit	Over	Detector	Comment
		MHz	dBm	dB	dBm	dBm	dB		
1	*	1415.200	-43.85	-7.25	-51.10	-13.00	-38.10	peak	

REMARKS:

- (1) Measurement Value = Reading Level + Correct Factor.
- (2) Margin Level = Measurement Value - Limit Value.

Test Mode	NB-IOT Band 12	Test Date	2020/11/10
Test Channel	CH23095	Polarization	Vertical
Temp	23°C	Hum.	64%
Modulation Type	QPSK	Sub-carrier Spacing	15KHz

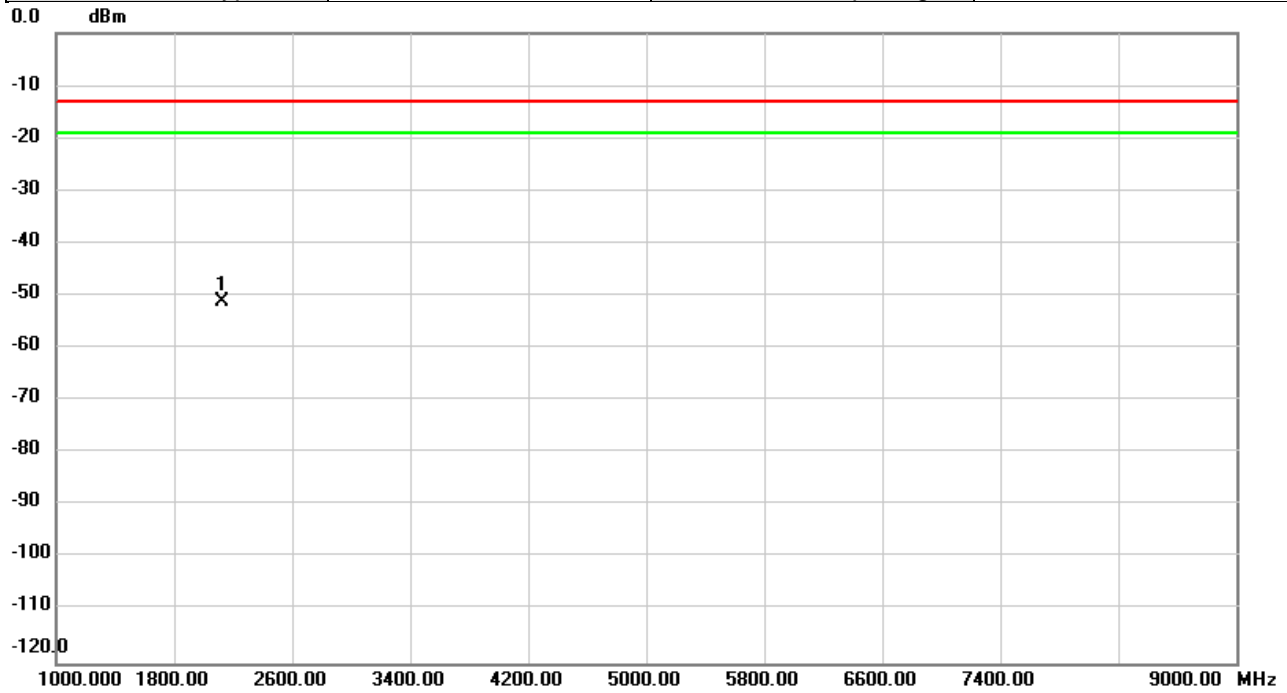

No.	Mk.	Freq.	Reading Level	Correct Factor	Measurement	Limit	Over	Detector	Comment
		MHz	dBm	dB	dBm	dBm	dB		
1	*	2122.400	-46.11	-4.95	-51.06	-13.00	-38.06	peak	

REMARKS:  
 (1) Measurement Value = Reading Level + Correct Factor.  
 (2) Margin Level = Measurement Value - Limit Value.

Test Mode	NB-IOT Band 12	Test Date	2020/11/10
Test Channel	CH23095	Polarization	Horizontal
Temp	23°C	Hum.	64%
Modulation Type	QPSK	Sub-carrier Spacing	15KHz

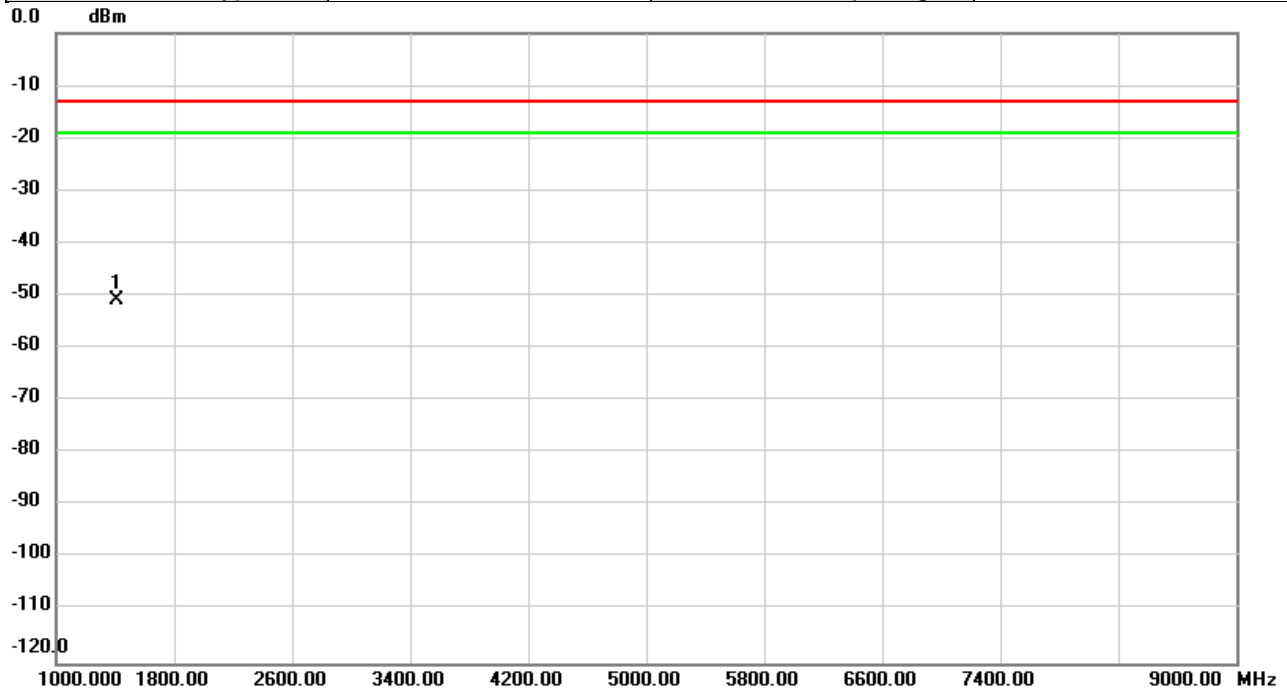

No.	Mk.	Freq.	Reading Level	Correct Factor	Measurement	Limit	Over	Detector	Comment
		MHz	dBm	dB	dBm	dBm	dB		
1	*	1414.933	-43.68	-7.24	-50.92	-13.00	-37.92	peak	

REMARKS:  
 (1) Measurement Value = Reading Level + Correct Factor.  
 (2) Margin Level = Measurement Value - Limit Value.

Test Mode	NB-IOT Band 12	Test Date	2020/11/10
Test Channel	CH23173	Polarization	Vertical
Temp	23°C	Hum.	64%
Modulation Type	QPSK	Sub-carrier Spacing	3.75KHz

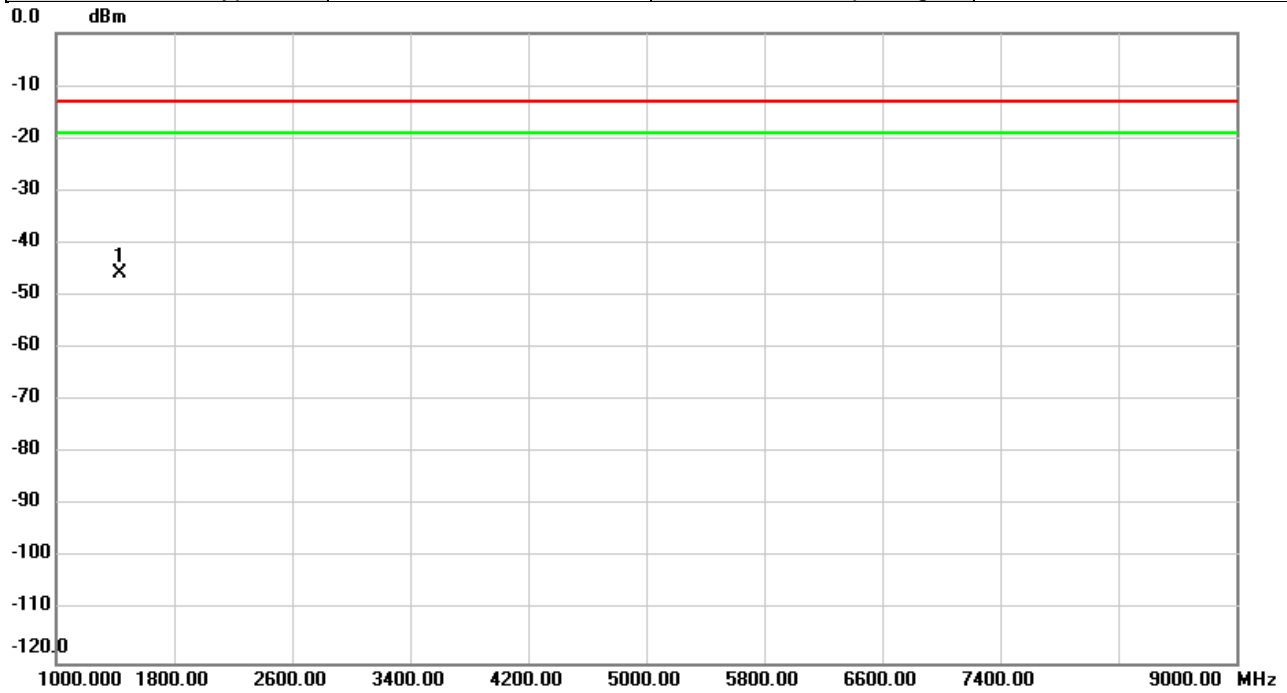

No.	Mk.	Freq.	Reading Level	Correct Factor	Measurement	Limit	Over	Detector	Comment
		MHz	dBm	dB	dBm	dBm	dB		
1	*	1430.400	-37.18	-8.42	-45.60	-13.00	-32.60	peak	

REMARKS:

- (1) Measurement Value = Reading Level + Correct Factor.
- (2) Margin Level = Measurement Value - Limit Value.

Test Mode	NB-IOT Band 12	Test Date	2020/11/10
Test Channel	CH23173	Polarization	Horizontal
Temp	23°C	Hum.	64%
Modulation Type	QPSK	Sub-carrier Spacing	3.75KHz

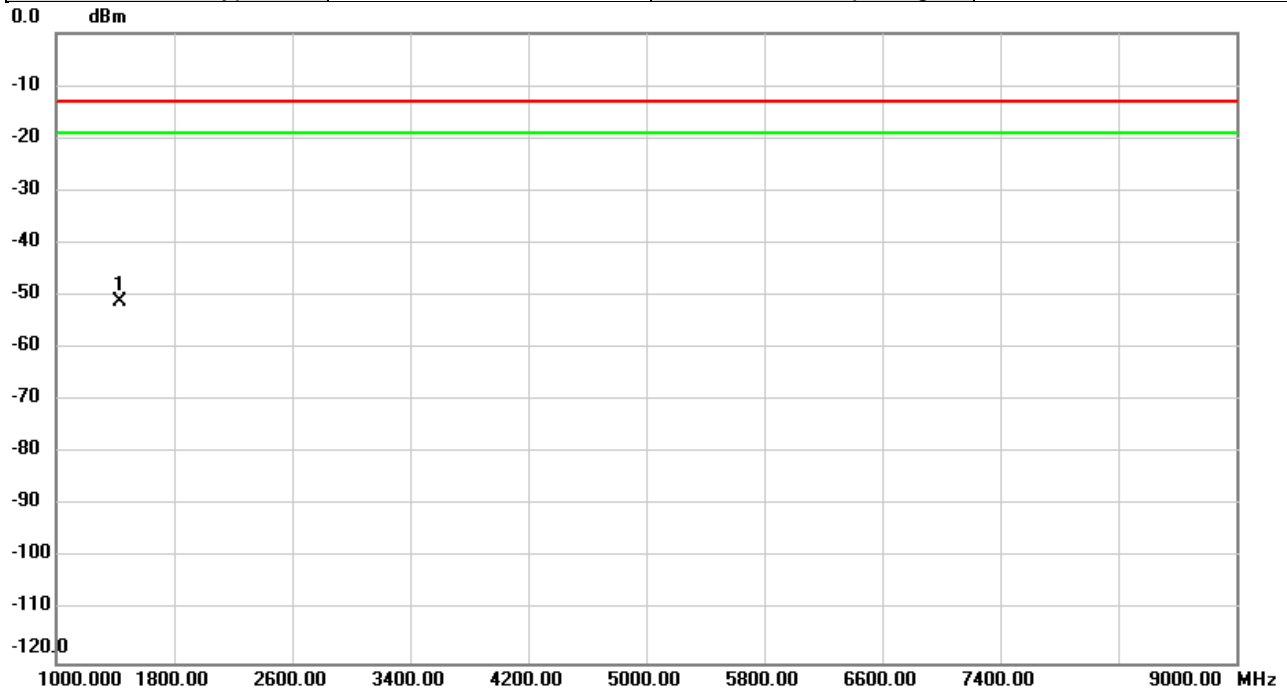

No.	Mk.	Freq.	Reading Level	Correct Factor	Measurement	Limit	Over	Detector	Comment
		MHz	dBm	dB	dBm	dBm	dB		
1	*	1430.400	-43.66	-7.56	-51.22	-13.00	-38.22	peak	

REMARKS:  
 (1) Measurement Value = Reading Level + Correct Factor.  
 (2) Margin Level = Measurement Value - Limit Value.



Test Mode	NB-IOT Band 12	Test Date	2020/11/10
Test Channel	CH23173	Polarization	Vertical
Temp	23°C	Hum.	64%
Modulation Type	QPSK	Sub-carrier Spacing	15KHz

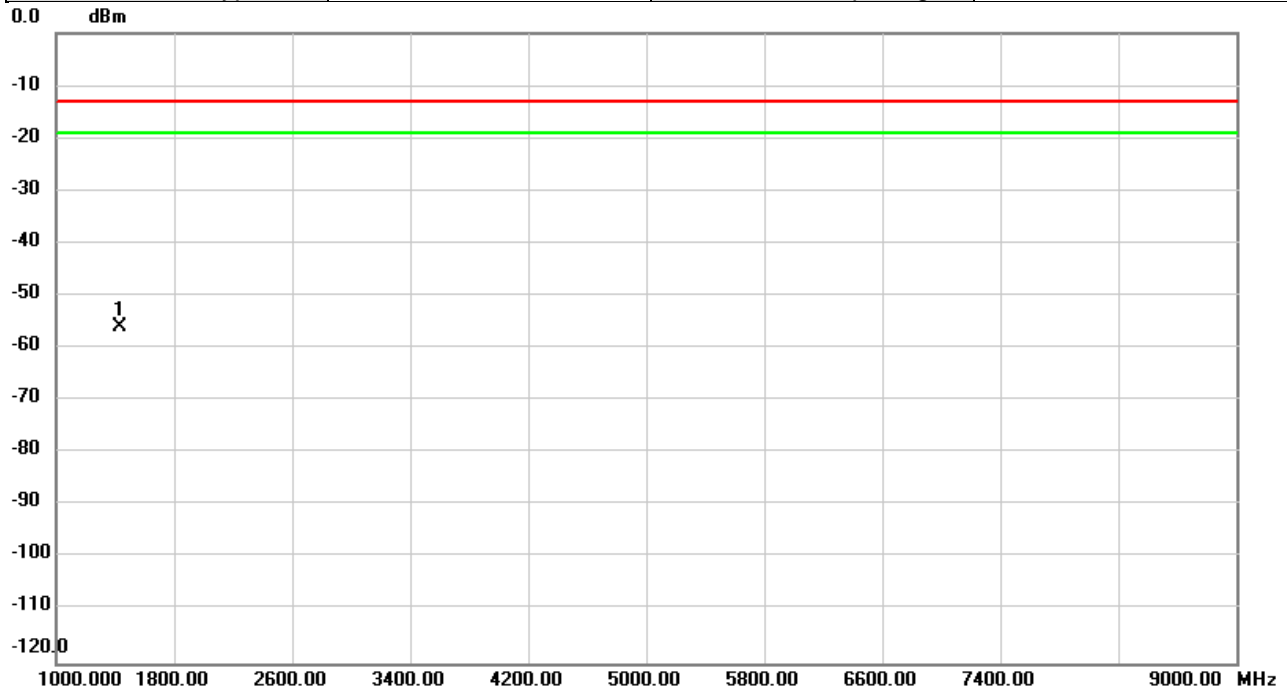

No.	Mk.	Freq.	Reading Level	Correct Factor	Measurement	Limit	Over	Detector	Comment
		MHz	dBm	dB	dBm	dBm	dB		
1	*	1430.400	-47.54	-8.42	-55.96	-13.00	-42.96	peak	

**REMARKS:**

- (1) Measurement Value = Reading Level + Correct Factor.
- (2) Margin Level = Measurement Value - Limit Value.

Test Mode	NB-IOT Band 12	Test Date	2020/11/10
Test Channel	CH23173	Polarization	Horizontal
Temp	23°C	Hum.	64%
Modulation Type	QPSK	Sub-carrier Spacing	15KHz

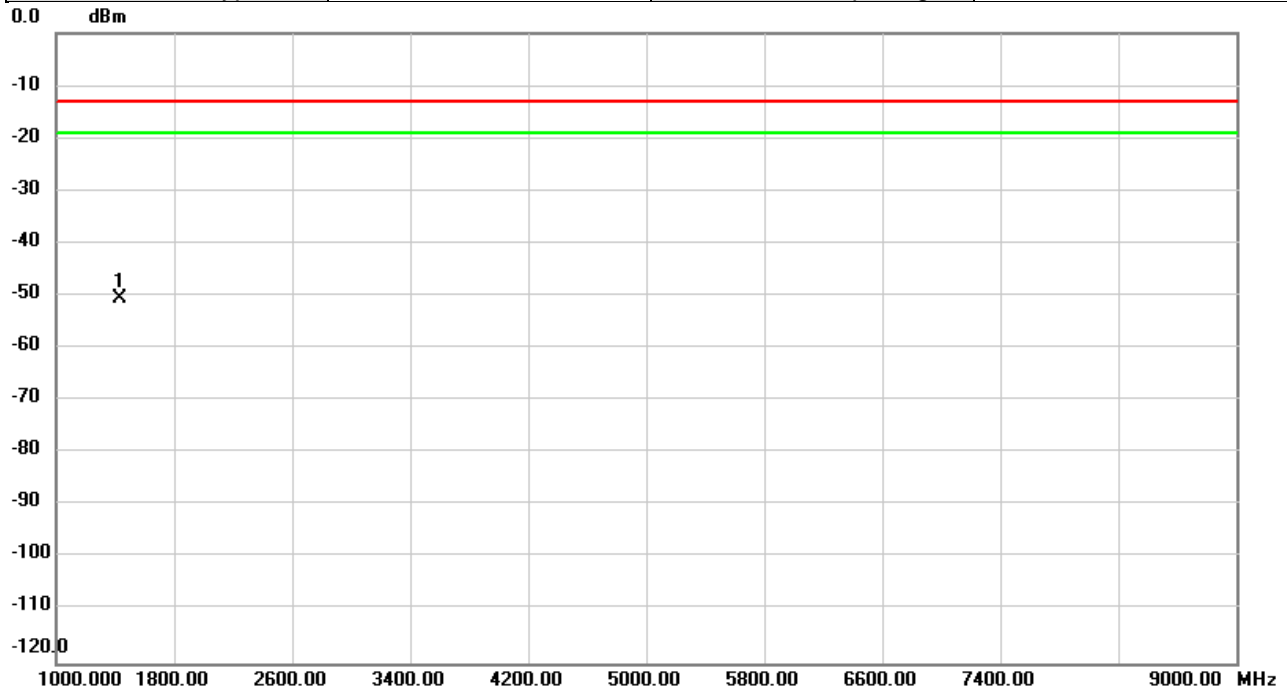

No.	Mk.	Freq.	Reading Level	Correct Factor	Measurement	Limit	Over	Detector	Comment
		MHz	dBm	dB	dBm	dBm	dB		
1	*	1430.400	-43.03	-7.56	-50.59	-13.00	-37.59	peak	

REMARKS:

- (1) Measurement Value = Reading Level + Correct Factor.
- (2) Margin Level = Measurement Value - Limit Value.

Test Mode	NB-IOT Band 12	Test Date	2020/11/10
Test Channel	CH23095	Polarization	Vertical
Temp	23°C	Hum.	64%
Modulation Type	BPSK	Sub-carrier Spacing	15KHz

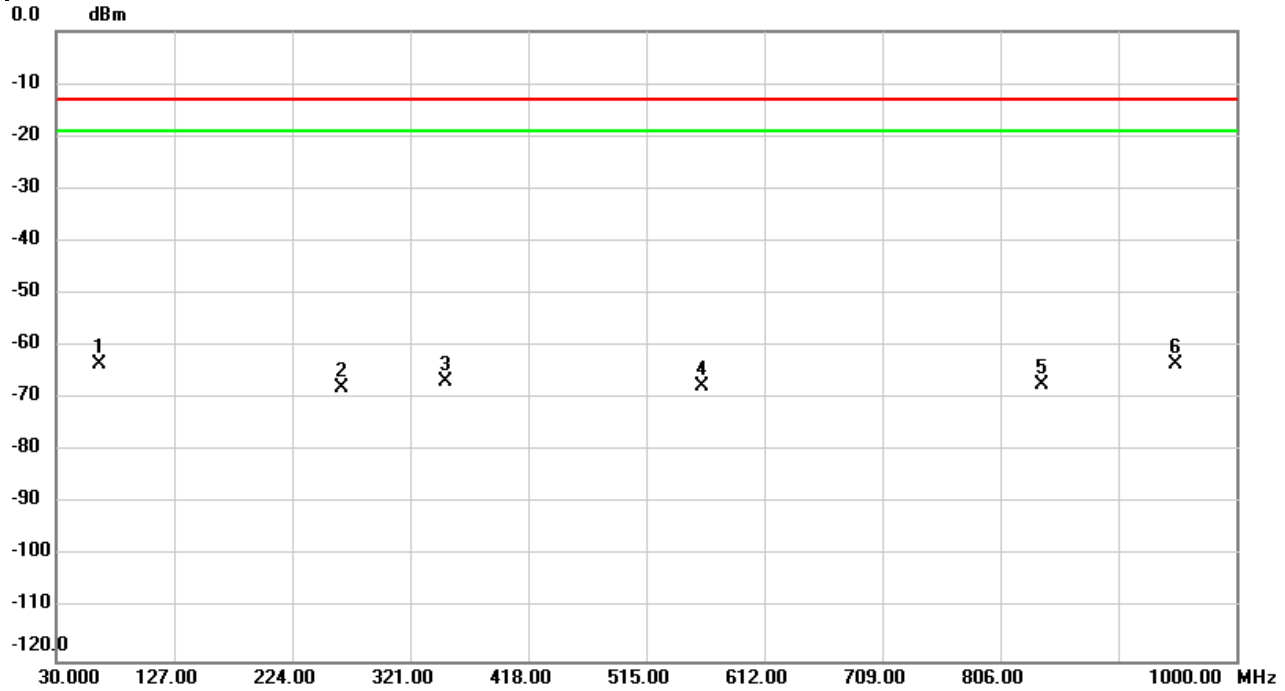

No.	Mk.	Freq.	Reading Level	Correct Factor	Measurement	Limit	Over	Detector	Comment
		MHz	dBm	dB	dBm	dBm	dB		
1	*	65.8253	-61.47	-1.96	-63.43	-13.00	-50.43	peak	
2		264.9663	-75.62	7.69	-67.93	-13.00	-54.93	peak	
3		350.1323	-73.35	6.63	-66.72	-13.00	-53.72	peak	
4		560.7840	-77.31	9.70	-67.61	-13.00	-54.61	peak	
5		840.2410	-77.13	9.67	-67.46	-13.00	-54.46	peak	
6		950.6593	-76.11	12.62	-63.49	-13.00	-50.49	peak	

REMARKS:  
 (1) Measurement Value = Reading Level + Correct Factor.  
 (2) Margin Level = Measurement Value - Limit Value.

Test Mode	NB-IOT Band 12	Test Date	2020/11/10
Test Channel	CH23095	Polarization	Horizontal
Temp	23°C	Hum.	64%
Modulation Type	BPSK	Sub-carrier Spacing	15KHz

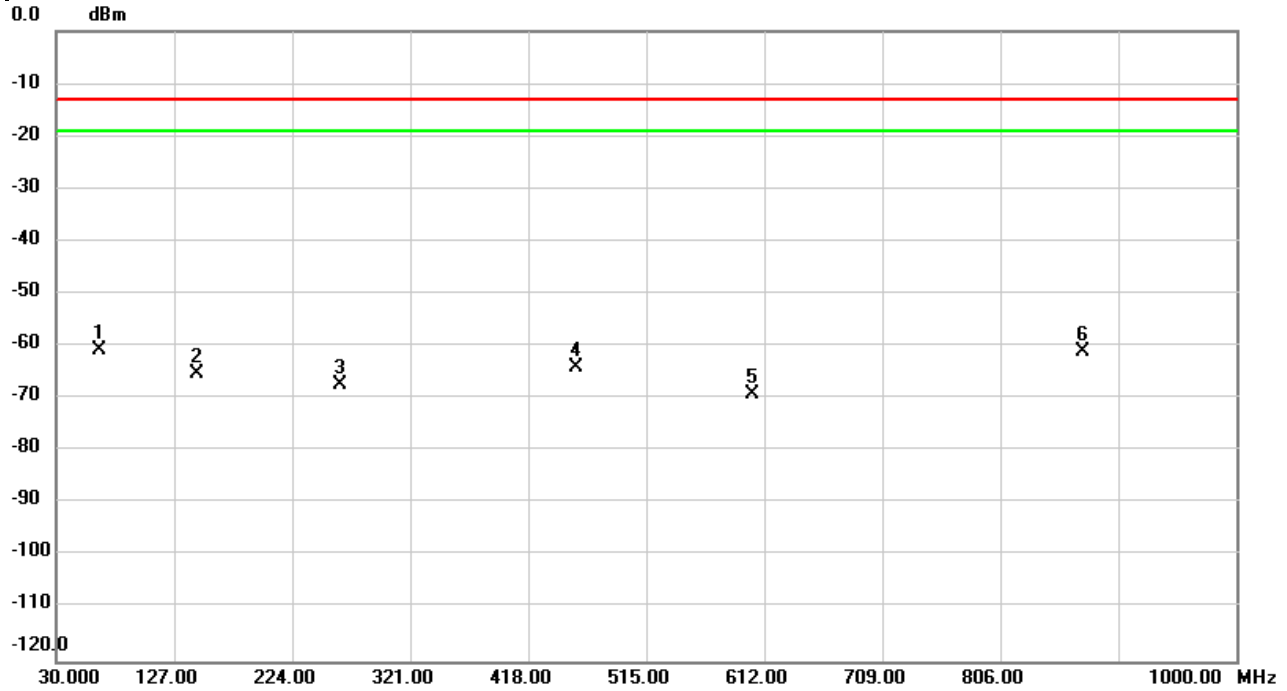

No.	Mk.	Freq. MHz	Reading Level dBm	Correct Factor dB	Measure- ment dBm	Limit dBm	Over dB	Detector	Comment
1	*	65.1787	-66.24	5.54	-60.70	-13.00	-47.70	peak	
2		145.7857	-68.17	2.81	-65.36	-13.00	-52.36	peak	
3		264.0610	-67.00	-0.26	-67.26	-13.00	-54.26	peak	
4		457.8023	-76.41	12.41	-64.00	-13.00	-51.00	peak	
5		602.7527	-76.35	7.24	-69.11	-13.00	-56.11	peak	
6		874.4173	-77.21	16.08	-61.13	-13.00	-48.13	peak	

REMARKS:  
 (1) Measurement Value = Reading Level + Correct Factor.  
 (2) Margin Level = Measurement Value - Limit Value.

Test Mode	NB-IOT Band 12	Test Date	2020/11/10
Test Channel	CH23017	Polarization	Horizontal
Temp	23°C	Hum.	64%
Modulation Type	BPSK	Sub-carrier Spacing	3.75KHz

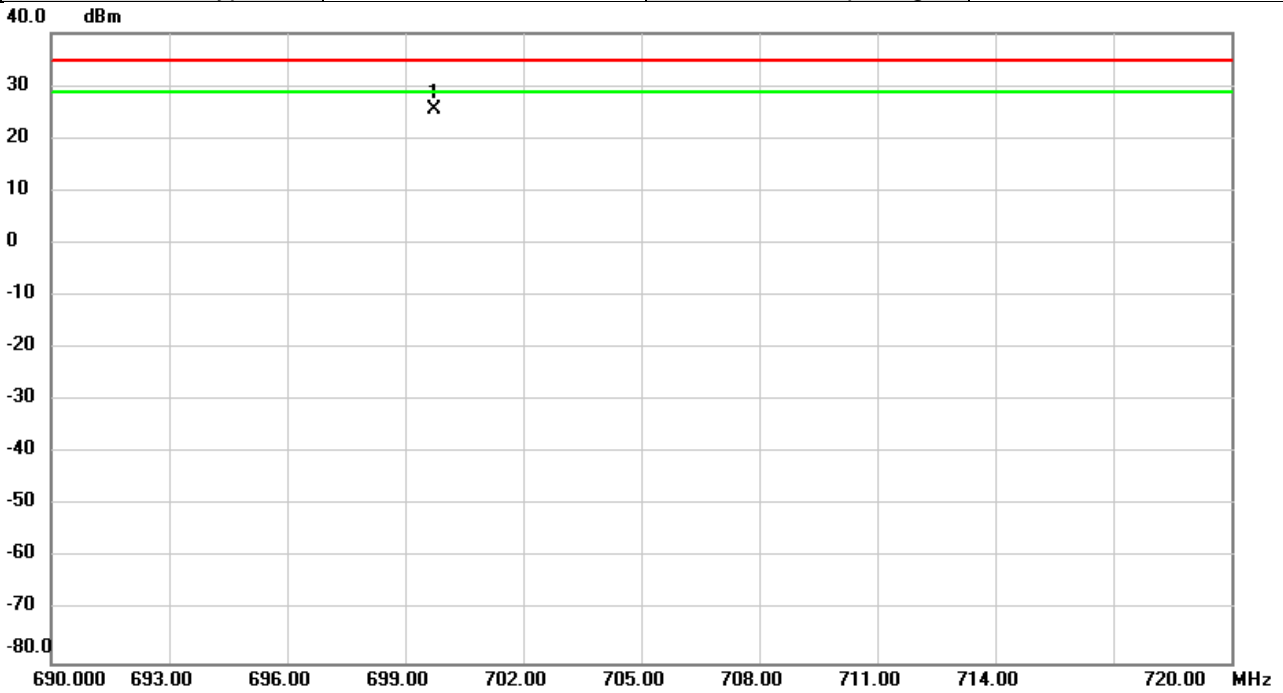

No.	Mk.	Freq.	Reading Level	Correct Factor	Measurement	Limit	Over	Detector	Comment
		MHz	dBm	dB	dBm	dBm	dB		
1	*	699.7540	14.08	11.52	25.60	34.77	-9.17	peak	

REMARKS:

- (1) Measurement Value = Reading Level + Correct Factor.
- (2) Margin Level = Measurement Value - Limit Value.

Test Mode	NB-IOT Band 12	Test Date	2020/11/10
Test Channel	CH23017	Polarization	Vertical
Temp	23°C	Hum.	64%
Modulation Type	BPSK	Sub-carrier Spacing	3.75KHz

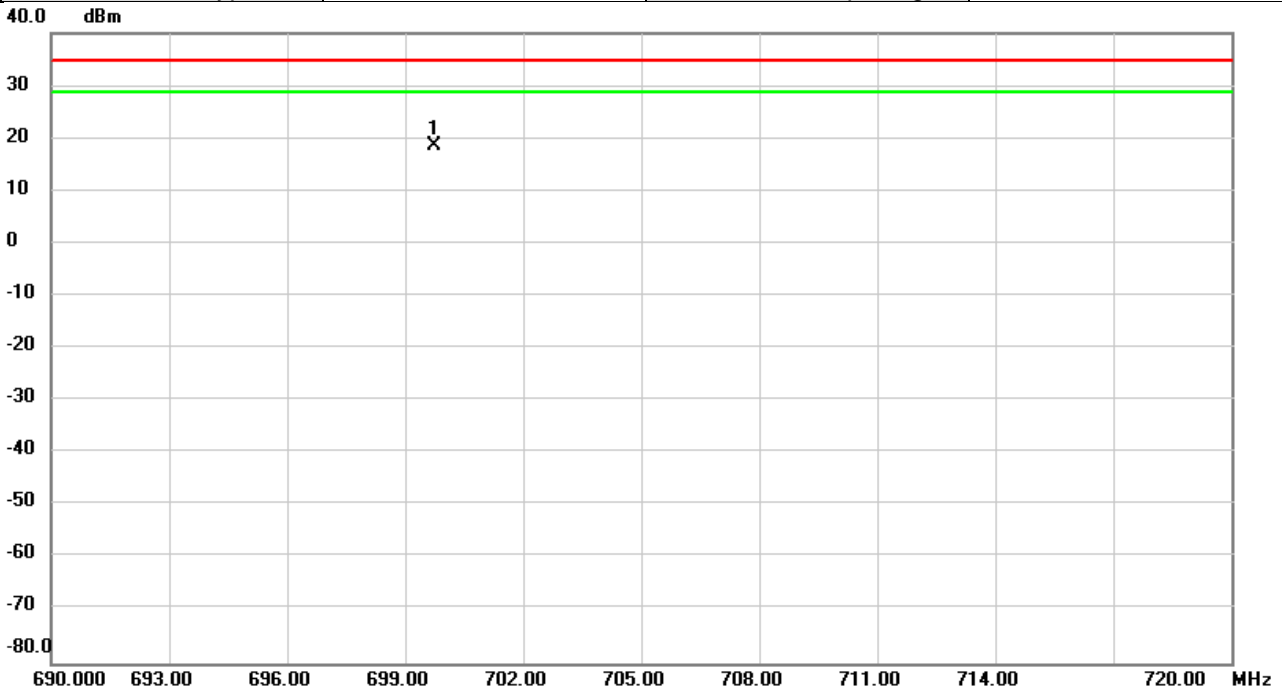

No.	Mk.	Freq.	Reading Level	Correct Factor	Measurement	Limit	Over	Detector	Comment
		MHz	dBm	dB	dBm	dBm	dB		
1	*	699.7580	3.77	14.81	18.58	34.77	-16.19	peak	

REMARKS:

- (1) Measurement Value = Reading Level + Correct Factor.
- (2) Margin Level = Measurement Value - Limit Value.

Test Mode	NB-IOT Band 12	Test Date	2020/11/10
Test Channel	CH23017	Polarization	Vertical
Temp	23°C	Hum.	64%
Modulation Type	BPSK	Sub-carrier Spacing	15KHz

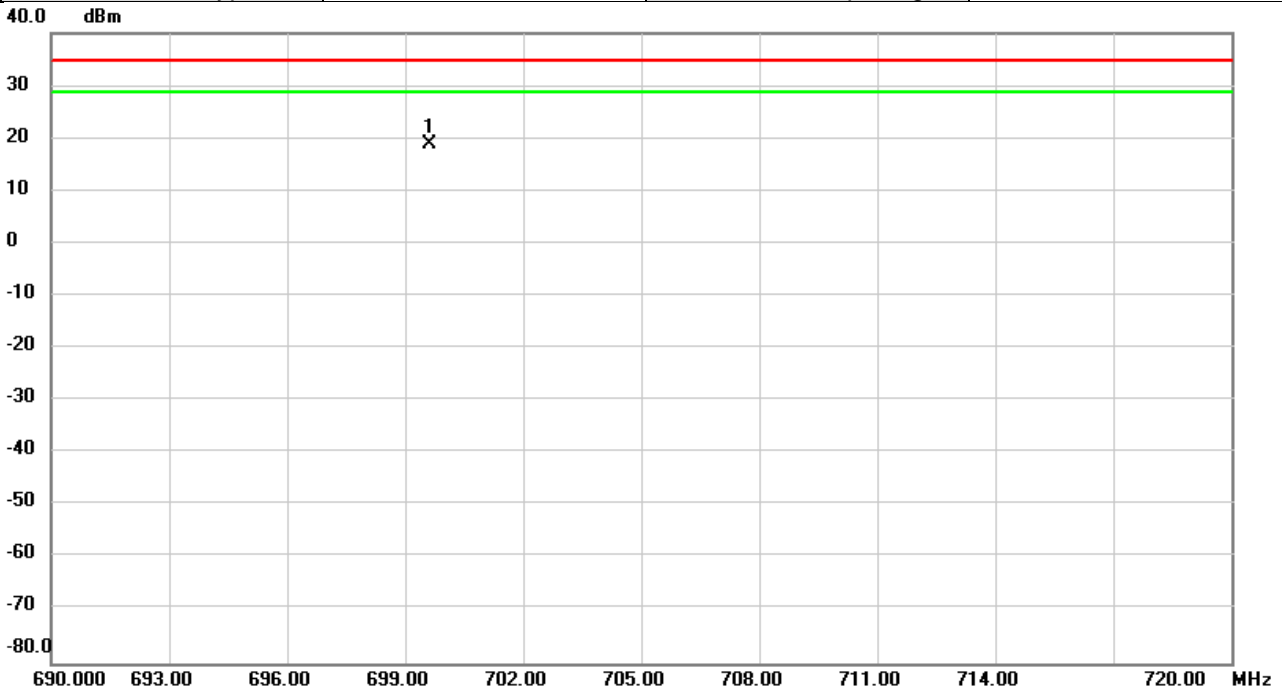

No.	Mk.	Freq.	Reading Level	Correct Factor	Measurement	Limit	Over	Detector	Comment
		MHz	dBm	dB	dBm	dBm	dB		
1	*	699.6210	3.91	14.81	18.72	34.77	-16.05	peak	

**REMARKS:**

- (1) Measurement Value = Reading Level + Correct Factor.
- (2) Margin Level = Measurement Value - Limit Value.

Test Mode	NB-IOT Band 12	Test Date	2020/11/10
Test Channel	CH23017	Polarization	Horizontal
Temp	23°C	Hum.	64%
Modulation Type	BPSK	Sub-carrier Spacing	15KHz

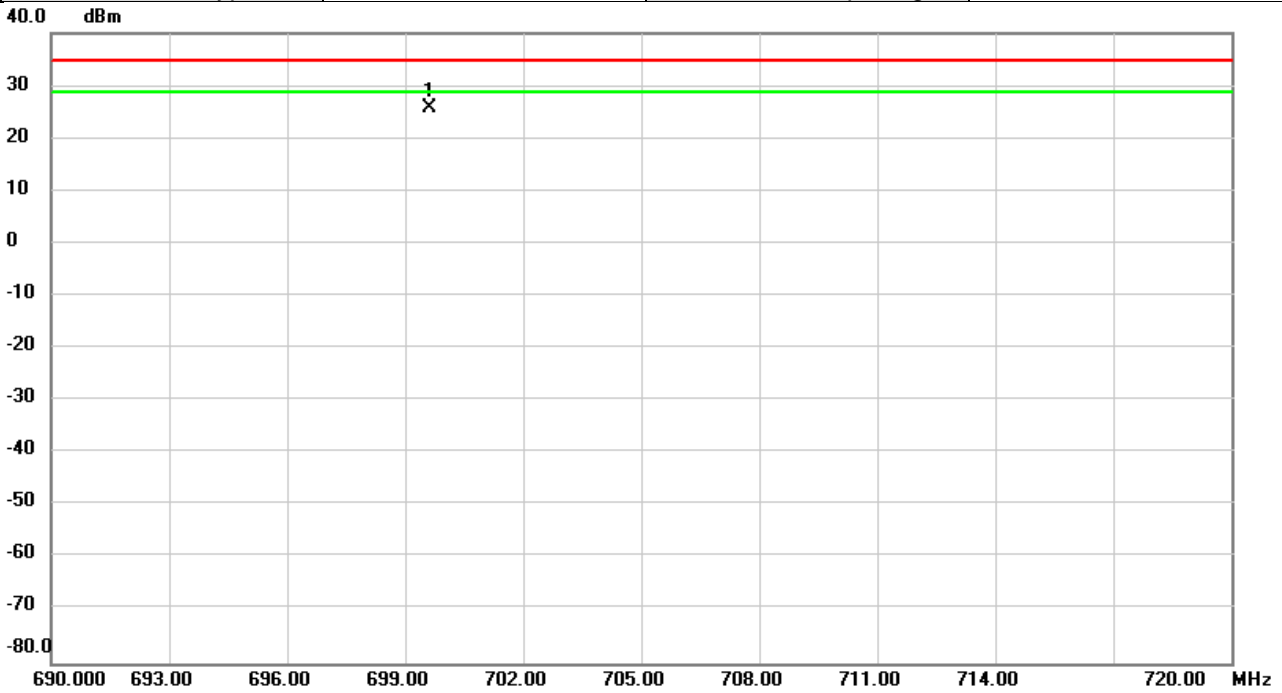

No.	Mk.	Freq.	Reading Level	Correct Factor	Measurement	Limit	Over	Detector	Comment
		MHz	dBm	dB	dBm	dBm	dB		
1	*	699.6320	14.38	11.51	25.89	34.77	-8.88	peak	

REMARKS:

- (1) Measurement Value = Reading Level + Correct Factor.
- (2) Margin Level = Measurement Value - Limit Value.



Test Mode	NB-IOT Band 12	Test Date	2020/11/10
Test Channel	CH23095	Polarization	Vertical
Temp	23°C	Hum.	64%
Modulation Type	BPSK	Sub-carrier Spacing	3.75KHz

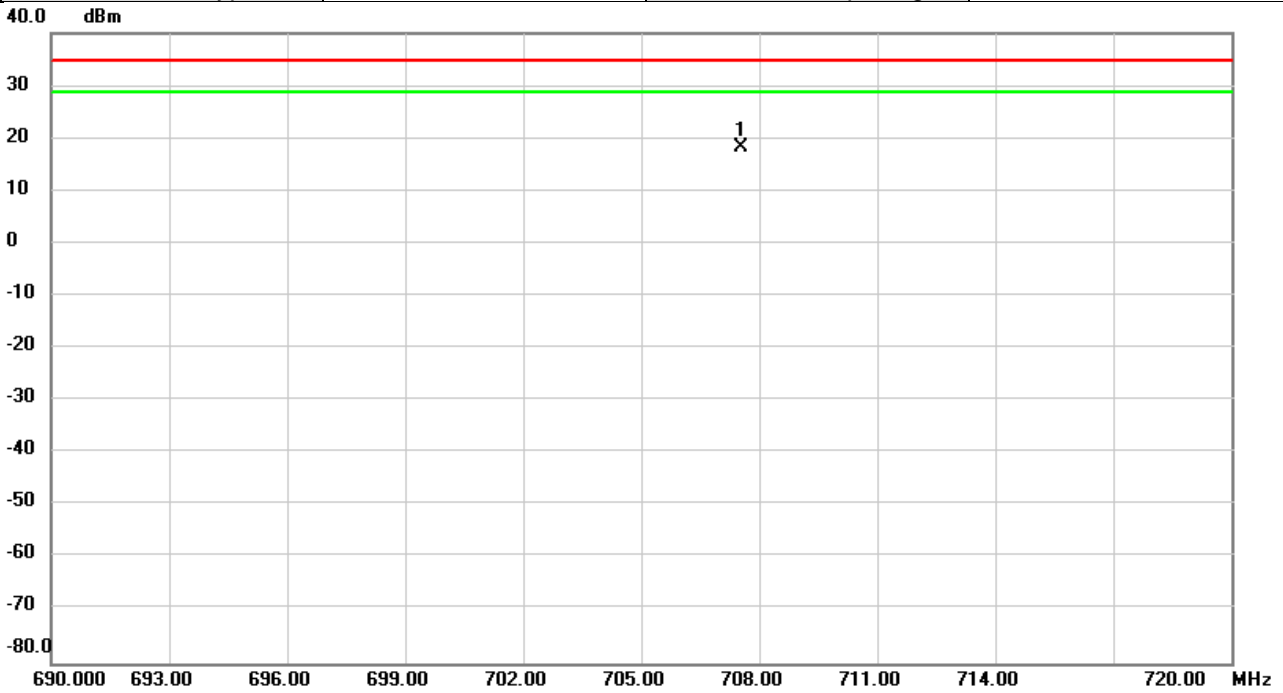

No.	Mk.	Freq.	Reading Level	Correct Factor	Measurement	Limit	Over	Detector	Comment
		MHz	dBm	dB	dBm	dBm	dB		
1	*	707.5580	3.72	14.64	18.36	34.77	-16.41	peak	

**REMARKS:**

- (1) Measurement Value = Reading Level + Correct Factor.
- (2) Margin Level = Measurement Value - Limit Value.

Test Mode	NB-IOT Band 12	Test Date	2020/11/10
Test Channel	CH23095	Polarization	Horizontal
Temp	23°C	Hum.	64%
Modulation Type	BPSK	Sub-carrier Spacing	3.75KHz

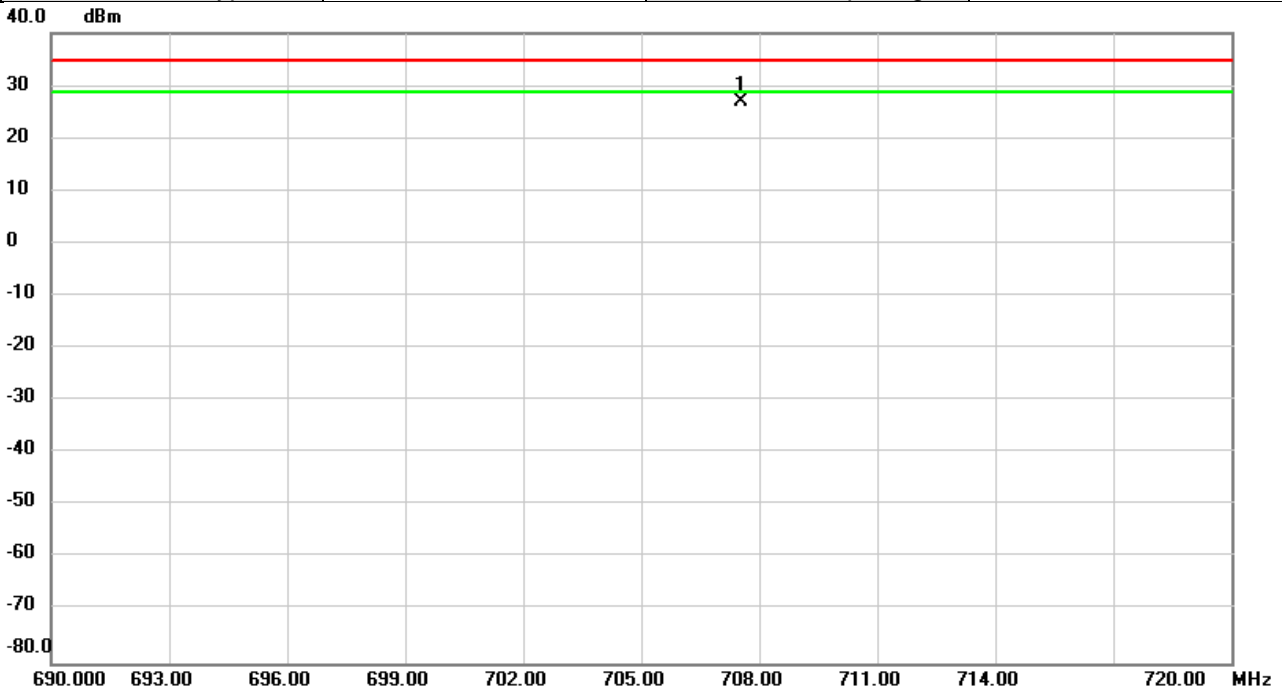

No.	Mk.	Freq.	Reading Level	Correct Factor	Measurement	Limit	Over	Detector	Comment
		MHz	dBm	dB	dBm	dBm	dB		
1	*	707.5540	14.94	12.04	26.98	34.77	-7.79	peak	

**REMARKS:**

- (1) Measurement Value = Reading Level + Correct Factor.
- (2) Margin Level = Measurement Value - Limit Value.

Test Mode	NB-IOT Band 12	Test Date	2020/11/10
Test Channel	CH23095	Polarization	Vertical
Temp	23°C	Hum.	64%
Modulation Type	BPSK	Sub-carrier Spacing	15KHz

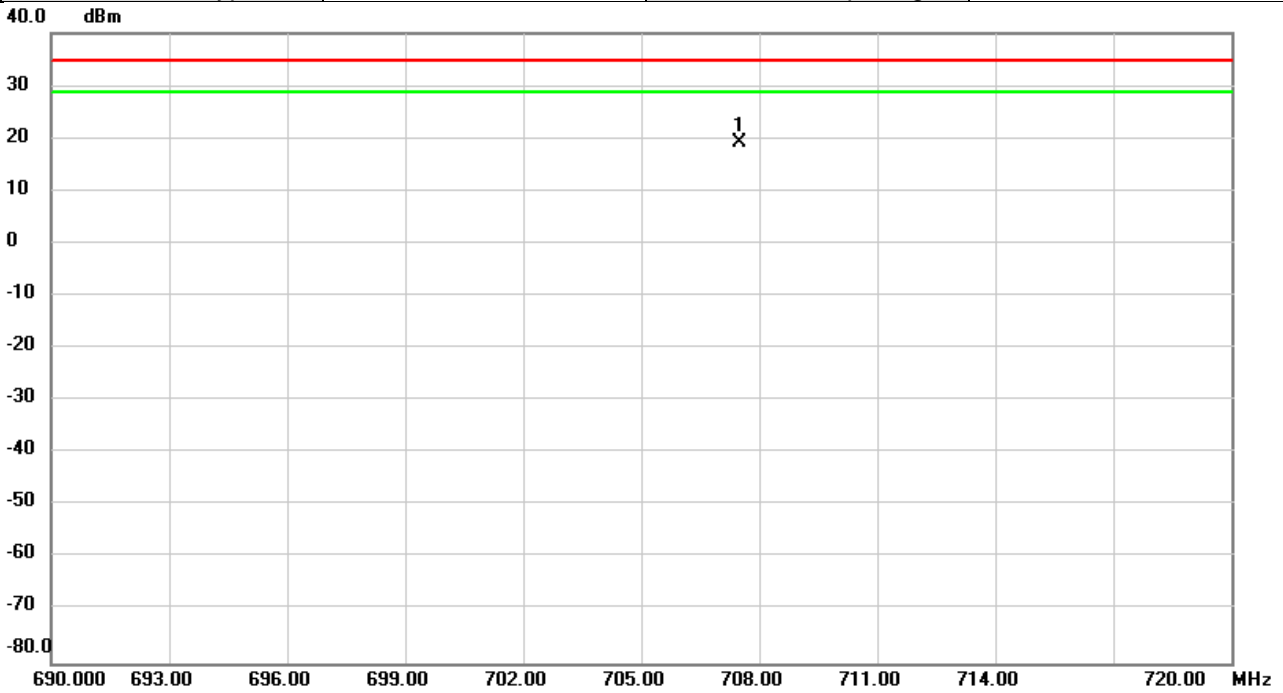

No.	Mk.	Freq.	Reading Level	Correct Factor	Measurement	Limit	Over	Detector	Comment
		MHz	dBm	dB	dBm	dBm	dB		
1	*	707.4870	4.46	14.65	19.11	34.77	-15.66	peak	

REMARKS:

- (1) Measurement Value = Reading Level + Correct Factor.
- (2) Margin Level = Measurement Value - Limit Value.

Test Mode	NB-IOT Band 12	Test Date	2020/11/10
Test Channel	CH23095	Polarization	Horizontal
Temp	23°C	Hum.	64%
Modulation Type	BPSK	Sub-carrier Spacing	15KHz

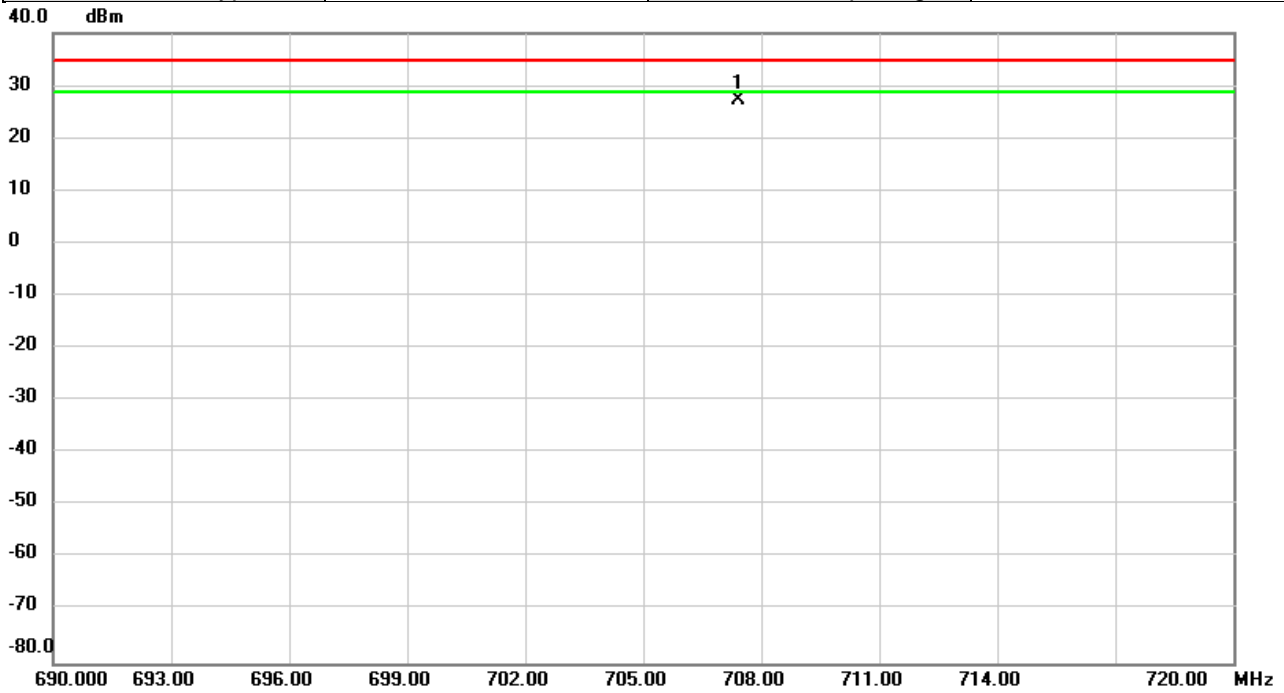

No.	Mk.	Freq. MHz	Reading Level dBm	Correct Factor dB	Measure- ment dBm	Limit dBm	Over dB	Detector	Comment
1	*	707.4280	15.17	12.03	27.20	34.77	-7.57	peak	

**REMARKS:**

- (1) Measurement Value = Reading Level + Correct Factor.
- (2) Margin Level = Measurement Value - Limit Value.

Test Mode	NB-IOT Band 12	Test Date	2020/11/10
Test Channel	CH23173	Polarization	Vertical
Temp	23°C	Hum.	64%
Modulation Type	BPSK	Sub-carrier Spacing	3.75KHz

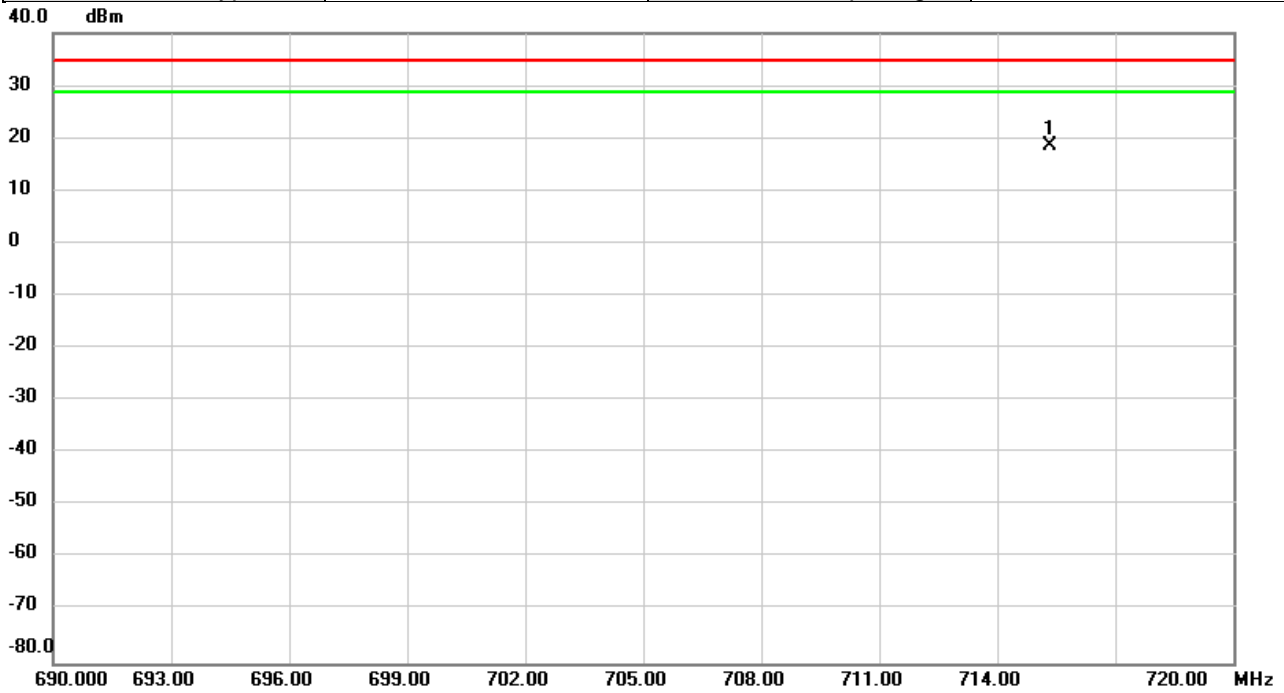

No.	Mk.	Freq. MHz	Reading Level dBm	Correct Factor dB	Measure- ment dBm	Limit dBm	Over dB	Detector	Comment
1	*	715.3590	4.12	14.47	18.59	34.77	-16.18	peak	

REMARKS:

- (1) Measurement Value = Reading Level + Correct Factor.
- (2) Margin Level = Measurement Value - Limit Value.

Test Mode	NB-IOT Band 12	Test Date	2020/11/10
Test Channel	CH23173	Polarization	Horizontal
Temp	23°C	Hum.	64%
Modulation Type	BPSK	Sub-carrier Spacing	3.75KHz

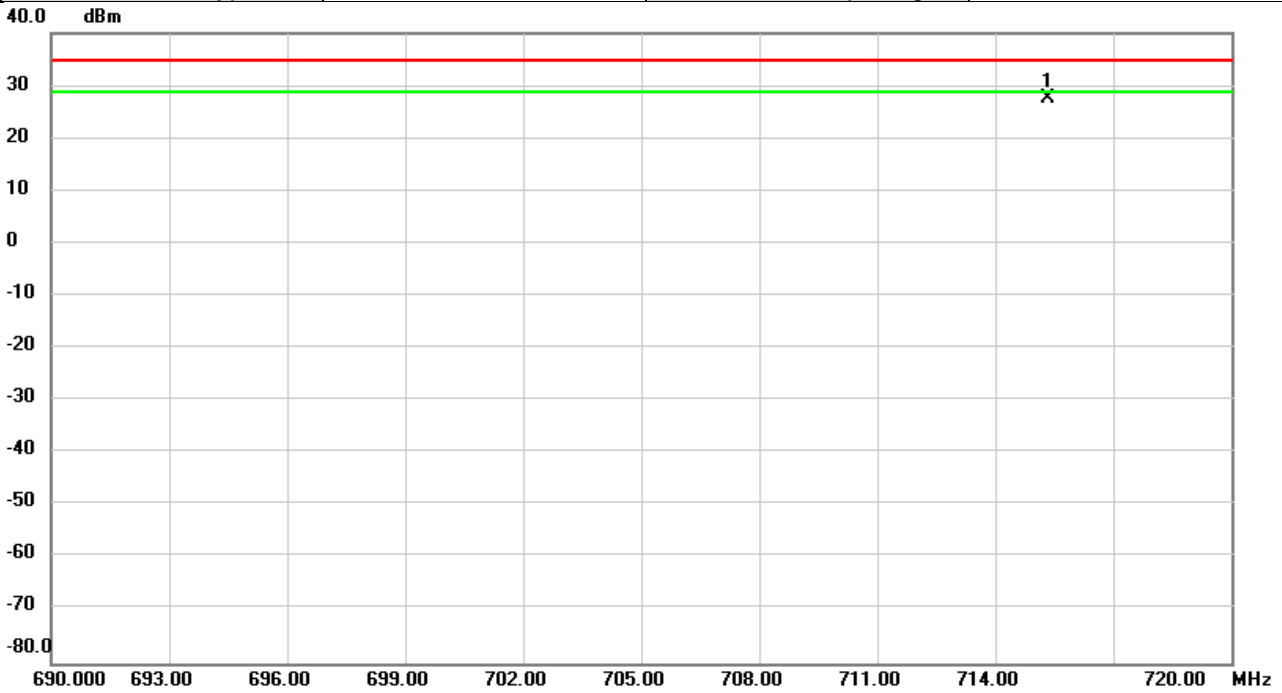

No.	Mk.	Freq.	Reading Level	Correct Factor	Measurement	Limit	Over	Detector	Comment
		MHz	dBm	dB	dBm	dBm	dB		
1	*	715.3490	14.97	12.57	27.54	34.77	-7.23	peak	

REMARKS:

- (1) Measurement Value = Reading Level + Correct Factor.
- (2) Margin Level = Measurement Value - Limit Value.

Test Mode	NB-IOT Band 12	Test Date	2020/11/10
Test Channel	CH23173	Polarization	Vertical
Temp	23°C	Hum.	64%
Modulation Type	BPSK	Sub-carrier Spacing	15KHz

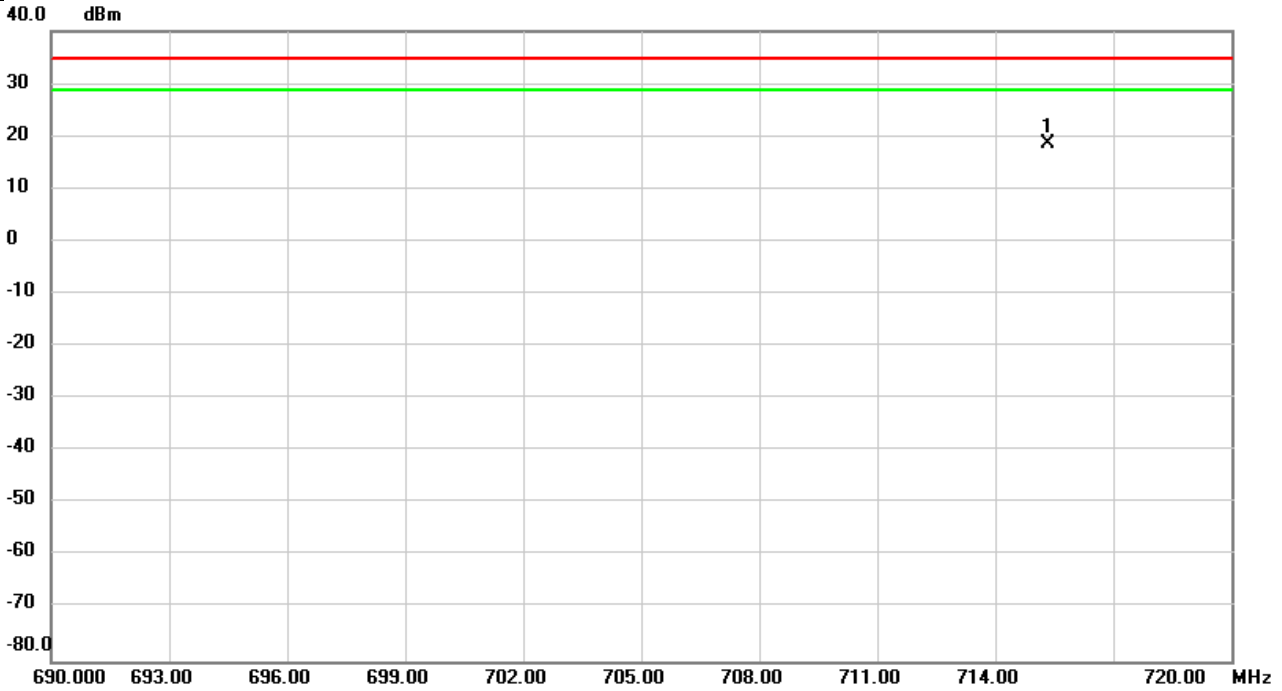

No.	Mk.	Freq. MHz	Reading Level dBm	Correct Factor dB	Measure- ment dBm	Limit dBm	Over dB	Detector	Comment
1	*	715.3590	4.12	14.47	18.59	34.77	-16.18	peak	

REMARKS:

- (1) Measurement Value = Reading Level + Correct Factor.
- (2) Margin Level = Measurement Value - Limit Value.

Test Mode	NB-IOT Band 12	Test Date	2020/11/10
Test Channel	CH23173	Polarization	Horizontal
Temp	23°C	Hum.	64%
Modulation Type	BPSK	Sub-carrier Spacing	15KHz

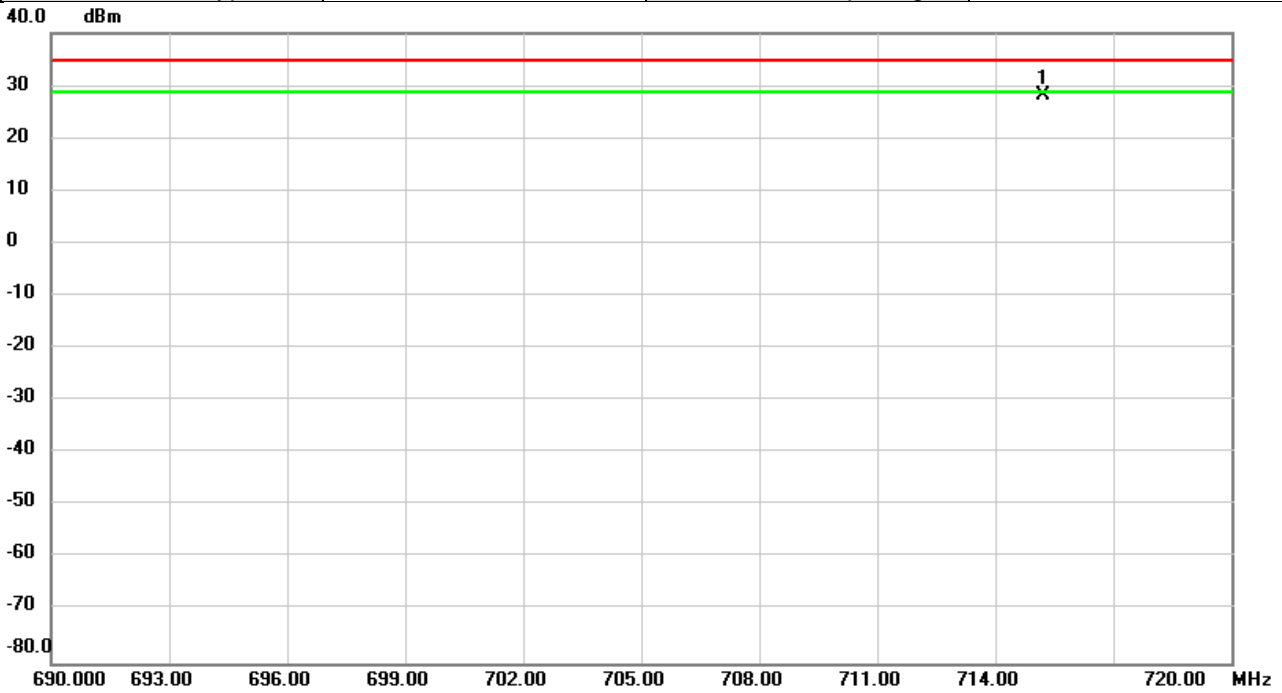

No.	Mk.	Freq.	Reading Level	Correct Factor	Measurement	Limit	Over	Detector	Comment
		MHz	dBm	dB	dBm	dBm	dB		
1	*	715.2080	15.53	12.56	28.09	34.77	-6.68	peak	

REMARKS:

- (1) Measurement Value = Reading Level + Correct Factor.
- (2) Margin Level = Measurement Value - Limit Value.



Test Mode	NB-IOT Band 12	Test Date	2020/11/10
Test Channel	CH23017	Polarization	Vertical
Temp	23°C	Hum.	64%
Modulation Type	BPSK	Sub-carrier Spacing	3.75KHz

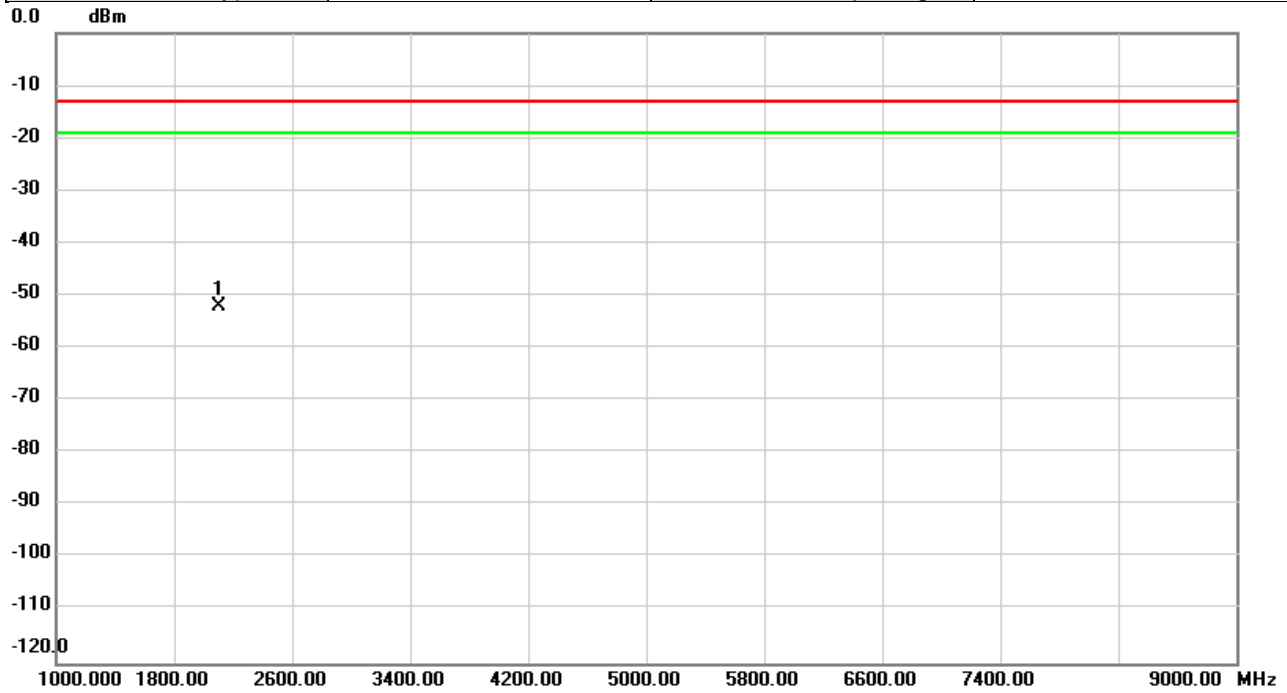

No.	Mk.	Freq.	Reading Level	Correct Factor	Measurement	Limit	Over	Detector	Comment
		MHz	dBm	dB	dBm	dBm	dB		
1	*	2099.200	-46.76	-5.36	-52.12	-13.00	-39.12	peak	

REMARKS:

- (1) Measurement Value = Reading Level + Correct Factor.
- (2) Margin Level = Measurement Value - Limit Value.

Test Mode	NB-IOT Band 12	Test Date	2020/11/10
Test Channel	CH23017	Polarization	Horizontal
Temp	23°C	Hum.	64%
Modulation Type	BPSK	Sub-carrier Spacing	3.75KHz

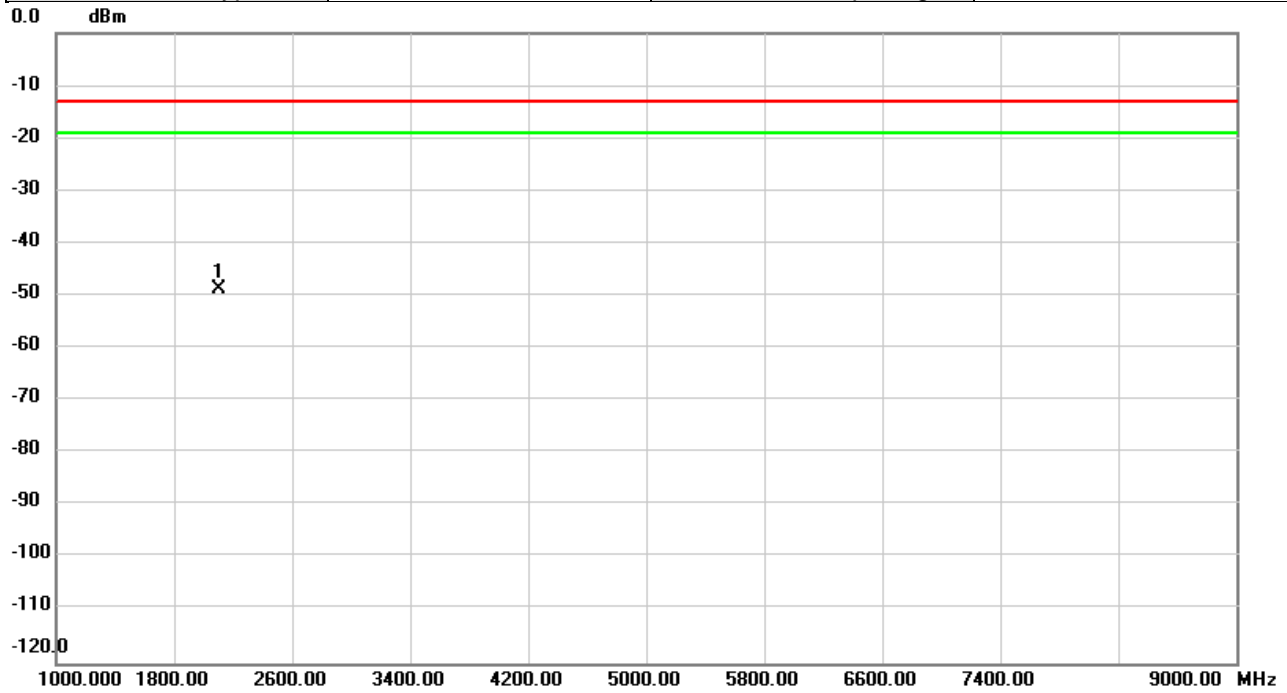

No.	Mk.	Freq.	Reading Level	Correct Factor	Measurement	Limit	Over	Detector	Comment
		MHz	dBm	dB	dBm	dBm	dB		
1	*	2098.667	-43.18	-5.66	-48.84	-13.00	-35.84	peak	

REMARKS:

- (1) Measurement Value = Reading Level + Correct Factor.
- (2) Margin Level = Measurement Value - Limit Value.

Test Mode	NB-IOT Band 12	Test Date	2020/11/10
Test Channel	CH23017	Polarization	Vertical
Temp	23°C	Hum.	64%
Modulation Type	BPSK	Sub-carrier Spacing	15KHz

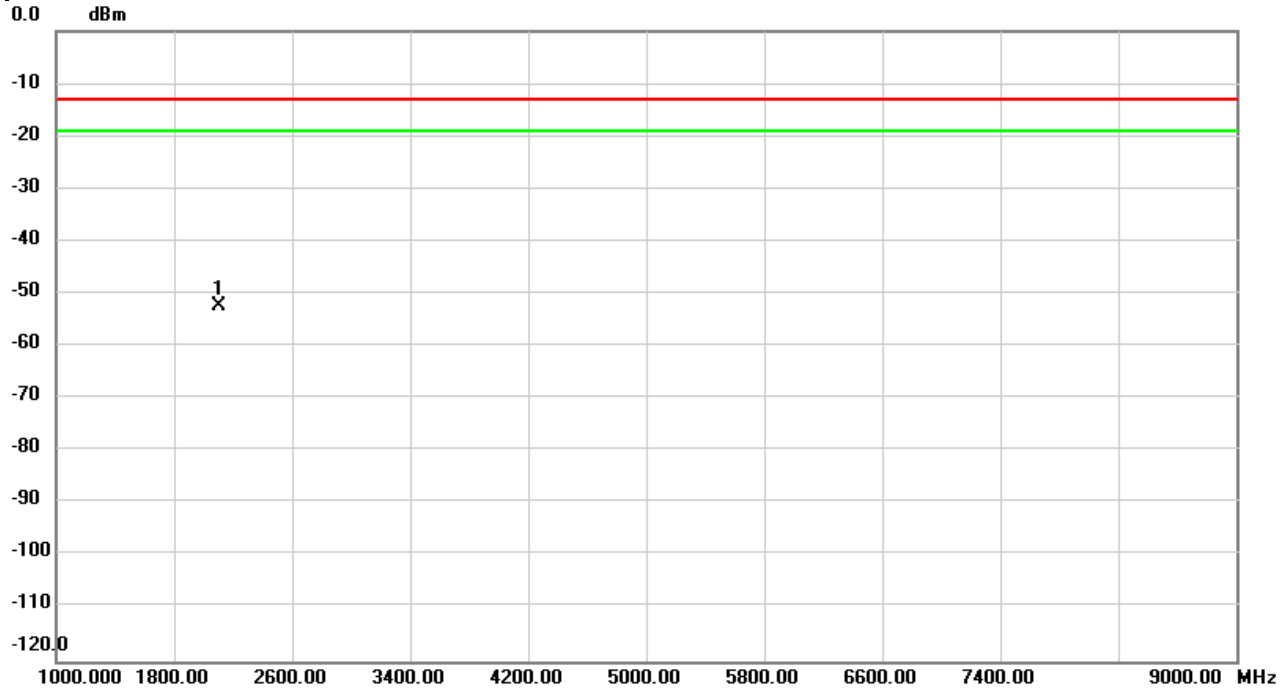

No.	Mk.	Freq.	Reading Level	Correct Factor	Measurement	Limit	Over	Detector	Comment
		MHz	dBm	dB	dBm	dBm	dB		
1	*	2099.200	-47.11	-5.36	-52.47	-13.00	-39.47	peak	

REMARKS:  
 (1) Measurement Value = Reading Level + Correct Factor.  
 (2) Margin Level = Measurement Value - Limit Value.

Test Mode	NB-IOT Band 12	Test Date	2020/11/10
Test Channel	CH23017	Polarization	Horizontal
Temp	23°C	Hum.	64%
Modulation Type	BPSK	Sub-carrier Spacing	15KHz

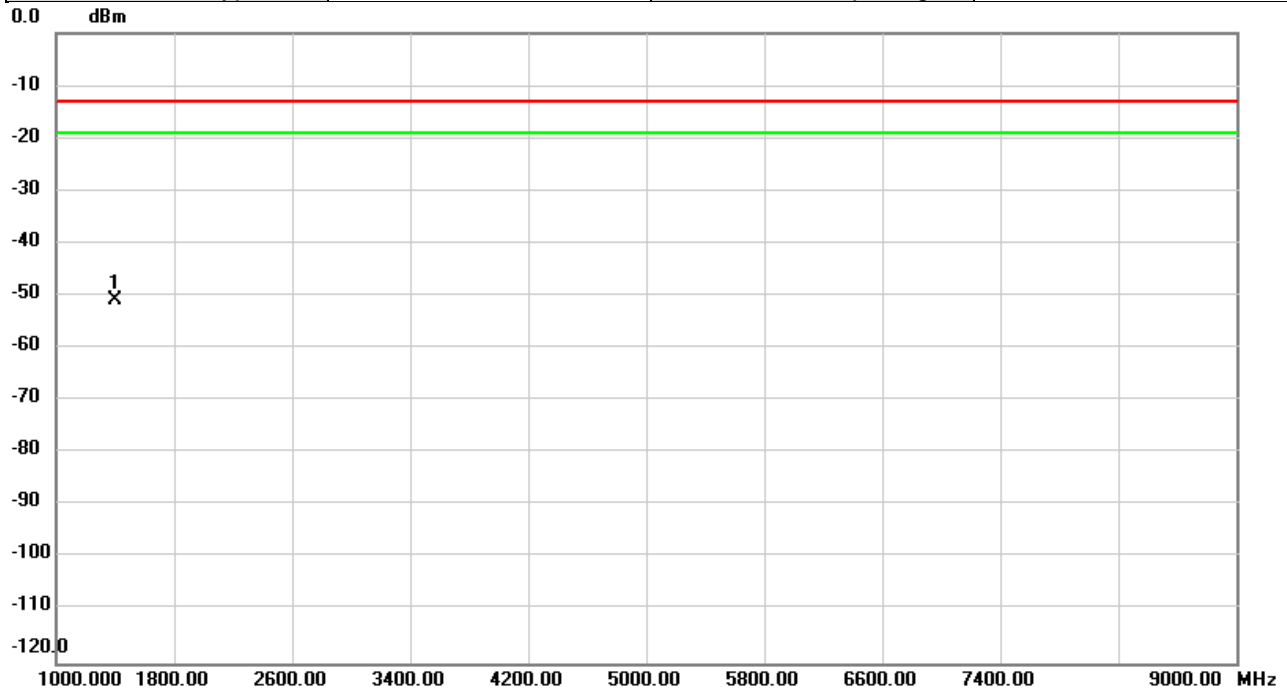

No.	Mk.	Freq.	Reading Level	Correct Factor	Measurement	Limit	Over	Detector	Comment
		MHz	dBm	dB	dBm	dBm	dB		
1	*	1399.467	-43.80	-6.96	-50.76	-13.00	-37.76	peak	

REMARKS:

- (1) Measurement Value = Reading Level + Correct Factor.
- (2) Margin Level = Measurement Value - Limit Value.

Test Mode	NB-IOT Band 12	Test Date	2020/11/10
Test Channel	CH23095	Polarization	Vertical
Temp	23°C	Hum.	64%
Modulation Type	BPSK	Sub-carrier Spacing	3.75KHz

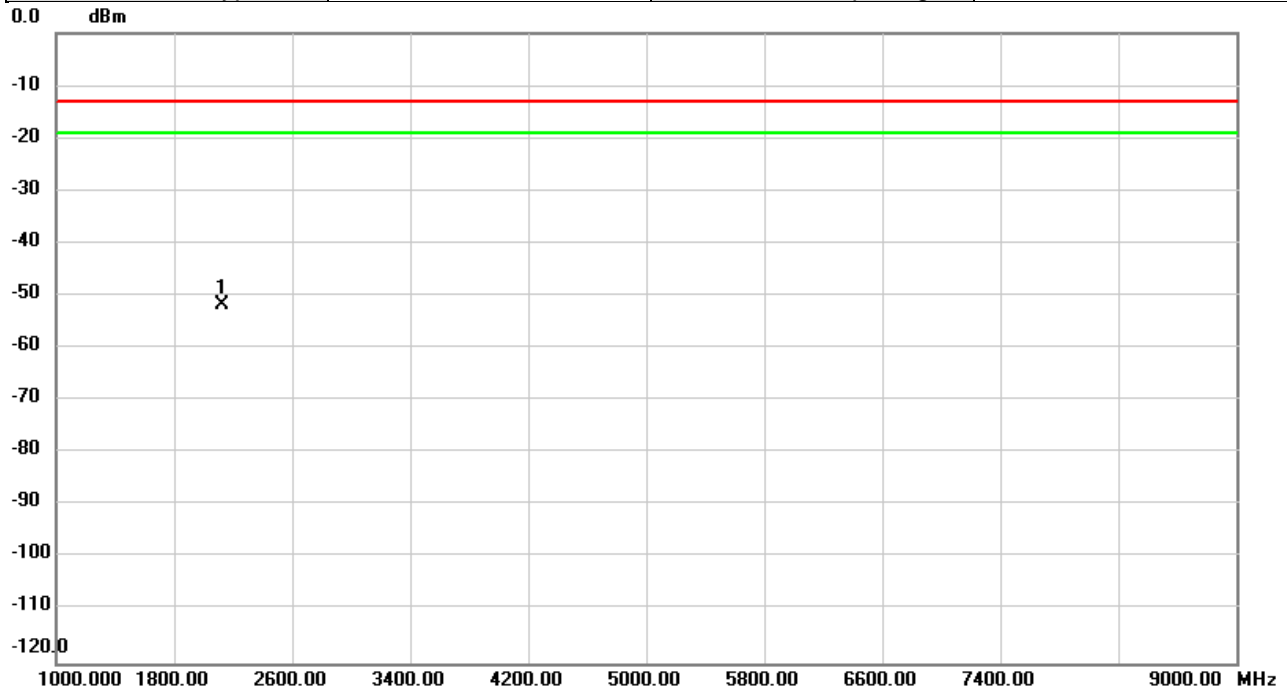

No.	Mk.	Freq.	Reading Level	Correct Factor	Measurement	Limit	Over	Detector	Comment
		MHz	dBm	dB	dBm	dBm	dB		
1	*	2122.400	-46.88	-4.95	-51.83	-13.00	-38.83	peak	

REMARKS:

- (1) Measurement Value = Reading Level + Correct Factor.
- (2) Margin Level = Measurement Value - Limit Value.

Test Mode	NB-IOT Band 12	Test Date	2020/11/10
Test Channel	CH23095	Polarization	Horizontal
Temp	23°C	Hum.	64%
Modulation Type	BPSK	Sub-carrier Spacing	3.75KHz

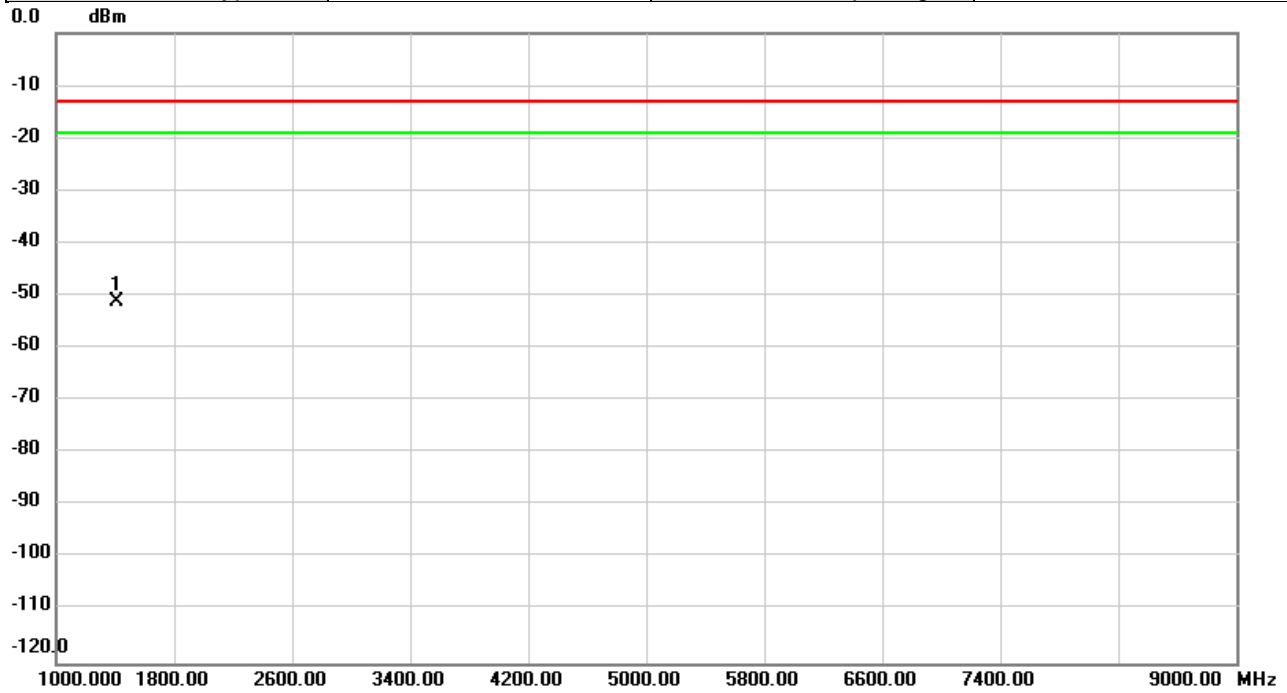

No.	Mk.	Freq.	Reading Level	Correct Factor	Measurement	Limit	Over	Detector	Comment
		MHz	dBm	dB	dBm	dBm	dB		
1	*	1414.667	-43.83	-7.24	-51.07	-13.00	-38.07	peak	

REMARKS:

- (1) Measurement Value = Reading Level + Correct Factor.
- (2) Margin Level = Measurement Value - Limit Value.

Test Mode	NB-IOT Band 12	Test Date	2020/11/10
Test Channel	CH23095	Polarization	Vertical
Temp	23°C	Hum.	64%
Modulation Type	BPSK	Sub-carrier Spacing	15KHz

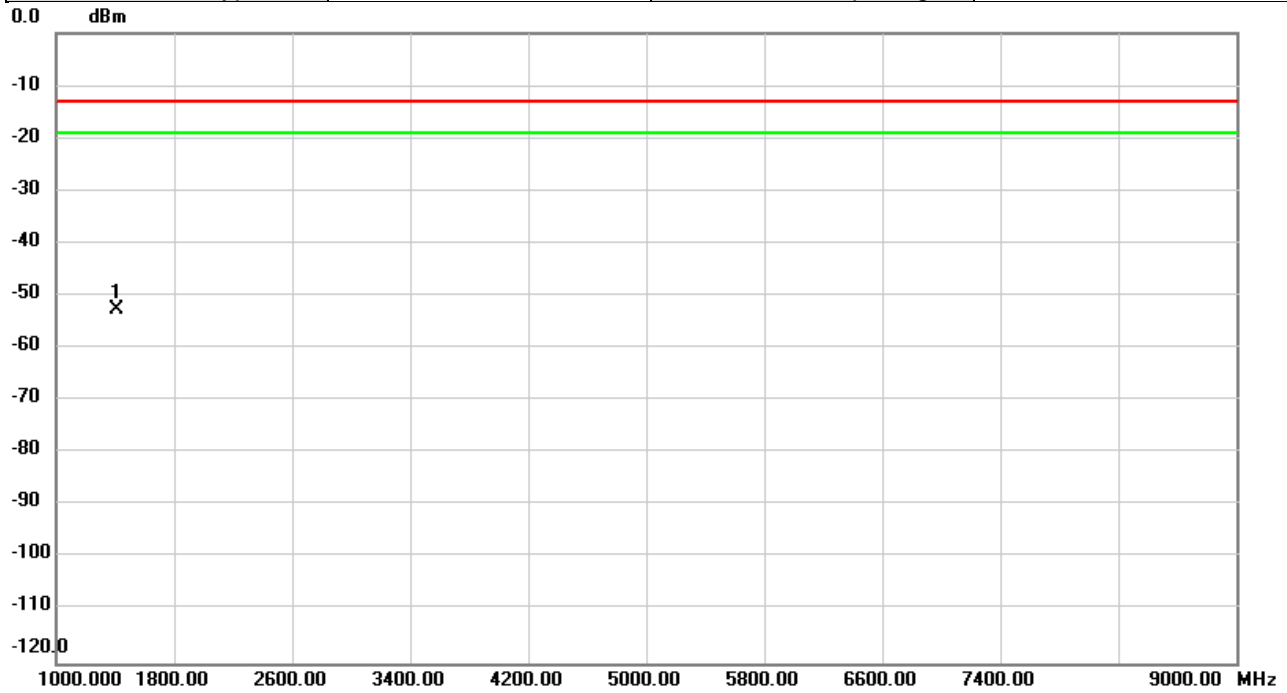

No.	Mk.	Freq.	Reading Level	Correct Factor	Measurement	Limit	Over	Detector	Comment
		MHz	dBm	dB	dBm	dBm	dB		
1	*	1414.933	-44.35	-8.45	-52.80	-13.00	-39.80	peak	

REMARKS:

- (1) Measurement Value = Reading Level + Correct Factor.
- (2) Margin Level = Measurement Value - Limit Value.

Test Mode	NB-IOT Band 12	Test Date	2020/11/10
Test Channel	CH23095	Polarization	Horizontal
Temp	23°C	Hum.	64%
Modulation Type	BPSK	Sub-carrier Spacing	15KHz

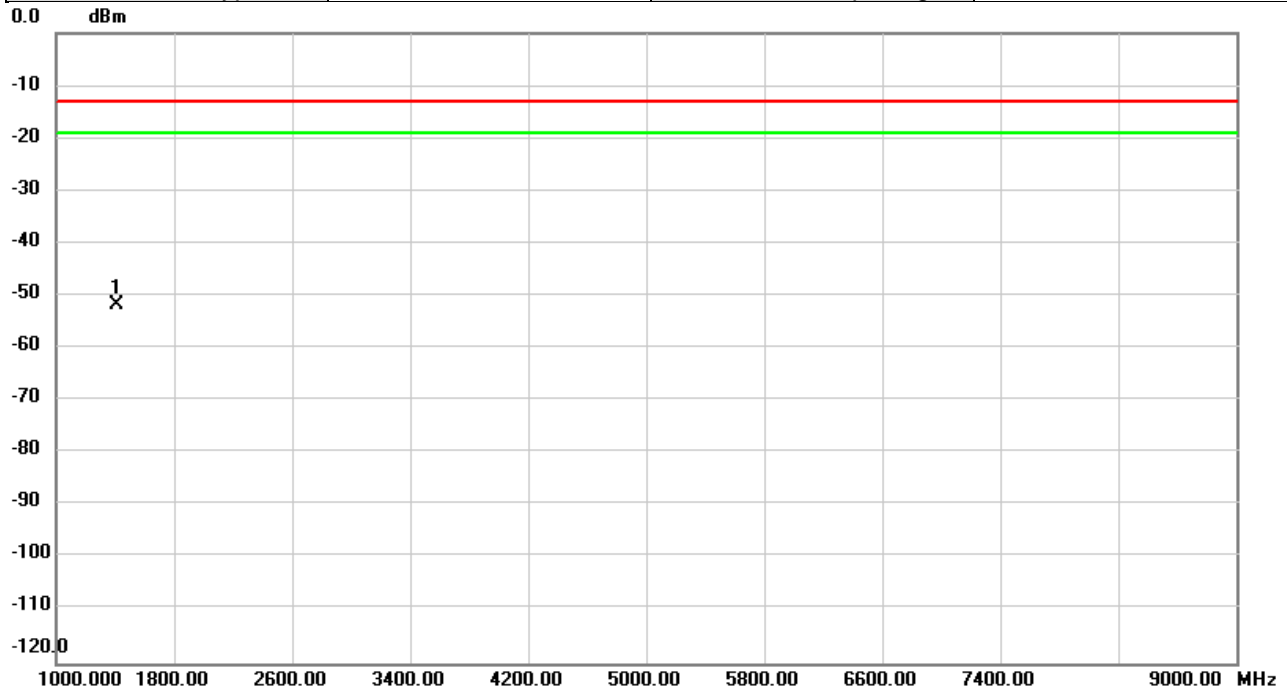

No.	Mk.	Freq.	Reading Level	Correct Factor	Measurement	Limit	Over	Detector	Comment
		MHz	dBm	dB	dBm	dBm	dB		
1	*	1414.667	-44.50	-7.24	-51.74	-13.00	-38.74	peak	

REMARKS:

- (1) Measurement Value = Reading Level + Correct Factor.
- (2) Margin Level = Measurement Value - Limit Value.



Test Mode	NB-IOT Band 12	Test Date	2020/11/10
Test Channel	CH23173	Polarization	Vertical
Temp	23°C	Hum.	64%
Modulation Type	BPSK	Sub-carrier Spacing	3.75KHz

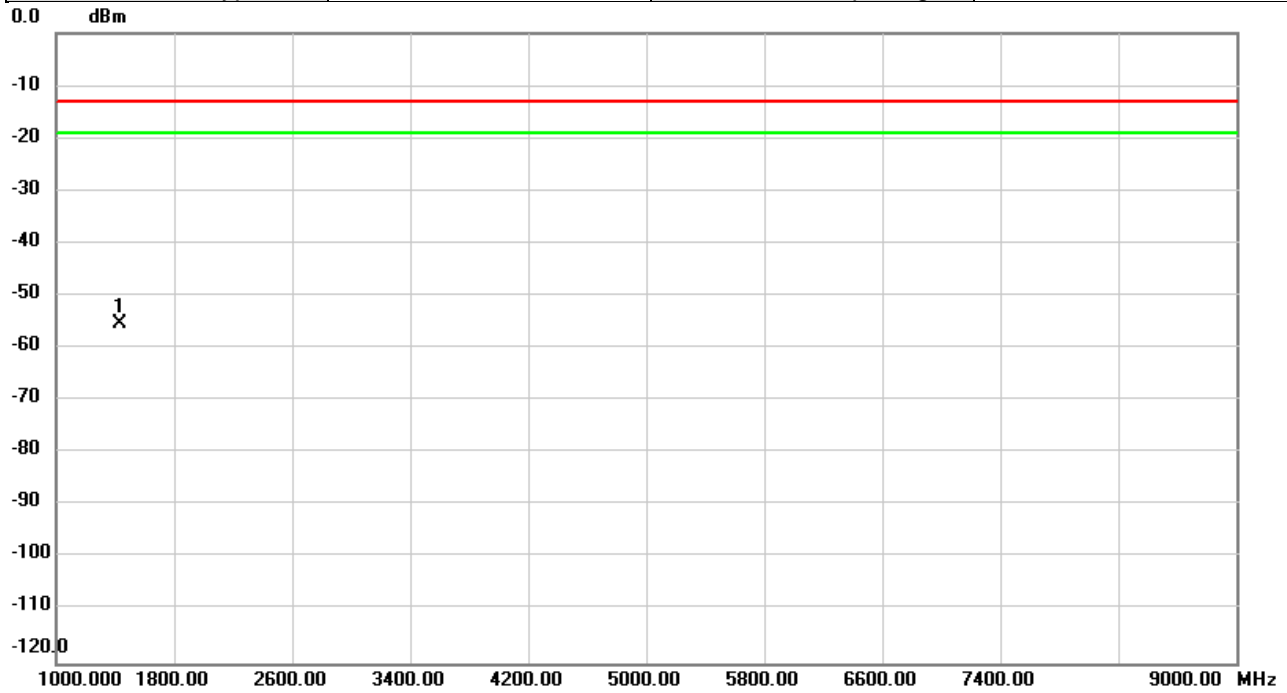

No.	Mk.	Freq.	Reading Level	Correct Factor	Measurement	Limit	Over	Detector	Comment
		MHz	dBm	dB	dBm	dBm	dB		
1	*	1430.400	-46.99	-8.42	-55.41	-13.00	-42.41	peak	

REMARKS:

- (1) Measurement Value = Reading Level + Correct Factor.
- (2) Margin Level = Measurement Value - Limit Value.

Test Mode	NB-IOT Band 12	Test Date	2020/11/10
Test Channel	CH23173	Polarization	Horizontal
Temp	23°C	Hum.	64%
Modulation Type	BPSK	Sub-carrier Spacing	3.75KHz

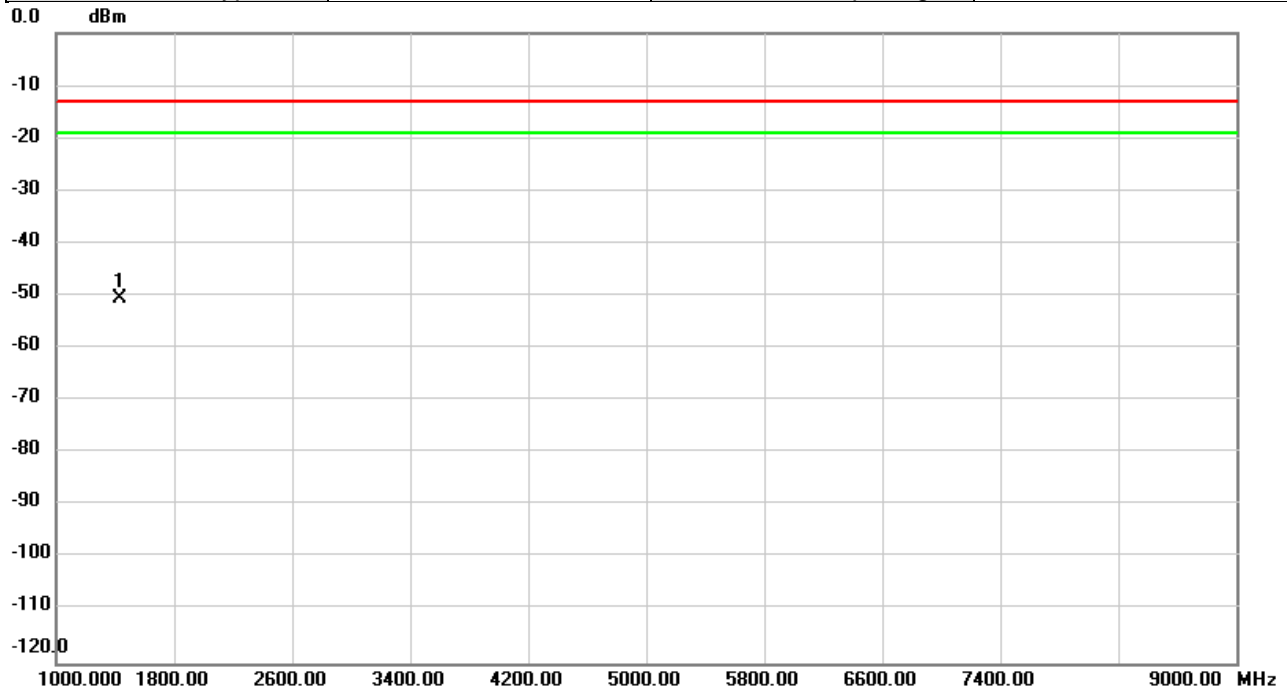

No.	Mk.	Freq.	Reading Level	Correct Factor	Measurement	Limit	Over	Detector	Comment
		MHz	dBm	dB	dBm	dBm	dB		
1	*	1430.667	-43.03	-7.57	-50.60	-13.00	-37.60	peak	

REMARKS:

- (1) Measurement Value = Reading Level + Correct Factor.
- (2) Margin Level = Measurement Value - Limit Value.

Test Mode	NB-IOT Band 12	Test Date	2020/11/10
Test Channel	CH23173	Polarization	Vertical
Temp	23°C	Hum.	64%
Modulation Type	BPSK	Sub-carrier Spacing	15KHz

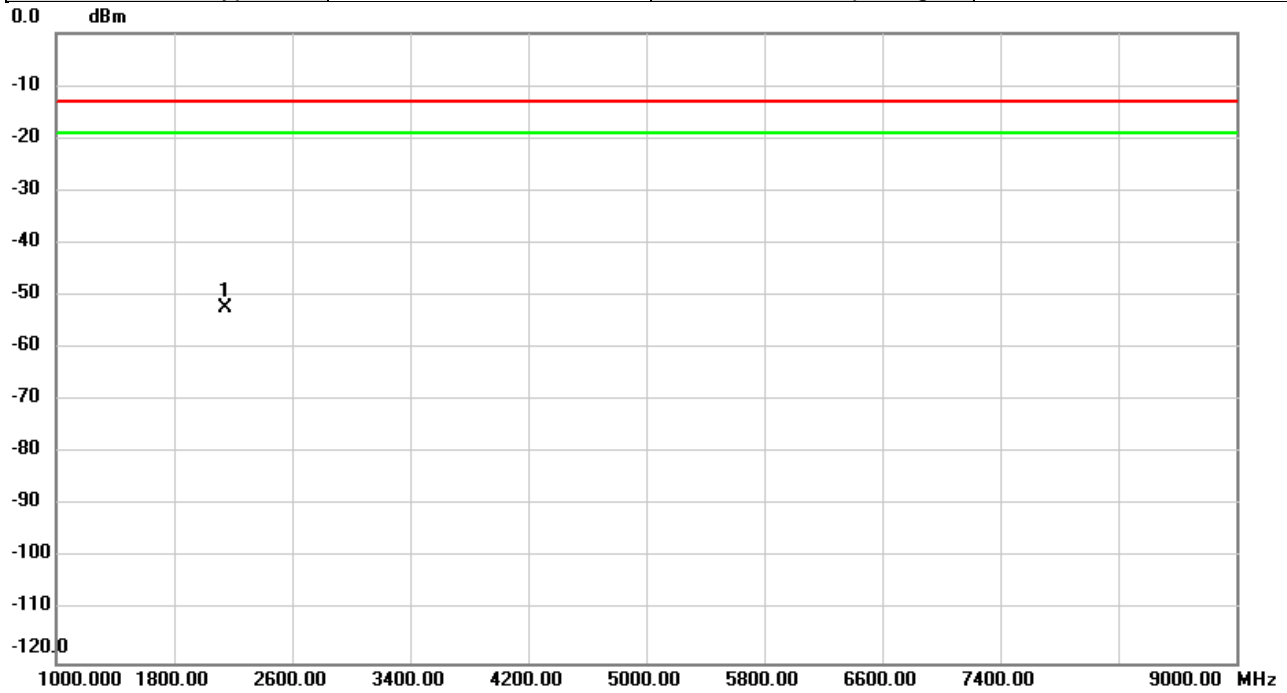

No.	Mk.	Freq.	Reading Level	Correct Factor	Measurement	Limit	Over	Detector	Comment
		MHz	dBm	dB	dBm	dBm	dB		
1	*	2145.867	-47.88	-4.53	-52.41	-13.00	-39.41	peak	

**REMARKS:**

- (1) Measurement Value = Reading Level + Correct Factor.
- (2) Margin Level = Measurement Value - Limit Value.

Test Mode	NB-IOT Band 12	Test Date	2020/11/10
Test Channel	CH23173	Polarization	Horizontal
Temp	23°C	Hum.	64%
Modulation Type	BPSK	Sub-carrier Spacing	15KHz

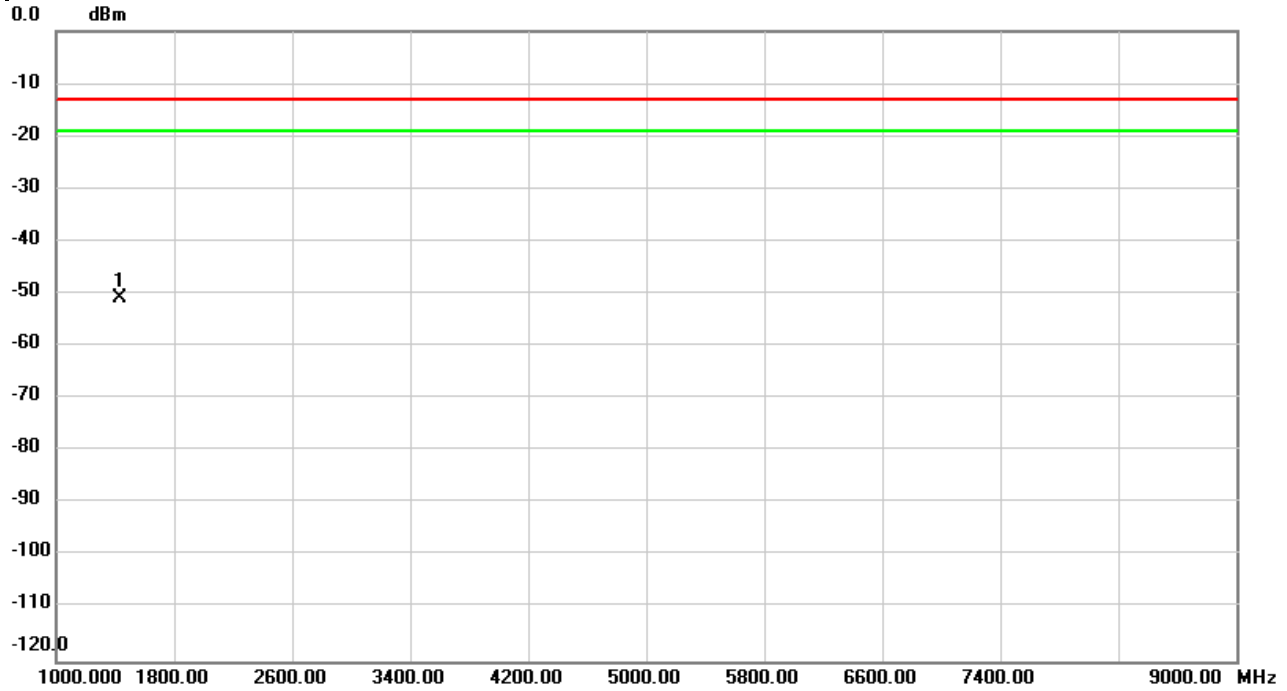

No.	Mk.	Freq.	Reading Level	Correct Factor	Measurement	Limit	Over	Detector	Comment
		MHz	dBm	dB	dBm	dBm	dB		
1	*	1430.400	-43.19	-7.56	-50.75	-13.00	-37.75	peak	

**REMARKS:**

- (1) Measurement Value = Reading Level + Correct Factor.
- (2) Margin Level = Measurement Value - Limit Value.

**End of Test Report**