

FCC TEST REPORT  
for  
SHENZHEN CP PLUS INTERNATIONAL LTD.

IP camera  
Model No.: EPK-HP10L1

Prepared For : SHENZHEN CP PLUS INTERNATIONAL LTD.  
Address : 14A XINHAOFANG BLDG., SHENNAN AVENUE NORTH,  
NANTOU STREET, NANSHAN DISTRICT, SHENZHEN,  
CHINA

Prepared By : Shenzhen Anbotek Compliance Laboratory Limited  
Address : 1/F., Building 1, SEC Industrial Park, No.0409 Qianhai Road,  
Nanshan District, Shenzhen, Guangdong, China  
Tel: (86) 755-26066544  
Fax: (86) 755-26014772

Report Number : R0217030034W  
Date of Test : Mar. 10~Apr. 17, 2017  
Date of Report : Apr. 18, 2017

## TABLE OF CONTENT

Description

Page

Test Report

<b>1. GENERAL INFORMATION.....</b>	<b>4</b>
1.1. Description of Device (EUT).....	4
1.2. Auxiliary Equipment Used during Test.....	5
1.3. Description of Test Facility.....	5
1.4. Measurement Uncertainty.....	5
<b>2. TEST METHODOLOGY.....</b>	<b>6</b>
2.1. Summary of Test Results.....	6
2.2. Description of Test Modes.....	6
2.3. List of channels:.....	7
2.4. Description Of Test Setup.....	8
<b>3. CONDUCTED EMISSION TEST.....</b>	<b>9</b>
3.1. Block Diagram of Test Setup.....	9
3.2 Power Line Conducted Emission Measurement Limits (15.207).....	9
3.3. Configuration of EUT on Measurement.....	10
3.4. Operating Condition of EUT.....	10
3.5. Test Procedure.....	10
3.6. Test equipment.....	10
3.7. Power Line Conducted Emission Measurement Results.....	10
<b>4. FCC PART 15.247 REQUIREMENTS FOR DSSS &amp; OFDM MODULATION.....</b>	<b>15</b>
4.1 Test Setup.....	15
4.2 6dB Bandwidth & 20dB Bandwidth.....	15
4.3. Maximum Output Power Test.....	29
4.4. Duty Cycle.....	36
4.5. 100 kHz bandwidth outside the frequency Measurement.....	39
4.6. Peak Power Spectral Density.....	44
4.7. Radiated Emissions and Band Edge Measurement.....	51
<b>5. ANTENNA APPLICATION.....</b>	<b>62</b>
5.1. Antenna requirement.....	62
5.2. Result.....	62
<b>6. PHOTOGRAPH.....</b>	<b>63</b>
6.1. Photo of Conducted Emission Measurement.....	63
6.2. Photo of Radiation Emission Test.....	63
<b>APPENDIX II (EXTERNAL PHOTOS).....</b>	<b>65</b>
<b>APPENDIX III (INTERNAL PHOTOS).....</b>	<b>68</b>

## TEST REPORT

Applicant : SHENZHEN CP PLUS INTERNATIONAL LTD.  
Manufacturer : SHENZHEN CP PLUS INTERNATIONAL LTD.  
EUT : IP camera  
Model No. : EPK-HP10L1  
Serial No. : N.A.  
Trade Mark : Ezykam  
Rating : Input DC 5V, 2A

Measurement Procedure Used:  
FCC Part15 Subpart C 2016, Paragraph 15.247  
KDB558074 D01 DTS Meas Guidance v04

The device described above is tested by Shenzhen Anbotek Compliance Laboratory Limited to determine the maximum emission levels emanating from the device and the severe levels of the device can endure and its performance criterion. The measurement results are contained in this test report and Shenzhen Anbotek Compliance Laboratory Limited is assumed full of responsibility for the accuracy and completeness of these measurements. Also, this report shows that the EUT (Equipment Under Test) is technically compliant with the FCC Part 15 Subpart C requirements.

This report applies to above tested sample only and shall not be reproduced in part without written approval of Shenzhen Anbotek Compliance Laboratory Limited.

Date of Test : Mar. 10~Apr. 17, 2017

Prepared by :



Winkey Wang  
(Tested Engineer / Winkey Wang)

Reviewer :

Brown Lu  
(Project Manager / Brown Lu)

Approved & Authorized Signer :

Tom Chen  
(Manager / Tom Chen)

## 1. GENERAL INFORMATION

### 1.1. Description of Device (EUT)

EUT	: IP camera
Model Number	: EPK-HP10L1
Test Power Supply	: AC 120V, 60Hz for adapter/ AC 240V, 60Hz for adapter
RF Transmission Frequency	: 2412MHz~2462MHz (802.11b/802.11g/802.11n(HT20))
Channels	: 11 For (802.11b/802.11g/802.11n(HT20))
Modulation	: WiFi: 802.11b CCK; 802.11g OFDM; 802.11n MCS
Antenna Type	: Rod Antenna
Antenna Gain:	: 0 dBi
Applicant Address	: SHENZHEN CP PLUS INTERNATIONAL LTD. 14A XINHAOFANG BLDG., SHENNAN AVENUE NORTH, NANTOU STREET, NANSHAN DISTRICT, SHENZHEN, CHINA
Manufacturer Address	: SHENZHEN CP PLUS INTERNATIONAL LTD. 14A XINHAOFANG BLDG., SHENNAN AVENUE NORTH, NANTOU STREET, NANSHAN DISTRICT, SHENZHEN, CHINA
Date of receipt	: Mar. 10, 2017
Date of Test	: Mar. 10~Apr. 17, 2017

## 1.2. Auxiliary Equipment Used during Test

Adapter : Model No.: XHY050yyyabcCd  
Input: 100-240V~, 50/60Hz, 0.16A  
Output: DC 5V, 2000mA

## 1.3. Description of Test Facility

The test facility is recognized, certified, or accredited by the following organizations:

### **FCC-Registration No.: 752021**

Shenzhen Anbotek Compliance Laboratory Limited, EMC Laboratory has been registered and fully described in a report filed with the (FCC) Federal Communications Commission. The acceptance letter from the FCC is maintained in our files. Registration 752021, July 06, 2016.

### **IC-Registration No.: 8058A-1**

Shenzhen Anbotek Compliance Laboratory Limited., EMC Laboratory has been registered and fully described in a report filed with the (IC) Industry Canada. The acceptance letter from the IC is maintained in our files. Registration 8058A, June 13, 2016.

### **Test Location**

All Emissions tests were performed at Shenzhen Anbotek Compliance Laboratory Limited. at 1/F., Building 1, SEC Industrial Park, No.0409 Qianhai Road, Nanshan District, Shenzhen, Guangdong, China

## 1.4. Measurement Uncertainty

Radiation Uncertainty : Ur = 4.1 dB (Horizontal)  
Ur = 4.3 dB (Vertical)  
Conduction Uncertainty : Uc = 3.4dB

## 2. TEST METHODOLOGY

The tests documented in this report were performed in accordance with ANSI C63.10: 2013 and FCC Part 15, Paragraph 15.247.

### 2.1. Summary of Test Results

The EUT has been tested according to the following specifications:

Standard	Test Type	Result	Notes
FCC Part 15, Paragraph 15.107, 15.207	Conducted Emission Test	PASS	Complies
FCC Part 15, Paragraph 15.247(b)(1)	Maximum Output Power	PASS	Complies
FCC Part 15, Paragraph 15.247(a)(2)	6dB Bandwidth	PASS	Complies
FCC Part 15, Paragraph 15.247(c)	100kHz Bandwidth of Frequency Band Edges	PASS	Complies
FCC Part 15, Paragraph 15.209(a)(f)	Spurious Emission	PASS	Complies
FCC Part 15, Paragraph 15.247(a)(1)	Frequency Separation	-	N/A
FCC Part 15, Paragraph 15.247(a)(1)(iii)	Number of Hopping Frequency	-	N/A
FCC Part 15, Paragraph 15.247(a)(1)(iii)	Time of Occupancy	-	N/A
FCC Part 15, Paragraph 15.247(c)	Peak Power Density	PASS	Complies

### 2.2. Description of Test Modes

The EUT has been tested under operating condition.

Software used to control the EUT for staying in continuous transmitting and receiving mode is programmed.

IEEE802.11b: Channel 1(2412MHz), Channel 6(2437MHz) and Channel 11(2462MHz) with 1 Mbps lowest data rate (worst case) are chosen for the final testing.

IEEE802.11g: Channel 1(2412MHz), Channel 6(2437MHz) and Channel 11(2462MHz) with 6 Mbps lowest data rate (the worst case) are chosen for the final testing.

IEEE802.11n (HT20): Channel 1(2412MHz), Channel 6(2437MHz) and Channel 11(2462MHz) with MCS 0 Mbps lowest data rate (the worst case) are chosen for the final testing.

The EUT was programmed to be in continuously transmitting mode and the transmit duty cycle is not less than 98%

2.3. List of channels:

√ - available

X - tested

Number	Frequency(MHz)		802.11 b/g/n (HT20)
1	2412	√	X
2	2417	√	
3	2422	√	
4	2427	√	
5	2432	√	
6	2437	√	X
7	2442	√	
8	2447	√	
9	2452	√	
10	2457	√	
11	2462	√	X

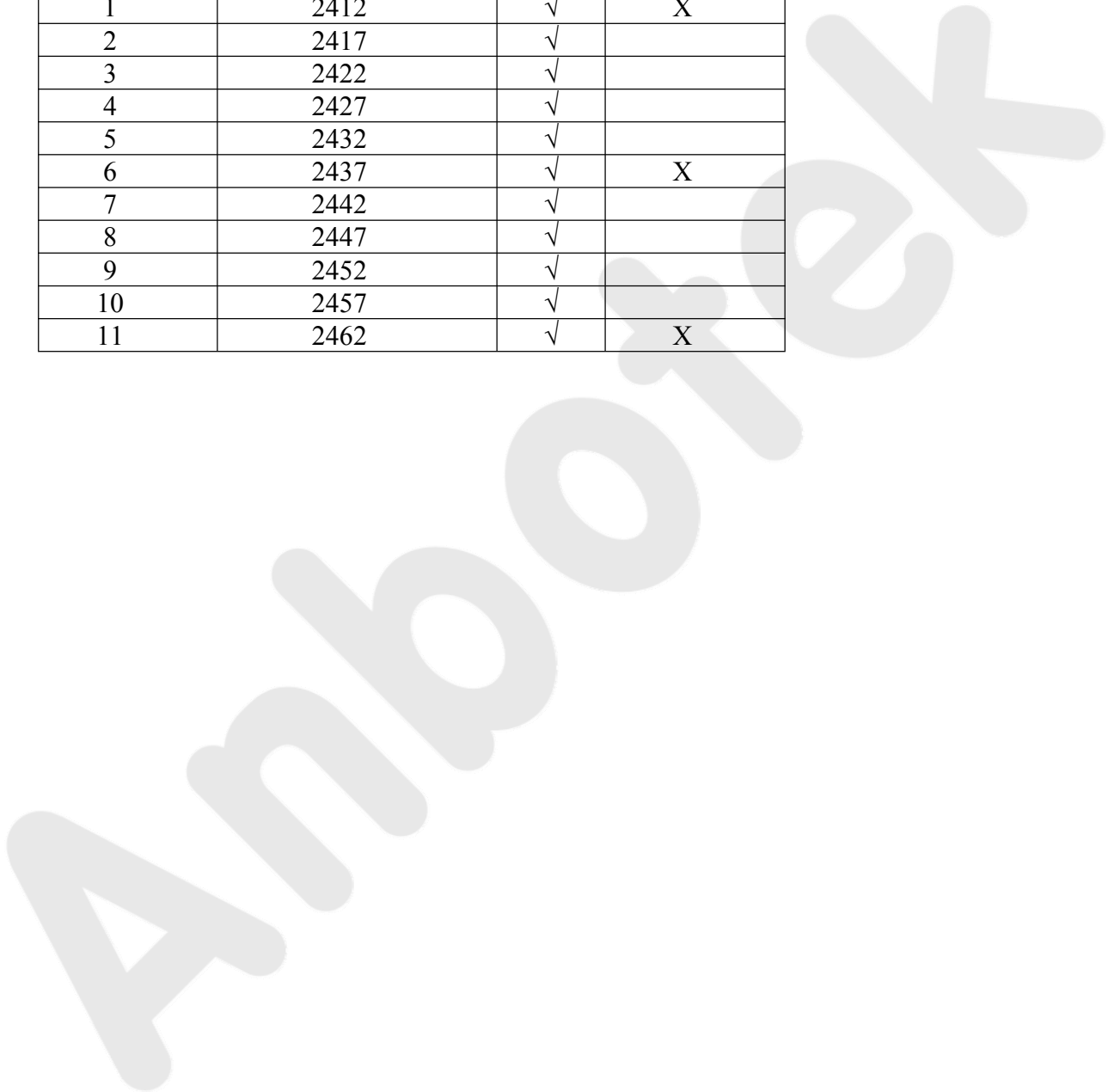

### 2.4. Description Of Test Setup

CE

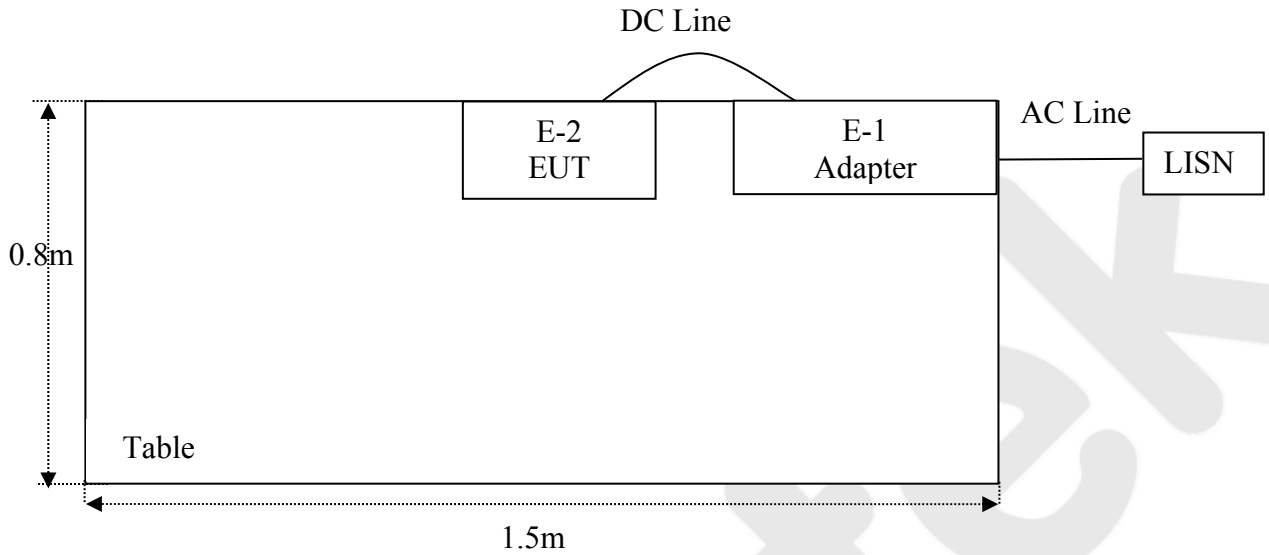

RE

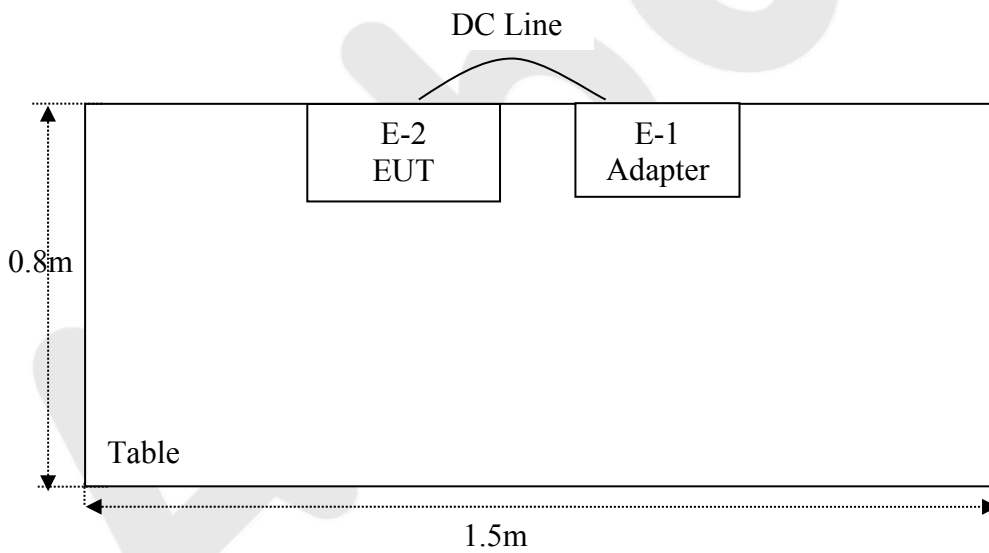

### 3. Conducted Emission Test

#### 3.1. Block Diagram of Test Setup

##### 3.1.1. Block diagram of connection between the EUT and simulators

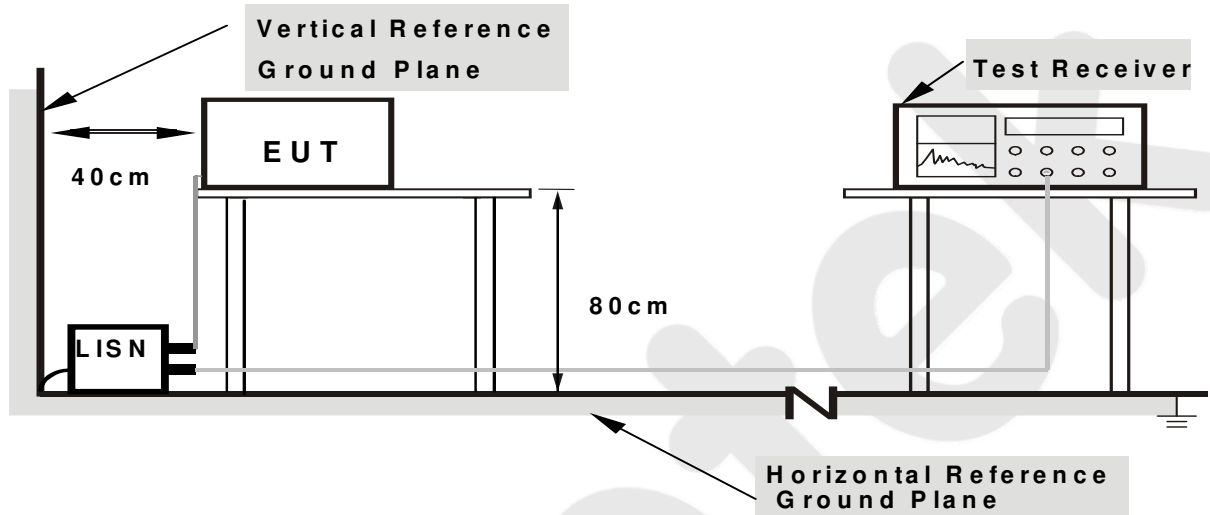

- Note:**
1. Support units were connected to second LISN.
  2. Both of LISNs (AMN) are 80 cm from EUT and at least 80 cm from other units and other metal planes

#### 3.2 Power Line Conducted Emission Measurement Limits (15.207)

Frequency MHz	Limits dB( $\mu$ V)	
	Quasi-peak Level	Average Level
0.15 ~ 0.50	66 ~ 56*	56 ~ 46*
0.50 ~ 5.00	56	46
5.00 ~ 30.00	60	50

- Notes:
1. \*Decreasing linearly with logarithm of frequency.
  2. The lower limit shall apply at the transition frequencies.

### 3.3. Configuration of EUT on Measurement

The following equipments are installed on Power Line Conducted Emission Measurement to meet the commission requirement and operating regulations in a manner which tends to maximize its emission characteristics in a normal application.

### 3.4. Operating Condition of EUT

- 3.4.1. Setup the EUT and simulator as shown as Section 3.1.
- 3.4.2. Turn on the power of all equipment.
- 3.4.3. Let the EUT work in test mode (WiFi Mode) and measure it.

### 3.5. Test Procedure

The EUT system is connected to the power mains through a line impedance stabilization network (L.I.S.N.). This provides a 50ohm coupling impedance for the EUT system. Please refer the block diagram of the test setup and photographs. Both sides of AC line are checked to find out the maximum conducted emission. In order to find the maximum emission levels, the relative positions of equipment and all of the interface cables shall be changed according to FCC ANSI C63.10-2013 on Conducted Emission Measurement.

The bandwidth of test receiver (ESCI) set at 9KHz.

The frequency range from 150KHz to 30MHz is checked.

The test results are reported on Section 3.6.

### 3.6. Test equipment

Item	Equipment	Manufacturer	Model No.	Serial No.	Last Cal.	Cal. Interval
1.	Two-Line V-network	Rohde & Schwarz	ENV216	100055	Jul. 19, 2016	1 Year
2.	EMI Test Receiver	Rohde & Schwarz	ESCI	100627	Jun. 17, 2016	1 Year
3.	RF Switching Unit	Compliance Direction	RSU-M2	38303	Jun. 17, 2016	1 Year

### 3.7. Power Line Conducted Emission Measurement Results

**PASS.**

The frequency range from 150KHz to 30 MHz is investigated.  
Please refer the following pages.

**CONDUCTED EMISSION TEST DATA**

Test Site: 1# Shielded Room  
 Operating Condition: WiFi Mode  
 Test Specification: AC 120V, 60Hz for adapter  
 Comment: Live Line  
 Tem.:25°C Hum.:50%

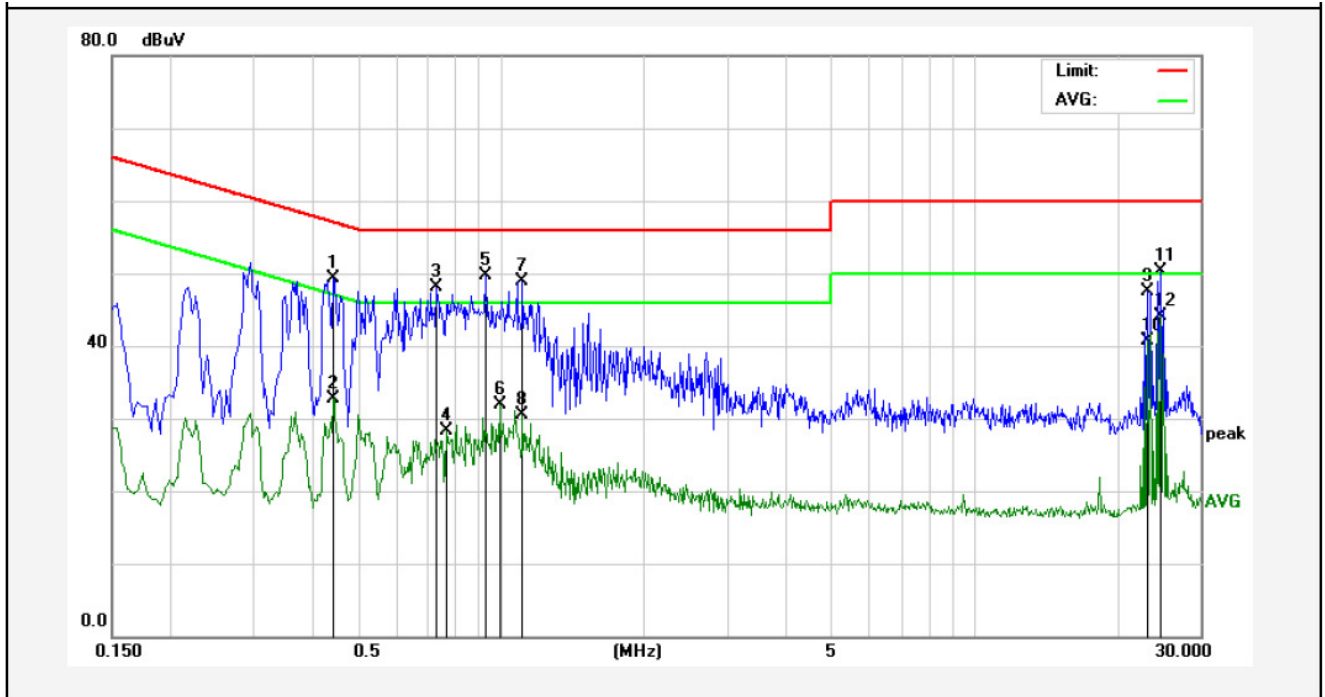

No.	Freq. (MHz)	Reading (dBuV)	Factor (dB)	Result (dBuV)	Limit dBuV	Over Limit (dB)	Detector	Remark
1	0.4420	29.39	19.95	49.34	57.02	-7.68	QP	
2	0.4420	12.73	19.95	32.68	47.02	-14.34	AVG	
3	0.7299	28.12	20.05	48.17	56.00	-7.83	QP	
4	0.7660	8.25	20.06	28.31	46.00	-17.69	AVG	
5	0.9260	29.54	20.10	49.64	56.00	-6.36	QP	
6	0.9939	11.76	20.12	31.88	46.00	-14.12	AVG	
7	1.1100	28.77	20.12	48.89	56.00	-7.11	QP	
8	1.1100	10.32	20.12	30.44	46.00	-15.56	AVG	
9	23.2500	27.19	20.30	47.49	60.00	-12.51	QP	
10	23.2500	20.46	20.30	40.76	50.00	-9.24	AVG	
11	24.7500	29.97	20.28	50.25	60.00	-9.75	QP	
12	24.7500	23.87	20.28	44.15	50.00	-5.85	AVG	

**CONDUCTED EMISSION TEST DATA**

Test Site: 1# Shielded Room  
 Operating Condition: WiFi Mode  
 Test Specification: AC 120V, 60Hz for adapter  
 Comment: Neutral Line  
 Tem.:25°C Hum.:50%

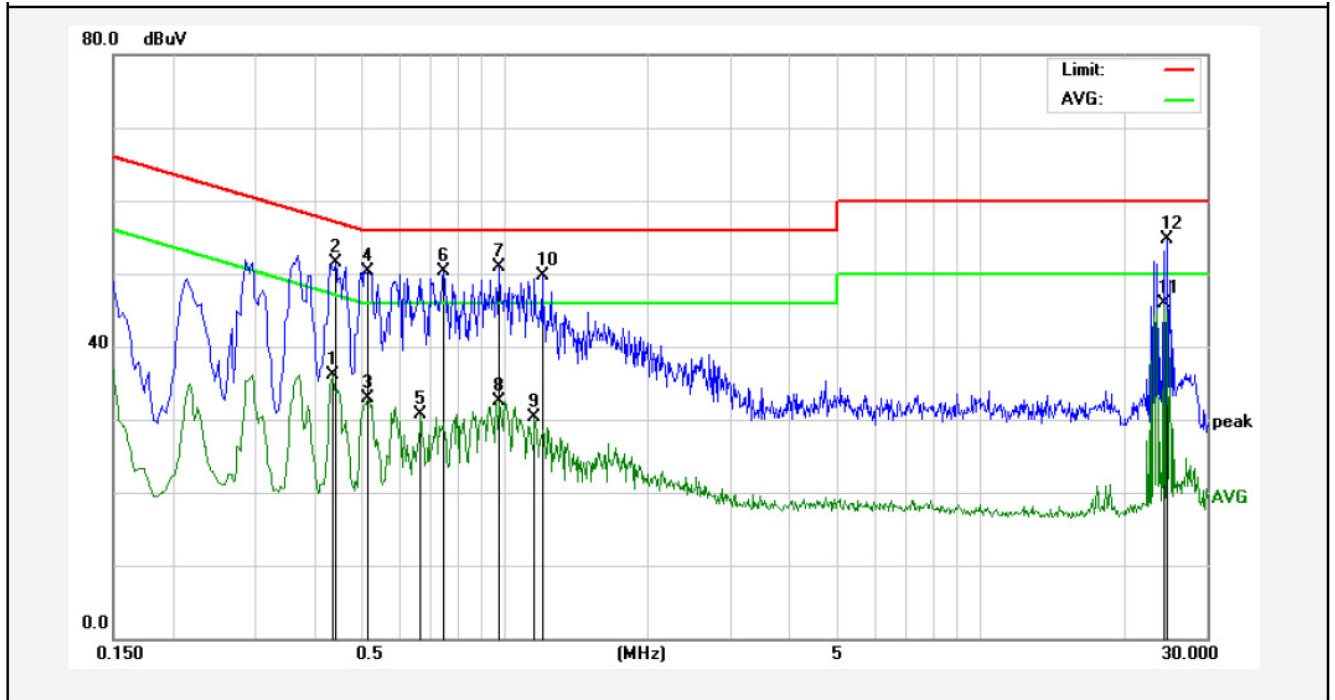

No.	Freq. (MHz)	Reading (dBuV)	Factor (dB)	Result (dBuV)	Limit dBuV	Over Limit (dB)	Detector	Remark
1	0.4339	16.23	19.95	36.18	47.18	-11.00	AVG	
2	0.4420	31.61	19.95	51.56	57.02	-5.46	QP	
3	0.5140	12.97	19.98	32.95	46.00	-13.05	AVG	
4	0.5180	30.38	19.99	50.37	56.00	-5.63	QP	
5	0.6660	10.58	20.03	30.61	46.00	-15.39	AVG	
6	0.7459	30.35	20.05	50.40	56.00	-5.60	QP	
7	0.9739	30.89	20.11	51.00	56.00	-5.00	QP	
8	0.9739	12.46	20.11	32.57	46.00	-13.43	AVG	
9	1.1539	10.17	20.12	30.29	46.00	-15.71	AVG	
10	1.2019	29.65	20.12	49.77	56.00	-6.23	QP	
11	24.3739	25.66	20.29	45.95	50.00	-4.05	AVG	
12	24.7500	34.43	20.28	54.71	60.00	-5.29	QP	

**CONDUCTED EMISSION TEST DATA**

Test Site: 1# Shielded Room  
 Operating Condition: WiFi Mode  
 Test Specification: AC 240V, 60Hz for adapter  
 Comment: Live Line  
 Tem.:25°C Hum.:50%

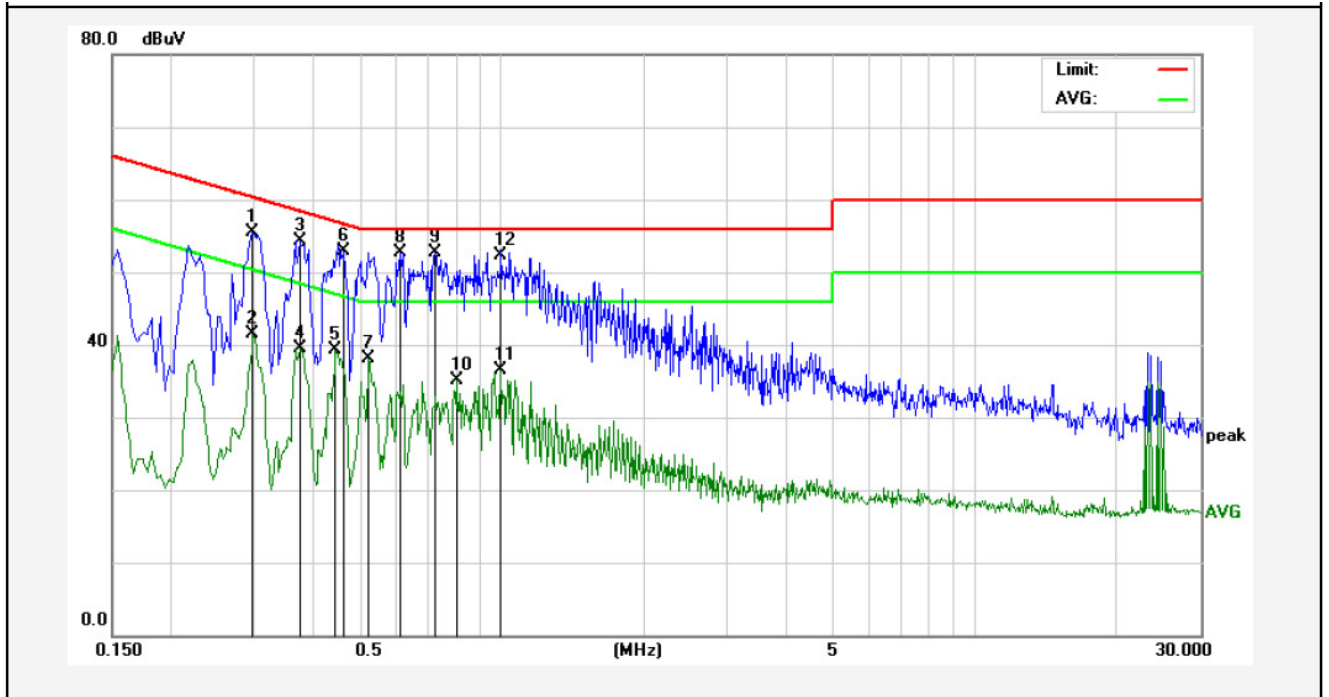

No.	Freq. (MHz)	Reading (dBuV)	Factor (dB)	Result (dBuV)	Limit dBuV	Over Limit (dB)	Detector	Remark
1	0.2980	35.56	19.89	55.45	60.30	-4.85	QP	
2	0.2980	21.65	19.89	41.54	50.30	-8.76	AVG	
3	0.3740	34.41	19.92	54.33	58.41	-4.08	QP	
4	0.3740	19.53	19.92	39.45	48.41	-8.96	AVG	
5	0.4460	19.37	19.96	39.33	46.95	-7.62	AVG	
6	0.4660	32.96	19.96	52.92	56.58	-3.66	QP	
7	0.5220	18.05	19.99	38.04	46.00	-7.96	AVG	
8	0.6100	32.68	20.01	52.69	56.00	-3.31	QP	
9	0.7220	32.71	20.05	52.76	56.00	-3.24	QP	
10	0.8020	15.11	20.07	35.18	46.00	-10.82	AVG	
11	0.9940	16.33	20.12	36.45	46.00	-9.55	AVG	
12	0.9980	32.28	20.12	52.40	56.00	-3.60	QP	

**CONDUCTED EMISSION TEST DATA**

Test Site: 1# Shielded Room  
 Operating Condition: WiFi Mode  
 Test Specification: AC 240V, 60Hz for adapter  
 Comment: Neutral Line  
 Tem.:25°C Hum.:50%

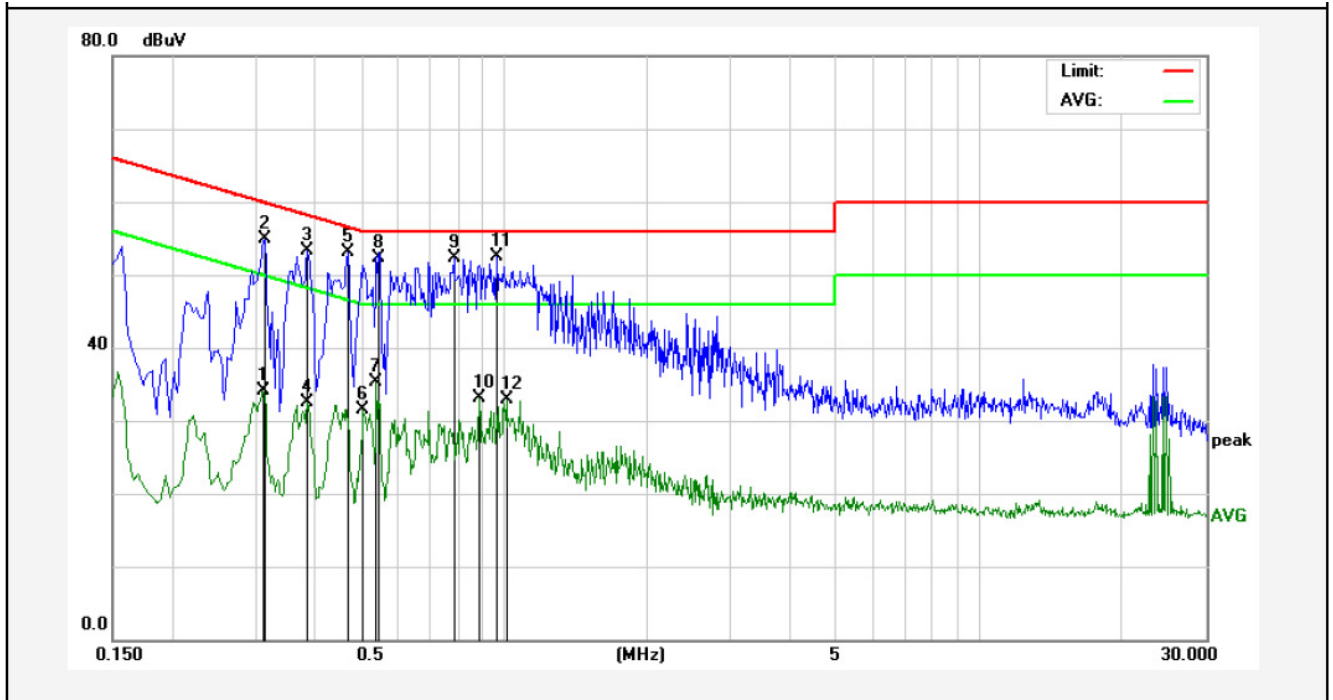

No.	Freq. (MHz)	Reading (dBuV)	Factor (dB)	Result (dBuV)	Limit dBuV	Over Limit (dB)	Detector	Remark
1	0.3100	14.30	19.89	34.19	49.97	-15.78	AVG	
2	0.3140	35.09	19.90	54.99	59.86	-4.87	QP	
3	0.3860	33.35	19.93	53.28	58.15	-4.87	QP	
4	0.3860	12.52	19.93	32.45	48.15	-15.70	AVG	
5	0.4700	33.11	19.97	53.08	56.51	-3.43	QP	
6	0.5060	11.62	19.98	31.60	46.00	-14.40	AVG	
7	0.5380	15.30	19.99	35.29	46.00	-10.71	AVG	
8	0.5460	32.41	19.99	52.40	56.00	-3.60	QP	
9	0.7860	32.24	20.06	52.30	56.00	-3.70	QP	
10	0.8860	13.03	20.09	33.12	46.00	-12.88	AVG	
11	0.9660	32.32	20.11	52.43	56.00	-3.57	QP	
12	1.0140	12.75	20.12	32.87	46.00	-13.13	AVG	

## 4. FCC Part 15.247 Requirements for DSSS & OFDM Modulation

### 4.1 Test Setup

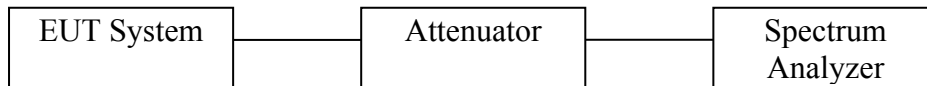

### 4.2 6dB Bandwidth & 20dB Bandwidth

#### 6dB Bandwidth

##### a. Limit

For the direct sequence systems, the minimum 6dB bandwidth shall be at least 500kHz.

##### b. Test Procedure

1. Place the EUT on the table and set it in the transmitting mode.
2. Remove the antenna from the EUT and then connect a low loss RF cable from the antenna port to the spectrum analyzer.
3. Set the spectrum analyzer as:  
RBW = 100kHz, VBW $\geq$ 3\*RBW =300kHz,  
Detector= Peak  
Trace mode= Max hold.  
Sweep- auto couple.
4. Mark the peak frequency and -6dB (upper and lower) frequency.
5. Repeat until all the rest channels are investigated.

#### 20dB Bandwidth:

##### C63.10

##### Occupied Bandwidth (OBW=20dB Bandwidth)

1. Set RBW=1%~5% OBW
2. Set the VBW $\geq$ 3\*RBW
3. Set the span range between 2 times and 5 times of the OBW
4. Sweep Time= Auto  
Detector= Peak  
Trace= Max hold
5. Once the reference level is established, the equipment is conditioned with typical modulating signals to produce the worst case (i.e. the widest) bandwidth. Unless otherwise specified for an unlicensed wireless device, measure the bandwidth at the -20dB levels with respect to the reference level.

##### c. Test Setup See 4.1

**d. Test Equipment**

Item	Equipment	Manufacturer	Model No.	Serial No.	Last Cal.	Cal. Interval
1.	Spectrum Analysis	Agilent	E4407B	US39390582	Jul. 12, 2016	1 Year
2.	Preamplifier	Instruments corporation	EMC011830	980100	Jun. 17, 2016	1 Year
3.	EMI Test Receiver	Rohde & Schwarz	ESPI	101604	Jun. 17, 2016	1 Year
4.	Double Ridged Horn Antenna	Instruments corporation	GTH-0118	351600	May 06, 2016	1 Year
5.	Bilog Broadband Antenna	Schwarzbeck	VULB9163	VULB 9163-289	May 06, 2016	1 Year
6.	Pre-amplifier	SONOMA	310N	186860	Jun. 17, 2016	1 Year
7.	EMI Test Software EZ-EMC	SHURPLE	N/A	N/A	N/A	N/A
8	Power Sensor	Agilent	KFSW150502	15I00041SN045	Jun. 17, 2016	1 Year
9	MXA Spectrum Analysis	Agilent	N9020A	MY51170037	Jun. 17, 2016	1 Year
10	MXG RF Vector Signal Generator	Agilent	N5182A	MY48180656	Jun. 17, 2016	1 Year
11	Signal Generator	Agilent	E4421B	MY41000743	Jun. 17, 2016	1 Year
12	DC Power supply	IV	IV-8080	YQSB0096	Jun. 17, 2016	1 Year
13	TEMP&HUMI PROGRAMMABLE CHAMBER	Bell Group	BE-THK-150M8	SE-0137	Jun. 17, 2016	1 Year

**e. Test Results**

Pass.

**f. Test Data**

**6dB Bandwidth**

Test mode: IEEE 802.11b

Channel	Frequency (MHz)	Bandwidth (MHz)	Limit (kHz)	Results
Low	2412	9.058		Pass
Mid	2437	10.07	>500	Pass
High	2462	10.00		Pass

Test mode: IEEE 802.11g

Channel	Frequency (MHz)	Bandwidth (MHz)	Limit (kHz)	Results
Low	2412	15.67		Pass
Mid	2437	15.51	>500	Pass
High	2462	16.29		Pass

Test mode: IEEE 802.11n (HT20)

Channel	Frequency (MHz)	Bandwidth (MHz)	Limit (kHz)	Results
Low	2412	15.70		Pass
Mid	2437	15.95	>500	Pass
High	2462	15.43		Pass

Test Plots See the following page.



Test Mode: 802.11b---Low

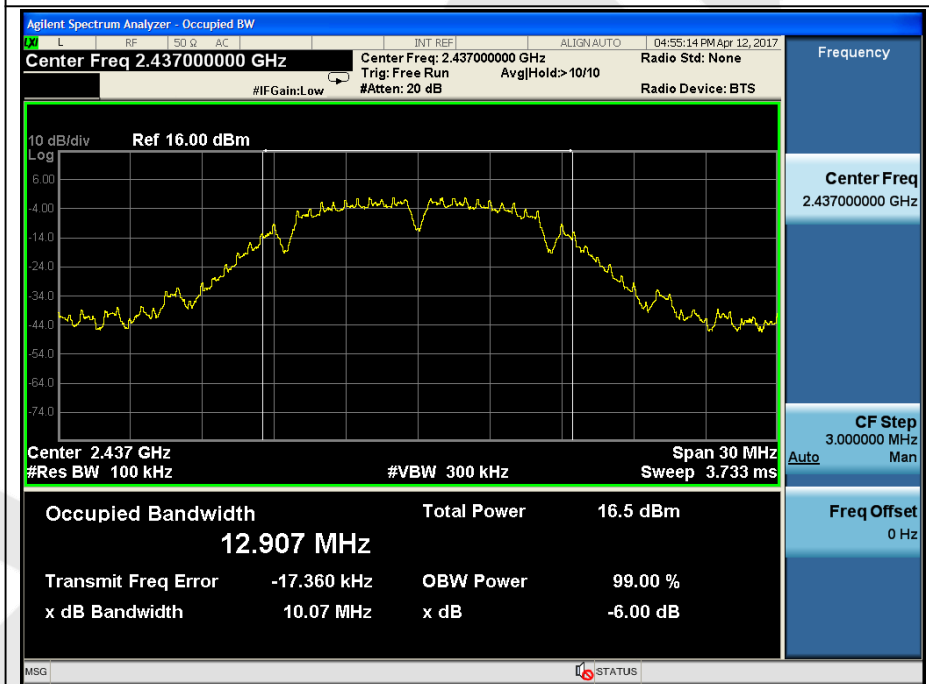

Test Mode: 802.11b---Mid

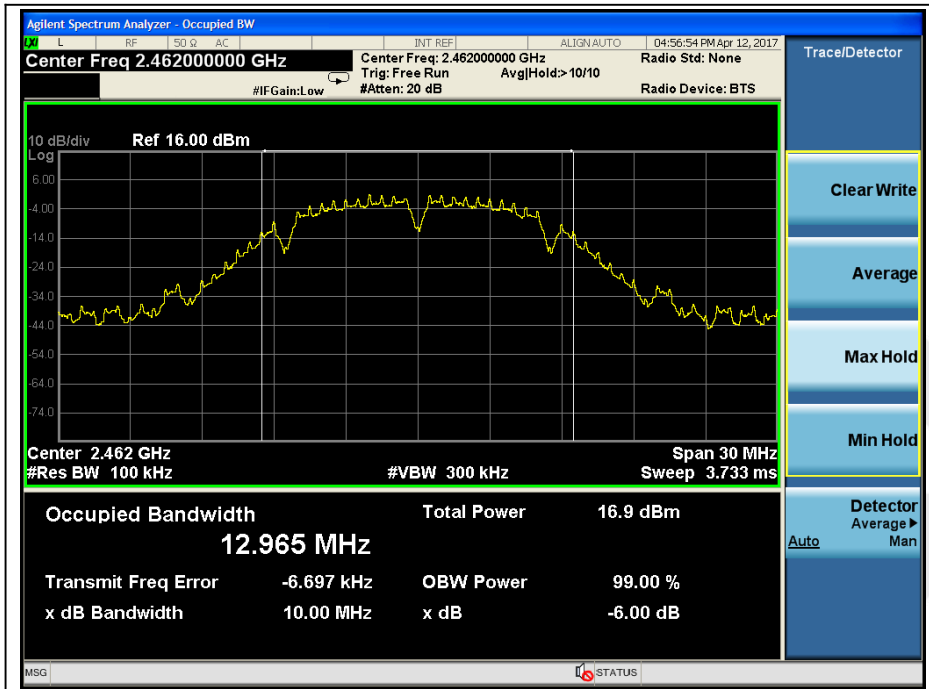

Test Mode: 802.11b---High

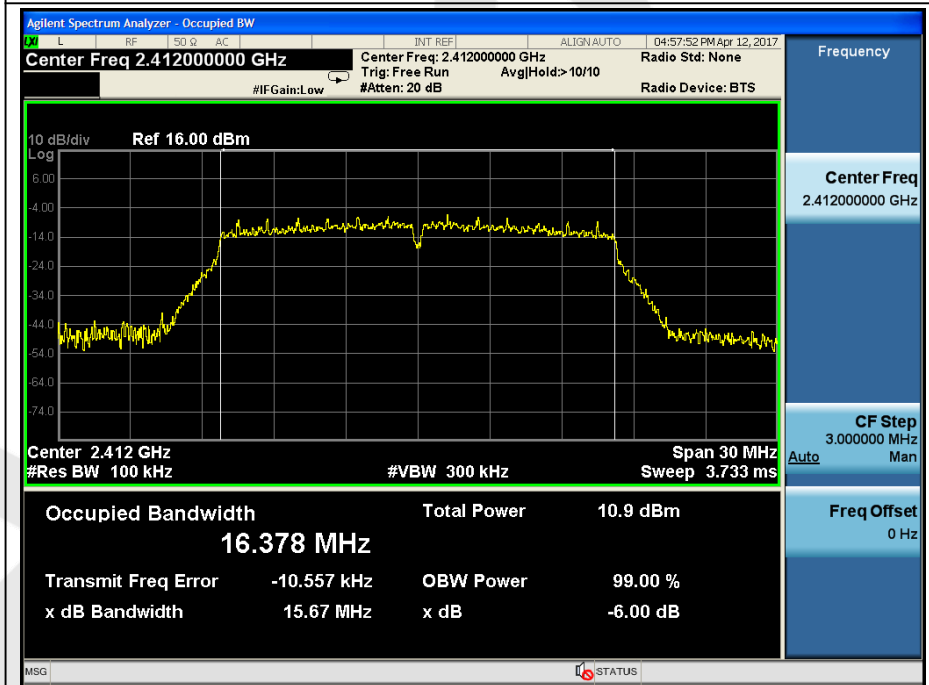

Test Mode: 802.11g---Low

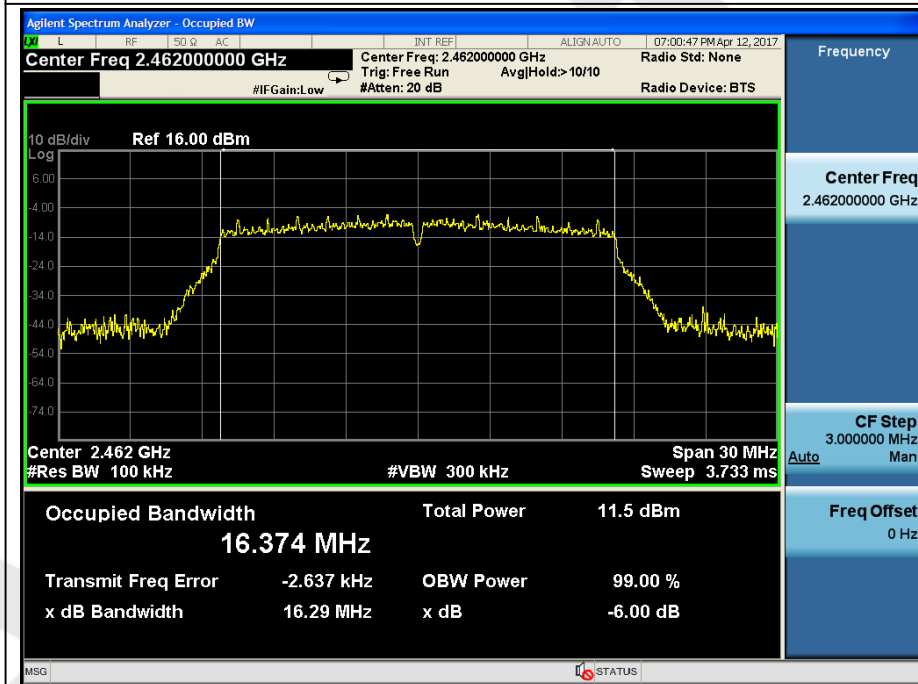
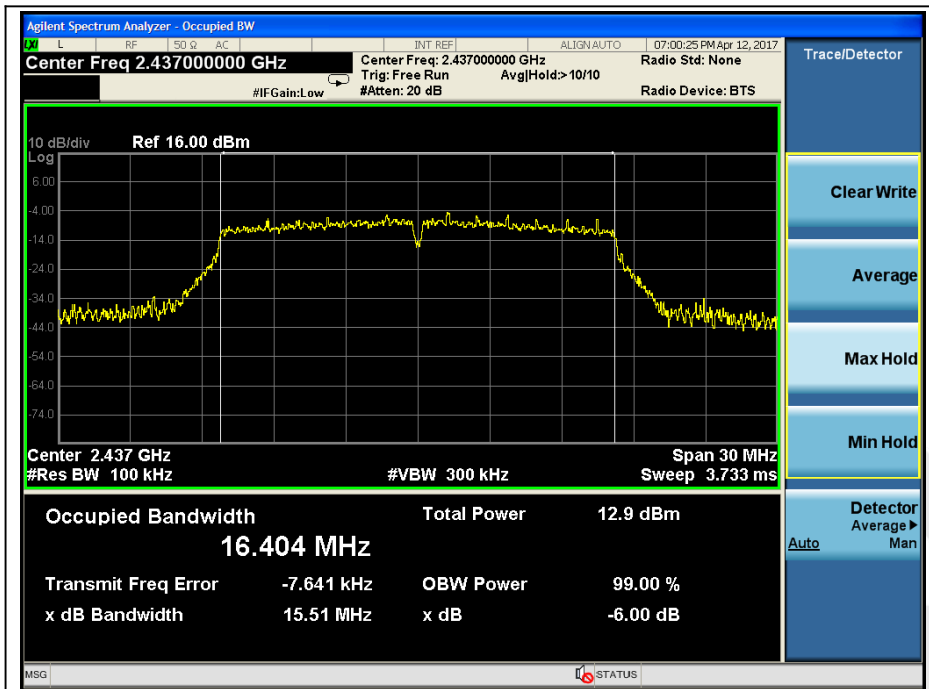

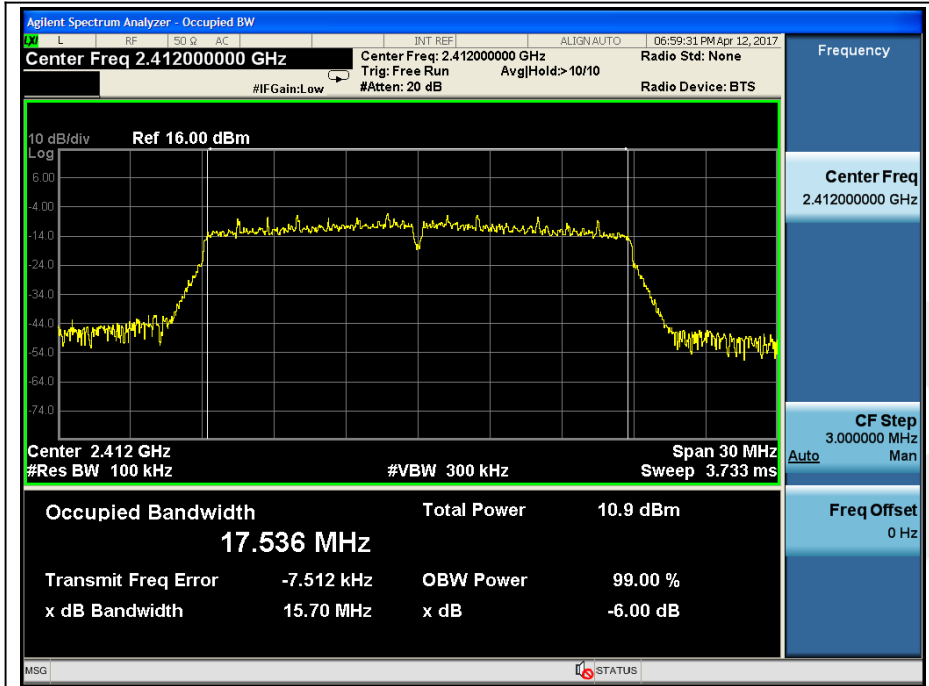

Test Mode: 802.11n20---Low

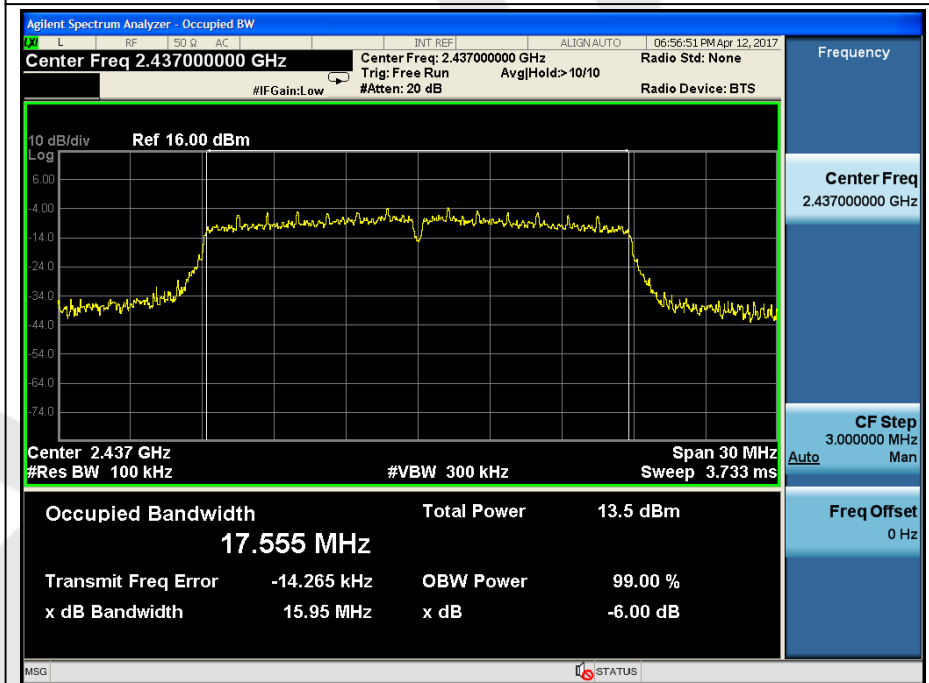

Test Mode: 802.11n20---Mid

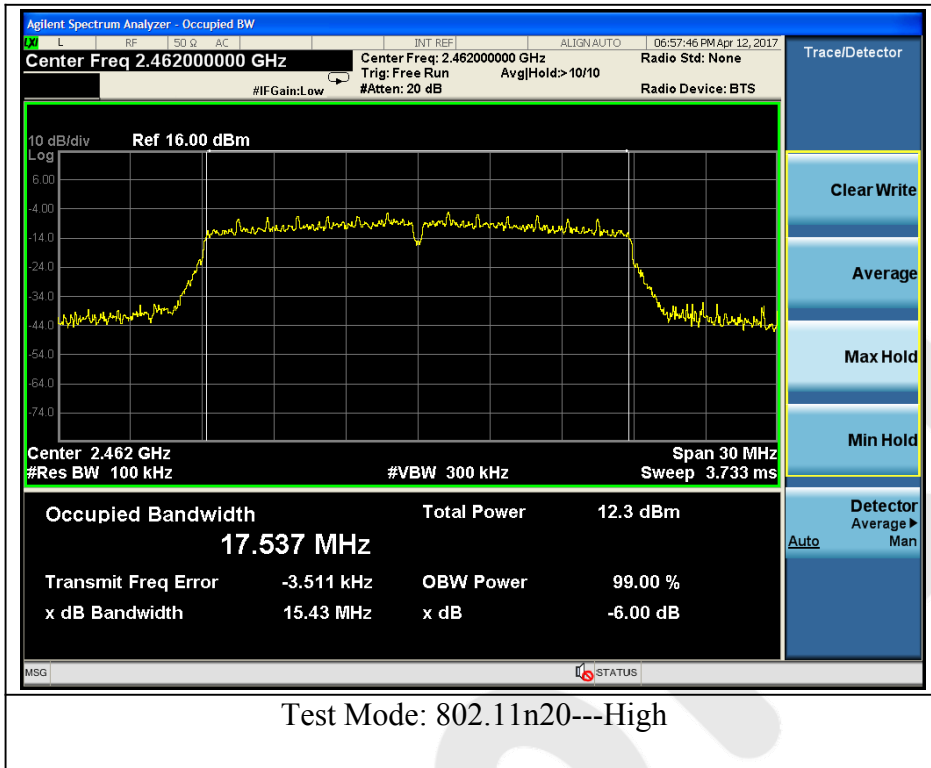

**20dB Bandwidth**

Test mode: IEEE 802.11b

Channel	Frequency (MHz)	Bandwidth (MHz)	Results
Low	2412	14.68	Pass
Mid	2437	14.71	Pass
High	2462	15.14	Pass

Test mode: IEEE 802.11g

Channel	Frequency (MHz)	Bandwidth (MHz)	Results
Low	2412	18.99	Pass
Mid	2437	18.56	Pass
High	2462	18.82	Pass

Test mode: IEEE 802.11n (HT20)

Channel	Frequency (MHz)	Bandwidth (MHz)	Results
Low	2412	19.22	Pass
Mid	2437	19.21	Pass
High	2462	19.21	Pass

Test Plots See the following page.

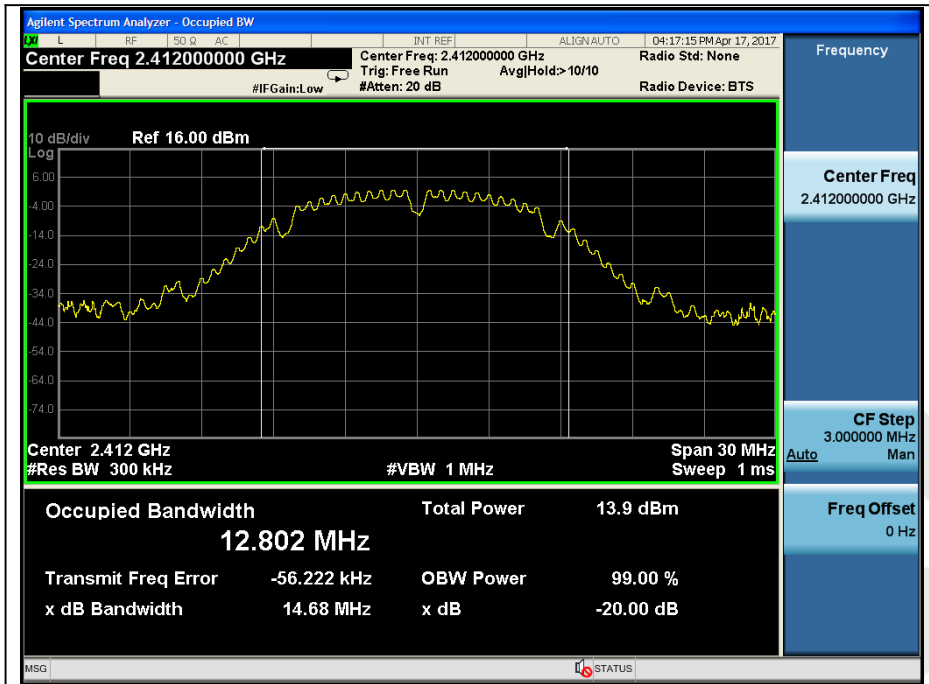

Test Mode: 802.11b---Low

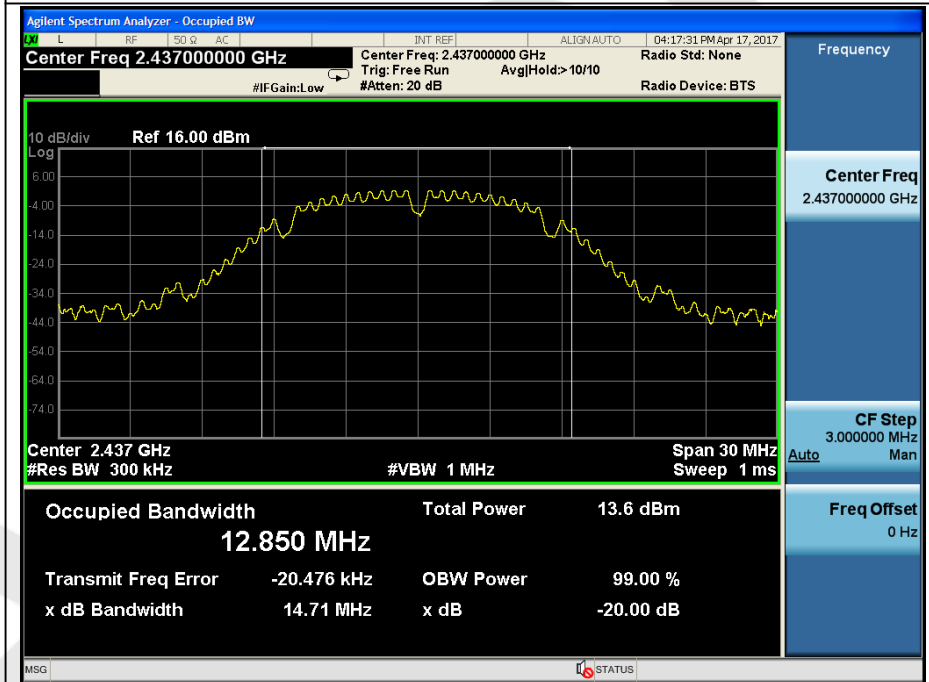

Test Mode: 802.11b---Mid

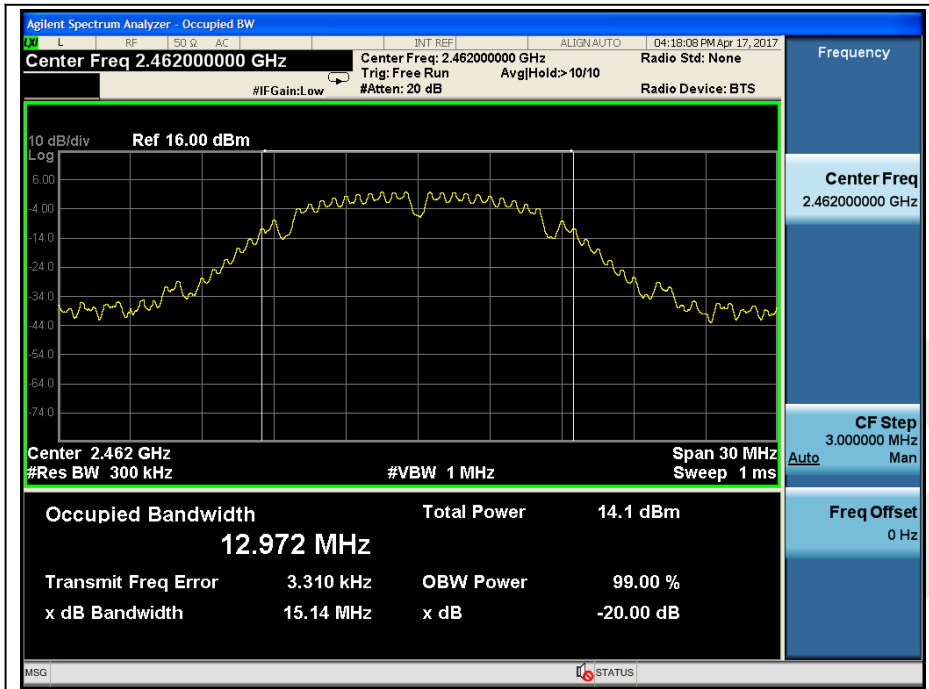

Test Mode: 802.11b---High

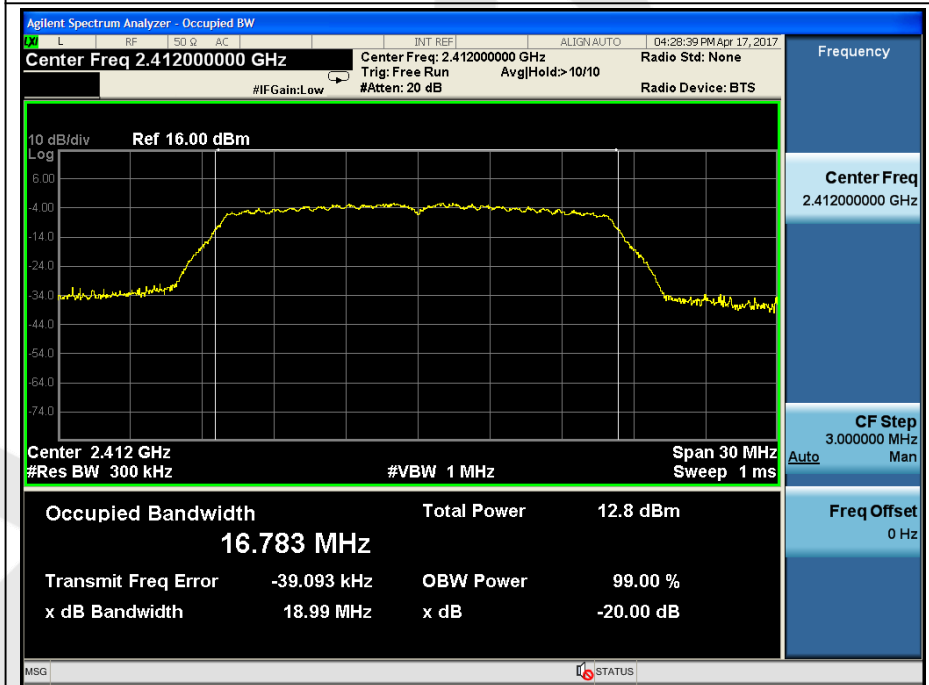

Test Mode: 802.11g---Low

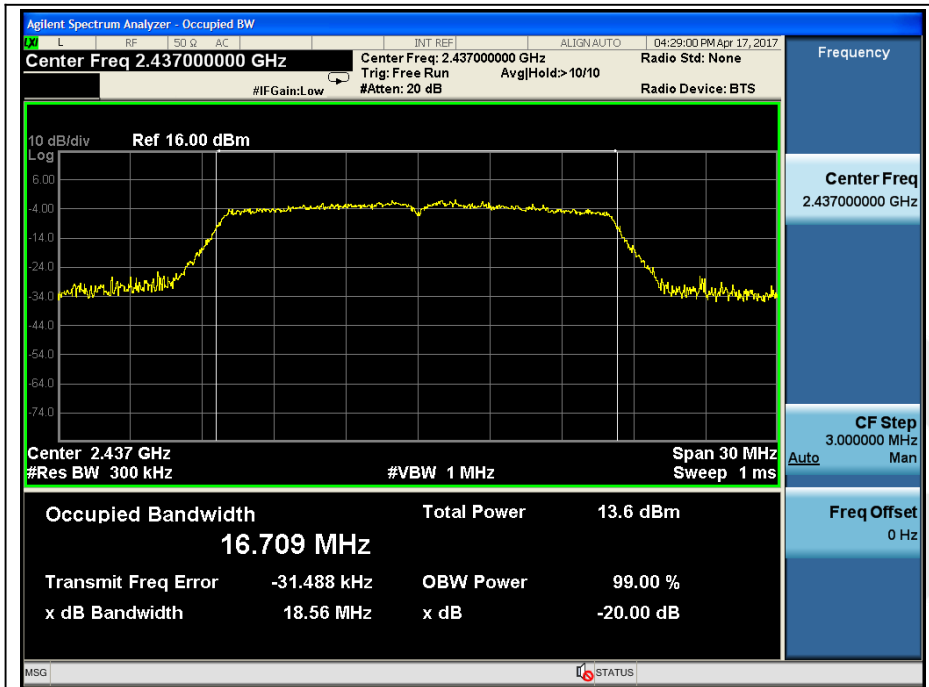

Test Mode: 802.11g---Mid

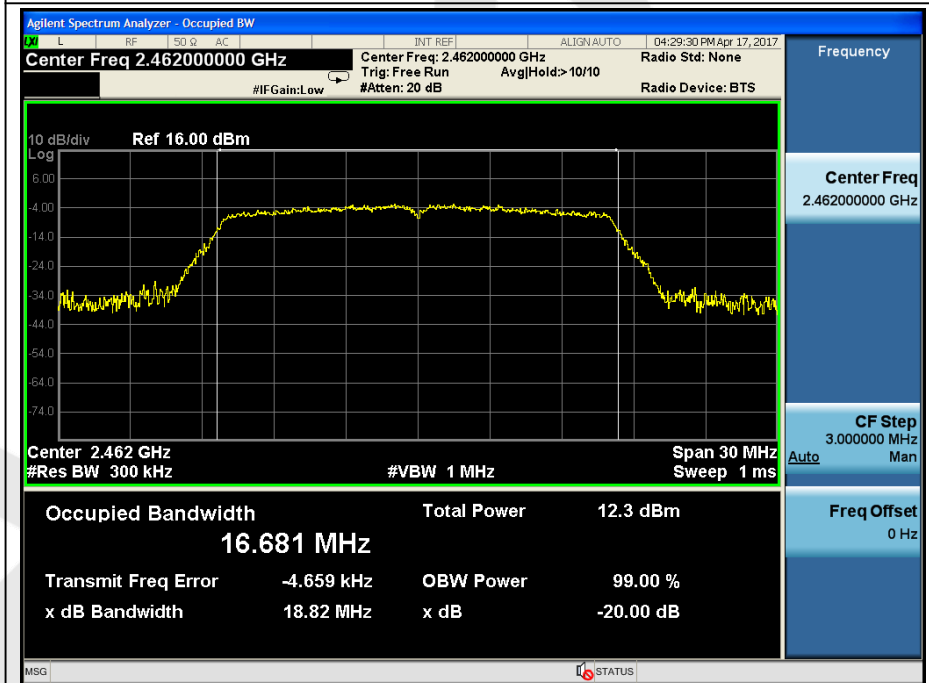

Test Mode: 802.11g---High

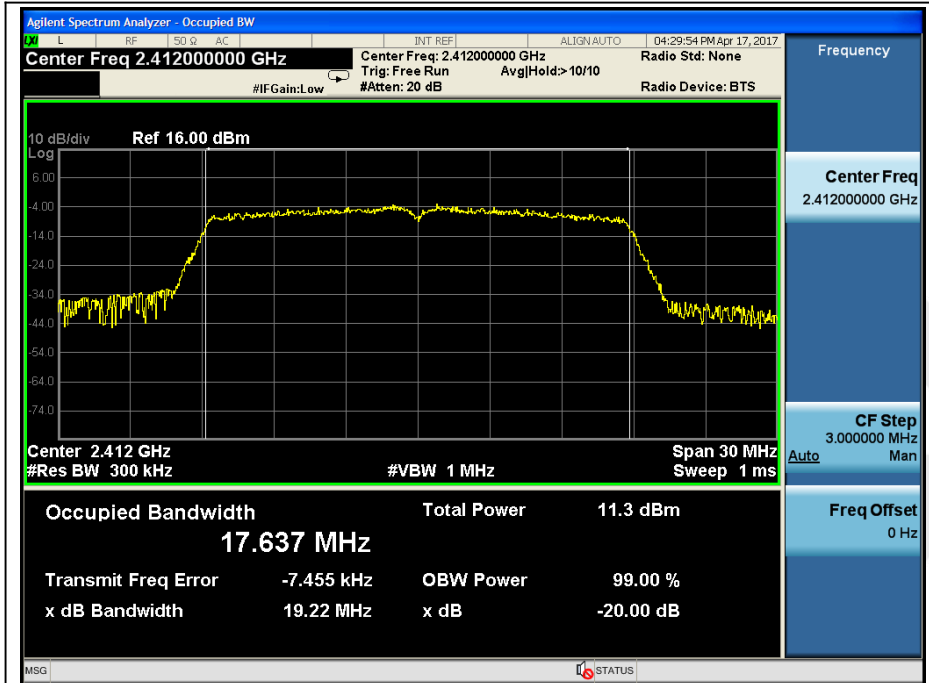

Test Mode: 802.11n20---Low

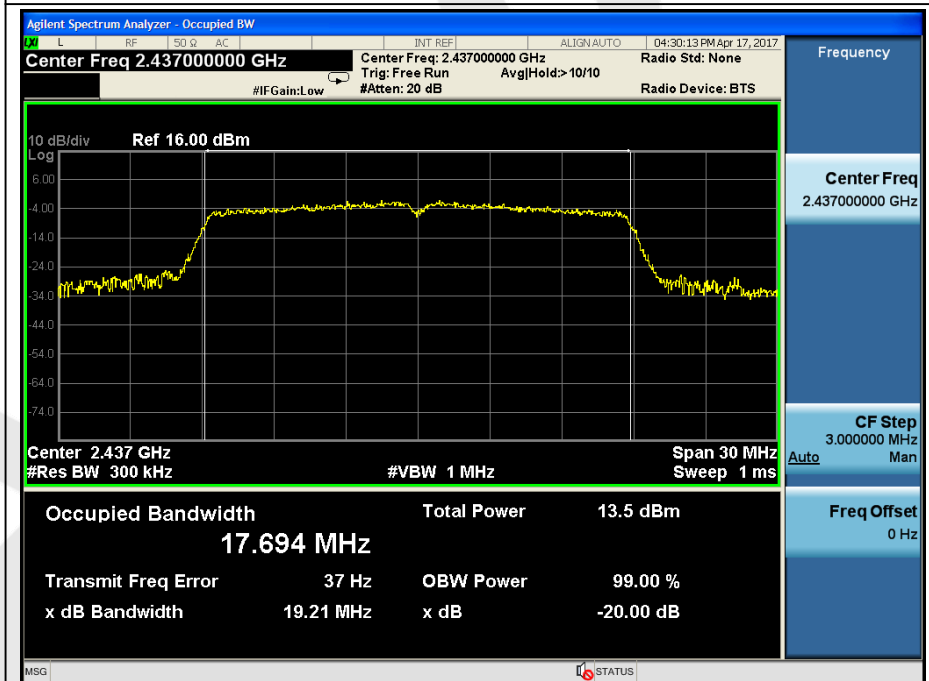

Test Mode: 802.11n20---Mid

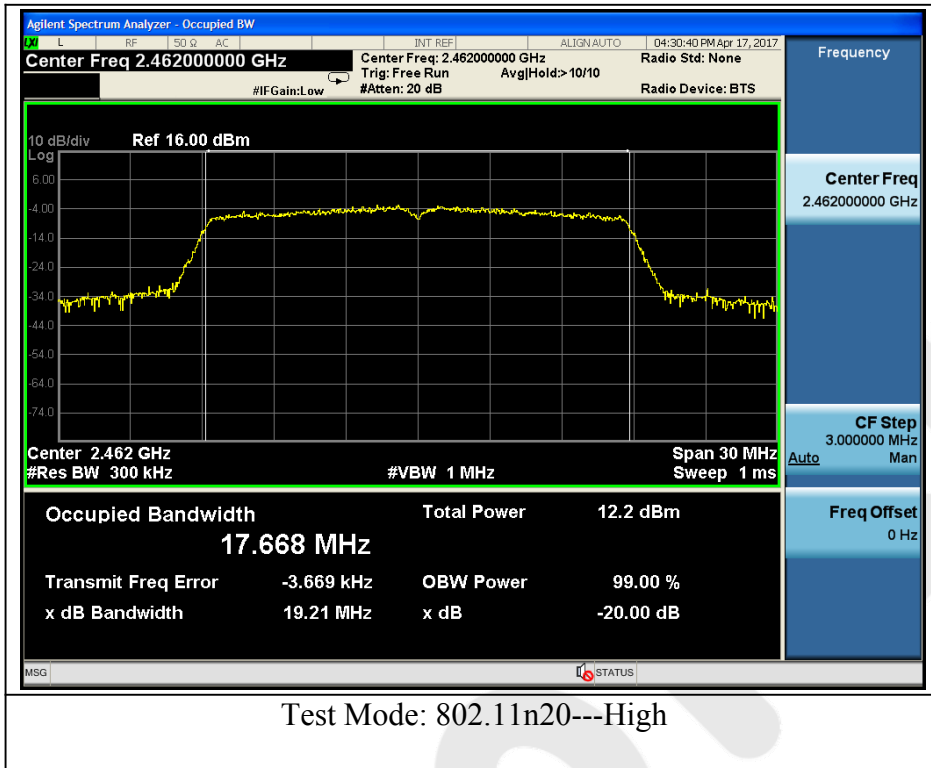

### 4.3. Maximum Output Power Test

#### a. Limit

The maximum output power of the intentional radiator shall not exceed the following:

1. For systems using digital modulation in the bands of 902-928 MHz, 2400-2483.5 MHz, and 5725-5850 MHz: 1 watt (30dBm).
2. Except as shown in paragraphs (b)(3) (i), (ii) and (iii) of this section, if transmitting antenna of directional gain greater than 6 dBi are used the peak output power from the intentional radiator shall be reduced below the stated values in paragraphs (b)(1) or (b)(2) of this section, as appropriate, by the amount in dB that the directional gain of the antenna exceeds 6 dBi.

#### b. Configuration of Measurement

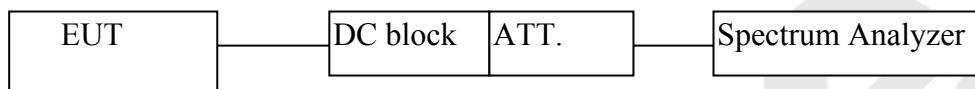

#### c. Data Rates

IEEE802.11b: Channel 1(2412MHz), Channel 6(2437MHz) and Channel 11(2462MHz) with 1 Mbps data rate (worst case) are chosen for the final testing.

IEEE802.11g: Channel 1(2412MHz), Channel 6(2437MHz) and Channel 11(2462MHz) with 6 Mbps data rate (the worst case) are chosen for the final testing.

IEEE802.11n (HT20: Channel 1(2412MHz), Channel 6(2437MHz) and Channel 11(2462MHz) with 6.5Mbps data rate (the worst case) are chosen for the final testing.

#### d. Test Procedure

**This test was according the kDB 558074 D01 DTS Meas Guidance v03r05 9.1.1:**

1. Set span to at least 1.5 times the OBW.
2. Set the RBW =1~5% of the OBW, not to exceed 1MHz.
3. Set  $VBW \geq 3 * RBW$ .
4. Detector = Average.
5. Sweep time = auto couple.
6. Trace mode = max hold.
7. Allow trace to fully stabilize.

#### e. Test Equipment

Same as the equipment listed in 4.2.

#### f. Test Results

Pass.

**g. Test Data**

Test mode: IEEE 802.11b

Channel	Frequency (MHz)	Maximum transmit power (dBm)	Limit		Result
			(dBm)	(watts)	
Low	2412	8.73	30	1	Pass
Mid	2437	8.82			Pass
High	2462	9.33			Pass

Test mode: IEEE 802.11g

Channel	Frequency (MHz)	Maximum transmit power (dBm)	Limit		Result
			(dBm)	(watts)	
Low	2412	7.48	30	1	Pass
Mid	2437	8.27			Pass
High	2462	8.90			Pass

Test mode: IEEE 802.11n (HT20)

Channel	Frequency (MHz)	Maximum transmit power (dBm)	Limit		Result
			(dBm)	(watts)	
Low	2412	7.56	30	1	Pass
Mid	2437	8.29			Pass
High	2462	8.87			Pass

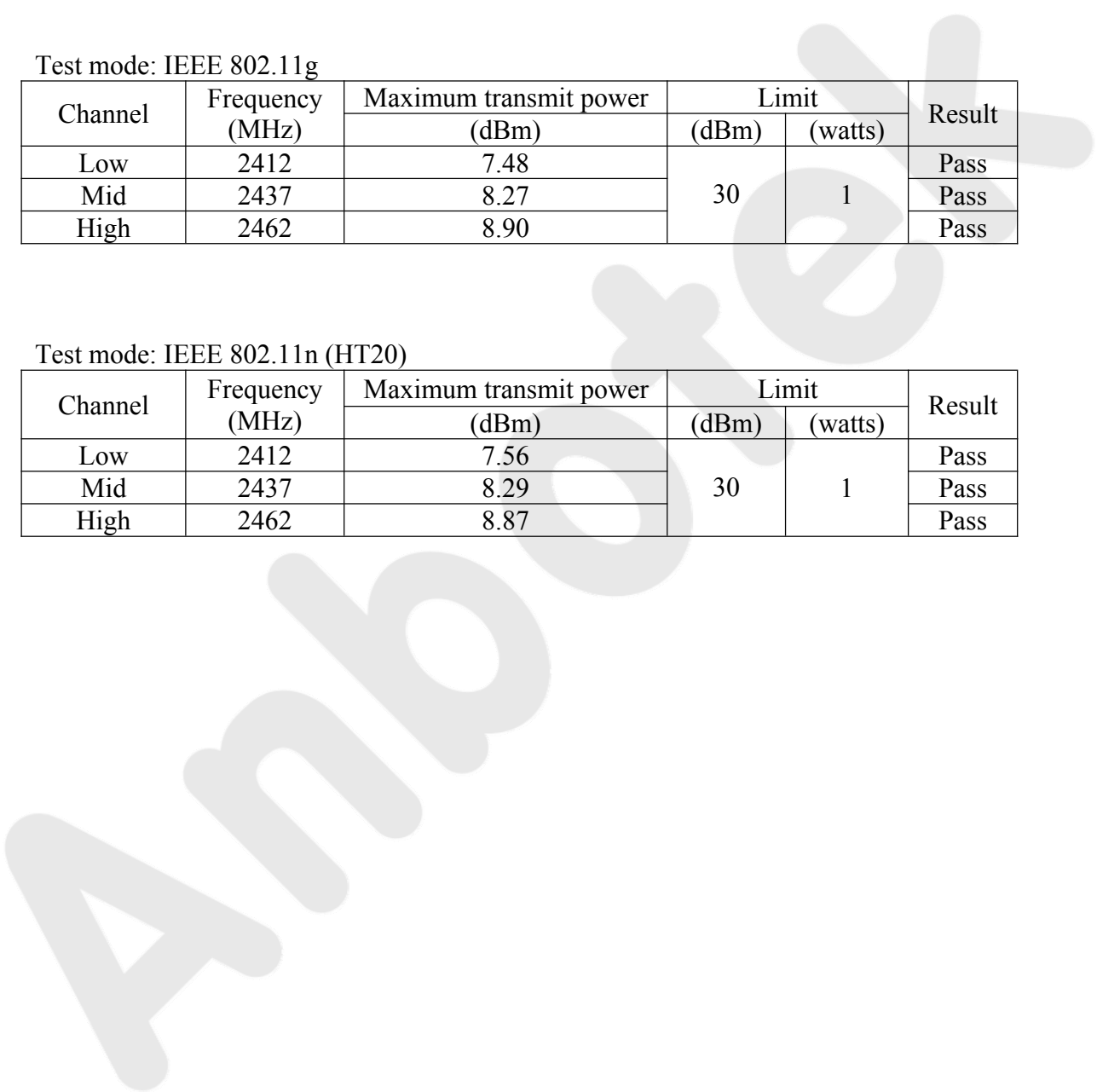

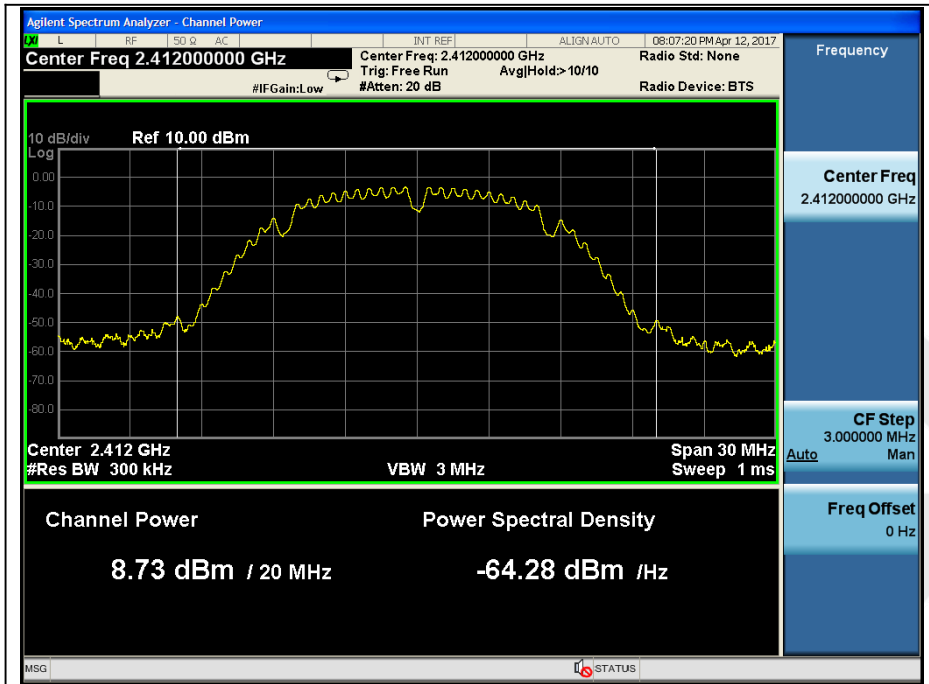

Test Mode: 802.11b---Low

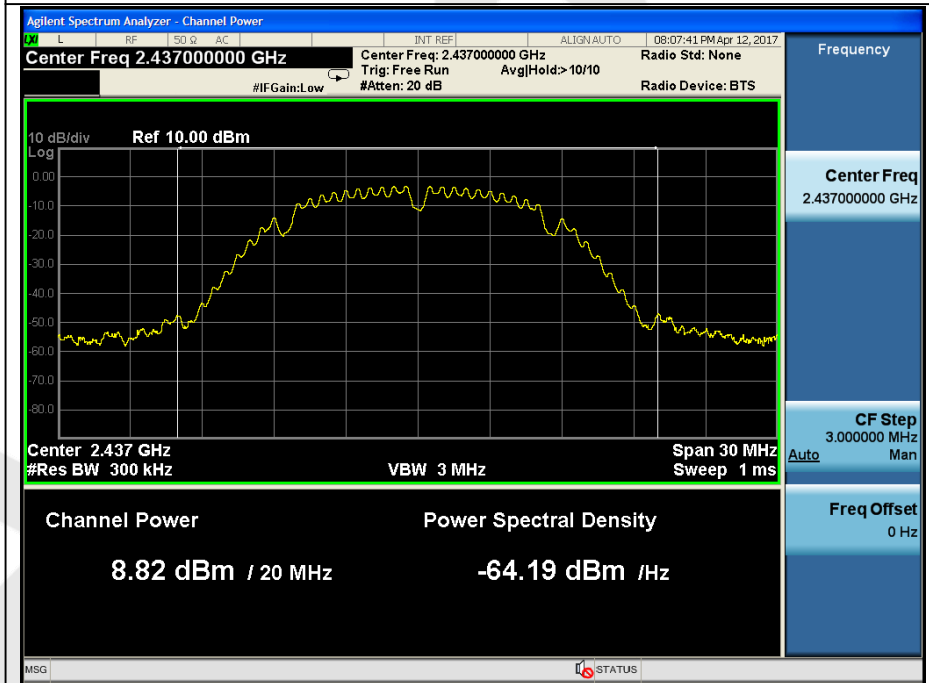

Test Mode: 802.11b---Mid



Test Mode: 802.11b---High

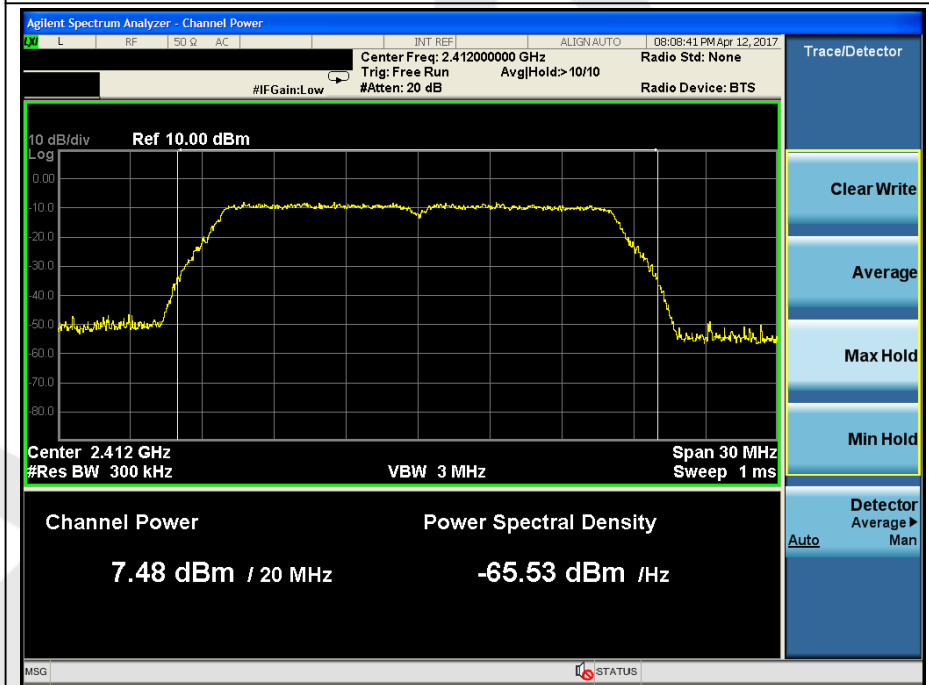

Test Mode: 802.11g---Low

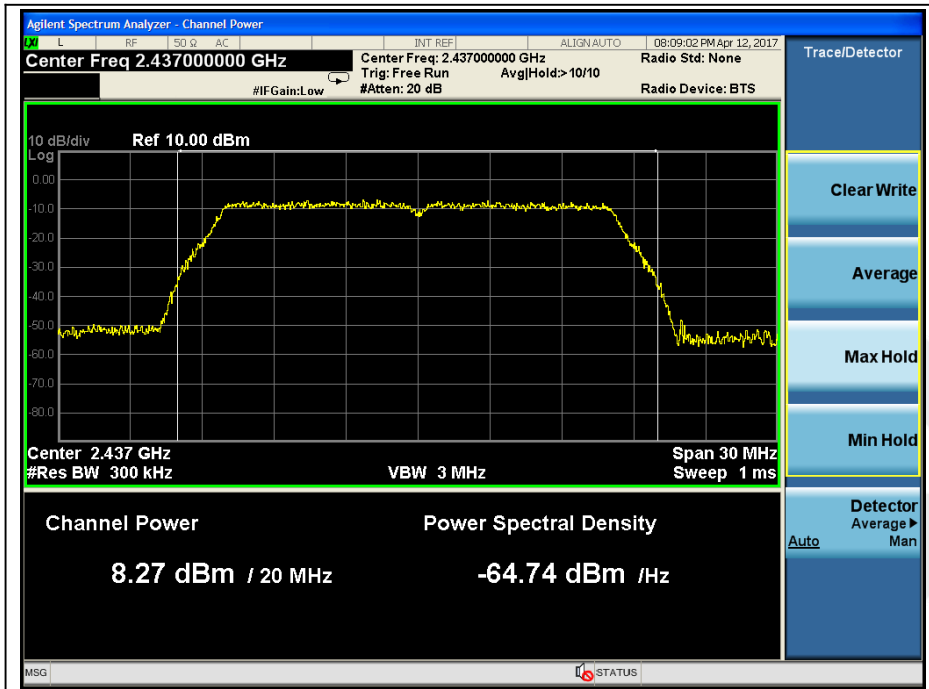

Test Mode: 802.11g---Mid

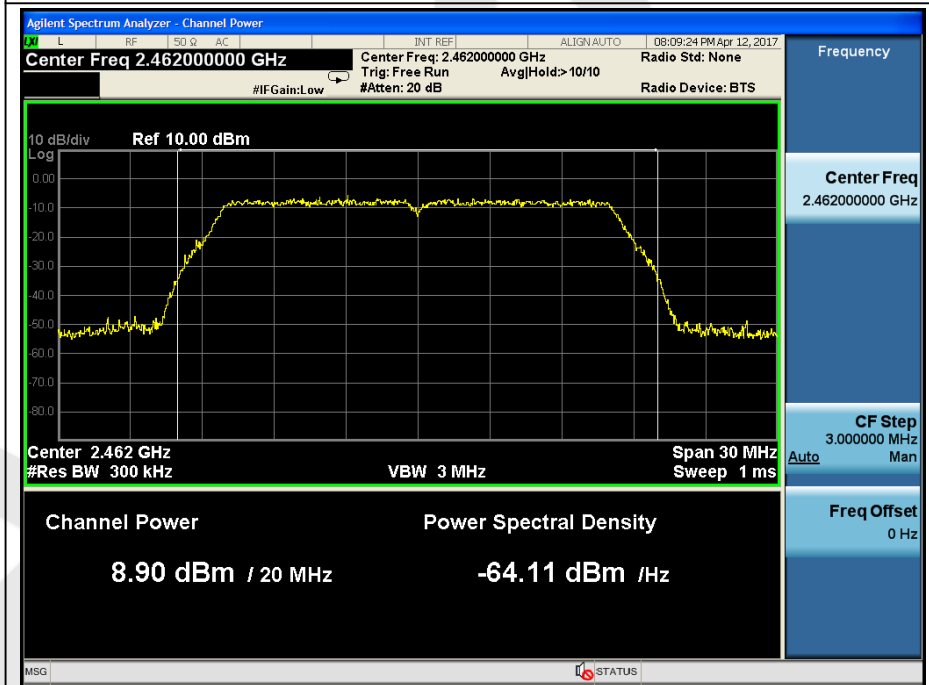

Test Mode: 802.11g---High

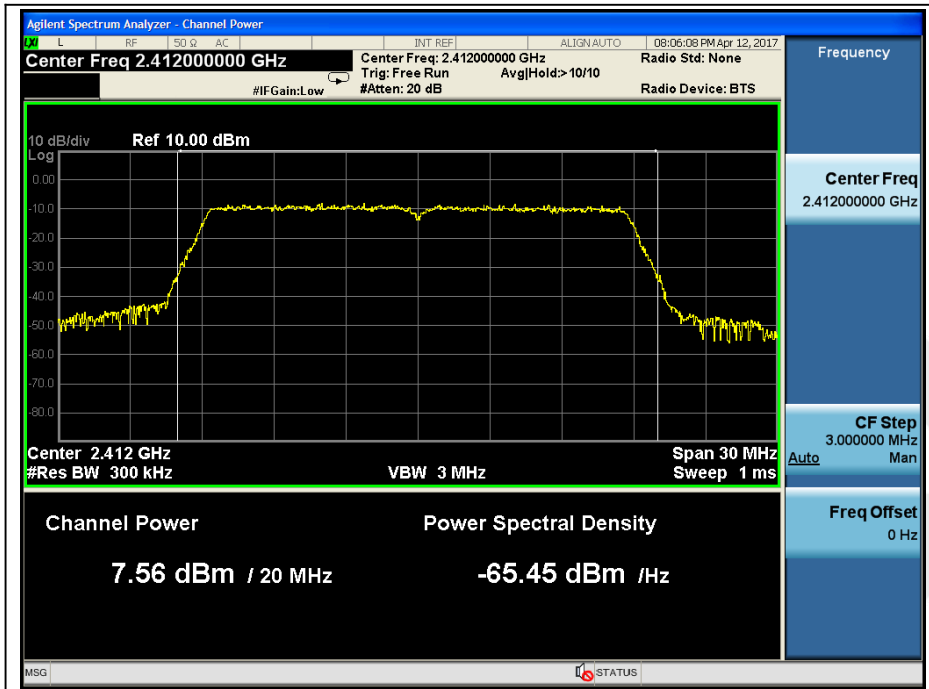

Test Mode: 802.11n20---Low

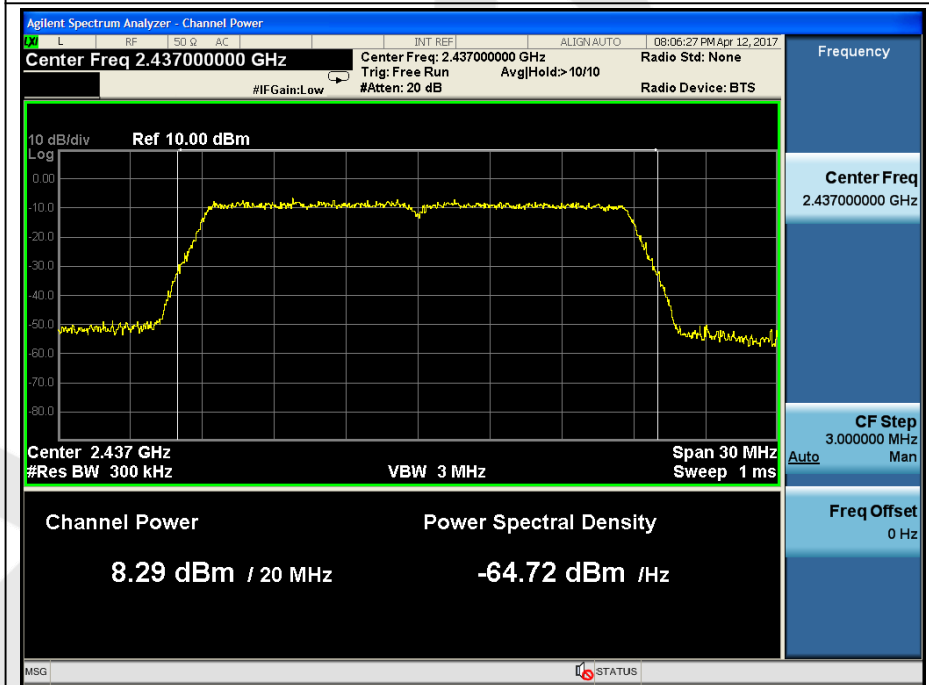

Test Mode: 802.11n20---Mid

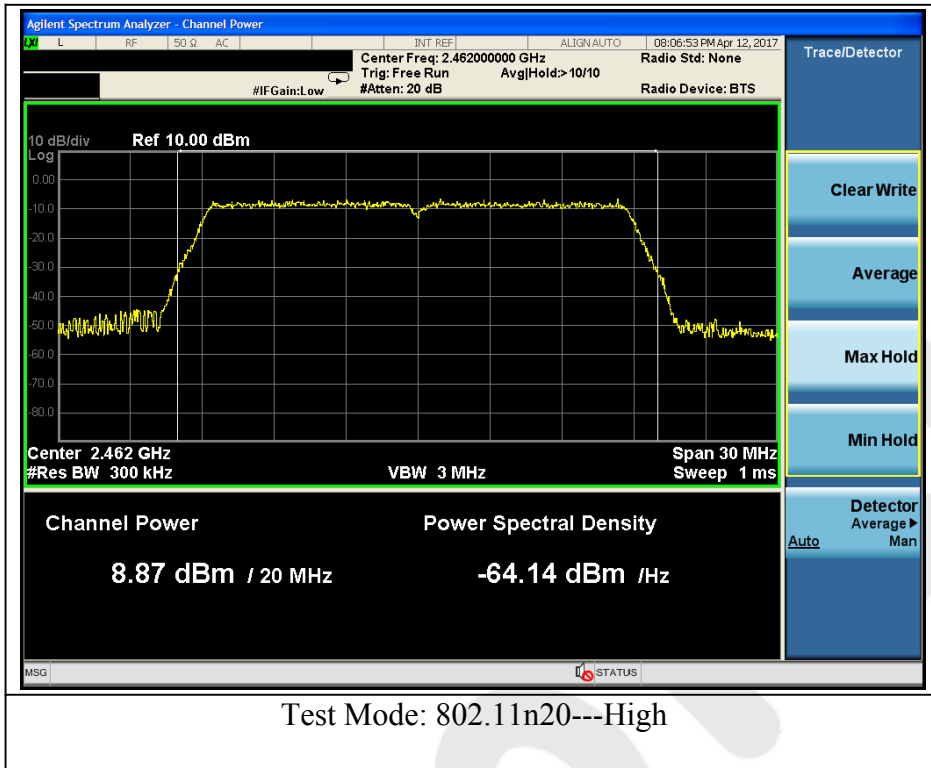

#### 4.4. Duty Cycle

##### a. Test Procedure

The zero-span mode on a spectrum analyzer or EMI receiver if the response time and spacing between bins on the sweep are sufficient to permit accurate measurements of the on and off times of the transmitted signal.

Set the center frequency of the instrument to the center frequency of the transmission.

Set RBW  $\geq$  OBW if possible; otherwise, set RBW to the largest available value.

Set VBW  $\geq$  RBW. Set detector = peak or average. The zero-span measurement method shall not be used unless both RBW and VBW are  $> 50/T$  and the number of sweep points across duration T exceeds 100. (For example, if VBW and/or RBW are limited to 3 MHz, then the zero-span method of measuring duty cycle shall not be used if  $T \leq 16.7$  microseconds.)

The RF output of EUT was connected to the spectrum analyzer by RF cable and attenuator.

The path loss was compensated to the results for each measurement.

Set to the maximum power setting and enable the EUT transmit continuously.

The EUT was operating in controlled its channel.

Use the following spectrum analyzer settings:

Span = Zero Span

RBW = 8MHz

VBW =8MHz

Number of points in Sweep  $>100$

Detector function = peak

Trace = Clear write Measure Ttotal and Ton

Calculate Duty Cycle =  $T_{on} / T_{total}$  and Duty Cycle Factor= $10 \cdot \log(1/Duty\ Cycle)$

##### b. Test Setup

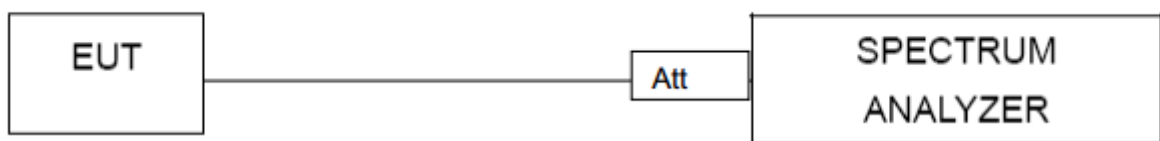

##### c. Test Data

Test Mode	Frequency (MHz)	T <sub>on</sub> (ms)	T <sub>total</sub> (ms)	Duty Cycle
802.11b	2437	10	10	100%
802.11g	2437	10	10	100%
802.11n(HT20)	2437	10	10	100%

The maximum duty cycle is not less than 98%

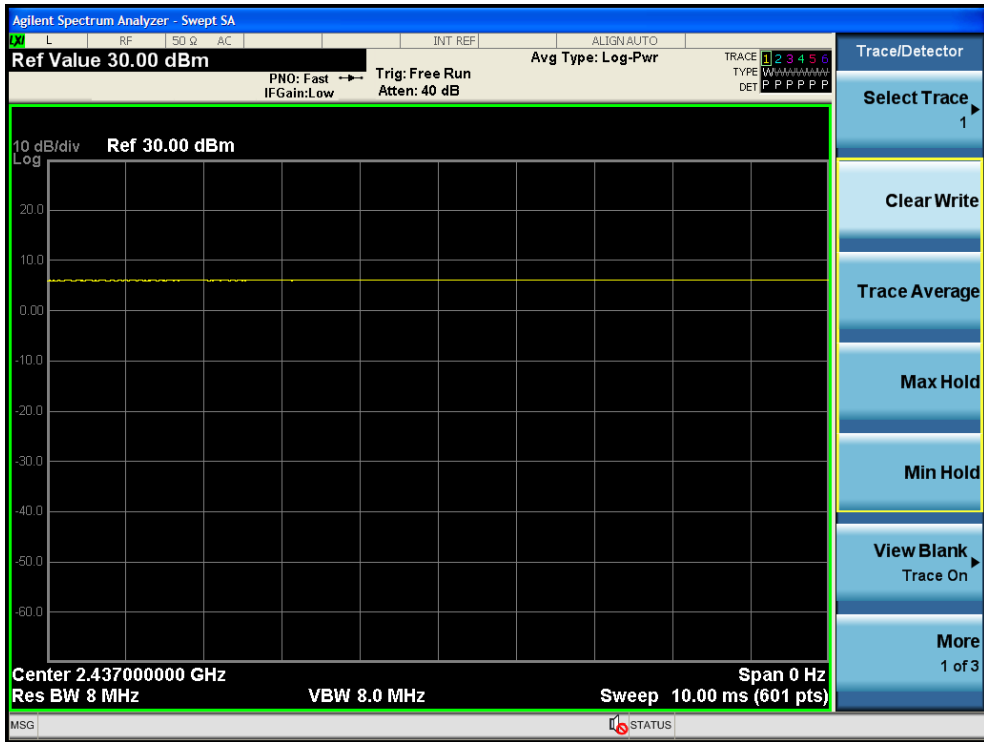

Test Mode: 802.11 b

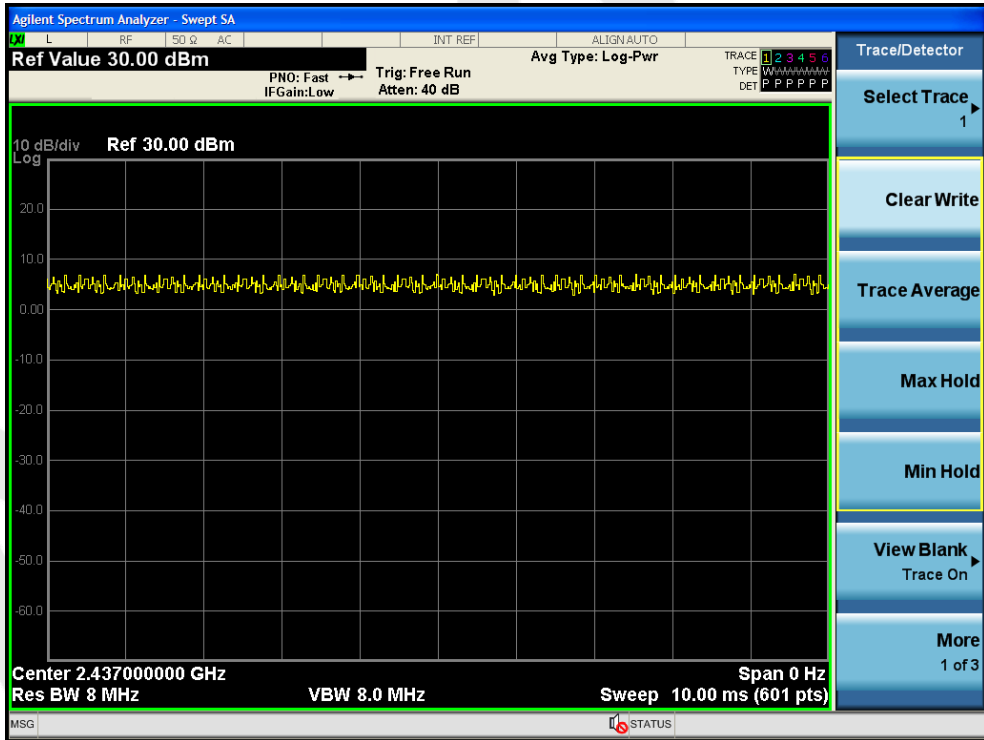

Test Mode: 802.11 g

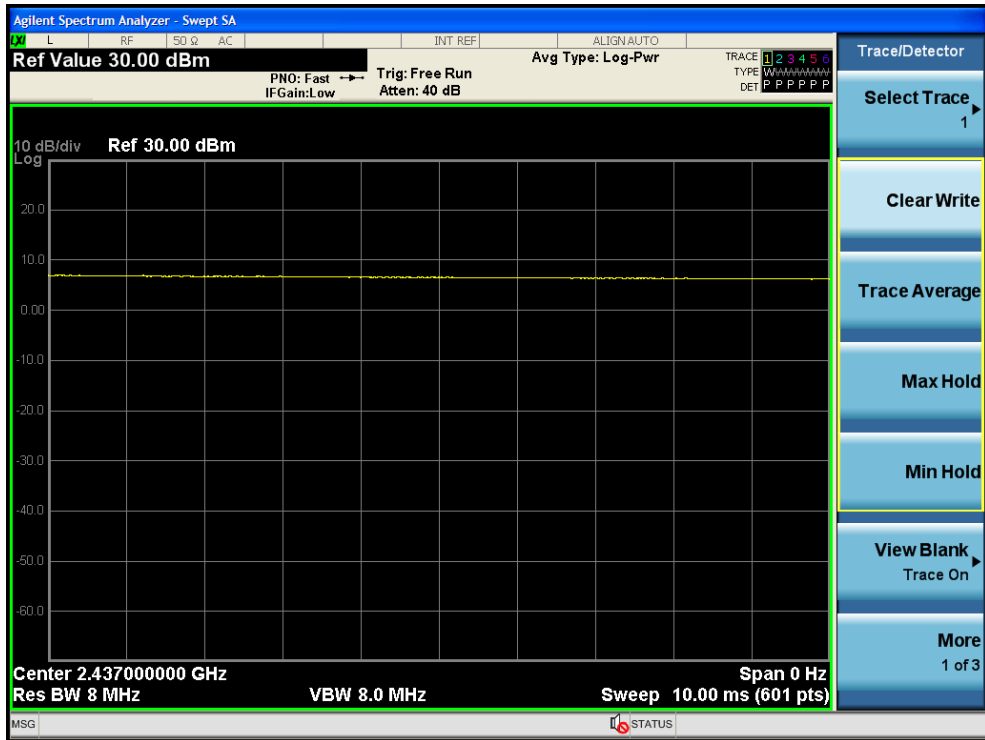

Test Mode: 802.11 n(HT20)

#### 4.5. 100 kHz bandwidth outside the frequency Measurement

##### **a. Applicable Standard**

In any 100 kHz bandwidth outside the frequency band in which the spread spectrum or digitally modulated intentional radiator is operating, the radio frequency power that is produced by the intentional radiator shall be at least 20 dB below that in the 100 kHz bandwidth within the band that contains the highest level of the desired power, based on either an RF conducted or a radiated measurement, provided the transmitter demonstrates compliance with the peak conducted power limits. If the transmitter complies with the conducted power limits based on the use of RMS averaging over a time interval, as permitted under paragraph (b)(3) of this section, the attenuation required under this paragraph shall be 30 dB instead of 20 dB. Attenuation below the general limits specified in §15.209(a) is not required. In addition, radiated emissions which fall in the restricted bands, as defined in §15.205(a), must also comply with the radiated emission limits specified in §15.209(a) (see §15.205(c)).

##### **b. Measurement Procedure**

The EUT must have its hopping/Non-hopping function enabled. Using the following spectrum analyzer setting:

1. Set the RBW = 100KHz.
2. Set the VBW = 300KHz.
3. Sweep time = auto couple.
4. Detector function = peak.
5. Trace mode = max hold.
6. Allow trace to fully stabilize.

##### **c. Test Equipment**

Same as the equipment listed in 4.2.

##### **d. Test Setup**

See 4.1

**Test Results:**

Mode	Frequency Band	Delta Peak to band emission (dBc)	Limit (dBc)	Result
802.11b mode	2400	42.931	30	Pass
	2483.5	55.649	30	Pass
802.11g mode	2400	37.901	30	Pass
	2483.5	52.652	30	Pass
802.11n(HT20) mode	2400	36.478	30	Pass
	2483.5	42.459	30	Pass

Anbotek

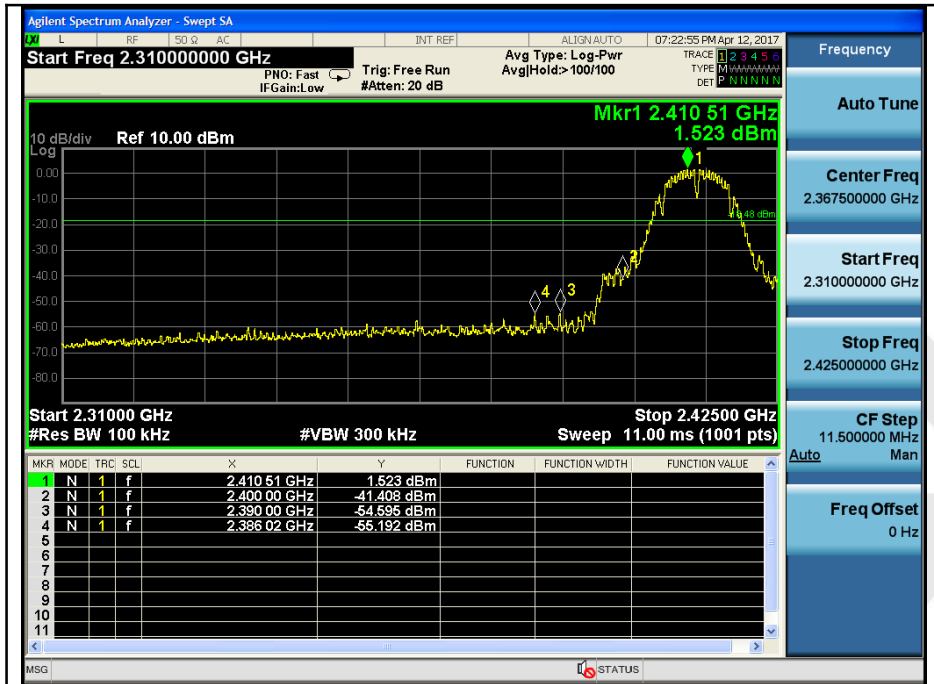

Test Mode: 802.11b---Low



Test Mode: 802.11b---High



Test Mode: 802.11g---Low



Test Mode: 802.11g---High

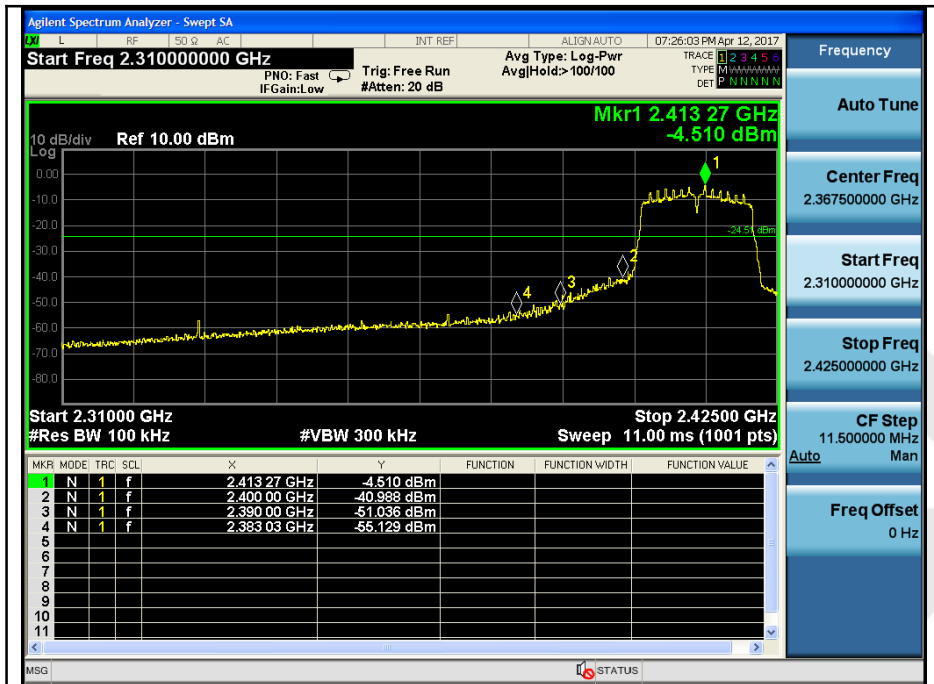

Test Mode: 802.11n20---Low



Test Mode: 802.11n20---High

#### 4.6. Peak Power Spectral Density

##### **a. Limit**

1. For direct sequence systems, the peak power spectral density conducted from the intentional radiator to the antenna shall not be greater than 8dBm in any 3kHz band during any time interval of continuous transmission.
2. The direct sequence operating of the hybrid system, with the frequency hopping operation turned off, shall comply with the power density requirements of paragraph (d) of this section.

##### **b. Test Procedure**

1. Place the EUT on the table and set it in transmitting mode. Remove the antenna from the EUT and then connect a low loss RF cable from the antenna port to the spectrum analyzer.
2. Set the spectrum analyzer as RBW = 3.0kHz, VBW = 10kHz, Span = 1.5xDTS BW
3. Record the max. reading.
4. Repeat the above procedure until the measurements for all frequencies are completed.

##### **c. Test Equipment**

Same as the equipment listed in 4.2.

##### **d. Test Setup**

See 4.1

Anbotek

**Test Results:**

Test mode: IEEE 802.11b

Channel	Frequency (MHz)	PPSD (dBm/3KHz)	∑PPSD (dBm/3KHz)	Limit (dBm)	Result
Low	2412	-12.341	-	8.00	Pass
Mid	2437	-11.929	-		Pass
High	2462	-12.200	-		Pass

Test mode: IEEE 802.11g

Channel	Frequency (MHz)	PPSD (dBm)	∑PPSD (dBm)	Limit (dBm)	Result
Low	2412	-19.105	-	8.00	Pass
Mid	2437	-16.253	-		Pass
High	2462	-17.174	-		Pass

Test mode: IEEE 802.11n (HT20)

Channel	Frequency (MHz)	PPSD (dBm/3KHz)	∑PPSD (dBm/3KHz)	Limit (dBm)	Result
Low	2412	-19.483	-	8.00	Pass
Mid	2437	-17.527	-		Pass
High	2462	-18.432	-		Pass



Test Mode: 802.11b---Low



Test Mode: 802.11b---Mid



Test Mode: 802.11b---High

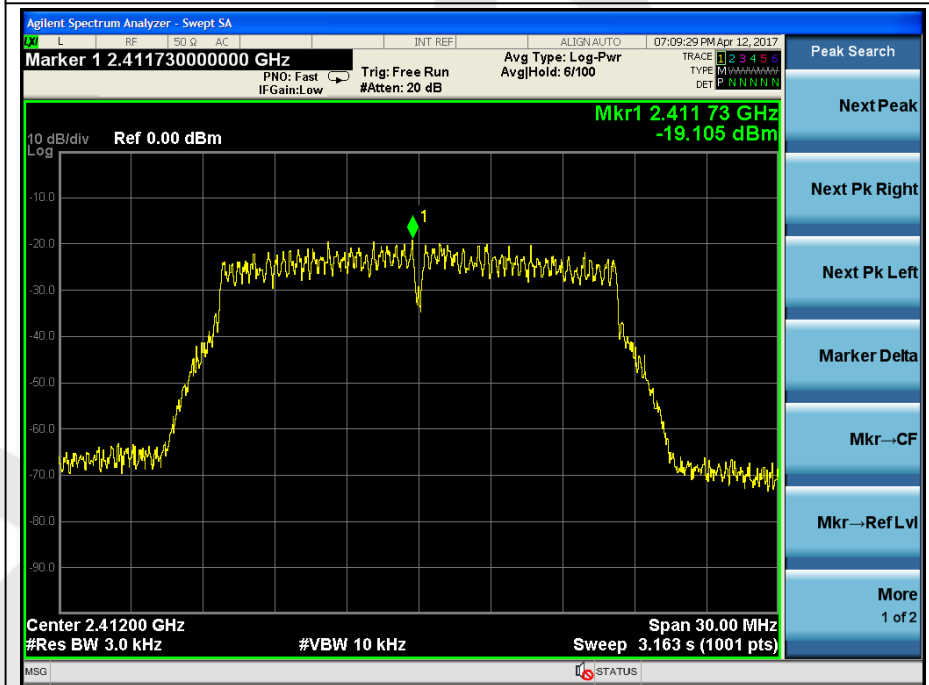

Test Mode: 802.11g---Low

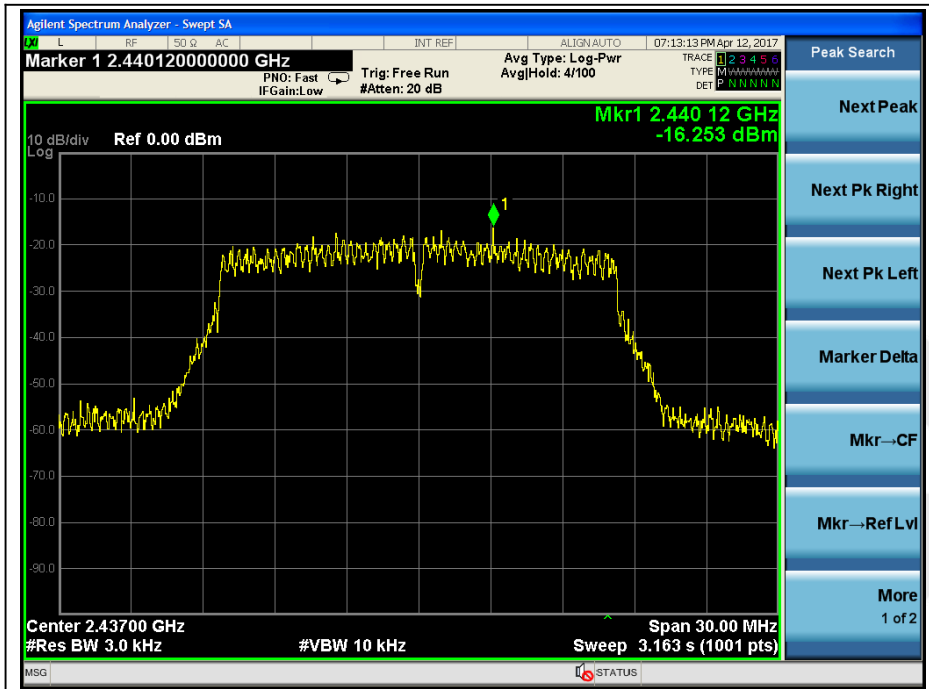

Test Mode: 802.11g---Mid



Test Mode: 802.11g---High

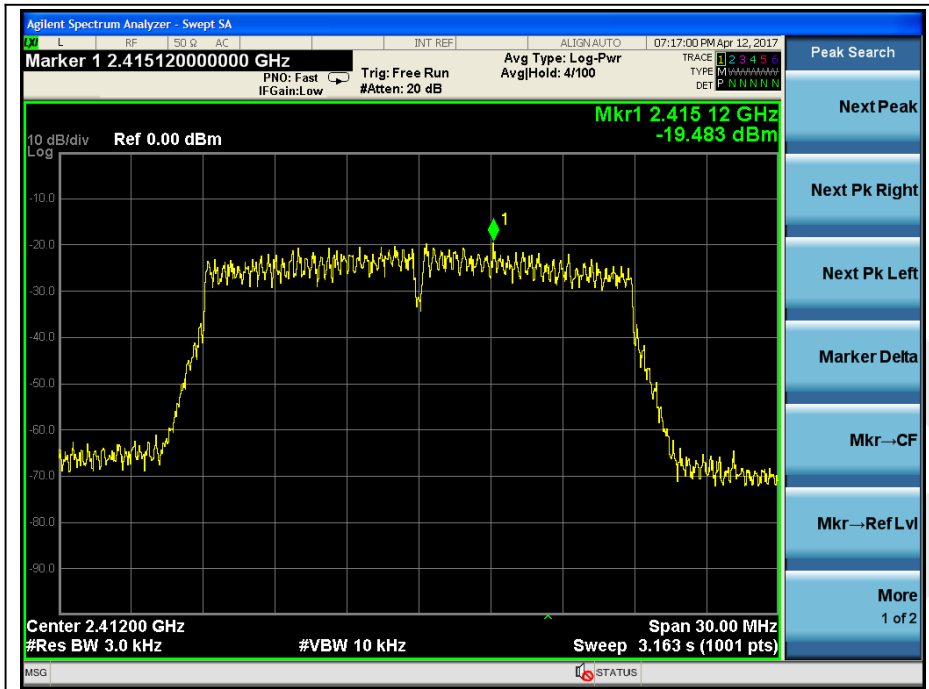

Test Mode: 802.11n20---Low

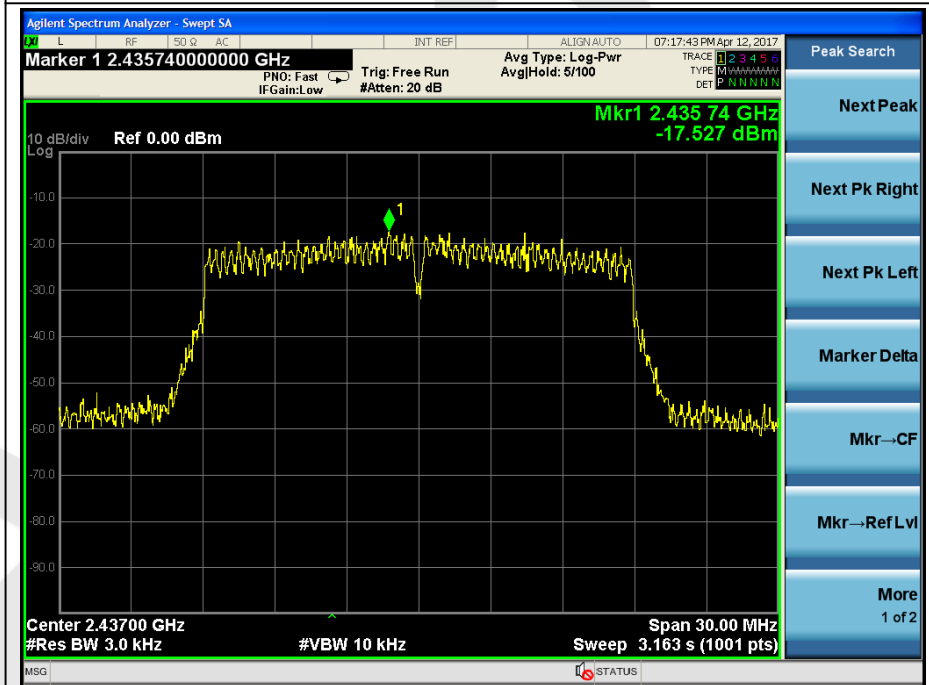

Test Mode: 802.11n20---Mid

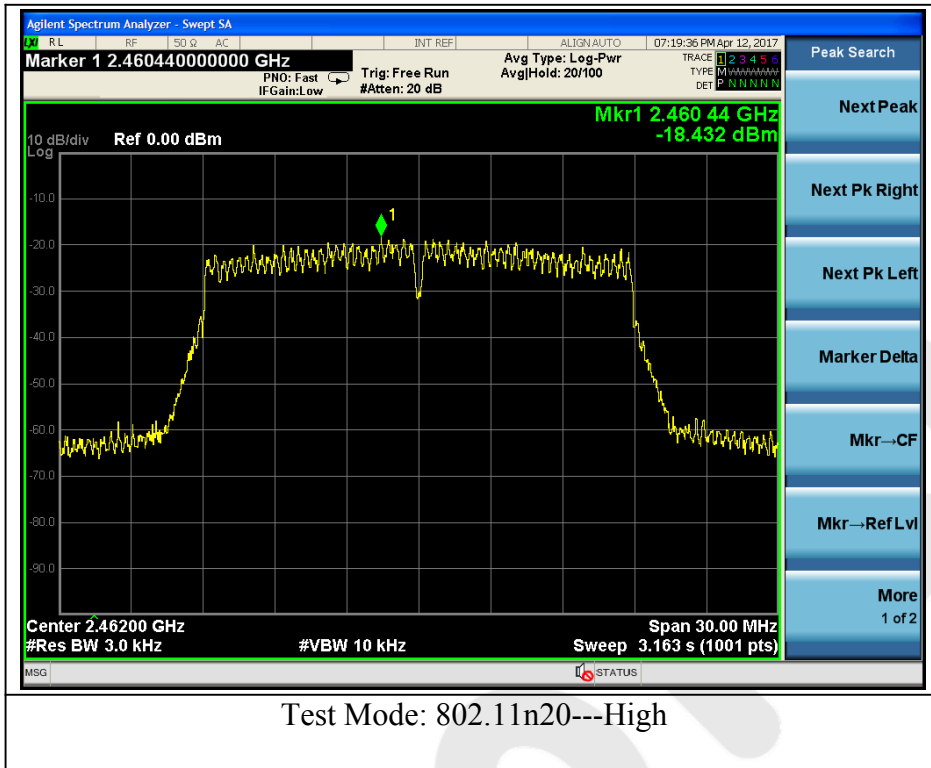

#### 4.7. Radiated Emissions and Band Edge Measurement

##### 4.7.1.1. Test Limits (< 30 MHz)

Frequency (MHz)	Field Strength (microvolts/meter)	Measurement Distance (meter)
0.009-0.490	2400/F(kHz)	300
0.490-1.705	24000/F(kHz)	30
1.705-30.0	30	30

##### 4.7.1.2. Test Limits (≥ 30 MHz)

FIELD STRENGTH of Fundamental: @3M	FIELD STRENGTH of Harmonics	S15.209 30 - 88 MHz	40 dBuV/m
902-928 MHz		88 - 216 MHz	43.5
2.4-2.4835 GHz		216 - 960 MHz	46
94 dBμV/m @3m	54 dBμV/m @3m	ABOVE 960 MHz	54dBuV/m

In any 100 kHz bandwidth outside the frequency band in which the spread spectrum or digitally modulated intentional radiator is operating, the radio frequency power that is produced by the intentional radiator shall be at least 20 dB below that in the 100 kHz bandwidth within the band that contains the highest level of the desired power, based on either an RF conducted or a radiated measurement. Attenuation below the general limits specified in Section 15.209(a) is not required. In addition, radiated emissions which fall in the restricted bands, as defined in Section 15.205(a), must also comply with the radiated emission limits specified in Section 15.209(a) (see Section 15.205(c)).

##### Test Equipment

Item	Equipment	Manufacturer	Model No.	Serial No.	Last Cal.	Cal. Interval
1.	Spectrum Analysis	Agilent	E4407B	US39390582	Jul. 12, 2016	1 Year
2.	Preamplifier	Instruments corporation	EMC011830	980100	Jun. 17, 2016	1 Year
3.	EMI Test Receiver	Rohde & Schwarz	ESPI	101604	Jun. 17, 2016	1 Year
4.	Double Ridged Horn Antenna	Instruments corporation	GTH-0118	351600	May 06, 2016	1 Year
5.	Bilog Broadband Antenna	Schwarzbeck	VULB9163	VULB 9163-289	May 06, 2016	1 Year
6.	Pre-amplifier	SONOMA	310N	186860	Jun. 17, 2016	1 Year
7.	EMI Test Software EZ-EMC	SHURPLE	N/A	N/A	N/A	N/A
8.	Power Sensor	Agilent	KFSW15050 2	15I00041SN045	Jun. 17, 2016	1 Year
9.	MXA Spectrum Analysis	Agilent	N9020A	MY51170037	Jun. 17, 2016	1 Year
10.	MXG RF Vector Signal Generator	Agilent	N5182A	MY48180656	Jun. 17, 2016	1 Year
11.	Signal Generator	Agilent	E4421B	MY41000743	Jun. 17, 2016	1 Year
12.	DC Power supply	IV	IV-8080	YQSB0096	Jun. 17, 2016	1 Year
13.	TEMP&HUMI PROGRAMMABLE CHAMBER	Bell Group	BE-THK-15 0M8	SE-0137	Jun. 17, 2016	1 Year

4.7.2. Test Configuration:

4.7.2.1. 9k to 30MHz emissions:

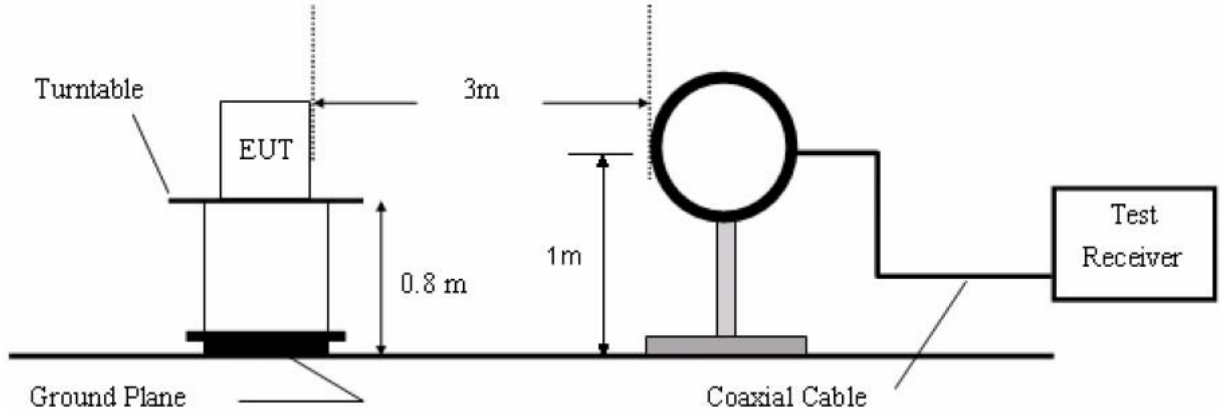

4.7.2.2. 30M to 1G emissions:

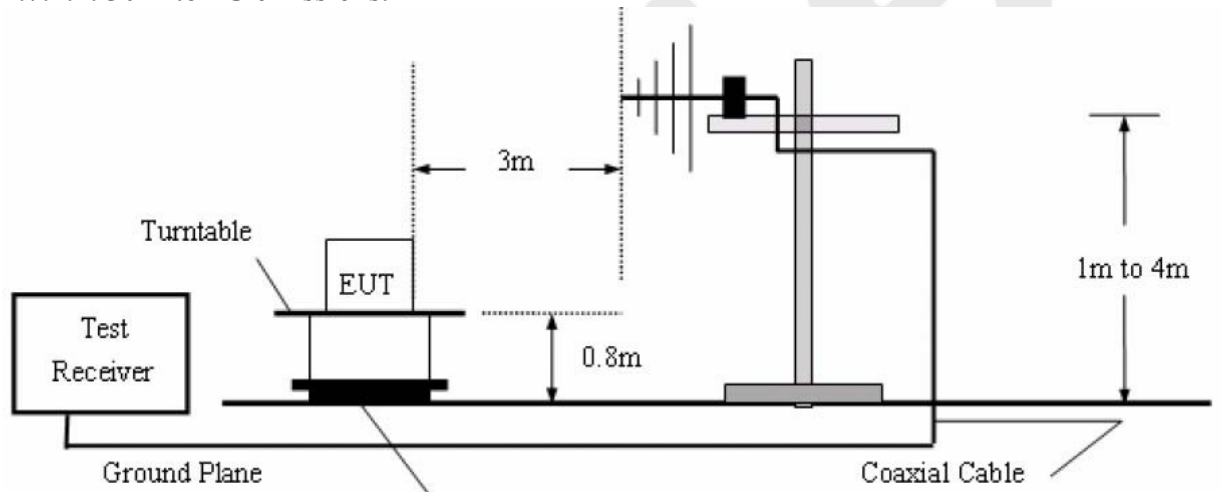

4.7.2.3. 1G to 40G emissions:

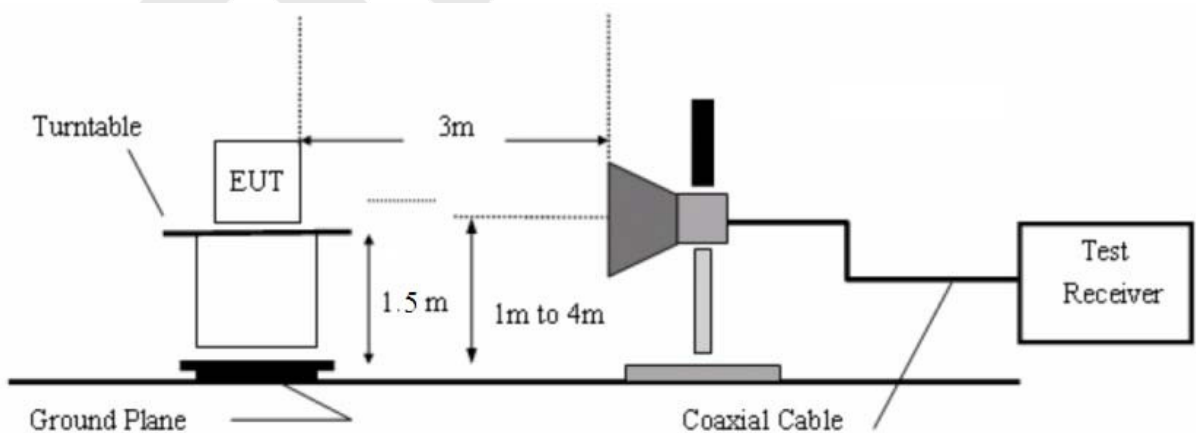

#### 4.7.3. Test Procedure

For below 1GHz: The EUT is placed on a turntable, which is 0.8m above the ground plane.  
For above 1GHz: The EUT is placed on a turntable, which is 1.5m above the ground plane.  
The turn table can rotate 360 degrees to determine the position of the maximum emission level.  
The EUT is set 3 meters away from the receiving antenna which is mounted on a antenna tower.  
The antenna can be moved up and down from 1 to 4 meters to find out the maximum emission level. Both horizontal and vertical polarization of the antenna are set on test.

Measurements are made on 9KHz to 30MHz and 30MHz to 26GHz range with the transmitter set to the lowest, middle, and highest channels.

For 9kHz to 150kHz, Set the spectrum analyzer as:  
RBW = 200Hz, VBW =1kHz, Detector= Quasi-Peak, Trace mode= Max hold, Sweep- auto couple.

For 150kHz to 30MHz, Set the spectrum analyzer as:  
RBW = 9KHz, VBW =30kHz, Detector= Quasi-Peak, Trace mode= Max hold, Sweep- auto couple.

For 30MHz to 1000MHz, Set the spectrum analyzer as:  
RBW = 100kHz, VBW =300kHz, Detector= Quasi-Peak, Trace mode= Max hold, Sweep- auto couple.

For above 1GHz, Set the spectrum analyzer as:  
For Peak Reading measurement:  
RBW =1MHz, VBW =3MHz, Detector= Peak, Trace mode= Max hold, Sweep- auto couple.  
For Average Reading measurement:  
If Duty cycle $\geq$ 98%: RBW =1MHz, VBW =10Hz,  
If Duty cycle<98%: RBW =1MHz, VBW =1/T (T is min transmission duration)

The EUT is tested in 9\*6\*6 Chamber. The device is evaluated in xyz orientation.

The test results are listed in Section 4.7.4.

#### 4.7.4. Test Results

Please refer the following pages. Only the worst case (x orientation).

The test results of 9kHz-30MHz and above 18000MHz are attenuated more than 20dB below the permissible limits, so the results don't record in the report.

Test Results (30~1000MHz)

Job No.:	0217030034W	Polarization:	Horizontal
Standard:	FCC PART15 C	Power Source:	AC 120V, 60Hz for adapter
Test item:	Radiation Test	Temp.(C)/Hum.(%RH):	24.3(C)/55% RH
Test Mode:	WiFi Mode	Distance:	3m

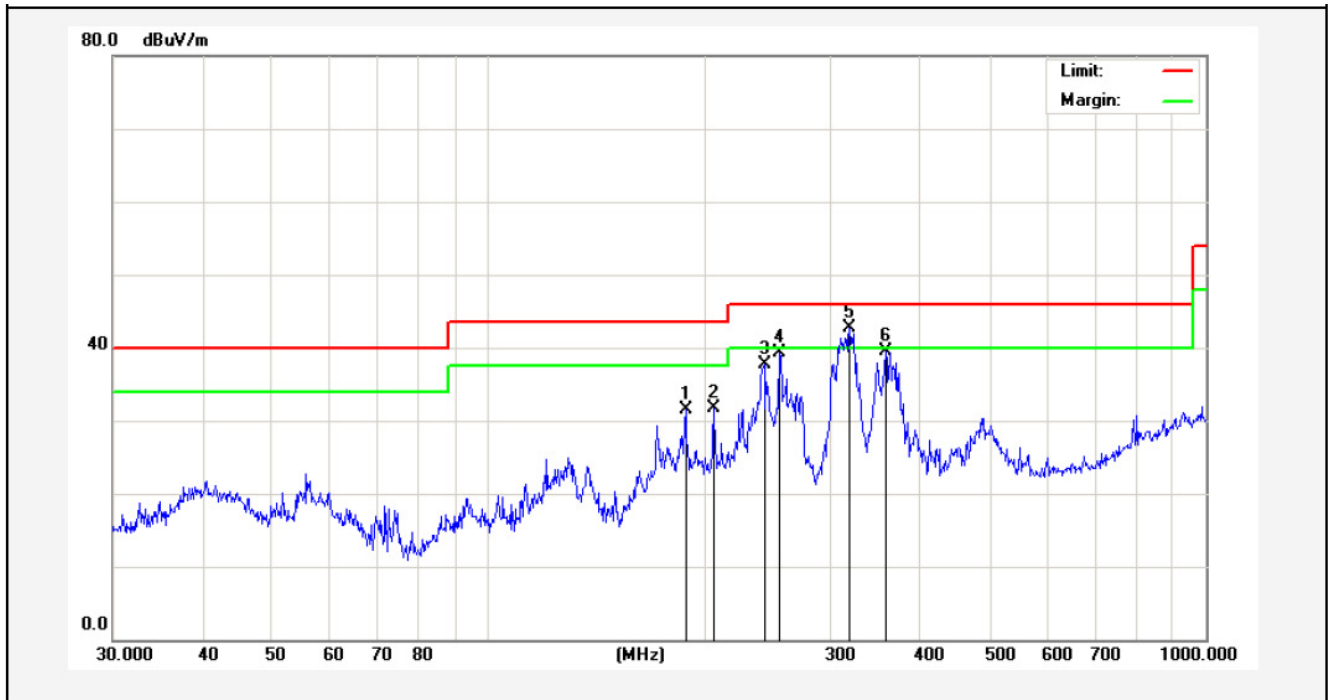

No.	Freq. (MHz)	Reading (dBuV/m)	Factor (dB/m)	Result (dBuV/m)	Limit (dBuV/)	Over Limit (dB)	Detector	Height (cm)	degree (deg)	Remark
1	188.4125	52.65	-21.07	31.58	43.50	-11.92	QP			
2	206.3976	52.34	-20.63	31.71	43.50	-11.79	QP			
3	242.5253	55.84	-18.21	37.63	46.00	-8.37	QP			
4	254.7284	58.14	-18.76	39.38	46.00	-6.62	QP			
5	318.8170	58.16	-15.39	42.77	46.00	-3.23	QP			
6	357.9287	53.23	-13.73	39.50	46.00	-6.50	QP			

Job No.:	0217030034W	Polarization:	Vertical
Standard:	FCC PART15 C	Power Source:	AC 120V, 60Hz for adapter
Test item:	Radiation Test	Temp.(C)/Hum.(%RH):	24.3(C)/55%RH
Test Mode:	WiFi Mode	Distance:	3m

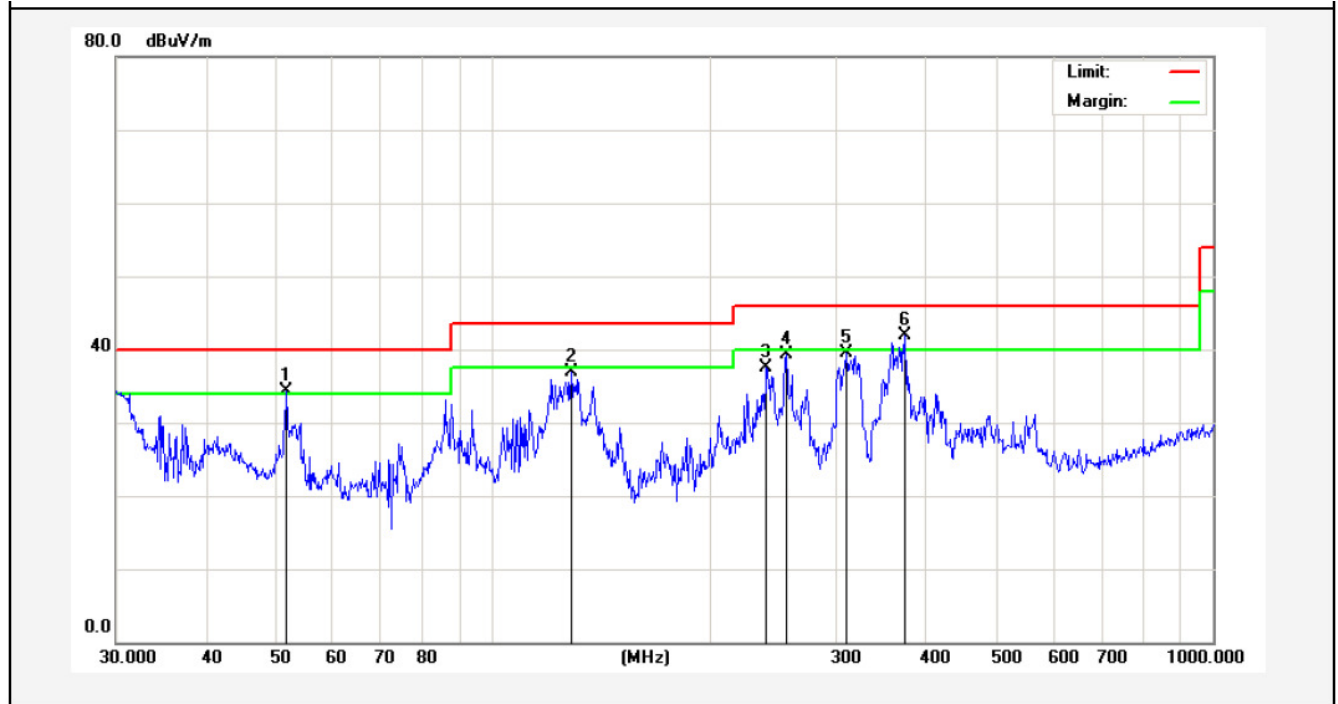

No.	Freq. (MHz)	Reading (dBuV/m)	Factor (dB/m)	Result (dBuV/m)	Limit (dBuV/)	Over Limit (dB)	Detector	Height (cm)	degree (deg)	Remark
1	51.6616	48.95	-14.69	34.26	40.00	-5.74	QP			
2	128.5630	54.52	-17.60	36.92	43.50	-6.58	QP			
3	239.9874	51.51	-14.09	37.42	46.00	-8.58	QP			
4	255.6231	53.36	-14.02	39.34	46.00	-6.66	QP			
5	309.9977	53.95	-14.47	39.48	46.00	-6.52	QP			
6	373.3112	54.22	-12.40	41.82	46.00	-4.18	QP			

**Test Results (Above 1000MHz)**

Test mode:	802.11b	Test channel:	Low CH
------------	---------	---------------	--------

Peak value:

Frequency (MHz)	Read Level (dBuV)	Antenna Factor (dB/m)	Cable Loss (dB)	Preamp Factor (dB)	Level (dBuV/m)	Limit Line (dBuV/m)	Over Limit (dB)	Polarization
4824.00	40.97	34.13	6.61	34.09	47.62	74.00	-26.38	Vertical
7236.00	34.65	37.14	7.74	34.51	45.02	74.00	-28.98	Vertical
9648.00	33.02	39.35	9.26	34.80	46.83	74.00	-27.17	Vertical
12060.00	*					74.00		Vertical
14472.00	*					74.00		Vertical
16884.00	*					74.00		Vertical
4824.00	39.53	34.13	6.61	34.09	46.18	74.00	-27.82	Horizontal
7236.00	34.34	37.14	7.74	34.51	44.71	74.00	-29.29	Horizontal
9648.00	32.57	39.35	9.26	34.80	46.38	74.00	-27.62	Horizontal
12060.00	*					74.00		Horizontal
14472.00	*					74.00		Horizontal
16884.00	*					74.00		Horizontal

Average value:

Frequency (MHz)	Read Level (dBuV)	Antenna Factor (dB/m)	Cable Loss (dB)	Preamp Factor (dB)	Level (dBuV/m)	Limit Line (dBuV/m)	Over Limit (dB)	Polarization
4824.00	30.00	34.13	6.61	34.09	36.65	54.00	-17.35	Vertical
7236.00	23.50	37.14	7.74	34.51	33.87	54.00	-20.13	Vertical
9648.00	23.35	39.35	9.26	34.80	37.16	54.00	-16.84	Vertical
12060.00	*					54.00		Vertical
14472.00	*					54.00		Vertical
16884.00	*					54.00		Vertical
4824.00	29.04	34.13	6.61	34.09	35.69	54.00	-18.31	Horizontal
7236.00	22.91	37.14	7.74	34.51	33.28	54.00	-20.72	Horizontal
9648.00	22.31	39.35	9.26	34.80	36.12	54.00	-17.88	Horizontal
12060.00	*					54.00		Horizontal
14472.00	*					54.00		Horizontal
16884.00	*					54.00		Horizontal

Note:

- 1, Final Level = Receiver Read level + Antenna Factor + Cable Loss – Preamplifier Factor
- 2, “\*”, means this data is the too weak instrument of signal is unable to test.

Test mode:	802.11b	Test channel:	Mid CH
------------	---------	---------------	--------

Peak value:

Frequency (MHz)	Read Level (dBuV)	Antenna Factor (dB/m)	Cable Loss (dB)	Preamp Factor (dB)	Level (dBuV/m)	Limit Line (dBuV/m)	Over Limit (dB)	Polarization
4874.00	39.91	34.35	6.67	34.09	46.84	74.00	-27.16	Vertical
7311.00	34.64	37.21	7.77	34.53	45.09	74.00	-28.91	Vertical
9748.00	33.99	39.45	9.33	34.80	47.97	74.00	-26.03	Vertical
12185.00	*					74.00		Vertical
14622.00	*					74.00		Vertical
17059.00	*					74.00		Vertical
4874.00	40.30	34.35	6.67	34.09	47.23	74.00	-26.77	Horizontal
7311.00	33.24	37.21	7.77	34.53	43.69	74.00	-30.31	Horizontal
9748.00	33.86	39.45	9.33	34.80	47.84	74.00	-26.16	Horizontal
12185.00	*					74.00		Horizontal
14622.00	*					74.00		Horizontal
17059.00	*					74.00		Horizontal

Average value:

Frequency (MHz)	Read Level (dBuV)	Antenna Factor (dB/m)	Cable Loss (dB)	Preamp Factor (dB)	Level (dBuV/m)	Limit Line (dBuV/m)	Over Limit (dB)	Polarization
4874.00	30.72	34.35	6.67	34.09	37.65	54.00	-16.35	Vertical
7311.00	22.95	37.21	7.77	34.53	33.40	54.00	-20.60	Vertical
9748.00	23.23	39.45	9.33	34.80	37.21	54.00	-16.79	Vertical
12185.00	*					54.00		Vertical
14622.00	*					54.00		Vertical
17059.00	*					54.00		Vertical
4874.00	30.38	34.35	6.67	34.09	37.31	54.00	-16.69	Horizontal
7311.00	22.32	37.21	7.77	34.53	32.77	54.00	-21.23	Horizontal
9748.00	23.56	39.45	9.33	34.80	37.54	54.00	-16.46	Horizontal
12185.00	*					54.00		Horizontal
14622.00	*					54.00		Horizontal
17059.00	*					54.00		Horizontal

Note:

- 1, Final Level = Receiver Read level + Antenna Factor + Cable Loss – Pre-amplifier Factor
- 2, “\*”, means this data is the too weak instrument of signal is unable to test.

Test mode:	802.11b	Test channel:	High CH
------------	---------	---------------	---------

Peak value:

Frequency (MHz)	Read Level (dBuV)	Antenna Factor (dB/m)	Cable Loss (dB)	Preamp Factor (dB)	Level (dBuV/m)	Limit Line (dBuV/m)	Over Limit (dB)	Polarization
4924.00	45.84	34.57	6.74	34.09	53.06	74.00	-20.94	Vertical
7386.00	35.57	37.29	7.80	34.55	46.11	74.00	-27.89	Vertical
9848.00	37.46	39.55	9.41	34.81	51.61	74.00	-22.39	Vertical
12310.00	*					74.00		Vertical
14772.00	*					74.00		Vertical
17234.00	*					74.00		Vertical
4924.00	45.00	34.57	6.74	34.09	52.22	74.00	-21.78	Horizontal
7386.00	34.40	37.29	7.80	34.55	44.94	74.00	-29.06	Horizontal
9848.00	33.60	39.55	9.41	34.81	47.75	74.00	-26.25	Horizontal
12310.00	*					74.00		Horizontal
14772.00	*					74.00		Horizontal
17234.00	*					74.00		Horizontal

Average value:

Frequency (MHz)	Read Level (dBuV)	Antenna Factor (dB/m)	Cable Loss (dB)	Preamp Factor (dB)	Level (dBuV/m)	Limit Line (dBuV/m)	Over Limit (dB)	Polarization
4924.00	36.68	34.57	6.74	34.09	43.90	54.00	-10.10	Vertical
7386.00	25.47	37.29	7.80	34.55	36.01	54.00	-17.99	Vertical
9848.00	25.95	39.55	9.41	34.81	40.10	54.00	-13.90	Vertical
12310.00	*					54.00		Vertical
14772.00	*					54.00		Vertical
17234.00	*					54.00		Vertical
4924.00	35.31	34.57	6.74	34.09	42.53	54.00	-11.47	Horizontal
7386.00	23.77	37.29	7.80	34.55	34.31	54.00	-19.69	Horizontal
9848.00	22.85	39.55	9.41	34.81	37.00	54.00	-17.00	Horizontal
12310.00	*					54.00		Horizontal
14772.00	*					54.00		Horizontal
17234.00	*					54.00		Horizontal

Note:

- 1, During the test, pre-scan the 802.11b,g,n(HT20N) mode, and found the 802.11b mode is worse case, , the report only record this mode.
- 2, Final Level =Receiver Read level + Antenna Factor + Cable Loss – Preamplifier Factor
- 3, “\*”, means this data is the too weak instrument of signal is unable to test.

**Radiated band edge:**

Test mode:	802.11b	Test channel:	Low CH
------------	---------	---------------	--------

Peak value:

Frequency (MHz)	Read Level (dBuV)	Antenna Factor (dB/m)	Cable Loss (dB)	Preamp Factor (dB)	Level (dBuV/m)	Limit Line (dBuV/m)	Over Limit (dB)	Polarization
2390.00	52.28	29.15	3.41	34.01	50.83	74.00	-23.17	Horizontal
2400.00	61.51	29.16	3.43	34.01	60.09	74.00	-13.91	Horizontal
2390.00	54.01	29.15	3.41	34.01	52.56	74.00	-21.44	Vertical
2400.00	63.48	29.16	3.43	34.01	62.06	74.00	-11.94	Vertical

Average value:

Frequency (MHz)	Read Level (dBuV)	Antenna Factor (dB/m)	Cable Loss (dB)	Preamp Factor (dB)	Level (dBuV/m)	Limit Line (dBuV/m)	Over Limit (dB)	Polarization
2390.00	38.86	29.15	3.41	34.01	37.41	54.00	-16.59	Horizontal
2400.00	47.23	29.16	3.43	34.01	45.81	54.00	-8.19	Horizontal
2390.00	40.73	29.15	3.41	34.01	39.28	54.00	-14.72	Vertical
2400.00	48.40	29.16	3.43	34.01	46.98	54.00	-7.02	Vertical

Test mode:	802.11b	Test channel:	High CH
------------	---------	---------------	---------

Peak value:

Frequency (MHz)	Read Level (dBuV)	Antenna Factor (dB/m)	Cable Loss (dB)	Preamp Factor (dB)	Level (dBuV/m)	Limit Line (dBuV/m)	Over Limit (dB)	Polarization
2483.50	53.22	29.28	3.53	34.03	52.00	74.00	-22.00	Horizontal
2500.00	48.84	29.30	3.56	34.03	47.67	74.00	-26.33	Horizontal
2483.50	55.60	29.28	3.53	34.03	54.38	74.00	-19.62	Vertical
2500.00	51.47	29.30	3.56	34.03	50.30	74.00	-23.70	Vertical

Average value:

Frequency (MHz)	Read Level (dBuV)	Antenna Factor (dB/m)	Cable Loss (dB)	Preamp Factor (dB)	Level (dBuV/m)	Limit Line (dBuV/m)	Over Limit (dB)	Polarization
2483.50	39.32	29.28	3.53	34.03	38.10	54.00	-15.90	Horizontal
2500.00	35.31	29.30	3.56	34.03	34.14	54.00	-19.86	Horizontal
2483.50	41.33	29.28	3.53	34.03	40.11	54.00	-13.89	Vertical
2500.00	37.21	29.30	3.56	34.03	36.04	54.00	-17.96	Vertical

Test mode:	802.11g	Test channel:	Low CH
------------	---------	---------------	--------

Peak value:

Frequency (MHz)	Read Level (dBuV)	Antenna Factor (dB/m)	Cable Loss (dB)	Preamp Factor (dB)	Level (dBuV/m)	Limit Line (dBuV/m)	Over Limit (dB)	Polarization
2390.00	51.05	29.15	3.41	34.01	49.60	74.00	-24.40	Horizontal
2400.00	59.86	29.16	3.43	34.01	58.44	74.00	-15.56	Horizontal
2390.00	52.69	29.15	3.41	34.01	51.24	74.00	-22.76	Vertical
2400.00	61.49	29.16	3.43	34.01	60.07	74.00	-13.93	Vertical

Average value:

Frequency (MHz)	Read Level (dBuV)	Antenna Factor (dB/m)	Cable Loss (dB)	Preamp Factor (dB)	Level (dBuV/m)	Limit Line (dBuV/m)	Over Limit (dB)	Polarization
2390.00	37.98	29.15	3.41	34.01	36.53	54.00	-17.47	Horizontal
2400.00	46.21	29.16	3.43	34.01	44.79	54.00	-9.21	Horizontal
2390.00	39.75	29.15	3.41	34.01	38.30	54.00	-15.70	Vertical
2400.00	47.29	29.16	3.43	34.01	45.87	54.00	-8.13	Vertical

Test mode:	802.11g	Test channel:	High CH
------------	---------	---------------	---------

Peak value:

Frequency (MHz)	Read Level (dBuV)	Antenna Factor (dB/m)	Cable Loss (dB)	Preamp Factor (dB)	Level (dBuV/m)	Limit Line (dBuV/m)	Over Limit (dB)	Polarization
2483.50	51.45	29.28	3.53	34.03	50.23	74.00	-23.77	Horizontal
2500.00	47.47	29.30	3.56	34.03	46.30	74.00	-27.70	Horizontal
2483.50	53.58	29.28	3.53	34.03	52.36	74.00	-21.64	Vertical
2500.00	49.86	29.30	3.56	34.03	48.69	74.00	-25.31	Vertical

Average value:

Frequency (MHz)	Read Level (dBuV)	Antenna Factor (dB/m)	Cable Loss (dB)	Preamp Factor (dB)	Level (dBuV/m)	Limit Line (dBuV/m)	Over Limit (dB)	Polarization
2483.50	38.26	29.28	3.53	34.03	37.04	54.00	-16.96	Horizontal
2500.00	34.47	29.30	3.56	34.03	33.30	54.00	-20.70	Horizontal
2483.50	40.15	29.28	3.53	34.03	38.93	54.00	-15.07	Vertical
2500.00	36.33	29.30	3.56	34.03	35.16	54.00	-18.84	Vertical

Test mode:	802.11n (HT20)	Test channel:	Low CH
------------	----------------	---------------	--------

Peak value:

Frequency (MHz)	Read Level (dBuV)	Antenna Factor (dB/m)	Cable Loss (dB)	Preamp Factor (dB)	Level (dBuV/m)	Limit Line (dBuV/m)	Over Limit (dB)	Polarization
2390.00	50.96	29.15	3.41	34.01	49.51	74.00	-24.49	Horizontal
2400.00	59.74	29.16	3.43	34.01	58.32	74.00	-15.68	Horizontal
2390.00	52.59	29.15	3.41	34.01	51.14	74.00	-22.86	Vertical
2400.00	61.35	29.16	3.43	34.01	59.93	74.00	-14.07	Vertical

Average value:

Frequency (MHz)	Read Level (dBuV)	Antenna Factor (dB/m)	Cable Loss (dB)	Preamp Factor (dB)	Level (dBuV/m)	Limit Line (dBuV/m)	Over Limit (dB)	Polarization
2390.00	37.92	29.15	3.41	34.01	36.47	54.00	-17.53	Horizontal
2400.00	46.14	29.16	3.43	34.01	44.72	54.00	-9.28	Horizontal
2390.00	39.68	29.15	3.41	34.01	38.23	54.00	-15.77	Vertical
2400.00	47.21	29.16	3.43	34.01	45.79	54.00	-8.21	Vertical

Test mode:	802.11n (HT20)	Test channel:	High CH
------------	----------------	---------------	---------

Peak value:

Frequency (MHz)	Read Level (dBuV)	Antenna Factor (dB/m)	Cable Loss (dB)	Preamp Factor (dB)	Level (dBuV/m)	Limit Line (dBuV/m)	Over Limit (dB)	Polarization
2483.50	51.32	29.28	3.53	34.03	50.10	74.00	-23.90	Horizontal
2500.00	47.37	29.30	3.56	34.03	46.20	74.00	-27.80	Horizontal
2483.50	53.44	29.28	3.53	34.03	52.22	74.00	-21.78	Vertical
2500.00	49.75	29.30	3.56	34.03	48.58	74.00	-25.42	Vertical

Average value:

Frequency (MHz)	Read Level (dBuV)	Antenna Factor (dB/m)	Cable Loss (dB)	Preamp Factor (dB)	Level (dBuV/m)	Limit Line (dBuV/m)	Over Limit (dB)	Polarization
2483.50	38.18	29.28	3.53	34.03	36.96	54.00	-17.04	Horizontal
2500.00	34.41	29.30	3.56	34.03	33.24	54.00	-20.76	Horizontal
2483.50	40.07	29.28	3.53	34.03	38.85	54.00	-15.15	Vertical
2500.00	36.27	29.30	3.56	34.03	35.10	54.00	-18.90	Vertical

## 5. ANTENNA APPLICATION

### 5.1. Antenna requirement

The EUT'S antenna is met the requirement of FCC part 15C section 15.203.

An intentional radiator shall be designed to ensure that no antenna other than that furnished by the responsible party shall be used with the device. The use of a permanently attached antenna or of an antenna that uses a unique coupling to the intentional radiator shall be considered sufficient to comply with the provisions of this section. The manufacturer may design the unit so that a broken antenna can be replaced by the user, but the use of a standard antenna jack or electrical connector is prohibited. This requirement does not apply to carrier current devices or to devices operated under the provisions of §15.211, §15.213, §15.217, §15.219, or §15.221. Further, this requirement does not apply to intentional radiators that must be professionally installed, such as perimeter protection systems and some field disturbance sensors, or to other intentional radiators which, in accordance with §15.31(d), must be measured at the installation site. However, the installer shall be responsible for ensuring that the proper antenna is employed so that the limits in this part are not exceeded.

### 5.2. Result

The EUT's antenna used a rod antenna which is permanently attached, The antenna's gain is 0dBi and meets the requirement.

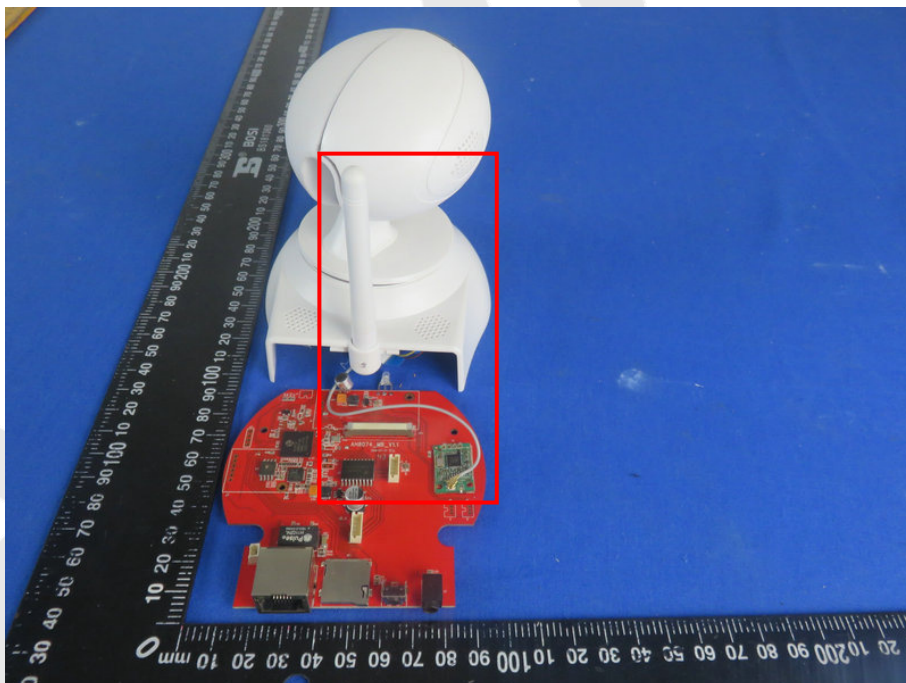

## 6. PHOTOGRAPH

### 6.1. Photo of Conducted Emission Measurement



### 6.2. Photo of Radiation Emission Test

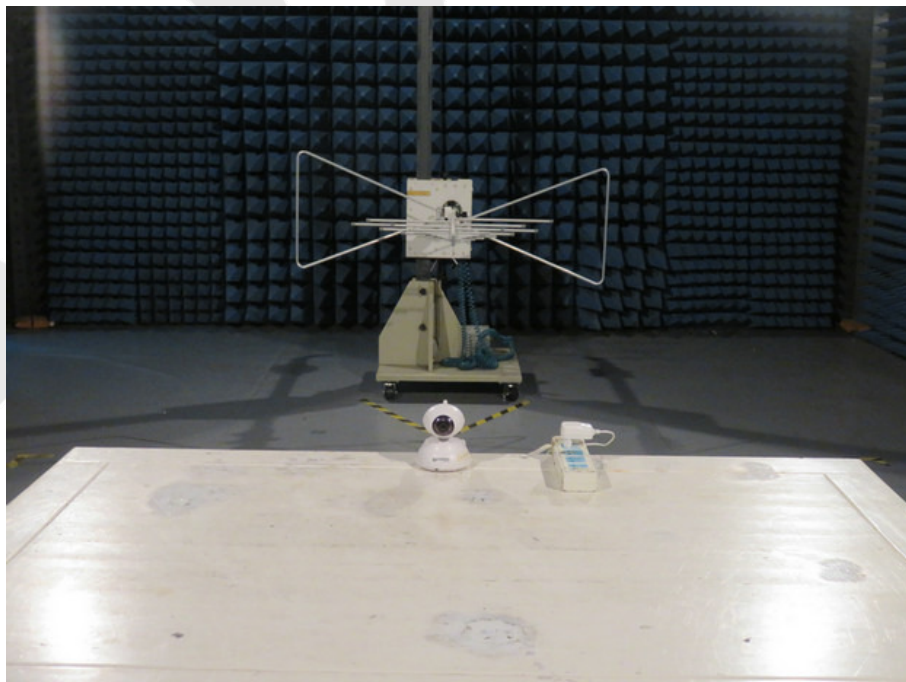

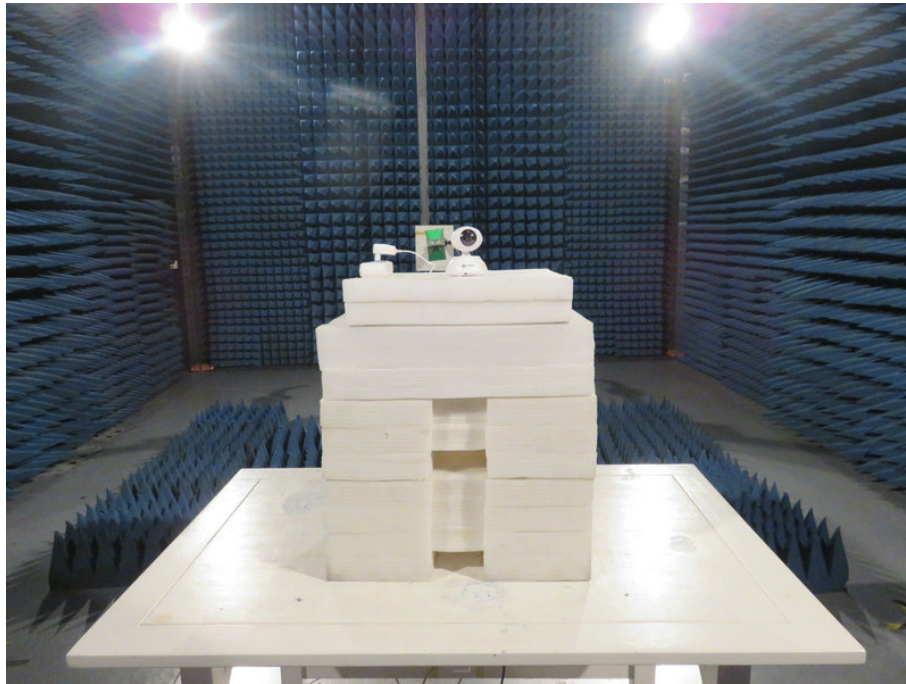

Anbotek

## APPENDIX II (EXTERNAL PHOTOS)

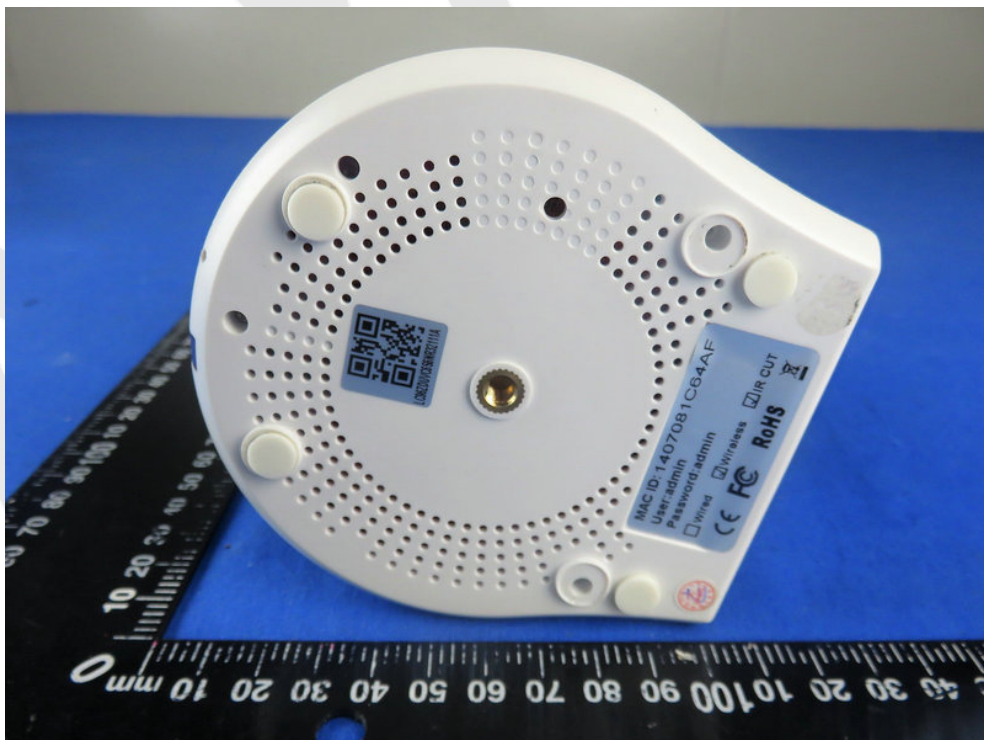
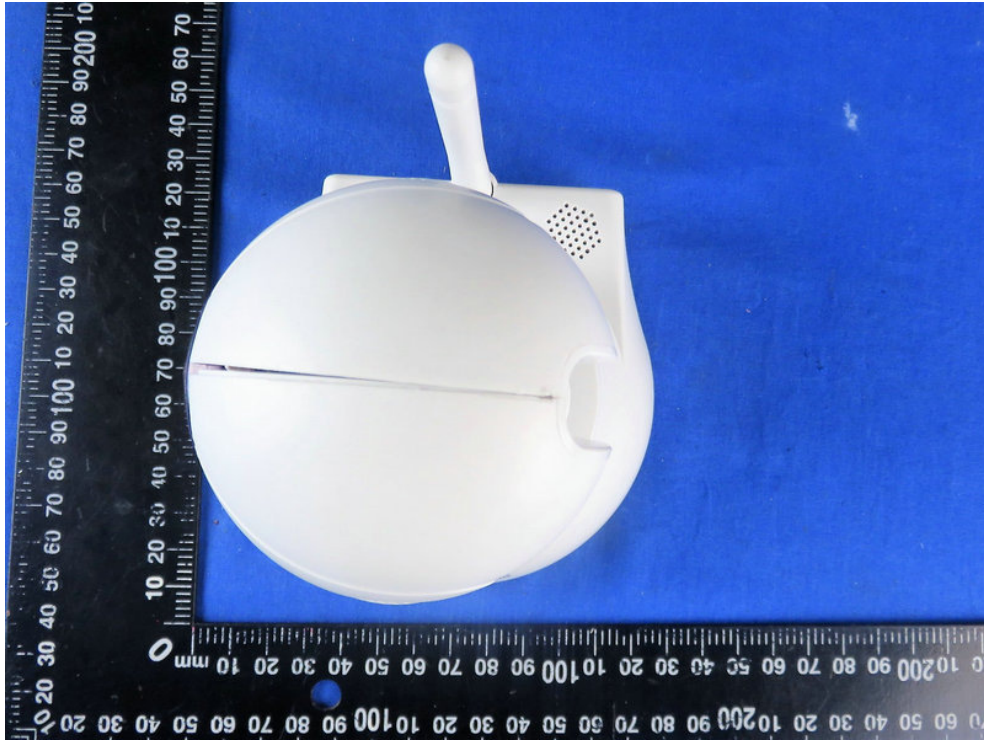



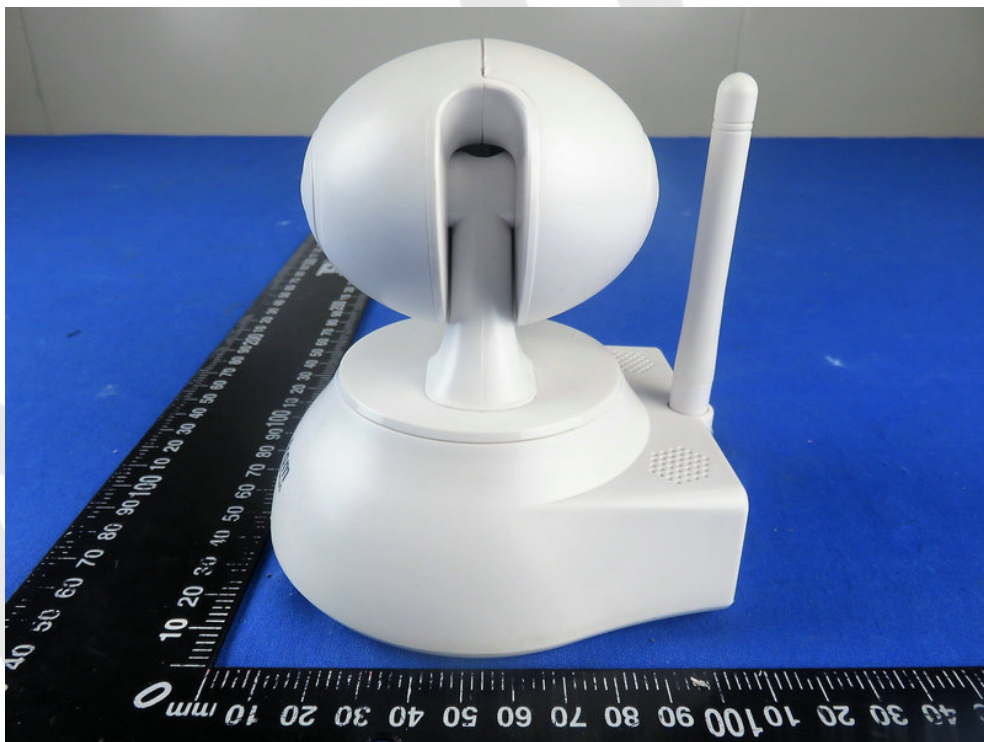
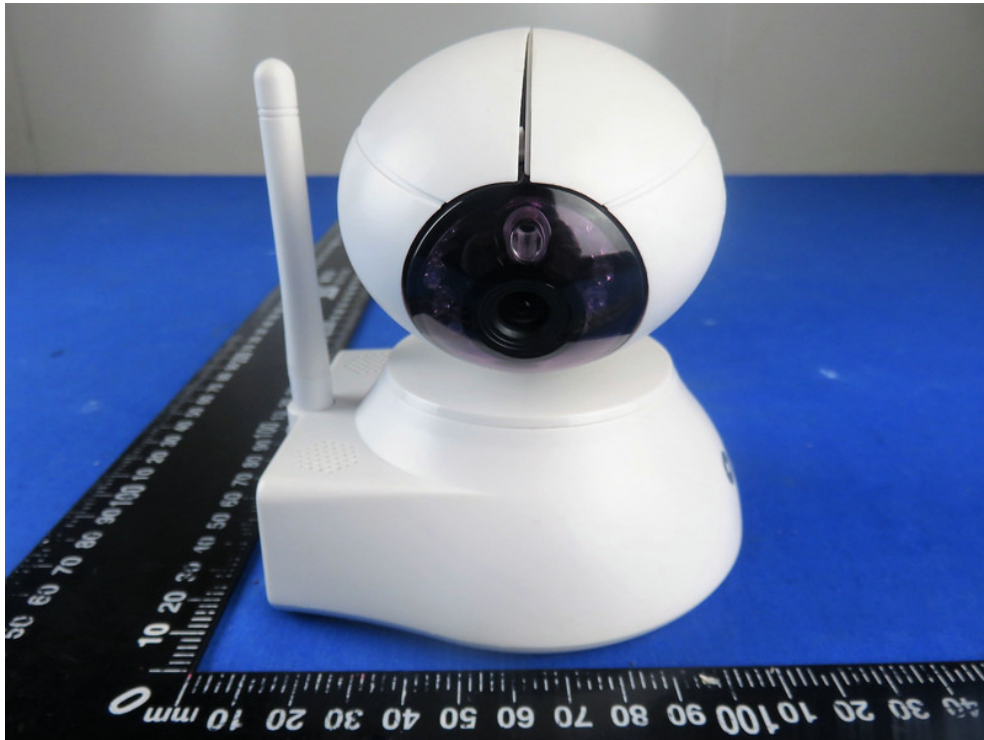

### APPENDIX III(INTERNAL PHOTOS)

