



MEASUREMENT REPORT

FCC PART 15C & RSS-247 Issue 2

FCC ID: 2ALS8-NB5213
IC: 22636-NB5213
APPLICANT: Ninebot (Changzhou) Tech Co., Ltd.
Application Type: Certification
Product: Segway miniPLUS
Model No.: N4M350
Brand Name: SEGWAY
FCC Classification: Digital Transmission System (DTS)
FCC Rule Part(s): Part 15.247
IC Rule(s): RSS-247 Issue 2
Test Procedure(s): ANSI C63.10-2013, KDB 558074 D01v04
Test Date: August 02 ~ 09, 2017

Reviewed By : 
(Sunny Sun)

Approved By : 
(Marlin Chen)



The test results relate only to the samples tested.

This equipment has been shown to be capable of compliance with the applicable technical standards as indicated in the measurement report and was tested in accordance with the measurement procedures specified in KDB 558074 D01v04. Test results reported herein relate only to the item(s) tested.

The test report shall not be reproduced except in full without the written approval of MRT Technology (Suzhou) Co., Ltd.

Revision History

Report No.	Version	Description	Issue Date	Note
1708RSU01402	Rev. 01	Initial Report	08-11-2017	Valid

CONTENTS

Description	Page
1. INTRODUCTION	6
1.1. Scope	6
1.2. MRT Test Location	6
2. PRODUCT INFORMATION	7
2.1. Feature of Equipment under Test	7
2.2. Product Specification Subjective to this Report.....	7
2.3. Working Frequencies.....	7
2.4. Device Capabilities	8
2.5. Test Configuration	8
2.6. EMI Suppression Device(s)/Modifications.....	8
2.7. Labeling Requirements.....	8
2.8. Test Software	8
3. DESCRIPTION OF TEST	9
3.1. Evaluation Procedure	9
3.2. AC Line Conducted Emissions	9
3.3. Radiated Emissions	10
4. ANTENNA REQUIREMENTS	11
5. TEST EQUIPMENT CALIBRATION DATE	12
6. MEASUREMENT UNCERTAINTY	13
7. TEST RESULT	14
7.1. Summary	14
7.2. 6dB Bandwidth Measurement.....	15
7.2.1. Test Limit	15
7.2.2. Test Procedure used.....	15
7.2.3. Test Setting.....	15
7.2.4. Test Setup.....	15
7.2.5. Test Result.....	16
7.3. Output Power Measurement.....	17
7.3.1. Test Limit	17
7.3.2. Test Procedure Used	17
7.3.3. Test Setting.....	17
7.3.4. Test Setup.....	17
7.3.5. Test Result of Output Power	18

7.4.	Power Spectral Density Measurement	19
7.4.1.	Test Limit	19
7.4.2.	Test Procedure Used	19
7.4.3.	Test Setting	19
7.4.4.	Test Setup.....	19
7.4.5.	Test Result.....	20
7.5.	Conducted Band Edge and Out-of-Band Emissions.....	21
7.5.1.	Test Limit	21
7.5.2.	Test Procedure Used	21
7.5.3.	Test Setting.....	21
7.5.4.	Test Setup.....	22
7.5.5.	Test Result.....	23
7.6.	Radiated Spurious Emission Measurement	25
7.6.1.	Test Limit	25
7.6.2.	Test Procedure Used	25
7.6.3.	Test Setting.....	25
7.6.4.	Test Setup.....	27
7.6.5.	Test Result.....	29
7.7.	Radiated Restricted Band Edge Measurement	34
7.7.1.	Test Result.....	34
7.8.	AC Conducted Emissions Measurement.....	42
7.8.1.	Test Limit	42
7.8.2.	Test Setup.....	42
7.8.3.	Test Result.....	43
8.	CONCLUSION.....	45

§2.1033 General Information

Applicant:	Ninebot (Changzhou) Tech Co., Ltd.
Applicant Address:	16F-17F, Block A, Building 3, Changwu Mid Road 18#, Wujin Dist., Changzhou, Jiangsu, China.
Manufacturer:	Ninebot (Changzhou) Tech Co., Ltd.
Manufacturer Address:	16F-17F, Block A, Building 3, Changwu Mid Road 18#, Wujin Dist., Changzhou, Jiangsu, China.
Test Site:	MRT Technology (Suzhou) Co., Ltd
Test Site Address:	D8 Building, Youxin Industrial Park, No.2 Tian'edang Rd., Wuzhong Economic Development Zone, Suzhou, China
MRT Registration No.:	893164
FCC Rule Part(s):	Part 15.247
Model No.:	N4M350
FCC ID:	2ALS8-NB5213
IC:	22636-NB5213
Test Device Serial No.:	N/A <input type="checkbox"/> Production <input checked="" type="checkbox"/> Pre-Production <input type="checkbox"/> Engineering
FCC Classification:	Digital Transmission System (DTS)

Test Facility / Accreditations

Measurements were performed at MRT Laboratory located in Tian'edang Rd., Suzhou, China.

- MRT facility is a FCC registered (MRT Reg. No. 893164) test facility with the site description report on file and has met all the requirements specified in Section 2.948 of the FCC Rules.
- MRT facility is an IC registered (MRT Reg. No. 11384A-1) test laboratory with the site description on file at Industry Canada.
- MRT facility is a VCCI registered (R-4179, G-814, C-4664, T-2206) test laboratory with the site description on file at VCCI Council.
- MRT Lab is accredited to ISO 17025 by the American Association for Laboratory Accreditation (A2LA) under the American Association for Laboratory Accreditation Program (A2LA Cert. No. 3628.01) in EMC, Telecommunications and Radio testing for FCC, Industry Canada, EU and TELEC Rules.



1. INTRODUCTION

1.1. Scope

Measurement and determination of electromagnetic emissions (EMC) of radio frequency devices including intentional and/or unintentional radiators for compliance with the technical rules and regulations of the Federal Communications Commission and the Industry Canada Certification and Engineering Bureau.

1.2. MRT Test Location

The map below shows the location of the MRT LABORATORY, its proximity to the Taihu Lake. These measurement tests were conducted at the MRT Technology (Suzhou) Co., Ltd. Facility located at D8 Building, Youxin Industrial Park, No.2 Tian'edang Rd., Wuzhong Economic Development Zone, Suzhou, China. The detailed description of the measurement facility was found to be in compliance with the requirements of § 2.948 according to ANSI C63.4-2009 on September 30, 2013.



2. PRODUCT INFORMATION

2.1. Feature of Equipment under Test

Product Name:	Segway miniPLUS
Model No.:	N4M350
Brand Name:	SEGWAY
RF Function:	Bluetooth v4.1 (BLE Only), UWB

2.2. Product Specification Subjective to this Report

Bluetooth Frequency	2402~2480MHz
Bluetooth Version	v4.1 (BLE Only)
Data Rate	1Mbps(GFSK)
Antenna Gain	5.0dBi

Note: For other features of this EUT, test report will be issued separately.

2.3. Working Frequencies

Channel List for BLE

Channel	Frequency	Channel	Frequency	Channel	Frequency
00	2402 MHz	01	2404 MHz	02	2406 MHz
03	2408 MHz	04	2410 MHz	05	2412 MHz
06	2414 MHz	07	2416 MHz	08	2418 MHz
09	2420 MHz	10	2422 MHz	11	2424 MHz
12	2426 MHz	13	2428 MHz	14	2430 MHz
15	2432 MHz	16	2434 MHz	17	2436 MHz
18	2438 MHz	19	2440 MHz	20	2442 MHz
21	2444 MHz	22	2446 MHz	23	2448 MHz
24	2450 MHz	25	2452 MHz	26	2454 MHz
27	2456 MHz	28	2458 MHz	29	2460 MHz
30	2462 MHz	31	2464 MHz	32	2466 MHz
33	2468 MHz	34	2470 MHz	35	2472 MHz
36	2474 MHz	37	2476 MHz	38	2478 MHz
39	2480 MHz	--	--	--	--

2.4. Device Capabilities

This device contains the following capabilities:

UWB & Bluetooth Device.

2.5. Test Configuration

The **Segway miniPLUS** was tested per the guidance of KDB 558074 D01v04. ANSI C63.10-2013 was used to reference the appropriate EUT setup for radiated spurious emissions testing and AC line conducted testing.

2.6. EMI Suppression Device(s)/Modifications

No EMI suppression device(s) were added and/or no modifications were made during testing.

2.7. Labeling Requirements

Per 2.1074 & 15.19; Docket 95-19

The label shall be permanently affixed at a conspicuous location on the device; instruction manual or pamphlet supplied to the user and be readily visible to the purchaser at the time of purchase.

However, when the device is so small wherein placement of the label with specified statement is not practical, only the FCC ID must be displayed on the device per Section 15.19(a)(5). Please see attachment for FCC ID label and label location.

2.8. Test Software

The test utility software used during testing was “nRFgo Studio”.

3. DESCRIPTION OF TEST

3.1. Evaluation Procedure

The measurement procedures described in the American National Standard for Testing Unlicensed Wireless Devices (ANSI C63.10-2013), and the guidance provided in KDB 558074 D01v04 were used in the measurement of the **Segway miniPLUS**.

Deviation from measurement procedure.....None

3.2. AC Line Conducted Emissions

The line-conducted facility is located inside an 8'x4'x4' shielded enclosure. A 1m x 2m wooden table 80cm high is placed 40cm away from the vertical wall and 80cm away from the sidewall of the shielded room. Two 10kHz-30MHz, 50Ω/50uH Line-Impedance Stabilization Networks (LISNs) are bonded to the shielded room floor. Power to the LISNs is filtered by external high-current high-insertion loss power line filters. These filters attenuate ambient signal noise from entering the measurement lines. These filters are also bonded to the shielded enclosure.

The EUT is powered from one LISN and the support equipment is powered from the second LISN. All interconnecting cables more than 1 meter were shortened to a 1 meter length by non-inductive bundling (serpentine fashion) and draped over the back edge of the test table. All cables were at least 40cm above the horizontal reference ground-plane. Power cables for support equipment were routed down to the second LISN while ensuring that that cables were not draped over the second LISN.

Sufficient time for the EUT, support equipment, and test equipment was allowed in order for them to warm up to their normal operating condition. The RF output of the LISN was connected to the receiver and exploratory measurements were made to determine the frequencies producing the maximum emission from the EUT. The receiver was scanned from 150kHz to 30MHz. The detector function was set to peak mode for exploratory measurements while the bandwidth of the analyzer was set to 9kHz. The EUT, support equipment, and interconnecting cables were arranged and manipulated to maximize each emission. Each emission was also maximized by varying: power lines, the mode of operation or data exchange speed, or support equipment whichever determined the worst-case emission. Once the worst case emissions have been identified, the one EUT cable configuration/arrangement and mode of operation that produced these emissions were used for final measurements on the same test site. The analyzer is set to CISPR quasi-peak and average detectors with a 9kHz resolution bandwidth for final measurements.

An extension cord was used to connect to a single LISN which powered by EUT. The extension cord was calibrated with LISN, the impedance and insertion loss are compliance with the requirements as stated in ANSI C63.10-2013.

Line conducted emissions test results are shown in Section 7.8.

3.3. Radiated Emissions

The radiated test facilities consisted of an indoor 3 meter semi-anechoic chamber used for final measurements and exploratory measurements, when necessary. The measurement area is contained within the semi-anechoic chamber which is shielded from any ambient interference. For measurements above 1GHz absorbers are arranged on the floor between the turn table and the Antenna mast in such a way so as to maximize the reduction of reflections. For measurements below 1GHz, the absorbers are removed. A MF Model 210SS turntable is used for radiated measurement. It is a continuously rotatable, remote controlled, metallic turntable and 2 meters (6.56 ft.) in diameter. The turn table is flush with the raised floor of the chamber in order to maintain its function as a ground plane. An 80cm high PVC support structure is placed on top of the turntable. For all measurements, the spectrum was scanned through all EUT azimuths and from 1 to 4 meter receive Antenna height using a broadband Antenna from 30MHz up to the upper frequency shown in 15.33(b)(1) depending on the highest frequency generated or used in the device or on which the device operates or tunes. For frequencies above 1GHz, linearly polarized double ridge horn Antennas were used. For frequencies below 30MHz, a calibrated loop Antenna was used. When exploratory measurements were necessary, they were performed at 1 meter test distance inside the semi-anechoic chamber using broadband Antennas, broadband amplifiers, and spectrum analyzers to determine the frequencies and modes producing the maximum emissions. Sufficient time for the EUT, support equipment, and test equipment was allowed in order for them to warm up to their normal operating condition. The test set-up for frequencies below 1GHz was placed on top of the 0.8 meter high, 1 x 1.5 meter table; and test set-up for frequencies 1-40GHz was placed on top of the 1.5 meter high, 1 x 1.5 meter table. The EUT, support equipment, and interconnecting cables were arranged and manipulated to maximize each emission. Appropriate precaution was taken to ensure that all emissions from the EUT were maximized and investigated. The system configuration, clock speed, mode of operation or video resolution, if applicable, turntable azimuth, and receive Antenna height was noted for each frequency found.

Final measurements were made in the semi-anechoic chamber using calibrated, linearly polarized broadband and horn Antennas. The test setup was configured to the setup that produced the worst case emissions. The spectrum analyzer was set to investigate all frequencies required for testing to compare the highest radiated disturbances with respect to the specified limits. The turntable containing the EUT was rotated through 360 degrees and the height of the receive Antenna was varied 1 to 4 meters and stopped at the azimuth and height producing the maximum emission. Each emission was maximized by changing the orientation of the EUT through three orthogonal planes and changing the polarity of the receive Antenna, whichever produced the worst-case emissions. According to 3dB Beam-Width of horn Antenna, the horn Antenna should be always directed to the EUT when rising height.

4. ANTENNA REQUIREMENTS

Excerpt from §15.203 of the FCC Rules/Regulations:

“An intentional radiator antenna shall be designed to ensure that no antenna other than that furnished by the responsible party can be used with the device. The use of a permanently attached antenna or of an antenna that uses a unique coupling to the intentional radiator shall be considered sufficient to comply with the provisions of this section.”

- The antenna of the **Segway miniPLUS** is **permanently attached**.
- There are no provisions for connection to an external antenna.

Conclusion:

The **Segway miniPLUS** unit complies with the requirement of §15.203.

5. TEST EQUIPMENT CALIBRATION DATE

Conducted Emissions - SR2

Instrument	Manufacturer	Type No.	Asset No.	Cali. Interval	Cali. Due Date
EMI Test Receiver	R&S	ESR7	MRTSUE06001	1 year	2018/04/24
Two-Line V-Network	R&S	ENV216	MRTSUE06002	1 year	2018/06/20
Two-Line V-Network	R&S	ENV216	MRTSUE06003	1 year	2018/06/20
Temperature/Humidity Meter	Yuhuaze	HTC-2	MRTSUE06181	1 year	2017/12/20
Shielding Anechoic Chamber	Mikebang	Chamber-SR2	MRTSUE06214	1 year	2018/05/10

Radiated Disturbance - AC1

Instrument	Manufacturer	Type No.	Asset No.	Cali. Interval	Cali. Due Date
MXE EMI Receiver	Agilent	N9038A	MRTSUE06125	1 year	2018/08/03
Microwave System Amplifier	Agilent	83017A	MRTSUE06076	1 year	2018/03/28
Loop Antenna	Schwarzbeck	FMZB1519	MRTSUE06025	1 year	2017/11/21
Bilog Period Antenna	Schwarzbeck	VULB 9168	MRTSUE06172	1 year	2017/11/19
Horn Antenna	Schwarzbeck	BBHA9120D	MRTSUE06023	1 year	2017/10/22
Broadband Horn Antenna	Schwarzbeck	BBHA9170	MRTSUE06024	1 year	2018/01/04
Temperature/Humidity Meter	Yuhuaze	HTC-2	MRTSUE06183	1 year	2017/12/20
Anechoic Chamber	TDK	Chamber-AC1	MRTSUE06212	1 year	2018/05/10

Conducted Test Equipment - TR3

Instrument	Manufacturer	Type No.	Asset No.	Cali. Interval	Cali. Due Date
MXE EMI Receiver	Agilent	N9038A	MRTSUE06125	1 year	2018/08/03
Power Meter	Agilent	U2021XA	MRTSUE06030	1 year	2017/12/06
Temperature/Humidity Meter	Yuhuaze	HTC-2	MRTSUE06180	1 year	2017/12/22

Software	Version	Function
e3	V8.3.5	EMI Test Software

6. MEASUREMENT UNCERTAINTY

Where relevant, the following test uncertainty levels have been estimated for tests performed on the EUT as specified in CISPR 16-4-2. This uncertainty represents an expanded uncertainty expressed at approximately the 95% confidence level using a coverage factor of $k = 2$.

AC Conducted Emission Measurement - SR2
Measuring Uncertainty for a Level of Confidence of 95% ($U=2Uc(y)$): 150kHz~30MHz: 3.46dB
Radiated Emission Measurement - AC2
Measuring Uncertainty for a Level of Confidence of 95% ($U=2Uc(y)$): 9kHz ~ 1GHz: ± 4.18 dB 1GHz ~ 25GHz: ± 4.76 dB

7. TEST RESULT

7.1. Summary

Company Name: Ninebot (Beijing) Tech Co., Ltd.
FCC ID: 2ALS8-NB5213
IC: 22636-NB5213
FCC Classification: Digital Transmission System (DTS)
Data Rate(s) Tested: 1Mbps(GFSK) (BLE)

FCC Section(s)	IC Section(s)	Test Description	Test Limit	Test Condition	Test Result	Reference
15.247(a)(2)	RSS-247 [5.2]	6dB Bandwidth	$\geq 500\text{kHz}$	Conducted	Pass	Section 7.2
15.247(b)(3)	RSS-247 [5.4(4)]	Output Power	$\leq 30\text{dBm}$		Pass	Section 7.3
15.247(e)	RSS-247 [5.2]	Power Spectral Density	$\leq 8\text{dBm}/3\text{kHz}$		Pass	Section 7.4
15.247(d)	RSS-247 [5.5]	Band Edge / Out-of-Band Emissions	$\geq 30\text{dBc(Average)}$		Pass	Section 7.5
15.205 15.209	RSS-247 [5.5]	General Field Strength Limits (Restricted Bands and Radiated Emission Limits)	Emissions in restricted bands must meet the radiated limits detailed in 15.209	Radiated	Pass	Section 7.6 & 7.7
15.207	RSS-Gen [8.8]	AC Conducted Emissions 150kHz - 30MHz	< FCC 15.207 limits	Line Conducted	Pass	Section 7.8

Notes: The analyzer plots shown in this section were all taken with a correction table loaded into the analyzer. The correction table was used to account for the losses of the cables and attenuators used as part of the system to connect the EUT to the analyzer at all frequencies of interest.

7.2. 6dB Bandwidth Measurement

7.2.1. Test Limit

The minimum 6dB bandwidth shall be at least 500 kHz.

7.2.2. Test Procedure used

KDB 558074 D01v04 - Section 8.2 Option 2

7.2.3. Test Setting

1. The Spectrum's automatic bandwidth measurement capability was used to perform the 6dB bandwidth measurement. The "X" dB bandwidth parameter was set to $X = 6$. The bandwidth measurement was not influenced by any intermediate power nulls in the fundamental emission.
2. Set RBW = 100 kHz
3. VBW $\geq 3 \times$ RBW
4. Detector = Peak
5. Trace mode = max hold
6. Sweep = auto couple
7. Allow the trace was allowed to stabilize

7.2.4. Test Setup

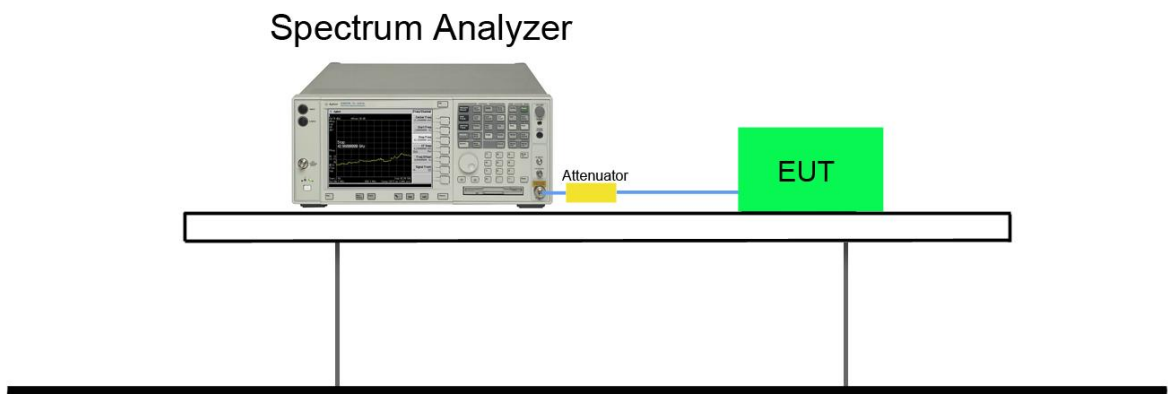

7.2.5. Test Result

Test Mode	Data Rate (Mbps)	Channel No.	Frequency (MHz)	6dB Bandwidth (MHz)	Limit (MHz)	Result
BLE	1	00	2402	0.68	≥ 0.5	Pass
BLE	1	19	2440	0.68	≥ 0.5	Pass
BLE	1	39	2480	0.69	≥ 0.5	Pass

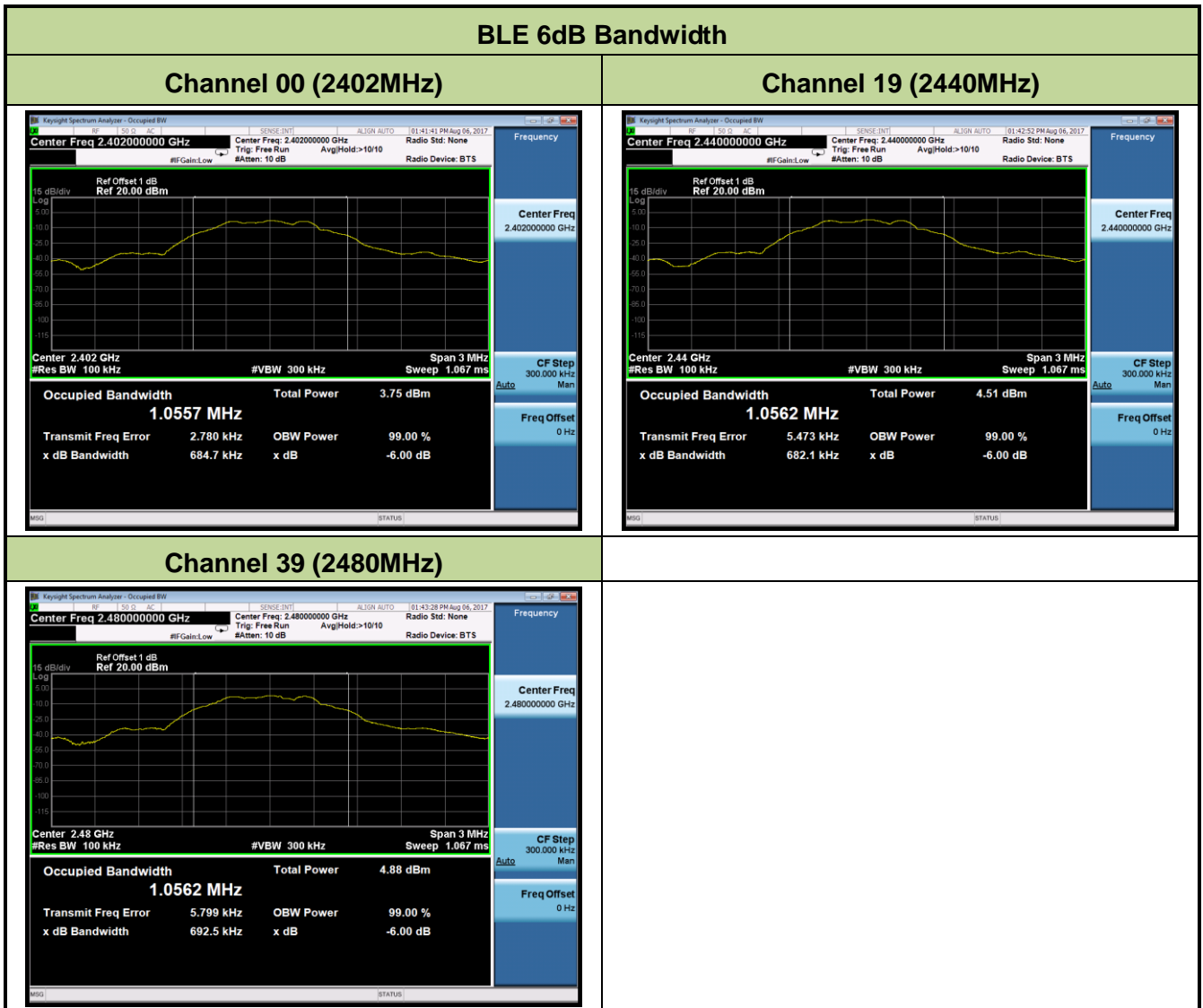

7.3. Output Power Measurement

7.3.1. Test Limit

The maximum out power shall be less 1 Watt (30dBm).

7.3.2. Test Procedure Used

KDB 558074 D01v04 - Section 9.1.2 PKPM1 - Peak Power Method

7.3.3. Test Setting

Method PKPM1 (Peak Power Measurement of Signals with DTS BW \leq 50MHz)

Peak power measurements were performed only when the EUT was transmitting at its maximum power control level using a broadband power meter with a pulse sensor. The pulse sensor employs a VBW = 50MHz so this method was only used for signals whose DTS bandwidth was less than or equal to 50MHz.

7.3.4. Test Setup

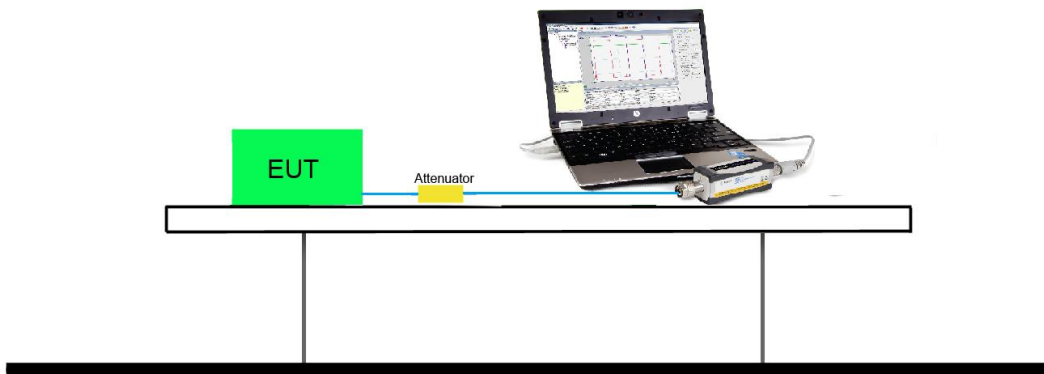

7.3.5. Test Result of Output Power

Test Result of Peak Output Power

Test Mode	Data Rate (Mbps)	Channel No.	Frequency (MHz)	Peak Power (dBm)	Limit (dBm)	Result
BLE	1	00	2402	-2.58	≤ 30	Pass
BLE	1	19	2440	-1.93	≤ 30	Pass
BLE	1	39	2480	-1.27	≤ 30	Pass

Test Result of Average Output Power (Reporting Only)

Test Mode	Data Rate (Mbps)	Channel No.	Frequency (MHz)	Average Power (dBm)	Limit (dBm)	Result
BLE	1	00	2402	-2.86	≤ 30	Pass
BLE	1	19	2440	-2.19	≤ 30	Pass
BLE	1	39	2480	-1.53	≤ 30	Pass

7.4. Power Spectral Density Measurement

7.4.1. Test Limit

The maximum permissible power spectral density is 8dBm in any 3 kHz band.

7.4.2. Test Procedure Used

KDB 558074 D01v04 - Section 10.2 Method PKPSD

7.4.3. Test Setting

1. Analyzer was set to the center frequency of the DTS channel under investigation
2. Span = 1.5 times the DTS channel bandwidth
3. RBW = 3kHz
4. VBW = 10kHz
5. Detector = peak
6. Sweep time = auto couple
7. Trace mode = max hold
8. Trace was allowed to stabilize

7.4.4. Test Setup

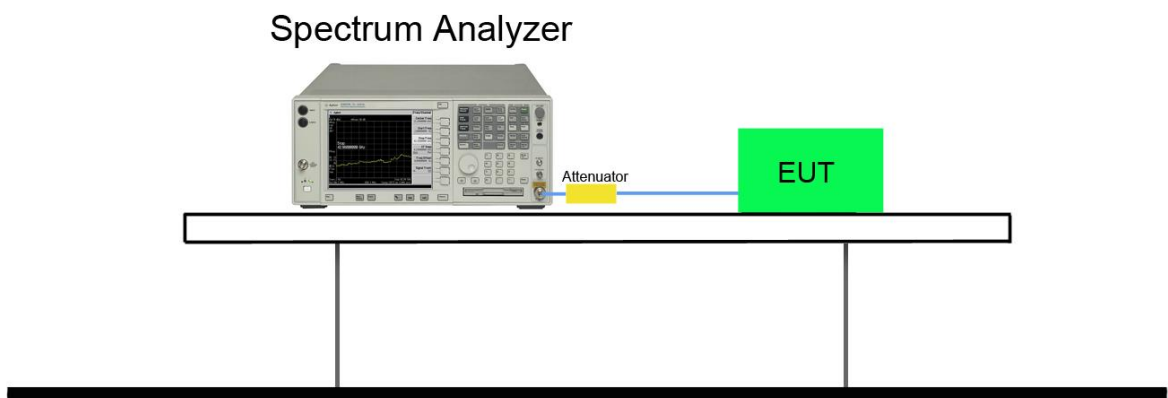

7.4.5. Test Result

Test Mode	Data Rate (Mbps)	Channel No.	Frequency (MHz)	PSD Result (dBm / 3kHz)	Limit (dBm / 3kHz)	Result
BLE	1	00	2402	-16.36	≤ 8.00	Pass
BLE	1	19	2440	-16.11	≤ 8.00	Pass
BLE	1	39	2480	-14.27	≤ 8.00	Pass

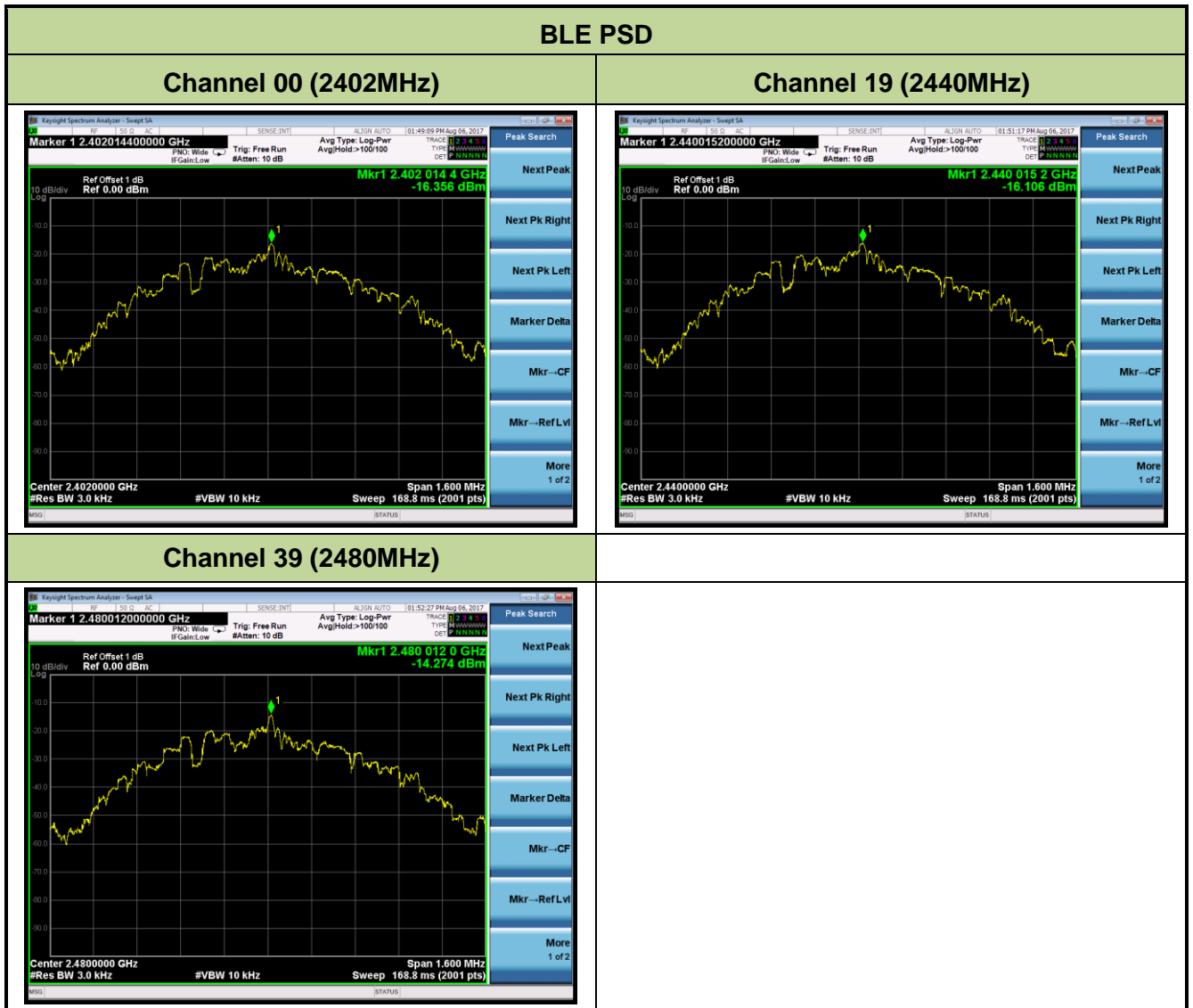

7.5. Conducted Band Edge and Out-of-Band Emissions

7.5.1. Test Limit

The limit for out-of-band spurious emissions at the band edge is 20dB below the fundamental emission level, as determined from the in-band power measurement of the DTS channel performed in a 100kHz bandwidth per the PSD procedure.

7.5.2. Test Procedure Used

KDB 558074 D01v04 - Section 11.2 & Section 11.3

7.5.3. Test Setting

Reference level measurement

1. Set instrument center frequency to DTS channel center frequency
2. Set the span to ≥ 1.5 times the DTS bandwidth
3. Set the RBW = 100 kHz
4. Set the VBW $\geq 3 \times$ RBW
5. Detector = peak
6. Sweep time = auto couple
7. Trace mode = max hold
8. Allow trace to fully stabilize

Emission level measurement

Set the center frequency and span to encompass frequency range to be measured

RBW = 100kHz

VBW = 300kHz

Detector = Peak

Number of sweep points $\geq 2 \times$ Span/RBW

Trace mode = max hold

Sweep time = auto couple

The trace was allowed to stabilize

7.5.4. Test Setup

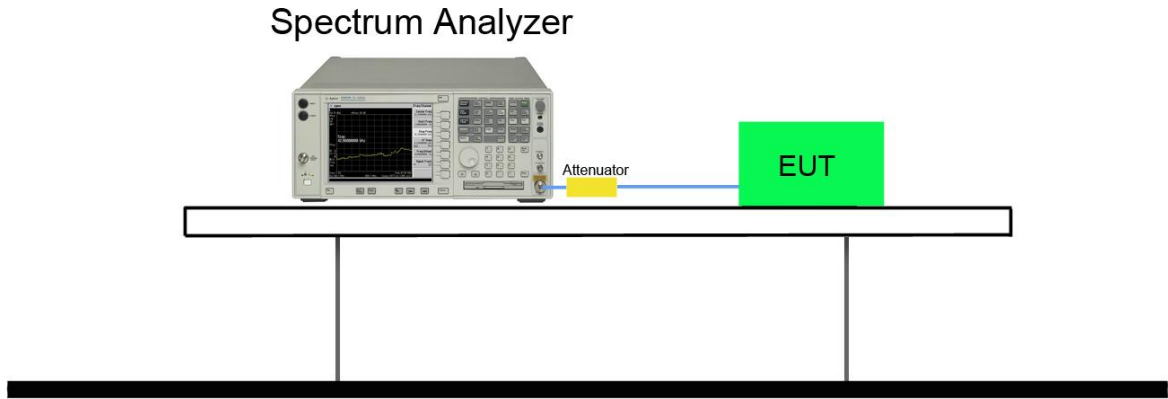

7.5.5. Test Result

Test Mode	Data Rate (Mbps)	Channel No.	Frequency (MHz)	Limit	Result
BLE	1	00	2402	20dBc	Pass
BLE	1	19	2440	20dBc	Pass
BLE	1	39	2480	20dBc	Pass

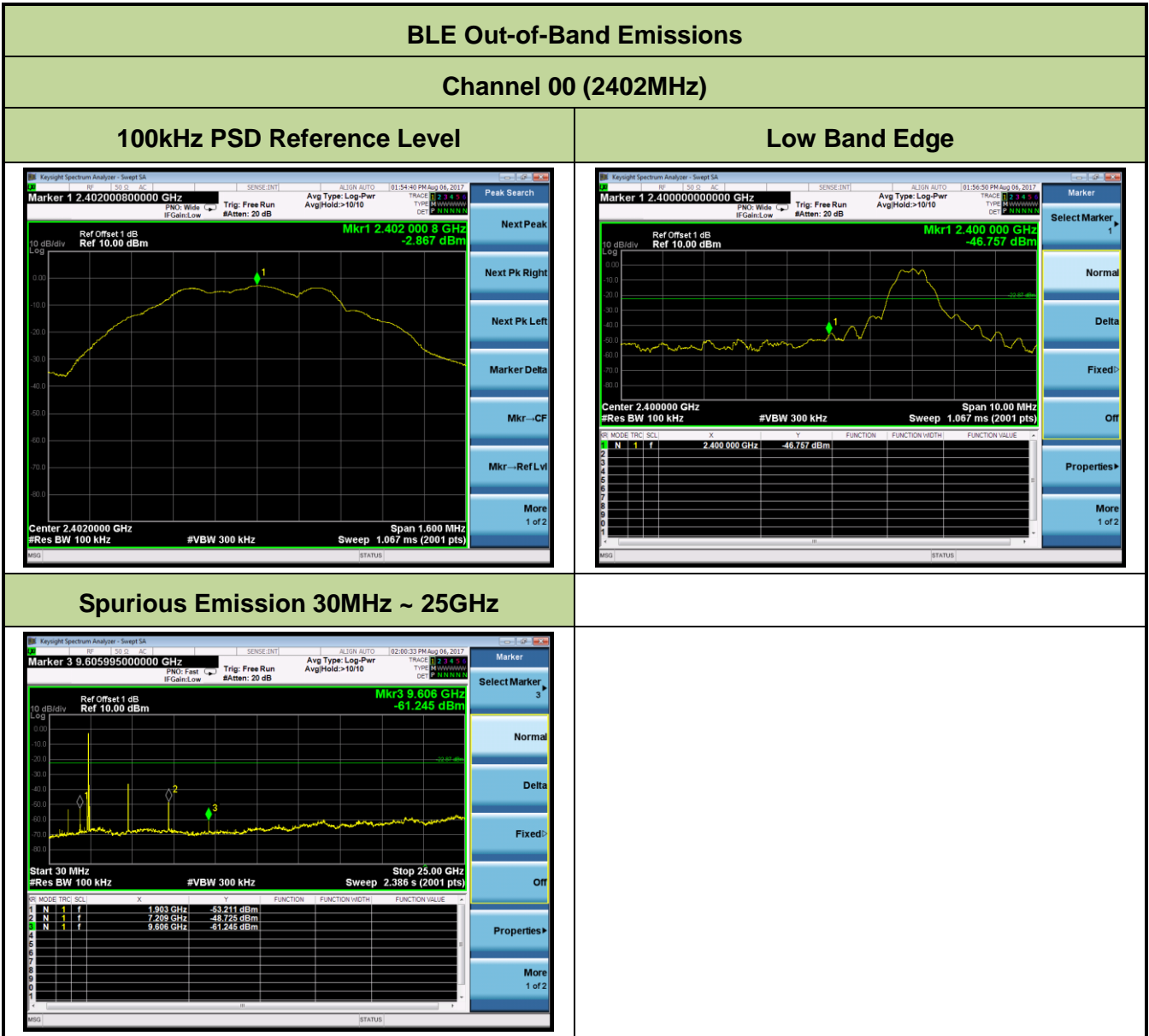

Channel 19 (2440MHz)

100kHz PSD Reference Level



Spurious Emission 30MHz ~ 25GHz

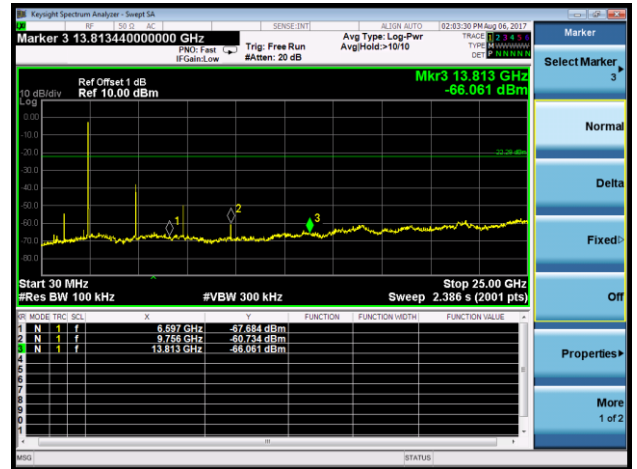

Channel 39 (2480MHz)

100kHz PSD Reference Level

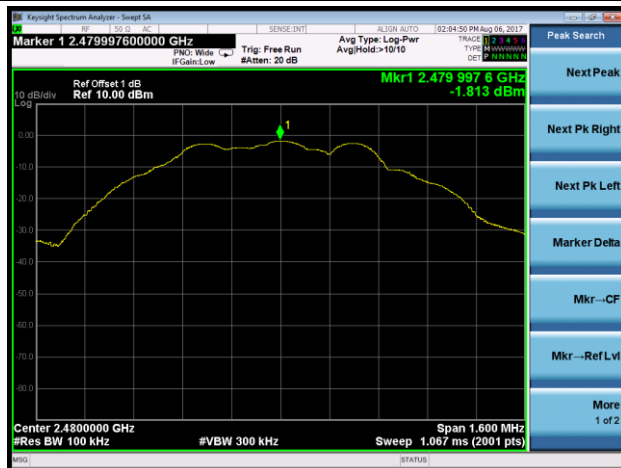

High Band Edge



Spurious Emission 30MHz ~ 25GHz

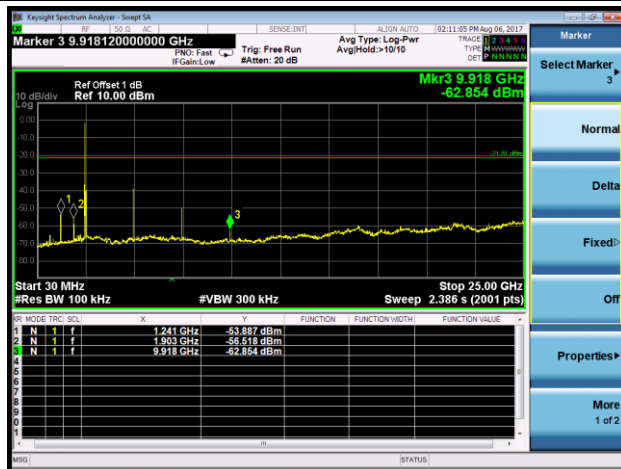

7.6. Radiated Spurious Emission Measurement

7.6.1. Test Limit

All out of band emissions appearing in a restricted band as specified in Section 15.205 of the Title 47 CFR must not exceed the limits shown in Table per Section 15.209.

FCC Part 15 Subpart C Paragraph 15.209		
Frequency [MHz]	Field Strength [uV/m]	Measured Distance [Meters]
0.009 - 0.490	2400/F (kHz)	300
0.490 - 1.705	24000/F (kHz)	30
1.705 - 30	30	30
30 - 88	100	3
88 - 216	150	3
216 - 960	200	3
Above 960	500	3

7.6.2. Test Procedure Used

KDB 558074 D01v04 - Section 12.2.3 (quasi-peak measurements)

KDB 558074 D01v04 - Section 12.2.4 (peak power measurements)

KDB 558074 D01v04 - Section 12.2.5 (average power measurements)

7.6.3. Test Setting

Peak Field Strength Measurements per Section 12.2.4 of KDB 558074 D01v04

1. Analyzer center frequency was set to the frequency of the radiated spurious emission of interest
2. RBW = as specified in Table 1
3. VBW = 3MHz
4. Detector = peak
5. Sweep time = auto couple

6. Trace mode = max hold
7. Trace was allowed to stabilize

Table 1 - RBW as a function of frequency

Frequency	RBW
9 ~ 150 kHz	200 ~ 300 Hz
0.15 ~ 30 MHz	9 ~ 10 kHz
30 ~ 1000 MHz	100 ~ 120 kHz
> 1000 MHz	1 MHz

Average Field Strength Measurements per Section 12.2.4 of KDB 558074 D01v04

1. Analyzer center frequency was set to the frequency of the radiated spurious emission of interest
2. RBW = 1MHz
3. VBW $\geq 1/T$
4. De As an alternative, the instrument may be set to linear detector mode. Ensure that video filtering is applied in linear voltage domain (rather than in a log or dB domain). Some instruments require linear display mode in order to accomplish this. Others have a setting for Average-VBW Type, which can be set to "Voltage" regardless of the display mode
5. Detector = Peak
6. Sweep time = auto
7. Trace mode = max hold
8. Allow max hold to run for at least 50 times (1/duty cycle) traces

7.6.4. Test Setup

9kHz ~ 30MHz Test Setup:

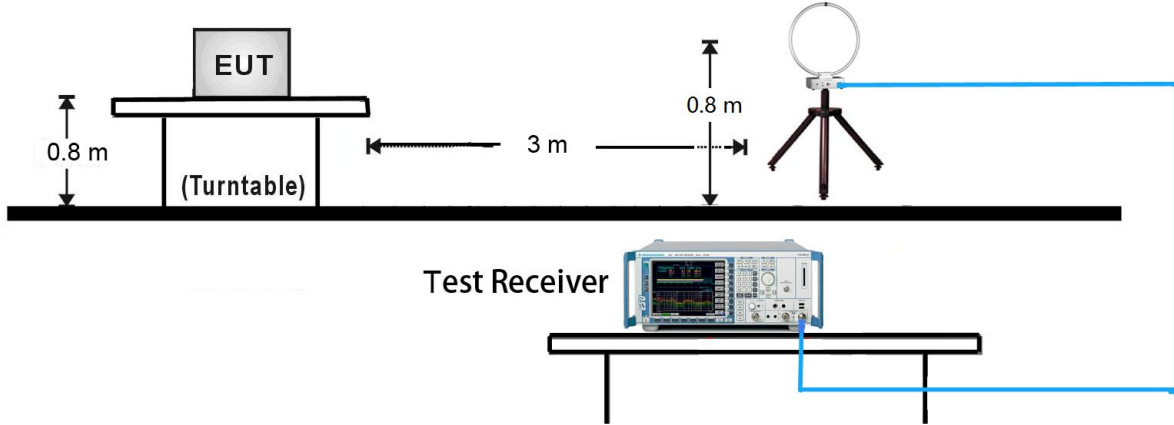

30MHz ~ 1GHz Test Setup:

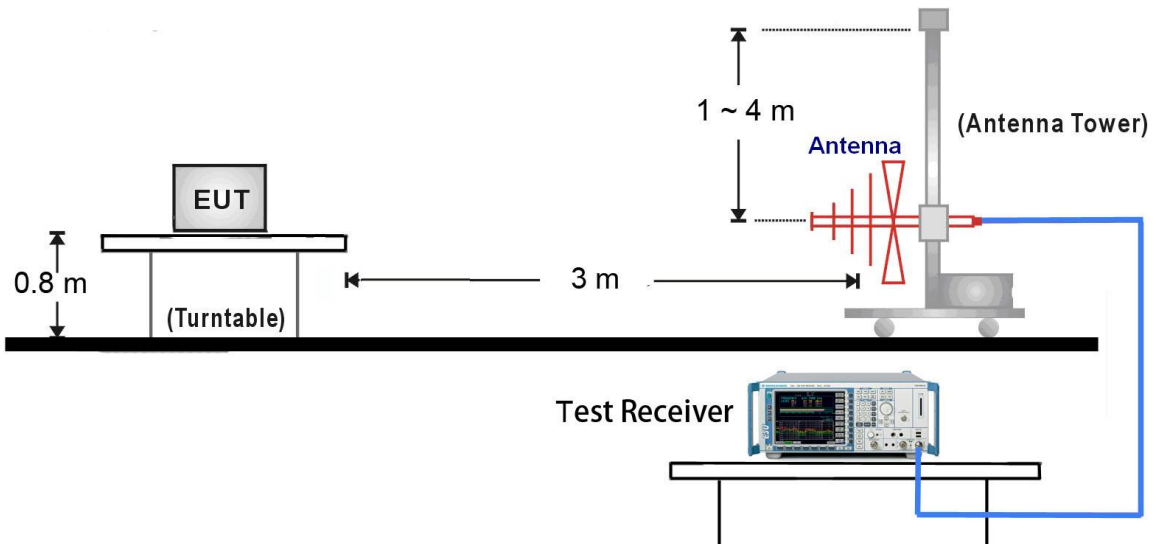

1GHz ~ 18GHz Test Setup:

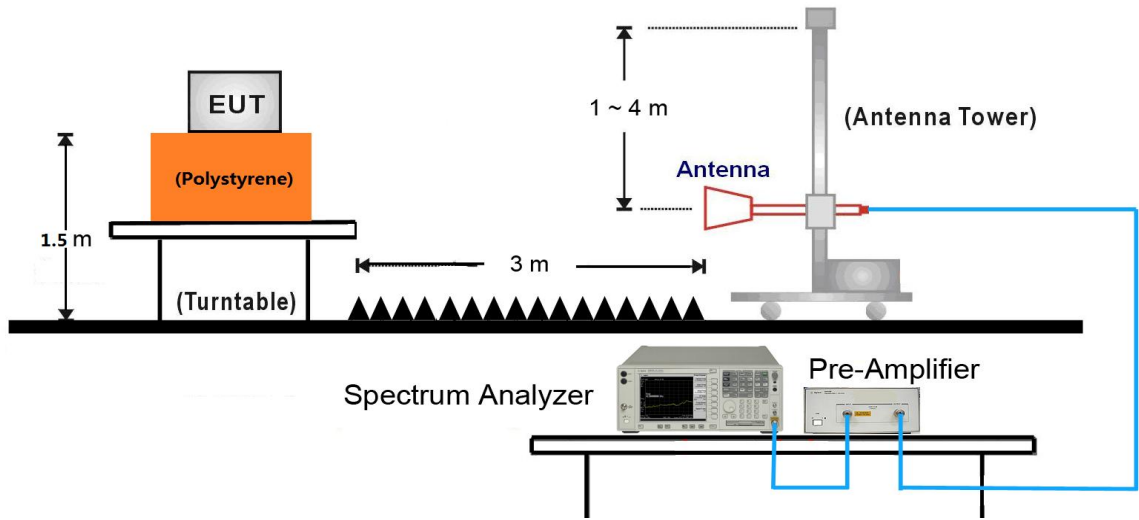

18GHz ~25GHz Test Setup:

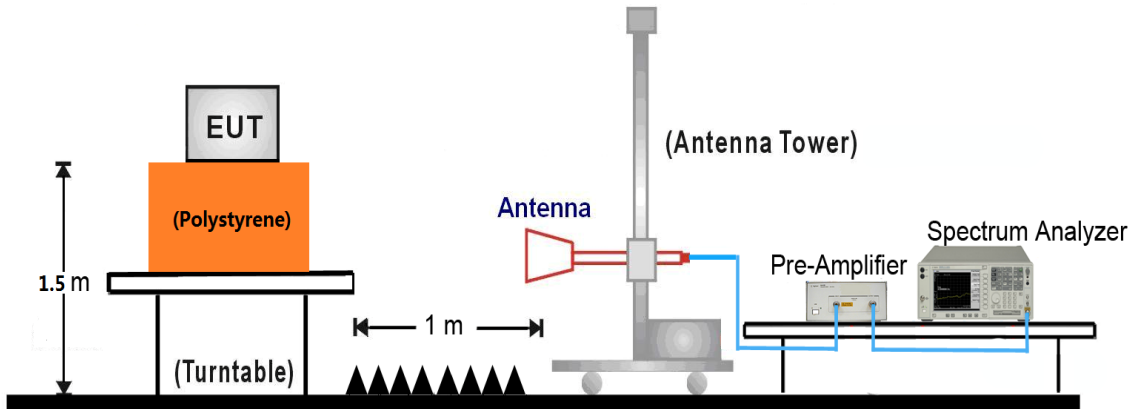

7.6.5. Test Result

Test Mode:	BLE	Test Site:	AC1
Test Channel:	00	Test Engineer:	Bruce Wang
Remark:	1. Average measurement was not performed if peak level lower than average limit. 2. Other frequency was 20dB below limit line within 1-18GHz, there is not show in the report.		

Mark	Frequency (MHz)	Reading Level (dB μ V)	Factor (dB)	Measure Level (dB μ V/m)	Limit (dB μ V/m)	Margin (dB)	Detector	Polarization
	4808.0	42.4	2.7	45.1	74	-28.9	Peak	Horizontal
*	7205.0	40.3	7.8	48.1	74	-25.9	Peak	Horizontal
	9143.0	36.7	9.8	46.5	74	-27.5	Peak	Horizontal
*	13206.0	35.6	12.6	48.2	74	-25.8	Peak	Horizontal
	4799.5	44.6	2.7	47.3	74	-26.7	Peak	Vertical
*	7205.0	42.7	7.8	50.5	74	-23.5	Peak	Vertical
	9355.5	36.3	10.5	46.8	74	-27.2	Peak	Vertical
*	13044.5	35.7	12.3	48.0	74	-26.0	Peak	Vertical

Note 1: "*" is not in restricted band, its limit is 20dBc of the fundamental emission level (87.1dB μ V/m) or 15.209 which is higher.

Note 2: Measure Level (dB μ V/m) = Reading Level (dB μ V) + Factor (dB)

Factor (dB) = Cable Loss (dB) + Antenna Factor (dB/m) - Pre_Amplifier Gain (dB)

Test Mode:	BLE	Test Site:	AC1
Test Channel:	19	Test Engineer:	Bruce Wang
Remark:	1. Average measurement was not performed if peak level lower than average limit. 2. Other frequency was 20dB below limit line within 1-18GHz, there is not show in the report.		

Mark	Frequency (MHz)	Reading Level (dBμV)	Factor (dB)	Measure Level (dBμV/m)	Limit (dBμV/m)	Margin (dB)	Detector	Polarization
	4876.0	41.3	2.7	44.0	74	-30.0	Peak	Horizontal
*	5896.0	36.8	4.2	41.0	74	-33.0	Peak	Horizontal
	7324.0	40.2	8.0	48.2	74	-25.8	Peak	Horizontal
*	9806.0	35.2	11.5	46.7	74	-27.3	Peak	Horizontal
	4876.0	45.6	2.7	48.3	74	-25.7	Peak	Vertical
*	5955.5	36.0	4.3	40.3	74	-33.7	Peak	Vertical
	7324.0	42.1	8.0	50.1	74	-23.9	Peak	Vertical
*	9636.0	34.1	11.0	45.1	74	-28.9	Peak	Vertical

Note 1: "*" is not in restricted band, its limit is 20dBc of the fundamental emission level (86.2dBμV/m) or 15.209 which is higher.

Note 2: Measure Level (dBμV/m) = Reading Level (dBμV) + Factor (dB)

Factor (dB) = Cable Loss (dB) + Antenna Factor (dB/m) - Pre_Amplifier Gain (dB)

Test Mode:	BLE	Test Site:	AC1
Test Channel:	39	Test Engineer:	Bruce Wang
Remark:	1. Average measurement was not performed if peak level lower than average limit. 2. Other frequency was 20dB below limit line within 1-18GHz, there is not show in the report.		

Mark	Frequency (MHz)	Reading Level (dBμV)	Factor (dB)	Measure Level (dBμV/m)	Limit (dBμV/m)	Margin (dB)	Detector	Polarization
	4961.0	40.9	2.9	43.8	74	-30.2	Peak	Horizontal
*	6066.0	35.7	4.1	39.8	74	-34.2	Peak	Horizontal
	7443.0	41.9	8.0	49.9	74	-24.1	Peak	Horizontal
*	9678.5	33.5	10.9	44.4	74	-29.6	Peak	Horizontal
	4961.0	46.3	2.9	49.2	74	-24.8	Peak	Vertical
*	6057.5	36.2	4.1	40.3	74	-33.7	Peak	Vertical
	7443.0	42.0	8.0	50.0	74	-24.0	Peak	Vertical
*	9678.5	33.9	10.9	44.8	74	-29.2	Peak	Vertical

Note 1: "*" is not in restricted band, its limit is 20dBc of the fundamental emission level (84.3dBμV/m) or 15.209 which is higher.

Note 2: Measure Level (dBμV/m) = Reading Level (dBμV) + Factor (dB)

Factor (dB) = Cable Loss (dB) + Antenna Factor (dB/m) - Pre_Amplifier Gain (dB)

The worst case of Radiated Emission below 1GHz:

Site: AC1	Time: 2017/08/09 - 18:46
Limit: FCC_Part15.209_RE(3m)	Engineer: Dandy Li
Probe: VULB 9168_20-2000MHz	Polarity: Horizontal
EUT: Segway miniPLUS	Power: By Battery
Worse Case Mode: Transmit by BLE at channel 2402MHz	

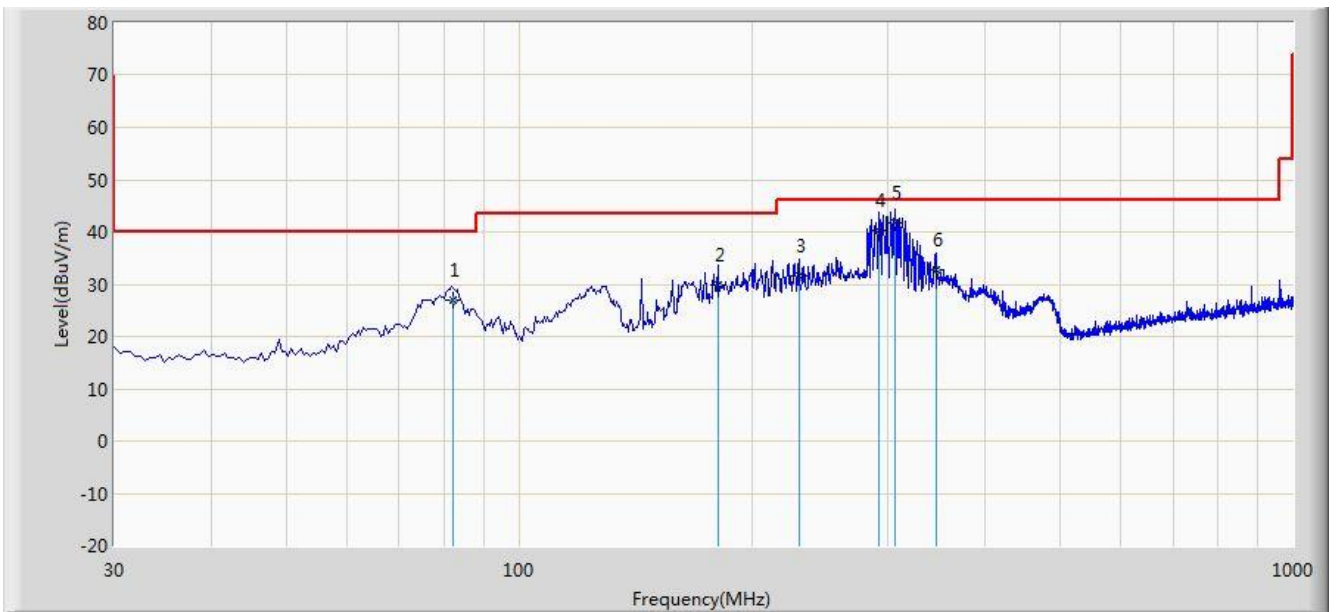

No	Flag	Mark	Frequency (MHz)	Measure Level (dBuV/m)	Reading Level (dBuV)	Over Limit (dB)	Limit (dBuV/m)	Factor (dB)	Type
1			82.380	27.013	16.945	-12.987	40.000	10.068	QP
2			180.835	29.882	17.182	-13.618	43.500	12.701	QP
3			229.820	31.708	19.210	-14.292	46.000	12.498	QP
4			292.385	40.293	26.198	-5.707	46.000	14.095	QP
5		*	305.965	41.626	27.183	-4.374	46.000	14.443	QP
6			345.735	32.769	17.393	-13.231	46.000	15.376	QP

Note 1: Measure Level (dBμV/m) = Reading Level (dBμV) + Factor (dB)

Factor (dB) = Cable Loss (dB) + Antenna Factor (dB/m)

Note 2: The test trace is same as the ambient noise and the amplitude of the emissions are attenuated more than 20dB below the permissible (the test frequency range: 9kHz ~ 30MHz, 18GHz ~ 25GHz), therefore no data appear in the report.

Site: AC1	Time: 2017/08/09 - 18:51
Limit: FCC_Part15.209_RE(3m)	Engineer: Dandy Li
Probe: VULB 9168_20-2000MHz	Polarity: Vertical
EUT: Segway miniPLUS	Power: By Battery
Worse Case Mode: Transmit by BLE at channel 2402MHz	

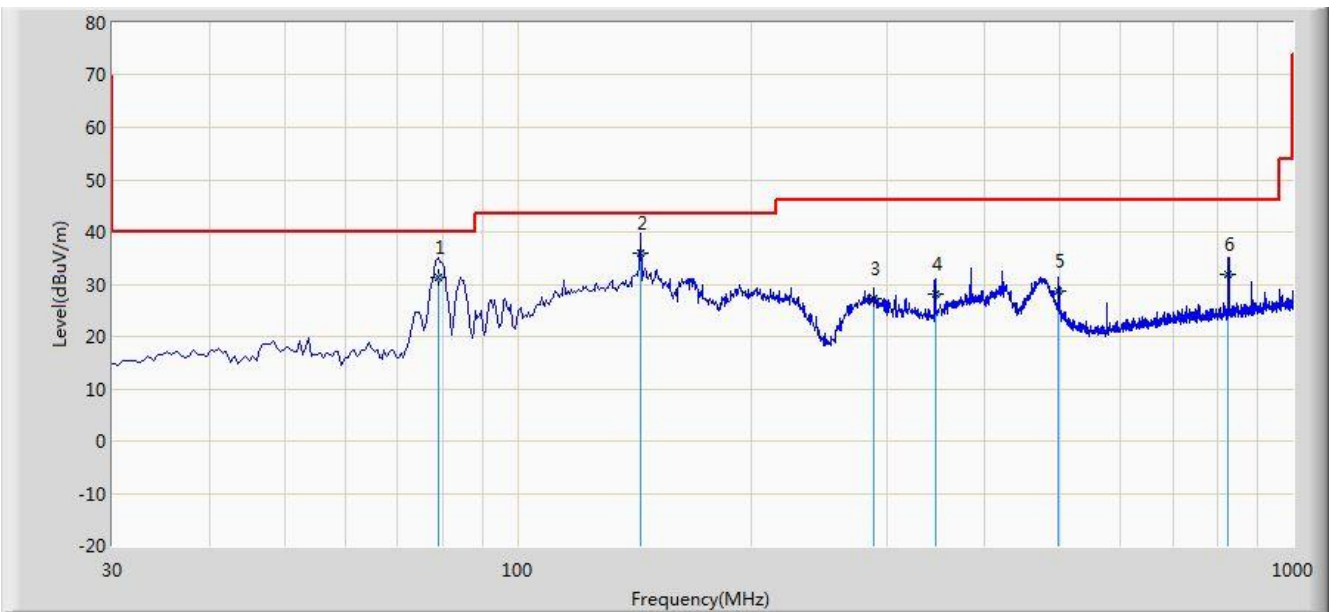

No	Flag	Mark	Frequency (MHz)	Measure Level (dBuV/m)	Reading Level (dBuV)	Over Limit (dB)	Limit (dBuV/m)	Factor (dB)	Type
1			78.985	31.440	21.284	-8.560	40.000	10.156	QP
2		*	143.975	36.047	21.284	-7.453	43.500	14.763	QP
3			288.020	27.201	13.209	-18.799	46.000	13.992	QP
4			345.735	28.139	12.763	-17.861	46.000	15.376	QP
5			498.995	28.749	10.287	-17.251	46.000	18.462	QP
6			826.370	31.754	8.287	-14.246	46.000	23.467	QP

Note 1: Measure Level (dBμV/m) = Reading Level (dBμV) + Factor (dB)

Factor (dB) = Cable Loss (dB) + Antenna Factor (dB/m)

Note 2: The test trace is same as the ambient noise and the amplitude of the emissions are attenuated more than 20dB below the permissible (the test frequency range: 9kHz ~ 30MHz, 18GHz ~ 25GHz), therefore no data appear in the report.

7.7. Radiated Restricted Band Edge Measurement

7.7.1. Test Result

Site: AC1	Time: 2017/08/10 - 01:32
Limit: FCC_Part15.209_RE(3m)	Engineer: Will Yan
Probe: BBHA9120D_1-18GHz	Polarity: Horizontal
EUT: Segway miniPLUS	Power: By Battery
Note: Transmit by BLE at channel 2402MHz	

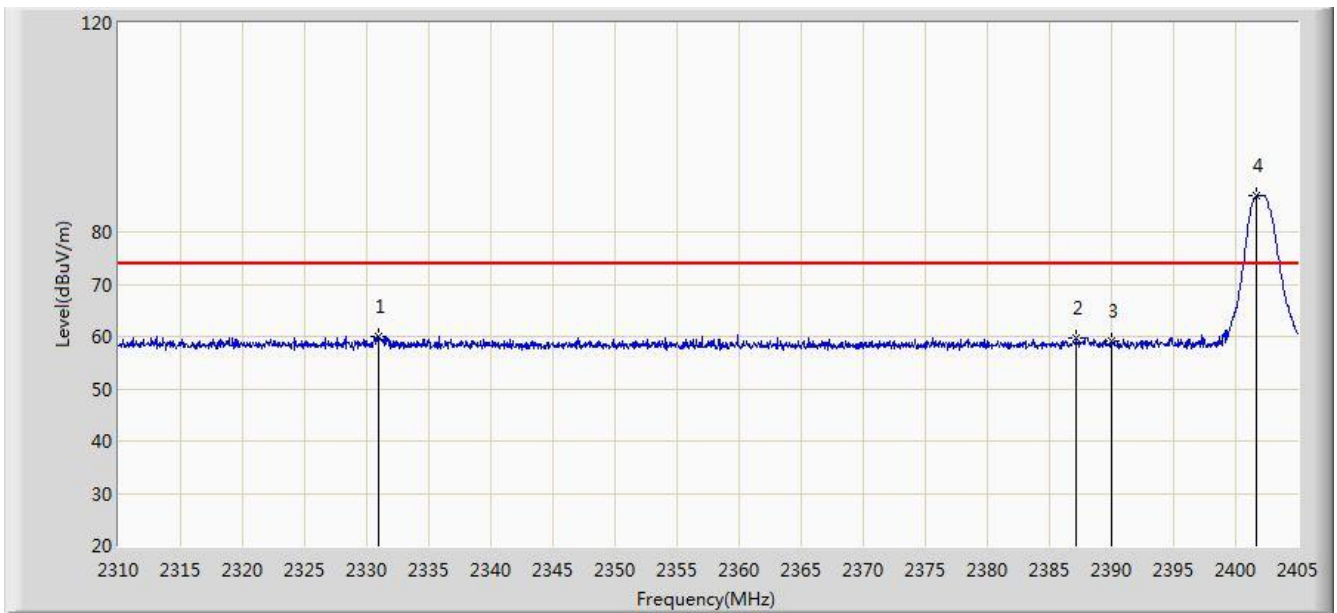

No	Flag	Mark	Frequency (MHz)	Measure Level (dBuV/m)	Reading Level (dBuV)	Over Limit (dB)	Limit (dBuV/m)	Factor (dB)	Type
1			2330.995	60.124	28.753	-13.876	74.000	31.372	PK
2			2387.140	59.810	28.602	-14.190	74.000	31.208	PK
3			2390.000	59.048	27.845	-14.952	74.000	31.203	PK
4		*	2401.722	87.069	55.885	N/A	N/A	31.184	PK

Note: Measure Level (dB μ V/m) = Reading Level (dB μ V) + Factor (dB)

Factor (dB) = Cable Loss (dB) + Antenna Factor (dB/m)

Site: AC1	Time: 2017/08/10 - 01:48
Limit: FCC_Part15.209_RE(3m)	Engineer: Will Yan
Probe: BBHA9120D_1-18GHz	Polarity: Horizontal
EUT: Segway miniPLUS	Power: By Battery
Note: Transmit by BLE at channel 2402MHz	

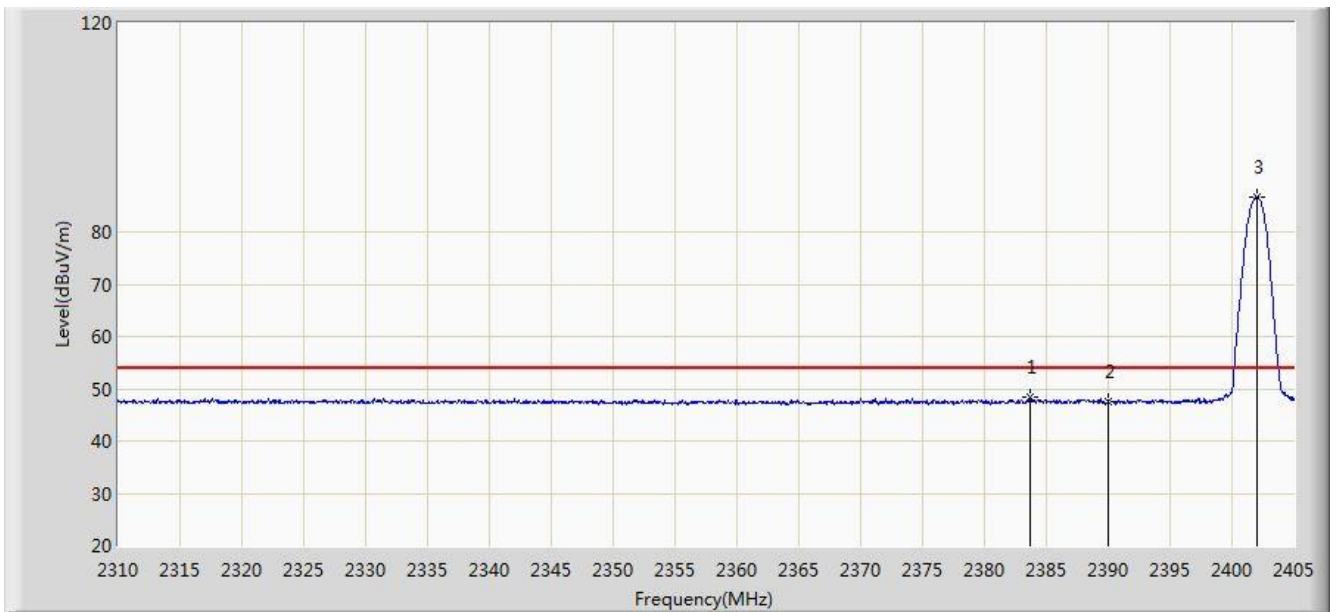

No	Flag	Mark	Frequency (MHz)	Measure Level (dBuV/m)	Reading Level (dBuV)	Over Limit (dB)	Limit (dBuV/m)	Factor (dB)	Type
1			2383.673	48.292	17.078	-5.708	54.000	31.214	AV
2			2390.000	47.679	16.476	-6.321	54.000	31.203	AV
3		*	2402.008	86.716	55.532	N/A	N/A	31.184	AV

Note: Measure Level (dB μ V/m) = Reading Level (dB μ V) + Factor (dB)

Factor (dB) = Cable Loss (dB) + Antenna Factor (dB/m)

Site: AC1	Time: 2017/08/10 - 01:48
Limit: FCC_Part15.209_RE(3m)	Engineer: Will Yan
Probe: BBHA9120D_1-18GHz	Polarity: Vertical
EUT: Segway miniPLUS	Power: By Battery
Note: Transmit by BLE at channel 2402MHz	

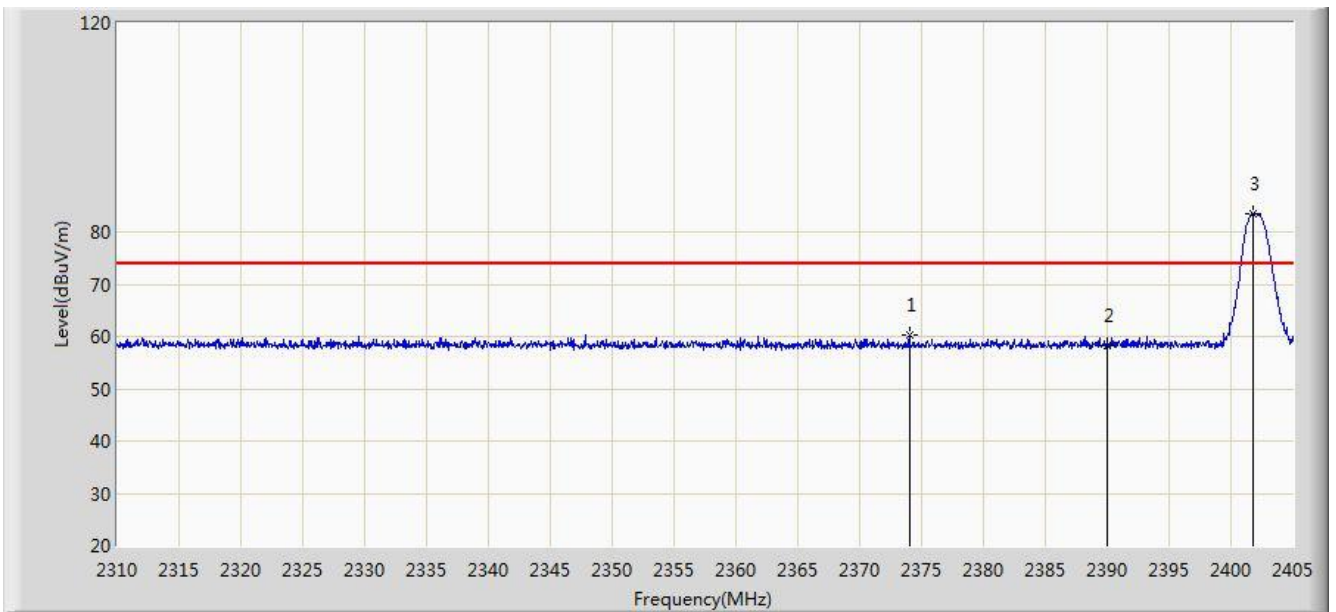

No	Flag	Mark	Frequency (MHz)	Measure Level (dBuV/m)	Reading Level (dBuV)	Over Limit (dB)	Limit (dBuV/m)	Factor (dB)	Type
1			2374.030	60.366	29.134	-13.634	74.000	31.232	PK
2			2390.000	58.295	27.092	-15.705	74.000	31.203	PK
3		*	2401.770	83.467	52.283	N/A	N/A	31.184	PK

Note: Measure Level (dBμV/m) = Reading Level (dBμV) + Factor (dB)

Factor (dB) = Cable Loss (dB) + Antenna Factor (dB/m)

Site: AC1	Time: 2017/08/10 - 01:51
Limit: FCC_Part15.209_RE(3m)	Engineer: Will Yan
Probe: BBHA9120D_1-18GHz	Polarity: Vertical
EUT: Segway miniPLUS	Power: By Battery
Note: Transmit by BLE at channel 2402MHz	

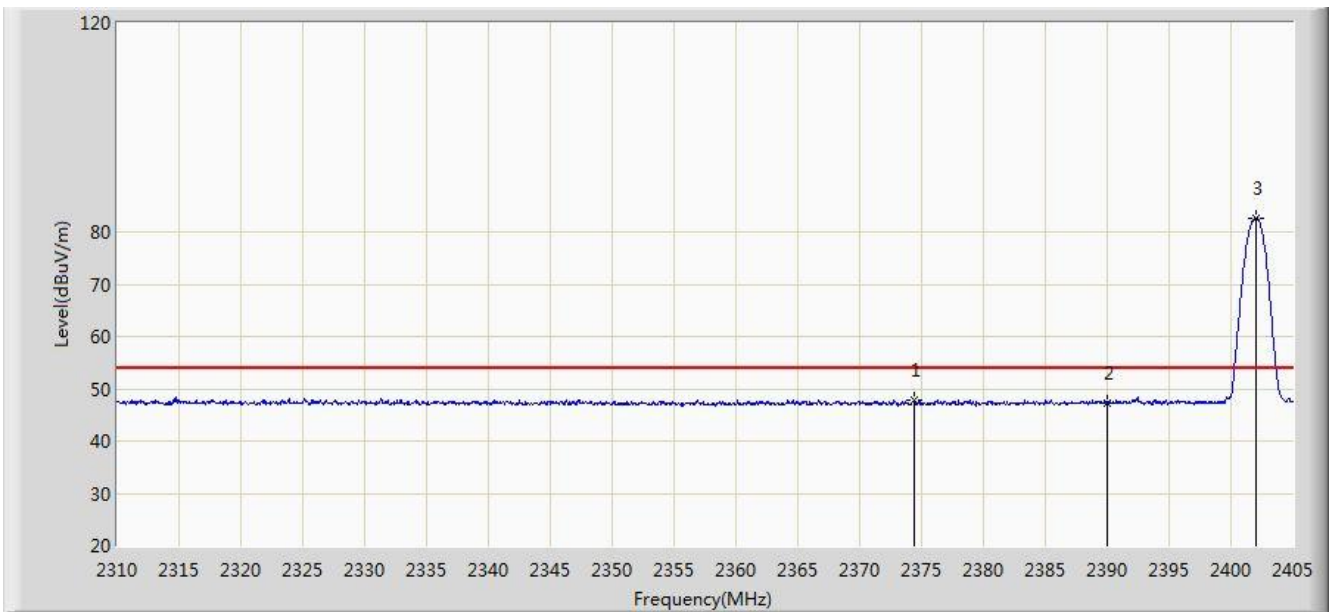

No	Flag	Mark	Frequency (MHz)	Measure Level (dBuV/m)	Reading Level (dBuV)	Over Limit (dB)	Limit (dBuV/m)	Factor (dB)	Type
1			2374.458	47.780	16.549	-6.220	54.000	31.231	AV
2			2390.000	47.144	15.941	-6.856	54.000	31.203	AV
3		*	2402.008	82.749	51.565	N/A	N/A	31.184	AV

Note: Measure Level (dBμV/m) = Reading Level (dBμV) + Factor (dB)

Factor (dB) = Cable Loss (dB) + Antenna Factor (dB/m)

Site: AC1	Time: 2017/08/10 - 01:52
Limit: FCC_Part15.209_RE(3m)	Engineer: Will Yan
Probe: BBHA9120D_1-18GHz	Polarity: Horizontal
EUT: Segway miniPLUS	Power: By Battery
Note: Transmit by BLE at channel 2480MHz	

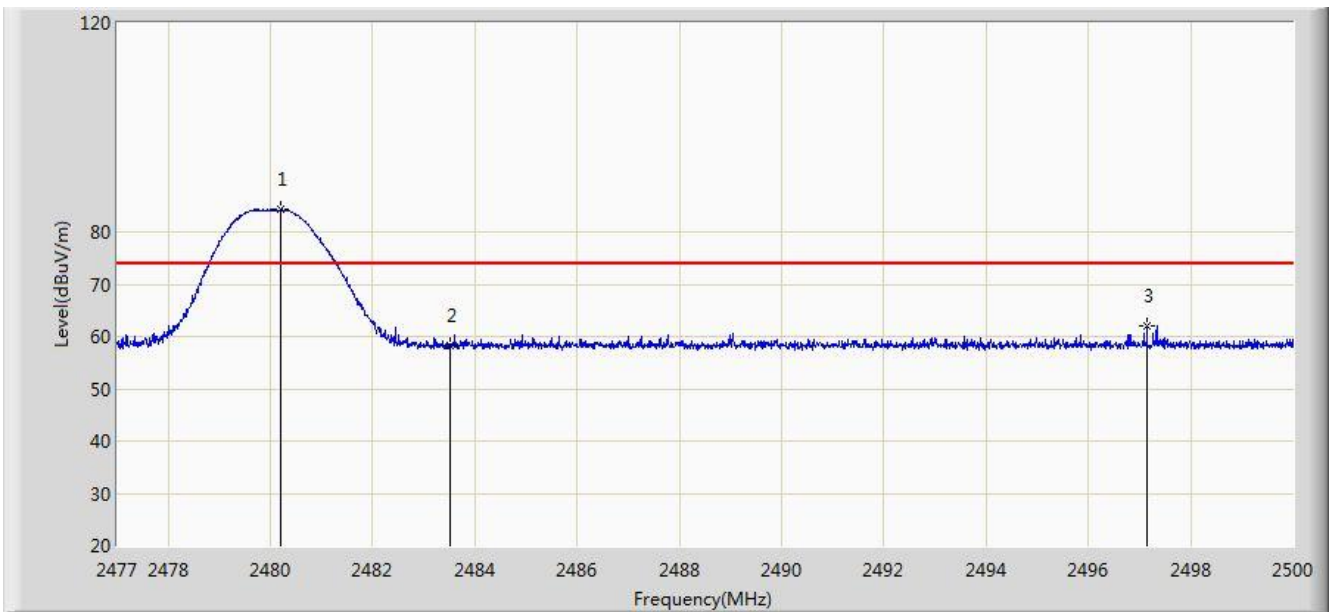

No	Flag	Mark	Frequency (MHz)	Measure Level (dBuV/m)	Reading Level (dBuV)	Over Limit (dB)	Limit (dBuV/m)	Factor (dB)	Type
1		*	2480.208	84.269	53.084	N/A	N/A	31.185	PK
2			2483.500	58.260	27.067	-15.740	74.000	31.194	PK
3			2497.148	62.037	30.808	-11.963	74.000	31.229	PK

Note: Measure Level (dB μ V/m) = Reading Level (dB μ V) + Factor (dB)

Factor (dB) = Cable Loss (dB) + Antenna Factor (dB/m)

Site: AC1	Time: 2017/08/10 - 01:56
Limit: FCC_Part15.209_RE(3m)	Engineer: Will Yan
Probe: BBHA9120D_1-18GHz	Polarity: Horizontal
EUT: Segway miniPLUS	Power: By Battery
Note: Transmit by BLE at channel 2480MHz	

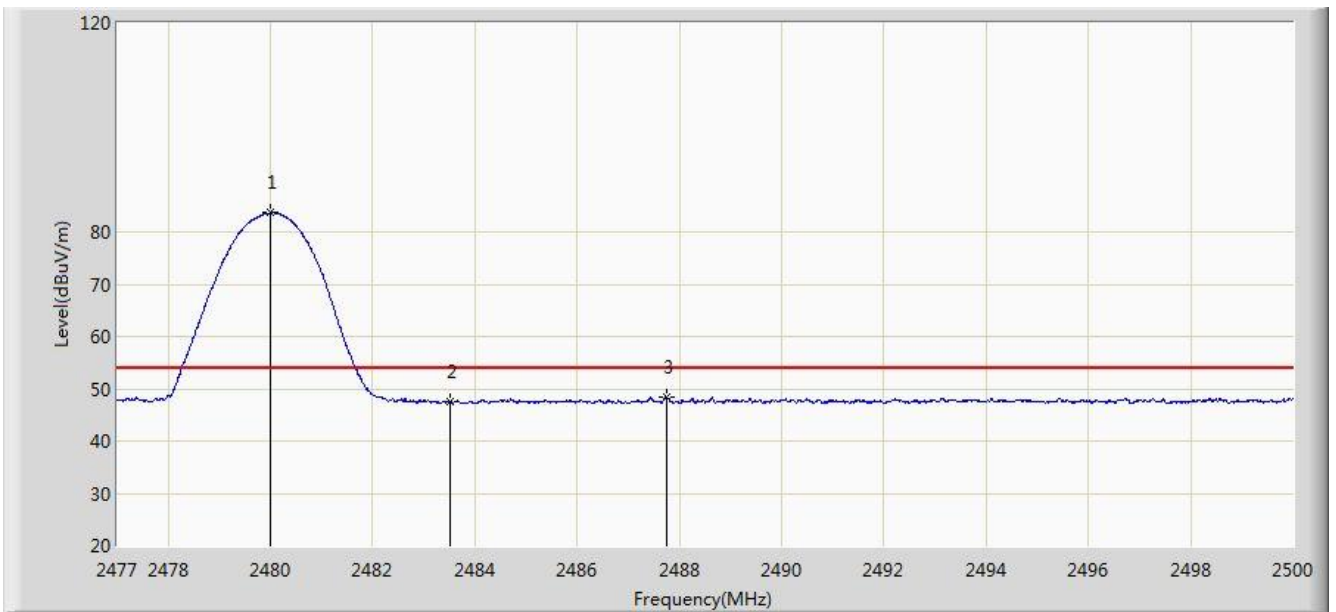

No	Flag	Mark	Frequency (MHz)	Measure Level (dBuV/m)	Reading Level (dBuV)	Over Limit (dB)	Limit (dBuV/m)	Factor (dB)	Type
1		*	2480.001	83.644	52.460	N/A	N/A	31.184	AV
2			2483.500	47.613	16.420	-6.387	54.000	31.194	AV
3			2487.741	48.383	17.179	-5.617	54.000	31.204	AV

Note: Measure Level (dB μ V/m) = Reading Level (dB μ V) + Factor (dB)

Factor (dB) = Cable Loss (dB) + Antenna Factor (dB/m)

Site: AC1	Time: 2017/08/10 - 01:59
Limit: FCC_Part15.209_RE(3m)	Engineer: Will Yan
Probe: BBHA9120D_1-18GHz	Polarity: Vertical
EUT: Segway miniPLUS	Power: By Battery
Note: Transmit by BLE at channel 2480MHz	

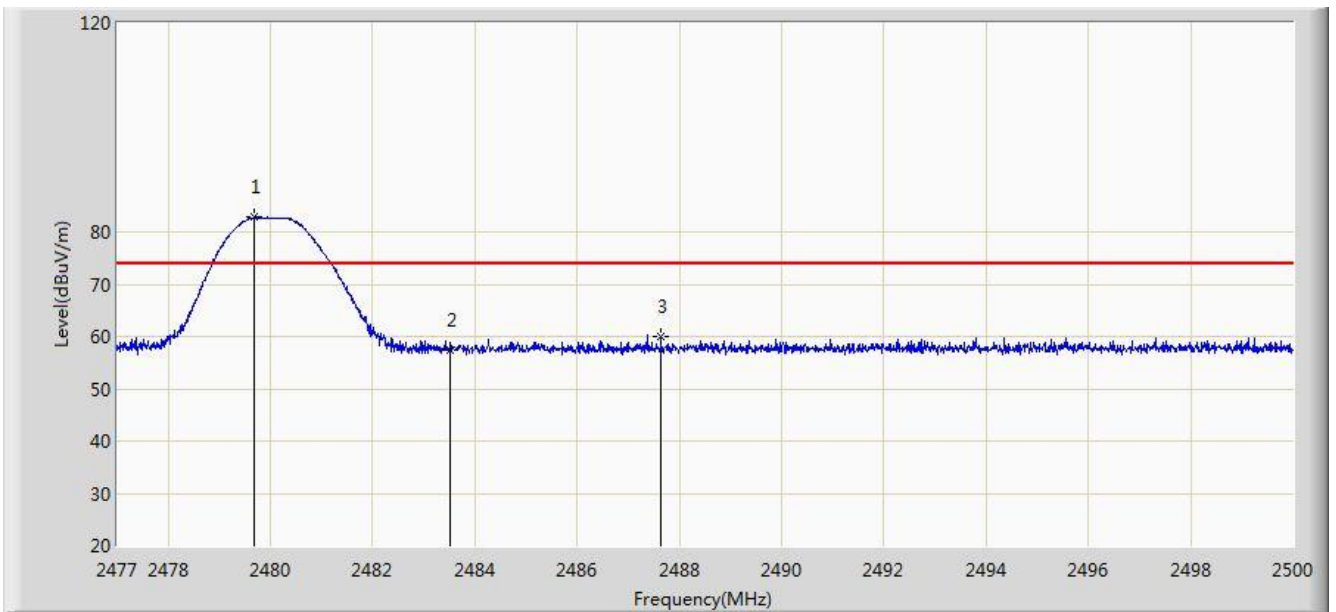

No	Flag	Mark	Frequency (MHz)	Measure Level (dBuV/m)	Reading Level (dBuV)	Over Limit (dB)	Limit (dBuV/m)	Factor (dB)	Type
1		*	2479.691	82.769	51.586	N/A	N/A	31.184	PK
2			2483.500	57.405	26.212	-16.595	74.000	31.194	PK
3			2487.637	60.022	28.818	-13.978	74.000	31.204	PK

Note: Measure Level (dB μ V/m) = Reading Level (dB μ V) + Factor (dB)

Factor (dB) = Cable Loss (dB) + Antenna Factor (dB/m)

Site: AC1	Time: 2017/08/10 - 02:02
Limit: FCC_Part15.209_RE(3m)	Engineer: Will Yan
Probe: BBHA9120D_1-18GHz	Polarity: Vertical
EUT: Segway miniPLUS	Power: By Battery
Note: Transmit by BLE at channel 2480MHz	

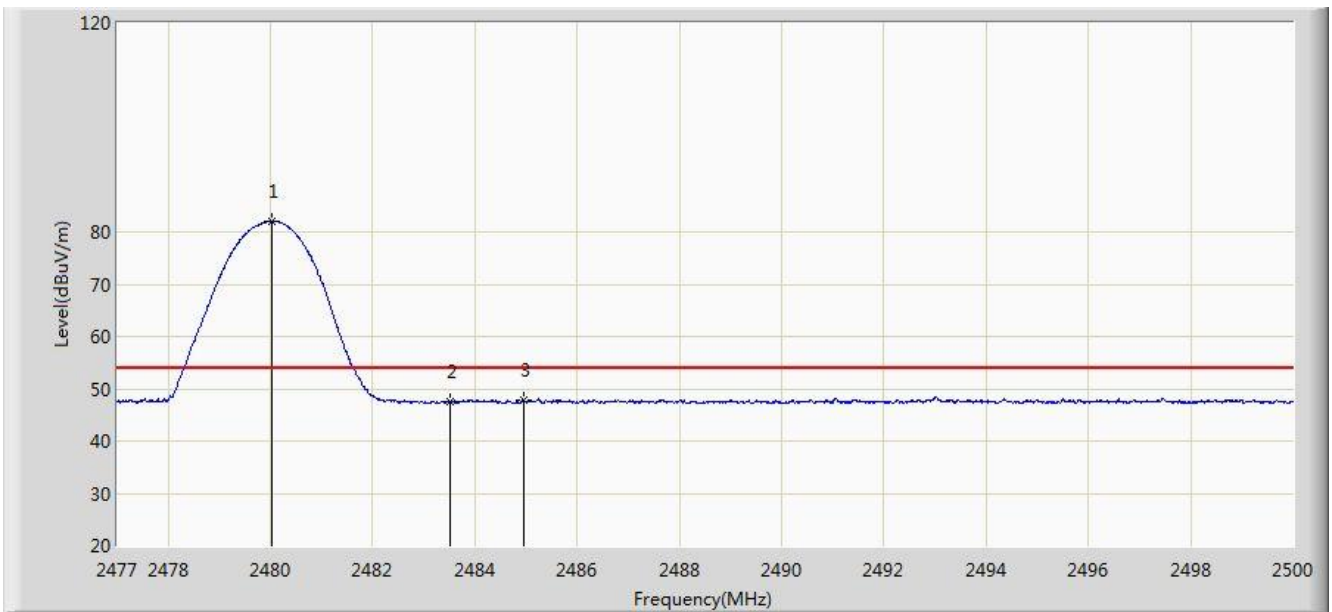

No	Flag	Mark	Frequency (MHz)	Measure Level (dBuV/m)	Reading Level (dBuV)	Over Limit (dB)	Limit (dBuV/m)	Factor (dB)	Type
1		*	2480.024	82.058	50.874	N/A	N/A	31.184	AV
2			2483.500	47.475	16.282	-6.525	54.000	31.194	AV
3			2484.947	47.952	16.755	-6.048	54.000	31.197	AV

Note: Measure Level (dBμV/m) = Reading Level (dBμV) + Factor (dB)

Factor (dB) = Cable Loss (dB) + Antenna Factor (dB/m)

7.8. AC Conducted Emissions Measurement

7.8.1. Test Limit

FCC Part 15 Subpart C Paragraph 15.207 Limits		
Frequency (MHz)	QP (dBuV)	AV (dBuV)
0.15 - 0.50	66 - 56	56 - 46
0.50 - 5.0	56	46
5.0 - 30	60	50

Note 1: The lower limit shall apply at the transition frequencies.

Note 2: The limit decreases linearly with the logarithm of the frequency in the range 0.15MHz to 0.5MHz.

7.8.2. Test Setup

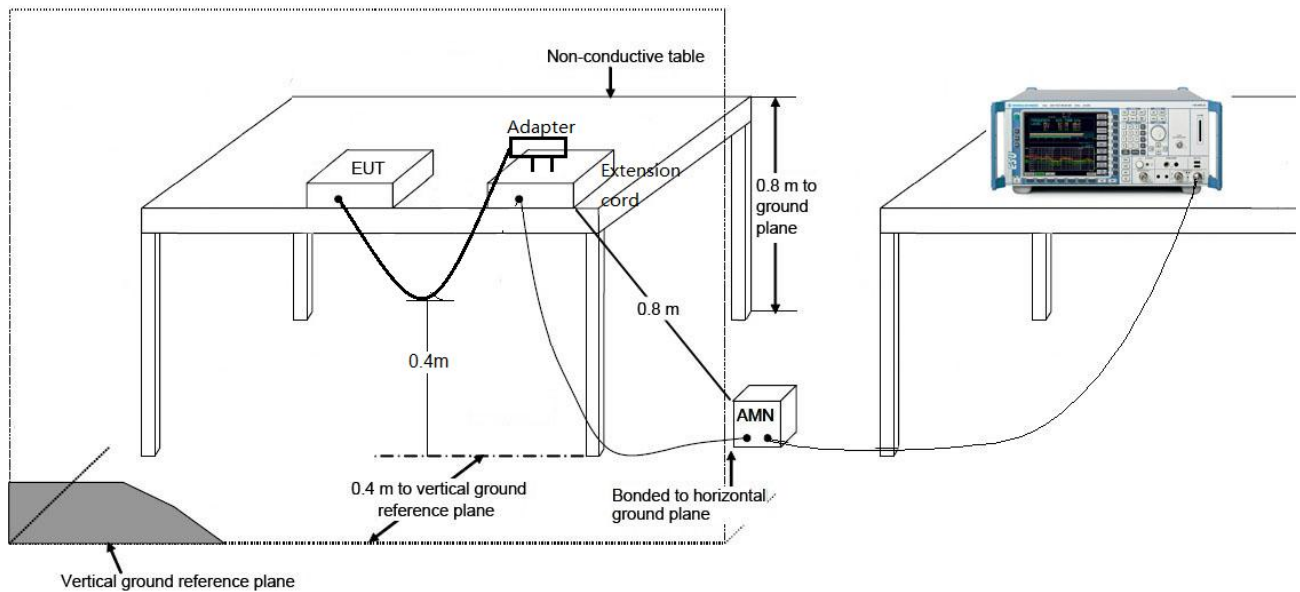

7.8.3. Test Result

Site: SR2	Time: 2017/08/10 - 13:46
Limit: FCC_Part15.207_CE_AC Power	Engineer: Bacon Dong
Probe: ENV216_101683_Filter On	Polarity: Line
EUT: Segway miniPLUS	Power: AC 120V/60Hz
Worst Case Mode: Transmit by BLE at channel 2402MHz	

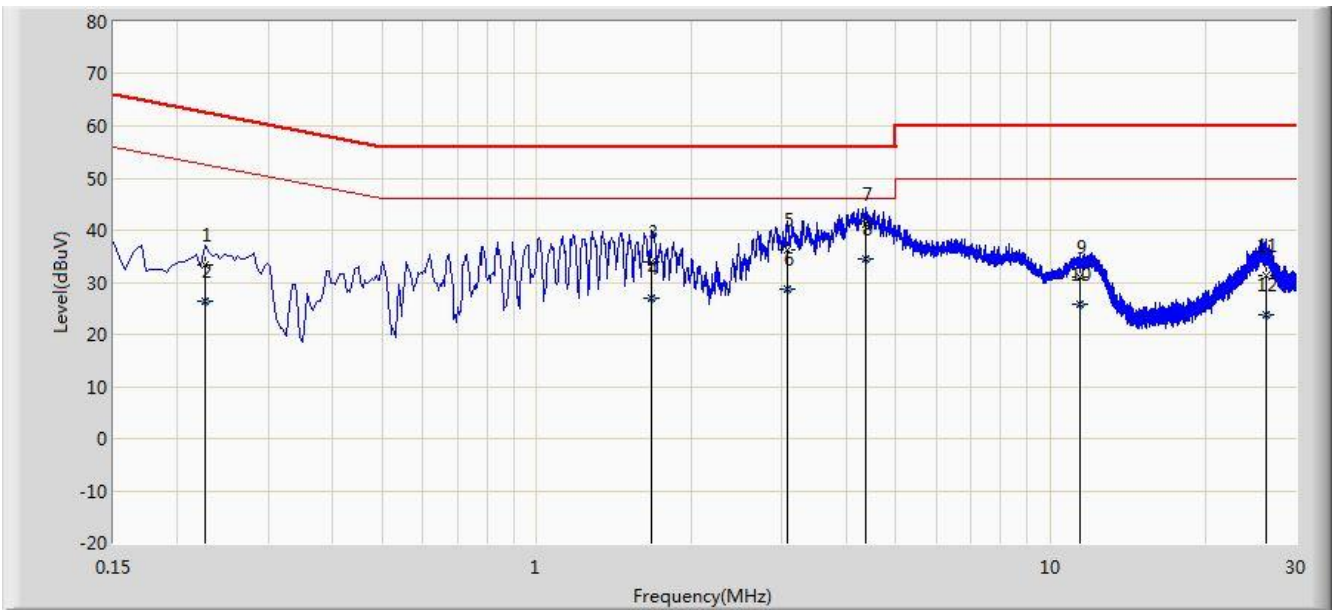

No	Flag	Mark	Frequency (MHz)	Measure Level (dBuV)	Reading Level (dBuV)	Over Limit (dB)	Limit (dBuV)	Factor (dB)	Type
1			0.226	33.332	23.388	-29.264	62.595	9.944	QP
2			0.226	26.255	16.310	-26.341	52.595	9.944	AV
3			1.670	33.925	24.042	-22.075	56.000	9.883	QP
4			1.670	26.902	17.020	-19.098	46.000	9.883	AV
5			3.066	36.339	26.478	-19.661	56.000	9.861	QP
6			3.066	28.658	18.797	-17.342	46.000	9.861	AV
7			4.374	41.068	31.087	-14.932	56.000	9.981	QP
8		*	4.374	34.483	24.501	-11.517	46.000	9.981	AV
9			11.402	31.048	20.952	-28.952	60.000	10.096	QP
10			11.402	25.715	15.619	-24.285	50.000	10.096	AV
11			26.346	31.347	21.110	-28.653	60.000	10.237	QP
12			26.346	23.753	13.516	-26.247	50.000	10.237	AV

Note: Measure Level (dBμV) = Reading Level (dBμV) + Factor (dB)

Factor (dB) = Cable Loss (dB) + LISN Factor (dB)

Site: SR2	Time: 2017/08/10 - 13:53
Limit: FCC_Part15.207_CE_AC Power	Engineer: Bacon Dong
Probe: ENV216_101683_Filter On	Polarity: Neutral
EUT: Segway miniPLUS	Power: AC 120V/60Hz
Worst Case Mode: Transmit by BLE at channel 2402MHz	

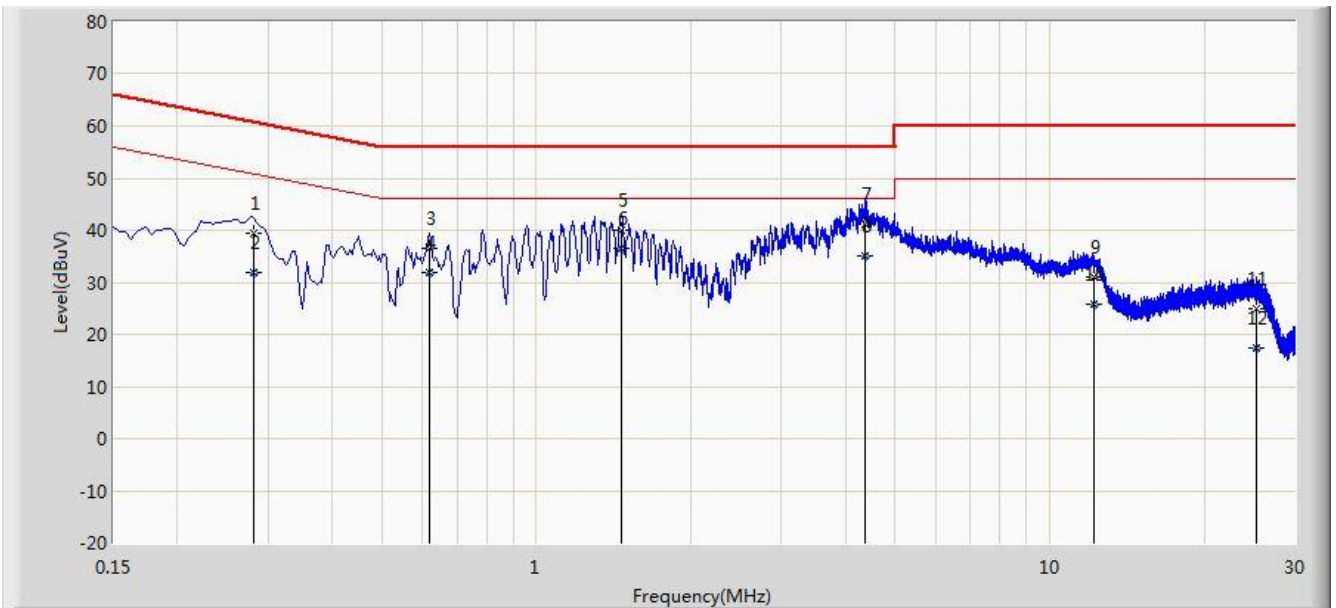

No	Flag	Mark	Frequency (MHz)	Measure Level (dBuV)	Reading Level (dBuV)	Over Limit (dB)	Limit (dBuV)	Factor (dB)	Type
1			0.282	39.410	29.385	-21.347	60.757	10.025	QP
2			0.282	31.915	21.890	-18.842	50.757	10.025	AV
3			0.618	36.515	26.394	-19.485	56.000	10.121	QP
4			0.618	31.952	21.830	-14.048	46.000	10.121	AV
5			1.462	40.128	30.236	-15.872	56.000	9.892	QP
6		*	1.462	36.603	26.711	-9.397	46.000	9.892	AV
7			4.378	41.256	31.267	-14.744	56.000	9.990	QP
8			4.378	34.948	24.958	-11.052	46.000	9.990	AV
9			12.222	30.930	20.807	-29.070	60.000	10.122	QP
10			12.222	25.761	15.639	-24.239	50.000	10.122	AV
11			25.230	24.929	14.622	-35.071	60.000	10.307	QP
12			25.230	17.388	7.081	-32.612	50.000	10.307	AV

Note: Measure Level (dBμV) = Reading Level (dBμV) + Factor (dB)

Factor (dB) = Cable Loss (dB) + LISN Factor (dB)

8. CONCLUSION

The data collected relate only the item(s) tested and show that the **Segway miniPLUS** is in compliance with Part 15C of the FCC Rules & IC Rules.

The End