

# MEASUREMENT REPORT

## FCC PART 15.247 / RSS-247 Bluetooth LE

---

**FCC ID:** 2ALS8-OR0001  
**IC** 22636-OR0001  
**Applicant:** Ninebot (Changzhou) Tech Co., Ltd.  
**Application Type:** Certification  
**Product:** T-BOX  
**Model No.:** NB-ORBOXC12  
**Brand Name:** Segway  
**FCC Classification:** Digital Transmission System (DTS)  
**FCC Rule Part(s):** Part 15 Subpart C (Section 15.247)  
**ISED Rule Part(s):** RSS-247 Issue 2, RSS-GEN Issue 5  
**Test Procedure(s):** ANSI C63.10-2013, KDB 558074 D01v05  
**Test Date:** September 24 ~ 30, 2020

Reviewed By:   
\_\_\_\_\_  
( Sunny Sun )

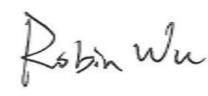
Approved By:   
\_\_\_\_\_  
( Robin Wu )



The test results relate only to the samples tested.

This equipment has been shown to be capable of compliance with the applicable technical standards as indicated in the measurement report and was tested in accordance with the measurement procedures specified in ANSI C63.10-2013. Test results reported herein relate only to the item(s) tested.

The test report shall not be reproduced except in full without the written approval of MRT Technology (Suzhou) Co., Ltd.

---

## Revision History

Report No.	Version	Description	Issue Date	Note
2009RSU050-U1	Rev. 01	Initial Report	10-14-2020	Valid

---

## CONTENTS

Description	Page
<b>1. INTRODUCTION .....</b>	<b>6</b>
1.1. Scope .....	6
1.2. MRT Test Location .....	6
<b>2. PRODUCT INFORMATION .....</b>	<b>7</b>
2.1. Feature of Equipment under Test.....	7
2.2. Working Frequencies for this report .....	7
2.3. Test Mode .....	8
2.4. Test Environment Condition .....	8
2.5. Test Software .....	8
2.6. Description of Test Configuration .....	8
2.7. Test System Details .....	8
2.8. Duty Cycle .....	9
<b>3. ANTENNA REQUIREMENTS .....</b>	<b>10</b>
<b>4. TEST EQUIPMENT CALIBRATION DATE .....</b>	<b>11</b>
<b>5. MEASUREMENT UNCERTAINTY .....</b>	<b>13</b>
<b>6. TEST RESULT .....</b>	<b>14</b>
6.1. Summary .....	14
6.2. Occupied Bandwidth Measurement .....	15
6.2.1. Test Limit .....	15
6.2.2. Test Procedure used .....	15
6.2.3. Test Setting.....	15
6.2.4. Test Setup .....	16
6.2.5. Test Result.....	17
6.3. Output Power Measurement .....	19
6.3.1. Test Limit .....	19
6.3.2. Test Procedure Used.....	19
6.3.3. Test Setting.....	19
6.3.4. Test Setup .....	20
6.3.5. Test Result of Output Power.....	21
6.4. Power Spectral Density Measurement.....	22
6.4.1. Test Limit .....	22
6.4.2. Test Procedure Used.....	22
6.4.3. Test Setting.....	22
6.4.4. Test Setup .....	22

---

6.4.5.	Test Result.....	23
6.5.	Conducted Band Edge and Out-of-Band Emissions .....	24
6.5.1.	Test Limit .....	24
6.5.2.	Test Procedure Used.....	24
6.5.3.	Test Setting.....	24
6.5.4.	Test Setup .....	25
6.5.5.	Test Result.....	26
6.6.	Radiated Spurious Emission Measurement .....	28
6.6.1.	Test Limit .....	28
6.6.2.	Test Procedure Used.....	29
6.6.3.	Test Setting.....	29
6.6.4.	Test Setup .....	30
6.6.5.	Test Result.....	32
6.7.	Radiated Restricted Band Edge Measurement.....	37
6.7.1.	Test Limit .....	37
6.7.2.	Test Procedure Used.....	40
6.7.3.	Test Setting.....	40
6.7.4.	Test Setup .....	41
6.7.5.	Test Result.....	42
6.8.	AC Conducted Emissions Measurement.....	50
6.8.1.	Test Limit .....	50
6.8.2.	Test Setup .....	50
6.8.3.	Test Result.....	50
<b>7.</b>	<b>CONCLUSION.....</b>	<b>51</b>
	<b>Appendix A - Test Setup Photograph.....</b>	<b>52</b>
	<b>Appendix B - EUT Photograph .....</b>	<b>53</b>

## General Information

<b>Applicant:</b>	Ninebot (Changzhou) Tech Co., Ltd.
<b>Applicant Address:</b>	16F-17F, Block A, Building 3, Changwu Mid Road 18#, Wujin Dist., Changzhou, Jiangsu, China
<b>Manufacturer:</b>	Segway Technology Co., Ltd.
<b>Manufacturer Address:</b>	No. 395, Xiacheng South Road, Wujin National High-tech Industrial Development Zone, Changzhou, Jiangsu, China. 213161
<b>Test Site:</b>	MRT Technology (Suzhou) Co., Ltd
<b>Test Site Address:</b>	D8 Building, No.2 Tian'edang Rd., Wuzhong Economic Development Zone, Suzhou, China

## Test Facility / Accreditations

Measurements were performed at MRT Laboratory located in Tian'edang Rd., Suzhou, China.

- MRT facility is an FCC accredited testing laboratory (MRT Designation No. CN1166) on the FCC website.
- MRT facility is an ISED recognized testing laboratory (MRT Reg. No. CN0001) on the ISED website.
- MRT facility is a VCCI registered (R-20025, G-20034, C-20020, T-20020) test laboratory with the site description on file at VCCI Council.
- MRT Lab is accredited to ISO 17025 by the A2LA under the A2LA Program (Cert. No. 3628.01) and CNAS under the CNAS Program (Cert. No. L10551) in EMC, Safety, Radio, Telecommunications and SAR testing.

## 1. INTRODUCTION

### 1.1. Scope

Measurement and determination of electromagnetic emissions (EMC) of radio frequency devices including intentional and/or unintentional radiators for compliance with the technical rules and regulations of the Federal Communications Commission and the Innovation, Science and Economic Development Canada and Certification and Engineering Bureau.

### 1.2. MRT Test Location

The map below shows the location of the MRT LABORATORY, its proximity to the Taihu Lake. These measurement tests were conducted at the MRT Technology (Suzhou) Co., Ltd. Facility located at D8 Building, No.2 Tian'edang Rd., Wuzhong Economic Development Zone, Suzhou, China. The measurement facility compliant with the test site requirements specified in ANSI C63.4-2014.



## 2. PRODUCT INFORMATION

### 2.1. Feature of Equipment under Test

Product Name	T-BOX
Model No.	NB-ORBOXC12
Brand Name	Segway
Bluetooth Version	v4.1 (BLE Only)
Bluetooth Frequency	2402 ~ 2480MHz
Type of modulation	GFSK
Data Rate	1Mbps
Antenna Type	PCB Antenna
Antenna Gain	-1.26dBi
S/N:	C3B2S20GWC0020

Note: Above information is declared by the manufacturer.

### 2.2. Working Frequencies for this report

Channel	Frequency	Channel	Frequency	Channel	Frequency
00	2402 MHz	01	2404 MHz	02	2406 MHz
03	2408 MHz	04	2410 MHz	05	2412 MHz
06	2414 MHz	07	2416 MHz	08	2418 MHz
09	2420 MHz	10	2422 MHz	11	2424 MHz
12	2426 MHz	13	2428 MHz	14	2430 MHz
15	2432 MHz	16	2434 MHz	17	2436 MHz
18	2438 MHz	19	2440 MHz	20	2442 MHz
21	2444 MHz	22	2446 MHz	23	2448 MHz
24	2450 MHz	25	2452 MHz	26	2454 MHz
27	2456 MHz	28	2458 MHz	29	2460 MHz
30	2462 MHz	31	2464 MHz	32	2466 MHz
33	2468 MHz	34	2470 MHz	35	2472 MHz
36	2474 MHz	37	2476 MHz	38	2478 MHz
39	2480 MHz	--	--	--	--

### 2.3. Test Mode

Test Mode	Mode 1: Transmit by BLE
-----------	-------------------------

### 2.4. Test Environment Condition

Ambient Temperature	15°C ~ 35°C
Relative Humidity	20%RH ~ 75%RH

### 2.5. Test Software

The test utility software used during testing was “nRFgo Studio”, and the version was “4.7.2”.

### 2.6. Description of Test Configuration

The ANSI C63.10: 2013 was used to reference the appropriate EUT setup for testing.

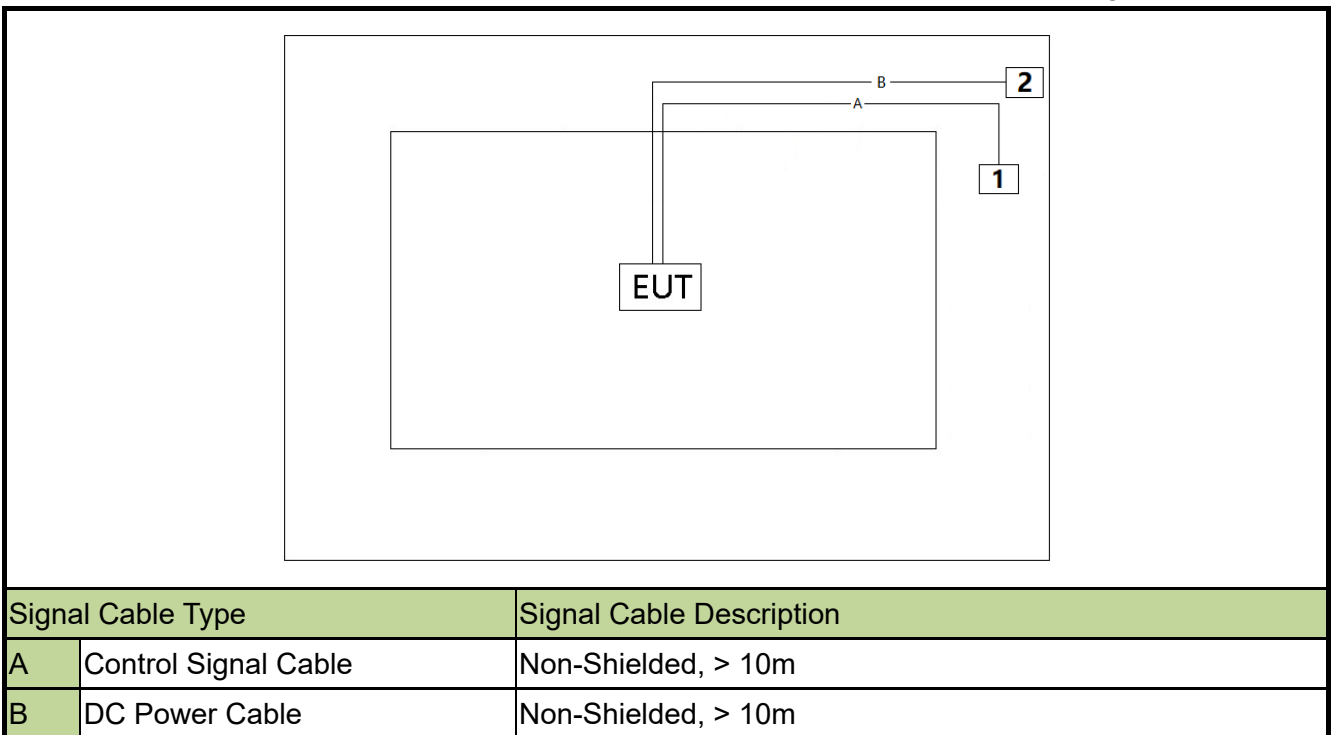

### 2.7. Test System Details

The types for all equipment, plus descriptions of all cables used in the tested system (including inserted cards) are:

Product	Manufacturer	Model No.
1	Notebook	Lenovo E495
2	DC Power Supply	GWINSTEK DPS-3303C



## 2.8. Duty Cycle

The maximum achievable duty cycles for all modes were determined based on measurements performed on a spectrum analyzer in zero-span mode with RBW = 8MHz, VBW = 50MHz. The RBW and VBW were both greater than  $50/T$ , where T is the minimum transmission duration, and the number of sweep points across T was greater than 100. The duty cycles are as follows:

Test Mode	Duty Cycle
BLE	66.93%

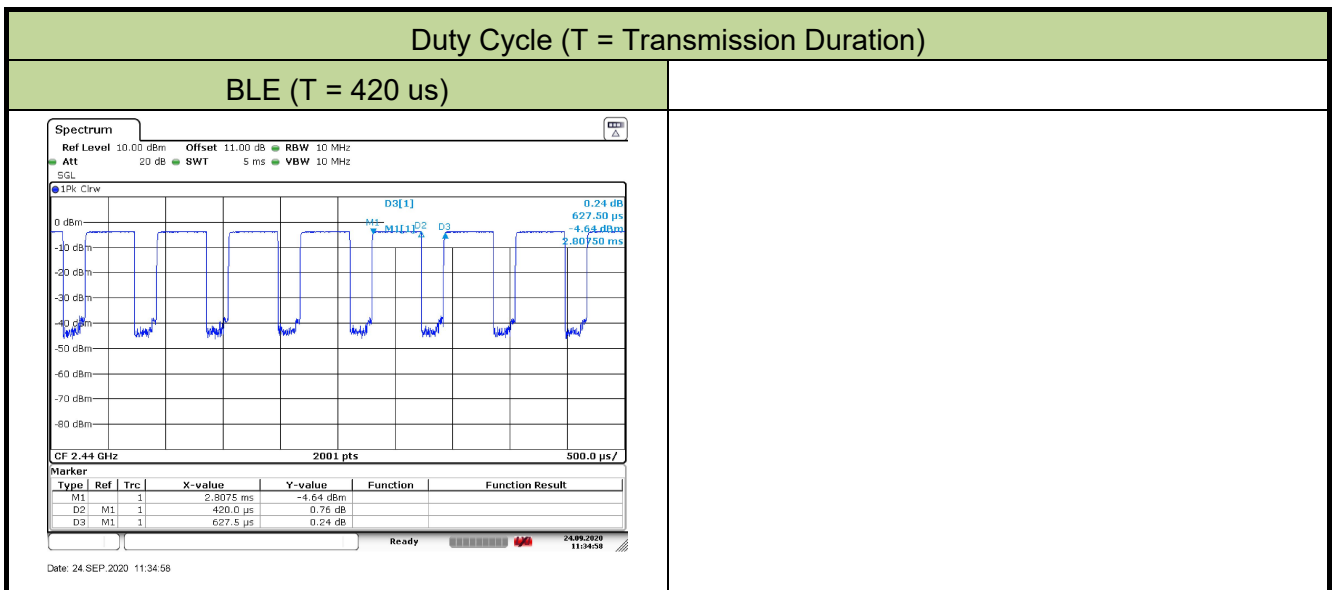

### 3. ANTENNA REQUIREMENTS

**Excerpt from §15.203 of the FCC Rules/Regulations:**

“An intentional radiator antenna shall be designed to ensure that no antenna other than that furnished by the responsible party can be used with the device. The use of a permanently attached antenna or of an antenna that uses a unique coupling to the intentional radiator shall be considered sufficient to comply with the provisions of this section.”

- The antenna of the device is **permanently attached**.
- There are no provisions for connection to an external antenna.

**Conclusion:**

The device unit complies with the requirement of §15.203.

#### 4. TEST EQUIPMENT CALIBRATION DATE

##### Conducted Emissions - SR2

Instrument	Manufacturer	Type No.	Asset No.	Cali. Interval	Cali. Due Date
EMI Test Receiver	R&S	ESR3	MRTSUE06185	1 year	2021/01/18
Two-Line V-Network	R&S	ENV 216	MRTSUE06002	1 year	2021/06/11
Two-Line V-Network	R&S	ENV 216	MRTSUE06003	1 year	2021/06/11
Thermal Hygrometer	testo	608-H1	MRTSUE06404	1 year	2021/07/26

##### Radiated Emissions - AC1

Instrument	Manufacturer	Type No.	Asset No.	Cali. Interval	Cali. Due Date
EMI Test Receiver	R&S	ESR7	MRTSUE06001	1 year	2021/01/18
PXA Signal Analyzer	Keysight	N9030B	MRTSUE06395	1 year	2021/08/30
Loop Antenna	Schwarzbeck	FMZB 1519	MRTSUE06025	1 year	2020/11/13
Bilog Period Antenna	Schwarzbeck	VULB 9168	MRTSUE06172	1 year	2021/04/03
Horn Antenna	Schwarzbeck	BBHA 9120D	MRTSUE06023	1 year	2020/10/13
Horn Antenna	Schwarzbeck	BBHA9170	MRTSUE06597	1 year	2020/12/17
Microwave System Amplifier	Agilent	83017A	MRTSUE06076	1 year	2020/11/15
Preamplifier	Schwarzbeck	BBV 9721	MRTSUE06121	1 year	2021/06/11
Thermal Hygrometer	testo	608-H1	MRTSUE06403	1 year	2021/07/26
Anechoic Chamber	TDK	Chamber-AC1	MRTSUE06212	1 year	2021/04/30

##### Radiated Emission - AC2

Instrument	Manufacturer	Type No.	Asset No.	Cali. Interval	Cali. Due Date
MXE EMI Receiver	Keysight	N9038A	MRTSUE06125	1 year	2021/07/02
Loop Antenna	Schwarzbeck	FMZB 1519	MRTSUE06025	1 year	2020/11/13
Bilog Period Antenna	Schwarzbeck	VULB 9162	MRTSUE06022	1 year	2020/10/13
Broad-Band Horn Antenna	Schwarzbeck	BBHA 9120D	MRTSUE06171	1 year	2020/10/27
Horn Antenna	Schwarzbeck	BBHA9170	MRTSUE06597	1 year	2020/12/17
Broadband Coaxial Preamplifier	Schwarzbeck	BBV 9718	MRTSUE06176	1 year	2020/11/15
Preamplifier	Schwarzbeck	BBV 9721	MRTSUE06121	1 year	2021/06/11
Thermal Hygrometer	Minggao	ETH529	MRTSUE06170	1 year	2020/12/15
Anechoic Chamber	RIKEN	Chamber-AC2	MRTSUE06213	1 year	2021/04/30

## Conducted Test Equipment - TR3

Instrument	Manufacturer	Type No.	Asset No.	Cali. Interval	Cali. Due Date
EXA Signal Analyzer	Agilent	N9020A	MRTSUE06106	1 year	2021/04/14
EXA Signal Analyzer	Keysight	N9010B	MRTSUE06607	1 year	2021/01/08
Signal Analyzer	R&S	FSV40	MRTSUE06218	1 year	2021/04/14
Power Meter	Agilent	U2021XA	MRTSUE06030	1 year	2020/11/18
USB wideband power sensor	Keysight	U2021XA	MRTSUE06446	1 year	2021/06/11
USB wideband power sensor	Keysight	U2021XA	MRTSUE06447	1 year	2021/06/11
Bluetooth Test Set	Anritsu	MT8852B-042	MRTSUE06389	1 year	2021/06/11
Audio Analyzer	Agilent	U8903B	MRTSUE06143	1 year	2021/06/11
Modulation Analyzer	HP	HP8901A	MRTSUE06098	1 year	2020/10/10
Wideband Radio Communication Tester	R&S	CMW 500	MRTSUE06243	1 year	2020/11/07
DC Power Supply	GWINSTEK	DPS-3303C	MRTSUE06064	N/A	N/A
Temperature & Humidity Chamber	BAOYT	BYH-150CL	MRTSUE06051	1 year	2020/11/07
Thermal Hygrometer	testo	608-H1	MRTSUE06401	1 year	2021/07/26

Software	Version	Function
EMI Software	V3	EMI Test Software

## 5. MEASUREMENT UNCERTAINTY

Where relevant, the following test uncertainty levels have been estimated for tests performed on the EUT as specified in CISPR 16-4-2. This uncertainty represents an expanded uncertainty expressed at approximately the 95% confidence level using a coverage factor of  $k = 2$ .

<b>AC Conducted Emission Measurement</b>
Measurement Uncertainty for a Level of Confidence of 95% ( $U=2Uc(y)$ ): 9kHz~150kHz: 3.74dB 150kHz~30MHz: 3.44dB
<b>Radiated Disturbance</b>
Measurement Uncertainty for a Level of Confidence of 95% ( $U=2Uc(y)$ ): Horizontal: 30MHz~300MHz: 5.04dB 300MHz~1GHz: 4.95dB 1GHz~40GHz: 6.40dB Vertical: 30MHz~300MHz: 5.24dB 300MHz~1GHz: 6.03dB 1GHz~40GHz: 6.40dB
<b>Spurious Emissions, Conducted</b>
Measurement Uncertainty for a Level of Confidence of 95% ( $U=2Uc(y)$ ): 0.78dB
<b>Output Power</b>
Measurement Uncertainty for a Level of Confidence of 95% ( $U=2Uc(y)$ ): 1.13dB
<b>Power Spectrum Density</b>
Measurement Uncertainty for a Level of Confidence of 95% ( $U=2Uc(y)$ ): 1.15dB
<b>Occupied Bandwidth</b>
Measurement Uncertainty for a Level of Confidence of 95% ( $U=2Uc(y)$ ): 0.28%

## 6. TEST RESULT

### 6.1. Summary

FCC Part Section(s)	RSS Section(s)	Test Description	Test Limit	Test Condition	Test Result	Reference
15.247(a)(2)	RSS-247 [5.2]	6dB Bandwidth	$\geq 500\text{kHz}$	Conducted	Pass	Section 6.2
N/A	RSS-Gen [6.7]	99% Bandwidth	N/A		Pass	
15.247(b)(3)	RSS-247 [5.4(d)]	Output Power	$\leq 1\text{Watt}$ & $\text{EIRP} \leq 4\text{Watt}$		Pass	Section 6.3
15.247(e)	RSS-247 [5.2]	Power Spectral Density	$\leq 8\text{dBm} / 3\text{kHz}$		Pass	Section 6.4
15.247(d)	RSS-247 [5.5]	Band Edge / Out-of-Band Emissions	$\leq 20\text{dBc}$ (Peak)		Pass	Section 6.5
15.205 15.209	RSS-247 [5.5]	General Field Strength Limits (Restricted Bands and Radiated Emission Limits)	Emissions in restricted bands must meet the radiated limits detailed in 15.209	Radiated	Pass	Section 6.6 & 6.7
15.207	RSS-Gen [8.8]	AC Conducted Emissions 150kHz - 30MHz	< FCC 15.207 limits	Line Conducted	N/A	Section 6.8

#### Notes:

- 1) All modes of operation and data rates were investigated. For radiated emission test, every axis (X, Y, Z) was also verified. The test results shown in the following sections represent the worst case emissions.
- 2) The analyzer plots shown in this section were all taken with a correction table loaded into the analyzer. The correction table was used to account for the losses of the cables and attenuators used as part of the system to connect the EUT to the analyzer at all frequencies of interest.

## **6.2. Occupied Bandwidth Measurement**

### **6.2.1. Test Limit**

The minimum 6dB bandwidth shall be at least 500 kHz.

### **6.2.2. Test Procedure used**

ANSI C63.10-2013 - Section 11.8 (6dB bandwidth)

ANSI C63.10-2013 - Section 6.9.3 (99% bandwidth)

### **6.2.3. Test Setting**

#### **For 6dB bandwidth**

1. Set RBW = 100 kHz
2. VBW  $\geq 3 \times$  RBW
3. Detector = Peak
4. Trace mode = Max hold
5. Sweep = Auto couple
6. Allow the trace was allowed to stabilize
7. Measure the maximum width of the emission that is constrained by the frequencies associated with the two outermost amplitude points (upper and lower frequencies) that are attenuated by 6 dB relative to the maximum level measured in the fundamental emission.

#### **For 99% bandwidth**

1. Span = 1.5 times to 5 times the OBW
2. Set RBW = 1% to 5% the OBW
3. VBW  $\geq 3 \times$  RBW
4. Detector = Peak
5. Trace mode = Max hold
6. Sweep = Auto couple
7. Allow the trace was allowed to stabilize

### 6.2.4. Test Setup

## Spectrum Analyzer

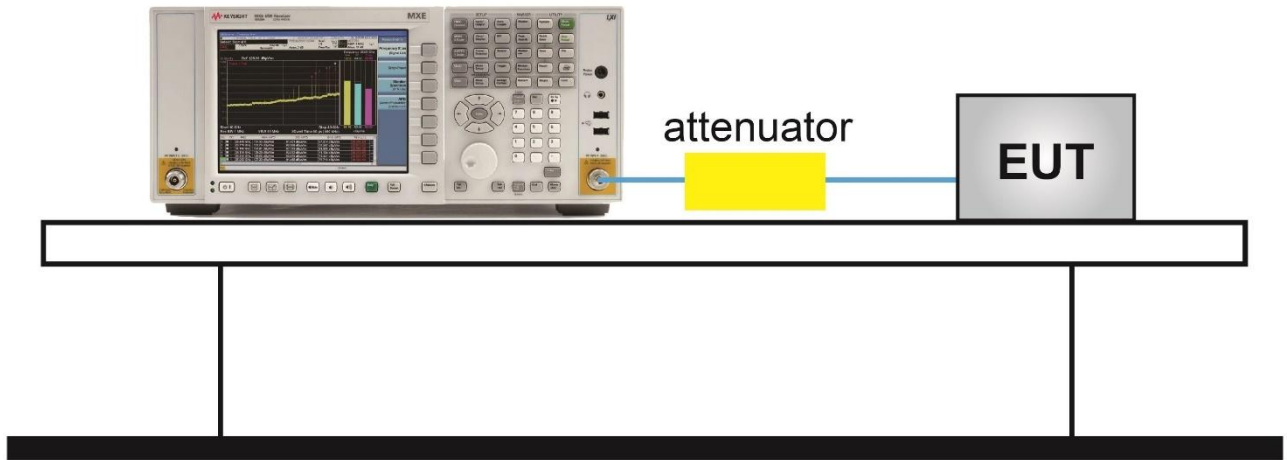



### 6.2.5. Test Result

Product	T-BOX	Test Engineer	Dandy Li
Test Site	TR3	Test Date	2020/09/24

Test Mode	Data Rate (Mbps)	Channel No.	Frequency (MHz)	6dB Bandwidth (MHz)	Limit (MHz)	99% Bandwidth (MHz)	Result
BLE	1	00	2402	0.708	≥ 0.5	1.067	Pass
BLE	1	19	2440	0.733	≥ 0.5	1.066	Pass
BLE	1	39	2480	0.714	≥ 0.5	1.063	Pass

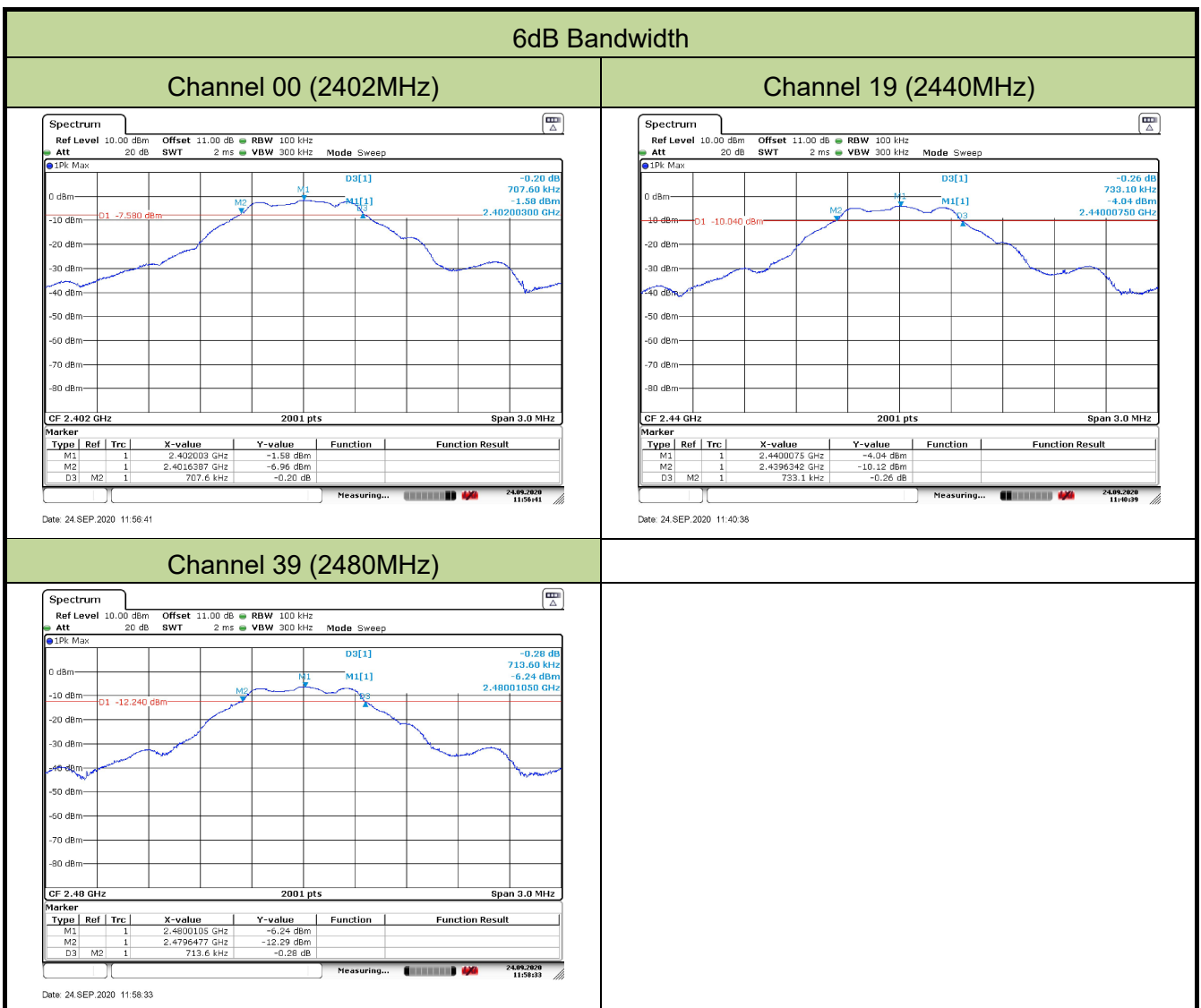

## 99% Bandwidth

## Channel 00 (2402MHz)

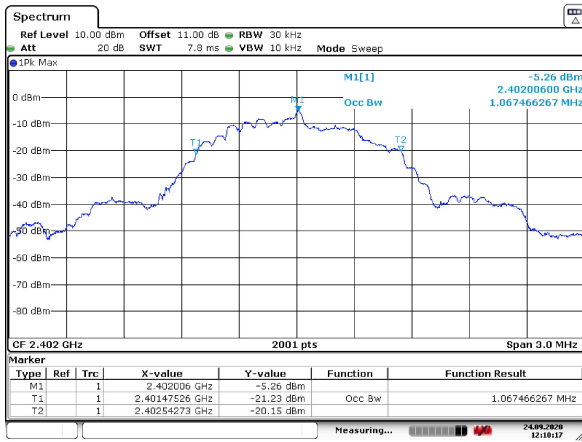

Date: 24 SEP 2020 12:10:18

## Channel 19 (2440MHz)

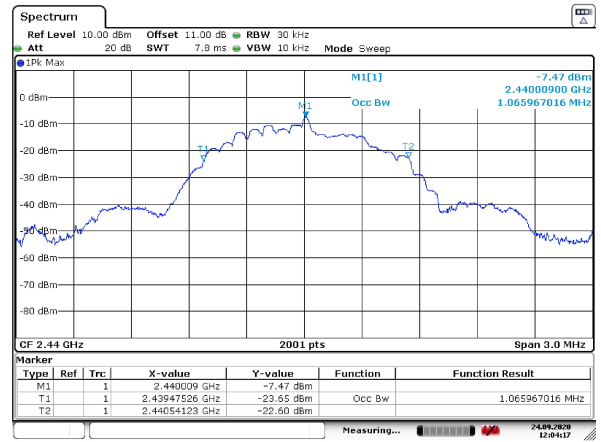

Date: 24 SEP 2020 12:04:18

## Channel 39 (2480MHz)

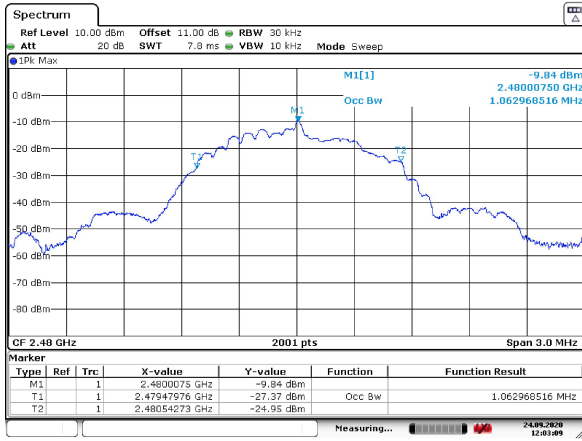

Date: 24 SEP 2020 12:03:10

### **6.3. Output Power Measurement**

#### **6.3.1. Test Limit**

The maximum out power shall be less 1 Watt (30dBm) and the E.I.R.P shall not exceed 4 Watt (36dBm).

#### **6.3.2. Test Procedure Used**

ANSI C63.10-2013 Section 11.9.1.3

ANSI C63.10-2013 Section 11.9.2.3.2

#### **6.3.3. Test Setting**

##### **PKPM1 Peak-reading power meter method**

The maximum peak conducted output power may be measured using a broadband peak RF power meter. The power meter shall have a video bandwidth that is greater than or equal to the DTS bandwidth and shall utilize a fast-responding diode detector.

##### **Method AVGPM-G (Measurement using a gated RF average-reading power meter)**

Measurements may be performed using a wideband gated RF power meter provided that the gate parameters are adjusted such that the power is measured only when the EUT is transmitting at its maximum power control level. Since this measurement is made only during the ON time of the transmitter, no duty cycle correction is required.

### 6.3.4. Test Setup

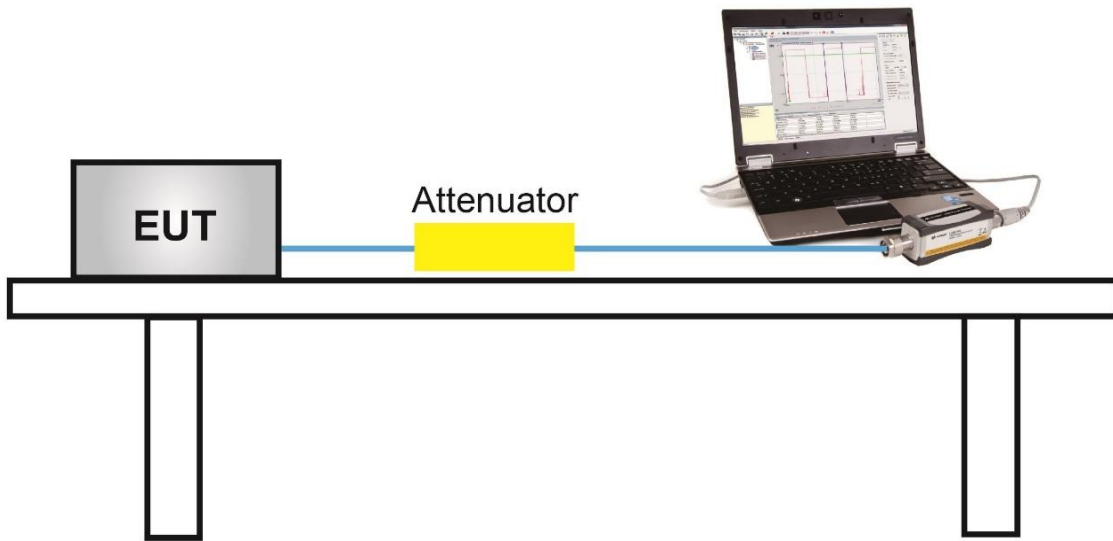

### 6.3.5. Test Result of Output Power

Product	T-BOX	Test Engineer	Dandy Li
Test Site	TR3	Test Date	2020/09/24

### Test Result of Peak Output Power

Test Mode	Data Rate (Mbps)	Channel No.	Frequency (MHz)	Peak Power (dBm)	Limit (dBm)	Max EIRP (dBm)	EIRP Limit (dBm)	Result
BLE	1	00	2402	-0.94	≤ 30.00	-2.20	≤ 36.00	Pass
BLE	1	19	2440	-3.02	≤ 30.00	-4.28	≤ 36.00	Pass
BLE	1	39	2480	-4.93	≤ 30.00	-6.19	≤ 36.00	Pass

Note: Max EIRP (dBm) = Peak Power (dBm) + Antenna Gain (dBi)

### Test Result of Average Output Power (Reporting Only)

Test Mode	Data Rate (Mbps)	Channel No.	Frequency (MHz)	Average Power (dBm)	Limit (dBm)	Max EIRP (dBm)	EIRP Limit (dBm)	Result
BLE	1	00	2402	-1.39	≤ 30.00	-2.65	≤ 36.00	Pass
BLE	1	19	2440	-3.69	≤ 30.00	-4.95	≤ 36.00	Pass
BLE	1	39	2480	-5.69	≤ 30.00	-6.95	≤ 36.00	Pass

Note: Max EIRP (dBm) = Average Power (dBm) + Antenna Gain (dBi)

## 6.4. Power Spectral Density Measurement

### 6.4.1. Test Limit

The maximum permissible power spectral density is 8dBm in any 3 kHz band.

The same method of determining the conducted output power shall be used to determine the power spectral density.

### 6.4.2. Test Procedure Used

ANSI C63.10-2013 Section 11.10.2

### 6.4.3. Test Setting

1. Analyzer was set to the center frequency of the DTS channel under investigation
2. Span = 1.5 times the DTS channel bandwidth
3. RBW = 3kHz
4. VBW = 10kHz
5. Detector = peak
6. Sweep time = auto couple
7. Trace mode = max hold
8. Trace was allowed to stabilize

### 6.4.4. Test Setup

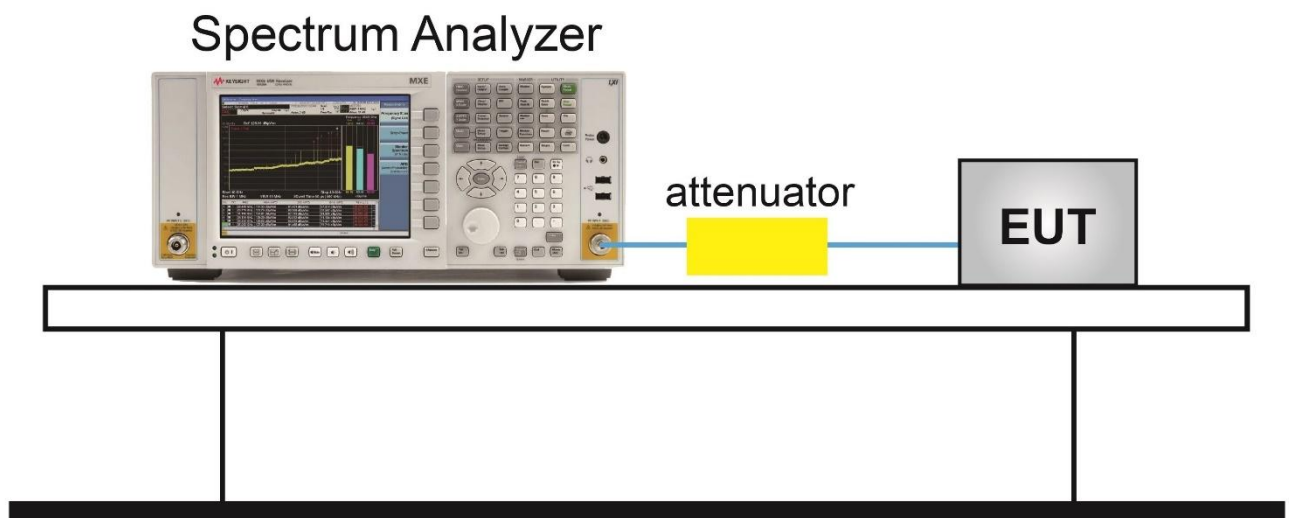

### 6.4.5. Test Result

Product	T-BOX	Test Engineer	Dandy Li
Test Site	TR3	Test Date	2020/09/24

Test Mode	Data Rate (Mbps)	Channel No.	Frequency (MHz)	PSD Result (dBm / 3kHz)	Limit (dBm / 3kHz)	Result
BLE	1	00	2402	-15.84	≤ 8.00	Pass
BLE	1	19	2440	-17.59	≤ 8.00	Pass
BLE	1	39	2480	-20.59	≤ 8.00	Pass

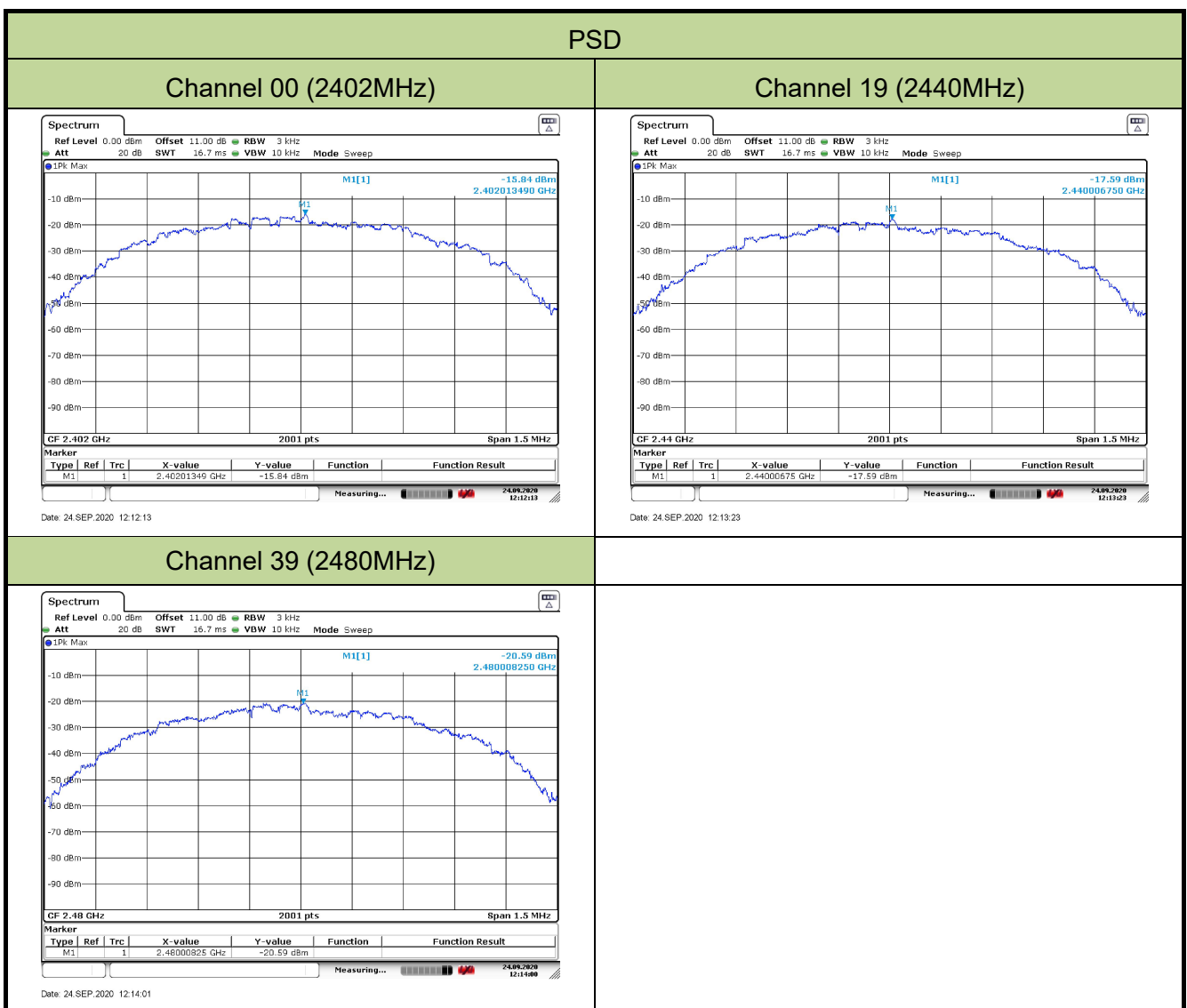

## **6.5. Conducted Band Edge and Out-of-Band Emissions**

### **6.5.1. Test Limit**

The limit for out-of-band spurious emissions at the band edge is 20dB below the fundamental emission level, as determined from the in-band power measurement of the DTS channel performed in a 100kHz bandwidth per the PSD procedure.

### **6.5.2. Test Procedure Used**

ANSI C63.10-2013 Section 11.11

### **6.5.3. Test Setting**

#### **Reference level measurement**

1. Set instrument center frequency to DTS channel center frequency
2. Set the span to  $\geq 1.5$  times the DTS bandwidth
3. Set the RBW = 100 kHz
4. Set the VBW  $\geq 3 \times$  RBW
5. Detector = peak
6. Sweep time = auto couple
7. Trace mode = max hold
8. Allow trace to fully stabilize

#### **Emission level measurement**

1. Set the center frequency and span to encompass frequency range to be measured
2. RBW = 100kHz
3. VBW = 300kHz
4. Detector = Peak
5. Trace mode = max hold
6. Sweep time = auto couple
7. The trace was allowed to stabilize



### 6.5.4. Test Setup

## Spectrum Analyzer

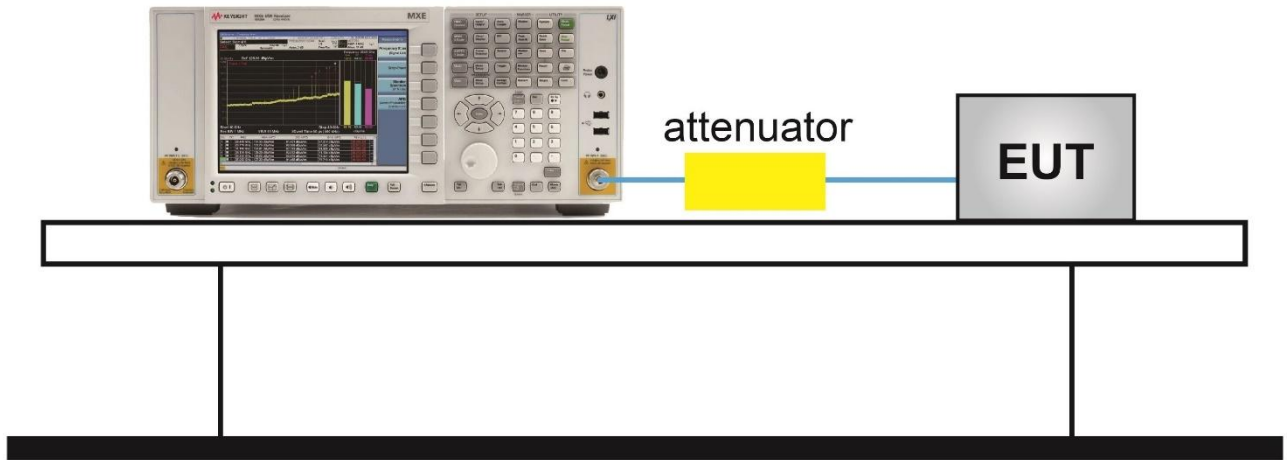

### 6.5.5. Test Result

Product	T-BOX	Test Engineer	Dandy Li
Test Site	TR3	Test Date	2020/09/24

Test Mode	Data Rate (Mbps)	Channel No.	Frequency (MHz)	Limit (dBm)	Result
BLE	1	00	2402	-21.59	Pass
BLE	1	19	2440	-24.05	Pass
BLE	1	39	2480	-26.25	Pass

Note: The limit is 20dB below the fundamental emission level.

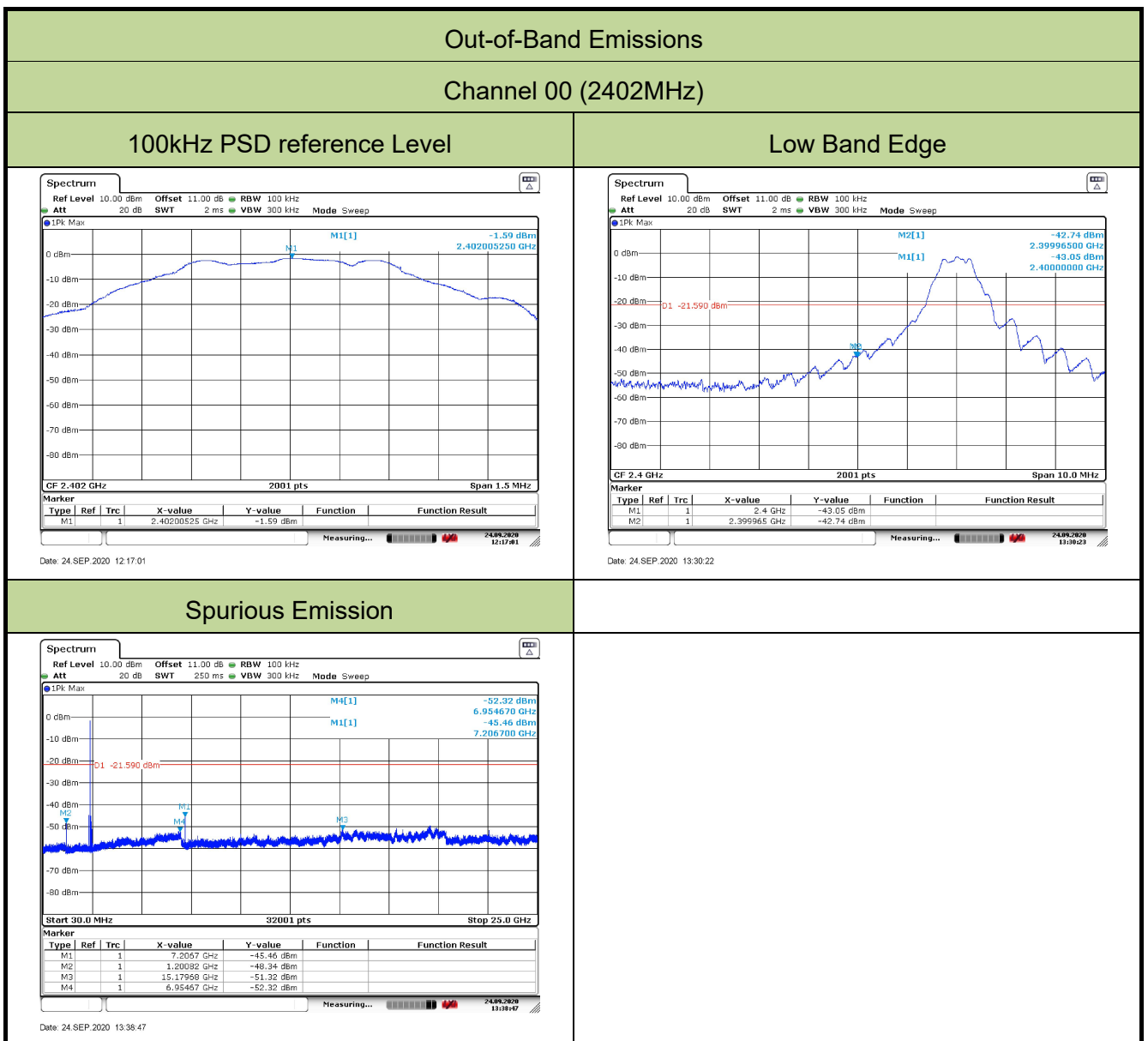

## Channel 19 (2440MHz)

## 100kHz PSD reference Level

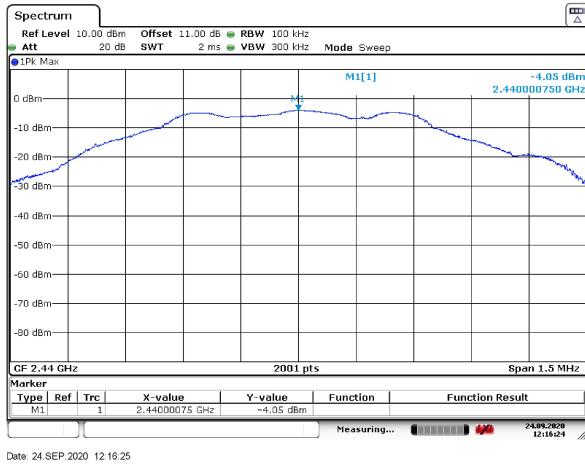

## Spurious Emission

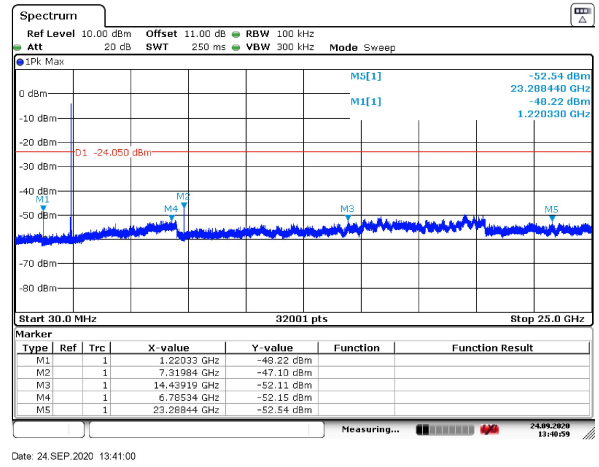

## Channel 39 (2480MHz)

## 100kHz PSD reference Level

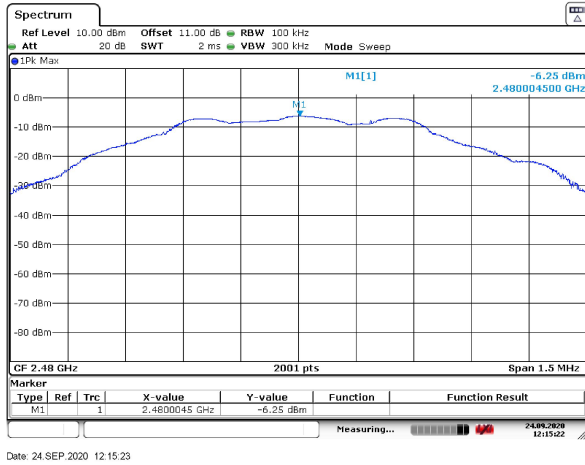

## High Band Edge

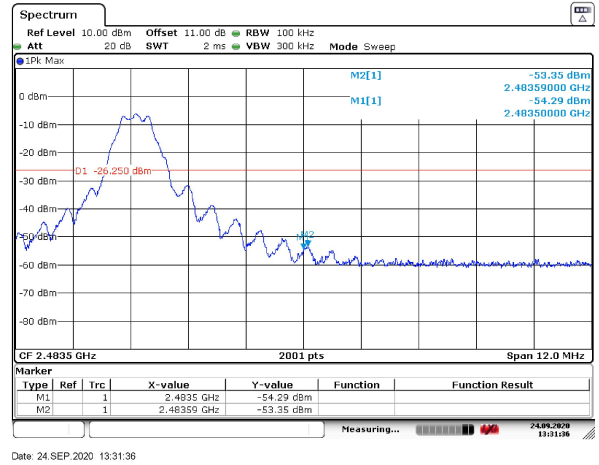

## Spurious Emission

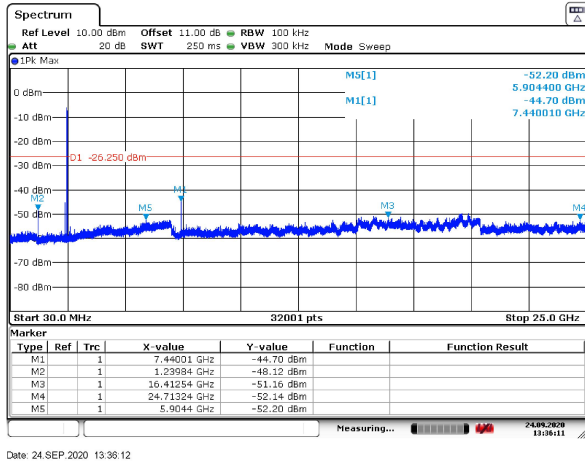

## 6.6. Radiated Spurious Emission Measurement

### 6.6.1. Test Limit

All out of band emissions appearing in a restricted band as specified in Section 15.205 of the Title 47 CFR must not exceed the limits shown in Table per Section 15.209.

FCC Part 15 Subpart C Paragraph 15.209		
Frequency [MHz]	Field Strength [ $\mu\text{V}/\text{m}$ ]	Measured Distance [Meters]
0.009 - 0.490	2400/F (kHz)	300
0.490 - 1.705	24000/F (kHz)	30
1.705 - 30	30	30
30 - 88	100	3
88 - 216	150	3
216 - 960	200	3
Above 960	500	3

All out of band emissions appearing in a restricted band as specified in Section 8.10 of the RSS-Gen must not exceed the limits shown in Table per Section 8.9.

RSS-Gen Section 8.9			
Frequency (MHz)	Field Strength ( $\mu\text{V}/\text{m}$ )	Magnetic Field Strength (H-Field) ( $\mu\text{A}/\text{m}$ )	Measured Distance (m)
0.009 - 0.490	--	6.37/F (F in kHz)	300
0.490 - 1.705	--	6.37/F (F in kHz)	30
1.705 - 30	--	0.08	30
30 - 88	100	--	3
88 - 216	150	--	3
216 - 960	200	--	3
Above 960	500	--	3

### 6.6.2. Test Procedure Used

ANSI C63.10-2013 Section 6.3 (General Requirements)

ANSI C63.10-2013 Section 6.4 (Standard test method below 30MHz)

ANSI C63.10-2013 Section 6.5 (Standard test method above 30MHz to 1GHz)

ANSI C63.10-2013 Section 6.6 (Standard test method above 1GHz)

### 6.6.3. Test Setting

**Table 1 - RBW as a function of frequency**

Frequency	RBW
9 ~ 150 kHz	200 ~ 300 Hz
0.15 ~ 30 MHz	9 ~ 10 kHz
30 ~ 1000 MHz	100 ~ 120 kHz
> 1000MHz	1MHz

#### **Quasi-Peak Measurements below 1GHz**

1. Analyzer center frequency was set to the frequency of the radiated spurious emission of interest
2. Span was set greater than 1MHz
3. RBW = as specified in Table 1
4. Detector = CISPR quasi-peak
5. Sweep time = auto couple
6. Trace was allowed to stabilize

#### **Peak Measurements above 1GHz**

1. Analyzer center frequency was set to the frequency of the radiated spurious emission of interest
2. RBW = 1MHz
3. VBW = 3MHz
4. Detector = peak
5. Sweep time = auto couple

6. Trace mode = max hold

7. Trace was allowed to stabilize

### **Average Measurements above 1GHz (Method VB)**

1. Analyzer center frequency was set to the frequency of the radiated spurious emission of interest

2. RBW = 1MHz

3. VBW; If the EUT is configured to transmit with duty cycle  $\geq 98\%$ , set VBW = 10 Hz.

If the EUT duty cycle is  $< 98\%$ , set VBW  $\geq 1/T$ . T is the minimum transmission duration.

4. Detector = Peak

5. Sweep time = auto

6. Trace mode = max hold

7. Trace was allowed to stabilize

### **6.6.4. Test Setup**

#### **Below 1GHz Test Setup:**

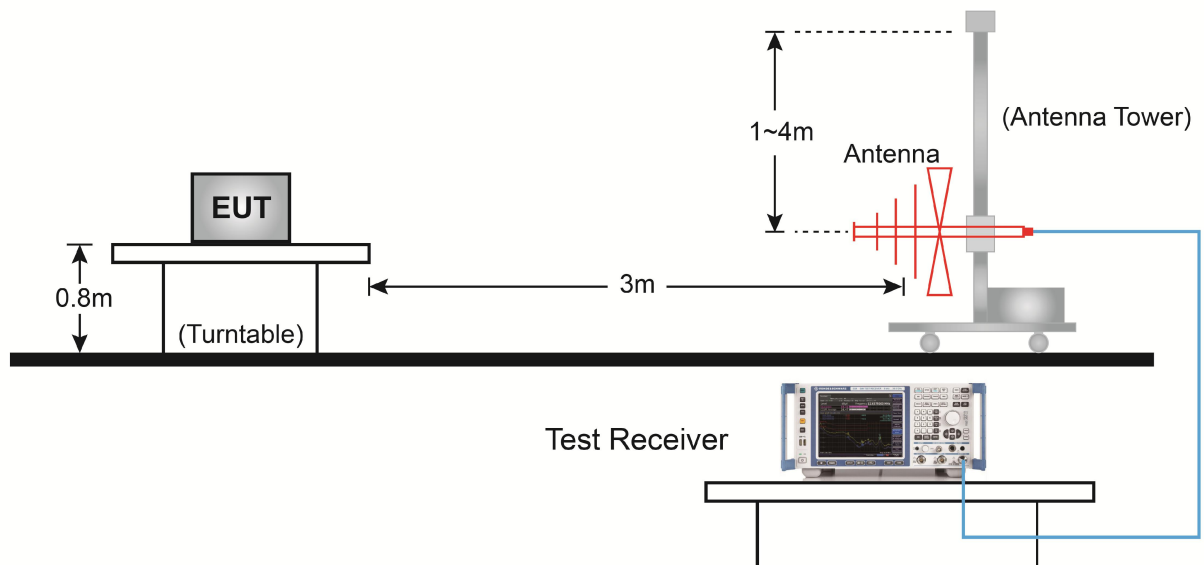

Above 1GHz Test Setup:

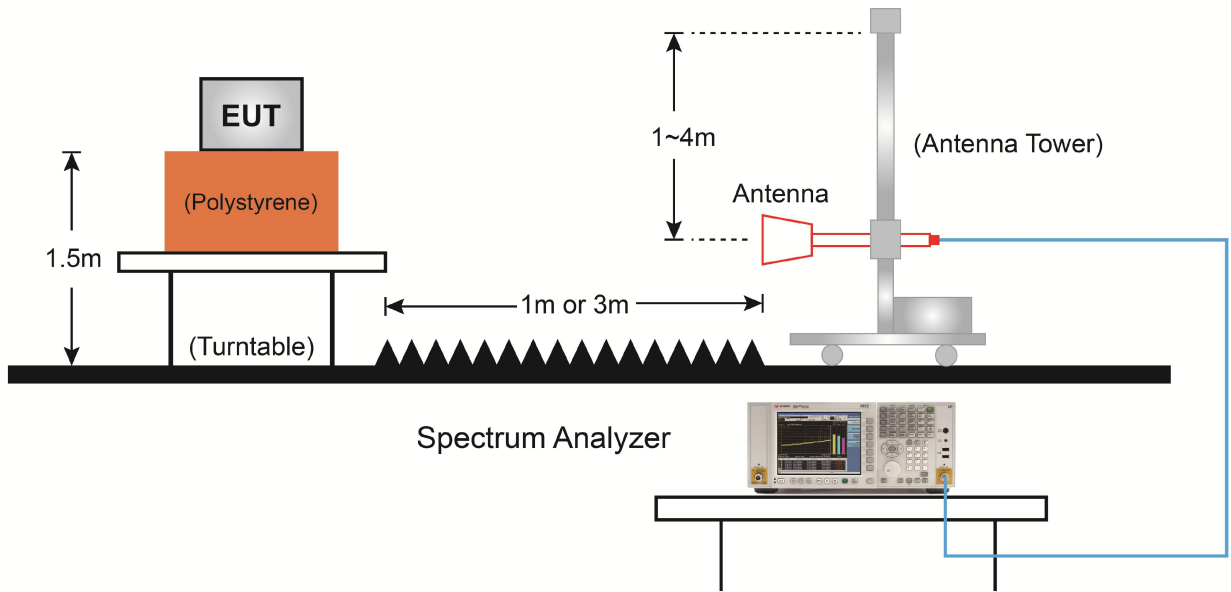

**6.6.5. Test Result**

Product	T-BOX	Test Engineer	David Lv
Test Site	AC1	Test Date	2020/09/27
Test Mode:	BLE	Test Channel:	00
Remark:	1. Average measurement was not performed if peak level lower than average limit. 2. Other frequency was 20dB below limit line within 1-18GHz, there is not show in the report.		

Mark	Frequency (MHz)	Reading Level (dB $\mu$ V)	Factor (dB)	Measure Level (dB $\mu$ V/m)	Limit (dB $\mu$ V/m)	Margin (dB)	Detector	Polarization
	3992.0	37.8	3.5	41.3	74.0	-32.7	Peak	Horizontal
	4799.5	41.9	5.9	47.8	74.0	-26.2	Peak	Horizontal
*	7205.0	39.0	10.5	49.5	74.0	-24.5	Peak	Horizontal
*	8862.5	37.2	12.9	50.1	74.0	-23.9	Peak	Horizontal
	4000.5	39.5	3.4	42.9	74.0	-31.1	Peak	Vertical
	4799.5	41.0	5.9	46.9	74.0	-27.1	Peak	Vertical
*	7205.0	40.0	10.5	50.5	74.0	-23.5	Peak	Vertical
*	8565.0	37.3	12.0	49.3	74.0	-24.7	Peak	Vertical

Note 1: "\*" means test frequency did not fall into restricted band.

Note 2: Measure Level (dB $\mu$ V/m) = Reading Level (dB $\mu$ V) + Factor (dB)

Factor (dB) = Cable Loss (dB) + Antenna Factor (dB/m) - Pre\_Amplifier Gain (dB)



Product	T-BOX	Test Engineer	David Lv
Test Site	AC1	Test Date	2020/09/27
Test Mode:	BLE	Test Channel:	19
Remark:	1. Average measurement was not performed if peak level lower than average limit. 2. Other frequency was 20dB below limit line within 1-18GHz, there is not show in the report.		

Mark	Frequency (MHz)	Reading Level (dBμV)	Factor (dB)	Measure Level (dBμV/m)	Limit (dBμV/m)	Margin (dB)	Detector	Polarization
	4876.0	40.7	5.5	46.2	74.0	-27.8	Peak	Horizontal
	7315.5	40.8	10.6	51.4	74.0	-22.6	Peak	Horizontal
*	7944.5	37.3	11.5	48.8	74.0	-25.2	Peak	Horizontal
*	8658.5	36.5	12.8	49.3	74.0	-24.7	Peak	Horizontal
	4876.0	40.1	5.5	45.6	74.0	-28.4	Peak	Vertical
	7315.5	40.5	10.6	51.1	74.0	-22.9	Peak	Vertical
*	7893.5	37.0	11.0	48.0	74.0	-26.0	Peak	Vertical
*	8692.5	36.6	13.1	49.7	74.0	-24.3	Peak	Vertical

Note 1: "\*" means test frequency did not fall into restricted band.

Note 2: Measure Level (dBμV/m) = Reading Level (dBμV) + Factor (dB)

Factor (dB) = Cable Loss (dB) + Antenna Factor (dB/m) - Pre\_Amplifier Gain (dB)

Product	T-BOX	Test Engineer	David Lv
Test Site	AC1	Test Date	2020/09/27
Test Mode:	BLE	Test Channel:	39
Remark:	1. Average measurement was not performed if peak level lower than average limit. 2. Other frequency was 20dB below limit line within 1-18GHz, there is not show in the report.		

Mark	Frequency (MHz)	Reading Level (dBμV)	Factor (dB)	Measure Level (dBμV/m)	Limit (dBμV/m)	Margin (dB)	Detector	Polarization
	4961.0	40.5	5.9	46.4	74.0	-27.6	Peak	Horizontal
	7443.0	44.4	11.0	55.4	74.0	-18.6	Peak	Horizontal
	7443.0	39.7	11.0	50.7	54.0	-3.3	Average	Horizontal
*	7944.5	37.5	11.5	49.0	74.0	-25.0	Peak	Horizontal
*	8658.5	36.3	12.8	49.1	74.0	-24.9	Peak	Horizontal
	4961.0	43.7	5.9	49.6	74.0	-24.4	Peak	Vertical
	7443.0	45.1	11.0	56.1	74.0	-17.9	Peak	Vertical
	7443.0	40.7	11.0	51.7	54.0	-2.3	Average	Vertical
*	7885.0	37.0	11.1	48.1	74.0	-25.9	Peak	Vertical
*	8650.0	36.8	12.9	49.7	74.0	-24.3	Peak	Vertical

Note 1: "\*" means test frequency did not fall into restricted band.

Note 2: Measure Level (dBμV/m) = Reading Level (dBμV) + Factor (dB)

Factor (dB) = Cable Loss (dB) + Antenna Factor (dB/m) - Pre\_Amplifier Gain (dB)

**The worst case of Radiated Emission below 1GHz:**

Site: AC1	Time: 2020/09/28 - 03:52
Limit: FCC_Part15.209_RE(3m)	Engineer: David Lv
Probe: AC1_VULB 9168 _30-1000MHz	Polarity: Horizontal
EUT: T-BOX	Power: DC 12V
<b>Test Mode:</b> Transmit by BLE at channel 2402MHz	

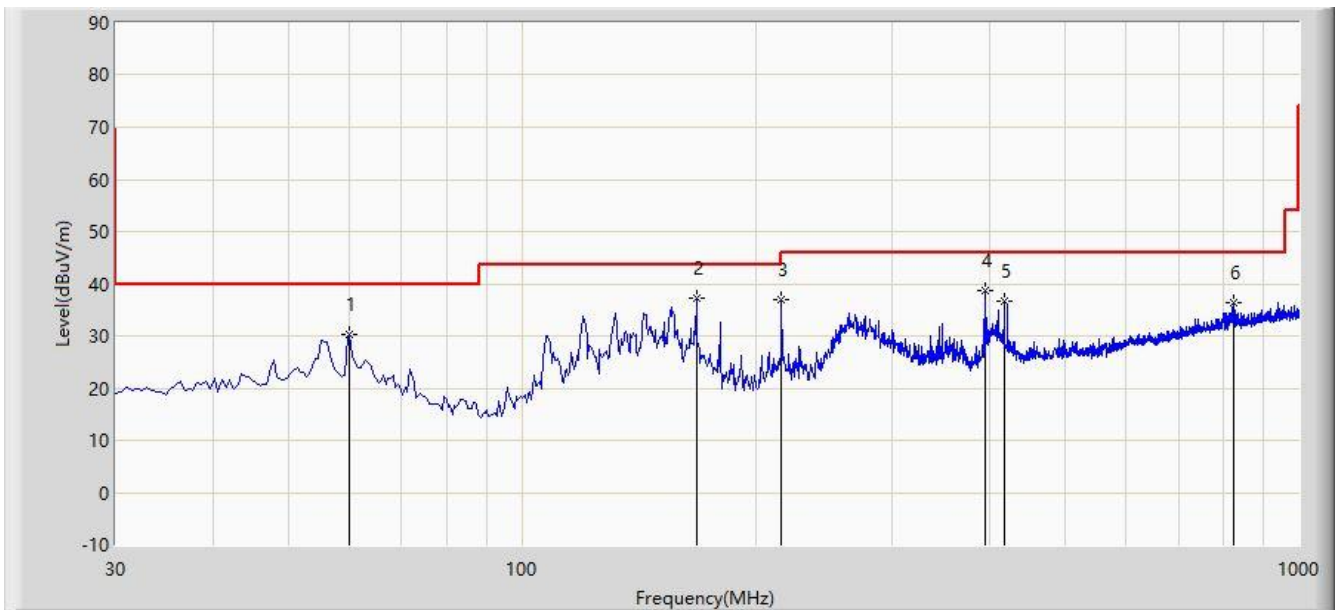

No	Flag	Mark	Frequency (MHz)	Measure Level (dBuV/m)	Reading Level (dBuV)	Margin (dB)	Limit (dBuV/m)	Factor (dB)	Type
1			60.070	30.296	12.798	-9.704	40.000	17.498	PK
2		*	167.740	37.150	19.427	-6.350	43.500	17.723	PK
3			215.755	37.096	22.358	-6.404	43.500	14.738	PK
4			395.690	38.569	17.491	-7.431	46.000	21.078	PK
5			418.000	36.695	15.156	-9.305	46.000	21.539	PK
6			824.430	36.512	7.388	-9.488	46.000	29.124	PK

Note 1: Measure Level (dB $\mu$ V/m) = Reading Level (dB $\mu$ V) + Factor (dB)

Factor (dB) = Cable Loss (dB) + Antenna Factor (dB/m)

Note 2: QP measurement was not performed when peak measure level was lower than the QP limit by more than 6dB.

Note 3: The amplitude of radiated emissions (frequency range from 9kHz to 30MHz and 18GHz to 25GHz) is that proximity to ambient noise, which also are attenuated more than 20 dB below the permissible value.

Therefore, the data is not presented in the report.

Site: AC1	Time: 2020/09/28 - 04:02
Limit: FCC_Part15.209_RE(3m)	Engineer: David Lv
Probe: AC1_VULB 9168 _30-1000MHz	Polarity: Vertical
EUT: T-BOX	Power: DC 12V
<b>Test Mode:</b> Transmit by BLE at channel 2402MHz	

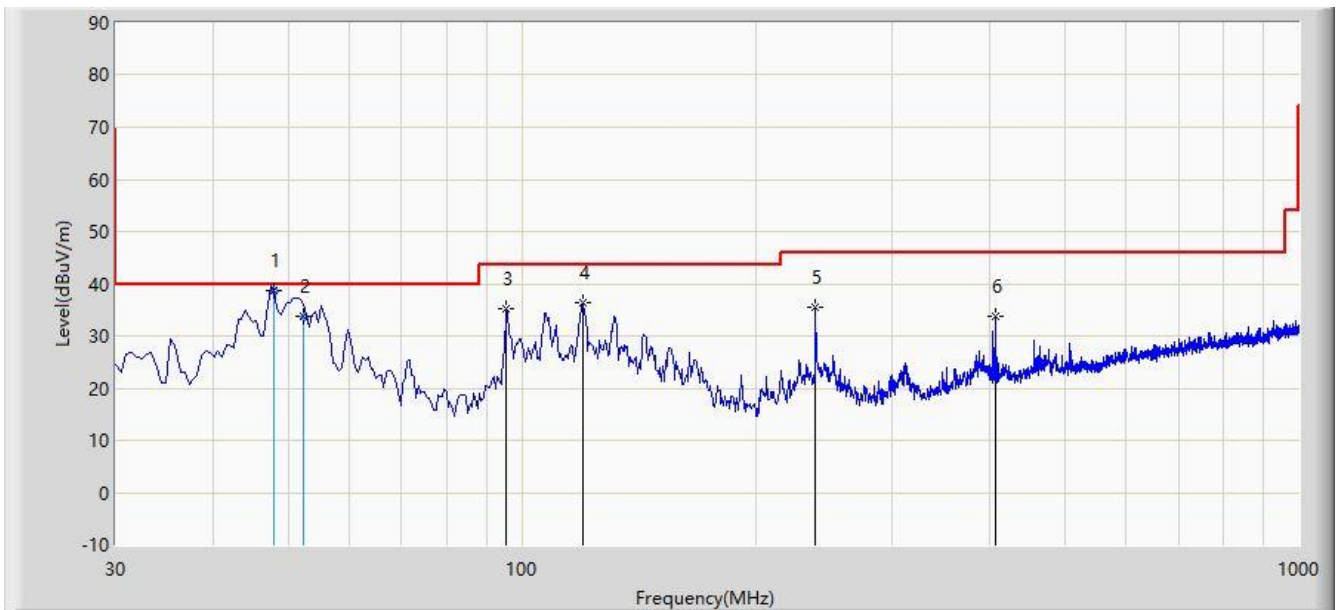

No	Flag	Mark	Frequency (MHz)	Measure Level (dBuV/m)	Reading Level (dBuV)	Margin (dB)	Limit (dBuV/m)	Factor (dB)	Type
1		*	47.967	38.813	20.800	-1.187	40.000	18.013	QP
2			52.410	33.797	15.700	-6.203	40.000	18.098	QP
3			95.475	35.310	22.571	-8.190	43.500	12.739	PK
4			119.725	36.510	20.616	-6.990	43.500	15.894	PK
5			239.035	35.630	19.069	-10.370	46.000	16.561	PK
6			406.845	33.677	12.359	-12.323	46.000	21.317	PK

Note 1: Measure Level (dB $\mu$ V/m) = Reading Level (dB $\mu$ V) + Factor (dB)

Factor (dB) = Cable Loss (dB) + Antenna Factor (dB/m)

Note 2: QP measurement was not performed when peak measure level was lower than the QP limit by more than 6dB.

Note 3: The amplitude of radiated emissions (frequency range from 9kHz to 30MHz and 18GHz to 25GHz) is that proximity to ambient noise, which also are attenuated more than 20 dB below the permissible value.

Therefore, the data is not presented in the report.

## 6.7. Radiated Restricted Band Edge Measurement

### 6.7.1. Test Limit

#### For 15.205 requirement:

Radiated emissions which fall in the restricted bands, as defined in Section 15.205(a) of FCC part 15, must also comply with the radiated emission limits specified in Section 15.209(a).

Frequency (MHz)	Frequency (MHz)	Frequency (MHz)	Frequency (GHz)
0.090 - 0.110	16.42 - 16.423	399.9 - 410	4.5 - 5.15
<sup>1</sup> 0.495 - 0.505	16.69475 - 16.69525	608 - 614	5.35 - 5.46
2.1735 - 2.1905	16.80425 - 16.80475	960 - 1240	7.25 - 7.75
4.125 - 4.128	25.5 - 25.67	1300 - 1427	8.025 - 8.5
4.17725 - 4.17775	37.5 - 38.25	1435 - 1626.5	9.0 - 9.2
4.20725 - 4.20775	73 - 74.6	1645.5 - 1646.5	9.3 - 9.5
6.215 - 6.218	74.8 - 75.2	1660 - 1710	10.6 - 12.7
6.26775 - 6.26825	108 - 121.94	1718.8 - 1722.2	13.25 - 13.4
6.31175 - 6.31225	123 - 138	2200 - 2300	14.47 - 14.5
8.291 - 8.294	149.9 - 150.05	2310 - 2390	15.35 - 16.2
8.362 - 8.366	156.52475 - 156.52525	2483.5 - 2500	17.7 - 21.4
8.37625 - 8.38675	156.7 - 156.9	2690 - 2900	22.01 - 23.12
8.41425 - 8.41475	162.0125 - 167.17	3260 - 3267	23.6 - 24.0
12.29 - 12.293	167.72 - 173.2	3332 - 3339	31.2 - 31.8
12.51975 - 12.52025	240 - 285	3345.8 - 3358	36.43 - 36.5
12.57675 - 12.57725	322 - 335.4	3600 - 4400	( <sup>2</sup> )
13.36 - 13.41	--	--	--

All out of band emissions appearing in a restricted band as specified in Section 15.205 of the Title 47CFR must not exceed the limits shown in Table per Section 15.209.

FCC Part 15 Subpart C Paragraph 15.209		
Frequency [MHz]	Field Strength [uV/m]	Measured Distance [Meters]
0.009 - 0.490	2400/F (kHz)	300
0.490 - 1.705	24000/F (kHz)	30
1.705 - 30	30	30
30 - 88	100	3
88 - 216	150	3
216 - 960	200	3
Above 960	500	3

### **For RSS-Gen Section 8.10 Requirement**

Radiated emissions which fall in the restricted bands, as defined in Section 8.10 of RSS-Gen, must also comply with the radiated emission limits specified in Section 8.9.

Frequency (MHz)	Frequency (MHz)	Frequency (GHz)
0.090 - 0.110	149.9 - 150.05	9.0 - 9.2
0.495 - 0.505	156.52475 - 156.52525	9.3 - 9.5
2.1735 - 2.1905	156.7 - 156.9	10.6 - 12.7
3.020 - 3.026	162.0125 - 167.17	13.25 - 13.4
4.125 - 4.128	167.72 - 173.2	14.47 - 14.5
4.17725 - 4.17775	240 - 285	15.35 - 16.2
4.20725 - 4.20775	322 - 335.4	17.7 - 21.4
5.677 - 5.683	399.9 - 410	22.01 - 23.12
6.215 - 6.218	608 - 614	23.6 - 24.0
6.26775 - 6.26825	960 - 1427	31.2 - 31.8
6.31175 - 6.31225	1435 - 1626.5	36.43 - 36.5
8.291 - 8.294	1645.5 - 1646.5	Above 38.6
8.362 - 8.366	1660 - 1710	--
8.37625 - 8.38675	1718.8 - 1722.2	
8.41425 - 8.41475	2200 - 2300	
12.29 - 12.293	2310 - 2390	
12.51975 - 12.52025	2483.5 - 2500	
12.57675 - 12.57725	2655 - 2900	
13.36 - 13.41	3260 - 3267	
16.42 - 16.423	3332 - 3339	
16.69475 - 16.69525	3345.8 - 3358	
16.80425 - 16.80475	3500 - 4400	
25.5 - 25.67	4500 - 5150	
37.5 - 38.25	5350 - 5460	
73 - 74.6	7250 - 7750	
74.8 - 75.2	8025 - 8500	
108 - 138		

All out of band emissions appearing in a restricted band as specified in Section 15.205 of the Title 47CFR and in Section 8.10 of the RSS-Gen must not exceed the limits shown in Table.

RSS-Gen Section 8.9			
Frequency (MHz)	Field Strength ( $\mu\text{V}/\text{m}$ )	Magnetic Field Strength (H-Field) ( $\mu\text{A}/\text{m}$ )	Measured Distance (m)
0.009 - 0.490	--	6.37/F (F in kHz)	300
0.490 - 1.705	--	6.37/F (F in kHz)	30
1.705 - 30	--	0.08	30
30 - 88	100	--	3
88 - 216	150	--	3
216 - 960	200	--	3
Above 960	500	--	3

### 6.7.2. Test Procedure Used

ANSI C63.10-2013 Section 6.3 (General Requirements)

ANSI C63.10-2013 Section 6.6 (Standard test method above 1GHz)

### 6.7.3. Test Setting

#### Peak Field Strength Measurements

1. Analyzer center frequency was set to the frequency of the radiated spurious emission of interest
2. RBW = 1MHz
3. VBW = 3MHz
4. Detector = peak
5. Sweep time = auto couple
6. Trace mode = max hold
7. Trace was allowed to stabilize



### Average Field Strength Measurements

1. Analyzer center frequency was set to the frequency of the radiated spurious emission of interest
2. RBW = 1MHz
3. VBW  $\geq 1/T$
4. De As an alternative, the instrument may be set to linear detector mode. Ensure that video filtering is applied in linear voltage domain (rather than in a log or dB domain). Some instruments require linear display mode in order to accomplish this. Others have a setting for Average-VBW Type, which can be set to "Voltage" regardless of the display mode
5. Detector = Peak
6. Sweep time = auto
7. Trace mode = max hold
8. Allow max hold to run for at least 50 times (1/duty cycle) traces

#### 6.7.4. Test Setup

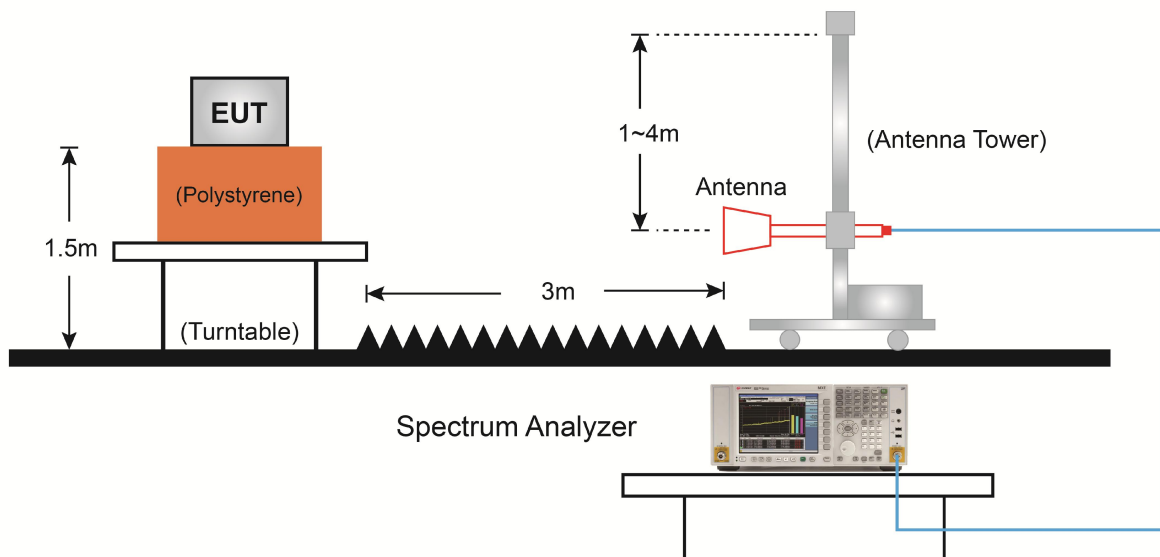

### 6.7.5. Test Result

Site: AC1	Time: 2020/09/30 - 14:29
Limit: FCC_Part15.209_RE(3m)	Engineer: David Lv
Probe: AC1_BBHA9120D_1-18GHz	Polarity: Horizontal
EUT: T-BOX	Power: DC 12V
Test Mode: Transmit by BLE at Channel 2402MHz	

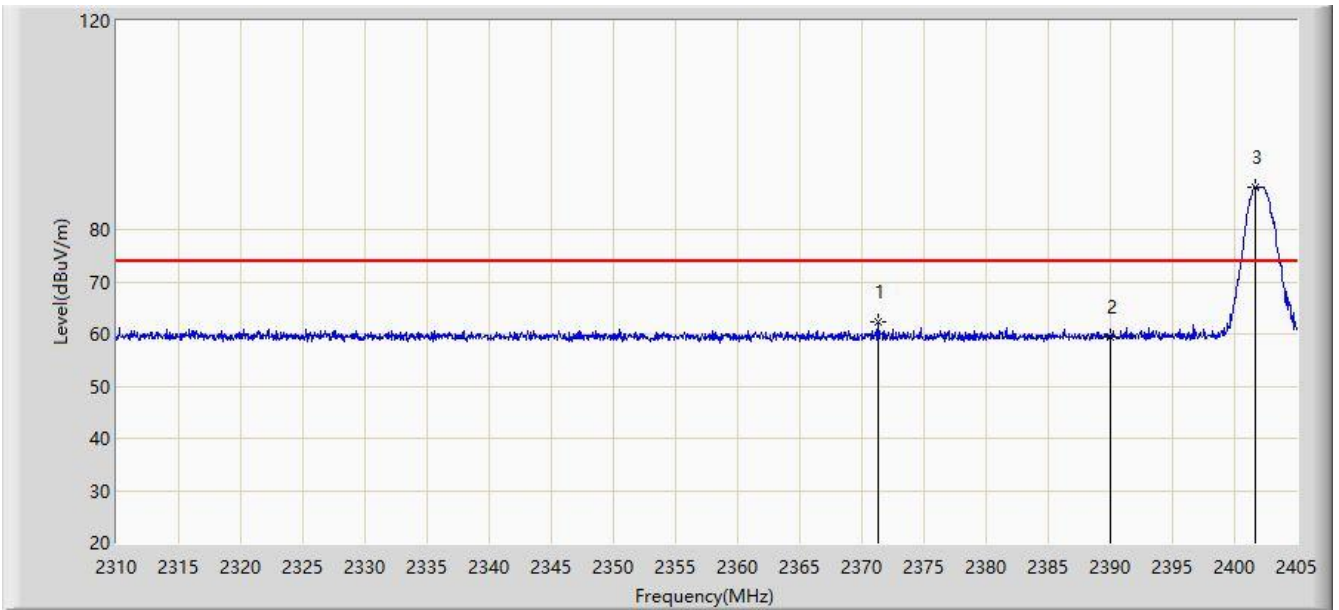

No	Flag	Mark	Frequency (MHz)	Measure Level (dBuV/m)	Reading Level (dBuV)	Margin (dB)	Limit (dBuV/m)	Factor (dB)	Type
1			2371.323	62.264	29.556	-11.736	74.000	32.708	PK
2			2390.000	59.498	26.786	-14.502	74.000	32.712	PK
3		*	2401.675	88.194	55.450	N/A	N/A	32.744	PK

Note: Measure Level (dB $\mu$ V/m) = Reading Level (dB $\mu$ V) + Factor (dB)

Factor (dB) = Cable Loss (dB) + Antenna Factor (dB/m).

Site: AC1	Time: 2020/09/30 - 14:32
Limit: FCC_Part15.209_RE(3m)	Engineer: David Lv
Probe: AC1_BBHA9120D_1-18GHz	Polarity: Horizontal
EUT: T-BOX	Power: DC 12V
Test Mode: Transmit by BLE at Channel 2402MHz	

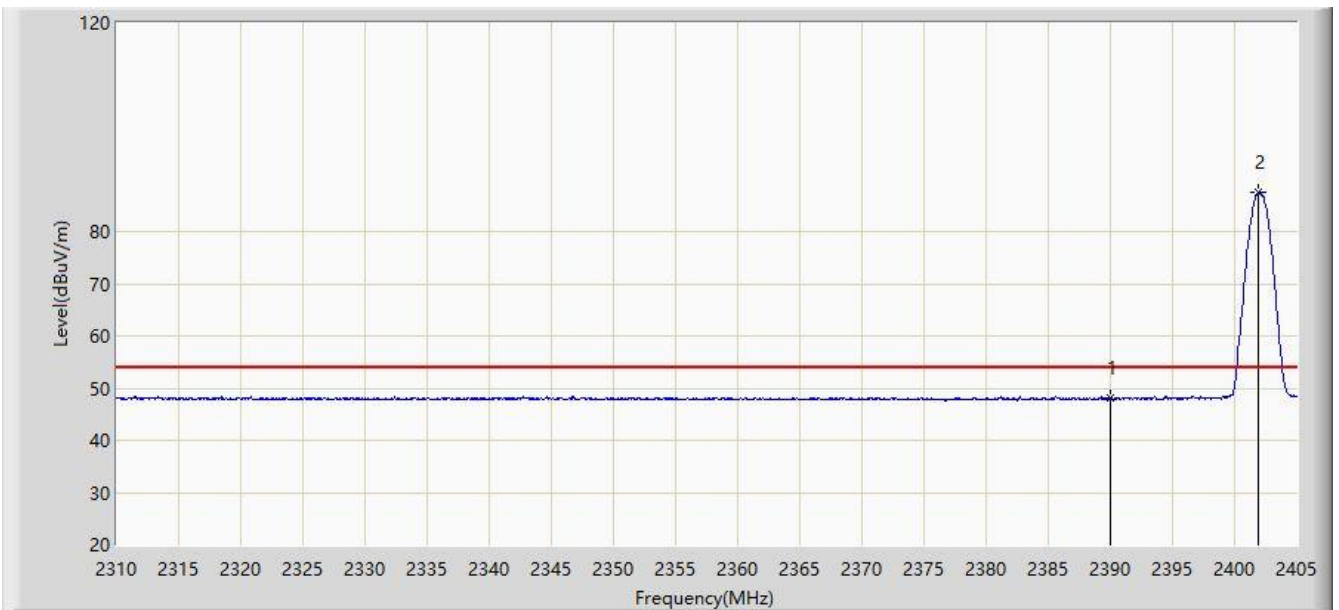

No	Flag	Mark	Frequency (MHz)	Measure Level (dBuV/m)	Reading Level (dBuV)	Margin (dB)	Limit (dBuV/m)	Factor (dB)	Type
1			2390.000	48.083	15.371	-5.917	54.000	32.712	AV
2		*	2401.960	87.564	54.820	N/A	N/A	32.744	AV

Note: Measure Level (dB $\mu$ V/m) = Reading Level (dB $\mu$ V) + Factor (dB)

Factor (dB) = Cable Loss (dB) + Antenna Factor (dB/m).

Site: AC1	Time: 2020/09/30 - 14:34
Limit: FCC_Part15.209_RE(3m)	Engineer: David Lv
Probe: AC1_BBHA9120D_1-18GHz	Polarity: Vertical
EUT: T-BOX	Power: DC 12V
Test Mode: Transmit by BLE at Channel 2402MHz	

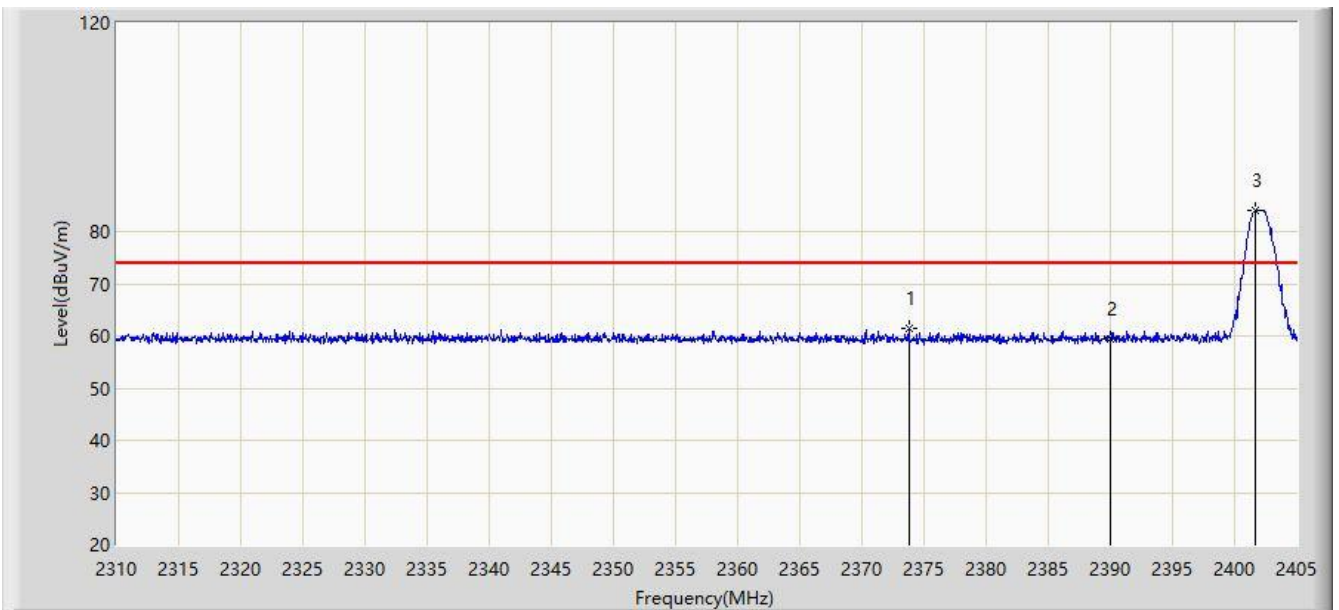

No	Flag	Mark	Frequency (MHz)	Measure Level (dBuV/m)	Reading Level (dBuV)	Margin (dB)	Limit (dBuV/m)	Factor (dB)	Type
1			2373.792	61.476	28.781	-12.524	74.000	32.694	PK
2			2390.000	59.565	26.853	-14.435	74.000	32.712	PK
3		*	2401.675	84.180	51.436	N/A	N/A	32.744	PK

Note: Measure Level (dB $\mu$ V/m) = Reading Level (dB $\mu$ V) + Factor (dB)

Factor (dB) = Cable Loss (dB) + Antenna Factor (dB/m).

Site: AC1	Time: 2020/09/30 - 14:33
Limit: FCC_Part15.209_RE(3m)	Engineer: David Lv
Probe: AC1_BBHA9120D_1-18GHz	Polarity: Vertical
EUT: T-BOX	Power: DC 12V
Test Mode: Transmit by BLE at Channel 2402MHz	

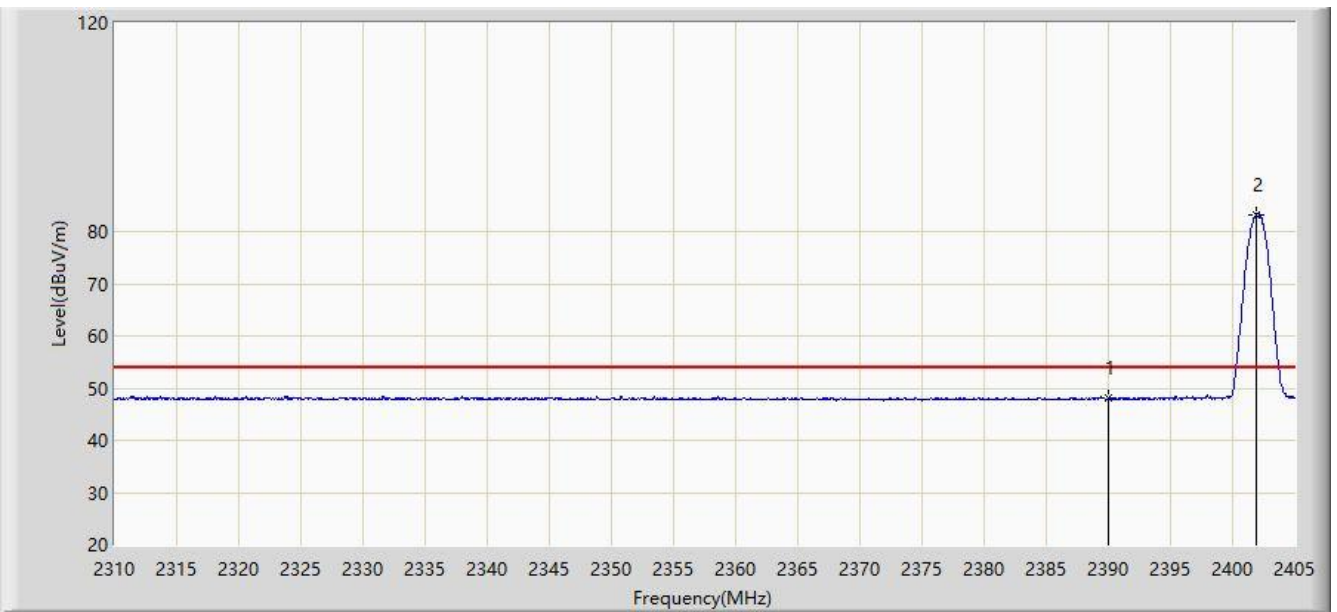

No	Flag	Mark	Frequency (MHz)	Measure Level (dBuV/m)	Reading Level (dBuV)	Margin (dB)	Limit (dBuV/m)	Factor (dB)	Type
1			2390.000	47.982	15.270	-6.018	54.000	32.712	AV
2		*	2401.913	83.307	50.563	N/A	N/A	32.744	AV

Note: Measure Level (dB $\mu$ V/m) = Reading Level (dB $\mu$ V) + Factor (dB)

Factor (dB) = Cable Loss (dB) + Antenna Factor (dB/m).

Site: AC1	Time: 2020/09/30 - 14:36
Limit: FCC_Part15.209_RE(3m)	Engineer: David Lv
Probe: AC1_BBHA9120D_1-18GHz	Polarity: Horizontal
EUT: T-BOX	Power: DC 12V
Test Mode: Transmit by BLE at Channel 2480MHz	

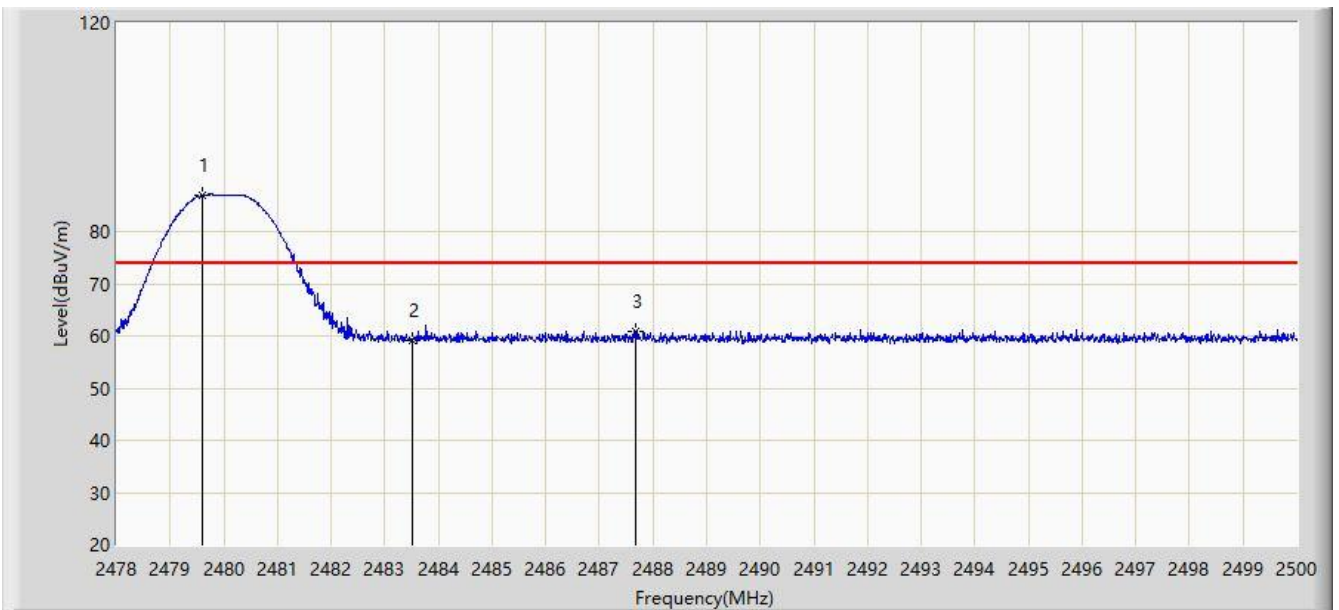

No	Flag	Mark	Frequency (MHz)	Measure Level (dBuV/m)	Reading Level (dBuV)	Margin (dB)	Limit (dBuV/m)	Factor (dB)	Type
1		*	2479.606	86.953	54.269	N/A	N/A	32.684	PK
2			2483.500	59.243	26.593	-14.757	74.000	32.651	PK
3			2487.669	60.960	28.345	-13.040	74.000	32.615	PK

Note: Measure Level (dB $\mu$ V/m) = Reading Level (dB $\mu$ V) + Factor (dB)

Factor (dB) = Cable Loss (dB) + Antenna Factor (dB/m).

Site: AC1	Time: 2020/09/30 - 14:39
Limit: FCC_Part15.209_RE(3m)	Engineer: David Lv
Probe: AC1_BBHA9120D_1-18GHz	Polarity: Horizontal
EUT: T-BOX	Power: DC 12V
Test Mode: Transmit by BLE at Channel 2480MHz	

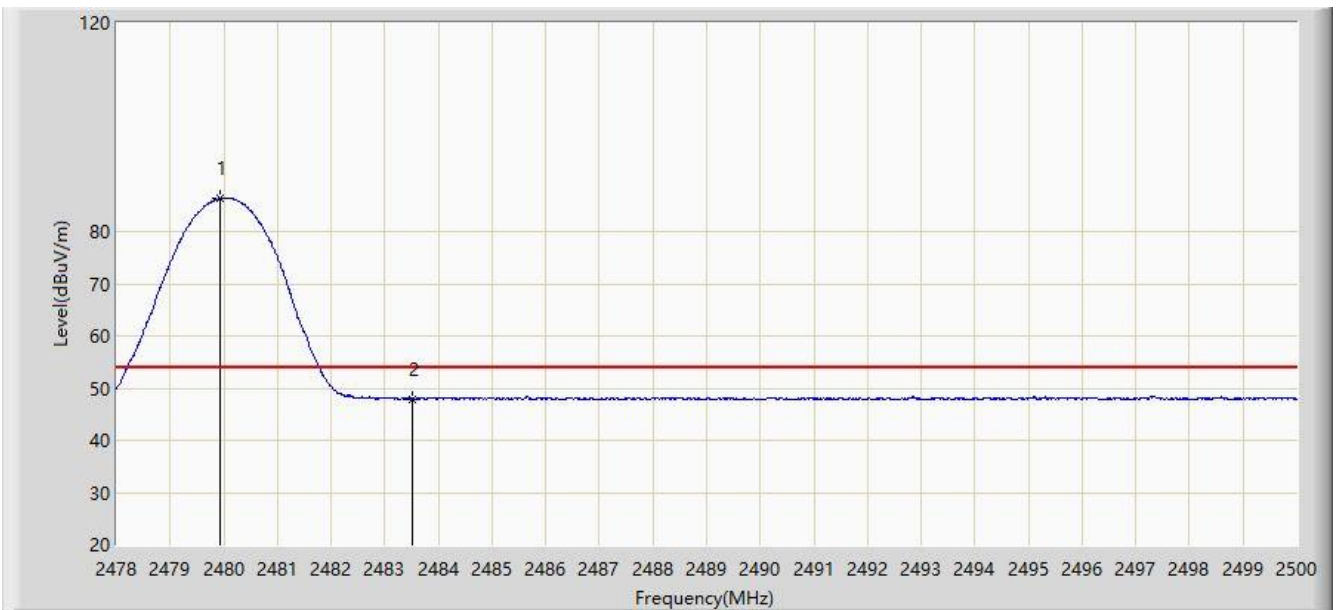

No	Flag	Mark	Frequency (MHz)	Measure Level (dBuV/m)	Reading Level (dBuV)	Margin (dB)	Limit (dBuV/m)	Factor (dB)	Type
1		*	2479.936	86.312	53.631	N/A	N/A	32.682	AV
2			2483.500	47.932	15.282	-6.068	54.000	32.651	AV

Note: Measure Level (dB $\mu$ V/m) = Reading Level (dB $\mu$ V) + Factor (dB)

Factor (dB) = Cable Loss (dB) + Antenna Factor (dB/m).

Site: AC1	Time: 2020/09/30 - 14:42
Limit: FCC_Part15.209_RE(3m)	Engineer: David Lv
Probe: AC1_BBHA9120D_1-18GHz	Polarity: Vertical
EUT: T-BOX	Power: DC 12V
Test Mode: Transmit by BLE at Channel 2480MHz	

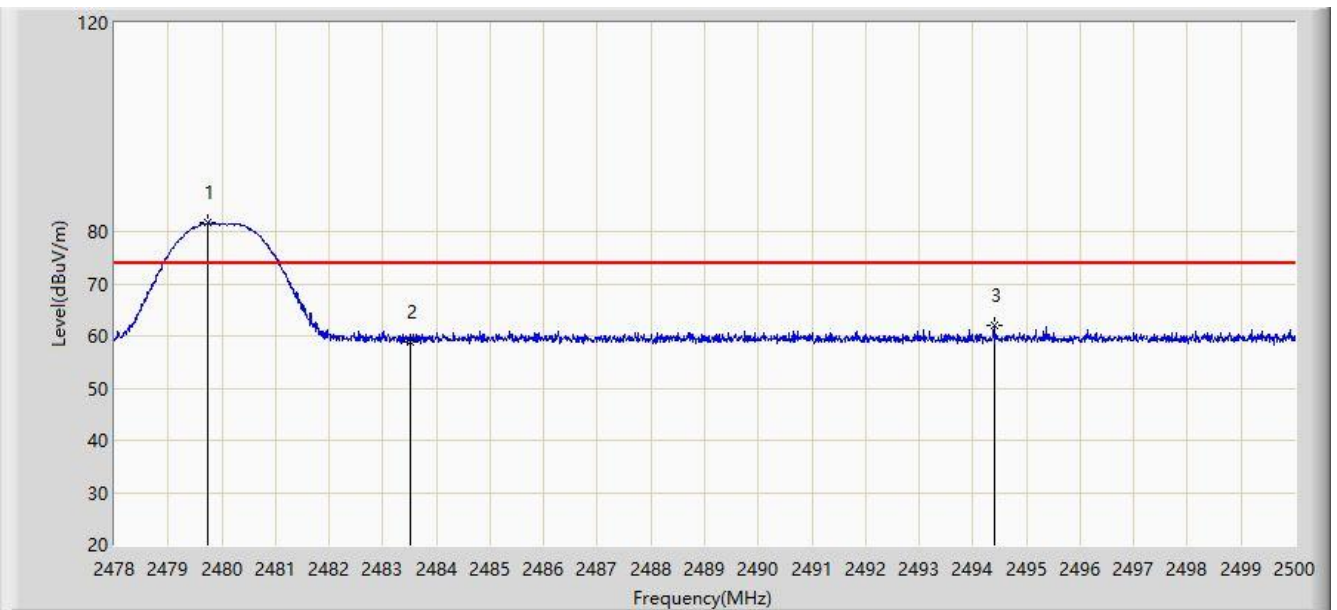

No	Flag	Mark	Frequency (MHz)	Measure Level (dBuV/m)	Reading Level (dBuV)	Margin (dB)	Limit (dBuV/m)	Factor (dB)	Type
1		*	2479.727	81.652	48.969	N/A	N/A	32.683	PK
2			2483.500	58.792	26.142	-15.208	74.000	32.651	PK
3			2494.390	61.934	29.316	-12.066	74.000	32.618	PK

Note: Measure Level (dB $\mu$ V/m) = Reading Level (dB $\mu$ V) + Factor (dB)

Factor (dB) = Cable Loss (dB) + Antenna Factor (dB/m).



Site: AC1	Time: 2020/09/30 - 14:40
Limit: FCC_Part15.209_RE(3m)	Engineer: David Lv
Probe: AC1_BBHA9120D_1-18GHz	Polarity: Vertical
EUT: T-BOX	Power: DC 12V
Test Mode: Transmit by BLE at Channel 2480MHz	

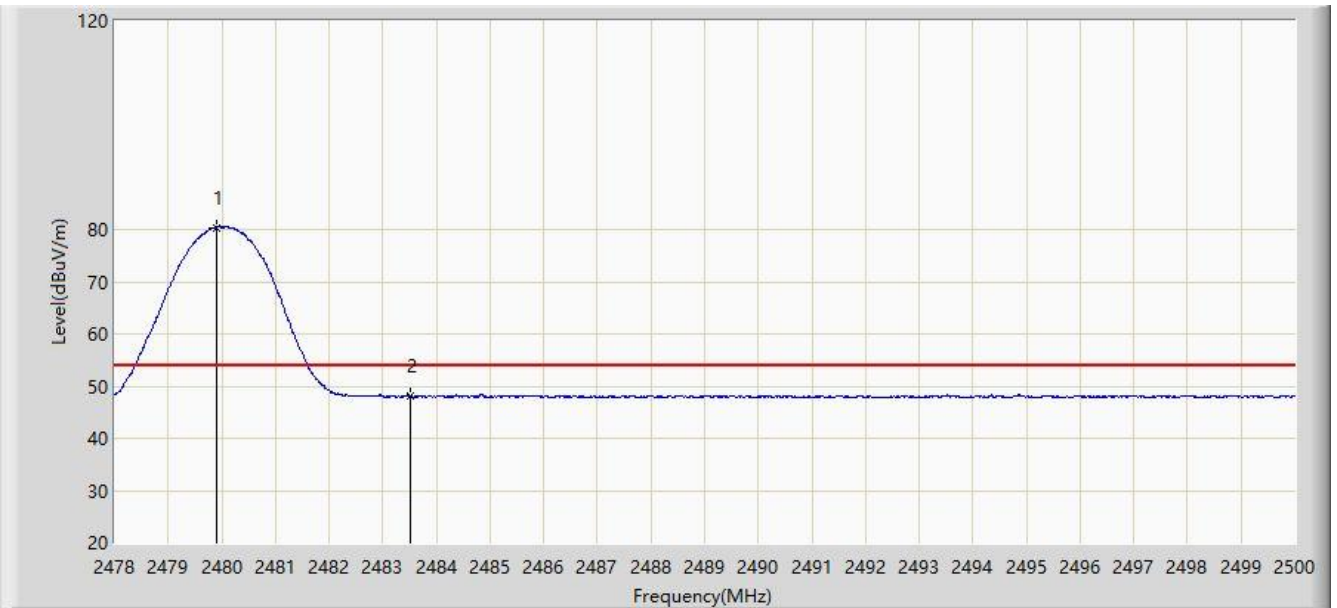

No	Flag	Mark	Frequency (MHz)	Measure Level (dBuV/m)	Reading Level (dBuV)	Margin (dB)	Limit (dBuV/m)	Factor (dB)	Type
1		*	2479.892	80.422	47.740	N/A	N/A	32.682	AV
2			2483.500	47.997	15.347	-6.003	54.000	32.651	AV

Note: Measure Level (dB $\mu$ V/m) = Reading Level (dB $\mu$ V) + Factor (dB)

Factor (dB) = Cable Loss (dB) + Antenna Factor (dB/m).

## 6.8. AC Conducted Emissions Measurement

### 6.8.1. Test Limit

FCC Part 15 Subpart C Paragraph 15.207 Limits & RSS-Gen Issue 5 Section 8.8 Limits		
Frequency (MHz)	QP (dBuV)	AV (dBuV)
0.15 - 0.50	66 - 56	56 - 46
0.50 - 5.0	56	46
5.0 - 30	60	50

Note 1: The lower limit shall apply at the transition frequencies.

Note 2: The limit decreases linearly with the logarithm of the frequency in the range 0.15MHz to 0.5MHz.

### 6.8.2. Test Setup

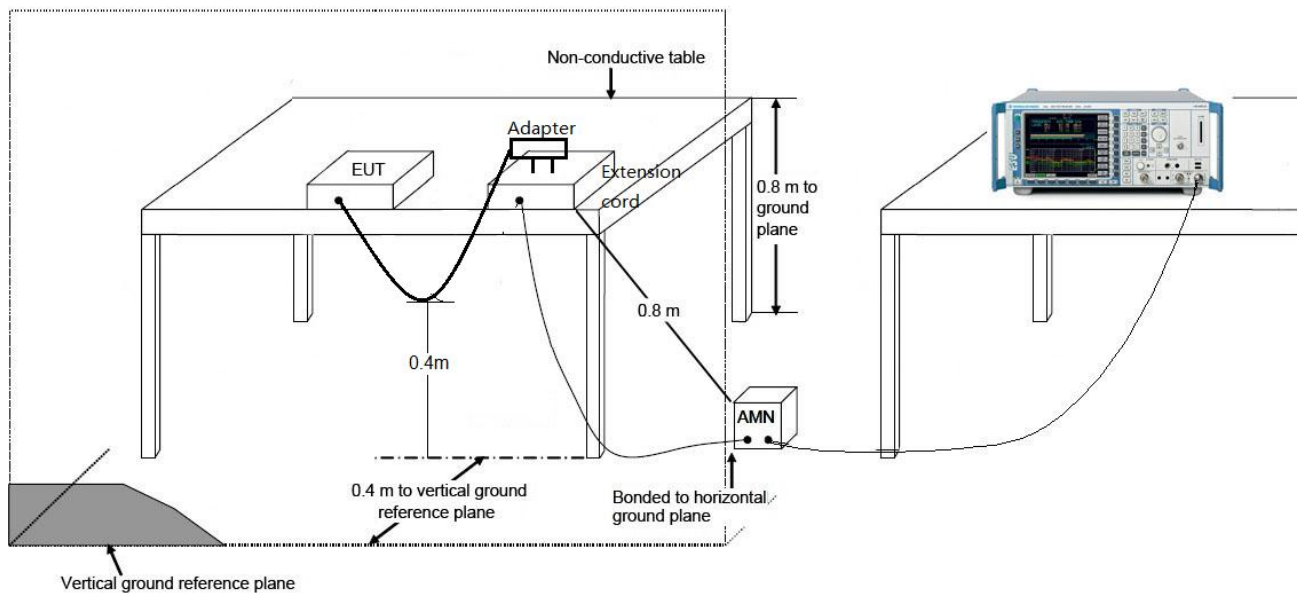

### 6.8.3. Test Result

The EUT is for vehicle use and it is powered by battery in actual use. So, this requirement doesn't apply.

## 7. CONCLUSION

The data collected relate only the item(s) tested and show that the device is in compliance with Part 15.247 of the FCC Rules and RSS-247 Section 5 of the ISED Rules.

————— The End —————

## Appendix A - Test Setup Photograph

Refer to "2009RSU050-UT" file.

## **Appendix B - EUT Photograph**

Refer to "2009RSU050-UE" file.