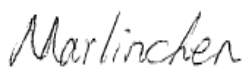

MEASUREMENT REPORT

FCC PART 15.247 / RSS-247 Bluetooth-LE

FCC ID: 2ALS8-NS9633
IC: 22636-NS9633
APPLICANT: Ninebot (Changzhou) Tech Co., Ltd.
Application Type: Certification
Product: Electric Scooter
Model No.: M365
Brand Name: MIJla
FCC Classification: Digital Transmission System (DTS)
FCC Rule Part(s): Part 15.247
IC Rule(s): RSS-247 Issue 2
Test Procedure(s): ANSI C63.10-2013, KDB 558074 D01v04
Test Date: June 05 ~ 28, 2017

Reviewed By : 
(Sunny Sun)

Approved By : 
(Marlin Chen)



The test results relate only to the samples tested.

This equipment has been shown to be capable of compliance with the applicable technical standards as indicated in the measurement report and was tested in accordance with the measurement procedures specified in KDB 558074 D01v04. Test results reported herein relate only to the item(s) tested.

The test report shall not be reproduced except in full without the written approval of MRT Technology (Suzhou) Co., Ltd.

Revision History

Report No.	Version	Description	Issue Date	Note
1706RSU03701	Rev. 01	Initial report	07-01-2017	Valid

CONTENTS

Description	Page
1. INTRODUCTION	6
1.1. Scope	6
1.2. MRT Test Location	6
2. PRODUCT INFORMATION	7
2.1. Feature of Equipment under Test	7
2.2. Product Specification Subjective to this Report.....	7
2.3. Working Frequencies.....	8
2.4. Device Capabilities	9
2.5. Test Configuration	9
2.6. EMI Suppression Device(s)/Modifications.....	9
2.7. Labeling Requirements.....	9
2.8. Test Software	9
3. DESCRIPTION OF TEST	10
3.1. Evaluation Procedure	10
3.2. AC Line Conducted Emissions	10
3.3. Radiated Emissions	11
4. ANTENNA REQUIREMENTS.....	12
5. TEST EQUIPMENT CALIBRATION DATE.....	13
6. MEASUREMENT UNCERTAINTY.....	14
7. TEST RESULT	15
7.1. Summary	15
7.2. 6dB Bandwidth Measurement.....	16
7.2.1. Test Limit	16
7.2.2. Test Procedure used.....	16
7.2.3. Test Setting.....	16
7.2.4. Test Setup.....	16
7.2.5. Test Result.....	17
7.3. Output Power Measurement.....	18
7.3.1. Test Limit	18
7.3.2. Test Procedure Used	18
7.3.3. Test Setting.....	18
7.3.4. Test Setup.....	18
7.3.5. Test Result of Output Power	19

7.4.	Power Spectral Density Measurement	20
7.4.1.	Test Limit	20
7.4.2.	Test Procedure Used	20
7.4.3.	Test Setting	20
7.4.4.	Test Setup.....	20
7.4.5.	Test Result.....	21
7.5.	Conducted Band Edge and Out-of-Band Emissions.....	22
7.5.1.	Test Limit	22
7.5.2.	Test Procedure Used	22
7.5.3.	Test Setting.....	22
7.5.4.	Test Setup.....	23
7.5.5.	Test Result.....	24
7.6.	Radiated Spurious Emission Measurement	26
7.6.1.	Test Limit	26
7.6.2.	Test Procedure Used	26
7.6.3.	Test Setting.....	26
7.6.4.	Test Setup.....	28
7.6.5.	Test Result.....	30
7.7.	Radiated Restricted Band Edge Measurement	35
7.7.1.	Test Result.....	35
7.8.	AC Conducted Emissions Measurement.....	43
7.8.1.	Test Limit	43
7.8.2.	Test Setup.....	43
7.8.3.	Test Result.....	44
8.	CONCLUSION.....	46

§2.1033 General Information

Applicant:	Ninebot (Changzhou) Tech Co., Ltd.
Applicant Address:	16F-17F, Block A, Building 3, Changwu Mid Road 18#, Wujin Dist., Changzhou, Jiangsu, China.
Manufacturer:	Ninebot (Changzhou) Tech Co., Ltd.
Manufacturer Address:	16F-17F, Block A, Building 3, Changwu Mid Road 18#, Wujin Dist., Changzhou, Jiangsu, China.
Test Site:	MRT Technology (Suzhou) Co., Ltd
Test Site Address:	D8 Building, Youxin Industrial Park, No.2 Tian'edang Rd., Wuzhong Economic Development Zone, Suzhou, China
MRT Registration No.:	809388
FCC Rule Part(s):	Part 15.247
Test Device Serial No.:	N/A <input type="checkbox"/> Production <input checked="" type="checkbox"/> Pre-Production <input type="checkbox"/> Engineering

Test Facility / Accreditations

Measurements were performed at MRT Laboratory located in Tian'edang Rd., Suzhou, China.

- MRT facility is a FCC registered (MRT Reg. No. 809388) test facility with the site description report on file and has met all the requirements specified in Section 2.948 of the FCC Rules.
- MRT facility is an IC registered (MRT Reg. No. 11384A-1) test laboratory with the site description on file at Industry Canada.
- MRT facility is a VCCI registered (R-4179, G-814, C-4664, T-2206) test laboratory with the site description on file at VCCI Council.
- MRT Lab is accredited to ISO 17025 by the American Association for Laboratory Accreditation (A2LA) under the American Association for Laboratory Accreditation Program (A2LA Cert. No. 3628.01) in EMC, Telecommunications and Radio testing for FCC, Industry Canada, EU and TELEC Rules.



1. INTRODUCTION

1.1. Scope

Measurement and determination of electromagnetic emissions (EMC) of radio frequency devices including intentional and/or unintentional radiators for compliance with the technical rules and regulations of the Federal Communications Commission and the Industry Canada Certification and Engineering Bureau.

1.2. MRT Test Location

The map below shows the location of the MRT LABORATORY, its proximity to the Taihu Lake. These measurement tests were conducted at the MRT Technology (Suzhou) Co., Ltd. Facility located at D8 Building, Youxin Industrial Park, No.2 Tian'edang Rd., Wuzhong Economic Development Zone, Suzhou, China. The detailed description of the measurement facility was found to be in compliance with the requirements of § 2.948 according to ANSI C63.4-2009 on September 30, 2013.



2. PRODUCT INFORMATION

2.1. Feature of Equipment under Test

Product Name	Electric Scooter
Model No.	M365
Brand Name:	MIJla
Bluetooth Version	v4.1

2.2. Product Specification Subjective to this Report

Bluetooth Frequency	2402~2480MHz
Bluetooth Version	v4.1
Data Rate	1Mbps(GFSK)
Antenna Gain	5.0dBi

Note: For other features of this EUT, test report will be issued separately.

2.3. Working Frequencies

Channel List for BLE

Channel	Frequency	Channel	Frequency	Channel	Frequency
00	2402 MHz	01	2404 MHz	02	2406 MHz
03	2408 MHz	04	2410 MHz	05	2412 MHz
06	2414 MHz	07	2416 MHz	08	2418 MHz
09	2420 MHz	10	2422 MHz	11	2424 MHz
12	2426 MHz	13	2428 MHz	14	2430 MHz
15	2432 MHz	16	2434 MHz	17	2436 MHz
18	2438 MHz	19	2440 MHz	20	2442 MHz
21	2444 MHz	22	2446 MHz	23	2448 MHz
24	2450 MHz	25	2452 MHz	26	2454 MHz
27	2456 MHz	28	2458 MHz	29	2460 MHz
30	2462 MHz	31	2464 MHz	32	2466 MHz
33	2468 MHz	34	2470 MHz	35	2472 MHz
36	2474 MHz	37	2476 MHz	38	2478 MHz
39	2480 MHz	--	--	--	--

2.4. Device Capabilities

This device contains the following capabilities:

Bluetooth v4.1.

2.5. Test Configuration

The **Electric Scooter** was tested per the guidance of KDB 558074 D01v04. ANSI C63.10-2013 was used to reference the appropriate EUT setup for radiated spurious emissions testing and AC line conducted testing.

2.6. EMI Suppression Device(s)/Modifications

No EMI suppression device(s) were added and/or no modifications were made during testing.

2.7. Labeling Requirements

Per 2.1074 & 15.19; Docket 95-19

The label shall be permanently affixed at a conspicuous location on the device; instruction manual or pamphlet supplied to the user and be readily visible to the purchaser at the time of purchase.

However, when the device is so small wherein placement of the label with specified statement is not practical, only the FCC ID must be displayed on the device per Section 15.19(a)(5). Please see attachment for FCC ID label and label location.

2.8. Test Software

The test utility software used during testing was “nRFgo Studio”.

3. DESCRIPTION OF TEST

3.1. Evaluation Procedure

The measurement procedures described in the American National Standard for Testing Unlicensed Wireless Devices (ANSI C63.10-2013), and the guidance provided in KDB 558074 D01v04 were used in the measurement of the **Electric Scooter**.

Deviation from measurement procedure.....None

3.2. AC Line Conducted Emissions

The line-conducted facility is located inside an 8'x4'x4' shielded enclosure. A 1m x 2m wooden table 80cm high is placed 40cm away from the vertical wall and 80cm away from the sidewall of the shielded room. Two 10kHz-30MHz, 50Ω/50uH Line-Impedance Stabilization Networks (LISNs) are bonded to the shielded room floor. Power to the LISNs is filtered by external high-current high-insertion loss power line filters. These filters attenuate ambient signal noise from entering the measurement lines. These filters are also bonded to the shielded enclosure.

The EUT is powered from one LISN and the support equipment is powered from the second LISN. All interconnecting cables more than 1 meter were shortened to a 1 meter length by non-inductive bundling (serpentine fashion) and draped over the back edge of the test table. All cables were at least 40cm above the horizontal reference ground-plane. Power cables for support equipment were routed down to the second LISN while ensuring that that cables were not draped over the second LISN.

Sufficient time for the EUT, support equipment, and test equipment was allowed in order for them to warm up to their normal operating condition. The RF output of the LISN was connected to the receiver and exploratory measurements were made to determine the frequencies producing the maximum emission from the EUT. The receiver was scanned from 150kHz to 30MHz. The detector function was set to peak mode for exploratory measurements while the bandwidth of the analyzer was set to 9kHz. The EUT, support equipment, and interconnecting cables were arranged and manipulated to maximize each emission. Each emission was also maximized by varying: power lines, the mode of operation or data exchange speed, or support equipment whichever determined the worst-case emission. Once the worst case emissions have been identified, the one EUT cable configuration/arrangement and mode of operation that produced these emissions were used for final measurements on the same test site. The analyzer is set to CISPR quasi-peak and average detectors with a 9kHz resolution bandwidth for final measurements.

An extension cord was used to connect to a single LISN which powered by EUT. The extension cord was calibrated with LISN, the impedance and insertion loss are compliance with the requirements as stated in ANSI C63.10-2013.

Line conducted emissions test results are shown in Section 7.8.

3.3. Radiated Emissions

The radiated test facilities consisted of an indoor 3 meter semi-anechoic chamber used for final measurements and exploratory measurements, when necessary. The measurement area is contained within the semi-anechoic chamber which is shielded from any ambient interference. For measurements above 1GHz absorbers are arranged on the floor between the turn table and the Antenna mast in such a way so as to maximize the reduction of reflections. For measurements below 1GHz, the absorbers are removed. A MF Model 210SS turntable is used for radiated measurement. It is a continuously rotatable, remote controlled, metallic turntable and 2 meters (6.56 ft.) in diameter. The turn table is flush with the raised floor of the chamber in order to maintain its function as a ground plane. An 80cm high PVC support structure is placed on top of the turntable. For all measurements, the spectrum was scanned through all EUT azimuths and from 1 to 4 meter receive Antenna height using a broadband Antenna from 30MHz up to the upper frequency shown in 15.33(b)(1) depending on the highest frequency generated or used in the device or on which the device operates or tunes. For frequencies above 1GHz, linearly polarized double ridge horn Antennas were used. For frequencies below 30MHz, a calibrated loop Antenna was used. When exploratory measurements were necessary, they were performed at 1 meter test distance inside the semi-anechoic chamber using broadband Antennas, broadband amplifiers, and spectrum analyzers to determine the frequencies and modes producing the maximum emissions. Sufficient time for the EUT, support equipment, and test equipment was allowed in order for them to warm up to their normal operating condition. The test set-up for frequencies below 1GHz was placed on top of the 0.8 meter high, 1 x 1.5 meter table; and test set-up for frequencies 1-40GHz was placed on top of the 1.5 meter high, 1 x 1.5 meter table. The EUT, support equipment, and interconnecting cables were arranged and manipulated to maximize each emission. Appropriate precaution was taken to ensure that all emissions from the EUT were maximized and investigated. The system configuration, clock speed, mode of operation or video resolution, if applicable, turntable azimuth, and receive Antenna height was noted for each frequency found.

Final measurements were made in the semi-anechoic chamber using calibrated, linearly polarized broadband and horn Antennas. The test setup was configured to the setup that produced the worst case emissions. The spectrum analyzer was set to investigate all frequencies required for testing to compare the highest radiated disturbances with respect to the specified limits. The turntable containing the EUT was rotated through 360 degrees and the height of the receive Antenna was varied 1 to 4 meters and stopped at the azimuth and height producing the maximum emission. Each emission was maximized by changing the orientation of the EUT through three orthogonal planes and changing the polarity of the receive Antenna, whichever produced the worst-case emissions. According to 3dB Beam-Width of horn Antenna, the horn Antenna should be always directed to the EUT when rising height.

4. ANTENNA REQUIREMENTS

Excerpt from §15.203 of the FCC Rules/Regulations:

“An intentional radiator antenna shall be designed to ensure that no antenna other than that furnished by the responsible party can be used with the device. The use of a permanently attached antenna or of an antenna that uses a unique coupling to the intentional radiator shall be considered sufficient to comply with the provisions of this section.”

- The antenna of the **Electric Scooter** is **permanently attached**.
- There are no provisions for connection to an external antenna.

Conclusion:

The **Electric Scooter** unit complies with the requirement of §15.203.

5. TEST EQUIPMENT CALIBRATION DATE

Conducted Emissions - SR2

Instrument	Manufacturer	Type No.	Asset No.	Cali. Interval	Cali. Due Date
EMI Test Receiver	R&S	ESR7	MRTSUE06001	1 year	2018/04/24
Two-Line V-Network	R&S	ENV216	MRTSUE06002	1 year	2018/06/20
Two-Line V-Network	R&S	ENV216	MRTSUE06003	1 year	2018/06/20
Temperature/Humidity Meter	Yuhuaze	HTC-2	MRTSUE06181	1 year	2017/12/20
Shielding Anechoic Chamber	Mikebang	Chamber-SR2	MRTSUE06214	1 year	2018/05/10

Radiated Disturbance - AC2

Instrument	Manufacturer	Type No.	Asset No.	Cali. Interval	Cali. Due Date
MXE EMI Receiver	Agilent	N9038A	MRTSUE06125	1 year	2017/08/03
Loop Antenna	Schwarzbeck	FMZB1519	MRTSUE06025	1 year	2017/12/21
Bilog Period Antenna	Schwarzbeck	VULB9162	MRTSUE06022	1 year	2017/10/22
Broad-Band Horn Antenna	Schwarzbeck	BBHA9120D	MRTSUE06171	1 year	2017/11/19
Broadband Coaxial Preamp	Schwarzbeck	BBV 9718	MRTSUE06106	1 year	2017/12/10
Broadband Horn Antenna	Schwarzbeck	BBHA9170	MRTSUE06024	1 year	2018/04/25
Digital Thermometer & Hygrometer	Minggao	ETH529	MRTSUE06170	1 year	2017/11/30
Anechoic Chamber	RIKEN	Chamber-AC2	MRTSUE06213	1 year	2018/05/10

Conducted Test Equipment - TR3

Instrument	Manufacturer	Type No.	Asset No.	Cali. Interval	Cali. Due Date
MXE EMI Receiver	Agilent	N9038A	MRTSUE06125	1 year	2017/08/03
Power Meter	Agilent	U2021XA	MRTSUE06030	1 year	2017/12/06
Temperature/Humidity Meter	Yuhuaze	HTC-2	MRTSUE06180	1 year	2017/12/22

Software	Version	Function
e3	V8.3.5	EMI Test Software

6. MEASUREMENT UNCERTAINTY

Where relevant, the following test uncertainty levels have been estimated for tests performed on the EUT as specified in CISPR 16-4-2. This uncertainty represents an expanded uncertainty expressed at approximately the 95% confidence level using a coverage factor of $k = 2$.

AC Conducted Emission Measurement - SR2
Measuring Uncertainty for a Level of Confidence of 95% ($U=2Uc(y)$): 150kHz~30MHz: 3.46dB
Radiated Emission Measurement - AC2
Measuring Uncertainty for a Level of Confidence of 95% ($U=2Uc(y)$): 9kHz ~ 1GHz: ± 4.18 dB 1GHz ~ 25GHz: ± 4.76 dB
Spurious Emissions, Conducted - TR3
Measuring Uncertainty for a Level of Confidence of 95% ($U=2Uc(y)$): 0.78dB
Output Power - TR3
Measuring Uncertainty for a Level of Confidence of 95% ($U=2Uc(y)$): 1.13dB
Power Spectrum Density - TR3
Measuring Uncertainty for a Level of Confidence of 95% ($U=2Uc(y)$): 1.15dB
Occupied Bandwidth - TR3
Measuring Uncertainty for a Level of Confidence of 95% ($U=2Uc(y)$): 0.28%

7. TEST RESULT

7.1. Summary

Company Name: Ninebot (Changzhou) Tech Co., Ltd.
FCC ID: 2ALS8-NS9633
IC: 22636-NS9633
FCC Classification: Digital Transmission System (DTS)
Data Rate(s) Tested: 1Mbps(GFSK) (BLE)

FCC Section(s)	IC Section(s)	Test Description	Test Limit	Test Condition	Test Result	Reference
15.247(a)(2)	RSS-247 [5.2]	6dB Bandwidth	$\geq 500\text{kHz}$	Conducted	Pass	Section 7.2
15.247(b)(3)	RSS-247 [5.4(4)]	Output Power	$\leq 30\text{dBm}$		Pass	Section 7.3
15.247(e)	RSS-247 [5.2]	Power Spectral Density	$\leq 8\text{dBm}/3\text{kHz}$		Pass	Section 7.4
15.247(d)	RSS-247 [5.5]	Band Edge / Out-of-Band Emissions	$\geq 30\text{dBc(Average)}$		Pass	Section 7.5
15.205 15.209	RSS-247 [5.5]	General Field Strength Limits (Restricted Bands and Radiated Emission Limits)	Emissions in restricted bands must meet the radiated limits detailed in 15.209	Radiated	Pass	Section 7.6 & 7.7
15.207	RSS-Gen [8.8]	AC Conducted Emissions 150kHz - 30MHz	< FCC 15.207 limits	Line Conducted	Pass	Section 7.8

Notes: The analyzer plots shown in this section were all taken with a correction table loaded into the analyzer. The correction table was used to account for the losses of the cables and attenuators used as part of the system to connect the EUT to the analyzer at all frequencies of interest.

7.2. 6dB Bandwidth Measurement

7.2.1. Test Limit

The minimum 6dB bandwidth shall be at least 500 kHz.

7.2.2. Test Procedure used

KDB 558074 D01v04 - Section 8.2 Option 2

7.2.3. Test Setting

1. The Spectrum's automatic bandwidth measurement capability was used to perform the 6dB bandwidth measurement. The "X" dB bandwidth parameter was set to $X = 6$. The bandwidth measurement was not influenced by any intermediate power nulls in the fundamental emission.
2. Set RBW = 100 kHz
3. VBW $\geq 3 \times$ RBW
4. Detector = Peak
5. Trace mode = max hold
6. Sweep = auto couple
7. Allow the trace was allowed to stabilize

7.2.4. Test Setup

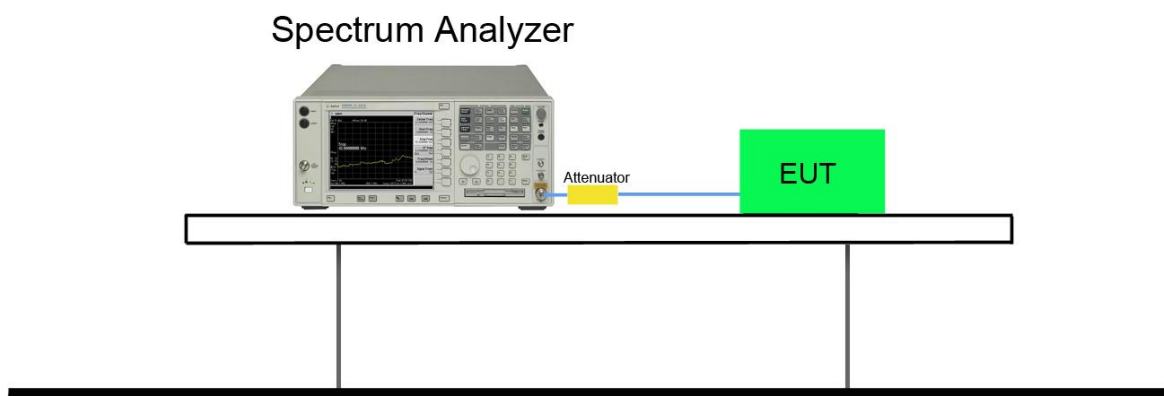

7.2.5. Test Result

Test Mode	Data Rate (Mbps)	Channel No.	Frequency (MHz)	6dB Bandwidth (MHz)	Limit (MHz)	Result
BLE	1	00	2402	0.68	≥ 0.5	Pass
BLE	1	19	2440	0.68	≥ 0.5	Pass
BLE	1	39	2480	0.69	≥ 0.5	Pass

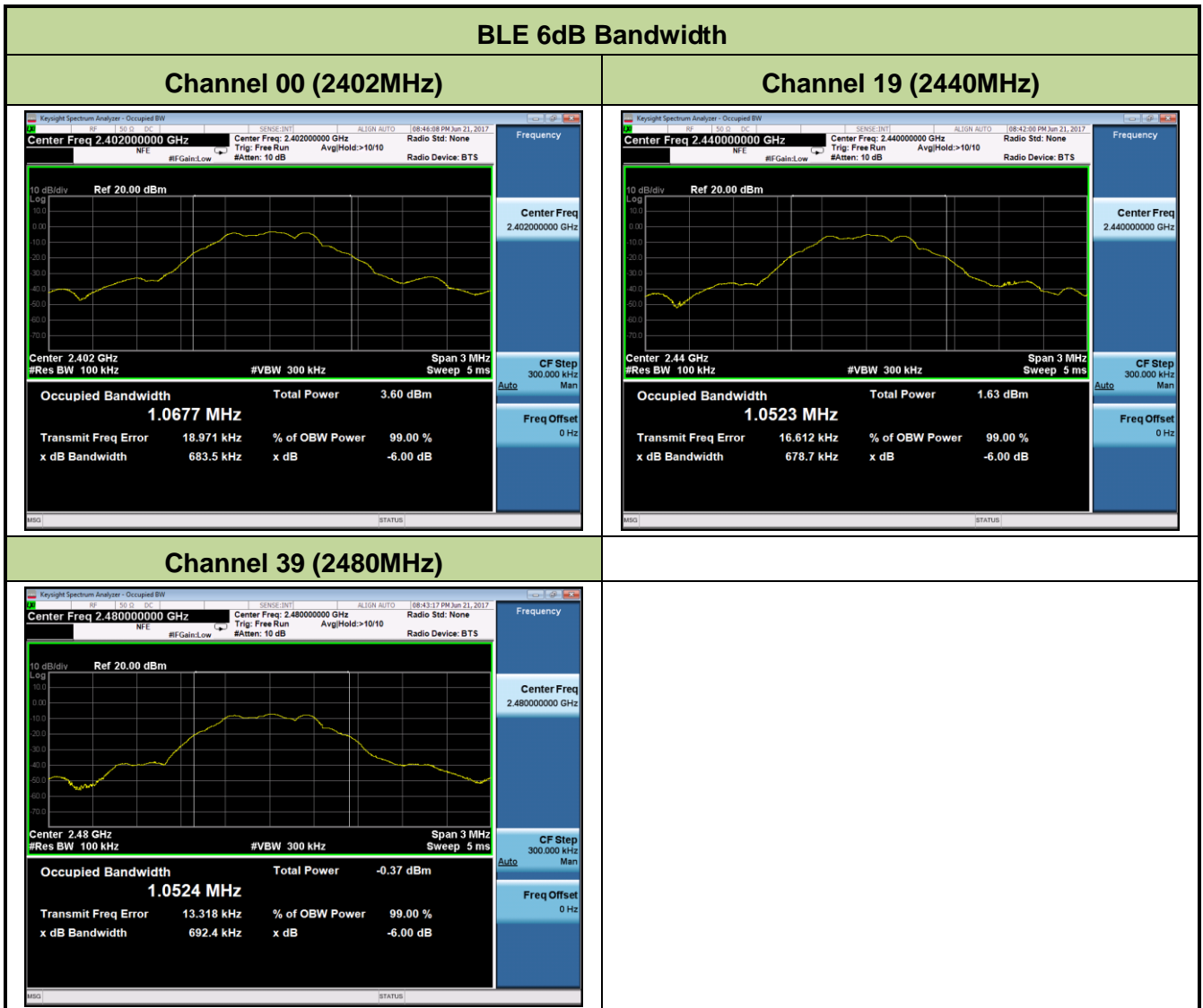

7.3. Output Power Measurement

7.3.1. Test Limit

The maximum out power shall be less 1 Watt (30dBm) and the E.I.R.P shall not exceed 4 Watt (36dBm).

7.3.2. Test Procedure Used

KDB 558074 D01v04 - Section 9.1.2 PKPM1 - Peak Power Method

KDB 558074 D01v04 - Section 9.2.3.2 Method AVGPM-G

7.3.3. Test Setting

Method PKPM1 (Peak Power Measurement of Signals with DTS BW \leq 50MHz)

Peak power measurements were performed only when the EUT was transmitting at its maximum power control level using a broadband power meter with a pulse sensor. The pulse sensor employs a VBW = 50MHz so this method was only used for signals whose DTS bandwidth was less than or equal to 50MHz.

Method AVGPM-G (Measurement using a gated RF average-reading power meter)

Measurements may be performed using a wideband gated RF power meter provided that the gate parameters are adjusted such that the power is measured only when the EUT is transmitting at its maximum power control level. Since this measurement is made only during the ON time of the transmitter, no duty cycle correction is required.

7.3.4. Test Setup

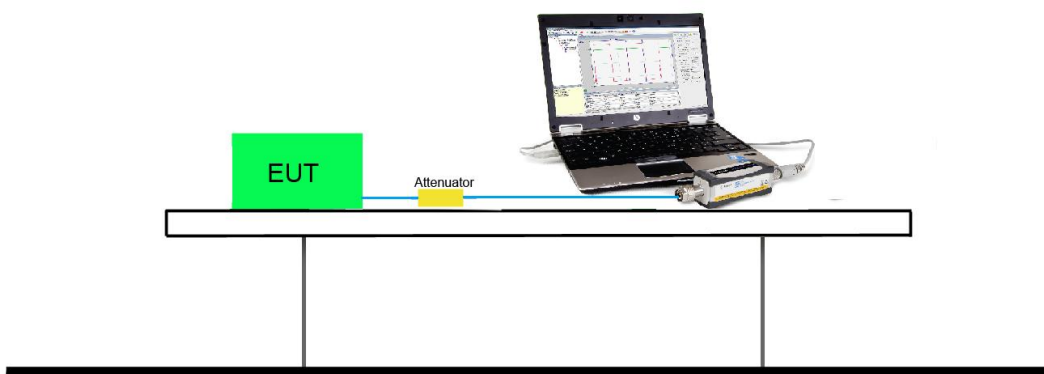

7.3.5. Test Result of Output Power

Test Result of Peak Output Power

Test Mode	Data Rate (Mbps)	Channel No.	Frequency (MHz)	Peak Power (dBm)	Limit (dBm)	Result
BLE	1	00	2402	-2.23	≤ 30	Pass
BLE	1	19	2440	-4.01	≤ 30	Pass
BLE	1	39	2480	-5.43	≤ 30	Pass

Test Result of Average Output Power (Reporting Only)

Test Mode	Data Rate (Mbps)	Channel No.	Frequency (MHz)	Average Power (dBm)	Limit (dBm)	Result
BLE	1	00	2402	-3.87	≤ 30	Pass
BLE	1	19	2440	-6.16	≤ 30	Pass
BLE	1	39	2480	-7.06	≤ 30	Pass

7.4. Power Spectral Density Measurement

7.4.1. Test Limit

The maximum permissible power spectral density is 8dBm in any 3 kHz band.

7.4.2. Test Procedure Used

KDB 558074 D01v04 - Section 10.2 Method PKPSD

7.4.3. Test Setting

1. Analyzer was set to the center frequency of the DTS channel under investigation
2. Span = 1.5 times the DTS channel bandwidth
3. RBW = 3kHz
4. VBW = 10kHz
5. Detector = peak
6. Sweep time = auto couple
7. Trace mode = max hold
8. Trace was allowed to stabilize

7.4.4. Test Setup

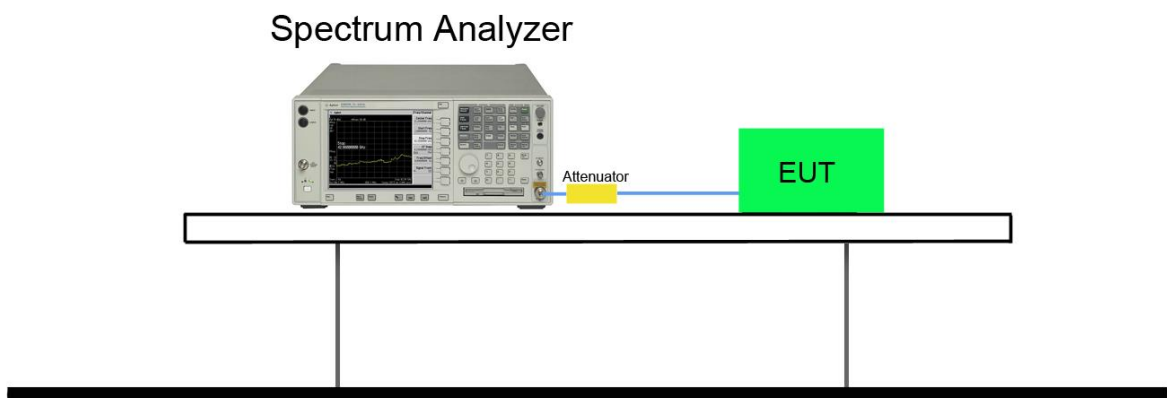

7.4.5. Test Result

Test Mode	Data Rate (Mbps)	Channel No.	Frequency (MHz)	PSD Result (dBm / 3kHz)	Limit (dBm / 3kHz)	Result
BLE	1	00	2402	-17.32	≤ 8	Pass
BLE	1	19	2440	-19.57	≤ 8	Pass
BLE	1	39	2480	-19.75	≤ 8	Pass

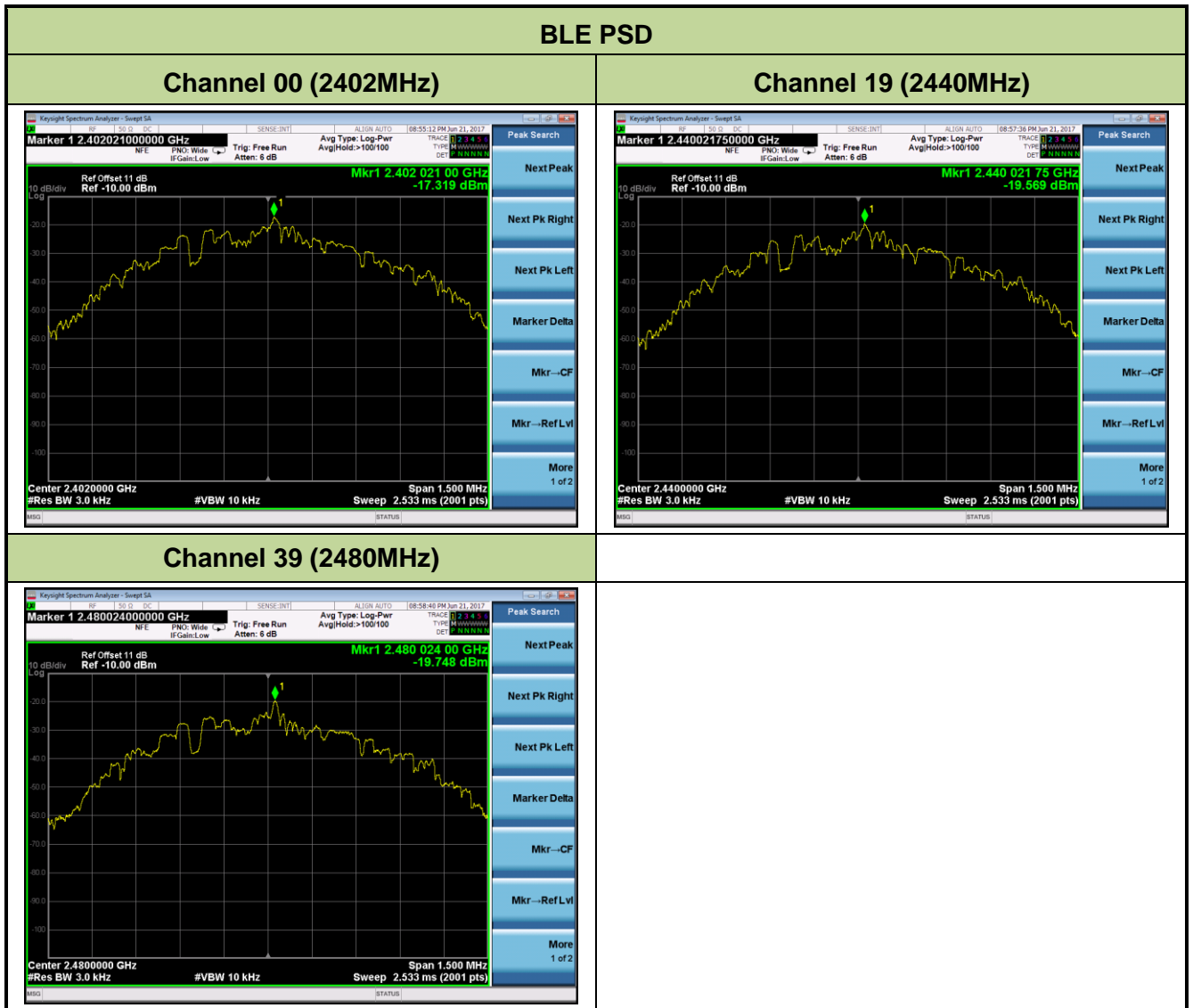

7.5. Conducted Band Edge and Out-of-Band Emissions

7.5.1. Test Limit

The limit for out-of-band spurious emissions at the band edge is 20dB below the fundamental emission level, as determined from the in-band power measurement of the DTS channel performed in a 100kHz bandwidth per the PSD procedure.

7.5.2. Test Procedure Used

KDB 558074 D01v04 - Section 11.2 & Section 11.3

7.5.3. Test Setting

Reference level measurement

1. Set instrument center frequency to DTS channel center frequency
2. Set the span to ≥ 1.5 times the DTS bandwidth
3. Set the RBW = 100 kHz
4. Set the VBW $\geq 3 \times$ RBW
5. Detector = peak
6. Sweep time = auto couple
7. Trace mode = max hold
8. Allow trace to fully stabilize

Emission level measurement

1. Set the center frequency and span to encompass frequency range to be measured
2. RBW = 100kHz
3. VBW = 300kHz
4. Detector = Peak
5. Number of sweep points $\geq 2 \times$ Span/RBW
6. Trace mode = max hold
7. Sweep time = auto couple
8. The trace was allowed to stabilize

7.5.4. Test Setup

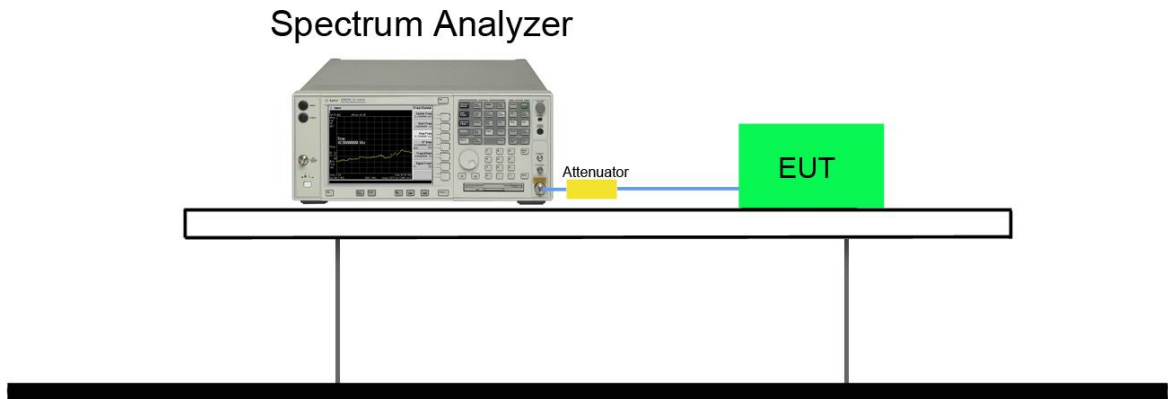

7.5.5. Test Result

Test Mode	Data Rate (Mbps)	Channel No.	Frequency (MHz)	Limit	Result
BLE	1	00	2402	20dBc	Pass
BLE	1	19	2440	20dBc	Pass
BLE	1	39	2480	20dBc	Pass

BLE Out-of-Band Emissions

Channel 00 (2402MHz)

100kHz PSD reference Level



Low Band Edge



Spurious Emission 30MHz ~ 25GHz

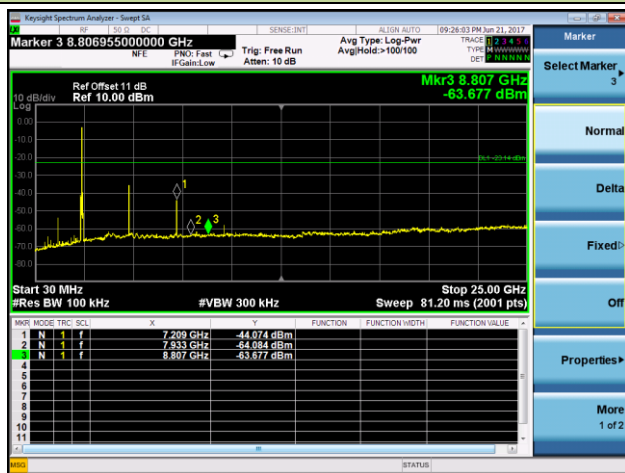

Channel 19 (2440MHz)

100kHz PSD reference Level



Spurious Emission 30MHz ~ 25GHz

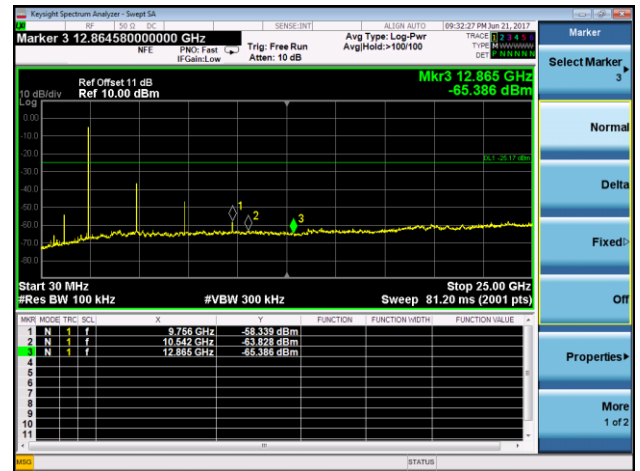

Channel 39 (2480MHz)

100kHz PSD reference Level



High Band Edge

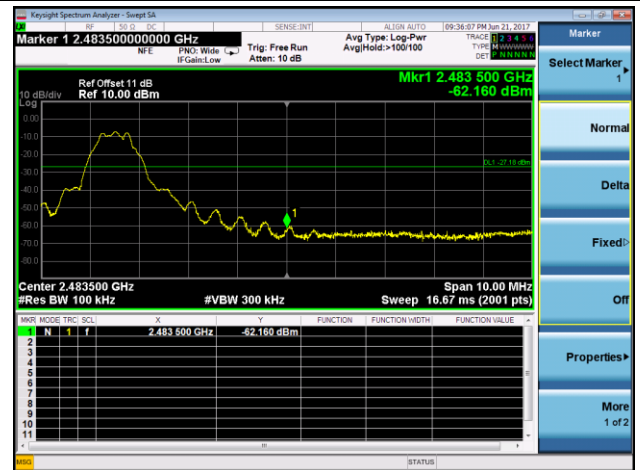

Spurious Emission 30MHz ~ 25GHz

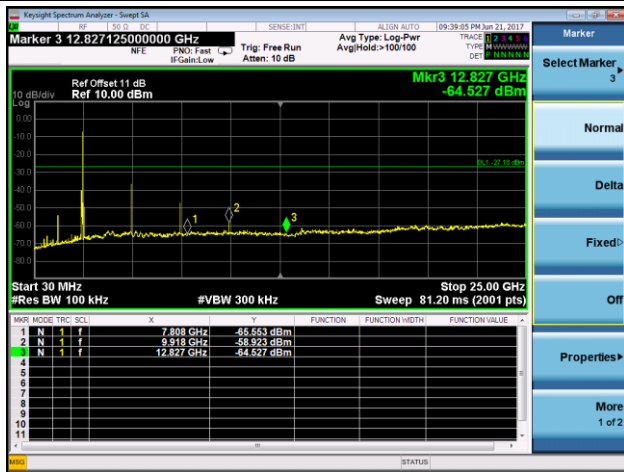

7.6. Radiated Spurious Emission Measurement

7.6.1. Test Limit

All out of band emissions appearing in a restricted band as specified in Section 15.205 of the Title 47 CFR must not exceed the limits shown in Table per Section 15.209.

FCC Part 15 Subpart C Paragraph 15.209		
Frequency [MHz]	Field Strength [uV/m]	Measured Distance [Meters]
0.009 - 0.490	2400/F (kHz)	300
0.490 - 1.705	24000/F (kHz)	30
1.705 - 30	30	30
30 - 88	100	3
88 - 216	150	3
216 - 960	200	3
Above 960	500	3

7.6.2. Test Procedure Used

KDB 558074 D01v04 - Section 12.2.3 (quasi-peak measurements)

KDB 558074 D01v04 - Section 12.2.4 (peak power measurements)

KDB 558074 D01v04 - Section 12.2.5 (average power measurements)

7.6.3. Test Setting

Peak Field Strength Measurements per Section 12.2.4 of KDB 558074 D01v04

1. Analyzer center frequency was set to the frequency of the radiated spurious emission of interest
2. RBW = as specified in Table 1
3. VBW = 3MHz
4. Detector = peak
5. Sweep time = auto couple

6. Trace mode = max hold
7. Trace was allowed to stabilize

Table 1 - RBW as a function of frequency

Frequency	RBW
9 ~ 150 kHz	200 ~ 300 Hz
0.15 ~ 30 MHz	9 ~ 10 kHz
30 ~ 1000 MHz	100 ~ 120 kHz
> 1000 MHz	1 MHz

Average Field Strength Measurements per Section 12.2.4 of KDB 558074 D01v04

1. Analyzer center frequency was set to the frequency of the radiated spurious emission of interest
2. RBW = 1MHz
3. VBW $\geq 1/T$
4. De As an alternative, the instrument may be set to linear detector mode. Ensure that video filtering is applied in linear voltage domain (rather than in a log or dB domain). Some instruments require linear display mode in order to accomplish this. Others have a setting for Average-VBW Type, which can be set to "Voltage" regardless of the display mode
5. Detector = Peak
6. Sweep time = auto
7. Trace mode = max hold
8. Allow max hold to run for at least 50 times (1/duty cycle) traces

7.6.4. Test Setup

9kHz ~ 30MHz Test Setup:

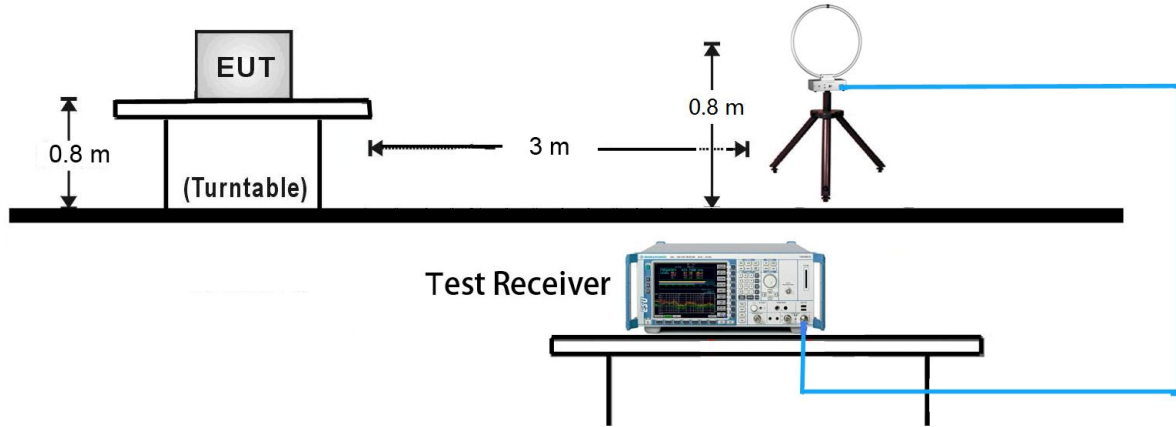

30MHz ~ 1GHz Test Setup:

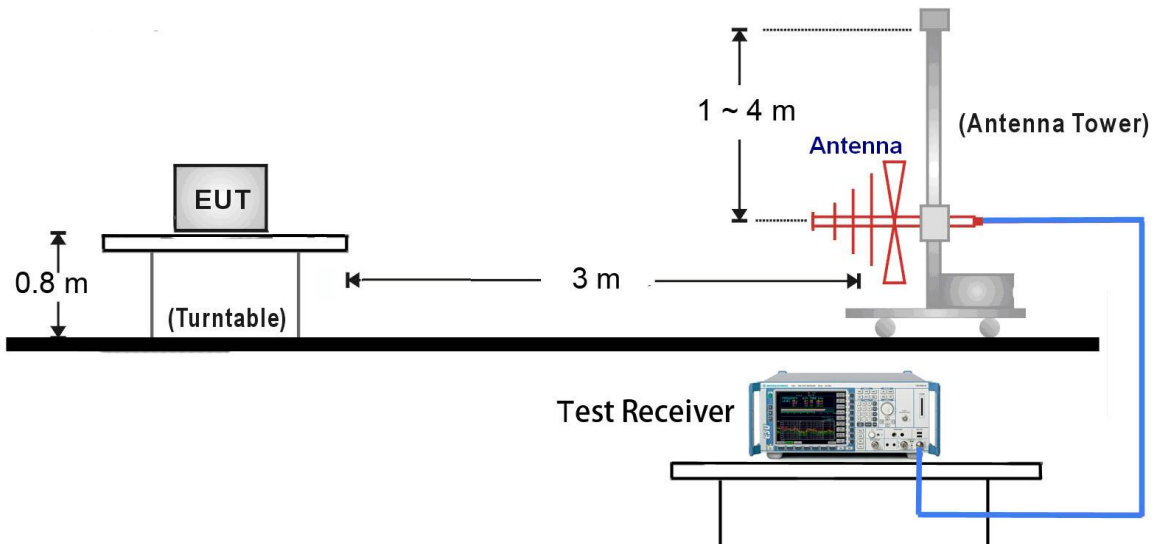

1GHz ~ 18GHz Test Setup:

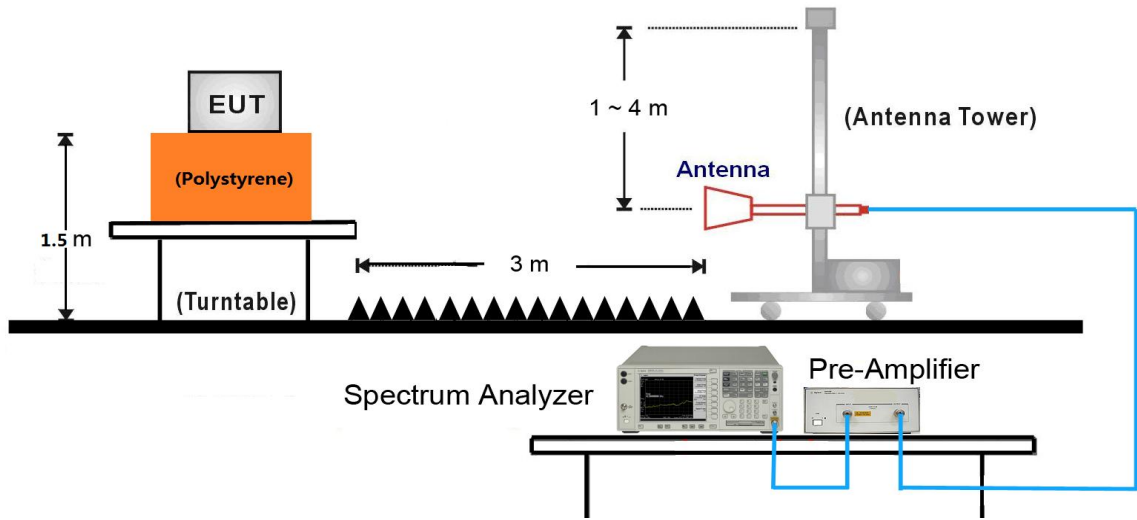

18GHz ~25GHz Test Setup:

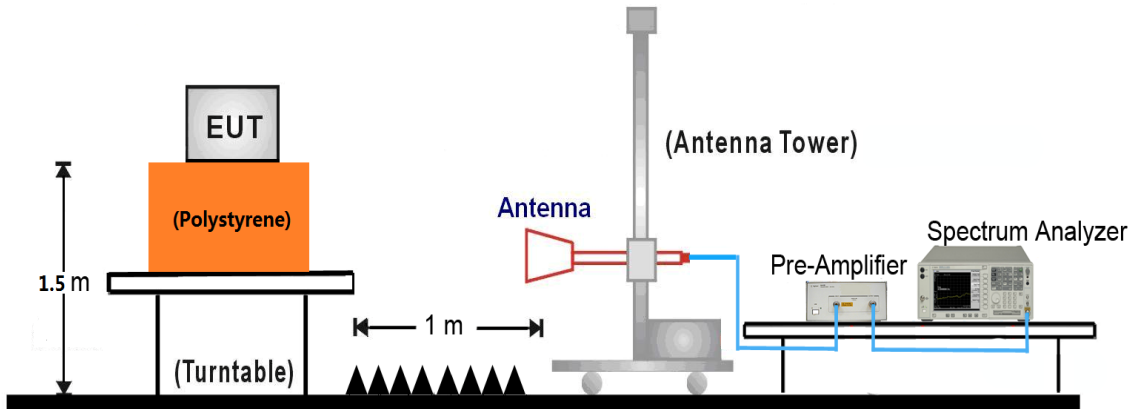

7.6.5. Test Result

Test Mode:	BLE	Test Site:	AC1
Test Channel:	00	Test Engineer:	Bruce Wang
Remark:	1. Average measurement was not performed if peak level lower than average limit. 2. Other frequency was 20dB below limit line within 1-18GHz, there is not show in the report.		

Mark	Frequency (MHz)	Reading Level (dBμV)	Factor (dB)	Measure Level (dBμV/m)	Limit (dBμV/m)	Margin (dB)	Detector	Polarization
	4808.0	45.4	2.7	48.1	74	-25.9	Peak	Horizontal
	5020.5	34.6	2.8	37.4	74	-36.6	Peak	Horizontal
*	7205.0	38.6	10.5	49.1	74	-24.9	Peak	Horizontal
*	9636.0	33.4	12.9	46.3	74	-27.7	Peak	Horizontal
	4808.0	41.4	2.7	44.1	74	-29.9	Peak	Vertical
	5063.0	35.3	3.0	38.3	74	-35.7	Peak	Vertical
*	7205.0	38.4	10.5	48.9	74	-25.1	Peak	Vertical
*	9644.5	33.1	12.7	45.8	74	-28.2	Peak	Vertical

Note 1: "*" is not in restricted band, its limit is 20dBc of the fundamental emission level (87.4dBμV/m) or 15.209 which is higher.

Note 2: Measure Level (dBμV/m) = Reading Level (dBμV) + Factor (dB)

Factor (dB) = Cable Loss (dB) + Antenna Factor (dB/m) - Pre_Amplifier Gain (dB)

Test Mode:	BLE	Test Site:	AC1
Test Channel:	19	Test Engineer:	Bruce Wang
Remark:	1. Average measurement was not performed if peak level lower than average limit. 2. Other frequency was 20dB below limit line within 1-18GHz, there is not show in the report.		

Mark	Frequency (MHz)	Reading Level (dB μ V)	Factor (dB)	Measure Level (dB μ V/m)	Limit (dB μ V/m)	Margin (dB)	Detector	Polarization
	4876.0	46.2	2.6	48.8	74	-25.2	Peak	Horizontal
	7324.0	38.9	10.6	49.5	74	-24.5	Peak	Horizontal
*	8582.0	32.3	11.0	43.3	74	-30.7	Peak	Horizontal
*	9644.5	33.4	12.7	46.1	74	-27.9	Peak	Horizontal
	4876.0	42.1	2.6	44.7	74	-29.3	Peak	Vertical
	7324.0	37.6	10.6	48.2	74	-25.8	Peak	Vertical
*	8582.0	32.2	11.0	43.2	74	-30.8	Peak	Vertical
*	9653.0	33.3	12.5	45.8	74	-28.2	Peak	Vertical

Note 1: "*" is not in restricted band, its limit is 20dBc of the fundamental emission level (86.2dB μ V/m) or 15.209 which is higher.

Note 2: Measure Level (dB μ V/m) = Reading Level (dB μ V) + Factor (dB)

Factor (dB) = Cable Loss (dB) + Antenna Factor (dB/m) - Pre_Amplifier Gain (dB)

Test Mode:	BLE	Test Site:	AC1
Test Channel:	39	Test Engineer:	Bruce Wang
Remark:	1. Average measurement was not performed if peak level lower than average limit. 2. Other frequency was 20dB below limit line within 1-18GHz, there is not show in the report.		

Mark	Frequency (MHz)	Reading Level (dBμV)	Factor (dB)	Measure Level (dBμV/m)	Limit (dBμV/m)	Margin (dB)	Detector	Polarization
	4961.0	47.4	2.7	50.1	74	-23.9	Peak	Horizontal
	7443.0	40.7	10.7	51.4	74	-22.6	Peak	Horizontal
*	8599.0	32.6	11.0	43.6	74	-30.4	Peak	Horizontal
*	9644.5	32.9	12.7	45.6	74	-28.4	Peak	Horizontal
	4961.0	41.8	2.7	44.5	74	-29.5	Peak	Vertical
	7443.0	35.5	10.7	46.2	74	-27.8	Peak	Vertical
*	8735.0	31.7	11.6	43.3	74	-30.7	Peak	Vertical
*	9644.5	32.9	12.7	45.6	74	-28.4	Peak	Vertical

Note 1: "*" is not in restricted band, its limit is 20dBc of the fundamental emission level (85.0dBμV/m) or 15.209 which is higher.

Note 2: Measure Level (dBμV/m) = Reading Level (dBμV) + Factor (dB)

Factor (dB) = Cable Loss (dB) + Antenna Factor (dB/m) - Pre_Amplifier Gain (dB)

The worst case of Radiated Emission below 1GHz:

Site: AC2	Time: 2017/06/27 - 02:58
Limit: FCC_Part15.209_RE(3m)	Engineer: Dandy Li
Probe: VULB9162_0.03-8GHz	Polarity: Horizontal
EUT: Electric Scooter	Power: AC 120V/60Hz
Worse Case Mode: Transmit by BLE at channel 2402MHz	

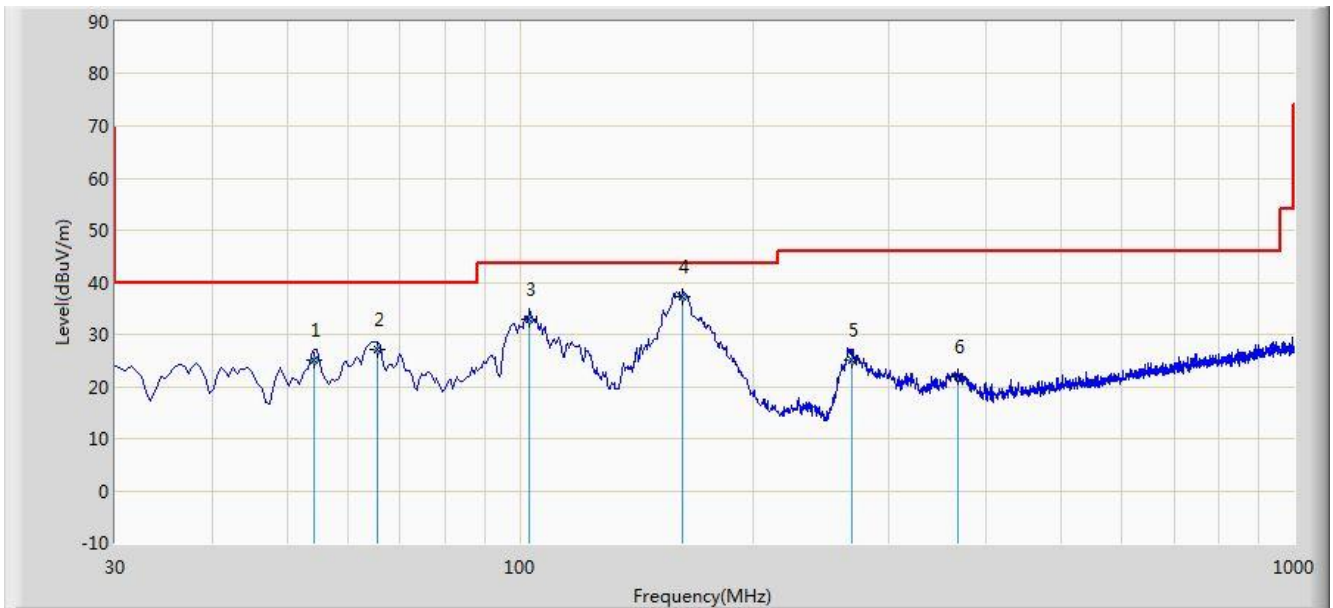

No	Flag	Mark	Frequency (MHz)	Measure Level (dBuV/m)	Reading Level (dBuV)	Over Limit (dB)	Limit (dBuV/m)	Factor (dB)	Type
1			54.250	24.993	11.153	-15.007	40.000	13.840	QP
2			65.405	26.989	14.563	-13.011	40.000	12.426	QP
3			102.750	32.866	21.563	-10.634	43.500	11.303	QP
4		*	162.405	37.173	22.154	-6.327	43.500	15.019	QP
5			268.620	25.027	11.545	-20.973	46.000	13.482	QP
6			367.560	22.003	6.145	-23.997	46.000	15.858	QP

Note 1: Measure Level (dB μ V/m) = Reading Level (dB μ V) + Factor (dB)

Factor (dB) = Cable Loss (dB) + Antenna Factor (dB/m)

Note 2: The test trace is same as the ambient noise and the amplitude of the emissions are attenuated more than 20dB below the permissible (the test frequency range: 9kHz ~ 30MHz, 18GHz ~ 25GHz), therefore no data appear in the report.

Site: AC2	Time: 2017/06/27 - 03:05
Limit: FCC_Part15.209_RE(3m)	Engineer: Dandy Li
Probe: VULB9162_0.03-8GHz	Polarity: Vertical
EUT: Electric Scooter	Power: AC 120V/60Hz
Worse Case Mode: Transmit by BLE at channel 2402MHz	

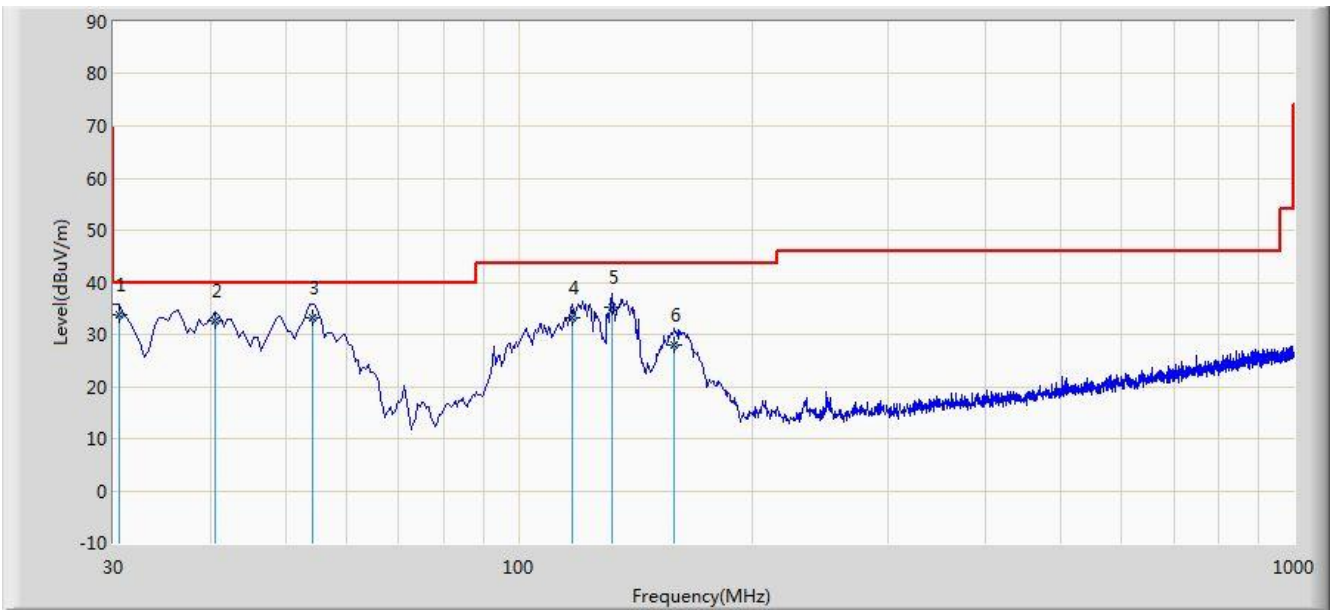

No	Flag	Mark	Frequency (MHz)	Measure Level (dBuV/m)	Reading Level (dBuV)	Over Limit (dB)	Limit (dBuV/m)	Factor (dB)	Type
1		*	30.485	33.715	21.565	-6.285	40.000	12.150	QP
2			40.670	32.516	18.526	-7.484	40.000	13.989	QP
3			54.250	33.331	18.525	-6.669	40.000	14.806	QP
4			117.300	33.255	21.553	-10.245	43.500	11.702	QP
5			131.850	35.296	25.366	-8.204	43.500	9.930	QP
6			159.010	28.063	18.256	-15.437	43.500	9.807	QP

Note 1: Measure Level (dB μ V/m) = Reading Level (dB μ V) + Factor (dB)

Factor (dB) = Cable Loss (dB) + Antenna Factor (dB/m)

Note 2: The test trace is same as the ambient noise and the amplitude of the emissions are attenuated more than 20dB below the permissible (the test frequency range: 9kHz ~ 30MHz, 18GHz ~ 25GHz), therefore no data appear in the report.

7.7. Radiated Restricted Band Edge Measurement

7.7.1. Test Result

Site: AC2	Time: 2017/06/28 - 05:43
Limit: FCC_Part15.209_RE(3m)	Engineer: Dandy Li
Probe: BBHA9120D_1-18GHz	Polarity: Horizontal
EUT: Electric Scooter	Power: AC 120V/60Hz
Test Mode: Transmit by BLE at Channel 2402MHz	

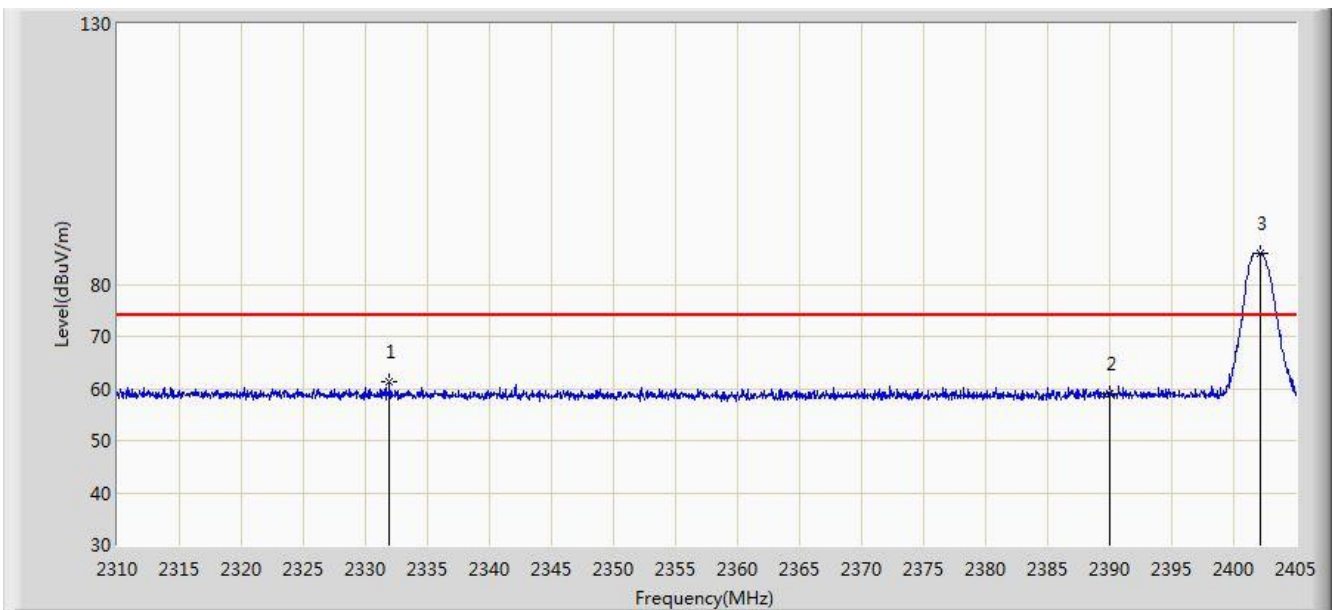

No	Flag	Mark	Frequency (MHz)	Measure Level (dBuV/m)	Reading Level (dBuV)	Over Limit (dB)	Limit (dBuV/m)	Factor (dB)	Type
1			2331.945	61.219	28.867	-12.781	74.000	32.352	PK
2			2390.000	58.923	26.645	-15.077	74.000	32.278	PK
3		*	2402.150	85.890	53.617	N/A	N/A	32.273	PK

Note: Measure Level (dB μ V/m) = Reading Level (dB μ V) + Factor (dB)

Factor (dB) = Cable Loss (dB) + Antenna Factor (dB/m)

Site: AC2	Time: 2017/06/28 - 05:44
Limit: FCC_Part15.209_RE(3m)	Engineer: Dandy Li
Probe: BBHA9120D_1-18GHz	Polarity: Horizontal
EUT: Electric Scooter	Power: AC 120V/60Hz
Test Mode: Transmit by BLE at Channel 2402MHz	

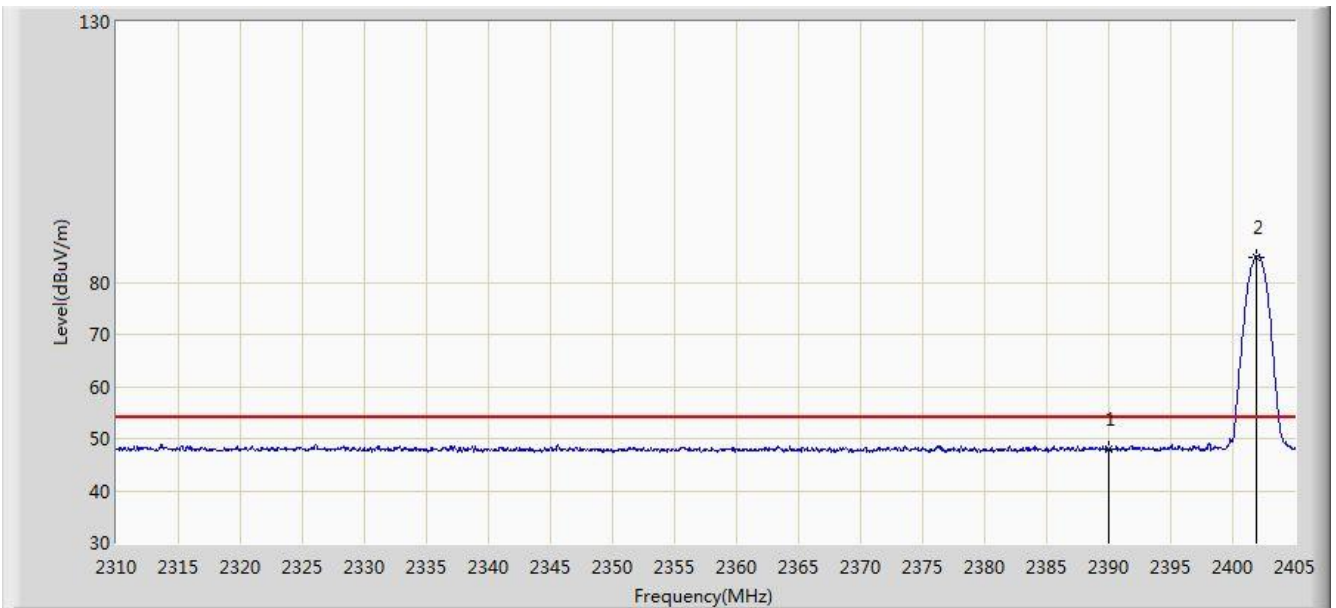

No	Flag	Mark	Frequency (MHz)	Measure Level (dBuV/m)	Reading Level (dBuV)	Over Limit (dB)	Limit (dBuV/m)	Factor (dB)	Type
1			2390.000	48.098	15.820	-5.902	54.000	32.278	AV
2		*	2401.865	84.883	52.609	N/A	N/A	32.274	AV

Note: Measure Level (dB μ V/m) = Reading Level (dB μ V) + Factor (dB)

Factor (dB) = Cable Loss (dB) + Antenna Factor (dB/m)

Site: AC2	Time: 2017/06/28 - 05:49
Limit: FCC_Part15.209_RE(3m)	Engineer: Dandy Li
Probe: BBHA9120D_1-18GHz	Polarity: Vertical
EUT: Electric Scooter	Power: AC 120V/60Hz
Test Mode: Transmit by BLE at Channel 2402MHz	

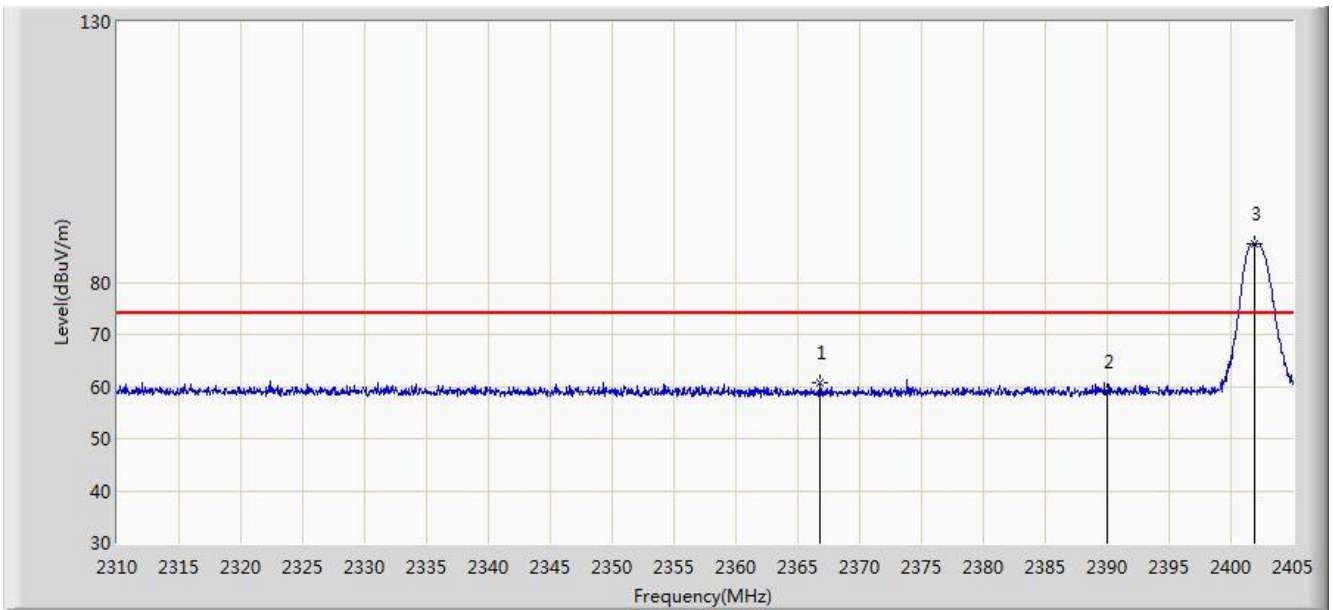

No	Flag	Mark	Frequency (MHz)	Measure Level (dBuV/m)	Reading Level (dBuV)	Over Limit (dB)	Limit (dBuV/m)	Factor (dB)	Type
1			2366.810	60.791	28.559	-13.209	74.000	32.232	PK
2			2390.000	59.064	26.786	-14.936	74.000	32.278	PK
3		*	2401.865	87.354	55.080	N/A	N/A	32.274	PK

Note: Measure Level (dB μ V/m) = Reading Level (dB μ V) + Factor (dB)

Factor (dB) = Cable Loss (dB) + Antenna Factor (dB/m)

Site: AC2	Time: 2017/06/28 - 05:51
Limit: FCC_Part15.209_RE(3m)	Engineer: Dandy Li
Probe: BBHA9120D_1-18GHz	Polarity: Vertical
EUT: Electric Scooter	Power: AC 120V/60Hz
Test Mode: Transmit by BLE at Channel 2402MHz	

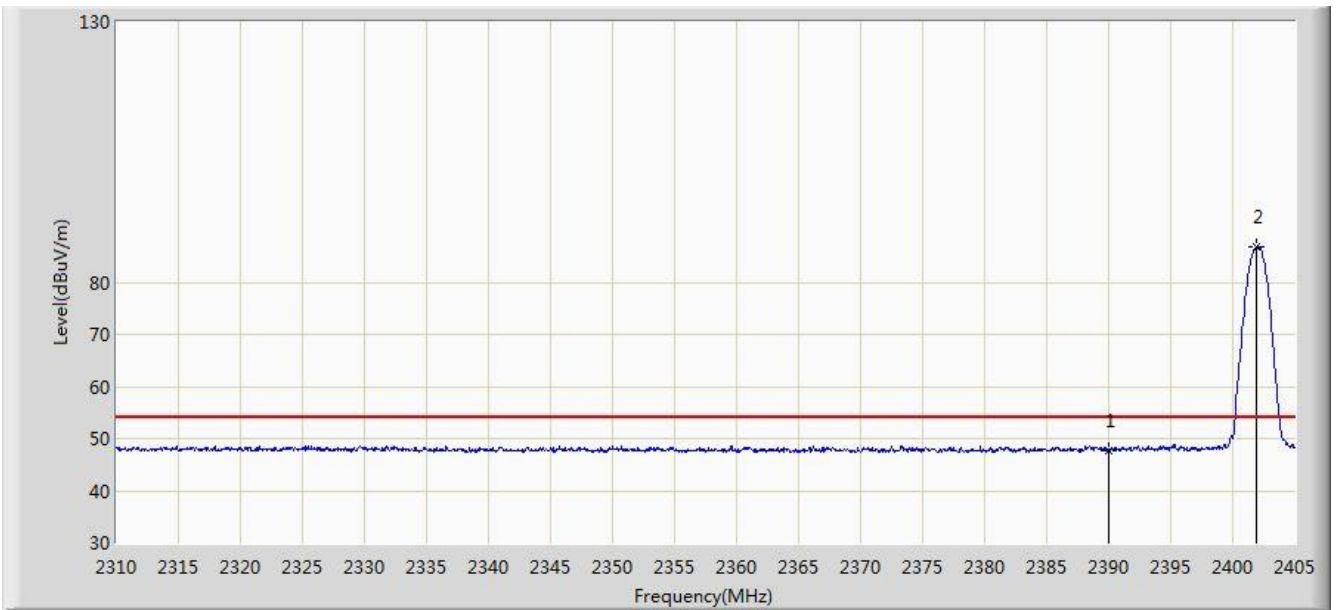

No	Flag	Mark	Frequency (MHz)	Measure Level (dBuV/m)	Reading Level (dBuV)	Over Limit (dB)	Limit (dBuV/m)	Factor (dB)	Type
1			2390.000	47.677	15.399	-6.323	54.000	32.278	AV
2		*	2401.865	86.697	54.423	N/A	N/A	32.274	AV

Note: Measure Level (dB μ V/m) = Reading Level (dB μ V) + Factor (dB)

Factor (dB) = Cable Loss (dB) + Antenna Factor (dB/m)

Site: AC2	Time: 2017/06/28 - 05:51
Limit: FCC_Part15.209_RE(3m)	Engineer: Dandy Li
Probe: BBHA9120D_1-18GHz	Polarity: Horizontal
EUT: Electric Scooter	Power: AC 120V/60Hz
Test Mode: Transmit by BLE at Channel 2480MHz	

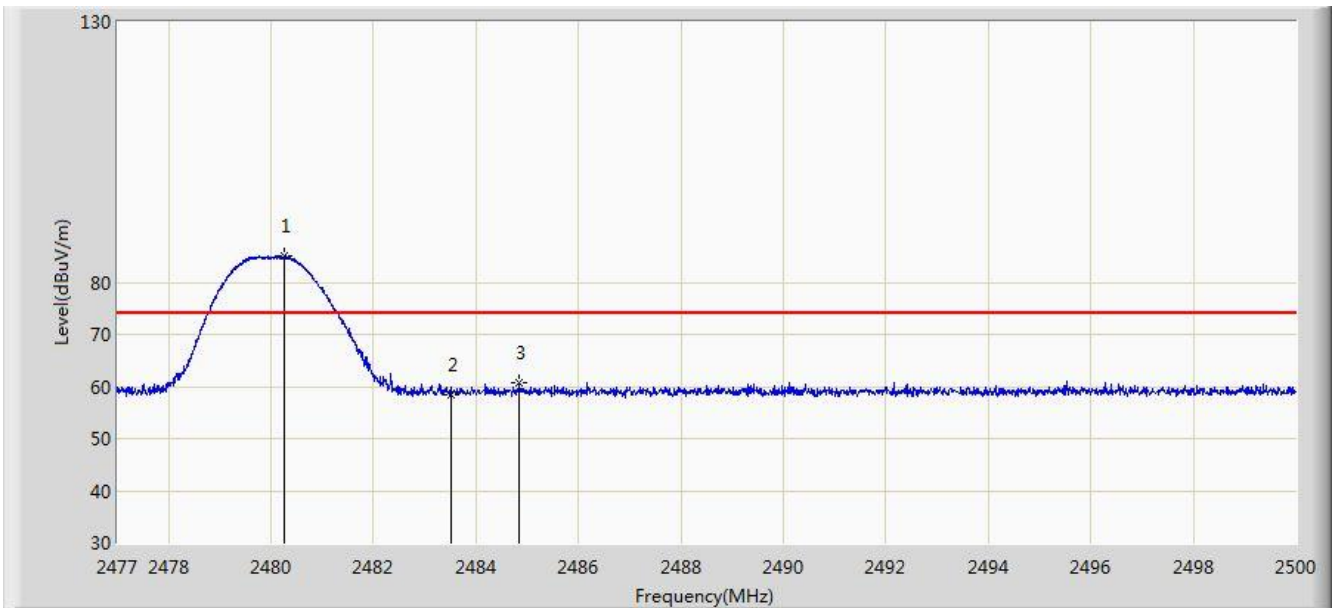

No	Flag	Mark	Frequency (MHz)	Measure Level (dBuV/m)	Reading Level (dBuV)	Over Limit (dB)	Limit (dBuV/m)	Factor (dB)	Type
1		*	2480.266	85.041	52.771	N/A	N/A	32.270	PK
2			2483.500	58.462	26.181	-15.538	74.000	32.282	PK
3			2484.843	60.680	28.394	-13.320	74.000	32.286	PK

Note: Measure Level (dB μ V/m) = Reading Level (dB μ V) + Factor (dB)

Factor (dB) = Cable Loss (dB) + Antenna Factor (dB/m)

Site: AC2	Time: 2017/06/28 - 05:53
Limit: FCC_Part15.209_RE(3m)	Engineer: Dandy Li
Probe: BBHA9120D_1-18GHz	Polarity: Horizontal
EUT: Electric Scooter	Power: AC 120V/60Hz
Test Mode: Transmit by BLE at Channel 2480MHz	

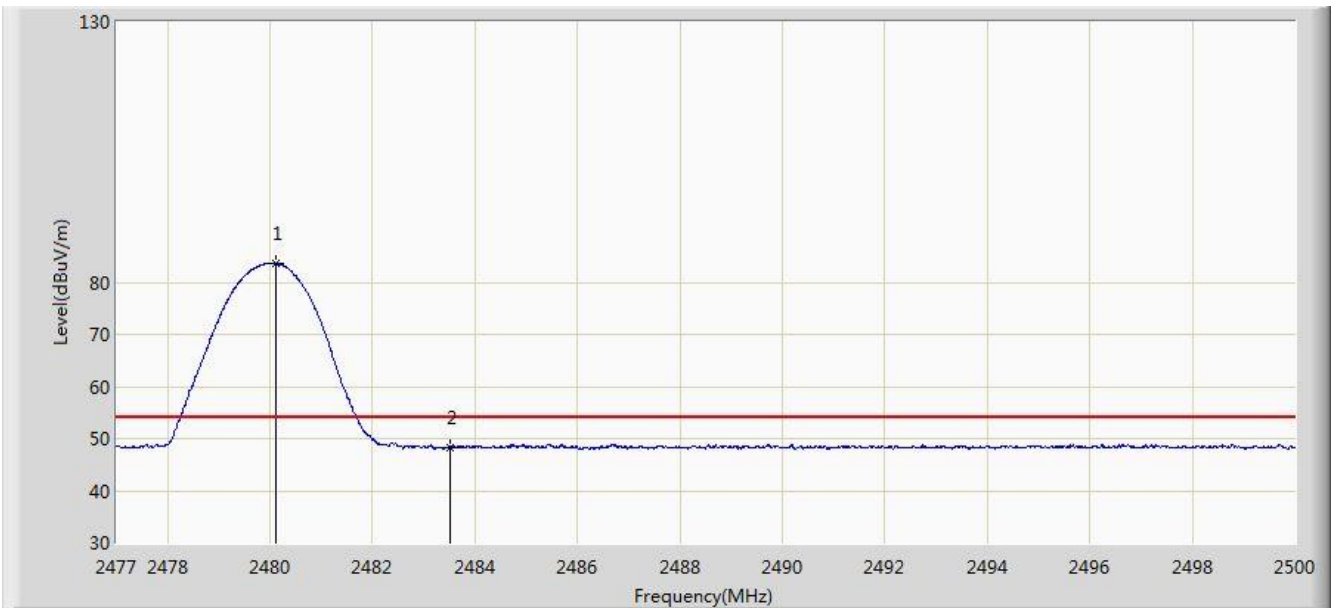

No	Flag	Mark	Frequency (MHz)	Measure Level (dBuV/m)	Reading Level (dBuV)	Over Limit (dB)	Limit (dBuV/m)	Factor (dB)	Type
1		*	2480.105	83.612	51.343	N/A	N/A	32.269	AV
2			2483.500	48.305	16.024	-5.695	54.000	32.282	AV

Note: Measure Level (dB μ V/m) = Reading Level (dB μ V) + Factor (dB)

Factor (dB) = Cable Loss (dB) + Antenna Factor (dB/m)

Site: AC2	Time: 2017/06/28 - 05:53
Limit: FCC_Part15.209_RE(3m)	Engineer: Dandy Li
Probe: BBHA9120D_1-18GHz	Polarity: Vertical
EUT: Electric Scooter	Power: AC 120V/60Hz
Test Mode: Transmit by BLE at Channel 2480MHz	

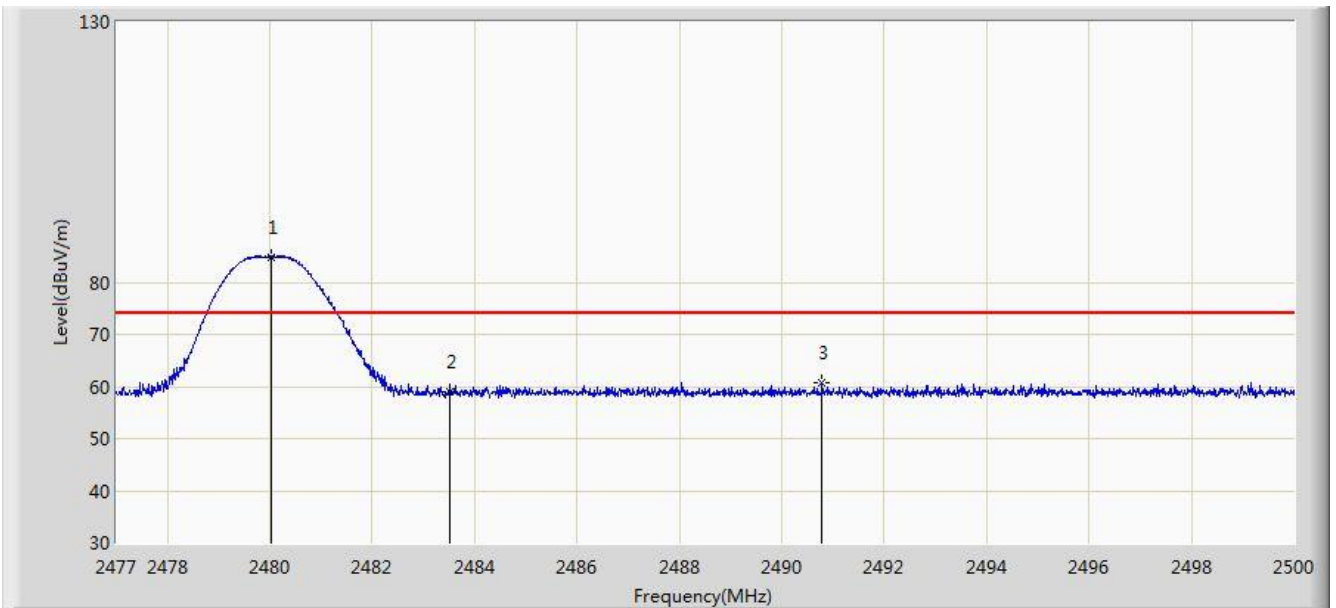

No	Flag	Mark	Frequency (MHz)	Measure Level (dBuV/m)	Reading Level (dBuV)	Over Limit (dB)	Limit (dBuV/m)	Factor (dB)	Type
1		*	2480.024	84.886	52.617	N/A	N/A	32.269	PK
2			2483.500	59.118	26.837	-14.882	74.000	32.282	PK
3			2490.789	60.610	28.304	-13.390	74.000	32.307	PK

Note: Measure Level (dB μ V/m) = Reading Level (dB μ V) + Factor (dB)

Factor (dB) = Cable Loss (dB) + Antenna Factor (dB/m)

Site: AC2	Time: 2017/06/28 - 05:55
Limit: FCC_Part15.209_RE(3m)	Engineer: Dandy Li
Probe: BBHA9120D_1-18GHz	Polarity: Vertical
EUT: Electric Scooter	Power: AC 120V/60Hz
Test Mode: Transmit by BLE at Channel 2480MHz	

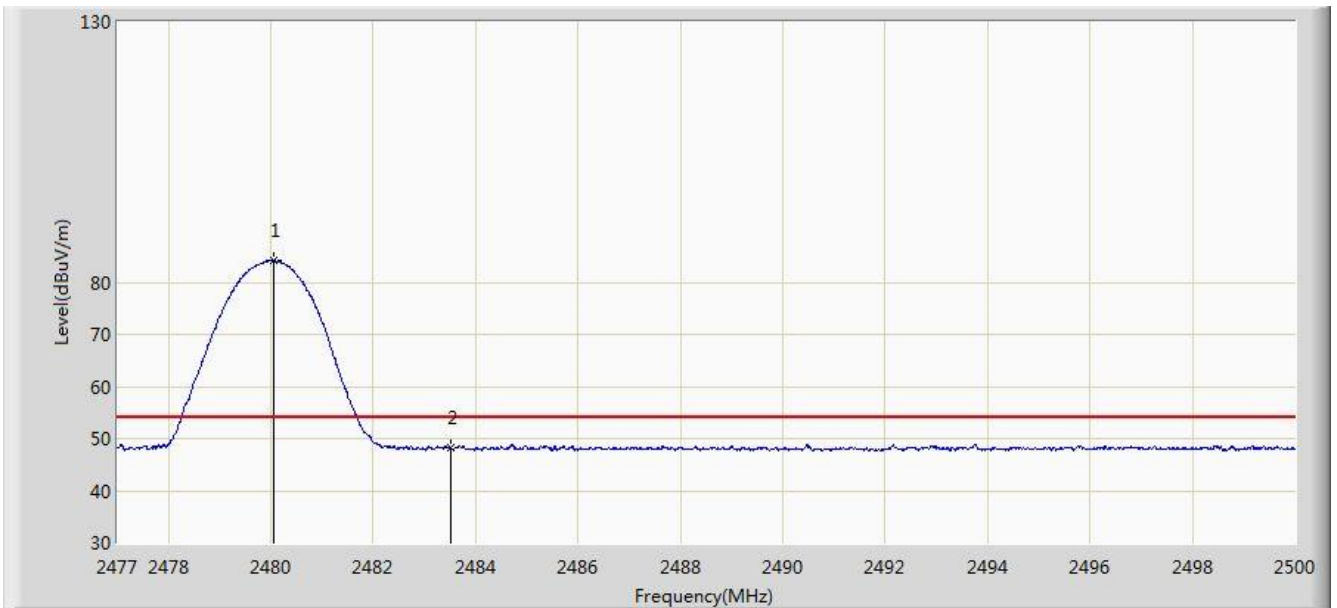

No	Flag	Mark	Frequency (MHz)	Measure Level (dBuV/m)	Reading Level (dBuV)	Over Limit (dB)	Limit (dBuV/m)	Factor (dB)	Type
1		*	2480.059	84.084	51.815	N/A	N/A	32.269	AV
2			2483.500	48.324	16.043	-5.676	54.000	32.282	AV

Note: Measure Level (dB μ V/m) = Reading Level (dB μ V) + Factor (dB)

Factor (dB) = Cable Loss (dB) + Antenna Factor (dB/m)

7.8. AC Conducted Emissions Measurement

7.8.1. Test Limit

FCC Part 15 Subpart C Paragraph 15.207 Limits		
Frequency (MHz)	QP (dBuV)	AV (dBuV)
0.15 - 0.50	66 - 56	56 - 46
0.50 - 5.0	56	46
5.0 - 30	60	50

Note 1: The lower limit shall apply at the transition frequencies.

Note 2: The limit decreases linearly with the logarithm of the frequency in the range 0.15MHz to 0.5MHz.

7.8.2. Test Setup

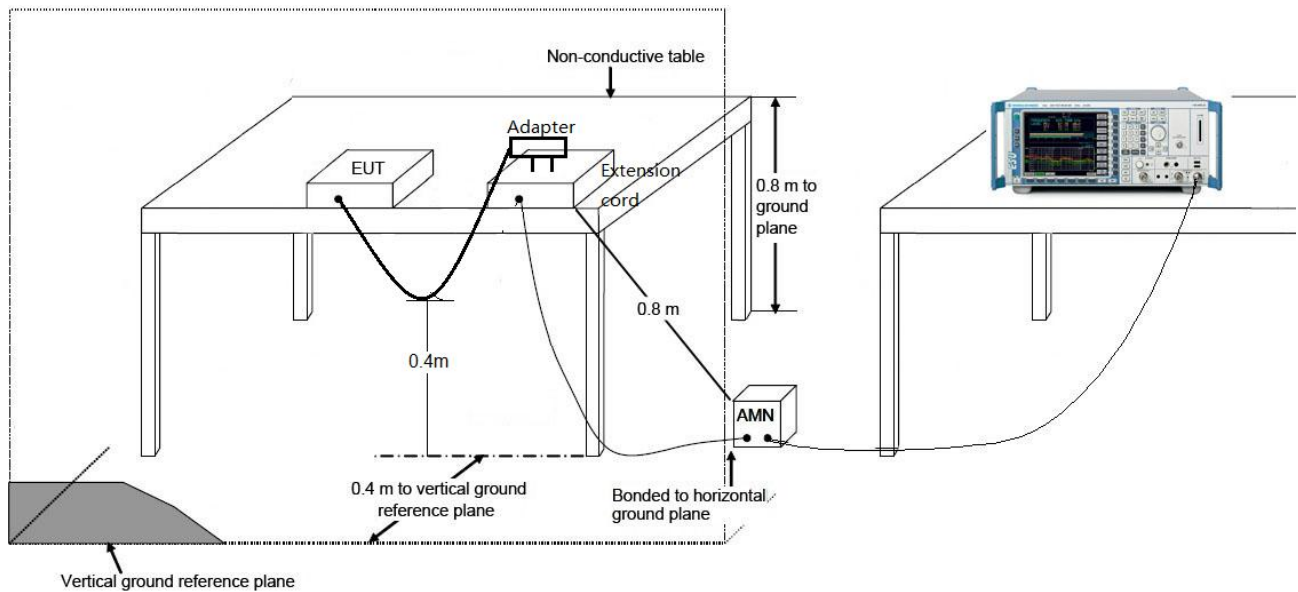

7.8.3. Test Result

Site: SR2	Time: 2017/06/27 - 21:36
Limit: FCC_Part15.207_CE_AC Power	Engineer: Bacon Dong
Probe: ENV216_101683_Filter On	Polarity: Line
EUT: Electric Scooter	Power: AC 120V/60Hz
Worst Case Mode: Transmit by BLE at channel 2402MHz	

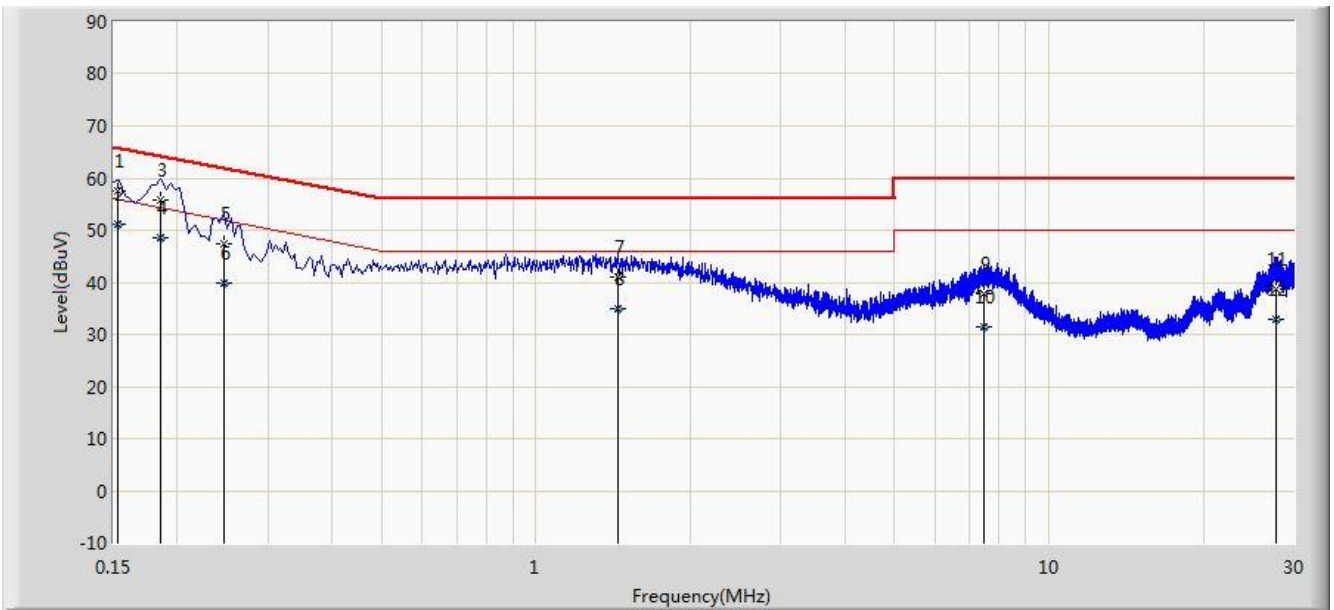

No	Flag	Mark	Frequency (MHz)	Measure Level (dBuV)	Reading Level (dBuV)	Over Limit (dB)	Limit (dBuV)	Factor (dB)	Type
1			0.153	57.547	46.700	-8.289	65.836	10.847	QP
2		*	0.153	51.147	40.300	-4.689	55.836	10.847	AV
3			0.186	55.886	45.848	-8.327	64.213	10.039	QP
4			0.186	48.441	38.403	-5.772	54.213	10.039	AV
5			0.246	47.291	37.330	-14.600	61.891	9.961	QP
6			0.246	39.803	29.842	-12.088	51.891	9.961	AV
7			1.442	40.872	30.980	-15.128	56.000	9.891	QP
8			1.442	35.009	25.118	-10.991	46.000	9.891	AV
9			7.458	37.690	27.521	-22.310	60.000	10.169	QP
10			7.458	31.371	21.201	-18.629	50.000	10.169	AV
11			27.750	38.776	28.519	-21.224	60.000	10.257	QP
12			27.750	32.835	22.578	-17.165	50.000	10.257	AV

Note: Measure Level (dBμV) = Reading Level (dBμV) + Factor (dB)

Factor (dB) = Cable Loss (dB) + LISN Factor (dB)

Site: SR2	Time: 2017/06/27 - 21:43
Limit: FCC_Part15.207_CE_AC Power	Engineer: Bacon Dong
Probe: ENV216_101683_Filter On	Polarity: Neutral
EUT: Electric Scooter	Power: AC 120V/60Hz
Worst Case Mode: Transmit by BLE at channel 2402MHz	

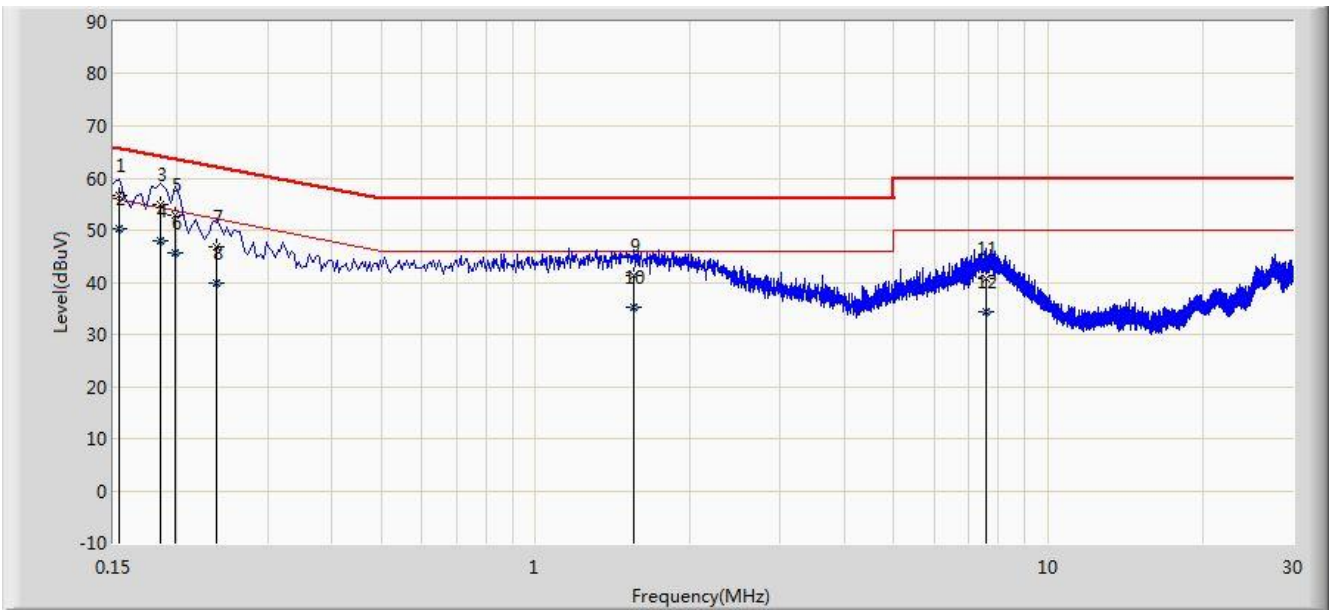

No	Flag	Mark	Frequency (MHz)	Measure Level (dBuV)	Reading Level (dBuV)	Over Limit (dB)	Limit (dBuV)	Factor (dB)	Type
1			0.154	56.662	45.946	-9.120	65.781	10.716	QP
2		*	0.154	50.242	39.526	-5.540	55.781	10.716	AV
3			0.186	54.867	44.832	-9.346	64.213	10.035	QP
4			0.186	47.981	37.946	-6.232	54.213	10.035	AV
5			0.198	53.026	43.012	-10.668	63.694	10.015	QP
6			0.198	45.549	35.535	-8.145	53.694	10.015	AV
7			0.238	46.817	36.825	-15.349	62.166	9.992	QP
8			0.238	39.773	29.781	-12.393	52.166	9.992	AV
9			1.554	41.274	31.387	-14.726	56.000	9.888	QP
10			1.554	35.174	25.287	-10.826	46.000	9.888	AV
11			7.562	40.606	30.424	-19.394	60.000	10.182	QP
12			7.562	34.241	24.059	-15.759	50.000	10.182	AV

Note: Measure Level (dBμV) = Reading Level (dBμV) + Factor (dB)

Factor (dB) = Cable Loss (dB) + LISN Factor (dB)

8. CONCLUSION

The data collected relate only the item(s) tested and show that the **Electric Scooter** is in compliance with Part 15C of the FCC Rules & IC Rules.

_____ The End _____