



FCC/IC TEST REPORT

According to

CFR47 §15.250/RSS-220,Issue1(March 2009)

Applicant : Ninebot (Changzhou) Tech Co., Ltd.

Address : 16F-17F, Block A, Building 3, Changwu Mid Road 18#, Wujin Dist.,
Changzhou, Jiangsu, China

Manufacturer : Ninebot (Changzhou) Tech Co., Ltd.

Address : 16F-17F, Block A, Building 3, Changwu Mid Road 18#, Wujin Dist.,
Changzhou, Jiangsu, China

Equipment : Segway miniPLUS

Model No. : N4M350

Trade Name : Segway

FCC ID : 2ALS8-NB5213

IC ID : 22636- NB5213

Test Period : Jun.15,2017~ Jun.29, 2017

- The test result refers exclusively to the test presented test model / sample.
- Without written approval of **CerpPASS Technology Corp.** the test report shall not be reproduced except in full.

I HEREBY CERTIFY THAT :

The measurements shown in this test report were made in accordance with the procedures given in **ANSI C63.10 – 2013** and the energy emitted by this equipment was **passed**.

FCC Part 15 in both radiated and conducted emission class B limits. Testing was carried out on Jun.15,2017~ Jun.29, 2017 at **CerpPASS Technology Corp.**

Prepared By:

Kerry Zhou

Approved by:

Miro Chueh (EMC/RF Manager)

Laboratory Accreditation:

CerpPASS Technology Corporation Test Laboratory

<input type="checkbox"/>	NVLAP LAB Code:	200954-0
	TAF LAB Code:	1439

CerpPASS Technology (SuZhou) Co., Ltd.

<input checked="" type="checkbox"/>	NVLAP LAB Code:	200814-0
	CNAS LAB Code:	L5515



Contents

1. Report of Measurements and Examinations	4
General Info	5
1.1 Description of EUT	5
1.2 Description of wireless module	6
1.3 Description of Antenna	6
1.4 EUT Exercise Software	6
1.5 Support equipment	7
2. General Information of Test Site	8
2.1 Information of Test Site	8
2.2 Measuring Equipment	8
2.3 Measurement Uncertainty	9
3. AC Conducted Emission Measurement	11
3.1 Test Limit	11
3.2 Test Standard	11
3.3 Test Procedures	11
3.4 Test Setup Layout	12
3.5 Test Result	13
4. Radiated Emission Measurement	15
4.1 Test Limit	15
4.2 Test Procedure	17
4.3 Test Setup Layout	18
4.4 Test Datas	20
5. -10dB Bandwidth Measurement	34
5.1 Test Limit	34
5.2 Test Setup Layout	34
5.3 Test Result	35
6. RMS Power in a 1 MHz Bandwidth	36
6.1 Test Limit	36
6.2 Test Datas	36
7. Peak Emissions in a 50 MHz Bandwidth	37
7.1 Test Limit	37
7.2 Test Datas	37
8. Public Exposure to Radio Frequency Energy Levels	38
8.1 Test Limit	38
8.2 Test Datas	38



History of this Test Report

Report No.	Version	Issue Date	Description
SEFI1705162	Rev 01	Jul.10, 2017	Original.
SEFI1705162	Rev 02	Jul.19, 2017	Update the Limit of radiated emission



1. Report of Measurements and Examinations

Test Requirement	FCC Rule Requirement	IC Rule Requirement	Compliance results
Antenna Requirement	15.203	RSS-220 5.1 (b)	Compliant
Conducted Emissions	15.207	RSS-GEN	Compliant
Spurious Radiated Emissions	15.250(d) (1) 15.209	RSS-220 3.4	Compliant
Radiated Emissions in GPS Bands	15.250(d) 2	RSS-220 5.3.1 (e)	Compliant
Wideband Bandwidth	15.250(b)	RSS-220 2 RSS-220 5.1	Compliant
RMS Power in a 1 MHz Bandwidth	15.250(d) 1	RSS-220 5.3.1 (d)	Compliant
Peak Emissions in a 50 MHz Bandwidth	15.250(d) 3	RSS-220 5.3.1 (g)	Compliant
Operational Requirements	15.250(a)	RSS-220	Compliant
Radio Frequency Exposure	FCC OET Bulletin 65 1.1307(b)(1)	N/A	Compliant



General Info

1.1 Description of EUT

Product name	Segway miniPLUS	
Model No.	N4M350	
Power supply	Model:	HT-A10-120W-58.8V
	Input:	100~240V AC 50-60Hz 2.0A MAX
	Output:	58.8V $\overline{\text{---}}$ 2A



1.2 Description of wireless module

Operating Frequency	6489.6 MHz Center Frequency Nominal (Channel 5 – 500 MHz BW)
Modulation Type	Pulse Modulation, Frequency Hopping
Rate(Mbps)	0.11/0.85/6.81

Note: For more details, please refer to the EUT User manual.

1.3 Description of Antenna

Requirement: An intentional radiator shall be designed to ensure that no antenna other than that furnished by the responsible party shall be used with the device. The use of a permanently attached antenna or of an antenna that uses a unique coupling to the intentional radiator shall be considered sufficient to comply.

Result: The antenna utilized by the device under test is a surface mount PCB Type, non user replaceable unit.

Antenna	Peak Gain
PCB Antenna	8.08dBi for 5GHz band

1.4 EUT Exercise Software

1	Turn on the power of equipment.
2	Input RF test command and set the test mode and channel, then press OK to start continue transmit.



1.5 Support equipment

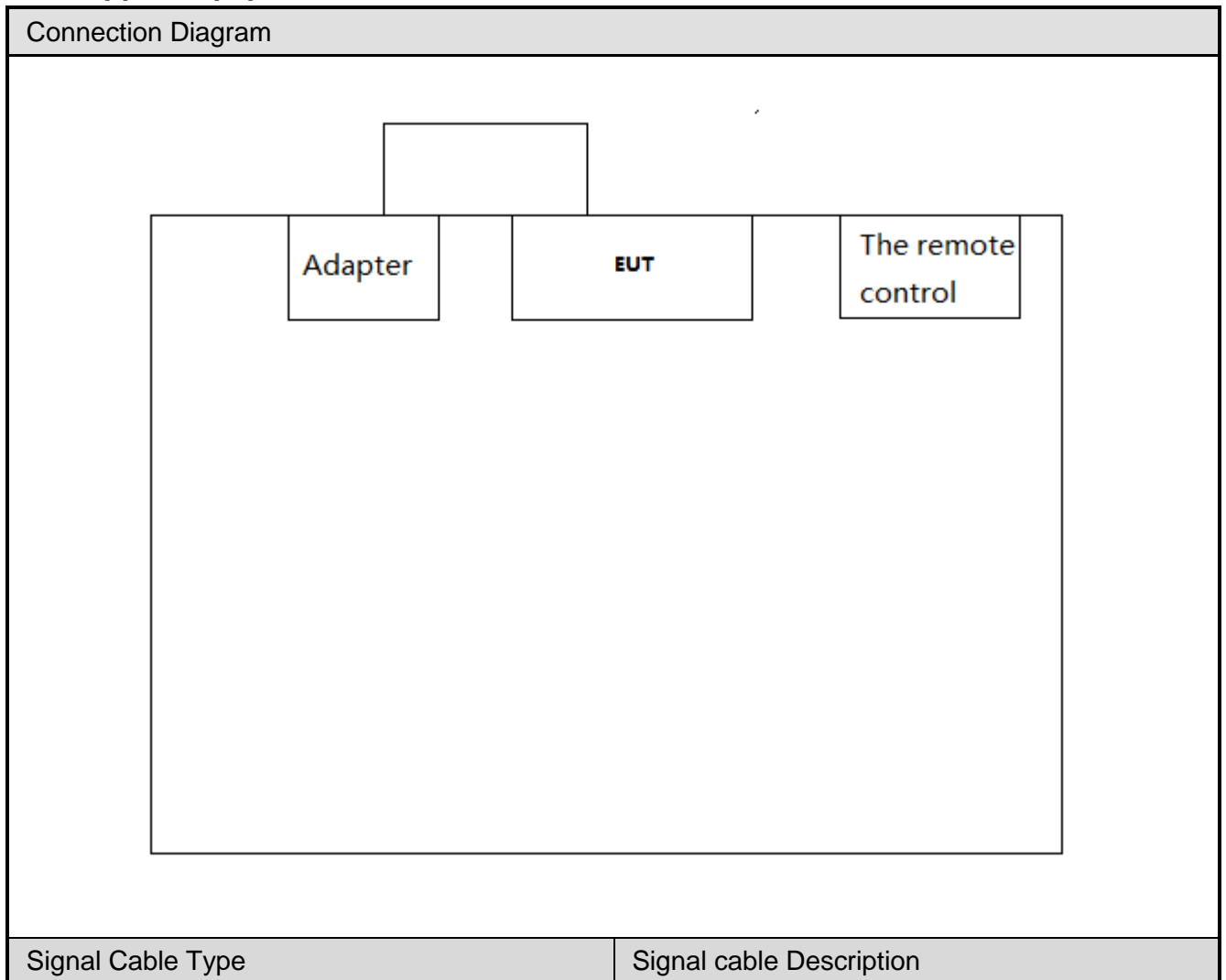



2. General Information of Test Site

2.1 Information of Test Site

Test Site	CerpPASS Technology(Suzhou) Co., Ltd.
Test Site Location	No.66,Tangzhuang Road, Suzhou Industrial Park, Jiangsu 215006, China
NVLAP LAB Code	200814-0
FCC Registration Number	916572, 331395
IC Registration Number	7290A-1, 7290A-2
VCCI Registration Number	T-1945 for Telecommunication Test C-2919 for Conducted emission test R-2670 for Radiated emission test below 1GHz G-227 for Radiated emission test above 1GHz

2.2 Measuring Equipment

RF Conducted Measuring Equipment-AC104					
Instrument/Ancillary	Manufacturer	Model No.	Serial No.	Calibration Date	Valid Date.
Peak Power Sensor	Boonton	55006	9778	2017.06.08	2018.06.07
Series Power Meter	ANRITSU	ML2495A	1224005	2017.03.27	2018.03.26
Spectrum Analyzer	N9010A	Agilent	MY53400169	2016.11.11	2018.11.11
Spectrum Analyzer	E4407B	Agilent	MY44211883	2016.10.15	2017.10.14
Temperature/Humidity Meter	Zhicheng	ZC1-11	CEP-TH-003	2017.03.31	2018.03.30

AC Conducted Emission Measuring Equipment-SR101					
Instrument/Ancillary	Manufacturer	Model No.	Serial No.	Calibration Date	Valid Date.
EZ-EMC	Fala	Ver CT3A1	N/A	N/A	N/A
EMI Test Receiver	R&S	ESCI	100565	2017.03.26	2018.03.25
Artificial-Mains-Network	R&S	ESH2-Z5	100182	2016.08.31	2017.08.30
Line Impedance Stabilization Network	FCC	FCC-LISN-50-200-2-02	112087	2016.08.31	2017.08.30
Temperature/Humidity Meter	Zhicheng	ZC1-11	CEP-TH-004	2017.03.29	2018.03.28



Radiated Measuring Equipment-AC102					
Instrument/Ancillary	Manufacturer	Model No.	Serial No.	Calibration Date	Valid Date.
Loop Antenna	R&S	HFH2-Z2	100150	2016.08.31	2017.08.30
Bilog Antenna	Sunol Science	JB1	A072414-1	2017.04.16	2018.04.15
Broad-Band Horn Antenna	Schwarzbeck	BBHA9120D	9120D-619	2016.07.16	2017.07.15
Broad-Band Horn Antenna	Schwarzbeck	BBHA9170	9170-348	2017.05.07	2018.05.06
Preamplifier	HP	8447F	3113A05582	2017.03.26	2018.03.25
Preamplifier	EMCI	EMC-051835	980085	2016.09.06	2017.09.05
Preamplifier	COM-POWER	PA-840	711885	2017.03.26	2018.03.25
EMI Test Receiver	R&S	ESCI-3	101183	2016.06.29	2017.06.28
Spectrum Analyzer	N9010A	Agilent	MY53400169	2016.11.11	2017.11.11
Spectrum Analyzer	R&S	FS040	100324	2017.03.26	2018.03.25
Temperature/ Humidity Meter	Zhicheng	ZC1-11	CEP-TH-002	2017.03.31	2018.03.30

2.3 Measurement Uncertainty

ISO/IEC 17025 requires that an estimate of the measurement uncertainties associated with the emissions test results be included in the report. The measurement uncertainties given below are based on a 95% confidence level (based on a coverage factor (k=2)).

RF Conducted Measurement

Test Item	Uncertainty	Limit
Radio Frequency	$\pm 8.7 \times 10^{-7}$	$\pm 1 \times 10^{-5}$
RF output power, conducted	$\pm 0.63\text{dB}$	$\pm 1.5\text{dB}$
Power density, conducted	$\pm 1.21\text{dB}$	$\pm 3\text{dB}$
Unwanted emissions, conducted	30-1000MHz	$\pm 0.51\text{dB}$
	1-25GHz	$\pm 0.67\text{dB}$
All emissions, radiated	30-1000MHz	$\pm 2.28\text{dB}$
	1-25GHz	$\pm 2.59\text{dB}$
Temperature	$\pm 0.8^\circ\text{C}$	$\pm 1^\circ\text{C}$
Humidity	$\pm 3\%$	$\pm 5\%$
DC and low frequency voltages	$\pm 3\%$	$\pm 3\%$



AC Conducted Measurement

Measurement	Frequency	Uncertainty
Conducted emissions(LINE)	9KHz-30MHz	+/- 0.7738 dB
Conducted emissions(NEUTRAL)	9KHz-30MHz	+/- 0.7886 dB
Conducted emissions(10Mbps)	150KHz-30MHz	+/- 1.3013dB
Conducted emissions(100Mbps)	150KHz-30MHz	+/- 1.3197 dB
Conducted emissions(1000Mbps)	150KHz-30MHz	+/- 1.2987 dB

Radiated Measurement

Measurement	Polarity	Frequency	Uncertainty
Radiated emissions	Horizontal	below 1GHz	+/- 3.8936 dB
	Vertical	below 1GHz	+/- 3.8928 dB
	Horizontal	above 1GHz	+/- 5.18858dB
	Vertical	above 1GHz	+/- 5.18928 dB



3. AC Conducted Emission Measurement

3.1 Test Limit

Conducted Emissions were measured from 150 kHz to 30 MHz with a bandwidth of 9 KHz on the 120 VAC power and return leads of the EUT according to the methods defined in ANSI C63.10-2013 Section 6.2. The EUT was placed on a nonmetallic stand in a shielded room 0.8 meters above the ground plane as shown in section 6.2.2. The interface cables and equipment positioning were varied within limits of reasonable applications to determine the position produced maximum conducted emissions.

FCC Part 15 Subpart C Paragraph 15.207 Limits		
Frequency (MHz)	Quasi Peak (dB μ V)	Average (dB μ V)
0.15 – 0.5	66-56*	56-46*
0.5 – 5.0	56	46
5.0 – 30.0	60	50

*Decreases with the logarithm of the frequency.

3.2 Test Standard

Tested according to ANSI C63.10: 2013 Section 6.2 for compliance to FCC 47CFR 15.247 Part15.207 (a) requirements.

3.3 Test Procedures

The EUT was placed on a platform of nominal size, 1 m by 1.5 m, raised 80 cm above the conducting ground plane. The vertical conducting plane was located 40 cm to the rear of the EUT. All other surfaces of EUT were at least 80 cm from any other grounded conducting surface. The EUT and simulators are connected to the main power through a line impedance stabilization network (LISN). The LISN provides a 50 ohm /50uH coupling impedance for the measuring equipment. The peripheral devices are also connected to the main power through a LISN. (Please refer to the block diagram of the test setup and photographs) Each current-carrying conductor of the EUT power cord, except the ground (safety) conductor, was individually connected through a LISN to the input power source. The excess length of the power cord between the EUT and the LISN receptacle were folded back and forth at the center of the lead to form a bundle not exceeding 40 cm in length.

Conducted emissions were investigated over the frequency range from 0.15MHz to 30MHz using a receiver bandwidth of 9 kHz.



3.4 Test Setup Layout

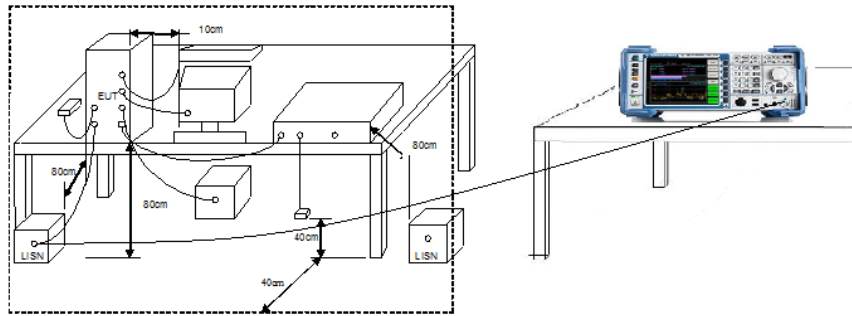



3.5 Test Result

Test Mode :	Mode 1: Normal Operation		
AC Power :	AC 120V/60Hz	Phase:	LINE
Temperature :	26°C	Humidity:	60%
Pressure(mbar) :	1002	Date:	2017/06/15

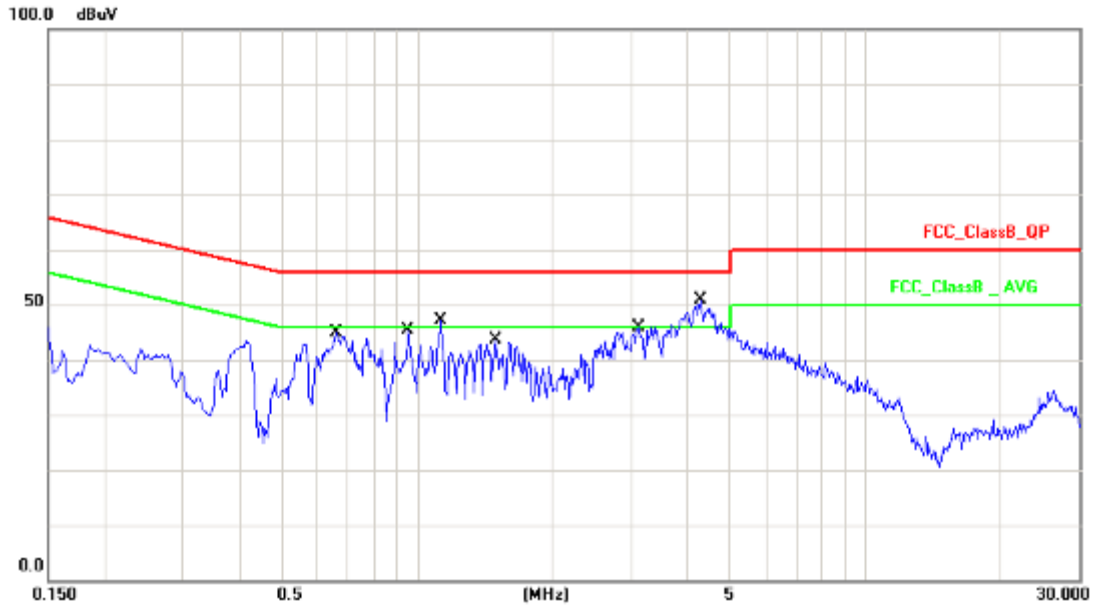

No.	Frequency (MHz)	Factor (dB)	Reading (dBuV)	Level (dBuV)	Limit (dBuV)	Margin (dB)	Detector
1	0.6580	10.15	29.14	39.29	56.00	-16.71	QP
2	0.6580	10.15	23.48	33.63	46.00	-12.37	AVG
3	0.9580	10.16	31.10	41.26	56.00	-14.74	QP
4	0.9580	10.16	25.49	35.65	46.00	-10.35	AVG
5	1.1340	10.16	31.64	41.80	56.00	-14.20	QP
6	1.1340	10.16	27.94	38.10	46.00	-7.90	AVG
7	1.4980	10.16	28.56	38.72	56.00	-17.28	QP
8	1.4980	10.16	22.77	32.93	46.00	-13.07	AVG
9	3.1100	10.19	32.60	42.79	56.00	-13.21	QP
10	3.1100	10.19	26.29	36.48	46.00	-9.52	AVG
11	4.2900	10.22	35.39	45.61	56.00	-10.39	QP
12	4.2900	10.22	28.50	38.72	46.00	-7.28	AVG

Note: Measurement Level = Reading Level + Correct Factor



Test Mode :	Mode 1: Normal Operation		
AC Power :	AC 120V/60Hz	Phase :	NEUTRAL
Temperature :	26°C	Humidity :	60%
Pressure(mbar) :	1002	Date:	2017/06/15

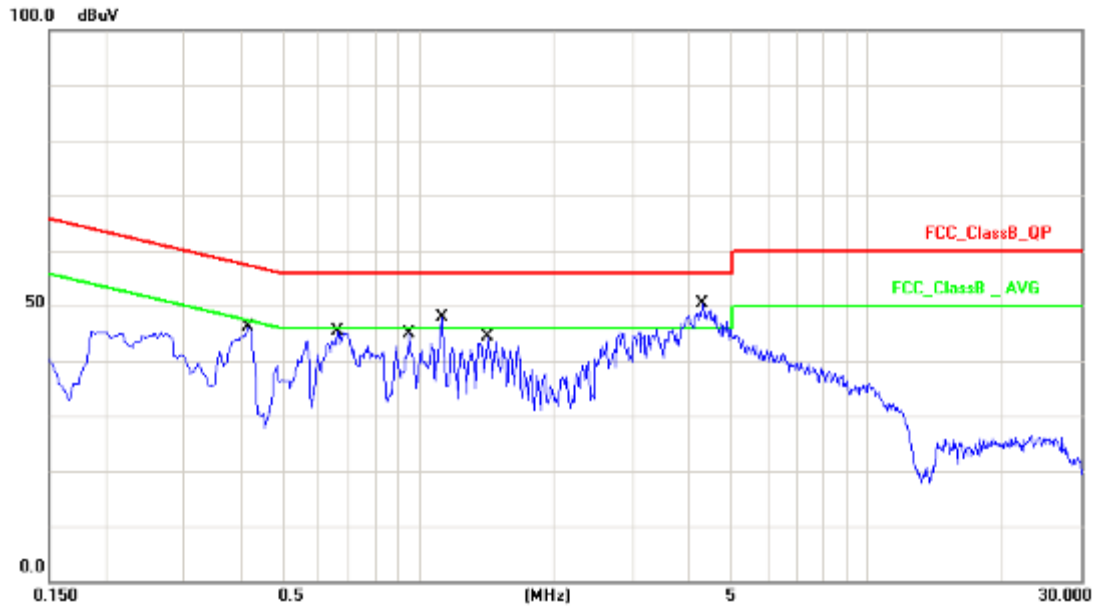

No.	Frequency (MHz)	Factor (dB)	Reading (dBuV)	Level (dBuV)	Limit (dBuV)	Margin (dB)	Detector
1	0.4180	10.15	33.30	43.45	57.49	-14.04	QP
2	0.4180	10.15	23.14	33.29	47.49	-14.20	AVG
3	0.6580	10.16	29.46	39.62	56.00	-16.38	QP
4	0.6580	10.16	22.16	32.32	46.00	-13.68	AVG
5	0.9540	10.18	31.06	41.24	56.00	-14.76	QP
6	0.9540	10.18	26.28	36.46	46.00	-9.54	AVG
7	1.1340	10.18	33.78	43.96	56.00	-12.04	QP
8	1.1340	10.18	27.27	37.45	46.00	-8.55	AVG
9	1.4299	10.18	31.24	41.42	56.00	-14.58	QP
10	1.4299	10.18	27.46	37.64	46.00	-8.36	AVG
11	4.3100	10.24	34.88	45.12	56.00	-10.88	QP
12	4.3100	10.24	26.89	37.13	46.00	-8.87	AVG

Note: Measurement Level = Reading Level + Correct Factor



4. Radiated Emission Measurement

4.1 Test Limit

Spurious Radiated Emissions (15.250 (d) (1), 15.209)

Requirement: The radiated emissions at or below 960 MHz from a device operating under the provisions of this section shall not exceed the emission levels in Section 15.209. The radiated emissions above 960 MHz from a device operating under the provisions of this section shall not exceed the following average limits when measured using a resolution bandwidth of 1 MHz:

Frequency (MHz)	EIRP (dBm)	EIRP at 3 Meters (dB μ V/m)
960 - 1610	-75.3	19.9
1610 - 1990	-63.3	31.9
1990 - 3100	-61.3	33.9
3100 – 5925	-51.3	43.9
5925 – 7250	-41.3	53.9
7250 – 10,600	-51.3	43.9
Above 10,600	-61.3	33.9

Spurious Radiated Emissions (RSS-220 5.3.1 (d))

Requirement: The radiated emissions at or below 960 MHz from a device shall not exceed the limits in Section 3.4. The radiated emissions above 960 MHz from a device shall not exceed the following average limits when measured using a resolution bandwidth of 1 MHz:

Frequency (MHz)	EIRP (dBm)	EIRP at 3 Meters (dB μ V/m)
960 - 1610	-75.3	19.9
1610 – 4750	-70.0	25.2
4750 – 10,600	-43.1	53.9
Above 10,600	-61.3	33.9



Spurious Radiated Emissions (15.250 (d) (1), 15.209 Continued)

Radiated Emissions Field Strength Limits at 3 Meters (Section 15.250 (d),15.209, RSS-220 3.4)

FCC Part 15 Subpart C Paragraph 15.209		
FREQUENCIES (MHz)	FIELD STRENGTH (micro volts/meter)	MEASUREMENT DISTANCE (meters)
0.009~0.490	2400/F(kHz)	300
0.490~1.705	24000/F(kHz)	30
1.705~30.0	30	30
30~88	100	3
88~216	150	3
216~960	200	3
Above 960	500	3

Note 1: The lower limit shall apply at the transition frequency.

Note 2: Distance refers to the distance in meters between the measuring instrument Antenna and the closed point of any part of the device or system.

Note 3: E field strength (dBuV/m) = 20 log E field strength (uV/m)

Note 4: **Except as provided in paragraph (g), fundamental emissions from intentional radiators operating under this section shall not be located in the frequency bands 54-72 MHz, 76-88 MHz, 174-216 MHz or 470-806 MHz. However, operation within these frequency bands is permitted under other sections of this part, e.g., §§15.231 and 15.241.

In addition to the radiated emission limits specified in the table in paragraph (a)(b) of this section, UWB transmitters operating under the provisions of this section shall not exceed the following average limits when measured using a resolution bandwidth of no less than 1 kHz:

Frequency in MHz	EIRP in dBm
1164-1240	-85.3
1559-1610	-85.3



4.2 Test Procedure

1. The testing follows the guidelines in ANSI C63.10-2013.
2. The EUT was arranged to its worst case and then tune the antenna tower (from 1 m to 4 m) and turntable (from 0 degree to 360 degrees) to find the maximum reading. A pre-amp and a high pass filter are used for the test in order to get better signal level. Both horizontal and vertical polarizations of the antenna are set to make the measurement.
3. The EUT was placed on a turntable with 0.8 meter above ground.
4. The EUT was set 3 meters from the interference receiving antenna, which was mounted on the top of a variable height antenna tower.
5. Corrected Reading: Antenna Factor + Cable Loss + Read Level - Preamp Factor = Level
6. For measurement below 1GHz, the initial step in collecting radiated emission data is a spectrum analyzer peak detector mode pre-scanning the measurement frequency range. Significant peaks are then marked and then Quasi Peak detector mode re-measured. If the emission level of the EUT measured by the peak detector is 3 dB lower than the applicable limit, the peak emission level will be reported. Otherwise, the emission measurement will be repeated using the quasi-peak detector and reported.
7. For the actual test configuration, please refer to the related Item in this test report (Photographs of the Test Configuration)



4.3 Test Setup Layout

9kHz~30MHz Test Setup

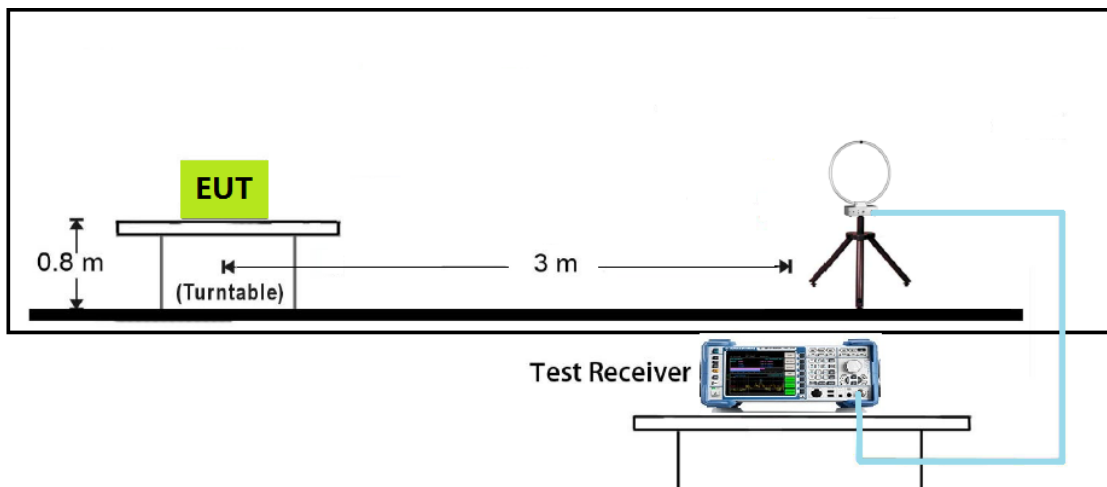

30MHz~960MHz Test Setup

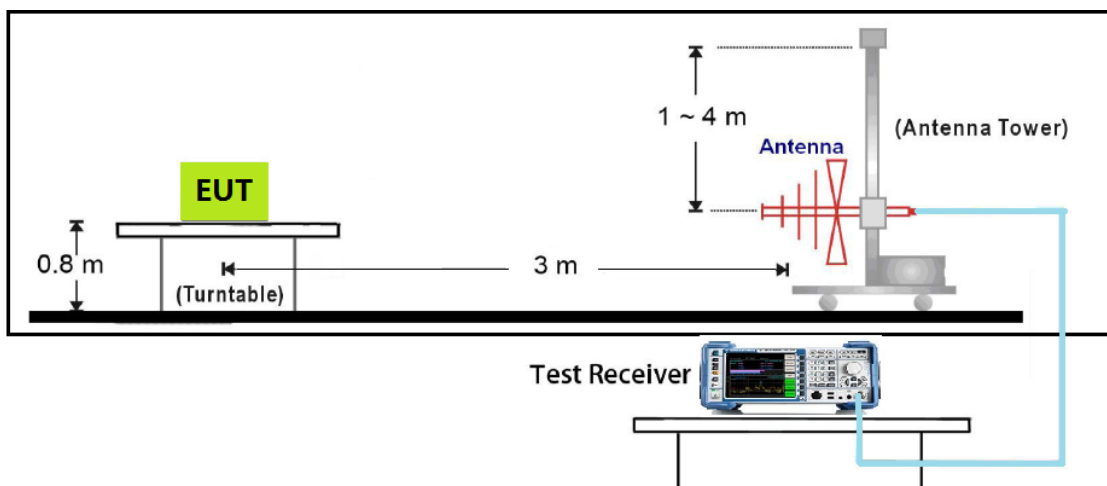



1GHz~18GHz Test Setup

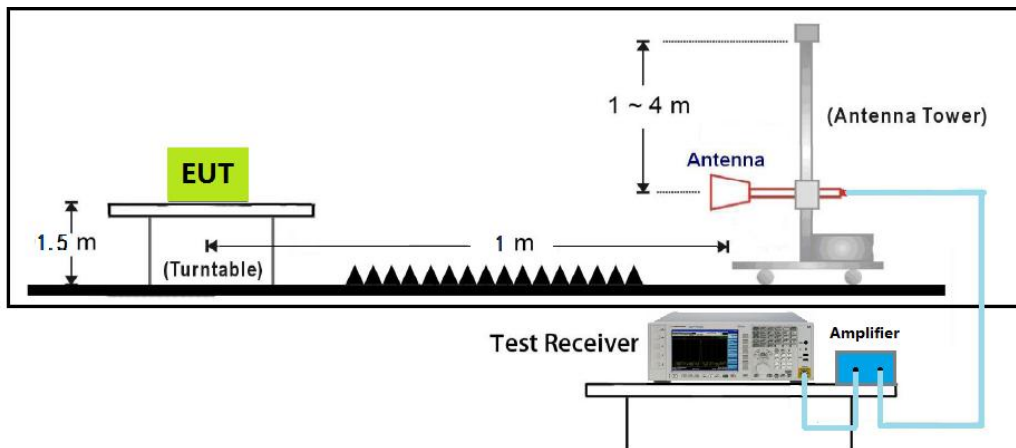

18GHz~40GHz Test Setup

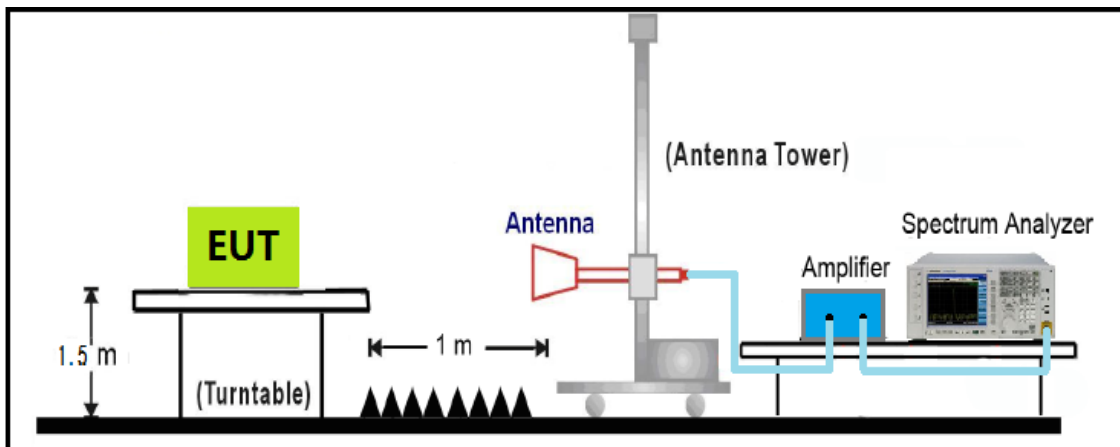



4.4 Test Datas

Limit: FCC_Part15.209_RE(3m)	Margin: 0
Probe: HFH2-Z2 (9KHz-30MHz)	Polarity: Face on
Note: There is the ambient noise within frequency range 9KHz-0.15MHz	

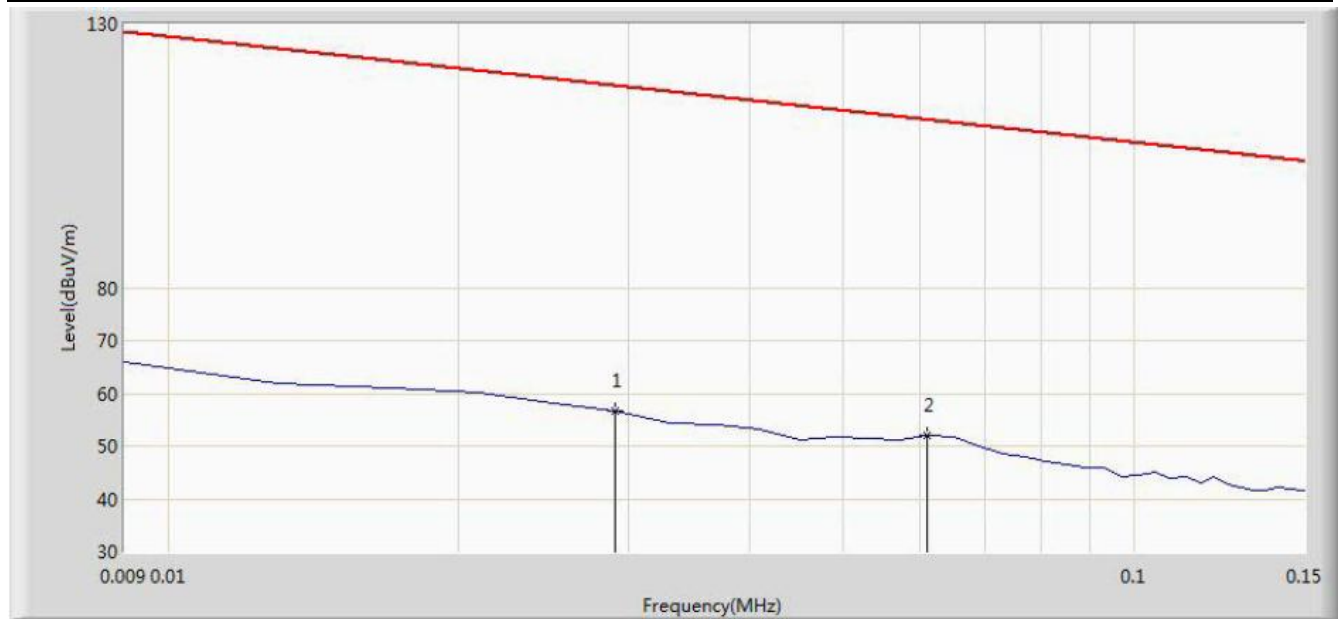

No.	Frequency (MHz)	Level (dBuV/m)	Reading (dBuV)	Margin (dB)	Limit (dBuV/m)	Factor (dB/m)	Det.
1	0.029	58.574	37.548	-59.768	118.342	21.026	QP
2	0.061	53.064	32.527	-58.823	111.887	20.537	QP

Note: Measure Level (dBuV/m) = Reading Level (dBuV) + Factor(dB).

Factor (dB)=Cable Loss(dB) + Antenna Factor (dB/m) - Pre_Amplifier Gain(dB)



Limit: FCC_Part15.209_RE(3m)	Margin: 0
Probe: HFH2-Z2 (9KHz-30MHz)	Polarity: Face on
Note: There is the ambient noise within frequency range 0.15MHz-30MHz	

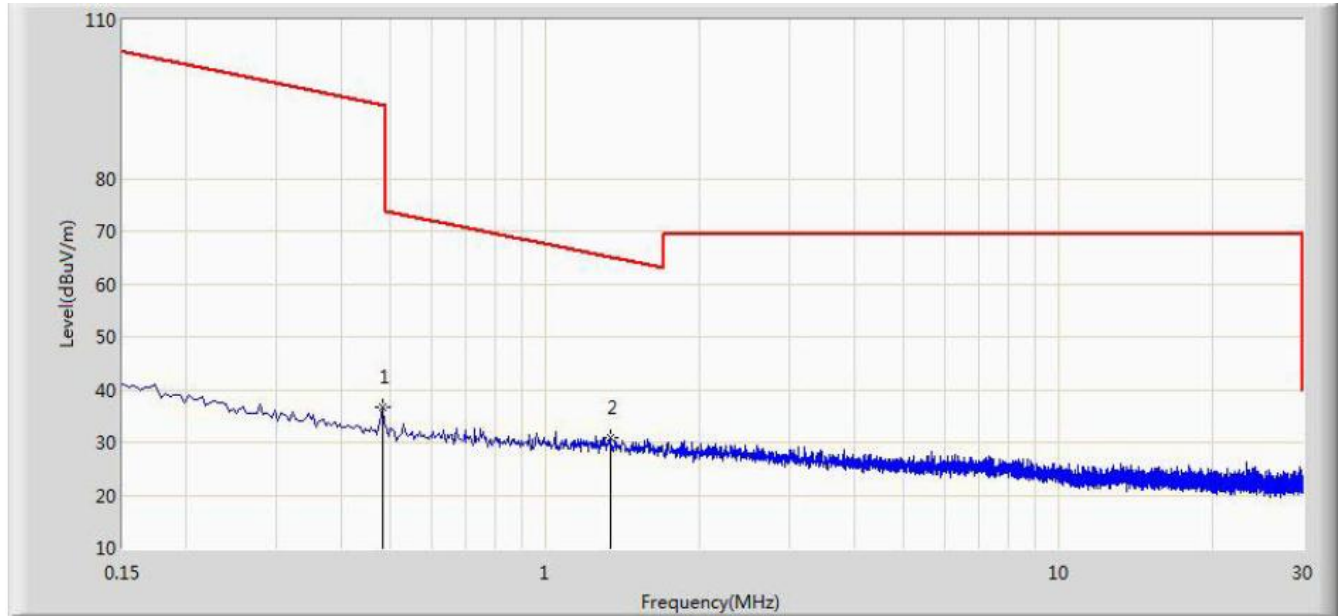

No.	Frequency (MHz)	Level (dBuV/m)	Reading (dBuV)	Margin (dB)	Limit (dBuV/m)	Factor (dB/m)	Det.
1	0.482	37.942	17.537	-56.001	93.943	20.405	QP
2	1.338	33.136	12.683	-31.963	65.099	20.453	QP

Note: Measure Level (dBuV/m) = Reading Level (dBuV) + Factor(dB).

Factor (dB)=Cable Loss(dB) + Antenna Factor (dB/m) - Pre_Amplifier Gain(dB)



Test Mode :	Mode 1		
AC Power :	AC 120V/60Hz	Ant. Polarization:	Horizontal
Temp :	24°C	Humidity :	53%
Pressure(mbar) :	1002	Date:	2017/06/25

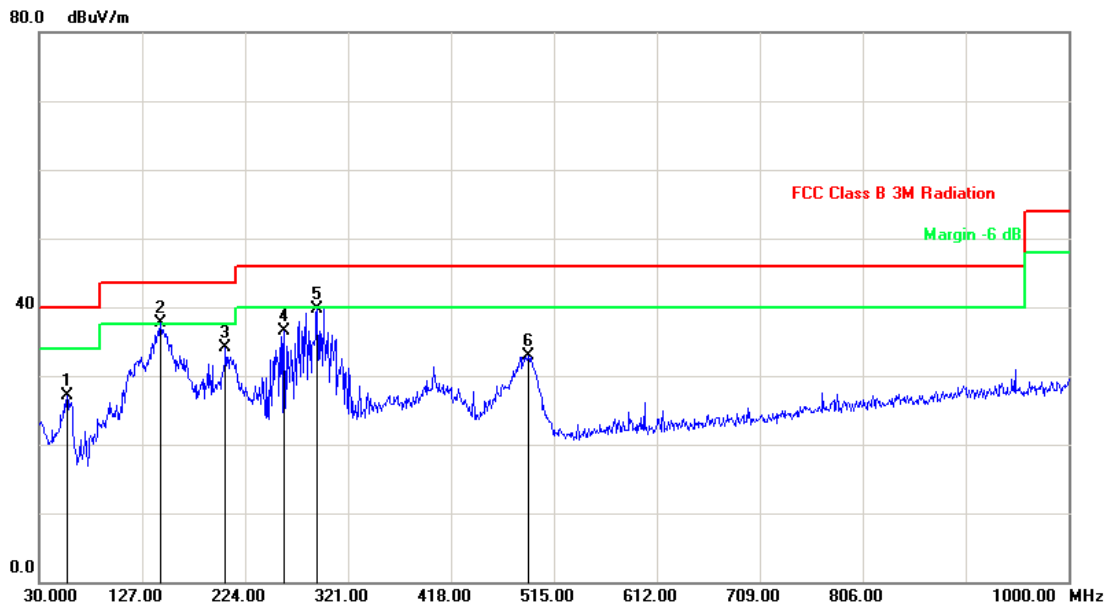

No.	Frequency (MHz)	Factor (dB/m)	Reading (dBuV)	Level (dBuV/m)	Limit (dBuV/m)	Margin (dB)	Det.	Height (cm)	Azimuth (deg)
1	56.1899	-13.73	40.79	27.06	40.00	-12.94	peak	200	10
2	144.4600	-11.87	49.65	37.78	43.50	-5.72	peak	200	32
3	205.5699	-13.26	47.31	34.05	43.50	-9.45	peak	200	288
4	260.8599	-11.03	47.50	36.47	46.00	-9.53	peak	200	11
5	291.8999	-10.32	50.01	39.69	46.00	-6.31	peak	200	61
6	490.7500	-7.06	39.97	32.91	46.00	-13.09	peak	100	242

Note: Measurement Level = Reading Level + Correct Factor



Test Mode :	Mode 1		
AC Power :	AC 120V/60Hz	Ant. Polarization:	Vertical
Temp :	24°C	Humidity :	53%
Pressure(mbar) :	1002	Date:	2017/06/25

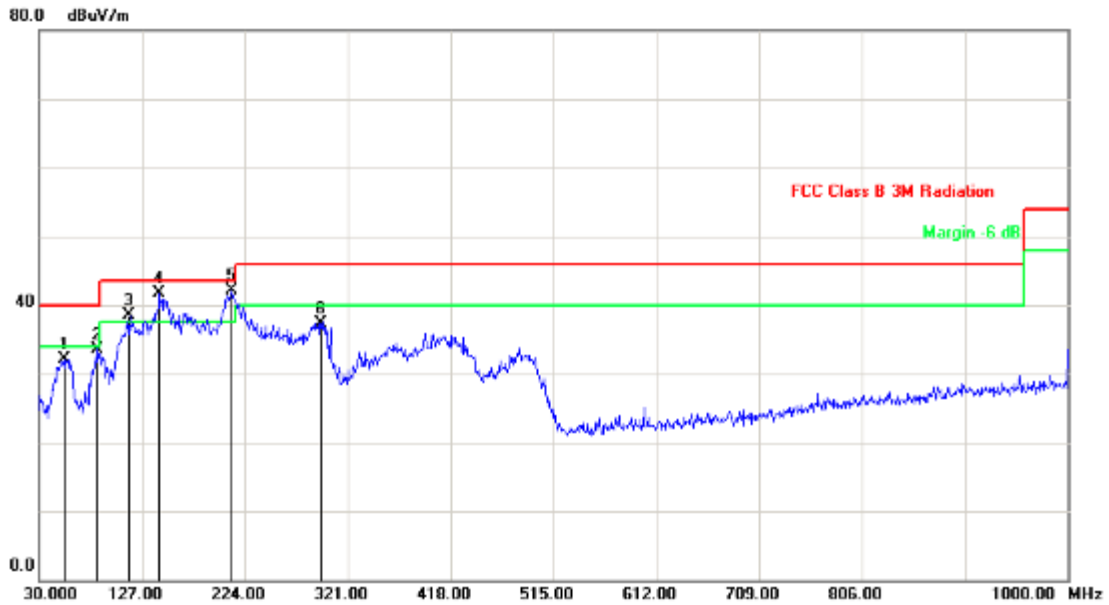

No.	Frequency (MHz)	Factor (dB/m)	Reading (dBuV)	Level (dBuV/m)	Limit (dBuV/m)	Margin (dB)	Det.	Height (cm)	Azimuth (deg)
1	54.2500	-13.66	45.83	32.17	40.00	-7.83	peak	200	215
2	85.2900	-17.90	51.50	33.60	40.00	-6.40	peak	100	148
3	115.3598	-11.21	49.70	38.49	43.50	-5.01	peak	100	15
4	143.4900	-11.81	53.59	41.78	43.50	-1.72	peak	200	265
5	211.3899	-13.55	55.69	42.14	43.50	-1.36	peak	200	302
6	295.7798	-10.19	47.53	37.34	46.00	-8.66	peak	100	14

Note: Measurement Level = Reading Level + Correct Factor



960MHz to 8 GHz Horizontal

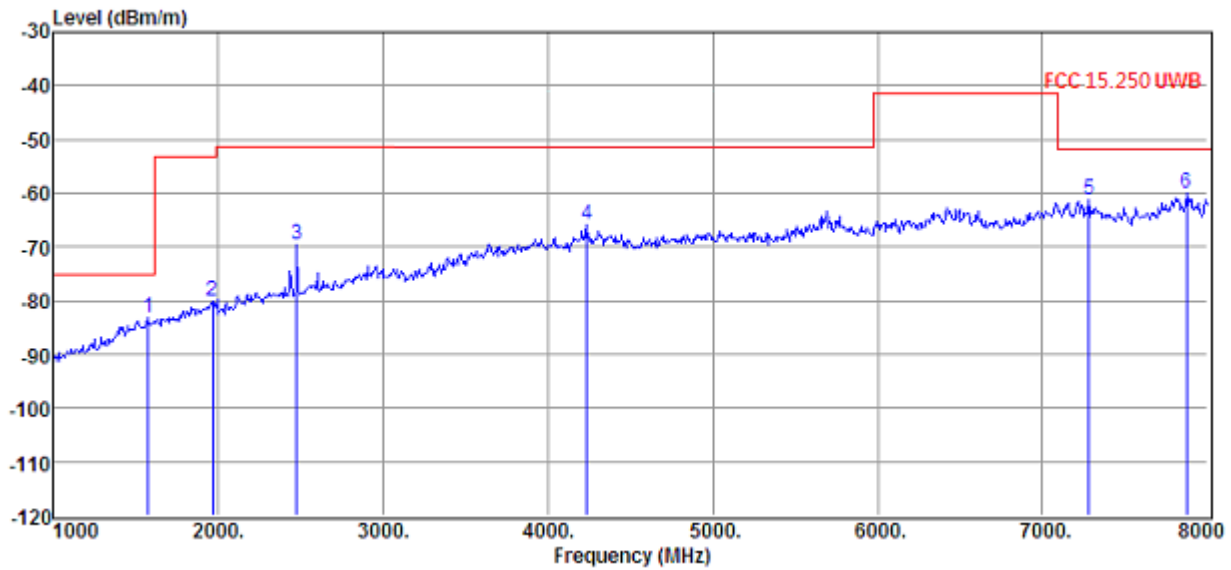

Item (Mark)	Freq. (MHz)	Read Level (dBm)	Antenna Factor (dB/m)	PRM Factor dB	Cable Loss dB	Result Level (dBm)	Limit Line (dBm)	Over Limit (dB)	Detector
1	1574.00	-85.12	26.02	29.09	5.00	-83.19	-75.30	-7.89	Peak
2	1966.00	-84.60	27.95	28.99	5.47	-80.17	-53.30	-26.87	Peak
3	2477.00	-76.03	30.11	29.69	6.13	-69.48	-51.30	-18.18	Peak
4	4234.00	-78.27	33.59	29.09	7.87	-65.90	-51.30	-14.60	Peak
5	7279.00	-77.89	36.43	30.55	10.66	-61.35	-51.30	-10.05	Peak
6	7874.00	-76.76	36.68	31.08	11.07	-60.09	-51.30	-8.79	Peak

Note: 1. Result Level = Read Level + Antenna Factor + Cable loss-PRM Factor

2. Test setup: RBW: 1 MHz, VBW: 1 MHz, Sweep time: auto



960MHz to 8 GHz Vertical

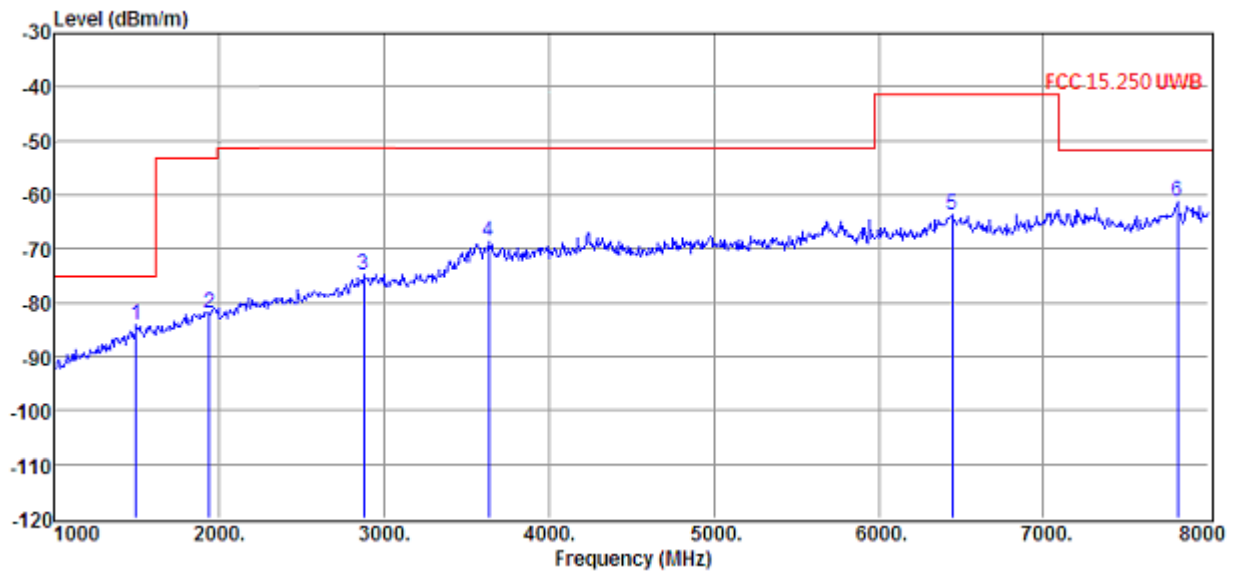

Item (Mark)	Freq. (MHz)	Read Level (dBm)	Antenna Factor (dB/m)	PRM Factor dB	Cable Loss dB	Result Level (dBm)	Limit Line (dBm)	Over Limit (dB)	Detector
1	1497.00	-85.60	25.59	29.14	4.92	-84.23	-75.30	-8.93	Peak
2	1938.00	-86.10	27.83	29.00	5.43	-81.84	-53.30	-28.54	Peak
3	2876.00	-82.57	31.35	30.14	6.61	-74.75	-51.30	-23.45	Peak
4	3632.00	-78.94	32.32	29.31	7.38	-68.55	-51.30	-17.25	Peak
5	6446.00	-79.74	35.72	29.74	9.91	-63.85	-41.30	-22.55	Peak
6	7811.00	-77.97	36.66	31.04	11.03	-61.32	-51.30	-10.02	Peak

Note: 1. Result Level = Read Level + Antenna Factor + Cable loss-PRM Factor

2. Test setup: RBW: 1 MHz, VBW: 1 MHz, Sweep time: auto



8GHz to 18 GHz Horizontal

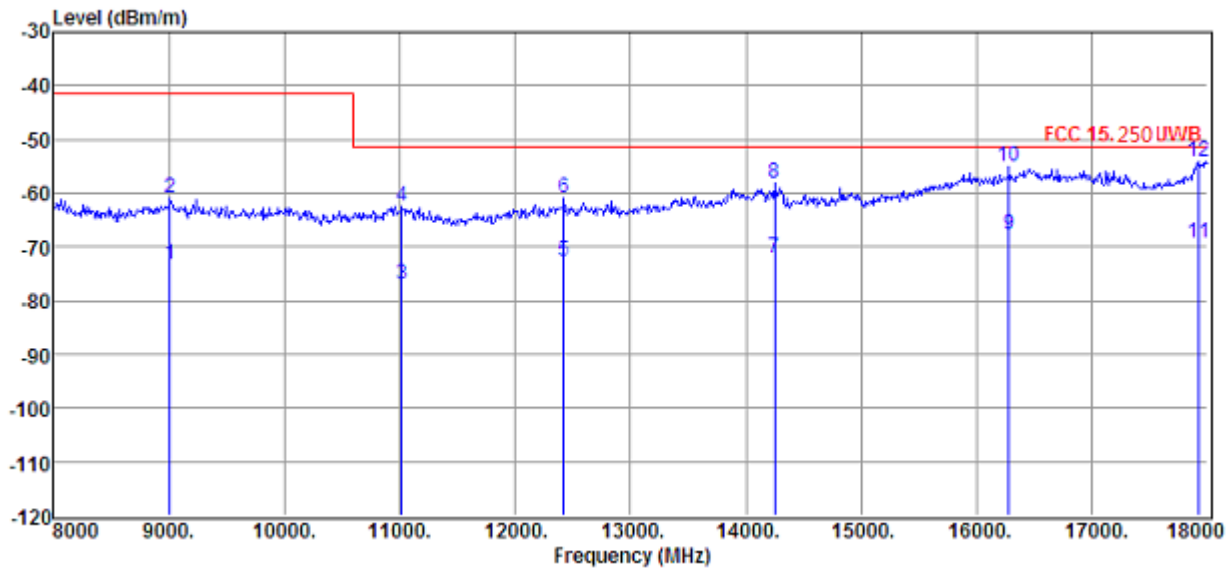

Item (Mark)	Freq. (MHz)	Read Level (dBm)	Antenna Factor (dB/m)	PRM Factor dB	Cable Loss dB	Result Level (dBm)	Limit Line (dBm)	Over Limit (dB)	Detector
1	9010.00	-90.25	37.48	32.33	11.83	-73.27	-41.30	-31.97	Average
2	9010.00	-78.06	37.48	32.33	11.83	-61.08	-41.30	-19.78	Peak
3	11020.00	-94.36	37.76	33.98	13.49	-77.09	-51.30	-25.79	Average
4	11020.00	-79.83	37.76	33.98	13.49	-62.56	-51.30	-11.26	Peak
5	12420.00	-90.26	38.19	35.16	14.57	-72.66	-51.30	-21.36	Average
6	12420.00	-78.49	38.19	35.16	14.57	-60.89	-51.30	-9.59	Peak
7	14250.00	-92.65	40.30	34.96	15.38	-71.93	-51.30	-20.63	Average
8	14250.00	-78.90	40.30	34.96	15.38	-58.18	-51.30	-6.88	Peak
9	16280.00	-93.54	44.35	35.75	17.30	-67.64	-51.30	-16.34	Average
10	16280.00	-81.04	44.35	35.75	17.30	-55.14	-51.30	-3.84	Peak
11	17930.00	-95.61	44.46	37.67	19.58	-69.24	-51.30	-17.94	Average
12	17930.00	-80.45	44.46	37.67	19.58	-54.08	-51.30	-2.78	Peak

Note: 1. Result Level = Read Level + Antenna Factor + Cable loss-PRM Factor

2. Test setup: RBW: 1 MHz, VBW: 1 MHz, Sweep time: auto

3. The higher frequency, which started from 18GHz to 40GHz, was pre-scanned and the result which was 20dB lower than the limit line and was not reported.



8GHz to 18 GHz Vertical

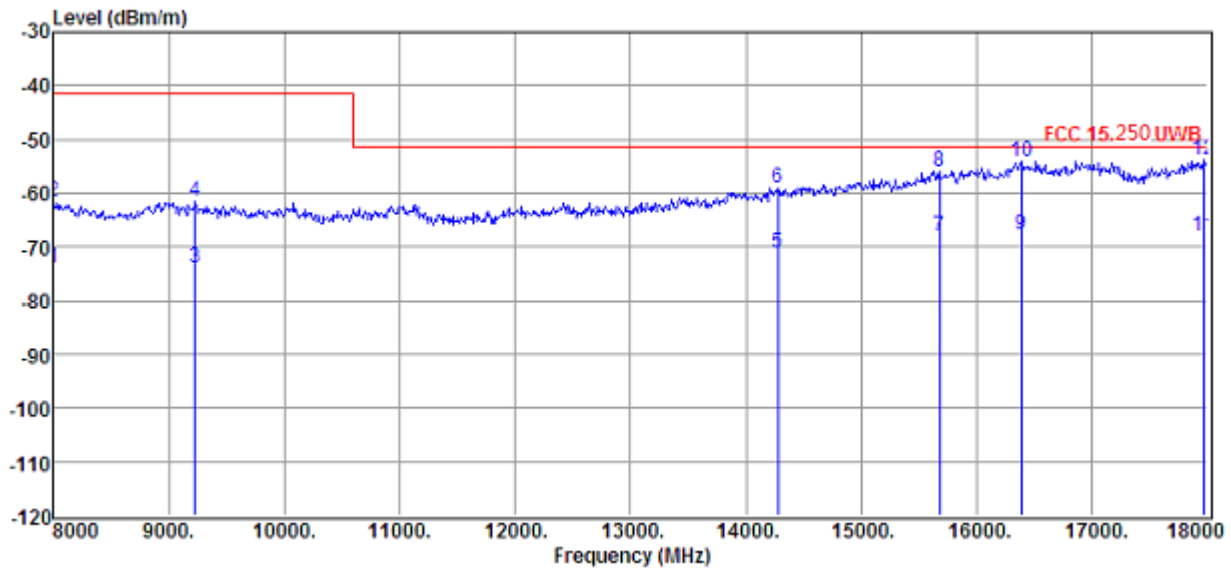

Item (Mark)	Freq. (MHz)	Read Level (dBm)	Antenna Factor (dB/m)	PRM Factor dB	Cable Loss dB	Result Level (dBm)	Limit Line (dBm)	Over Limit (dB)	Detector
1	8000.00	-90.54	36.70	31.13	11.14	-73.83	-41.30	-32.53	Average
2	8000.00	-78.39	36.70	31.13	11.14	-61.68	-41.30	-20.38	Peak
3	9230.00	-90.57	36.99	32.43	12.07	-73.94	-41.30	-32.64	Average
4	9230.00	-78.25	36.99	32.43	12.07	-61.62	-41.30	-20.32	Peak
5	14280.00	-91.84	40.36	35.01	15.44	-71.05	-51.30	-19.75	Average
6	14280.00	-79.78	40.36	35.01	15.44	-58.99	-51.30	-7.69	Peak
7	15680.00	-92.48	43.33	35.60	16.71	-68.04	-51.30	-16.74	Average
8	15680.00	-80.37	43.33	35.60	16.71	-55.93	-51.30	-4.63	Peak
9	16390.00	-93.60	44.53	35.92	17.40	-67.59	-51.30	-16.29	Average
10	16390.00	-80.22	44.53	35.92	17.40	-54.21	-51.30	-2.91	Peak
11	17960.00	-94.58	44.57	37.67	19.65	-68.03	-51.30	-16.73	Average
12	17960.00	-80.27	44.57	37.67	19.65	-53.72	-51.30	-2.42	Peak

Note: 1. Result Level = Read Level + Antenna Factor + Cable loss-PRM Factor

2. Test setup: RBW: 1 MHz, VBW: 1 MHz, Sweep time: auto

3. The higher frequency, which started from 18GHz to 40GHz, was pre-scanned and the result which was 20dB lower than the limit line and was not reported.



Horizontal Measurement Polarity 1164 to 1240 MHz

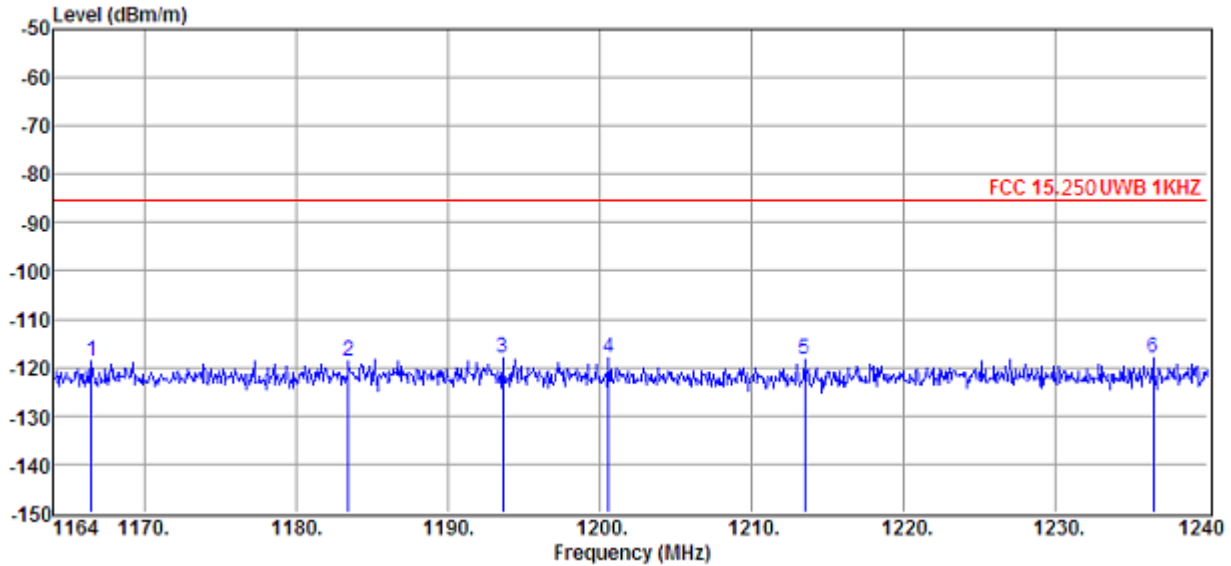

Item (Mark)	Freq. (MHz)	Read Level (dBm)	Antenna Factor (dB/m)	PRM Factor dB	Cable Loss dB	Result Level (dBm)	Limit Line (dBm)	Over Limit (dB)	Detector
1	1166.51	-117.14	23.80	29.46	4.10	-118.70	-85.30	-33.40	Peak
2	1183.46	-117.16	23.90	29.45	4.14	-118.57	-85.30	-33.27	Peak
3	1193.56	-116.66	23.97	29.45	4.19	-117.95	-85.30	-32.65	Peak
4	1200.56	-116.84	24.01	29.44	4.19	-118.08	-85.30	-32.78	Peak
5	1213.48	-117.14	24.08	29.44	4.23	-118.27	-85.30	-32.97	Peak
6	1236.43	-117.07	24.22	29.43	4.27	-118.01	-85.30	-32.71	Peak

Note: 1. Result Level = Read Level + Antenna Factor + Cable loss-PRM Factor
 2. Test setup: RBW: 1 MHz, VBW: 1 MHz, Sweep time: auto



Horizontal Measurement Polarity 1559 to 1610 MHz

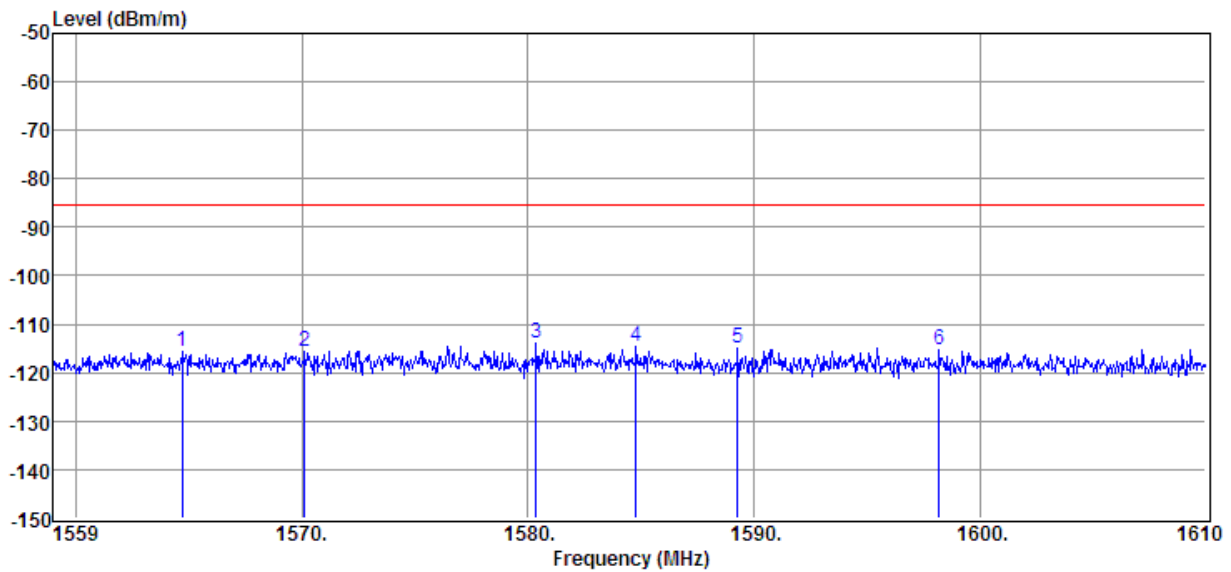

Item (Mark)	Freq. (MHz)	Read Level (dBm)	Antenna Factor (dB/m)	PRM Factor dB	Cable Loss dB	Result Level (dBm)	Limit Line (dBm)	Over Limit (dB)	Detector
1	1564.71	-117.55	25.97	29.10	4.98	-115.70	-85.30	-30.40	Peak
2	1570.12	-117.40	26.00	29.10	5.00	-115.50	-85.30	-30.20	Peak
3	1580.37	-115.97	26.05	29.09	5.00	-114.01	-85.30	-28.71	Peak
4	1584.81	-116.56	26.08	29.09	5.03	-114.54	-85.30	-29.24	Peak
5	1589.29	-117.03	26.10	29.09	5.03	-114.99	-85.30	-29.69	Peak
6	1598.22	-117.47	26.15	29.08	5.03	-115.37	-85.30	-30.07	Peak

Note: 1. Result Level = Read Level + Antenna Factor + Cable loss-PRM Factor

2. Test setup: RBW: 1 MHz, VBW: 1 MHz, Sweep time: auto



Vertical Measurement Polarity 1164 to 1240 MHz

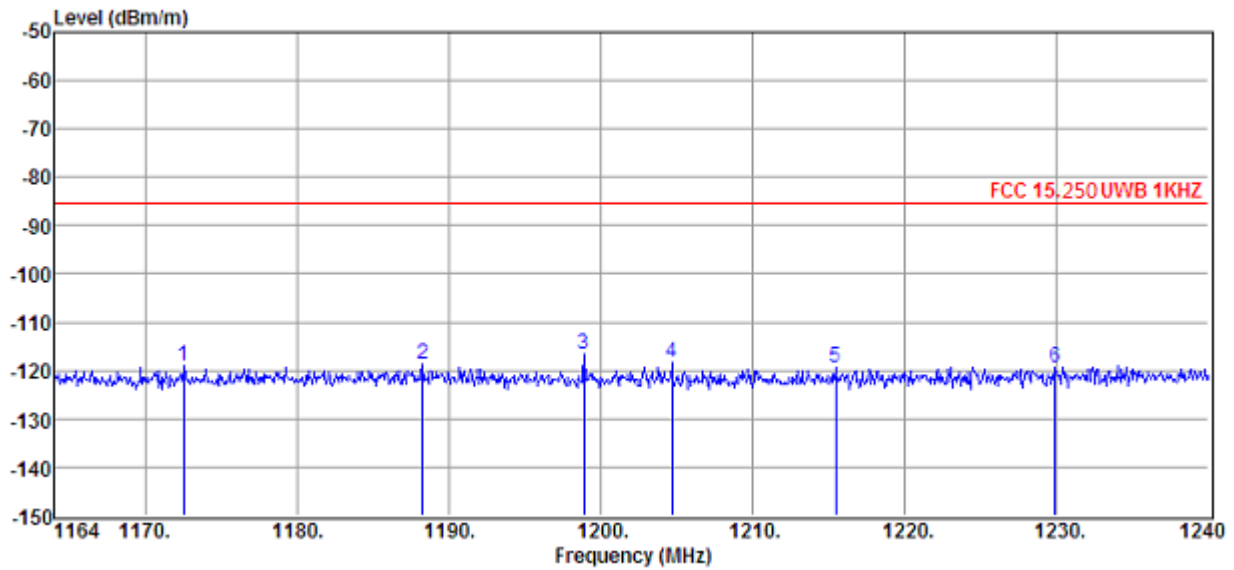

Item (Mark)	Freq. (MHz)	Read Level (dBm)	Antenna Factor (dB/m)	PRM Factor dB	Cable Loss dB	Result Level (dBm)	Limit Line (dBm)	Over Limit (dB)	Detector
1	1172.51	-117.71	23.84	29.45	4.14	-119.18	-85.30	-33.88	Peak
2	1188.24	-117.45	23.93	29.45	4.14	-118.83	-85.30	-33.53	Peak
3	1198.88	-115.53	24.00	29.44	4.19	-116.78	-85.30	-31.48	Peak
4	1204.66	-117.33	24.03	29.44	4.19	-118.55	-85.30	-33.25	Peak
5	1215.45	-118.22	24.10	29.43	4.23	-119.32	-85.30	-34.02	Peak
6	1229.89	-118.30	24.18	29.43	4.27	-119.28	-85.30	-33.98	Peak

Note: 1. Result Level = Read Level + Antenna Factor + Cable loss-PRM Factor

2. Test setup: RBW: 1 MHz, VBW: 1 MHz, Sweep time: auto



Vertical Measurement Polarity 1559 to 1610 MHz

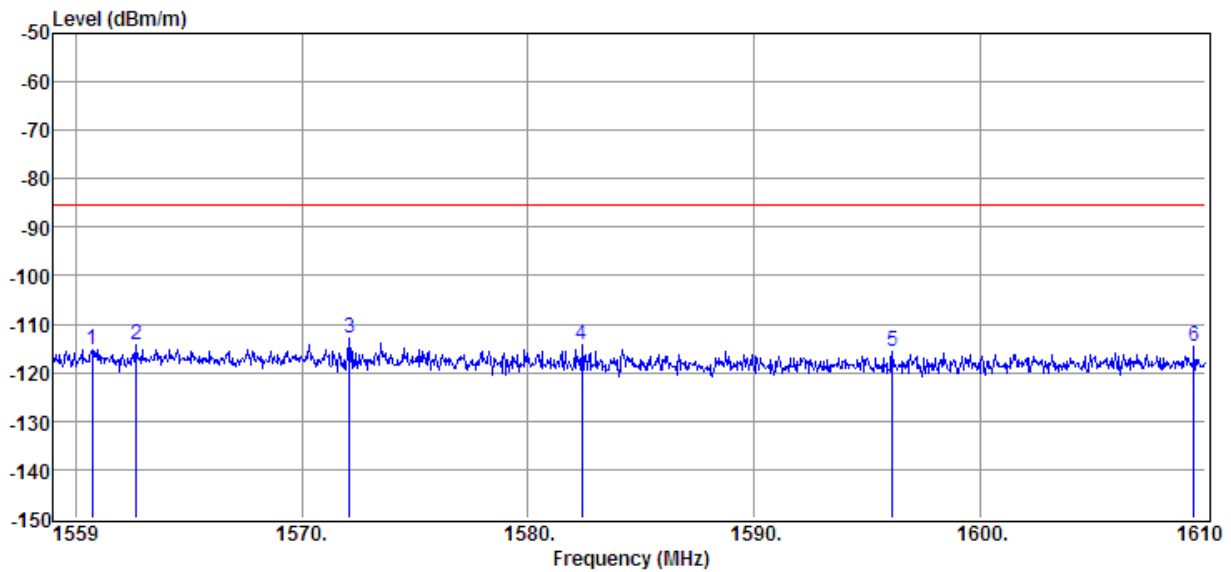

Item (Mark)	Freq. (MHz)	Read Level (dBm)	Antenna Factor (dB/m)	PRM Factor (dB)	Cable Loss (dB)	Result Level (dBm)	Limit Line (dBm)	Over Limit (dB)	Detector
1	1560.73	-117.11	25.94	29.10	4.98	-115.29	-85.30	-29.99	Peak
2	1562.67	-115.94	25.96	29.10	4.98	-114.10	-85.30	-28.80	Peak
3	1572.11	-114.89	26.01	29.09	5.00	-112.97	-85.30	-27.67	Peak
4	1582.41	-116.12	26.06	29.09	5.00	-114.15	-85.30	-28.85	Peak
5	1596.13	-117.69	26.14	29.08	5.03	-115.60	-85.30	-30.30	Peak
6	1609.49	-116.85	26.21	29.08	5.05	-114.67	-85.30	-29.37	Peak

Note: 1. Result Level = Read Level + Antenna Factor + Cable loss-PRM Factor

2. Test setup: RBW: 1 MHz, VBW: 1 MHz, Sweep time: auto



Radiated Emission above 18GHz:

Limit: FCC_Part15.209_RE(3m)	Margin: 0
Probe: BBHA9170 (18GHz-40GHz)	Polarity: Horizontal
EUT: Segway miniPLUS	Power: AC 120V/60Hz
Note: There is the ambient noise within frequency range 18GHz-40GHz	

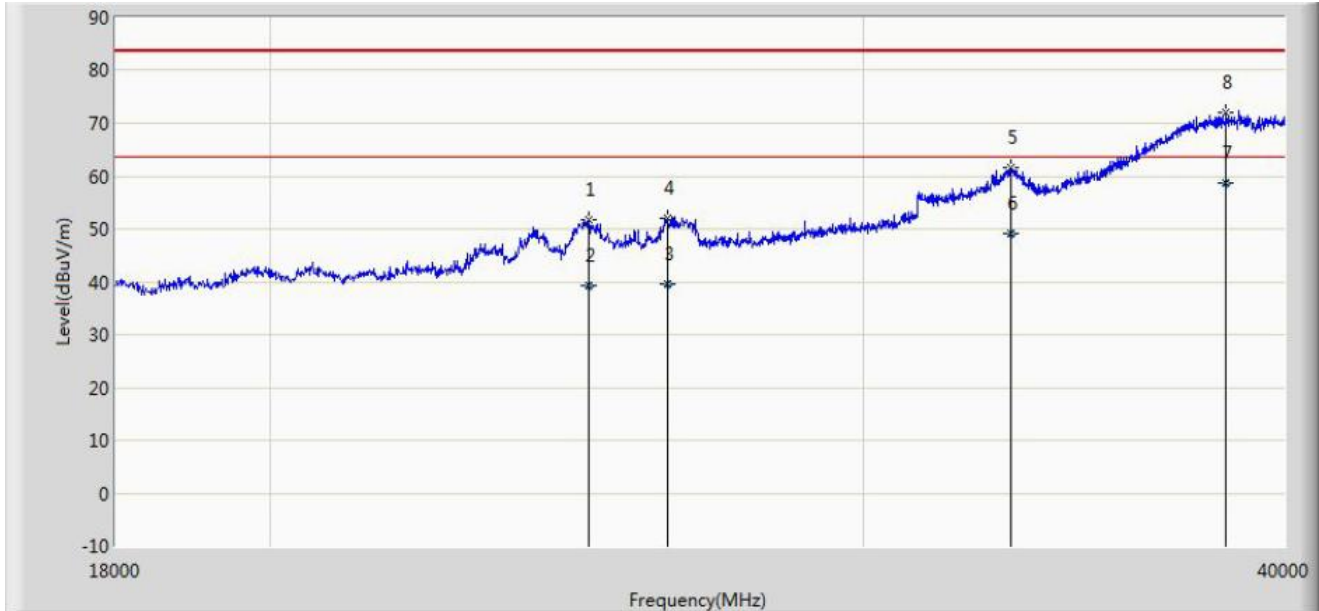

No	Mark	Frequency (MHz)	Measure Level (dBuV/m)	Reading Level (dBuV)	Over Limit (dB)	Limit (dBuV/m)	Factor (dB)	Type
1		24864.000	51.876	37.101	-31.624	83.500	14.775	PK
2		24864.088	39.255	24.480	-24.245	63.500	14.775	AV
3		26260.988	39.509	24.090	-23.991	63.500	15.419	AV
4		26261.000	51.996	36.577	-31.504	83.500	15.419	PK
5		33180.000	61.501	39.980	-21.999	83.500	21.521	PK
6		33180.363	49.081	27.560	-14.419	63.500	21.521	AV
7	*	38437.980	58.563	31.230	-4.937	63.500	27.333	AV
8		38438.000	72.071	44.738	-11.429	83.500	27.333	PK

Note: Measure Level (dBuV/m) = Reading Level (dBuV) + Factor(dB).

Factor (dB)=Cable Loss(dB) + Antenna Factor (dB/m) - Pre_Amplifier Gain(dB)

Limit@1m = 20*Log(500uV/m) + 20*Log(3m/1m) = 63.5dBµv/m (Average detector), and 83.5dBµv/m (Peak detector).



Limit: FCC_Part15.209_RE(3m)	Margin: 0
Probe: BBHA9170 (18GHz-40GHz)	Polarity: Vertical
EUT: Segway miniPLUS	Power: AC 120V/60Hz
Note: There is the ambient noise within frequency range 18GHz-40GHz	

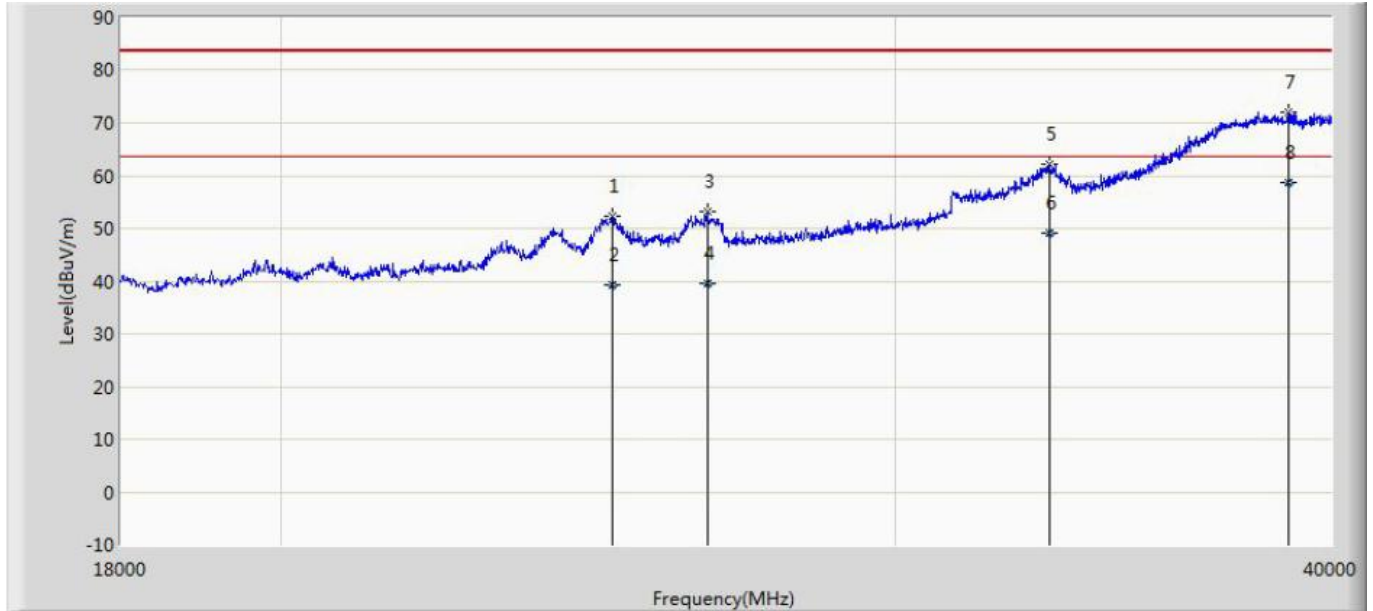

No	Mark	Frequency (MHz)	Measure Level (dBuV/m)	Reading Level (dBuV)	Over Limit (dB)	Limit (dBuV/m)	Factor (dB)	Type
1		24886.000	52.363	37.578	-31.137	83.500	14.785	PK
2		24886.970	39.274	24.489	-24.226	63.500	14.785	AV
3		26503.000	53.267	37.247	-30.233	83.500	16.020	PK
4		26503.877	39.632	23.610	-23.868	63.500	16.022	AV
5		33213.000	62.169	40.632	-21.331	83.500	21.538	PK
6		33213.989	49.128	27.590	-14.372	63.500	21.538	AV
7		38900.000	72.136	44.251	-11.364	83.500	27.885	PK
8	*	38900.756	58.755	30.870	-4.745	63.500	27.885	AV

Note: Measure Level (dBuV/m) = Reading Level (dBuV) + Factor(dB).

Factor (dB)=Cable Loss(dB) + Antenna Factor (dB/m) - Pre_Amplifier Gain(dB)

Limit@1m = 20*Log(500uV/m) + 20*Log(3m/1m) = 63.5dBµv/m (Average detector), and 83.5dBµv/m (Peak detector).



5. -10dB Bandwidth Measurement

5.1 Test Limit

According to Wideband Bandwidth FCC 15.250(b) , the -10 dB bandwidth of the fundamental emission shall be at least 50MHz.

5.2 Test Setup Layout

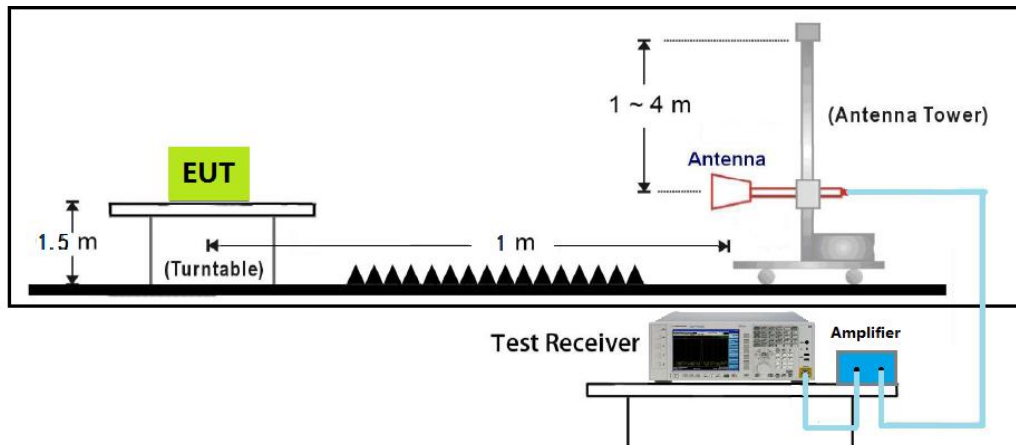



5.3 Test Result

Test Item	Occupied Bandwidth
Test Mode	Mode 1: Transmit

F_M	The highest emission peak	6.334GHz
F_L	10 dB below the highest peak	6.177GHz
F_H	10 dB above the highest peak	6.801GHz
Bandwidth	Calculated: ($f_H - f_L$)	624MHz

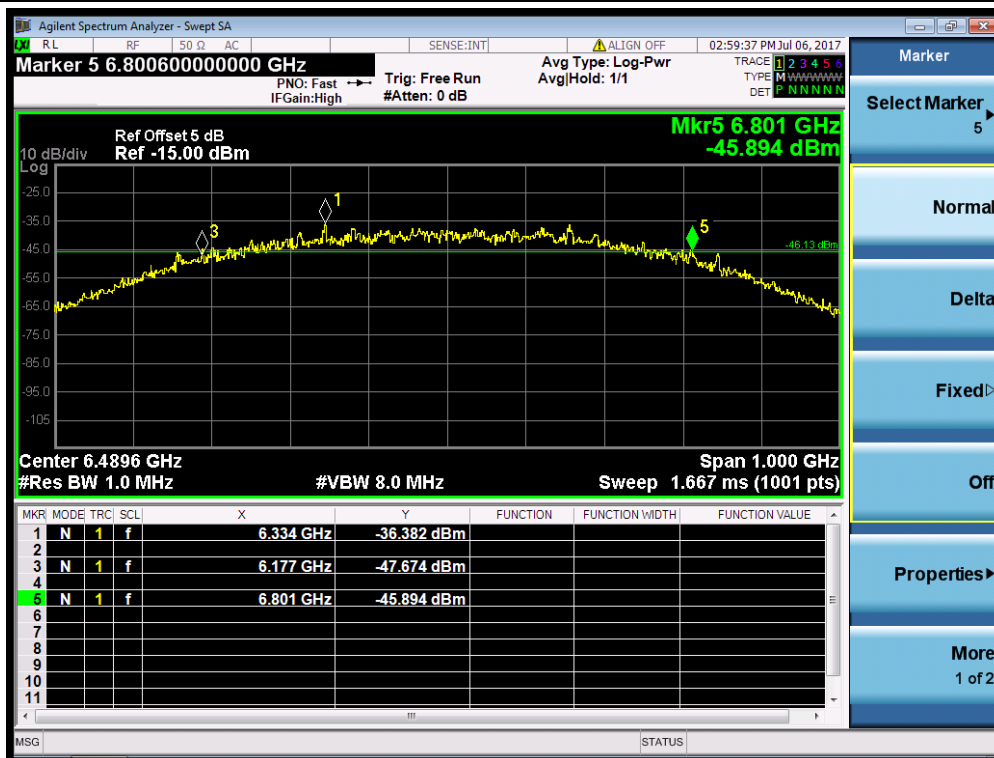



6. RMS Power in a 1 MHz Bandwidth

6.1 Test Limit

RMS Power in a 1 MHz Bandwidth (15.250 (d) (1), RSS-220 5.3.1 (d))

Requirement: The limit for operation in the 5925 to 7250 MHz band is -41.3 dBm EIRP.

6.2 Test Datas

Frequency (GHz)	Amplitude ¹	Limit	Margin	Ant Polarity	Ant Height	Turntable Azimuth	Result
6.509	(dBμV/m)	(dBμV/m)	(dB)	H/V	cm	Deg	Compliant
	50.67	53.90	-3.03	H	100	10	

Notes: ¹ Antenna Factor (AF), Cable Factor (CF) and External Pre-amplifier Gain (PAG) have been entered into the analyzer as transducer factors.

Equation (22) from ANSI C63.10-2013, EIRP = E_{meas} + 20 log (d_{meas}) – 104.7; d_{meas} = 3

EIRP (dBm) = E_{meas} (dBμV/m) – 95.2

Frequency (GHz)	Amplitude ¹ (dBm)	Limit (dBm)	Margin (dB)	Ant Polarity	Ant Height	Turntable Azimuth	Result
6.509	EIRP	EIRP	(dB)	H/V	cm	Deg	Compliant
	-44.5	-41.30	-3.2	H	100	10	

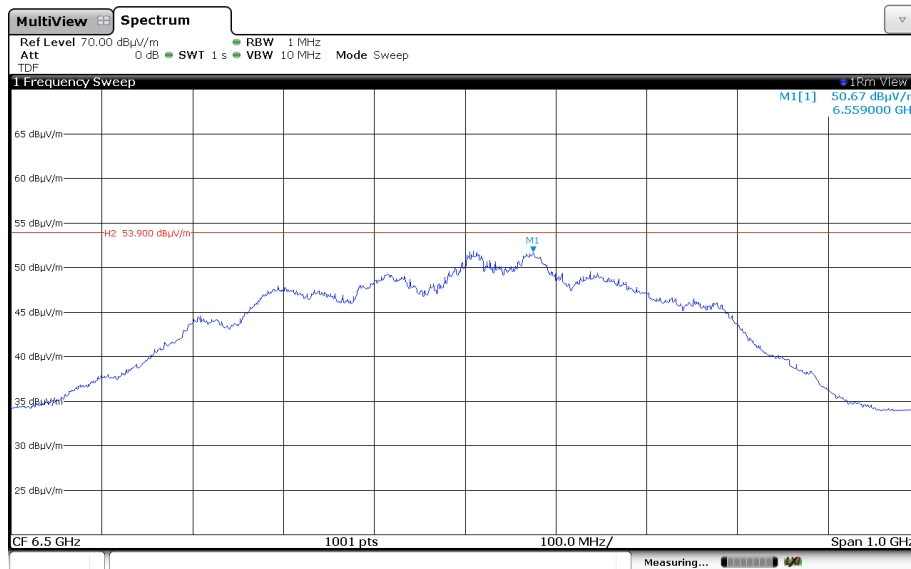



7. Peak Emissions in a 50 MHz Bandwidth

7.1 Test Limit

Peak Emissions in a 50 MHz Bandwidth (15.250 (d) (3), RSS-220 5.3.1 (g))

Requirement: There is a limit on the peak level of the emissions contained within a 50 MHz bandwidth centered on the frequency at which the highest radiated emission occurs, f_m . That limit is 0 dBm EIRP.

7.2 Test Datas

Frequency (GHz)	Amplitude ¹ (dBμV/m)	Limit (dBμV/m)	Margin (dB)	Ant Polarity	Ant Height (cm)	Turntable Azimuth (Deg)	Result
6.6508	(dBμV/m)	(dBμV/m)	(dB)	H/V	cm	Deg	Compliant
	91.53	95.20	-3.67	H	100	36	

Notes: ¹ Antenna Factor (AF), Cable Factor (CF) and External Pre-amplifier Gain (PAG) have been entered into the analyzer as transducer factors.

Equation (22) from ANSI C63.10-2013, $EIRP = E_{meas} + 20 \log(d_{meas}) - 104.7$; $d_{meas} = 3$

$EIRP (dBm) = E_{meas} (dBμV/m) - 95.2$

Frequency (GHz)	Amplitude ¹ (dBm)	Limit (dBm)	Margin (dB)	Ant Polarity	Ant Height (cm)	Turntable Azimuth (Deg)	Result
6.6508	EIRP	EIRP	(dB)	H/V	cm	Deg	Compliant
	-3.67	0	-3.67	H	100	36	

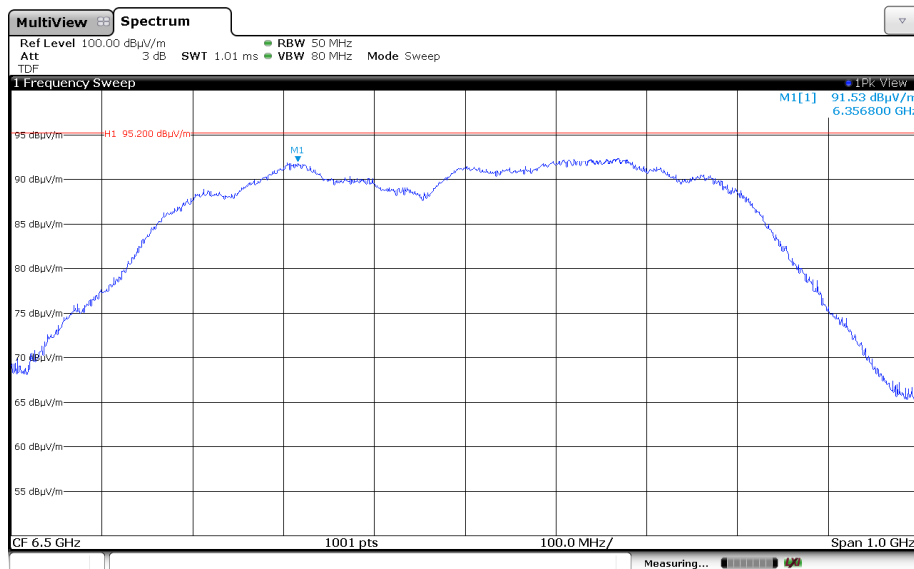



8. Public Exposure to Radio Frequency Energy Levels

8.1 Test Limit

SAR evaluation is required if the separation distance between the user and/or bystander and the antenna and/or radiating element of the device is less than or equal to 20 cm, except when the device operates at or below the applicable output power level (adjusted for tune-up tolerance) for the specified separation distance defined in Table 1. Portable devices are subject to radio frequency radiation exposure requirements.

Public Exposure to Radio Frequency Energy Levels 1.1307 (b)(1), RSS-GEN, Issue 4 Section 3.2, RSS 102

The limit was taken from Table 1 of RSS-102 Issue 5.

8.2 Test Datas

Center Frequency (GHz)	MPE Distance (cm)	DUT Output Power (dBm)	DUT Antenna Gain (dBi)	Power Density	FCC Limit (mW/cm ²)	IC Limit (W/m ²)
6.4896	(1)	(2)	(3)	(4) (mW/cm ²)	(5)	(6)
	5	-3.67	8.08	0.0088	1	10

$$PD = \frac{OP + AG}{(4 \times \pi \times d^2)}$$

1. Reference CFR 2.1093(b): For purposes of this section, a portable device is defined as a transmitting device designed to be used so that the radiating structure(s) of the device is/are within 5 centimeters of the body of the user.
2. Section 7.2 of this test report.
3. Data supplied by the client.
4. Power density is calculated from field strength measurement and antenna gain.
5. Reference CFR 1.1310, Table 1: Limits for Maximum Permissible Exposure (MPE), Section (B): Limits for General Population/Uncontrolled Exposure.
6. Reference IC RSS-102 Section 4 Table 4 RF Field Strength Limits for Devices Used by the General Public (Uncontrolled Environment)

_____ The End _____