

MEASUREMENT REPORT

FCC PART 15C / RSS-247 BLE

FCC ID: 2ALS8-KS0003
IC: 22636- KS0003
APPLICANT: Ninebot (Changzhou) Tech Co., Ltd.
Application Type: Certification
Product: Ninebot KickScooter
Model No.: E25A
Brand Name: Ninebot
FCC Classification: Digital Transmission System (DTS)
FCC Rule Part(s): Part 15 Subpart C (Section 15.247)
ISED Rule(s): RSS-247 Issue 2, RSS-GEN Issue 5
Test Procedure(s): ANSI C63.10-2013
Test Date: January 06 ~ April 14, 2020

Reviewed By:

Paddy Chen

(Paddy Chen)

Approved By:

Chenz Ker

(Chenz Ker)



Testing Laboratory
3261

The test results relate only to the samples tested.

This equipment has been shown to be capable of compliance with the applicable technical standards as indicated in the measurement report and was tested in accordance with the measurement procedures specified in ANSI C63.10-2013. Test results reported herein relate only to the item(s) tested.

The test report shall not be reproduced except in full without the written approval of MRT Technology (Taiwan) Co., Ltd.

Revision History

Report No.	Version	Description	Issue Date	Note
2004TW0004-U1	Rev. 01	Initial Report	04-23-2020	Valid

CONTENTS

Description	Page
1. INTRODUCTION	6
1.1. Scope	6
1.2. MRT Test Location.....	6
2. PRODUCT INFORMATION.....	7
2.1. Equipment Description.....	7
2.2. Product Specification Subjective to this Report	7
2.3. Working Frequencies for this report.....	7
2.4. Test Mode	8
2.5. Description of Test Software.....	8
2.6. Duty Cycle.....	8
2.7. EMI Suppression Device(s)/Modifications.....	8
2.8. Labeling Requirements	9
3. DESCRIPTION of TEST.....	10
3.1. Evaluation Procedure.....	10
3.2. AC Line Conducted Emissions	10
3.3. Radiated Emissions	11
4. ANTENNA REQUIREMENTS	12
5. TEST EQUIPMENT CALIBRATION DATE	13
6. MEASUREMENT UNCERTAINTY	15
7. TEST RESULT	16
7.1. Summary.....	16
7.2. Occupied Bandwidth Measurement	17
7.2.1. Test Limit.....	17
7.2.2. Test Procedure used	17
7.2.3. Test Setting	17
7.2.4. Test Setup	18
7.2.5. Test Result	19
7.3. Output Power Measurement.....	21
7.3.1. Test Limit.....	21
7.3.2. Test Procedure Used.....	21
7.3.3. Test Setting	21
7.3.4. Test Setup	22
7.3.5. Test Result	23

7.4.	Power Spectral Density Measurement.....	24
7.4.1.	Test Limit.....	24
7.4.2.	Test Procedure Used.....	24
7.4.3.	Test Setting.....	24
7.4.4.	Test Setup.....	24
7.4.5.	Test Result.....	25
7.5.	Conducted Band Edge and Out-of-Band Emissions.....	26
7.5.1.	Test Limit.....	26
7.5.2.	Test Procedure Used.....	26
7.5.3.	Test Settintg.....	26
7.5.4.	Test Setup.....	27
7.5.5.	Test Result.....	28
7.6.	Radiated Spurious Emission Measurement.....	30
7.6.1.	Test Limit.....	30
7.6.2.	Test Procedure Used.....	31
7.6.3.	Test Setting.....	31
7.6.4.	Test Setup.....	33
7.6.5.	Test Result.....	34
7.7.	Radiated Restricted Band Edge Measurement.....	42
7.7.1.	Test Limit.....	42
7.7.2.	Test Procedure Used.....	45
7.7.3.	Test Setting.....	45
7.7.4.	Test Setup.....	46
7.7.5.	Test Result.....	47
7.8.	AC Conducted Emissions Measurement.....	55
7.8.1.	Test Limit.....	55
7.8.2.	Test Setup.....	55
7.8.3.	Test Result.....	56
8.	CONCLUSION.....	58
	Appendix A - Test Setup Photograph.....	59
	Appendix B - EUT Photograph.....	60

General Information

Applicant:	Ninebot (Changzhou) Tech Co., Ltd.
Applicant Address:	16F-17F, Block A, Building 3, Changwu Mid Road 18#, Wujin Dist., Changzhou, Jiangsu, China
Manufacturer:	Ninebot (Changzhou) Tech Co., Ltd.
Manufacturer Address:	16F-17F, Block A, Building 3, Changwu Mid Road 18#, Wujin Dist., Changzhou, Jiangsu, China
Test Site:	MRT Technology (Taiwan) Co., Ltd
Test Site Address:	No. 38, Fuxing Second Rd., Guishan Dist., Taoyuan City 333, Taiwan (R.O.C)

Test Facility / Accreditations

Measurements were performed at MRT Laboratory located in Fuxing Rd., Taoyuan, Taiwan (R.O.C)

- MRT facility is a FCC registered (Designation No. TW3261) test facility with the site description report on file and is designated by the FCC as an Accredited Test Firm.
- MRT facility is an IC registered (MRT Reg. No. 21723-1) test laboratory with the site description on file at Industry Canada.
- MRT Lab is accredited to ISO 17025 by the American Association for Laboratory Accreditation (TAF) under the American Association for Laboratory Accreditation Program (TAF Cert. No. 3261) in EMC, Telecommunications and Radio testing for FCC, Industry Taiwan, EU and TELEC Rules.

1. INTRODUCTION

1.1. Scope

Measurement and determination of electromagnetic emissions (EMC) of radio frequency devices including intentional and/or unintentional radiators for compliance with the technical rules and regulations of the Federal Communications Commission and the Innovation, Science and Economic Development Canada and Certification and Engineering Bureau.

1.2. MRT Test Location

The map below shows the location of the MRT LABORATORY, its proximity to the Taoyuan City. These measurement tests were conducted at the MRT Technology (Taiwan) Co., Ltd. Facility located at No.38, Fuxing 2nd Rd., Guishan Dist., Taoyuan City 33377, Taiwan (R.O.C).

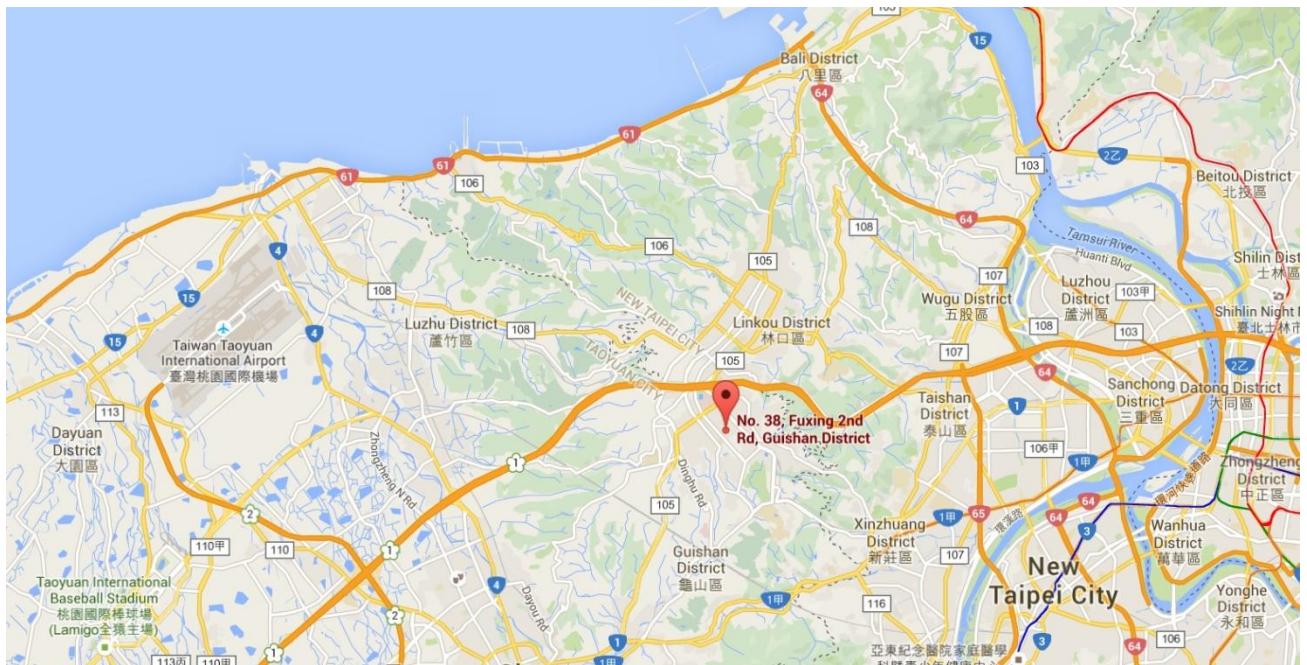

2. PRODUCT INFORMATION

2.1. Equipment Description

Product Name:	Ninebot KickScooter
Model No.:	E25A
Bluetooth Version:	v4.1 (BLE Only)
Firmware Version:	V0.2.0.4
Serial Number:	N2GVK1949C0040
Accessory:	Model No.: BCTA+71420-1700 Input Power: 100 - 240V ~ 50/60Hz, Max. 2.0A Output Power: 42VDC 1.7A

2.2. Product Specification Subjective to this Report

Frequency Range:	2402 ~ 2480 MHz
Bluetooth Version:	V4.1 (BLE Only)
Data Rate:	1Mbps (GFSK)
Antenna Type:	PCB Antenna
Antenna Gain:	-1.26dBi

2.3. Working Frequencies for this report

Channel	Frequency	Channel	Frequency	Channel	Frequency
00	2402 MHz	01	2404 MHz	02	2406 MHz
03	2408 MHz	04	2410 MHz	05	2412 MHz
06	2414 MHz	07	2416 MHz	08	2418 MHz
09	2420 MHz	10	2422 MHz	11	2424 MHz
12	2426 MHz	13	2428 MHz	14	2430 MHz
15	2432 MHz	16	2434 MHz	17	2436 MHz
18	2438 MHz	19	2440 MHz	20	2442 MHz
21	2444 MHz	22	2446 MHz	23	2448 MHz
24	2450 MHz	25	2452 MHz	26	2454 MHz
27	2456 MHz	28	2458 MHz	29	2460 MHz
30	2462 MHz	31	2464 MHz	32	2466 MHz
33	2468 MHz	34	2470 MHz	35	2472 MHz
36	2474 MHz	37	2476 MHz	38	2478 MHz
39	2480 MHz	--	--	--	--

2.4. Test Mode

Test Mode	Mode 1: Transmit by BLE
-----------	-------------------------

2.5. Description of Test Software

The test utility software used during testing was “nRFgo Studio”, and the version was 1.12.1.1992.

2.6. Duty Cycle

The maximum achievable duty cycles for all modes were determined based on measurements performed on a spectrum analyzer in zero-span mode with RBW = 8MHz, VBW = 50MHz. The RBW and VBW were both greater than 50/T, where T is the minimum transmission duration, and the number of sweep points across T was greater than 100. The duty cycles are as follows:

Test Mode	Duty Cycle
BLE	67.81%

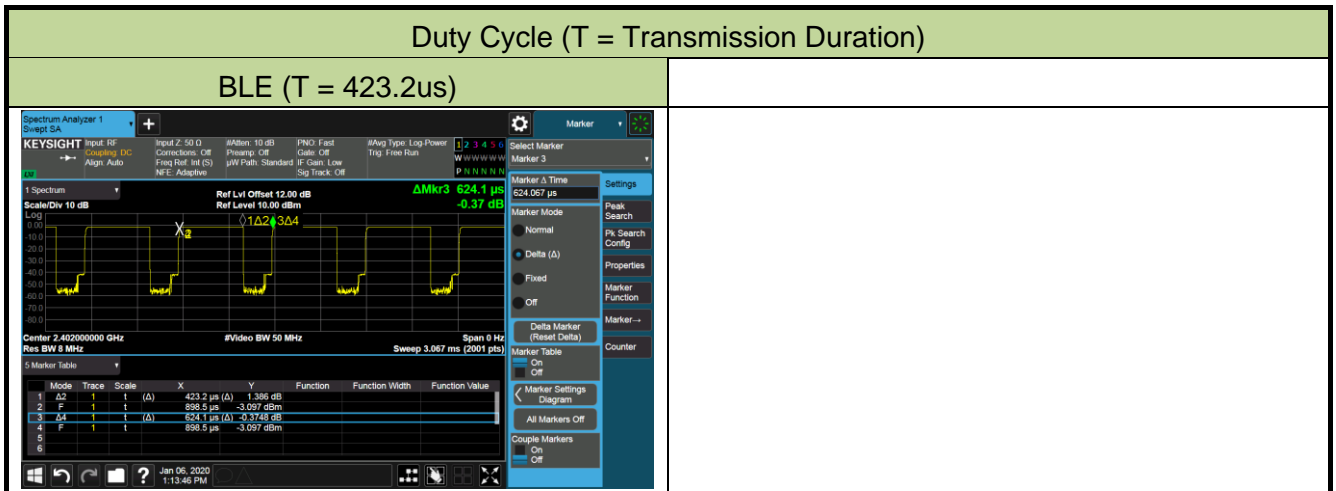

2.7. EMI Suppression Device(s)/Modifications

No EMI suppression device(s) were added and/or no modifications were made during testing.

2.8. Labeling Requirements

Per 2.1074 & 15.19; Docket 95-19

The label shall be permanently affixed at a conspicuous location on the device; instruction manual or pamphlet supplied to the user and be readily visible to the purchaser at the time of purchase. However, when the device is so small wherein placement of the label with specified statement is not practical, only the FCC ID must be displayed on the device per Section 15.19(a)(5). Please see attachment for FCC ID label and label location.

RSS-Gen Issue 5 Section 4

In addition to complying with the applicable RSSs and RSP-100, each unit of a product model (i.e. of a radio apparatus) shall meet the labelling requirements set out in this section prior to being marketed in Canada or imported into Canada.

For information regarding the labelling option, see Section 4.1, 4.2, 4.3 4.4. The label for the certified product represents the manufacturer's or importer's compliance with Innovation, Science and Economic Development Canada's (ISED) regulatory requirements.

Please see attachment for IC label and label location.

3. DESCRIPTION of TEST

3.1. Evaluation Procedure

The measurement procedures described in the American National Standard of Procedures for Compliance Testing of Unlicensed Wireless Devices (ANSI C63.10-2013) was used in the measurement.

3.2. AC Line Conducted Emissions

The line-conducted facility is located inside an 8'x4'x4' shielded enclosure. A 1m x 2m wooden table 80cm high is placed 40cm away from the vertical wall and 80cm away from the sidewall of the shielded room. For floor-standing equipment, The EUT is typically installed on the ground plane. In order to prevent direct metallic contact of the EUT and the reference ground plane, insulating material (up to 12 mm thick) shall be placed under the EUT. Two 10kHz-30MHz, 50Ω/50uH Line-Impedance Stabilization Networks (LISNs) are bonded to the shielded room floor. Power to the LISNs is filtered by external high-current high-insertion loss power line filters. These filters attenuate ambient signal noise from entering the measurement lines. These filters are also bonded to the shielded enclosure.

The EUT is powered from one LISN and the support equipment is powered from the second LISN. All interconnecting cables more than 1 meter were shortened to a 1 meter length by non-inductive bundling (serpentine fashion) and draped over the back edge of the test table. All cables were at least 40cm above the horizontal reference ground-plane. Power cables for support equipment were routed down to the second LISN while ensuring that that cables were not draped over the second LISN.

Sufficient time for the EUT, support equipment, and test equipment was allowed in order for them to warm up to their normal operating condition. The RF output of the LISN was connected to the receiver and exploratory measurements were made to determine the frequencies producing the maximum emission from the EUT. The receiver was scanned from 150kHz to 30MHz. The detector function was set to peak mode for exploratory measurements while the bandwidth of the analyzer was set to 9kHz. The EUT, support equipment, and interconnecting cables were arranged and manipulated to maximize each emission. Each emission was also maximized by varying: power lines, the mode of operation or data exchange speed, or support equipment which determined the worst-case emission. Once the worst-case emissions have been identified, the one EUT cable configuration/arrangement and mode of operation that produced these emissions are used for final measurements on the same test site. The analyzer is set to CISPR quasi-peak and average detectors with a 9kHz resolution bandwidth for final measurements.

An extension cord was used to connect to a single LISN which powered by EUT. The extension cord was calibrated with LISN, the impedance and insertion loss are compliance with the requirements as stated in ANSI C63.10-2013.

3.3. Radiated Emissions

The radiated test facilities consisted of an indoor 3 meter semi-anechoic chamber used for final measurements and exploratory measurements, when necessary. The measurement area is contained within the semi-anechoic chamber which is shielded from any ambient interference. For measurements above 1GHz absorbers are arranged on the floor between the turn table and the antenna mast in such a way so as to maximize the reduction of reflections. For measurements below 1GHz, the absorbers are removed. A MF Model 210SS turntable is used for radiated measurement. It is a continuously rotatable, remote controlled, metallic turntable and 2 meters (6.56 ft.) in diameter. The turn table is flush with the raised floor of the chamber in order to maintain its function as a ground plane.

For all measurements, the spectrum was scanned through all EUT azimuths and from 1 to 4 meter receive antenna height using a broadband antenna from 30MHz up to the upper frequency shown in 15.33(b)(1) depending on the highest frequency generated or used in the device or on which the device operates or tunes. For frequencies above 1GHz, linearly polarized double ridge horn antennas were used. For frequencies below 30MHz, a calibrated loop antenna was used. When exploratory measurements were necessary, they were performed at 1 meter test distance inside the semi-anechoic chamber using broadband antennas, broadband amplifiers, and spectrum analyzers to determine the frequencies and modes producing the maximum emissions. Sufficient time for the EUT, support equipment, and test equipment was allowed in order for them to warm up to their normal operating condition. The test set-up for frequencies below 1GHz was placed on top of the 0.8 meter high, 1 x 1.5 meter table; and test set-up for frequencies 1-40GHz was placed on top of the 1.5 meter high, 1 x 1.5 meter table. The EUT, support equipment, and interconnecting cables were arranged and manipulated to maximize each emission. Appropriate precaution was taken to ensure that all emissions from the EUT were maximized and investigated. The system configuration, clock speed, mode of operation or video resolution, if applicable, turntable azimuth, and receive antenna height was noted for each frequency found.

Final measurements were made in the semi-anechoic chamber using calibrated, linearly polarized broadband and horn antennas. The test setup was configured to the setup that produced the worst-case emissions. The spectrum analyzer was set to investigate all frequencies required for testing to compare the highest radiated disturbances with respect to the specified limits. The turntable containing the EUT was rotated through 360 degrees and the height of the receive antenna was varied 1 to 4 meters and stopped at the azimuth and height producing the maximum emission. Each emission was maximized by changing the orientation of the EUT through three orthogonal planes and changing the polarity of the receive antenna, which produced the worst-case emissions. According to 3dB Beam-Width of horn antenna, the horn antenna should be always directed to the EUT when rising height.

4. ANTENNA REQUIREMENTS

Excerpt from §15.203 of the FCC Rules/Regulations:

“An intentional radiator antenna shall be designed to ensure that no antenna other than that furnished by the responsible party can be used with the device. The use of a permanently attached antenna or of an antenna that uses a unique coupling to the intentional radiator shall be considered sufficient to comply with the provisions of this section.”

- The antenna of this device is permanently attached.
- There are no provisions for connection to an external antenna.

Conclusion:

This device complies with the requirement of §15.203.

5. TEST EQUIPMENT CALIBRATION DATE

Conducted Emissions - SR2

Instrument	Manufacturer	Type No.	Asset No.	Cali. Interval	Cali. Due Date
Two-Line V-Network	R&S	ENV216	MRTTWA00019	1 year	2021/3/26
Two-Line V-Network	R&S	ENV216	MRTTWA00020	1 year	2020/4/25
8-Wire ISN (T8-Cat6)	R&S	ENY81 CA6	MRTTWA00017	1 year	2020/4/23
8-Wire ISN (T8)	R&S	ENY81	MRTTWA00018	1 year	2020/4/23
EMI Test Receiver	R&S	ESR3	MRTTWA00045	1 year	2020/5/29
Conducted Cable	Rosnol	N1C50-RG400-B1C50-500CM	MRTTWE00013	1 year	2020/6/18
Temperature/Humidity Meter	TFA	35.1078.10.IT	MRTTWA00033	1 year	2020/5/30

Radiated Emissions - AC1

Instrument	Manufacturer	Type No.	Asset No.	Cali. Interval	Cali. Due Date
Active Loop Antenna	SCHWARZBECK	FMZB 1519B	MRTTWA00002	1 year	2020/4/29
Broadband TRILOG Antenna	SCHWARZBECK	VULB 9162	MRTTWA00001	1 year	2020/6/4
Broadband Hornantenna	SCHWARZBECK	BBHA 9120D	MRTTWA00003	1 year	2020/4/22
Breitband Hornantenna	SCHWARZBECK	BBHA 9170	MRTTWA00004	1 year	2020/4/23
Broadband Preamplifier	SCHWARZBECK	BBV 9718	MRTTWA00005	1 year	2020/4/24
Broadband Amplifier	SCHWARZBECK	BBV 9721	MRTTWA00006	1 year	2020/4/24
Signal Analyzer	R&S	FSV40	MRTTWA00007	1 year	2021/3/24
EMI Test Receiver	R&S	ESR3	MRTTWA00009	1 year	2021/3/25
EXA Signal Analyzer	KEYSIGHT	N9010A	MRTTWA00012	1 year	2020/10/2
EXA Signal Analyzer	KEYSIGHT	N9010B	MRTTWA00074	1 year	2020/7/11
Antenna Cable	HUBERSUHNER	SF106	MRTTWE00010	1 year	2020/4/22
Temperature/Humidity Meter	TFA	35.1078.10.IT	MRTTWA00032	1 year	2020/5/30
Cable	Rosnol	K1K50-UP02 64-K1K50-4M	MRTTWE00012	1 year	2020/6/18

Conducted Test Equipment

Instrument	Manufacturer	Type No.	Asset No.	Cali. Interval	Cali. Due Date
X-Series USB Peak and Average Power Sensor	KEYSIGHT	U2021XA	MRTTWA00014	1 year	2020/4/22
X-Series USB Peak and Average Power Sensor	KEYSIGHT	U2021XA	MRTTWA00015	1 year	2021/3/26
Wideband Radio Communication Taster	R&S	CMW 500	MRTTWA00041	1 year	2021/1/7
EXA Signal Analyzer	KEYSIGHT	N9010A	MRTTWA00012	1 year	2020/10/2
EXA Signal Analyzer	KEYSIGHT	N9010B	MRTTWA00074	1 year	2020/7/11
Signal Analyzer	R&S	FSV40	MRTTWA00007	1 year	2021/3/24
Temperature & Humidity Chamber	TEN BILLION	TTH-B3UP	MRTTWA00036	1 year	2020/6/10
Temperature/Humidity Meter	TFA	35.1078.10.IT	MRTTWA00033	1 year	2020/5/30

Software	Version	Function
e3	9.160520a	EMI Test Software
EMI	V 3	EMI Test Software

6. MEASUREMENT UNCERTAINTY

Where relevant, the following test uncertainty levels have been estimated for tests performed on the EUT as specified in CISPR 16-4-2. This uncertainty represents an expanded uncertainty expressed at approximately the 95% confidence level using a coverage factor of $k = 2$.

Conducted Emission- Power Line
Measuring Uncertainty for a Level of Confidence of 95% ($U=2Uc(y)$): 2.53dB
Conducted Emission- Impedance Stabilization Network Measurement
Measuring Uncertainty for a Level of Confidence of 95% ($U=2Uc(y)$): 3.96dB
Radiated Spurious Emission
Measuring Uncertainty for a Level of Confidence of 95% ($U=2Uc(y)$): 3.92dB (Below 30M)
Measuring Uncertainty for a Level of Confidence of 95% ($U=2Uc(y)$): 4.25dB (30M~1G)
Measuring Uncertainty for a Level of Confidence of 95% ($U=2Uc(y)$): 4.40dB (1G~18G)
Measuring Uncertainty for a Level of Confidence of 95% ($U=2Uc(y)$): 4.45dB (18G~40G)
Frequency Error
Measuring Uncertainty for a Level of Confidence of 95% ($U=2Uc(y)$): 78.4Hz
Conducted Power
Measuring Uncertainty for a Level of Confidence of 95% ($U=2Uc(y)$): 0.84dB
Conducted Spurious Emission
Measuring Uncertainty for a Level of Confidence of 95% ($U=2Uc(y)$): 2.65 dB
Occupied Bandwidth
Measuring Uncertainty for a Level of Confidence of 95% ($U=2Uc(y)$): 3.3%
Temp. / Humidity
Measuring Uncertainty for a Level of Confidence of 95% ($U=2Uc(y)$): 0.82°C/ 3%
DC Voltage
Measuring Uncertainty for a Level of Confidence of 95% ($U=2Uc(y)$): 0.3%

7. TEST RESULT

7.1. Summary

FCC Part Section(s)	RSS Section(s)	Test Description	Test Limit	Test Condition	Test Result	Reference
15.247(a)(2)	RSS-247 [5.2]	6dB Bandwidth	$\geq 500\text{kHz}$	Conducted	Pass	Section 7.2
N/A	RSS-Gen [6.7]	99% Bandwidth	N/A		Pass	
15.247(b)(3)	RSS-247 [5.4(d)]	Output Power	$\leq 1\text{Watt}$ & $\text{EIRP} \leq 4\text{Watt}$		Pass	Section 7.3
15.247(e)	RSS-247 [5.2]	Power Spectral Density	$\leq 8\text{dBm} / 3\text{kHz}$		Pass	Section 7.4
15.247(d)	RSS-247 [5.5]	Band Edge / Out-of-Band Emissions	20dBc (Peak)		Pass	Section 7.5
15.205 15.209	RSS-247 [5.5]	General Field Strength Limits (Restricted Bands and Radiated Emission Limits)	Emissions in restricted bands must meet the radiated limits detailed in 15.209	Radiated	Pass	Section 7.6&7.7
15.207	RSS-Gen [8.8]	AC Conducted Emissions 150kHz - 30MHz	< FCC 15.207 limits	Line Conducted	Pass	Section 7.8

Notes:

- 1) The analyzer plots shown in this section were all taken with a correction table loaded into the analyzer. The correction table was used to account for the losses of the cables and attenuators used as part of the system to connect the EUT to the analyzer at all frequencies of interest.
- 2) All modes of operation and data rates were investigated. For radiated emission test, every axis (X, Y, Z) was also verified. The test results shown in the following sections represent the worst-case emissions.

7.2. Occupied Bandwidth Measurement

7.2.1. Test Limit

The minimum 6dB bandwidth shall be at least 500 kHz.

7.2.2. Test Procedure used

ANSI C63.10-2013 - Section 11.8 (6dB bandwidth)

ANSI C63.10-2013 - Section 6.9.3 (99% bandwidth)

7.2.3. Test Setting

For 6dB bandwidth

1. The Spectrum's automatic bandwidth measurement capability was used to perform the 6dB bandwidth measurement. The "X" dB bandwidth parameter was set to $X = 6$. The bandwidth measurement was not influenced by any intermediate power nulls in the fundamental emission.
2. Set RBW = 100 kHz
3. $VBW \geq 3 \times RBW$
4. Detector = Peak
5. Trace mode = Max hold
6. Sweep = Auto couple
7. Allow the trace was allowed to stabilize

For 99% bandwidth

1. Span = 1.5 times to 5 times the OBW
2. Set RBW = 1% to 5% the OBW
3. $VBW \geq 3 \times RBW$
4. Detector = Peak
5. Trace mode = Max hold
6. Sweep = Auto couple
7. Allow the trace was allowed to stabilize

7.2.4. Test Setup

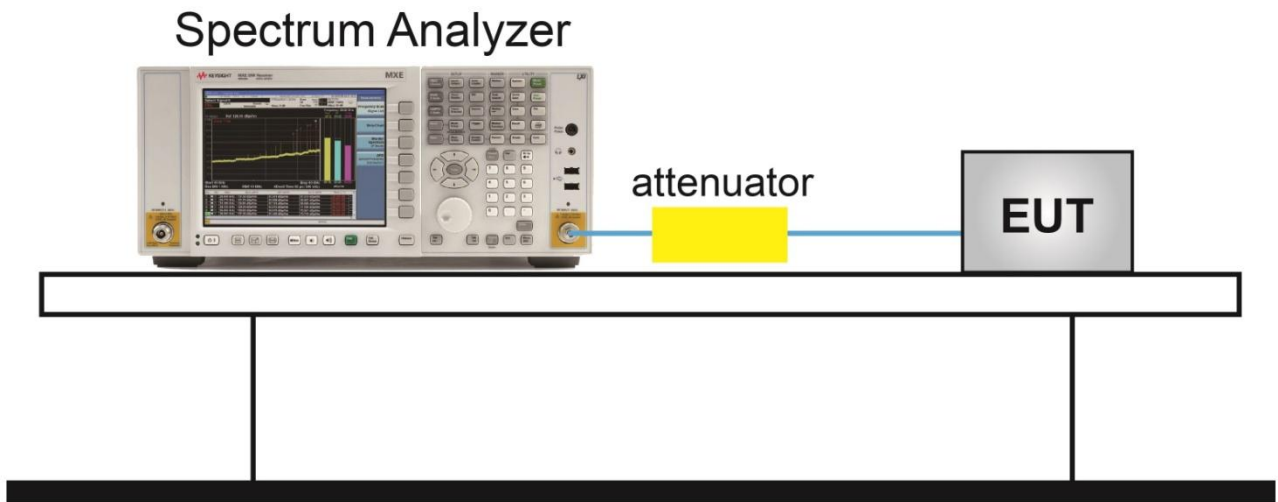

7.2.5. Test Result

Product	Ninebot KickScooter	Temperature	25°C
Test Engineer	Peter Syu	Relative Humidity	56%
Test Site	SR2	Test Date	2020/01/06

Test Mode	Data Rate / MCS	Channel No.	Frequency (MHz)	6dB Bandwidth (kHz)	Limit (MHz)	99% Bandwidth (MHz)	Result
BLE	1Mbps	00	2402	693.1	≥ 0.5	1.152	Pass
BLE	1Mbps	19	2440	694.0	≥ 0.5	1.160	Pass
BLE	1Mbps	39	2480	688.8	≥ 0.5	1.160	Pass

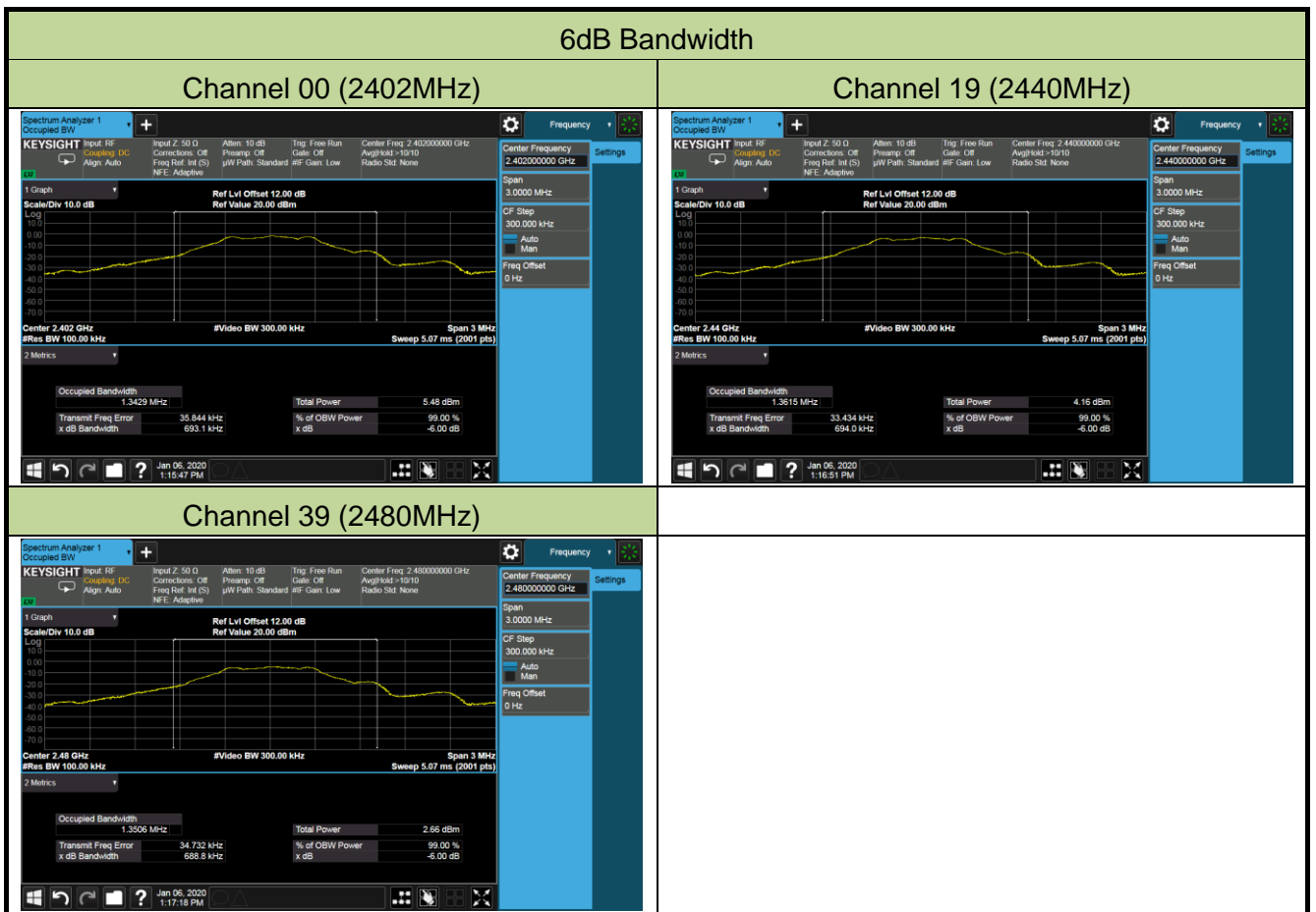

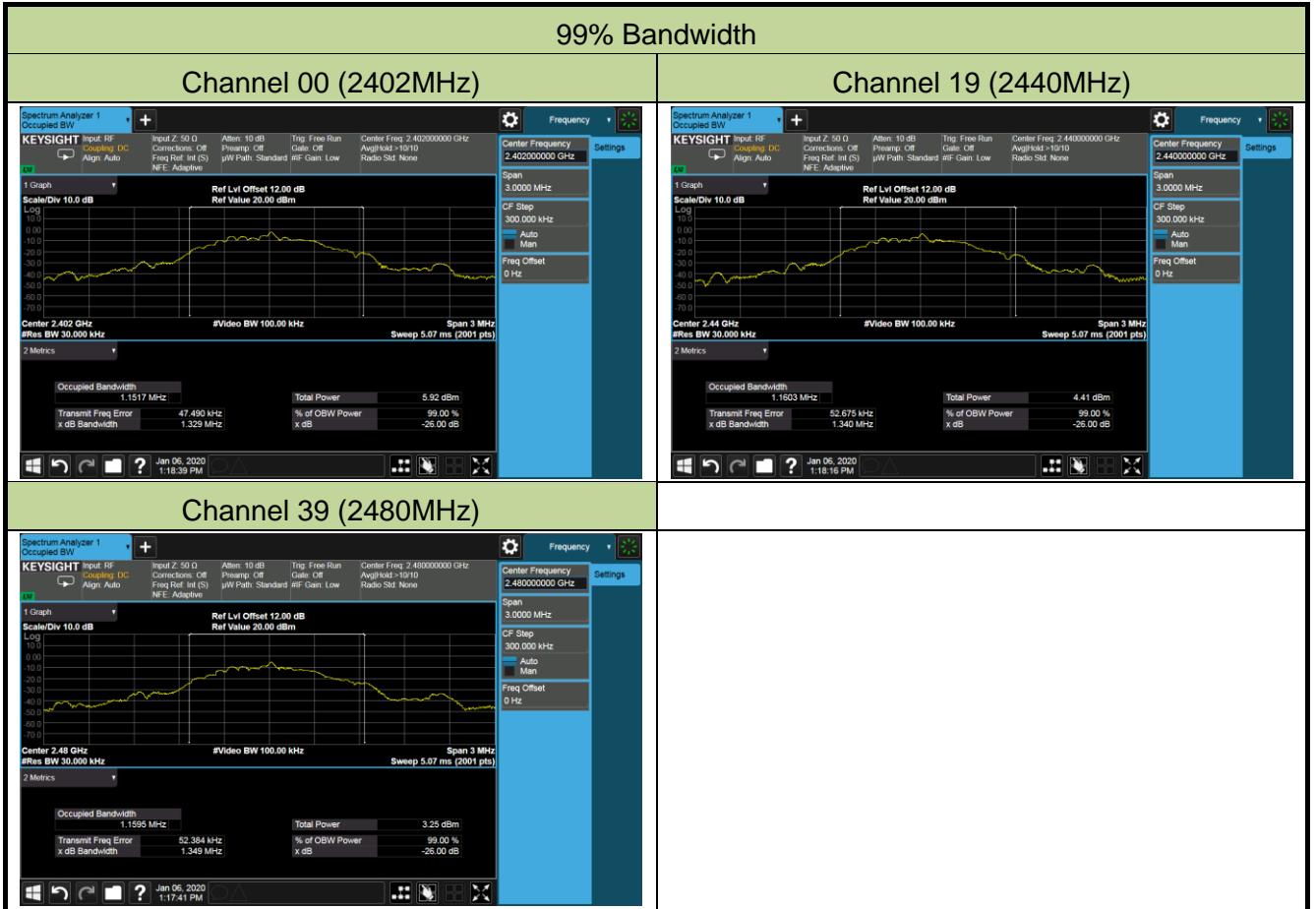

7.3. Output Power Measurement

7.3.1. Test Limit

The maximum conducted output power shall be exceeded 1 Watt (30dBm) and the E.I.R.P shall not exceed 4 Watt (36.02dBm).

7.3.2. Test Procedure Used

ANSI C63.10 - Section 11.9.1.3

ANSI C63.10 - Section 11.9.2.3.2

7.3.3. Test Setting

Method PKPM1 (Peak Power Measurement)

Peak power measurements were performed only when the EUT was transmitting at its maximum power control level using a broadband power meter with a pulse sensor. The pulse sensor employs a VBW = 50MHz so this method was only used for signals whose DTS bandwidth was less than or equal to 50MHz.

Method AVGPM-G (Measurement using a gated RF average-reading power meter)

Measurements may be performed using a wideband gated RF power meter provided that the gate parameters are adjusted such that the power is measured only when the EUT is transmitting at its maximum power control level. Since this measurement is made only during the ON time of the transmitter, no duty cycle correction is required.

7.3.4. Test Setup

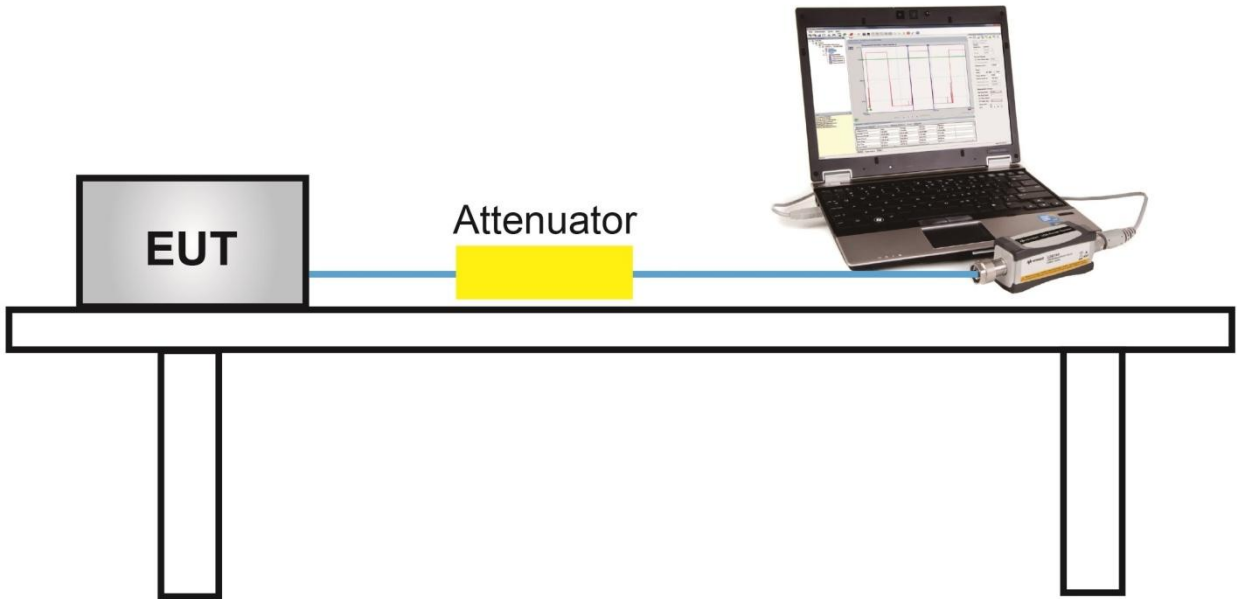

7.3.5. Test Result

Product	Ninebot KickScooter	Temperature	25°C
Test Engineer	Peter Syu	Relative Humidity	56%
Test Site	SR2	Test Date	2020/01/06

Test Result of Peak Output Power

Test Mode	Data Rate / MCS	Channel No.	Frequency (MHz)	Peak Power (dBm)	Limit (dBm)	E.I.R.P (dBm)	E.I.R.P Limit (dBm)	Result
BLE	1Mbps	00	2402	-2.19	≤ 30.00	-3.45	≤ 36.02	Pass
BLE	1Mbps	19	2440	-2.90	≤ 30.00	-4.16	≤ 36.02	Pass
BLE	1Mbps	39	2480	-3.92	≤ 30.00	-5.18	≤ 36.02	Pass

Note: E.I.R.P (dBm) = Peak Power (dBm) + Antenna Gain (dBi), Antenna Gain = -1.26 dBi.

Test Result of Average Output Power (Reporting Only)

Test Mode	Data Rate / MCS	Channel No.	Frequency (MHz)	Average Power (dBm)	Limit (dBm)	E.I.R.P (dBm)	E.I.R.P Limit (dBm)	Result
BLE	1Mbps	00	2402	-4.96	≤ 30.00	-6.22	≤ 36.02	Pass
BLE	1Mbps	19	2440	-6.81	≤ 30.00	-8.07	≤ 36.02	Pass
BLE	1Mbps	39	2480	-8.55	≤ 30.00	-9.81	≤ 36.02	Pass

Note: E.I.R.P (dBm) = Average Power (dBm) + Antenna Gain (dBi), Antenna Gain = -1.26 dBi.

7.4. Power Spectral Density Measurement

7.4.1. Test Limit

The maximum permissible power spectral density is 8dBm in any 3 kHz band.

The same method of determining the conducted output power shall be used to determine the power spectral density.

7.4.2. Test Procedure Used

ANSI C63.10 Section 11.10.5

7.4.3. Test Setting

1. Analyzer was set to the center frequency of the DTS channel under investigation
2. Span = 1.5 times the DTS channel bandwidth
3. RBW = 3kHz
4. VBW = 10kHz
5. Detector = peak
6. Sweep time = auto couple
7. Trace mode = max hold
8. Trace was allowed to stabilize

7.4.4. Test Setup

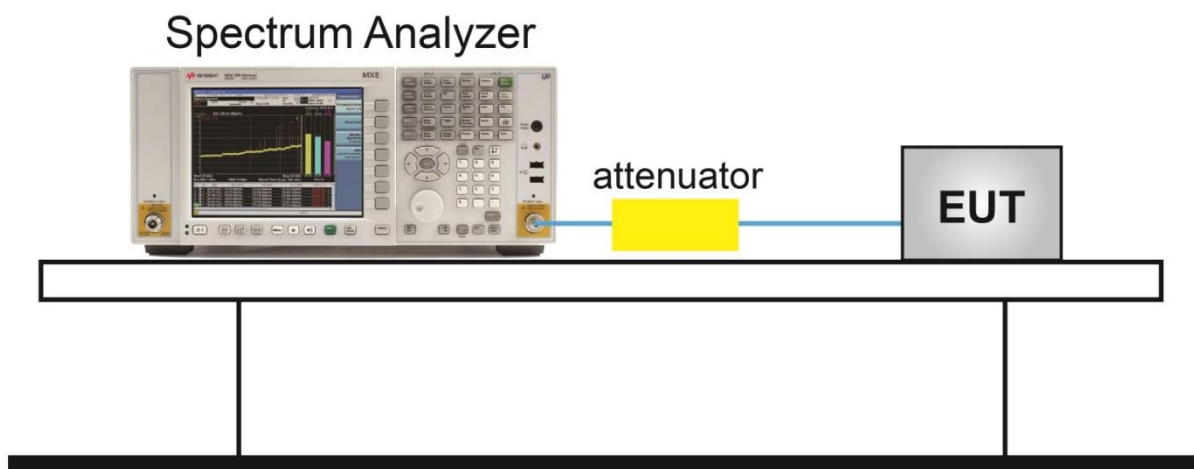

7.4.5. Test Result

Product	Ninebot KickScooter	Temperature	25°C
Test Engineer	Peter Syu	Relative Humidity	56%
Test Site	SR2	Test Date	2020/01/06

Test Mode	Data Rate / MCS	Channel No.	Frequency (MHz)	PK PSD (dBm / 3kHz)	Limit (dBm / 3kHz)	Result
BLE	1Mbps	00	2402	-15.67	≤ 8.00	Pass
BLE	1Mbps	19	2440	-17.35	≤ 8.00	Pass
BLE	1Mbps	39	2480	-18.33	≤ 8.00	Pass

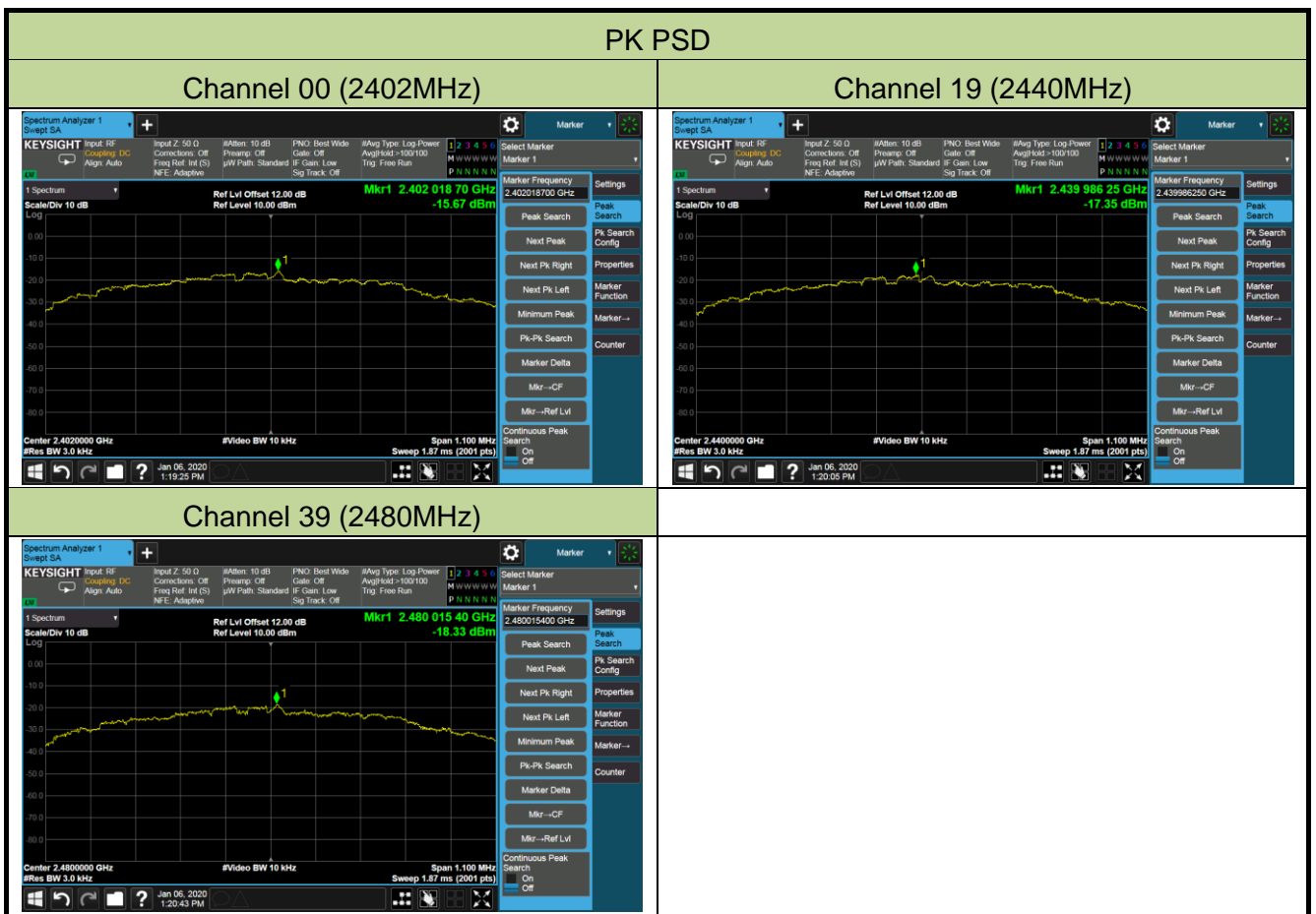

7.5. Conducted Band Edge and Out-of-Band Emissions

7.5.1. Test Limit

The limit for out-of-band spurious emissions at the band edge is 20dB below the fundamental emission level, as determined from the in-band power measurement of the DTS channel performed in a 100 kHz bandwidth per the PSD procedure.

7.5.2. Test Procedure Used

ANSI C63.10 - Section 11.11

7.5.3. Test Setting

Reference level measurement

1. Set instrument center frequency to DTS channel center frequency
2. Set the span to ≥ 1.5 times the DTS bandwidth
3. Set the RBW = 100 kHz
4. Set the VBW $\geq 3 \times$ RBW
5. Detector = peak
6. Sweep time = auto couple
7. Trace mode = max hold
8. Allow trace to fully stabilize

Emission level measurement

1. Set the center frequency and span to encompass frequency range to be measured
2. RBW = 100kHz
3. VBW = 300kHz
4. Detector = Peak
5. Trace mode = max hold
6. Sweep time = auto couple
7. The trace was allowed to stabilize

Test Notes

1. RBW was set to 1.3MHz rather than 100 kHz in order to increase the measurement speed; meanwhile, the VBW was set to 4MHz instead of 300 kHz.
2. The display line shown in the following plots denotes the limit at 20dB below the fundamental emission level measured in a 100 kHz bandwidth. However, since the traces in the following plots are measured with a 1.3 MHz RBW, the display line may not necessarily appear to be 20 dB below the level of the fundamental measured in a 1.3 MHz bandwidth.
3. For plots showing conducted spurious emissions near the limit, the frequencies were investigated with a reduced RBW to ensure that no emissions were present.

7.5.4. Test Setup

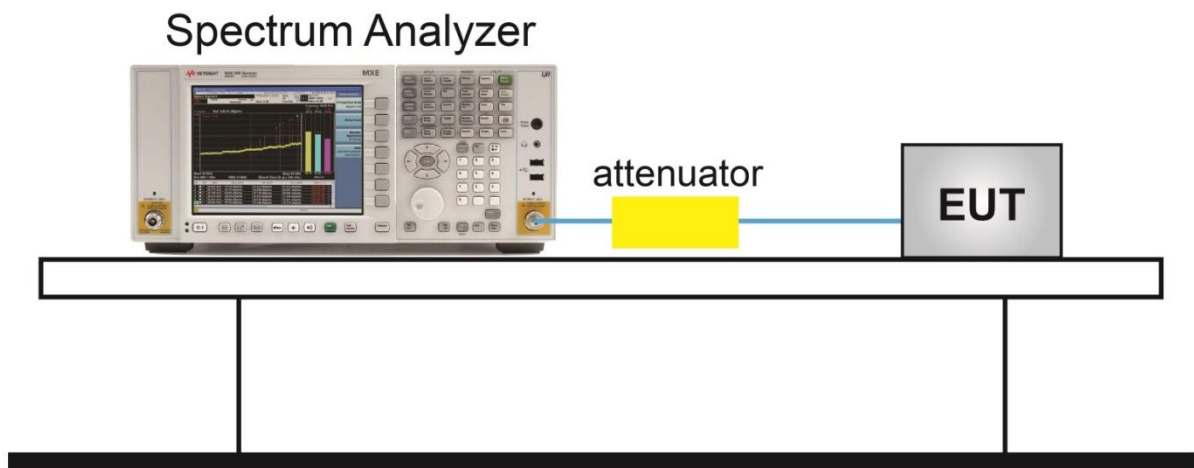

7.5.5. Test Result

Product	Ninebot KickScooter	Temperature	25°C
Test Engineer	Peter Syu	Relative Humidity	56%
Test Site	SR2	Test Date	2020/01/06

Test Mode	Data Rate / MCS	Channel No.	Frequency (MHz)	Limit	Result
BLE	1Mbps	00	2402	20dBc	Pass
BLE	1Mbps	19	2440	20dBc	Pass
BLE	1Mbps	39	2480	20dBc	Pass

Out-of-Band Emissions

Channel 00 (2402MHz)

100kHz PSD Reference Level

Low Band Edge

Spurious Emission

Note: The Value of the Display Line is -21.62dBm

Channel 19 (2440MHz)

100kHz PSD Reference Level

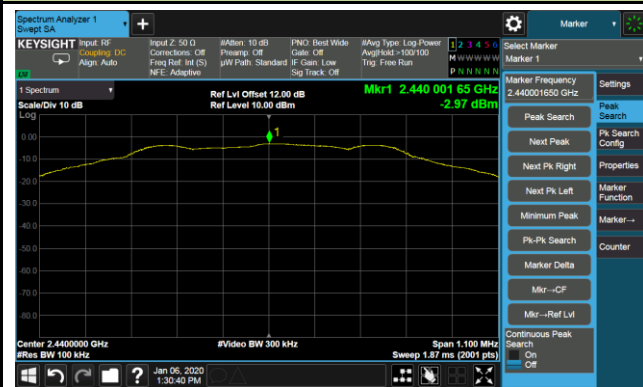

Spurious Emission



Note: The Value of the Display Line is -22.97dBm

Channel 39 (2480MHz)

100kHz PSD Reference Level



High Band Edge



Spurious Emission



Note: The Value of the Display Line is -24.43dBm

7.6. Radiated Spurious Emission Measurement

7.6.1. Test Limit

All out of band emissions appearing in a restricted band as specified in Section 15.205 of the Title 47 CFR must not exceed the limits shown in Table per Section 15.209.

FCC Part 15 Subpart C Paragraph 15.209		
Frequency [MHz]	Field Strength [$\mu\text{V}/\text{m}$]	Measured Distance [Meters]
0.009 - 0.490	2400/F (kHz)	300
0.490 - 1.705	24000/F (kHz)	30
1.705 - 30	30	30
30 - 88	100	3
88 - 216	150	3
216 - 960	200	3
Above 960	500	3

All out of band emissions appearing in a restricted band as specified in Section 8.10 of the RSS-Gen must not exceed the limits shown in Table per Section 8.9.

RSS-Gen Section 8.9			
Frequency (MHz)	Field Strength ($\mu\text{V}/\text{m}$)	Magnetic Field Strength (H-Field) ($\mu\text{A}/\text{m}$)	Measured Distance (m)
0.009 - 0.490	--	6.37/F (F in kHz)	300
0.490 - 1.705	--	6.37/F (F in kHz)	30
1.705 - 30	--	0.08	30
30 - 88	100	--	3
88 - 216	150	--	3
216 - 960	200	--	3
Above 960	500	--	3

7.6.2. Test Procedure Used

ANSI C63.10 Section 6.3 (General Requirements)

ANSI C63.10 Section 6.4 (Standard test method below 30MHz)

ANSI C63.10 Section 6.5 (Standard test method above 30MHz to 1GHz)

ANSI C63.10 Section 6.6 (Standard test method above 1GHz)

7.6.3. Test Setting

Table 1 - RBW as a function of frequency

Frequency	RBW
9 ~ 150 kHz	200 ~ 300 Hz
0.15 ~ 30 MHz	9 ~ 10 kHz
30 ~ 1000 MHz	100 ~ 120 kHz
> 1000 MHz	1 MHz

Quasi-Peak Measurements below 1GHz

1. Analyzer center frequency was set to the frequency of the radiated spurious emission of interest
2. Span was set greater than 1MHz
3. RBW = as specified in Table 1
4. Detector = CISPR quasi-peak
5. Sweep time = auto couple
6. Trace was allowed to stabilize

Peak Measurements above 1GHz

1. Analyzer center frequency was set to the frequency of the radiated spurious emission of interest
2. RBW = 1MHz
3. VBW = 3MHz
4. Detector = peak
5. Sweep time = auto couple
6. Trace mode = max hold
7. Trace was allowed to stabilize

Average Measurements above 1GHz (Method VB)

1. Analyzer center frequency was set to the frequency of the radiated spurious emission of interest
2. RBW = 1MHz
3. VBW; If the EUT is configured to transmit with duty cycle $\geq 98\%$, set VBW = 10 Hz.
If the EUT duty cycle is $< 98\%$, set VBW $\geq 1/T$. T is the minimum transmission duration.
4. Detector = Peak
5. Sweep time = auto
6. Trace mode = max hold
7. Trace was allowed to stabilize

7.6.4. Test Setup

Below 1GHz Test Setup:

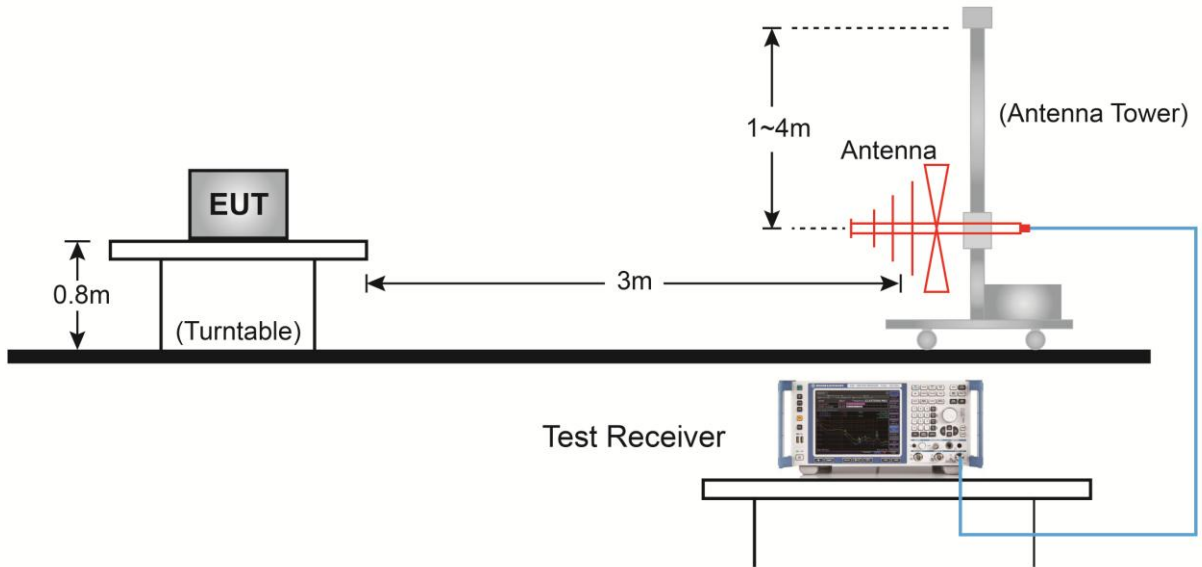

Above 1GHz Test Setup:

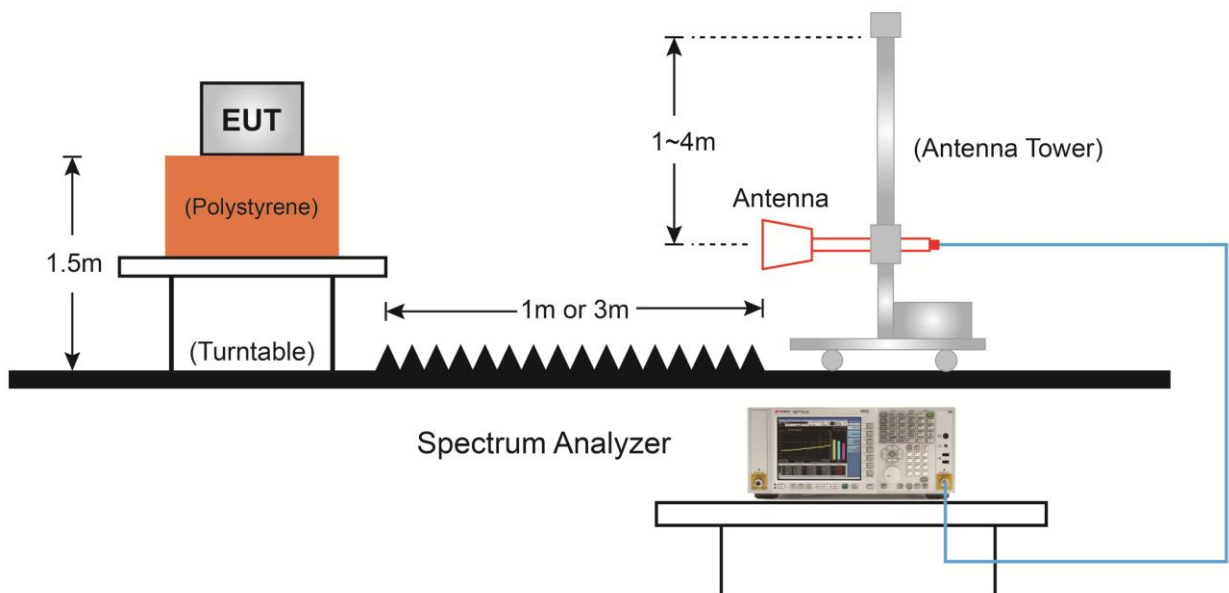

7.6.5. Test Result

EUT	Ninebot KickScooter	Date of Test	2020-04-14
Factor	BBHA 9120D	Temp. / Humidity	21.5°C/39%
Polarity	Horizontal	Site / Test Engineer	AC1 / Jay Chu
Test Mode	BLE_TX_CH00	Test Voltage	AC 120V/60Hz

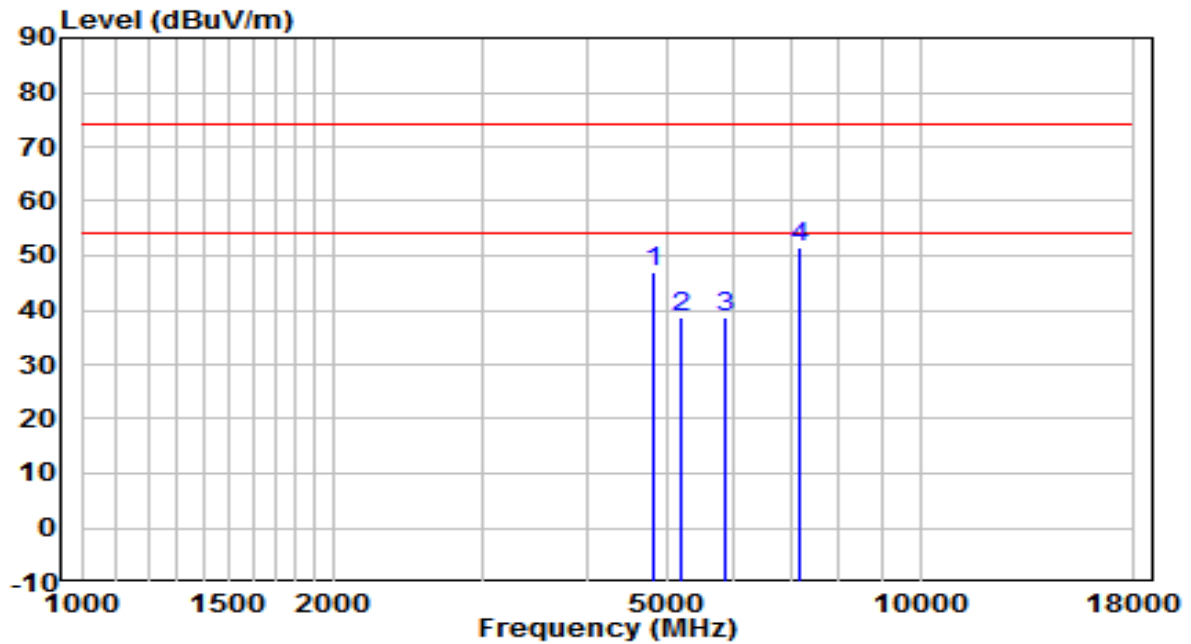

No	Frequency (MHz)	Reading (dBuV)	C.F (dB)	Measurement (dBuV/m)	Margin (dB)	Limit (dBuV/m)	Remark (QP/PK/AV)
1	4808.000	44.44	2.67	47.11	-26.89	74.00	Peak
2	5200.000	35.53	3.13	38.66	-35.34	74.00	Peak
3	5850.000	34.14	4.66	38.80	-35.20	74.00	Peak
4	* 7205.000	40.97	10.68	51.65	-22.35	74.00	Peak

Note:

1. " *", means this data is the worst emission level.
2. C.F (Correction Factor) = Antenna Factor (dB)+ Cable Loss (dB)– Preamplifier(dB).
3. Measurement(dBuV/m) = Reading(dBuV) + C.F (Correction Factor).
4. The emission levels of other frequencies are very lower than the limit and not show in test report.

EUT	Ninebot KickScooter	Date of Test	2020-04-14
Factor	BBHA 9120D	Temp. / Humidity	21.5°C/39%
Polarity	Vertical	Site / Test Engineer	AC1 / Jay Chu
Test Mode	BLE_TX_CH00	Test Voltage	AC 120V/60Hz

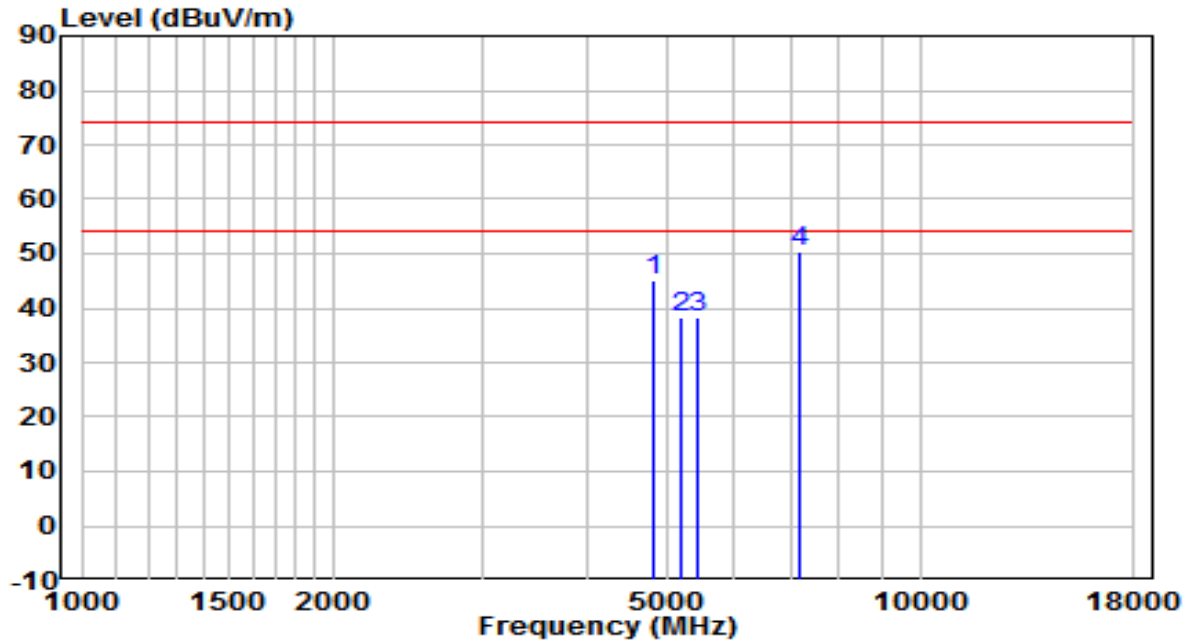

No	Frequency (MHz)	Reading (dBUV)	C.F (dB)	Measurement (dBUV/m)	Margin (dB)	Limit (dBUV/m)	Remark (QP/PK/AV)
1	4808.000	41.84	3.17	45.01	-28.99	74.00	Peak
2	5184.000	34.74	3.67	38.41	-35.59	74.00	Peak
3	5411.500	34.61	3.81	38.42	-35.58	74.00	Peak
4	* 7205.000	39.15	11.06	50.21	-23.79	74.00	Peak

Note:

1. " *", means this data is the worst emission level.
2. C.F (Correction Factor) = Antenna Factor (dB)+ Cable Loss (dB)– Preamplifier(dB).
3. Measurement(dBUV/m) = Reading(dBUV) + C.F (Correction Factor).
- 4.The emission levels of other frequencies are very lower than the limit and not show in test report.

EUT	Ninebot KickScooter	Date of Test	2020-04-14
Factor	BBHA 9120D	Temp. / Humidity	21.5°C/39%
Polarity	Horizontal	Site / Test Engineer	AC1 / Jay Chu
Test Mode	BLE_TX_CH19	Test Voltage	AC 120V/60Hz

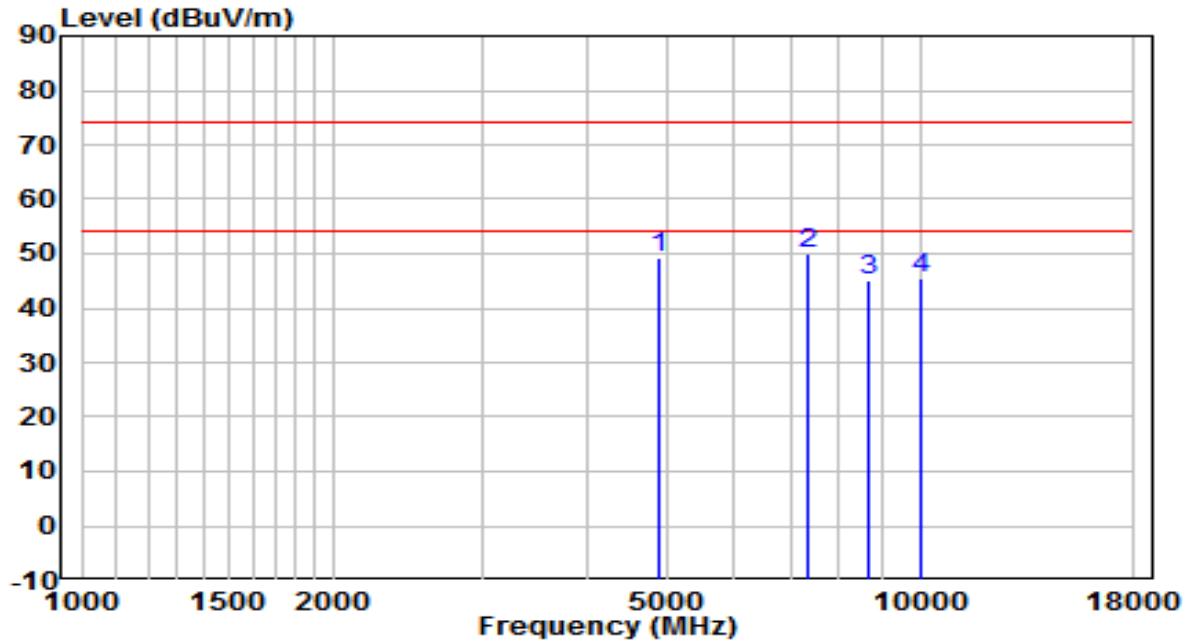

No	Frequency (MHz)	Reading (dBUV)	C.F (dB)	Measurement (dBUV/m)	Margin (dB)	Limit (dBUV/m)	Remark (QP/PK/AV)
1	4884.500	45.80	3.32	49.12	-24.88	74.00	Peak
2	* 7324.000	38.81	11.32	50.13	-23.87	74.00	Peak
3	8658.500	32.32	12.88	45.20	-28.80	74.00	Peak
4	10001.500	30.16	15.26	45.42	-28.58	74.00	Peak

Note:

- "*" means this data is the worst emission level.
- C.F (Correction Factor) = Antenna Factor (dB)+ Cable Loss (dB)- Preamplifier(dB).
- Measurement(dBUV/m) = Reading(dBUV) + C.F (Correction Factor).
- The emission levels of other frequencies are very lower than the limit and not show in test report.

EUT	Ninebot KickScooter	Date of Test	2020-04-14
Factor	BBHA 9120D	Temp. / Humidity	21.5°C/39%
Polarity	Vertical	Site / Test Engineer	AC1 / Jay Chu
Test Mode	BLE_TX_CH19	Test Voltage	AC 120V/60Hz

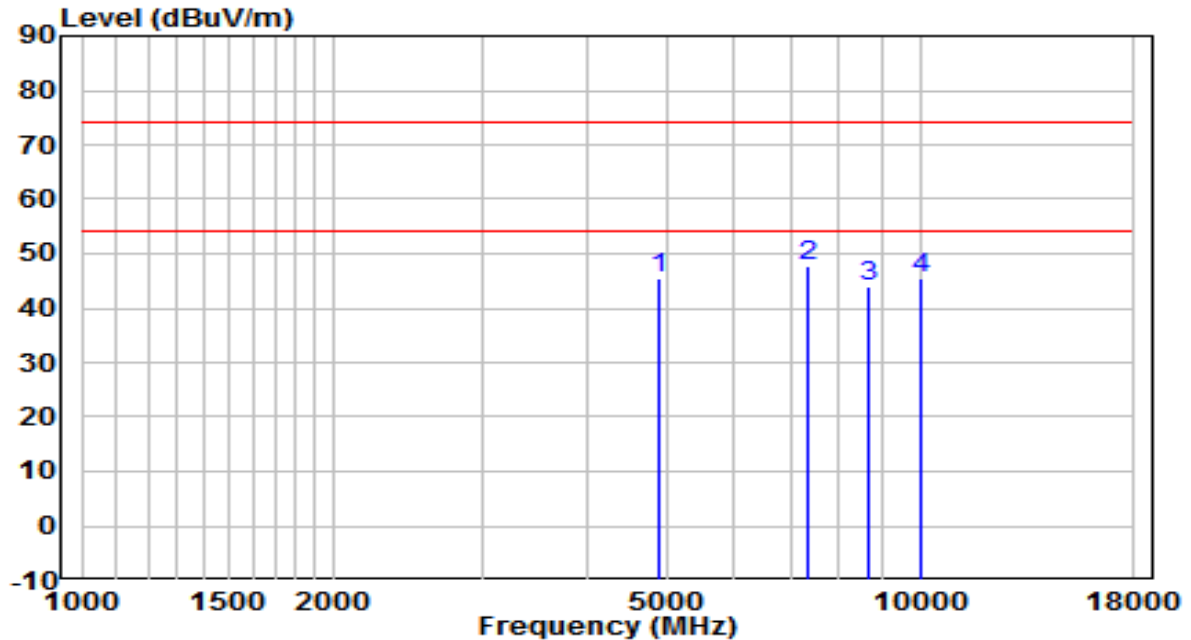

No	Frequency (MHz)	Reading (dBUV)	C.F (dB)	Measurement (dBUV/m)	Margin (dB)	Limit (dBUV/m)	Remark (QP/PK/AV)
1	4884.500	42.11	3.32	45.43	-28.57	74.00	Peak
2	* 7324.000	36.39	11.32	47.72	-26.28	74.00	Peak
3	8650.000	31.25	12.85	44.10	-29.90	74.00	Peak
4	10052.500	29.88	15.43	45.31	-28.69	74.00	Peak

Note:

- "*" means this data is the worst emission level.
- C.F (Correction Factor) = Antenna Factor (dB)+ Cable Loss (dB)– Preamplifier(dB).
- Measurement(dBUV/m) = Reading(dBUV) + C.F (Correction Factor).
- The emission levels of other frequencies are very lower than the limit and not show in test report.

EUT	Ninebot KickScooter	Date of Test	2020-04-14
Factor	BBHA 9120D	Temp. / Humidity	21.5°C/39%
Polarity	Horizontal	Site / Test Engineer	AC1 / Jay Chu
Test Mode	BLE_TX_CH39	Test Voltage	AC 120V/60Hz

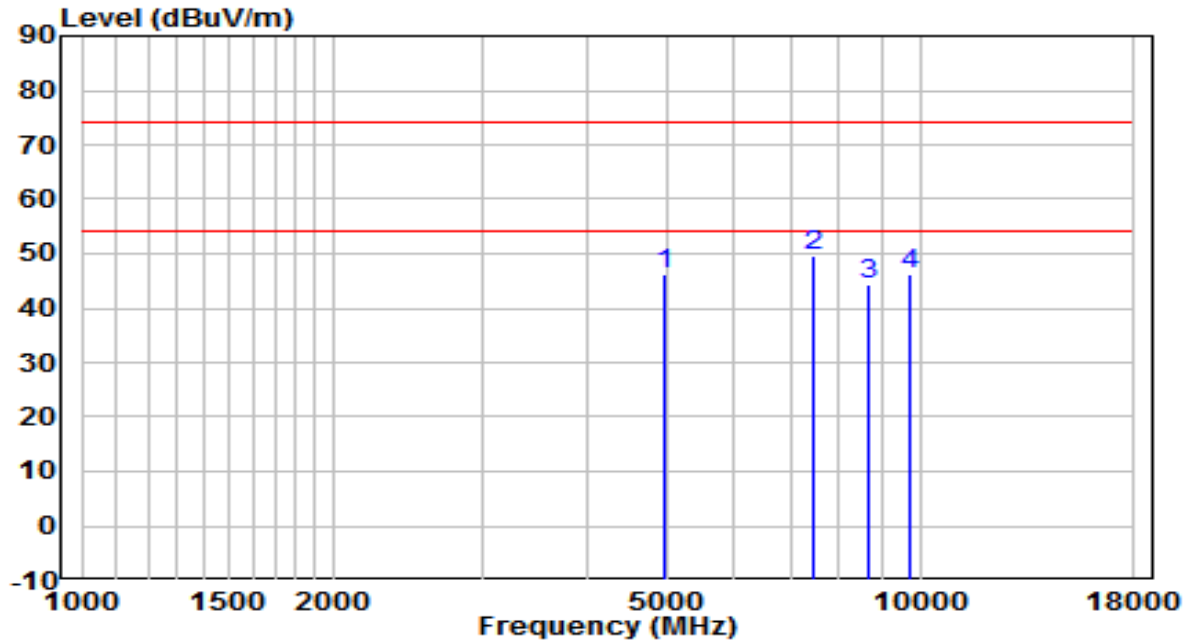

No	Frequency (MHz)	Reading (dBUV)	C.F (dB)	Measurement (dBUV/m)	Margin (dB)	Limit (dBUV/m)	Remark (QP/PK/AV)
1	4961.000	42.93	3.47	46.40	-27.60	74.00	Peak
2	* 7443.000	38.03	11.59	49.62	-24.38	74.00	Peak
3	8658.500	31.52	12.88	44.39	-29.61	74.00	Peak
4	9738.000	31.99	14.40	46.39	-27.61	74.00	Peak

Note:

- "*" means this data is the worst emission level.
- C.F (Correction Factor) = Antenna Factor (dB)+ Cable Loss (dB)– Preamplifier(dB).
- Measurement(dBUV/m) = Reading(dBUV) + C.F (Correction Factor).
- The emission levels of other frequencies are very lower than the limit and not show in test report.

EUT	Ninebot KickScooter	Date of Test	2020-04-14
Factor	BBHA 9120D	Temp. / Humidity	21.5°C/39%
Polarity	Vertical	Site / Test Engineer	AC1 / Jay Chu
Test Mode	BLE_TX_CH39	Test Voltage	AC 120V/60Hz

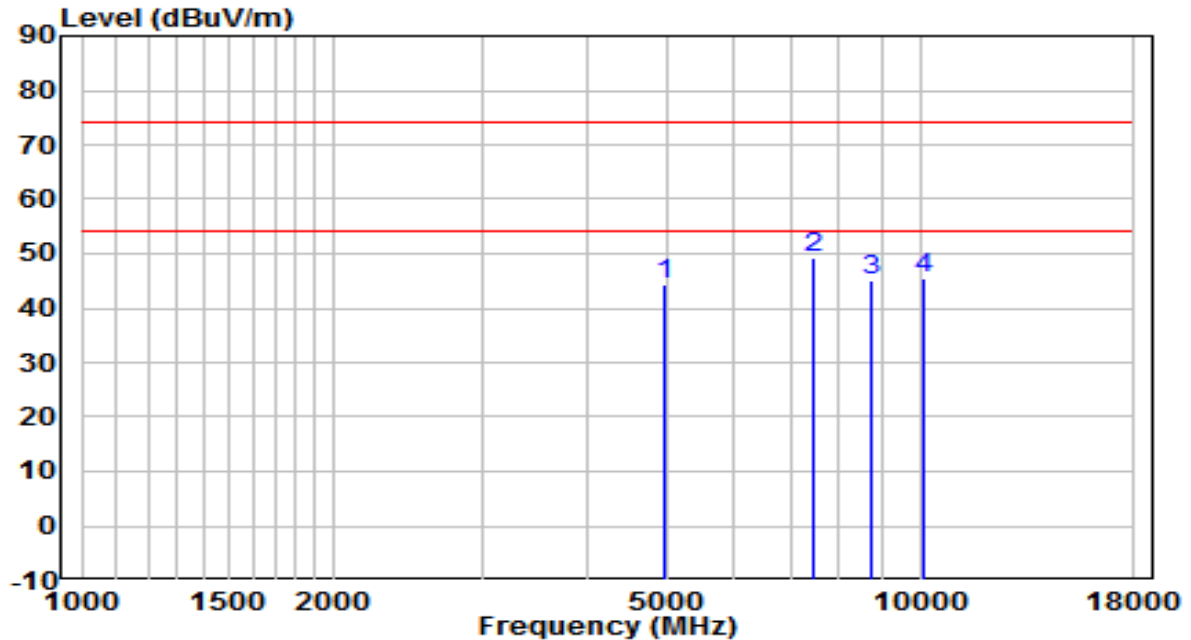

No	Frequency (MHz)	Reading (dBuV)	C.F (dB)	Measurement (dBuV/m)	Margin (dB)	Limit (dBuV/m)	Remark (QP/PK/AV)
1	4961.000	40.99	3.47	44.46	-29.54	74.00	Peak
2	* 7443.000	37.56	11.59	49.15	-24.85	74.00	Peak
3	8735.000	31.86	13.08	44.94	-29.06	74.00	Peak
4	10120.500	29.83	15.65	45.48	-28.52	74.00	Peak

Note:

1. " *", means this data is the worst emission level.
2. C.F (Correction Factor) = Antenna Factor (dB)+ Cable Loss (dB)– Preamplifier(dB).
3. Measurement(dBuV/m) = Reading(dBuV) + C.F (Correction Factor).
- 4.The emission levels of other frequencies are very lower than the limit and not show in test report.

The Worst Case of Radiated Emission below 1GHz:

EUT	Ninebot KickScooter	Date of Test	2020-04-15
Factor	VULB 9162	Temp. / Humidity	21.5°C/39%
Polarity	Horizontal	Site / Test Engineer	AC1 / Jay Chu
Test Mode	BLE_TX_CH19	Test Voltage	AC 120V/60Hz

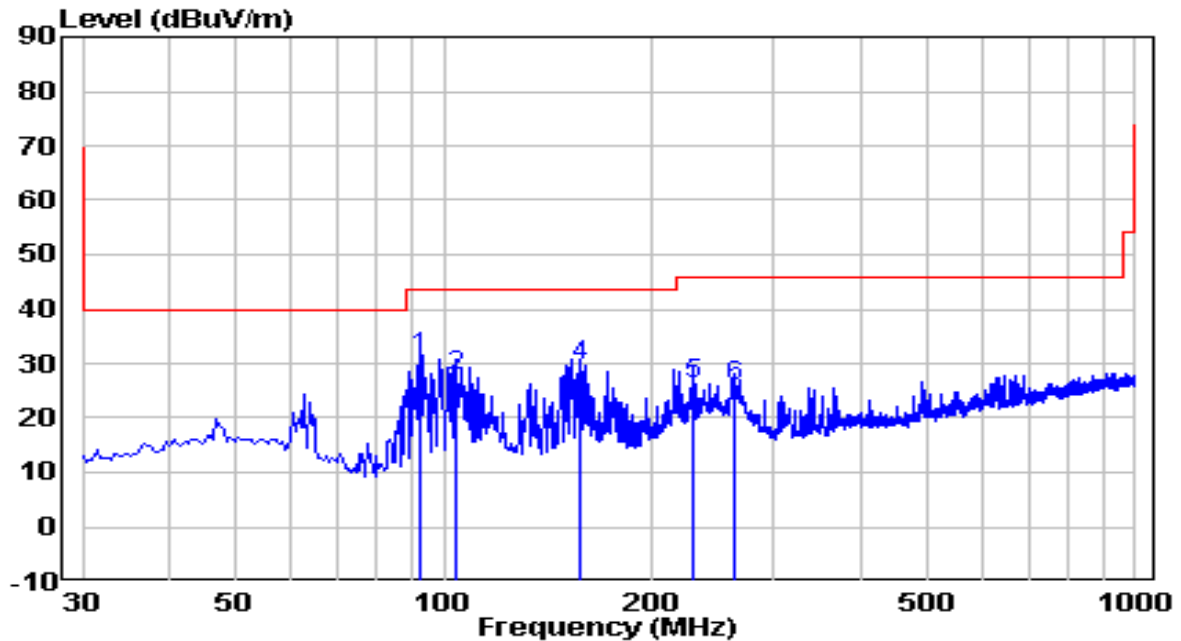

No	Frequency (MHz)	Reading (dBuV)	C.F (dB)	Measurement (dBuV/m)	Margin (dB)	Limit (dBuV/m)	Remark (QP/PK/AV)
1	*	13.39	17.65	31.04	-12.46	43.50	QP
2		527.80	-500.00	27.80	-41.70	69.50	QP
3		520.07	-500.00	20.07	-49.43	69.50	QP
4		529.54	-500.00	29.54	-39.96	69.50	QP
5		526.26	-500.00	26.26	-43.24	69.50	QP
6		525.97	-500.00	25.97	-43.53	69.50	QP

Note:

- "*", means this data is the worst emission level.
- C.F (Correction Factor) = Antenna Factor (dB)+ Cable Loss (dB)– Preamplifier(dB).
- Measurement(dBuV/m) = Reading(dBuV) + C.F (Correction Factor).
- The amplitude of radiated emissions (frequency range from 9kHz to 30MHz and 18GHz to 40GHz) is that proximity to ambient noise, which also are attenuated more than 20 dB below the permissible value. Therefore, the data is not presented in the report.

EUT	Ninebot KickScooter	Date of Test	2020-04-15
Factor	VULB 9162	Temp. / Humidity	21.5°C/39%
Polarity	Vertical	Site / Test Engineer	AC1 / Jay Chu
Test Mode	BLE_TX_CH19	Test Voltage	AC 120V/60Hz

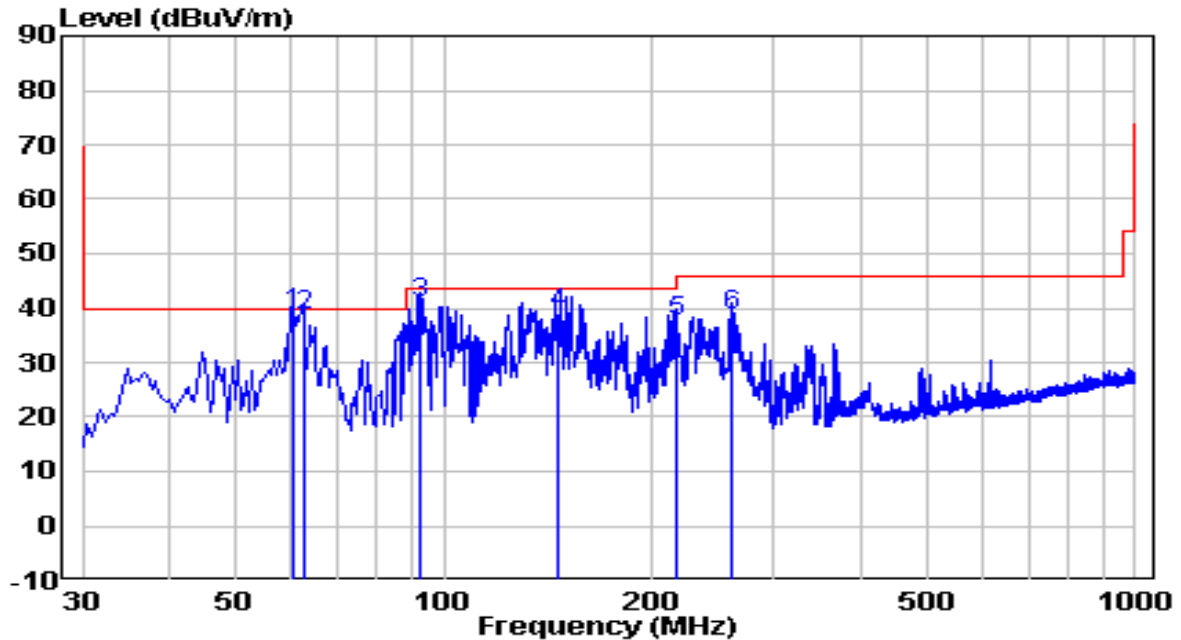

No	Frequency (MHz)	Reading (dBuV)	C.F (dB)	Measurement (dBuV/m)	Margin (dB)	Limit (dBuV/m)	Remark (QP/PK/AV)	
1	*	60.640	19.11	19.88	38.99	-1.01	40.00	QP
2		62.700	19.50	19.13	38.63	-1.37	40.00	QP
3		92.160	23.27	17.57	40.84	-2.66	43.50	QP
4		146.564	23.30	15.66	38.96	-4.54	43.50	QP
5		217.564	18.67	18.92	37.59	-8.41	46.00	QP
6		260.654	18.08	20.58	38.66	-7.34	46.00	QP

Note:

- "*" means this data is the worst emission level.
- C.F (Correction Factor) = Antenna Factor (dB)+ Cable Loss (dB)– Preamplifier(dB).
- Measurement(dBuV/m) = Reading(dBuV) + C.F (Correction Factor).
- The amplitude of radiated emissions (frequency range from 9kHz to 30MHz and 18GHz to 40GHz) is that proximity to ambient noise, which also are attenuated more than 20 dB below the permissible value. Therefore, the data is not presented in the report.

7.7. Radiated Restricted Band Edge Measurement

7.7.1. Test Limit

For 15.205 requirement:

Radiated emissions which fall in the restricted bands, as defined in Section 15.205(a) of FCC part 15, must also comply with the radiated emission limits specified in Section 15.209(a).

Frequency (MHz)	Frequency (MHz)	Frequency (MHz)	Frequency (GHz)
0.090 - 0.110	16.42 - 16.423	399.9 - 410	4.5 - 5.15
¹ 0.495 - 0.505	16.69475 - 16.69525	608 - 614	5.35 - 5.46
2.1735 - 2.1905	16.80425 - 16.80475	960 - 1240	7.25 - 7.75
4.125 - 4.128	25.5 - 25.67	1300 - 1427	8.025 - 8.5
4.17725 - 4.17775	37.5 - 38.25	1435 - 1626.5	9.0 - 9.2
4.20725 - 4.20775	73 - 74.6	1645.5 - 1646.5	9.3 - 9.5
6.215 - 6.218	74.8 - 75.2	1660 - 1710	10.6 - 12.7
6.26775 - 6.26825	108 - 121.94	1718.8 - 1722.2	13.25 - 13.4
6.31175 - 6.31225	123 - 138	2200 - 2300	14.47 - 14.5
8.291 - 8.294	149.9 - 150.05	2310 - 2390	15.35 - 16.2
8.362 - 8.366	156.52475 - 156.52525	2483.5 - 2500	17.7 - 21.4
8.37625 - 8.38675	156.7 - 156.9	2690 - 2900	22.01 - 23.12
8.41425 - 8.41475	162.0125 - 167.17	3260 - 3267	23.6 - 24.0
12.29 - 12.293	167.72 - 173.2	3332 - 3339	31.2 - 31.8
12.51975 - 12.52025	240 - 285	3345.8 - 3358	36.43 - 36.5
12.57675 - 12.57725	322 - 335.4	3600 - 4400	(²)
13.36 - 13.41	--	--	--

All out of band emissions appearing in a restricted band as specified in Section 15.205 of the Title 47CFR must not exceed the limits shown in Table per Section 15.209.

FCC Part 15 Subpart C Paragraph 15.209		
Frequency [MHz]	Field Strength [uV/m]	Measured Distance [Meters]
0.009 - 0.490	2400/F (kHz)	300
0.490 - 1.705	24000/F (kHz)	30
1.705 - 30	30	30
30 - 88	100	3
88 - 216	150	3
216 - 960	200	3
Above 960	500	3

For RSS-Gen Section 8.10 requirement:

Radiated emissions which fall in the restricted bands, as defined in Section 8.10 of RSS-Gen, must also comply with the radiated emission limits specified in Section 8.9.

Frequency (MHz)	Frequency (MHz)	Frequency (GHz)
0.090 - 0.110	149.9 - 150.05	9.0 - 9.2
0.495 - 0.505	156.52475 - 156.52525	9.3 - 9.5
2.1735 - 2.1905	156.7 - 156.9	10.6 - 12.7
3.020 - 3.026	162.0125 - 167.17	13.25 - 13.4
4.125 - 4.128	167.72 - 173.2	14.47 - 14.5
4.17725 - 4.17775	240 - 285	15.35 - 16.2
4.20725 - 4.20775	322 - 335.4	17.7 - 21.4
5.677 - 5.683	399.9 - 410	22.01 - 23.12
6.215 - 6.218	608 - 614	23.6 - 24.0
6.26775 - 6.26825	960 - 1427	31.2 - 31.8
6.31175 - 6.31225	1435 - 1626.5	36.43 - 36.5
8.291 - 8.294	1645.5 - 1646.5	Above 38.6
8.362 - 8.366	1660 - 1710	--
8.37625 - 8.38675	1718.8 - 1722.2	
8.41425 - 8.41475	2200 - 2300	
12.29 - 12.293	2310 - 2390	
12.51975 - 12.52025	2483.5 - 2500	
12.57675 - 12.57725	2655 - 2900	
13.36 - 13.41	3260 - 3267	
16.42 - 16.423	3332 - 3339	
16.69475 - 16.69525	3345.8 - 3358	
16.80425 - 16.80475	3500 - 4400	
25.5 - 25.67	4500 - 5150	
37.5 - 38.25	5350 - 5460	
73 - 74.6	7250 - 7750	
74.8 - 75.2	8025 - 8500	
108 - 138		

All out of band emissions appearing in a restricted band as specified in Section 8.10 of the RSS-Gen must not exceed the limits shown in Table per Section 8.9.

RSS-Gen Section 8.9			
Frequency (MHz)	Field Strength ($\mu\text{V}/\text{m}$)	Magnetic Field Strength (H-Field) ($\mu\text{A}/\text{m}$)	Measured Distance (m)
0.009 - 0.490	--	6.37/F (F in kHz)	300
0.490 - 1.705	--	6.37/F (F in kHz)	30
1.705 - 30	--	0.08	30
30 - 88	100	--	3
88 - 216	150	--	3
216 - 960	200	--	3
Above 960	500	--	3

7.7.2. Test Procedure Used

ANSI C63.10 Section 6.3 (General Requirements)

ANSI C63.10 Section 6.6 (Standard test method above 1GHz)

7.7.3. Test Setting

Peak Field Strength Measurements

1. Analyzer center frequency was set to the frequency of the radiated spurious emission of interest
2. RBW = 1MHz
3. VBW = 3MHz
4. Detector = peak
5. Sweep time = auto couple
6. Trace mode = max hold
7. Trace was allowed to stabilize

Average Field Strength Measurements

1. Analyzer center frequency was set to the frequency of the radiated spurious emission of interest
2. RBW = 1MHz
3. VBW $\geq 1/T$
4. As an alternative, the instrument may be set to linear detector mode. Ensure that video filtering is applied in linear voltage domain (rather than in a log or dB domain). Some instruments require linear display mode in order to accomplish this. Others have a setting for Average-VBW Type, which can be set to "Voltage" regardless of the display mode
5. Detector = Peak
6. Sweep time = auto
7. Trace mode = max hold
8. Allow max hold to run for at least 50 times (1/duty cycle) traces

7.7.4. Test Setup

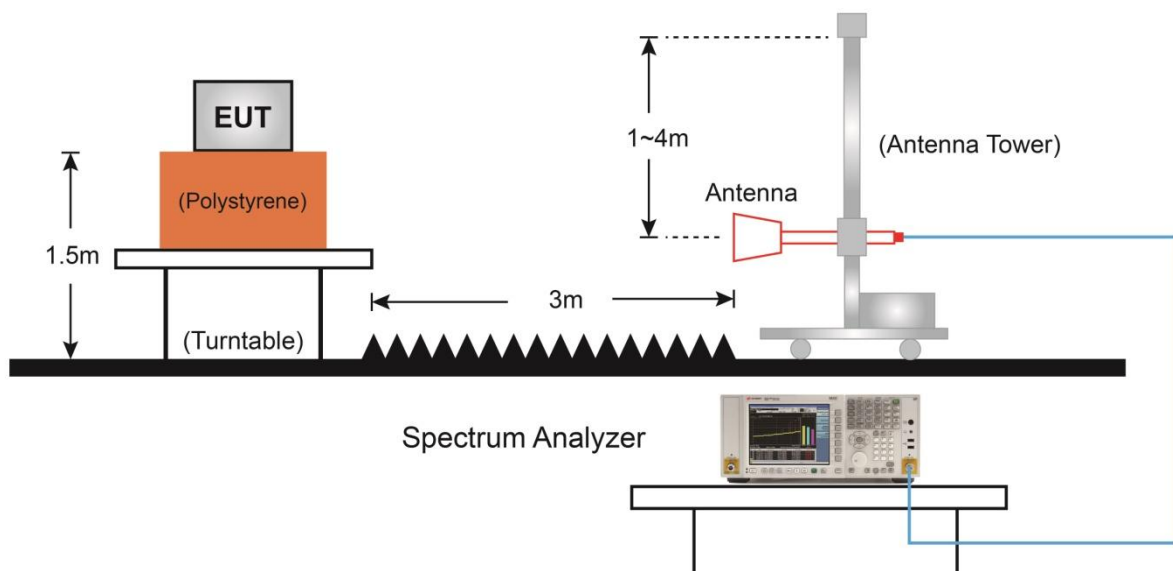

7.7.5. Test Result

EUT	Ninebot KickScooter	Date of Test	2020-04-14
Factor	BBHA 9120D	Temp. / Humidity	21.2°C/39%
Polarity	Horizontal	Site / Test Engineer	AC1 / Jay Chu
Test Mode	BLE_TX_CH00	Test Voltage	AC 120V/60Hz

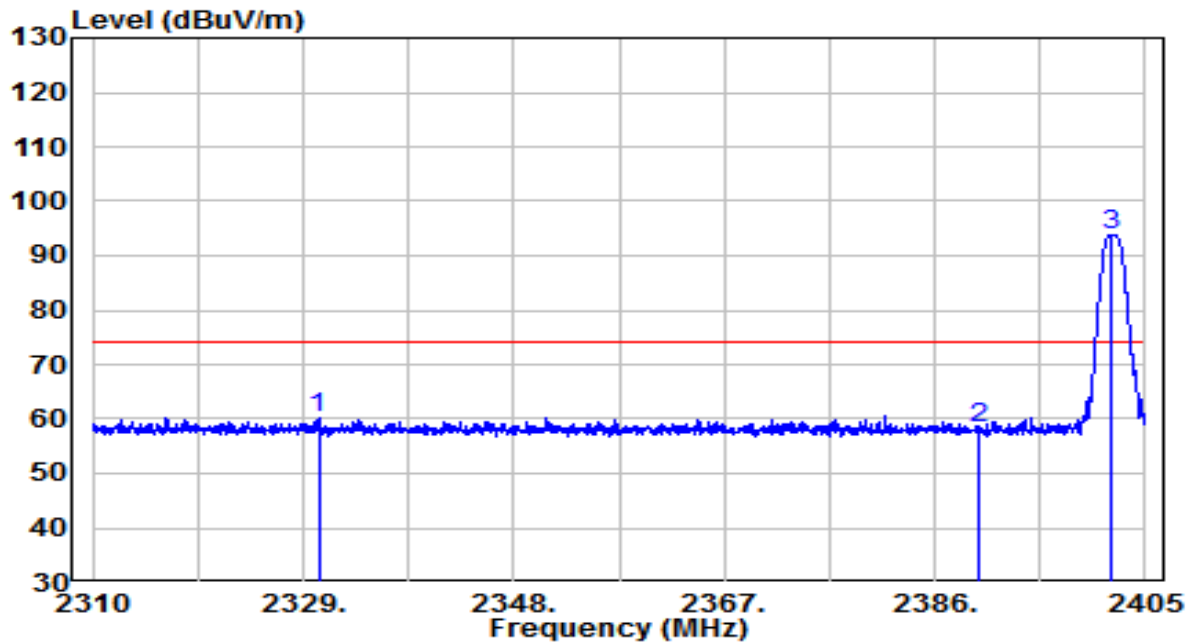

No	Frequency (MHz)	Reading (dBuV)	C.F (dB)	Measurement (dBuV/m)	Margin (dB)	Limit (dBuV/m)	Remark (QP/PK/AV)
1	2330.377	28.11	32.00	60.11	-13.89	74.00	Peak
2	2390.000	26.11	32.27	58.39	-15.61	74.00	Peak
3	* 2401.817	61.45	32.33	93.78	N/A	N/A	Peak

Note:

1. " *", means this data is the worst emission level.
2. C.F (Correction Factor) = Antenna Factor (dB)+ Cable Loss (dB)– Preamplifier(dB).
3. Measurement(dBuV/m) = Reading(dBuV) + C.F (Correction Factor).
4. The emission levels of other frequencies are very lower than the limit and not show in test report.

EUT	Ninebot KickScooter	Date of Test	2020-04-14
Factor	BBHA 9120D	Temp. / Humidity	21.2°C/39%
Polarity	Horizontal	Site / Test Engineer	AC1 / Jay Chu
Test Mode	BLE_TX_CH00	Test Voltage	AC 120V/60Hz

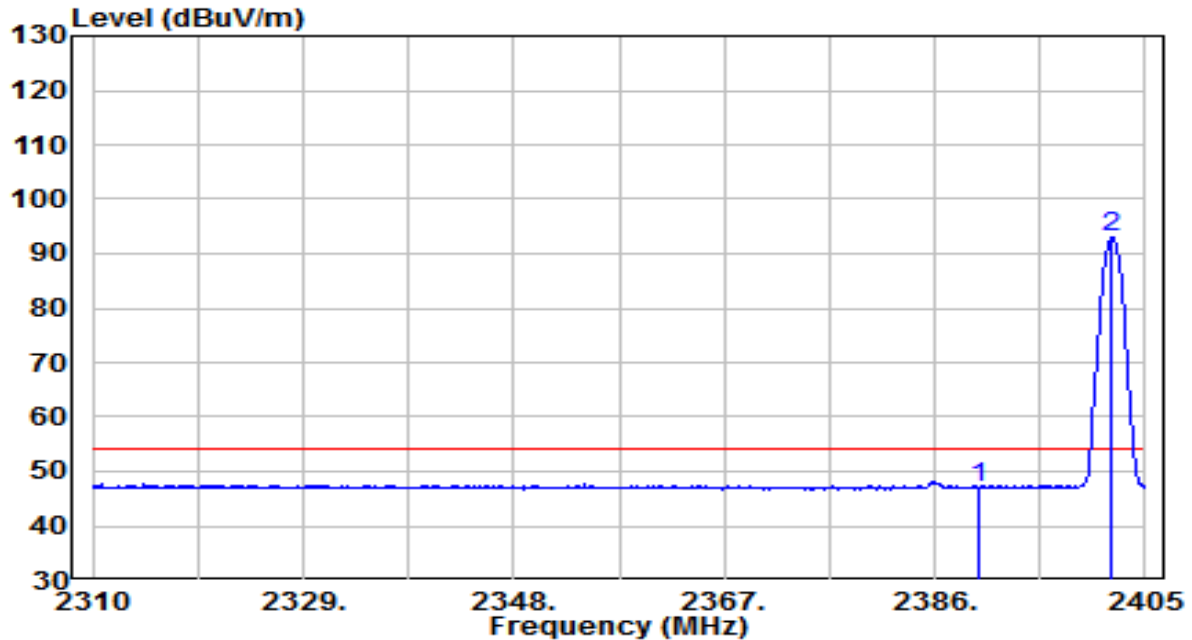

No	Frequency (MHz)	Reading (dBuV)	C.F (dB)	Measurement (dBuV/m)	Margin (dB)	Limit (dBuV/m)	Remark (QP/PK/AV)
1	2390.000	14.73	32.27	47.00	-7.00	54.00	Average
2	* 2402.008	60.81	32.33	93.14	N/A	N/A	Average

Note:

- "*" means this data is the worst emission level.
- C.F (Correction Factor) = Antenna Factor (dB)+ Cable Loss (dB)– Preamplifier(dB).
- Measurement(dBuV/m) = Reading(dBuV) + C.F (Correction Factor).
- The emission levels of other frequencies are very lower than the limit and not show in test report.

EUT	Ninebot KickScooter	Date of Test	2020-04-14
Factor	BBHA 9120D	Temp. / Humidity	21.2°C/39%
Polarity	Vertical	Site / Test Engineer	AC1 / Jay Chu
Test Mode	BLE_TX_CH00	Test Voltage	AC 120V/60Hz

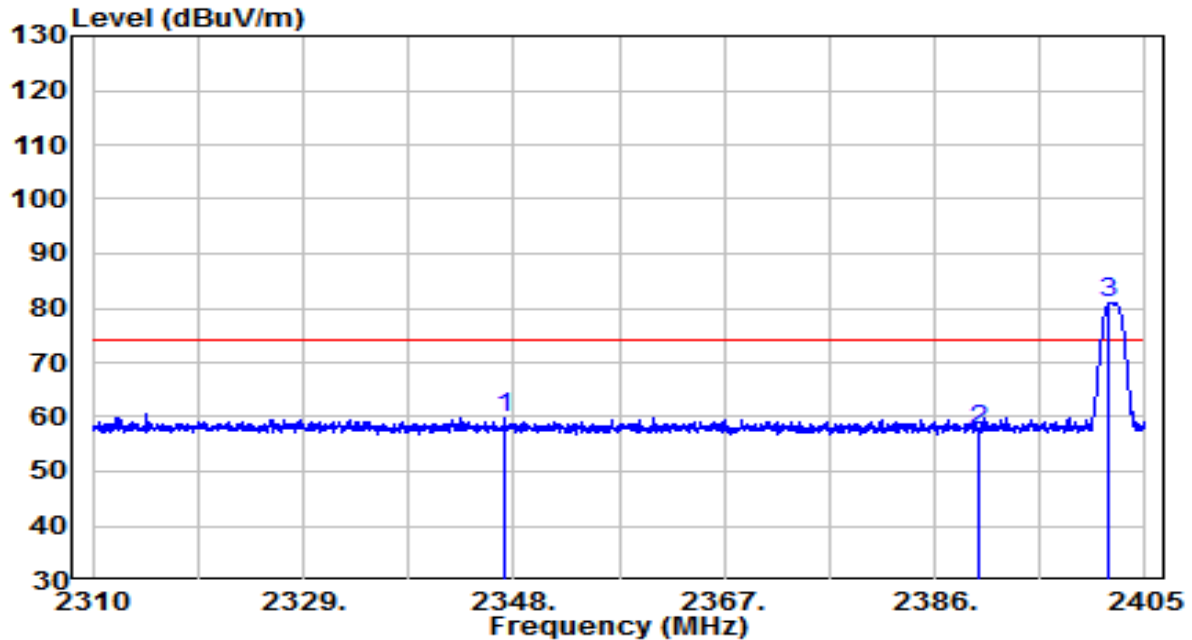

No	Frequency (MHz)	Reading (dBUV)	C.F (dB)	Measurement (dBUV/m)	Margin (dB)	Limit (dBUV/m)	Remark (QP/PK/AV)
1	2347.240	27.92	32.08	59.99	-14.01	74.00	Peak
2	2390.000	25.25	32.27	57.53	-16.47	74.00	Peak
3	* 2401.770	48.67	32.33	81.00	N/A	N/A	Peak

Note:

1. " *", means this data is the worst emission level.
2. C.F (Correction Factor) = Antenna Factor (dB)+ Cable Loss (dB)– Preamplifier(dB).
3. Measurement(dBUV/m) = Reading(dBUV) + C.F (Correction Factor).
- 4.The emission levels of other frequencies are very lower than the limit and not show in test report.

EUT	Ninebot KickScooter	Date of Test	2020-04-14
Factor	BBHA 9120D	Temp. / Humidity	21.2°C/39%
Polarity	Vertical	Site / Test Engineer	AC1 / Jay Chu
Test Mode	BLE_TX_CH00	Test Voltage	AC 120V/60Hz

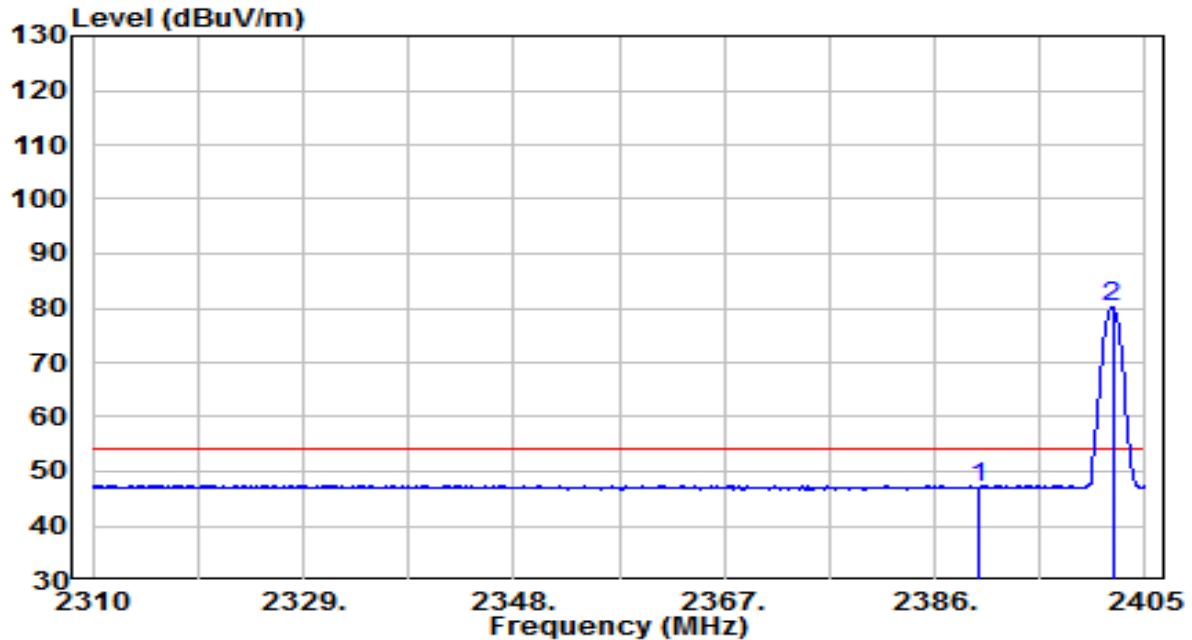

No	Frequency (MHz)	Reading (dBuV)	C.F (dB)	Measurement (dBuV/m)	Margin (dB)	Limit (dBuV/m)	Remark (QP/PK/AV)
1	2390.000	14.58	32.27	46.86	-7.14	54.00	Average
2	* 2402.055	47.78	32.33	80.11	N/A	N/A	Average

Note:

- "*" means this data is the worst emission level.
- C.F (Correction Factor) = Antenna Factor (dB)+ Cable Loss (dB)– Preamplifier(dB).
- Measurement(dBuV/m) = Reading(dBuV) + C.F (Correction Factor).
- The emission levels of other frequencies are very lower than the limit and not show in test report.

EUT	Ninebot KickScooter	Date of Test	2020-04-14
Factor	BBHA 9120D	Temp. / Humidity	21.2°C/39%
Polarity	Horizontal	Site / Test Engineer	AC1 / Jay Chu
Test Mode	BLE_TX_CH39	Test Voltage	AC 120V/60Hz

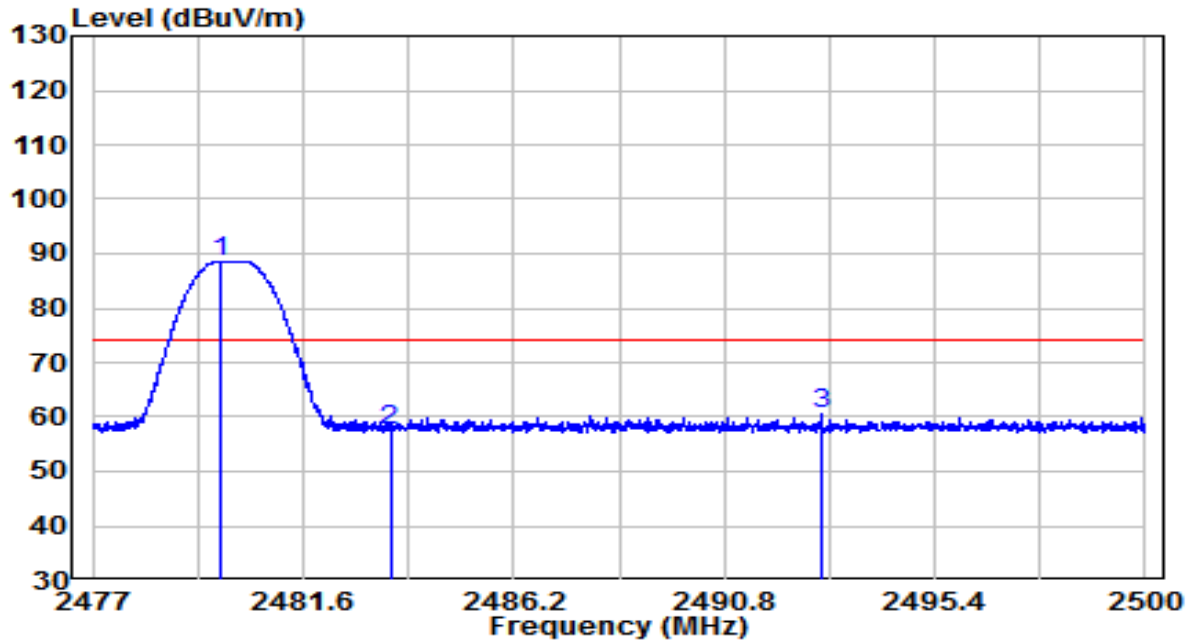

No	Frequency (MHz)	Reading (dBuV)	C.F (dB)	Measurement (dBuV/m)	Margin (dB)	Limit (dBuV/m)	Remark (QP/PK/AV)
1	* 2479.783	55.96	32.69	88.65	N/A	N/A	Peak
2	2483.500	24.86	32.70	57.57	-16.43	74.00	Peak
3	2492.939	27.75	32.75	60.50	-13.50	74.00	Peak

Note:

1. " *", means this data is the worst emission level.
2. C.F (Correction Factor) = Antenna Factor (dB)+ Cable Loss (dB)– Preamplifier(dB).
3. Measurement(dBuV/m) = Reading(dBuV) + C.F (Correction Factor).
- 4.The emission levels of other frequencies are very lower than the limit and not show in test report.

EUT	Ninebot KickScooter	Date of Test	2020-04-14
Factor	BBHA 9120D	Temp. / Humidity	21.2°C/39%
Polarity	Horizontal	Site / Test Engineer	AC1 / Jay Chu
Test Mode	BLE_TX_CH39	Test Voltage	AC 120V/60Hz

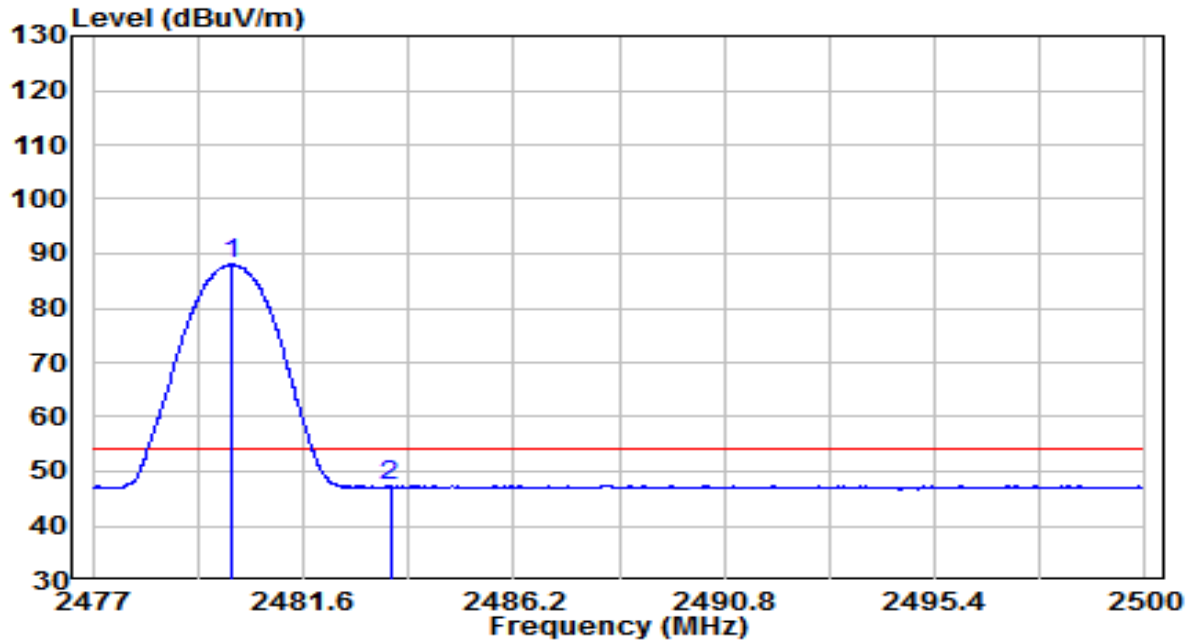

No	Frequency (MHz)	Reading (dBUV)	C.F (dB)	Measurement (dBUV/m)	Margin (dB)	Limit (dBUV/m)	Remark (QP/PK/AV)
1	*	55.30	32.69	87.99	N/A	N/A	Average
2		14.50	32.70	47.21	-6.79	54.00	Average

Note:

- "*" means this data is the worst emission level.
- C.F (Correction Factor) = Antenna Factor (dB)+ Cable Loss (dB)– Preamplifier(dB).
- Measurement(dBUV/m) = Reading(dBUV) + C.F (Correction Factor).
- The emission levels of other frequencies are very lower than the limit and not show in test report.

EUT	Ninebot KickScooter	Date of Test	2020-04-14
Factor	BBHA 9120D	Temp. / Humidity	21.2°C/39%
Polarity	Vertical	Site / Test Engineer	AC1 / Jay Chu
Test Mode	BLE_TX_CH39	Test Voltage	AC 120V/60Hz

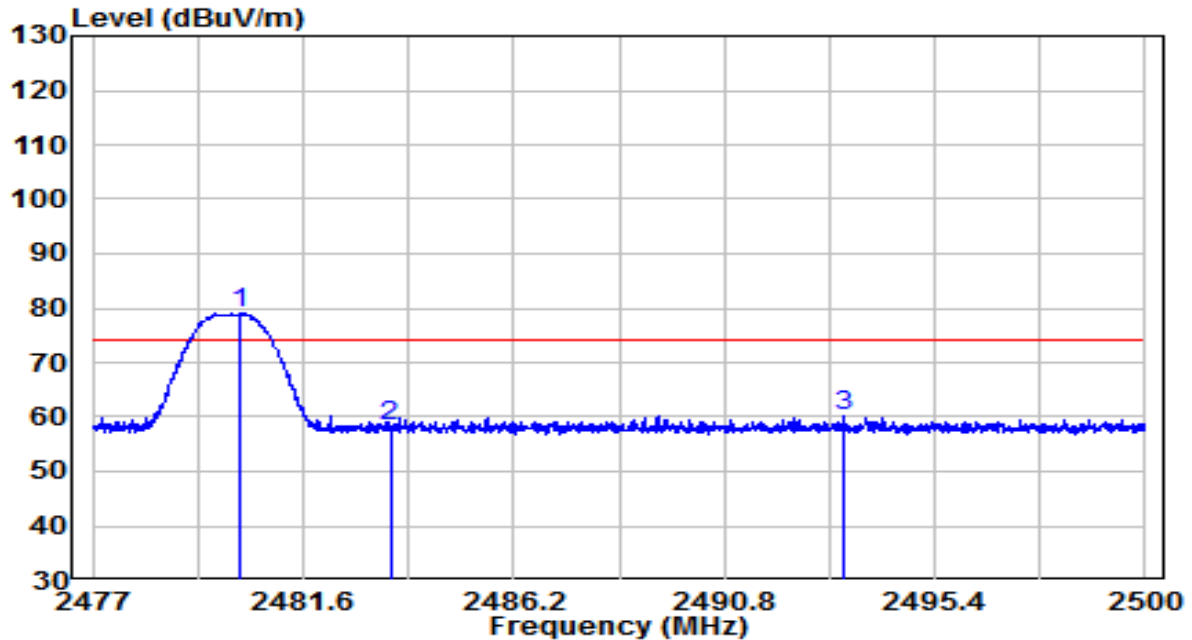

No	Frequency (MHz)	Reading (dBuV)	C.F (dB)	Measurement (dBuV/m)	Margin (dB)	Limit (dBuV/m)	Remark (QP/PK/AV)
1	* 2480.243	46.35	32.69	79.04	N/A	N/A	Peak
2	2483.500	25.72	32.70	58.43	-15.57	74.00	Peak
3	2493.387	27.44	32.75	60.19	-13.81	74.00	Peak

Note:

1. " *", means this data is the worst emission level.
2. C.F (Correction Factor) = Antenna Factor (dB)+ Cable Loss (dB)– Preamplifier(dB).
3. Measurement(dBuV/m) = Reading(dBuV) + C.F (Correction Factor).
- 4.The emission levels of other frequencies are very lower than the limit and not show in test report.

EUT	Ninebot KickScooter	Date of Test	2020-04-14
Factor	BBHA 9120D	Temp. / Humidity	21.2°C/39%
Polarity	Vertical	Site / Test Engineer	AC1 / Jay Chu
Test Mode	BLE_TX_CH39	Test Voltage	AC 120V/60Hz

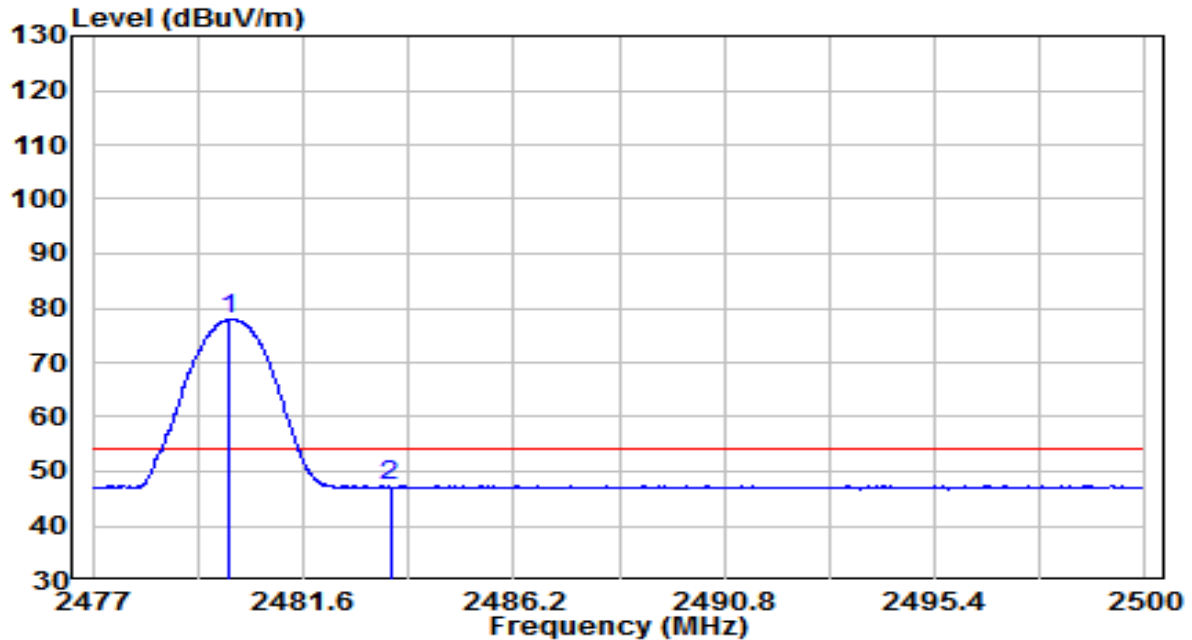

No	Frequency (MHz)	Reading (dBuV)	C.F (dB)	Measurement (dBuV/m)	Margin (dB)	Limit (dBuV/m)	Remark (QP/PK/AV)
1	*	45.32	32.69	78.00	N/A	N/A	Average
2		14.47	32.70	47.17	-6.83	54.00	Average

Note:

1. " *", means this data is the worst emission level.
2. C.F (Correction Factor) = Antenna Factor (dB)+ Cable Loss (dB)– Preamplifier(dB).
3. Measurement(dBuV/m) = Reading(dBuV) + C.F (Correction Factor).
- 4.The emission levels of other frequencies are very lower than the limit and not show in test report.

7.8. AC Conducted Emissions Measurement

7.8.1. Test Limit

FCC Part 15 Subpart C Paragraph 15.207 / RSS-Gen Issue 5 Section 8.8 Limits		
Frequency (MHz)	QP (dBuV)	AV (dBuV)
0.15 - 0.50	66 - 56	56 - 46
0.50 - 5.0	56	46
5.0 - 30	60	50

Note 1: The lower limit shall apply at the transition frequencies.

Note 2: The limit decreases linearly with the logarithm of the frequency in the range 0.15MHz to 0.5MHz.

7.8.2. Test Setup

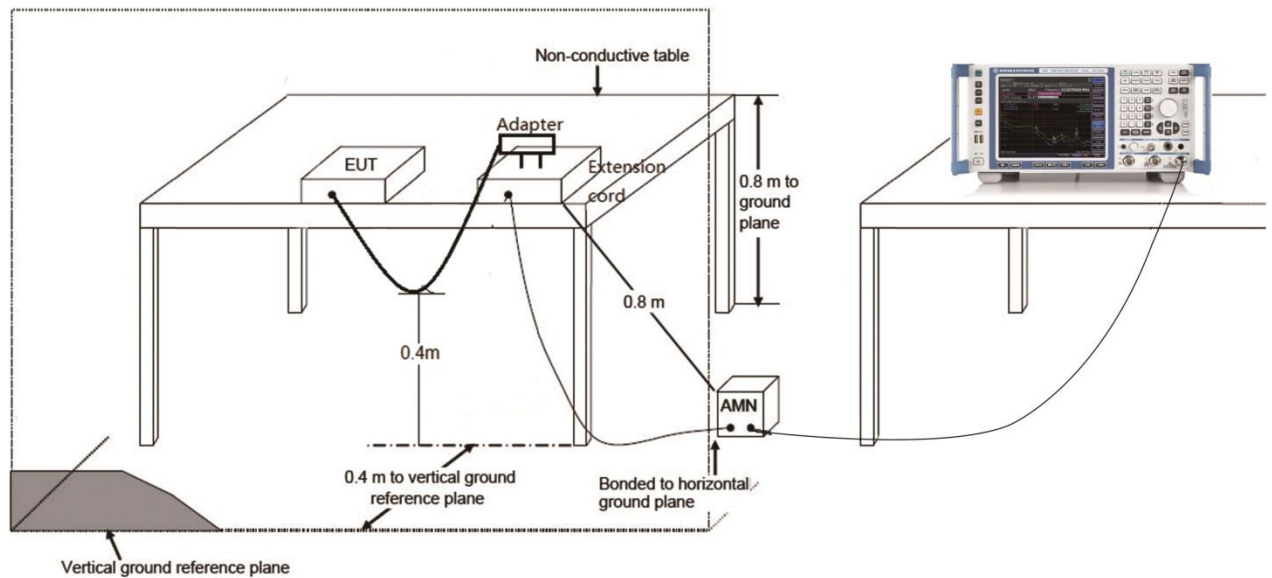

7.8.3. Test Result

Site: SR2	Time: 2020/01/14 - 14:10
Limit: FCC_Part15.207_CE_AC Power	Engineer: Peter Syu
Probe: TW ENV216 (Filter On)_2019	Polarity: Line
EUT: Ninebot KickScooter	Power: AC 120V/60Hz
Test Mode 1	

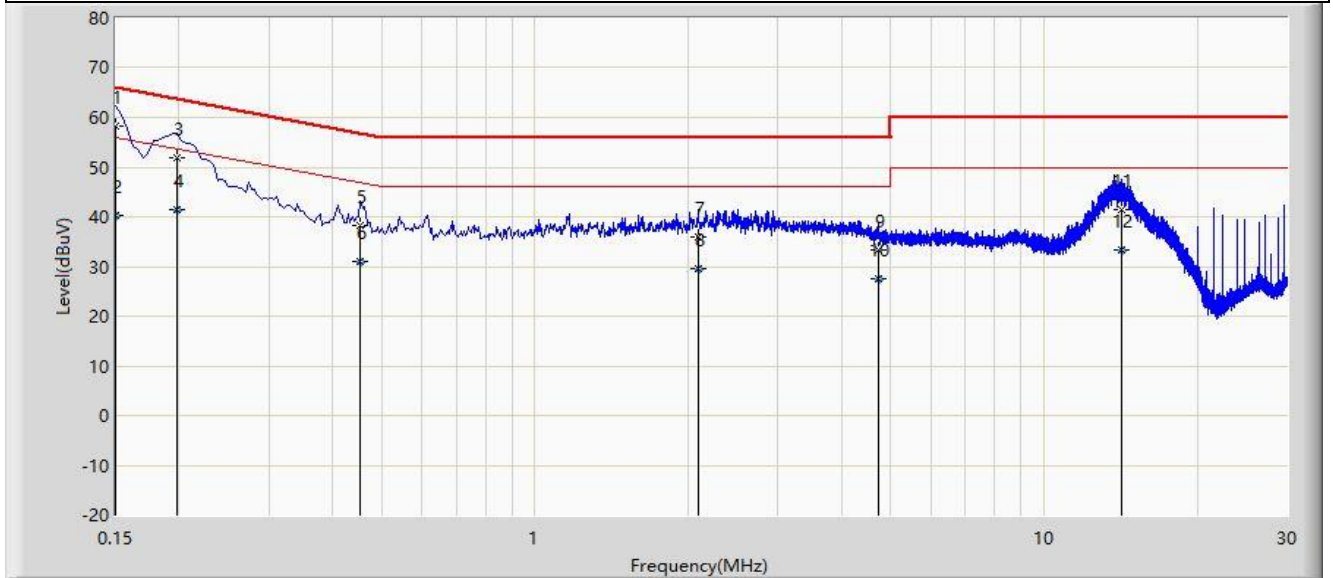

No	Flag	Mark	Frequency (MHz)	Measure Level (dBuV)	Reading Level (dBuV)	Margin (dB)	Limit (dBuV)	Factor (dB)	Type
1		s	0.150	58.211	47.263	-7.789	66.000	10.949	QP
2			0.150	40.405	29.457	-15.595	56.000	10.949	AV
3			0.198	51.930	42.338	-11.764	63.694	9.593	QP
4			0.198	41.409	31.817	-12.285	53.694	9.593	AV
5			0.454	38.374	28.772	-18.427	56.802	9.602	QP
6			0.454	30.958	21.356	-15.843	46.802	9.602	AV
7			2.090	36.078	26.389	-19.922	56.000	9.689	QP
8			2.090	29.557	19.868	-16.443	46.000	9.689	AV
9			4.718	33.326	23.591	-22.674	56.000	9.735	QP
10			4.718	27.646	17.911	-18.354	46.000	9.735	AV
11			14.170	41.366	31.438	-18.634	60.000	9.928	QP
12			14.170	33.366	23.438	-16.634	50.000	9.928	AV

Note: Measure Level (dBμV) = Reading Level (dBμV) + Factor (dB)

Factor (dB) = Cable Loss (dB) + LISN Factor (dB)

Site: SR2	Time: 2020/01/14 - 14:10
Limit: FCC_Part15.207_CE_AC Power	Engineer: Peter Syu
Probe: TW ENV216 (Filter On)_2019	Polarity: Neutral
EUT: Ninebot KickScooter	Power: AC 120V/60Hz
Test Mode 1	

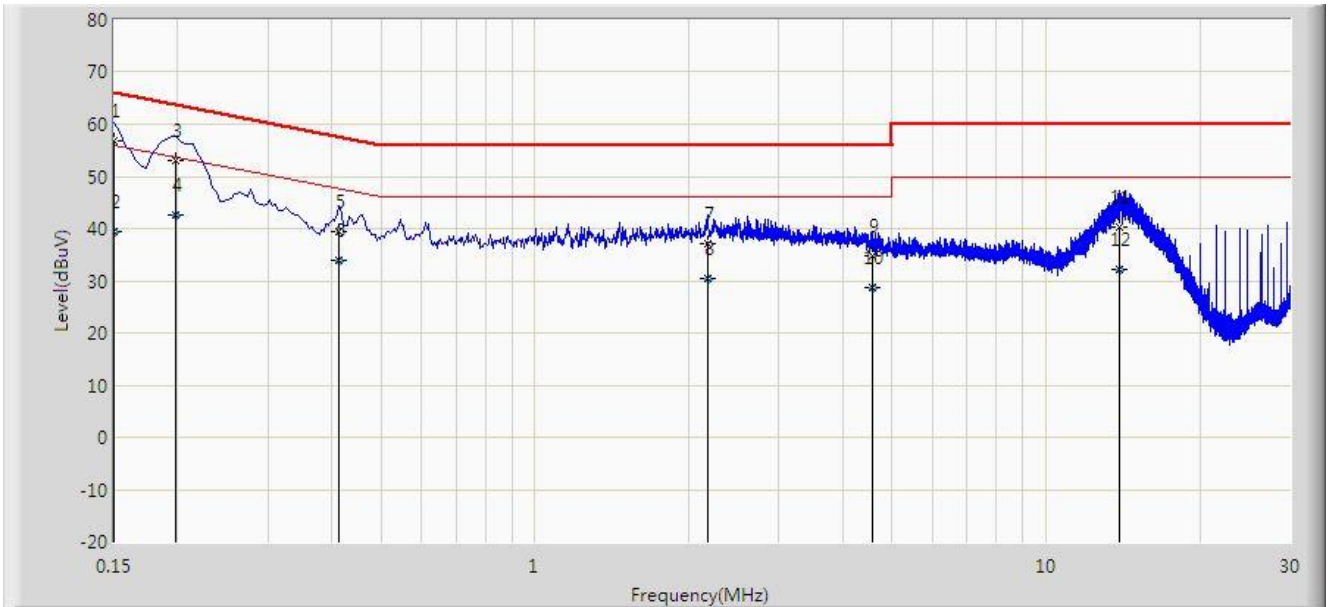

No	Flag	Mark	Frequency (MHz)	Measure Level (dBuV)	Reading Level (dBuV)	Margin (dB)	Limit (dBuV)	Factor (dB)	Type
1		*	0.150	56.877	45.926	-9.123	66.000	10.951	QP
2			0.150	39.416	28.465	-16.584	56.000	10.951	AV
3			0.198	52.981	43.373	-10.713	63.694	9.609	QP
4			0.198	42.726	33.118	-10.968	53.694	9.609	AV
5			0.414	39.424	29.813	-18.144	57.568	9.611	QP
6			0.414	33.817	24.206	-13.751	47.568	9.611	AV
7			2.174	37.155	27.467	-18.845	56.000	9.688	QP
8			2.174	30.366	20.678	-15.634	46.000	9.688	AV
9			4.570	34.794	25.070	-21.206	56.000	9.724	QP
10			4.570	28.687	18.963	-17.313	46.000	9.724	AV
11			13.902	40.427	30.475	-19.573	60.000	9.952	QP
12			13.902	32.050	22.098	-17.950	50.000	9.952	AV

Note: Measure Level (dBμV) = Reading Level (dBμV) + Factor (dB)

Factor (dB) = Cable Loss (dB) + LISN Factor (dB)

8. CONCLUSION

The data collected relate only the item(s) tested and show that the unit is compliance with Part 15C of the FCC rules and ISED rules.

————— The End —————

Appendix A - Test Setup Photograph

Refer to "2004TW0004-UT" file.

Appendix B - EUT Photograph

Refer to "2004TW0004-UE" file.