

FCC 47 CFR PART 15 SUBPART C

Canada RSS-247 Issue2

Canada RSS-Gen Issue5

TEST REPORT

For

Product Name: Ninebot Gokart Kit

Brand Name: Ninebot

Model No.: N4MZ98

Series Model.:N/A

FCC ID: 2ALS8-GK7053

IC: 22636-GK7053

Test Report Number:

C180502R01-RPB1

Issued for

Ninebot (Changzhou) Tech Co., Ltd.

16F-17F, Block A, Building 3, Changwu Mid Road 18#, Wujin Dist., Changzhou, Jiangsu, China

Issued by

Compliance Certification Services Inc.

Kun shan Laboratory

**No.10 Weiye Rd., Innovation park, Eco&Tec,
Development Zone, Kunshan City, Jiangsu, China**

TEL: 86-512-57355888

FAX: 86-512-57370818



Note: This report shall not be reproduced except in full, without the written approval of Compliance Certification Services Inc. This document may be altered or revised by Compliance Certification Services Inc. personnel only, and shall be noted in the revision section of the document. The client should not use it to claim product endorsement by A2LA or any government agencies. The test results in the report only apply to the tested sample.

TABLE OF CONTENTS

1	TEST RESULT CERTIFICATION	4
2	EUT DESCRIPTION	5
3	TEST METHODOLOGY	6
	3.1 EUT CONFIGURATION	6
	3.2 EXERCISEEUT	6
	3.3 GENERAL TEST PROCEDURES	6
	3.4 TEST MODE	7
	3.5 RESTRICTED BANDS OF OPERATIONS	8
	3.6 ANTENNA DESCRIPTION	10
4	INSTRUMENT CALIBRATION	11
5	FACILITIES AND ACCREDITATIONS	11
	5.1 FACILITIES	11
	5.2 EQUIPMENT	11
	5.3 LABORATORY ACCREDITATIONS AND LISTING	11
	5.4 TABLE OF ACCREDITATIONS	12
	5.5 LIST OF MEASURING EQUIPMENT	13
	5.6 MEASUREMENT UNCERTAINTY	15
	5.7 SETUP CONFIGURATION	16
	5.8 SUPPORT EQUIPMENT	16
6	FCC PART 15.247 & RSS-247 REQUIREMENTS	17
	6.1 MAXMUM CONDUCTED OUTPUT POWER	17
	6.2 PEAK POWER SPECTRAL DENSITY	19
	6.3 6DB BANDWIDTH MEASUREMENT	22
	6.4 99% BANDWIDTH MEASUREMENT	25
	6.5 CONDUCTED BAND EDGES AND SPURIOUS EMISSION MEASUREMENT	28
	6.6 RADIATED BAND EDGE AND SPURIOUS EMISSION MEASUREMENT	35
	6.7 POWERLINE CONDUCTED EMISSIONS	47

Revision History

Rev.	Issue Date	Report NO.	Effect Page	Contents
00	May 16, 2018	C180502R01-RPB1	ALL	N/A
01	July 23, 2018	C180502R01-RPB1	P6;P9;P17; P19;P22;P28; P36; P39;P48	Add KDB 558074 and ISED standard to Section 3; Add the restricted band section of ISED standard to Section 3.5; Add the ISED standard in the test items to Section 6; Add the plots of duty cycle to in page 39.

1 TEST RESULT CERTIFICATION

Product Name:	Ninebot Gokart Kit
Trade Name:	Ninebot
Model Name:	N4MZ98
Series Model:	N/A
Applicant Discrepancy:	Initial
Device Category:	mobile unit
Date of Test:	May 2, 2018 ~ May 16, 2018
Applicant:	Ninebot (Changzhou) Tech Co., Ltd. 16F-17F, Block A, Building 3, Changwu Mid Road 18#, Wujin Dist., Changzhou, Jiangsu, China
Manufacturer:	Ninebot (Changzhou) Tech Co., Ltd. 16F-17F, Block A, Building 3, Changwu Mid Road 18#, Wujin Dist., Changzhou, Jiangsu, China
Application Type:	Certification

APPLICABLE STANDARDS	
STANDARD	TEST RESULT
FCC 47 CFR Part 15 Subpart C	No non-compliance noted
Canada RSS-247 Issue2	No non-compliance noted
Canada RSS-Gen Issue5	No non-compliance noted

The above equipment was tested by Compliance Certification Services Inc. The test data, data evaluation, test procedures, and equipment configurations shown in this report were made in accordance with the procedures given in ANSI C63.10:2013 and the energy emitted by the sample EUT tested as described in this report is in compliance with the requirements of FCC Rules Part 15.207, 15.209, 15.247 and IC rules RSS-247 Issue2, RSS-Gen Issue5.

The test results of this report relate only to the tested sample EUT identified in this report.

Approved by:



Tested by:

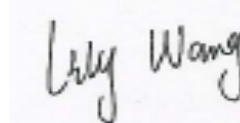

Jeff.Fang
RF Manager
Compliance Certification Services Inc.

Lily.Wang
Test Engineer
Compliance Certification Services Inc.

2 EUT DESCRIPTION

Product Name:	Ninebot Gokart Kit
Trade Name:	Ninebot
Model Name:	N4MZ98
Series Model:	N/A
Model Discrepancy:	N/A
EUT Power Rating:	DC 6-9V
Frequency Range :	Bluetooth:2402 ~ 2480 MHz
Transmit Power :	Bluetooth LE4.1: 0.38dBm(1.09mW)
Channel Spacing	Bluetooth LE4.1: 2MHz
Modulation type:	Bluetooth LE4.1: GFSK
Transmit Data Rate :	Bluetooth LE4.1: 1 Mbps
Number of Channels :	Bluetooth LE4.1: 40 Channels
Antenna Specification :	PCB Antenna
Antenna Specification:	5.0dBi

Remark:

- 1.The sample selected for test was engineering sample that approximated to production product and was provided by manufacturer.
- 2.This submittal(s) (test report) is intended for **FCC ID: 2ALS8-GK7053** filing to comply with Section 15.207, 15.209 and 15.247 of the FCC Part 15, Subpart C Rules.
- 3.This submittal(s) (test report) is intended for **IC: 22636-GK7053** filing to comply with IC rules RSS-247 Issue2, RSS-Gen Issue5.

3 TEST METHODOLOGY

The tests documented in this report were performed in accordance with ANSI C63.10 and FCC CFR 47 2.1046, 2.1047, 2.1049, 2.1051, 2.1053, 2.1055, 2.1057, 15.207, 15.209, 15.247, KDB 558074 and IC rules RSS-247 Issue2, RSS-Gen Issue5.

3.1 EUT CONFIGURATION

The EUT configuration for testing is installed on RF field strength measurement to meet the Commissions requirement and operating in a manner that intends to maximize its emission characteristics in a continuous normal application.

3.2 EXERCISE EUT

The EUT was operated in the engineering mode to fix the TX frequency that was for the purpose of the measurements.

According to its specifications, the EUT must comply with the requirements of the Section 15.207, 15.209 and 15.247 under the FCC Rules Part 15 Subpart C.

3.3 GENERAL TEST PROCEDURES

Conducted Emissions

The EUT is placed on the turntable, which is 0.8 m above ground plane. According to the requirements in Section 13.1.4.1 of ANSI C63.10 Conducted emissions from the EUT measured in the frequency range between 0.15 MHz and 30MHz using CISPR Quasi-peak and average detector modes.

Radiated Emissions

Under 1GHz

The EUT is placed on a turn table, which is 0.8 m above ground plane. The turntable shall rotate 360 degrees to determine the position of maximum emission level. EUT is set 3m away from the receiving antenna, which varied from 1m to 4m to find out the highest emission. And also, each emission was to be maximized by changing the polarization of receiving antenna both horizontal and vertical. In order to find out the maximum emissions, exploratory radiated emission measurements were made according to the requirements in Section 13.1.4.1 of ANSI C63.10.

Above 1GHz

The EUT is placed on a turn table, which is 1.5 m above ground plane. The turntable shall rotate 360 degrees to determine the position of maximum emission level. EUT is set 3m away from the receiving antenna, which varied from 1m to 4m to find out the highest emission. And also, each emission was to be maximized by changing the polarization of receiving antenna both horizontal and vertical. In order to find out the maximum emissions, exploratory radiated emission measurements were made according to the requirements in Section 13.1.4.1 of ANSI C63.10.

3.4 TEST MODE

Preliminary tests were performed in different data rate to find the worst radiated emission. The data rate shown in the table below is the worst-case rate with respect to the specific test item. Investigation has been done on all the possible configurations for searching the worst cases. The following table is a list of the test modes shown in this test report.

Test Items	Mode	Data Rate	Channel	Antenna
6dB Bandwidth	GFSK	1 Mbps	0/19/39	1
Peak Output Power	GFSK	1 Mbps	0/19/39	1
Power Spectral Density	GFSK	1 Mbps	0/19/39	1
Conducted Band Edges and Spurious Emission	GFSK	1 Mbps	0/19/39	1
Radiated Band Edges and Spurious Emission	GFSK	1 Mbps	0/19/39	1
AC Conducted Emission	CTX	-	-	-

Remark:

1. For radiated test cases below 1 GHz, the worst mode data rate channel 39 was reported only, because this data rate has the highest RF output power at preliminary tests.
2. EUT with support equipment N3M240 was the worst mode, which mode data was recorded.

3.5 RESTRICTED BANDS OF OPERATIONS

FCC PART 15.205 RESTRICTED BANDS OF OPERATIONS:

- (a) Except as shown in paragraph (d) of this section, only spurious emissions are permitted in any of the frequency bands listed below:

MHz	MHz	MHz	GHz
0.0900 - 0.1100	16.420 - 16.423	399.9 - 410.0	4.50 - 5.15
0.4950 - 0.505 ⁽¹⁾	16.69475 - 16.69525	608 - 614	5.35 - 5.46
2.1735 - 2.1905	16.80425 - 16.80475	960.0 - 1240	7.25 - 7.75
4.1250 - 4.1280	25.50 - 25.67	1300 - 1427	8.025 - 8.500
4.17725 - 4.17775	37.50 - 38.25	1435.0 - 1626.5	9.0 - 9.2
4.20725 - 4.20775	73.0 - 74.6	1645.5 - 1646.5	9.3 - 9.5
6.2150 - 6.2180	74.8 - 75.2	1660 - 1710	10.6 - 12.7
6.26775 - 6.26825	108.00 - 121.94	1718.8 - 1722.2	13.25 - 13.40
6.31175 - 6.31225	123 - 138	2200 - 2300	14.47 - 14.50
8.2910 - 8.2940	149.90 - 150.05	2310 - 2390	15.35 - 16.20
8.3620 - 8.3660	156.52475 - 156.52525	2483.5 - 2500.0	17.7 - 21.4
8.37625 - 8.38675	156.7 - 156.9	2655 - 2900	22.01 - 23.12
8.41425 - 8.41475	162.0125 - 167.1700	3260 - 3267	23.6 - 24.0
12.2900 - 12.2930	167.72 - 173.20	3332 - 3339	31.2 - 31.8
12.51975 - 12.52025	240 - 285	3345 - 3358	36.43 - 36.5 ⁽²⁾
12.57675 - 12.57725	322.0 - 335.4	3600 - 4400	
13.3600 - 13.4100			

¹ Until February 1, 1999, this restricted band shall be 0.490-0.510 MHz.

² Above 38.6

- (b) Except as provided in paragraphs (d) and (e), the field strength of emissions appearing within these frequency bands shall not exceed the limits shown in Section 15.209. At frequencies equal to or less than 1000 MHz, compliance with the limits in Section 15.209 shall be demonstrated using measurement instrumentation employing a CISPR quasi-peak detector. Above 1000 MHz, compliance with the emission limits in Section 15.209 shall be demonstrated based on the average value of the measured emissions. The provisions in Section 15.35 apply to these measurements.

RSS-Gen RESTRICTED BANDS OF OPERATIONS

Except as shown RSS-Gen 8.10, only spurious emissions are permitted in any of the frequency bands listed below:

MHz	MHz	GHz
0.090 - 0.110	156.7 - 156.9	9.0 - 9.2
0.495 - 0.505	162.0125 - 167.17	9.3 - 9.5
2.1735 - 2.1905	167.72 - 173.2	10.6 - 12.7
3.020 - 3.026	240 - 285	13.25 - 13.4
4.125 - 4.128	322 - 335.4	14.47 - 14.5
4.17725 - 4.17775	399.9 - 410	15.35 - 16.2
4.20725 - 4.20775	608 - 614	17.7 - 21.4
5.677 - 5.683	960 - 1427	22.01 - 23.12
6.215 - 6.218	1435 - 1626.5	23.6 - 24.0
6.26775 - 6.26825	1645.5 - 1646.5	31.2 - 31.8
6.31175 - 6.31225	1660 - 1710	36.43 - 36.5
8.291 - 8.294	1718.8 - 1722.2	Above 38.6
8.362 - 8.366	2200 - 2300	
8.37625 - 8.38675	2310 - 2390	
8.41425 - 8.41475	2483.5 - 2500	
12.29 - 12.293	2655 - 2900	
12.51975 - 12.52025	3260 - 3267	
12.57675 - 12.57725	3332 - 3339	
13.36 - 13.41	3345.8 - 3358	
16.42 - 16.423	3500 - 4400	
16.69475 - 16.69525	4500 - 5150	
16.80425 - 16.80475	5350 - 5460	
25.5 - 25.67	7250 - 7750	
37.5 - 38.25	8025 - 8500	
73 - 74.6	4500 - 5150	
74.8 - 75.2	5350 - 5460	
108 - 138	7250 - 7750	
149.9 - 150.05	8025 - 8500	
156.52475 - 156.52525		

* Certain frequency bands listed in table 7 and in bands above 38.6 GHz are designated for licence-exempt applications. These frequency bands and the requirements that apply to related devices are set out in the 200 and 300 series of RSSs.

3.6 ANTENNA DESCRIPTION

According to FCC 47 CFR 15.203

“an intentional radiator antenna shall be designed to ensure that no antenna other than that furnished by the responsible party can be used with the device. The use of a permanently attached or an antenna that uses a unique coupling to the intentional radiator shall be considered sufficient to comply with the provisions of this section”

As the photo below, the EUT use a unique coupling to the intentional radiator attached antenna, so the EUT complies with the requirement of 15.203.

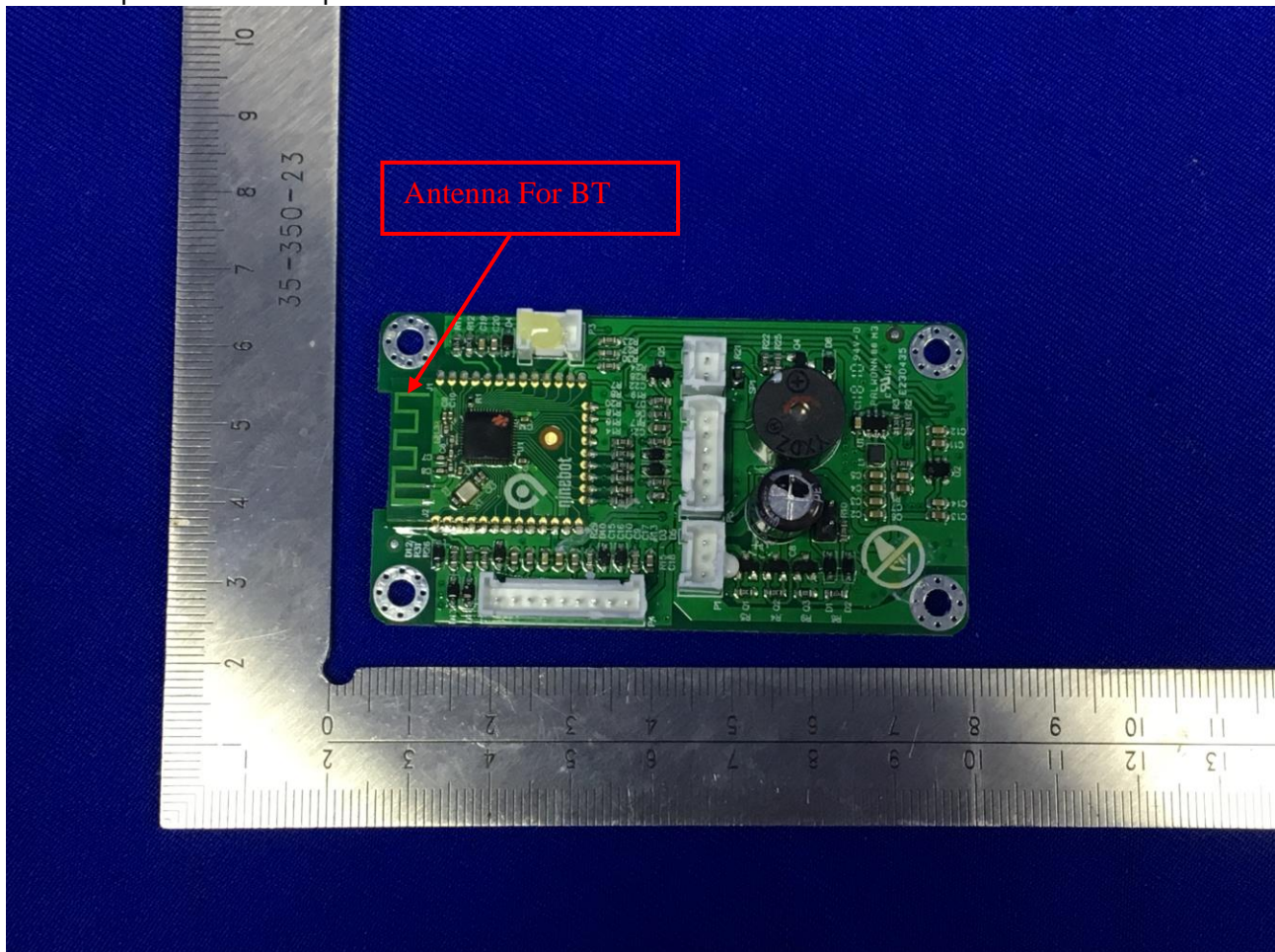

4 INSTRUMENT CALIBRATION

The measuring equipment, which was utilized in performing the tests documented herein, has been calibrated in accordance with the manufacturer's recommendations for utilizing calibration equipment, which is traceable to recognized national standards. facilities and accreditations

5 FACILITIES AND ACCREDITATIONS

5.1 FACILTIES

All measurement facilities used to collect the measurement data are located at CCS China Kunshan Lab at 10#Weiye Rd, Innovation Park Eco. & Tec. Development Zone Kunshan city JiangSu, (215300), CHINA.

The sites are constructed in conformance with the requirements of ANSI C63.4 and CISPR Publication 22.

5.2 EQUIPMENT

Radiated emissions are measured with one or more of the following types of linearly polarized antennas: tuned dipole, biconical, log periodic, bi-log, and/or ridged waveguide, horn. Spectrum analyzers with pre-selectors and quasi-peak detectors are used to perform radiated measurements.

Conducted emissions are measured with Line Impedance Stabilization Networks and EMI Test Receivers.

Calibrated wideband preamplifiers, coaxial cables, and coaxial attenuators are also used for making measurements.

All receiving equipment conforms to CISPR Publication 16-1, "Radio Interference Measuring Apparatus and Measurement Methods."

5.3 LABORATORY ACCREDITATIONS AND LISTING

FCC –Designation Number: CN1172.

Compliance Certification Services Inc. Kun shan Laboratory has been registered and fully described in a report filed with the (FCC) Federal Communications Commission. The acceptance letter from the FCC is maintained in our files and the Designation Number: CN1172.

The test facilities are listed with Industry Canada, Laboratory Division, 2324E-1 for 10m chamber, 2324E-2 for 3m chamber.

5.4 TABLE OF ACCREDITATIONS

Our laboratories are accredited and approved by the following accreditation body according to ISO/IEC 17025.

Taiwan	TAF
USA	A2LA

The measuring facility of laboratories has been authorized or registered by the following approval agencies.

Canada	Industry Canada
Japan	VCCI
Taiwan	BSMI
USA	FCC

Copies of granted accreditation certificates are available for downloading from our web site, <http://www.ccsrf.com>

5.5 LIST OF MEASURING EQUIPMENT

Conducted Emissions Test Site					
Name of Equipment	Manufacturer	Model	Serial Number	Calibration Data	Calibration Due
Spectrum Analyzer	Agilent	E4446A	MY44020154	2017-9-4	2018-9-3
Spectrum Analyzer	RS	FSU26	200789	2017-7-20	2018-7-19
Power meter	Anritsu	ML2495A	1445010	2018-4-26	2019-4-25
Power sensor	Anritsu	MA2411B	1339220	2018-4-26	2019-4-25
Power SPLITTER	Mini-Circuits	ZN2PD-9G	SF078500430	N.C.R	N.C.R
DC Power Supply	AGILENT	E3632A	MY50340053	N.C.R	N.C.R
Cable	N/A	Cable-05	N/A	2018-4-24	2019-4-23
6dB Attenuator	N/A	N/A	N/A	2018-4-24	2019-4-23
Temp. / Humidity Gauge	Anymetre	TH603	CCS007	2017-10-24	2018-10-23
Test Software			EZ-EMC		

Conducted Emission					
Name of Equipment	Manufacturer	Model	Serial Number	Calibration Data	Calibration Due
EMI TEST RECEIVER	R&S	ESCI	100781	2018-2-26	2019-2-25
V (V-LISN)	SCHWARZBECK	NNLK 8129	8129-143	2017-10-29	2018-10-28
TWO-LINE V-NETWORK	R&S	ENV216	101604	2017-10-29	2018-10-28
Pulse LIMITER	R&S	ESH3-Z2	100524	2017-12-27	2018-12-26
Cable	Thermax	Cable-02	14	2017-12-27	2018-12-26
Test Software			EZ-EMC		

977 Chamber					
Name of Equipment	Manufacturer	Model	Serial Number	Calibration Data	Calibration Due
Spectrum Analyzer	Agilent	E4446A	MY44020154	2017-9-4	2018-9-3
Spectrum Analyzer	RS	FSU26	200789	2017-7-20	2018-7-19
EMI Test Receiver	R&S	ESCI	101378	2017-12-27	2018-12-26
Amplifier	COM-POWER	PAM-840A	461332	2017-8-30	2018-8-29
Amplifier	MITEQ	JS41-00101800-32-10P	1675713	2017-7-20	2018-7-19
Broad-Band Horn Antenna	SCHWARZBECK	BBHA 9170	9170-515	2018-2-27	2019-2-26
Bilog Antenna	SCHAFFNER	CBL6143	5078	2017-11-5	2018-11-4
Loop Antenna	Hengweiyi	39501C	2014012	2018-1-3	2019-1-2
Horn-antenna	SCHWARZBECK	9120D	D:266	2018-2-26	2019-2-25
Horn-antenna	SCHWARZBECK	9120D	D:267	2017-11-5	2018-11-4
Turn Table	CT	CT123	4165	N.C.R	N.C.R
Antenna Tower	CT	CTERG23	3256	N.C.R	N.C.R
Controller	CT	CT100	95637	N.C.R	N.C.R
Cable	REBES MICROWAVE	Cable-93	N/A	2017-10-29	2018-10-28
Cable	REBES MICROWAVE	Cable-94	N/A	2017-10-29	2018-10-28
Cable	REBES MICROWAVE	Cable-95	N/A	2017-10-29	2018-10-28
Cable	N/A	Cable-03	N/A	2018-4-24	2019-4-23
Cable	N/A	Cable-04	N/A	2018-4-24	2019-4-23
2.4G Filter	N/A	N/A	N/A	2018-4-24	2019-4-23
Test Software			EZ-EMC		

Remark: Each piece of equipment is scheduled for calibration once a year.

5.6 MEASUREMENT UNCERTAINTY

For the test methods, according to the present document, the measurement uncertainty figures shall be calculated in accordance with TR 100 028-1 [2] and shall correspond to an expansion factor (coverage factor) $k = 1,96$ or $k = 2$ (which provide confidence levels of respectively 95 % and 95,45 % in the case where the distributions characterizing the actual measurement uncertainties are normal (Gaussian)). Table 6 is based on such expansion factors.

Table 6: Maximum measurement uncertainty

Parameter	Uncertainty
RF output power, conducted	$\pm 1.129\text{dB}$
Unwanted Emissions, conducted	$\pm 2.406\text{dB}$
RF Power density, conducted	$\pm 2.379\text{dB}$
Conducted emissions	$\pm 2.582\text{dB}$
All emissions, radiated (Below 1GHz)	$\pm 4.725\text{dB}$
All emissions, radiated (Above 1GHz)	$\pm 4.818\text{dB}$
Temperature	$\pm 0.3\text{dB}$
Supply voltages	$\pm 0.2\%$

5.7 SETUP CONFIGURATION

See test photographs attached in Appendix 1 for the actual connections between EUT and support equipment.

5.8 SUPPORT EQUIPMENT

No.	Equipment	Brand	Model	Series No.	FCC ID
1.	Ninebot S-PRO	ninebot	N3M240	N/A	2AF2B-NB
2.	Ninebot S-PRO	ninebot	N3M260	N/A	2AF2B-NB
3.	Ninebot S-PRO	ninebot	N3M320	N/A	2AF2B-NB

Remark:

- 1.All the equipment/cables were placed in the worst-case configuration to maximize the emission during the test.
- 2.Grounding was established in accordance with the manufacturer's requirements and conditions for the intended use.

6 FCC PART 15.247 & RSS-247 REQUIREMENTS

6.1 Maximum conducted output power

Limit

1). According to FCC part 15.247, the maximum peak output power of the intentional radiator shall not exceed the following:

For systems using digital modulation in the 2400-2483.5MHz, the limit for peak output power is 30dBm. If transmitting antenna of directional gain greater than 6dBi is used, the peak output power from the intentional radiator shall be reduced below the above stated value by the amount in dB that the directional gain of the antenna exceeds 6 dBi. In case of point-to-point operation, the limit has to be reduced by 1dB for every 3dB that the directional gain of the antenna exceeds 6dBi.

2). According to RSS-247 section 5.4, For DTSs employing digital modulation techniques operating in the bands 902-928 MHz and 2400-2483.5 MHz, the maximum peak conducted output power shall not exceed 1W. The e.i.r.p. shall not exceed 4 W, except as provided in section 5.4(e)

Test Configuration

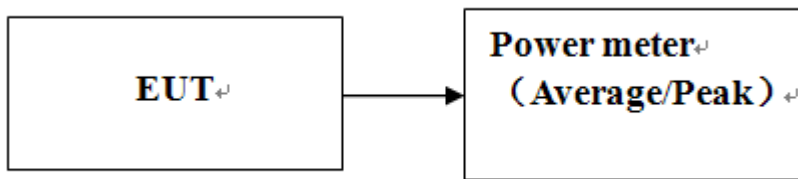

Remark: Each piece of equipment is scheduled for calibration once a year.

Test Procedure

1. The testing follows the Measurement Procedure of FCC KDB No. 558074 DTS D01 Meas. Guidance v04.
2. The RF output of EUT was connected to the power meter by RF cable and attenuator. The path loss was compensated to the results for each measurement.
3. Set to the maximum power setting and enable the EUT transmit continuously.
4. Measure the conducted output power and record the results in the test report.

Test RESULTS

No non-compliance noted

BLE4.1 GFSK Modulation 1Mbps mode

Test mode:	Bluetooth LE4.1	Temperature:	23°C
Test By:	Lily.Wang	Test Date:	2018-5-2

Channel	Frequency (MHz)	Peak Output Power (dBm)	Limit (dBm)	e.i.r.p. (dBm)	Limit (dBm)
Low	2402	0.38	30.00	5.38	36.02
Mid	2440	-1.27	30.00	3.73	36.02
High	2480	-3.20	30.00	1.80	36.02

Channel	Frequency (MHz)	Average Output Power (dBm)	e.i.r.p. (dBm)
Low	2402	-0.17	4.83
Mid	2440	-1.85	3.15
High	2480	-3.80	1.20

Note:Duty factor has been offsetted with cableloss

6.2 PEAK POWER SPECTRAL DENSITY

Limit

- 1). According to FCC part 15.247, the peak power spectral density shall not be greater than 8dBm in any 3kHz band at any time interval of continuous transmission.
- 2). According to RSS-247 section 5.2, The transmitter power spectral density conducted from the transmitter to the antenna shall not be greater than 8dBm in any 3kHz band during any time interval of continuous transmission.

Test Configuration

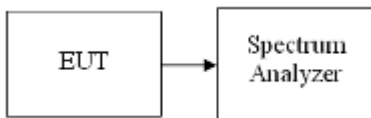

Test Procedure

1. Place the EUT on the table and set it in transmitting mode. Remove the antenna from the EUT and then connect a low loss RF cable from the antenna port to the spectrum analyzer.
2. Set the spectrum analyzer as RBW = 3 kHz, VBW = 10 kHz, Span = 1.5 times the DTS bandwidth, Sweep = auto
3. Record the max reading.
4. Repeat the above procedure until the measurements for all frequencies are completed.

Test Results of power Spectral Density

Test mode:	Bluetooth LE4.1	Temperature:	23°C
Test By:	Lily.Wang	Test Date:	2018-5-2

Channel	Frequency (MHz)	PSD/3kHz (dBm)	Limit (dBm)	Result
00	2402	-13.06	8	PASS
19	2440	-14.99		PASS
39	2480	-15.84		PASS

Test Plot of power Spectral Density

Channel 00

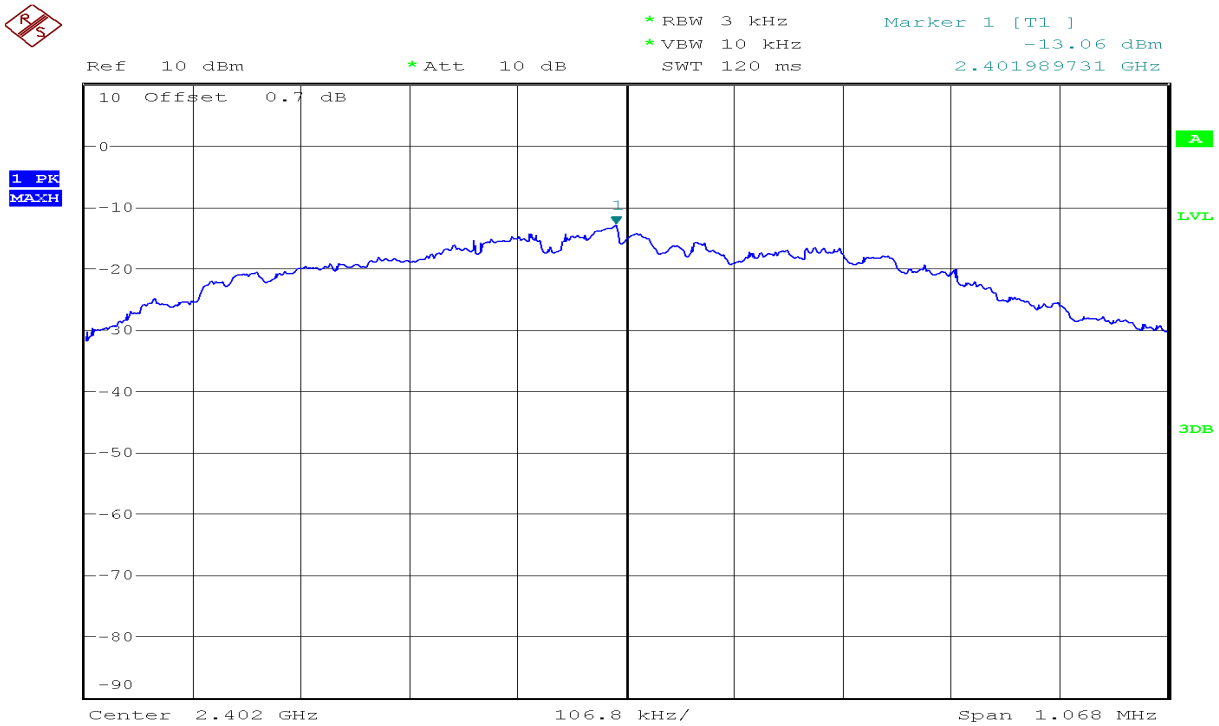

Channel 19



*RBW 3 kHz Marker 1 [T1]
*VBW 10 kHz -14.99 dBm
SWT 120 ms 2.439989731 GHz

Ref 10 dBm *Att 10 dB

1 PK
MAXH

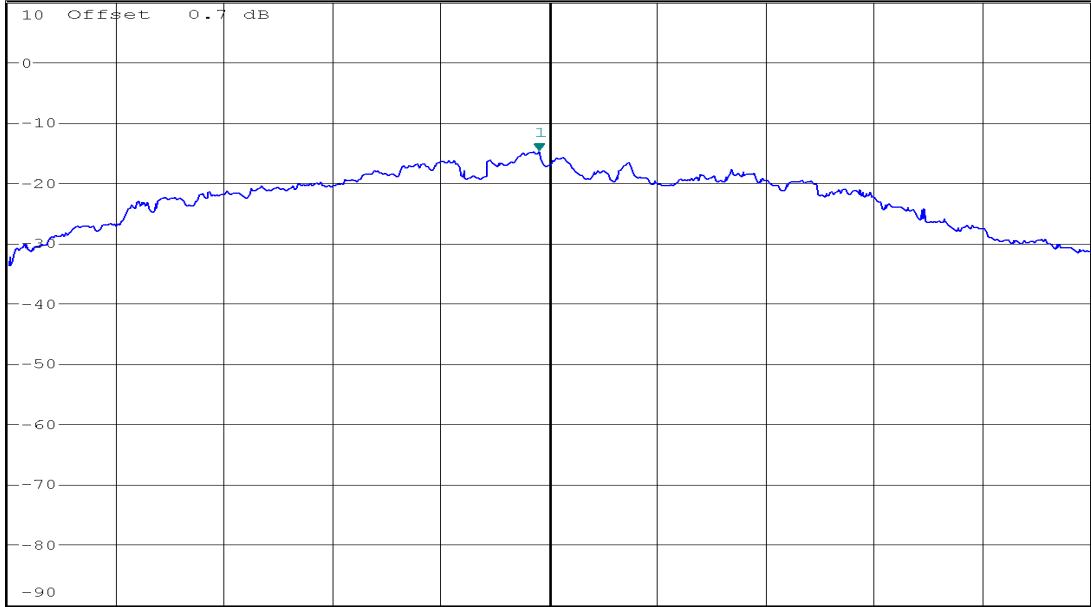

Channel 39



*RBW 3 kHz Marker 1 [T1]
*VBW 10 kHz -15.84 dBm
SWT 120 ms 2.479996577 GHz

Ref 10 dBm *Att 10 dB

1 PK
MAXH

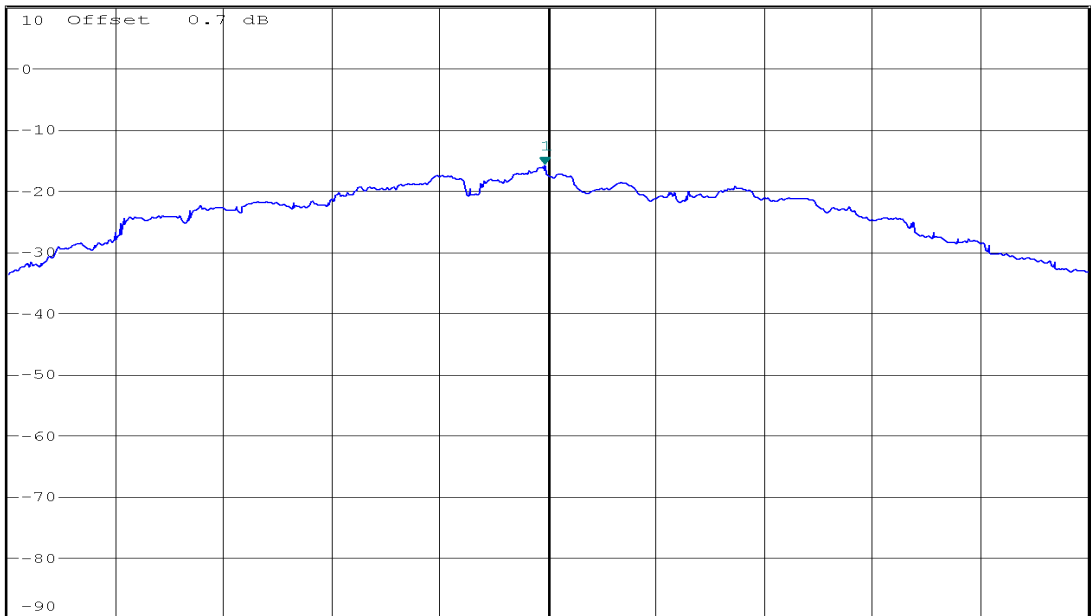

6.3 6dB Bandwidth Measurement

Limit

- 1).According to FCC part 15.247,The minimum 6 dB bandwidth shall be at least 500 kHz.
- 2).According to RSS-247 section 5.2, DTSs include systems that employ digital modulation techniques resulting in spectral characteristics similar to direct sequence systems. The following applies to the bands 902-928 MHz and 2400-2483.5 MHz: The minimum 6 dB bandwidth shall be 500 kHz

Test Configuration

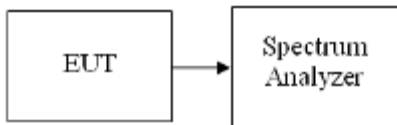

Test Procedure

1. The RF output of EUT was connected to the spectrum analyzer by RF cable and attenuator. The path loss was compensated to the results for each measurement.
2. Set to the maximum power setting and enable the EUT transmit continuously.
3. Make the measurement with the spectrum analyzer's resolution bandwidth (RBW) = 100 kHz. Set the Video bandwidth (VBW) = 300 kHz. In order to make an accurate measurement. The 6 dB bandwidth must be greater than 500 kHz.
4. Measure and record the results in the test report.

Test Results of Bandwidth

No non-compliance noted

Test mode:	Bluetooth LE4.1	Temperature:	23°C
Test By:	Lily.Wang	Test Date:	2018-5-2

Channel	Frequency (MHz)	6dB Bandwidth (MHz)	6dB Bandwidth Limit (MHz)	Result
00	2402	0.702	0.5	Pass
19	2440	0.712	0.5	Pass
39	2480	0.712	0.5	Pass

Test Plot

Channel 00

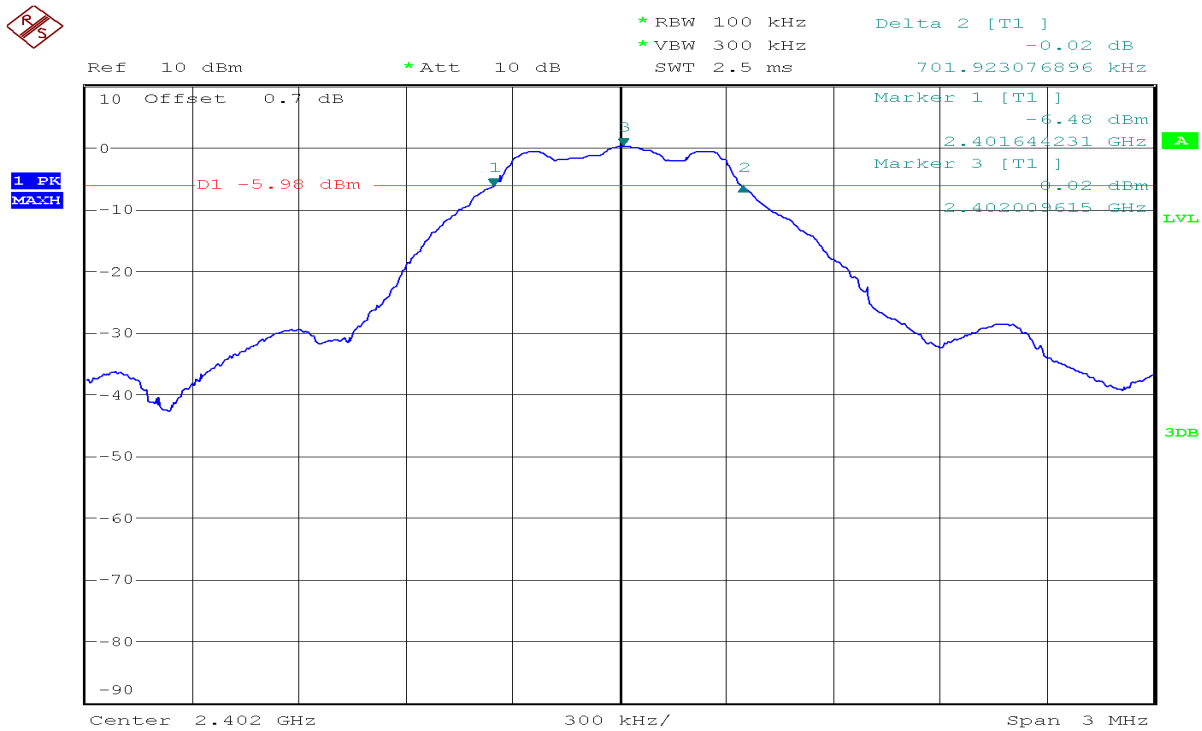

Channel 19

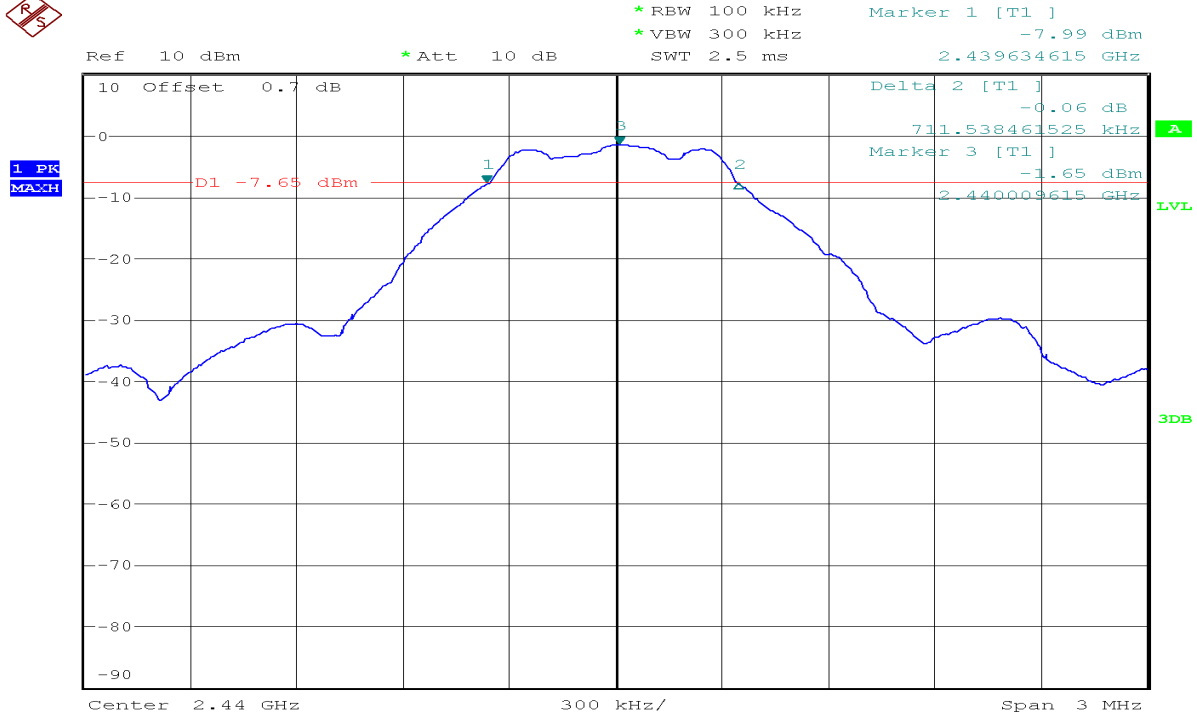

Channel 39

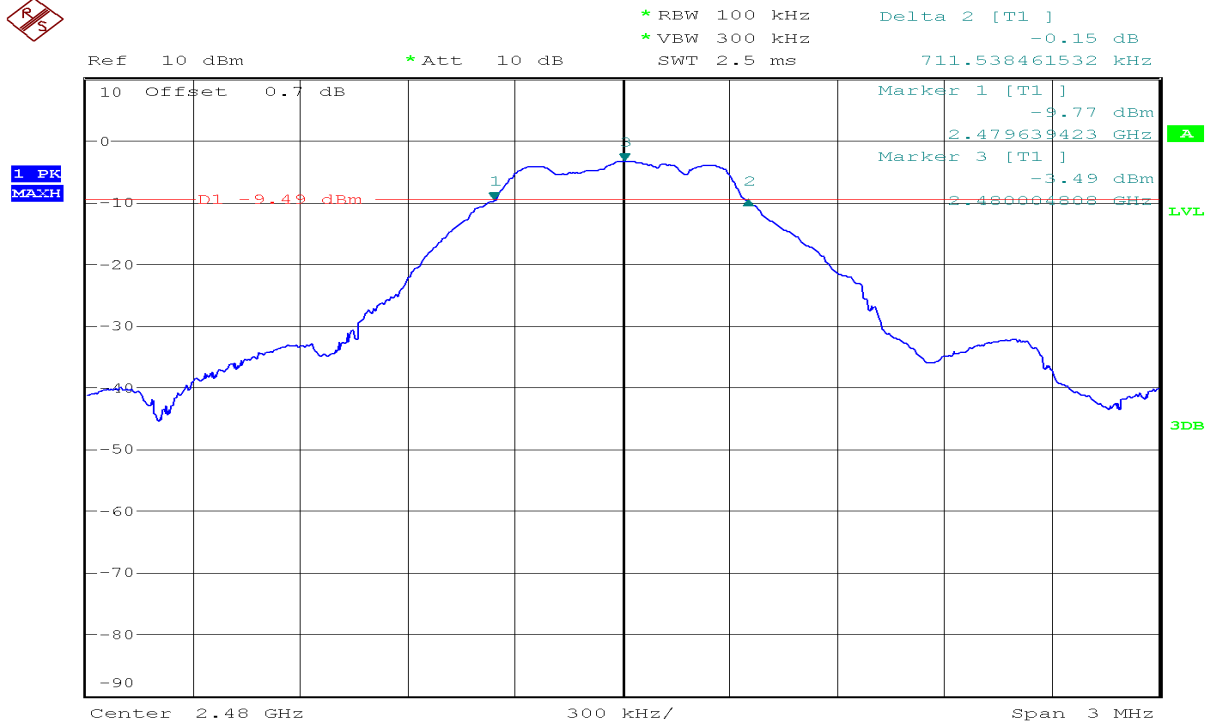

6.4 99% Bandwidth Measurement

LIMIT

None; for reporting purposes only
RSS-Gen 6.6

Test Configuration

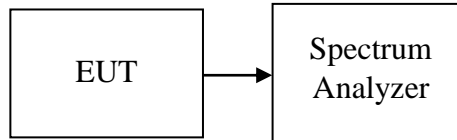

TEST PROCEDURE

The transmitter output is connected to the spectrum analyzer. The RBW shall be in the range of 1% to 5% of the occupied bandwidth and VBW shall be approximately 3x RBW. The sweep time is coupled. The spectrum analyzer internal 99% bandwidth function is utilized.

TEST RESULTS

No non-compliance noted

Test Data

Test mode:	Bluetooth LE4.1	Temperature:	23°C
Test By:	Lily.Wang	Test Date:	2018-5-2

Channel	Frequency (MHz)	99% Bandwidth (MHz)
00	2402	1.024
19	2440	1.024
39	2480	1.029

Test Plot

Channel 00

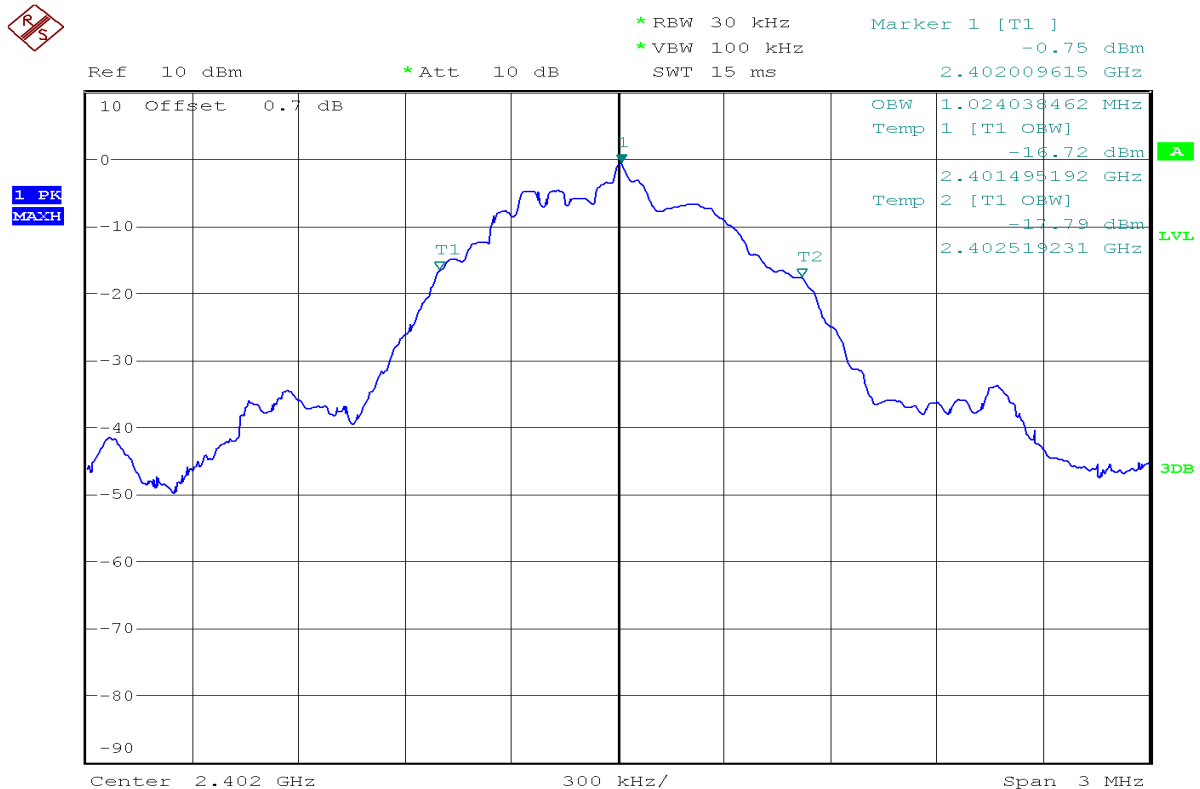

Channel 19



Ref 10 dBm *Att 10 dB *RBW 30 kHz Marker 1 [T1]
 *VBW 100 kHz -2.42 dBm
 SWT 15 ms 2.440009615 GHz

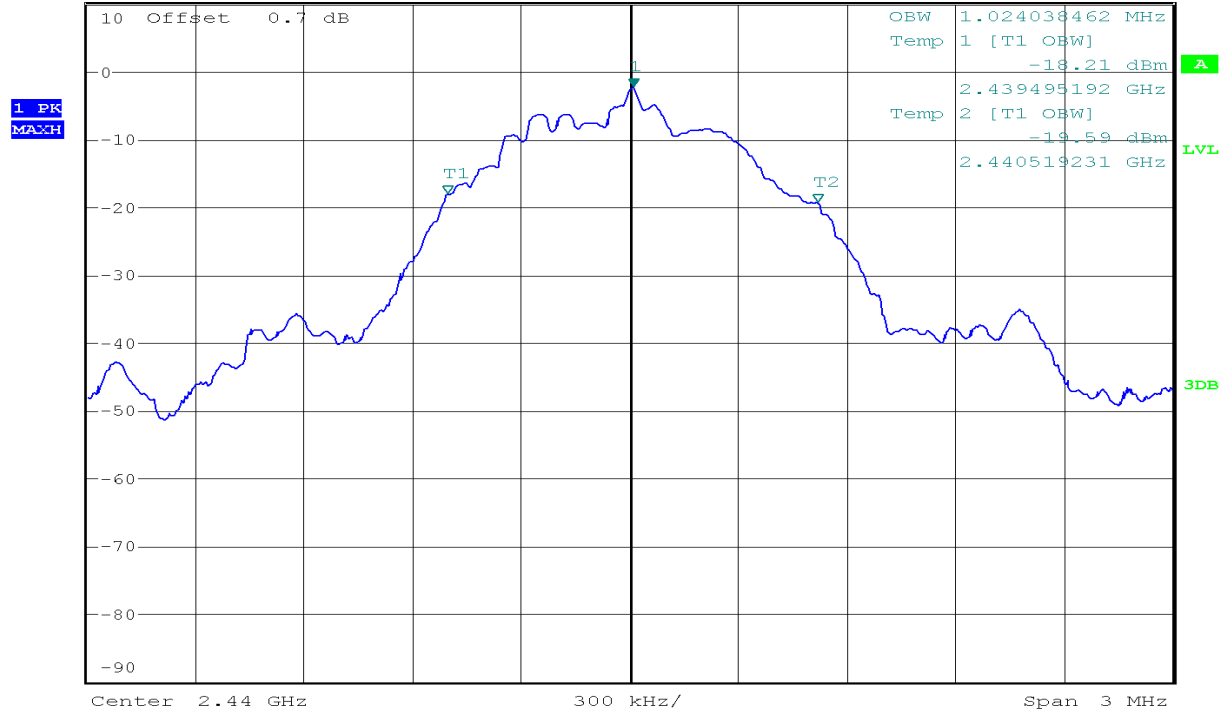

Channel 39



Ref 10 dBm *Att 10 dB *RBW 30 kHz Marker 1 [T1]
 *VBW 100 kHz -4.21 dBm
 SWT 15 ms 2.480009615 GHz

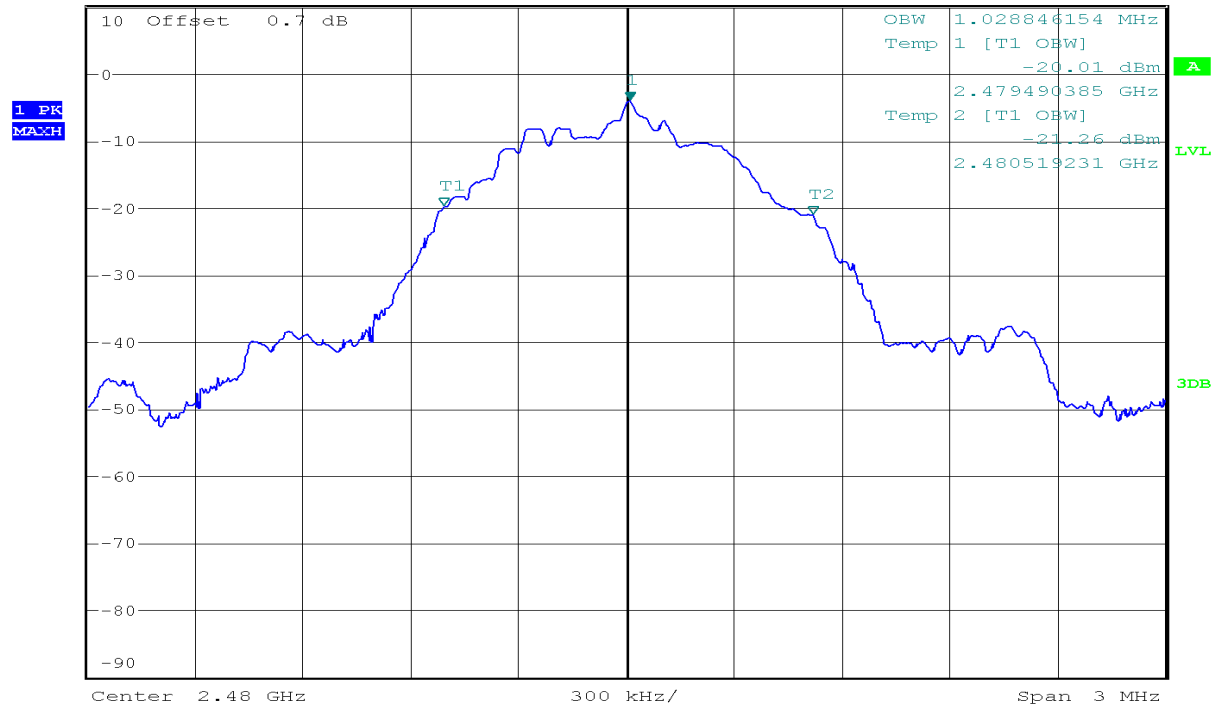

6.5 Conducted Band Edges and Spurious Emission Measurement

LIMIT

1). According to §15.247(d), in any 100kHz bandwidth outside the frequency bands in which the spread spectrum intentional radiator is operating, the radio frequency power that is produced by the intentional radiator shall be at least 20 dB below that in the 100kHz bandwidth within the band that contains the highest level of the desired power, based on either an RF conducted or a radiated measurement, provided the transmitter demonstrates compliance with the peak conducted power limits. In addition, radiated emissions which fall in the restricted bands, as defined in §15.205(a), must also comply with the radiated emission limits specified in 15.209(a) (see Section 15.205(c)).

2). According to RSS-247 section 5.5, In any 100kHz bandwidth outside the frequency band in which the spread spectrum or digitally modulated device is operating, the RF power that is produced shall be at least 20 dB below that in the 100kHz bandwidth within the band that contains the highest level of the desired power, based on either an RF conducted or a radiated measurement, provided that the transmitter demonstrates compliance with the peak conducted power limits. If the transmitter complies with the conducted power limits based on the use of root-mean-square averaging over a time interval, as permitted under section 5.4(d), the attenuation required shall be 30 dB instead of 20dB. Attenuation below the general field strength limits specified in RSS-Gen is not required.

Test Configuration

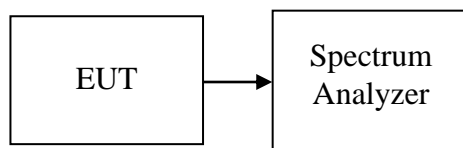

TEST PROCEDURE

Conducted RF measurements of the transmitter output were made to confirm that the EUT antenna port conducted emissions meet the specified limit and to identify any spurious signals that require further investigation or measurements on the radiated emissions site.

The transmitter output is connected to the spectrum analyzer. The resolution bandwidth is set to 100 kHz. The video bandwidth is set to 300 kHz.

Measurements are made over the 30MHz to 40GHz range with the transmitter set to the lowest, middle, and highest channels.

TEST RESULTSD

No non-compliance noted

Test Plot

OUT-OF-BAND SPURIOUS EMISSIONS-CONDUCTED MEASUREMENT

CH Low



Ref 10 dBm *Att 10 dB *RBW 100 kHz Marker 1 [T1]
 *VBW 300 kHz -0.11 dBm
 SWT 2.5 ms 2.402000000 GHz

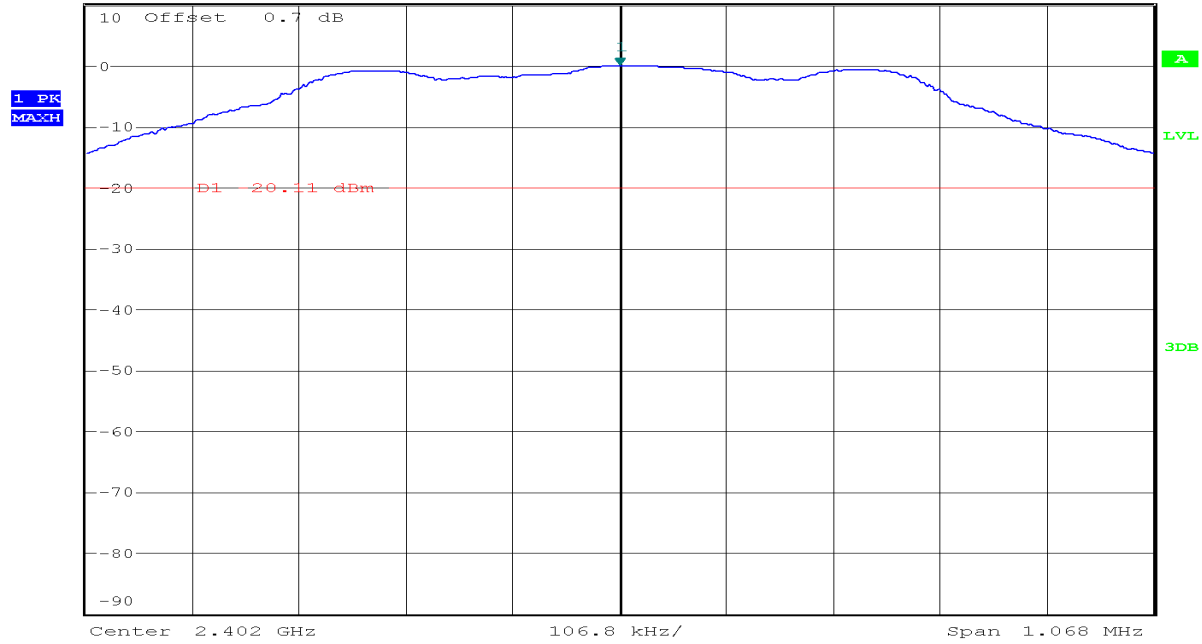

Ref 10 dBm *Att 10 dB *RBW 100 kHz Marker 2 [T1]
 *VBW 300 kHz -40.60 dBm
 SWT 45 ms 2.387128000 GHz

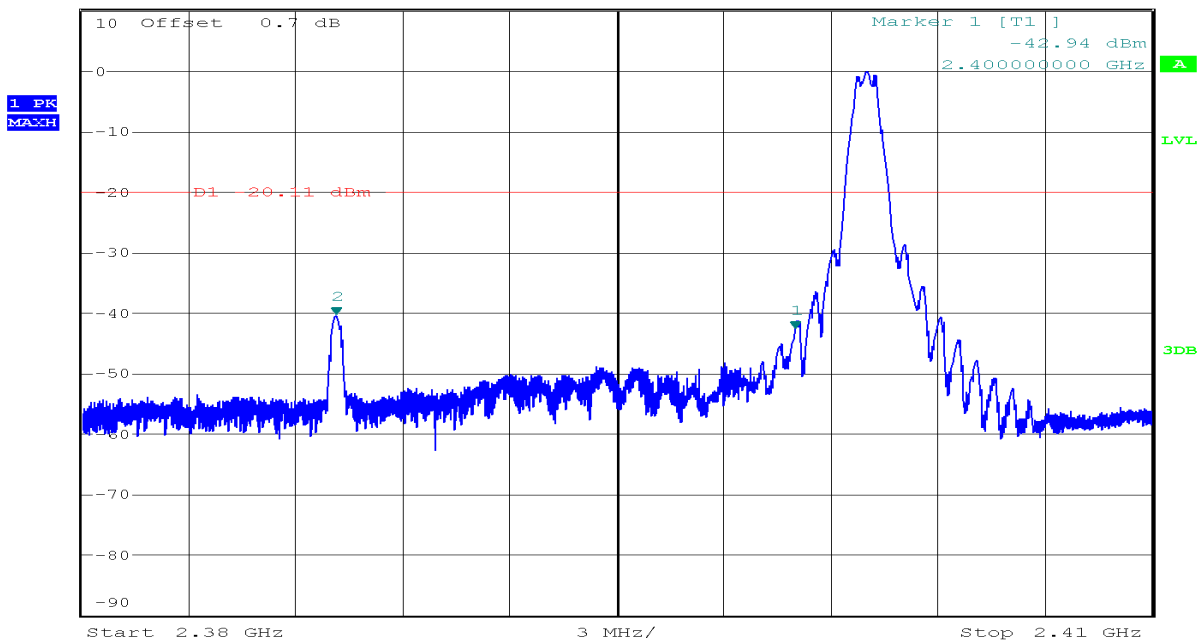

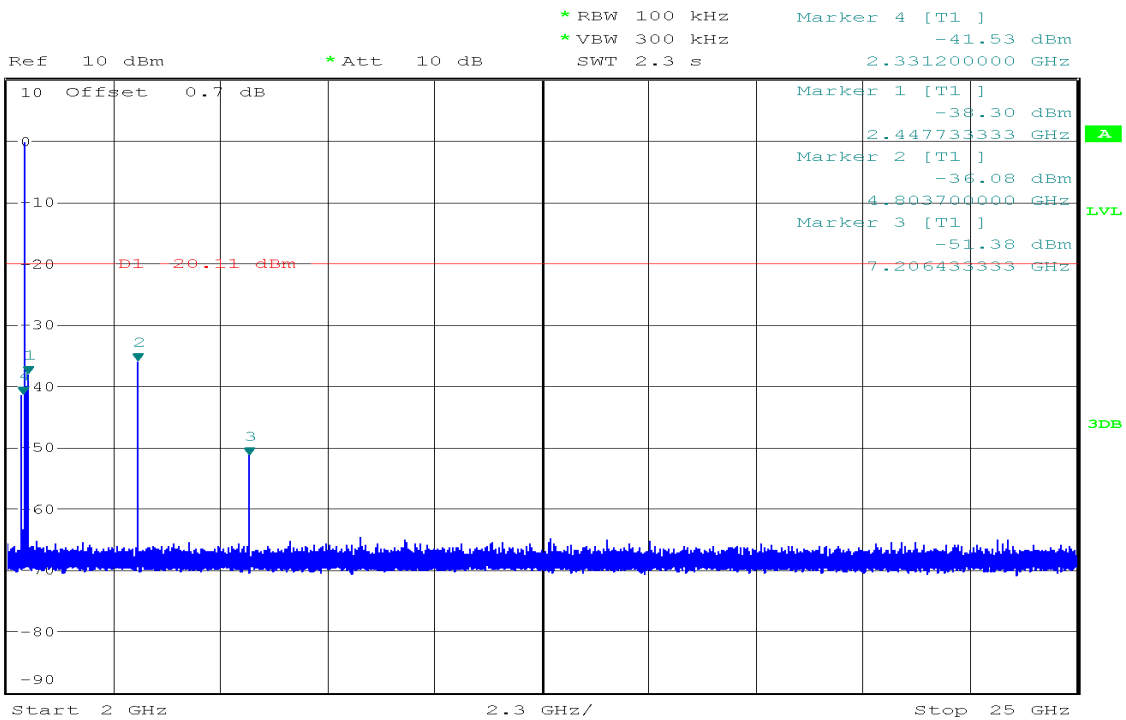
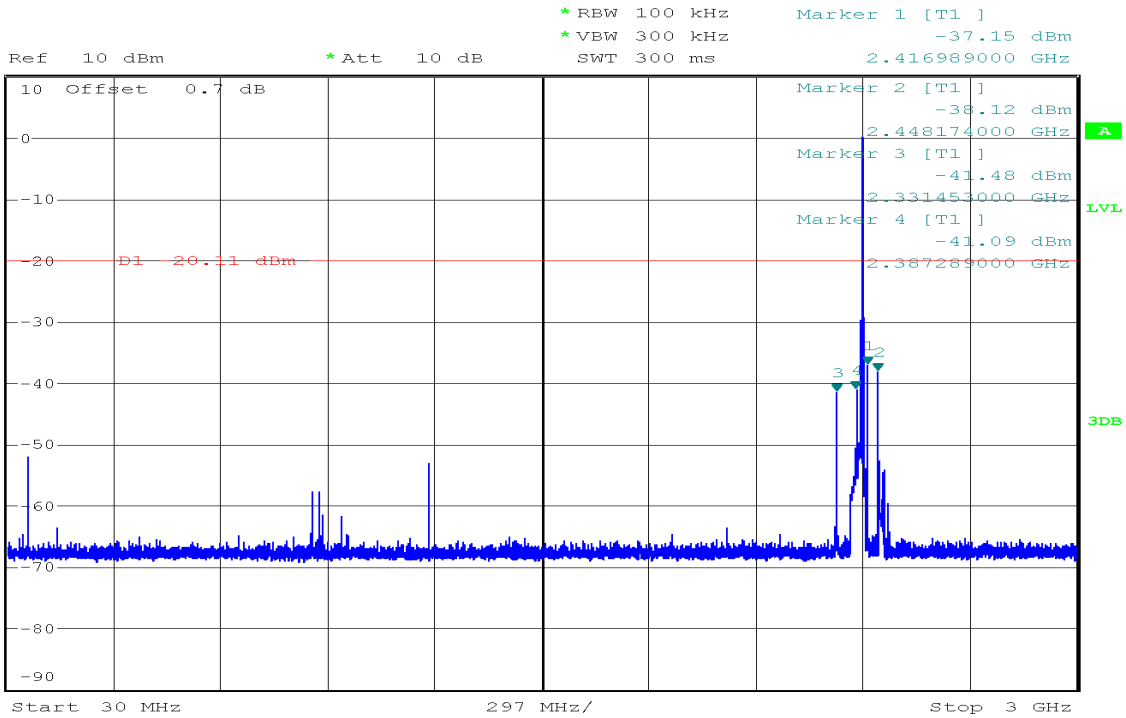

CH Mid

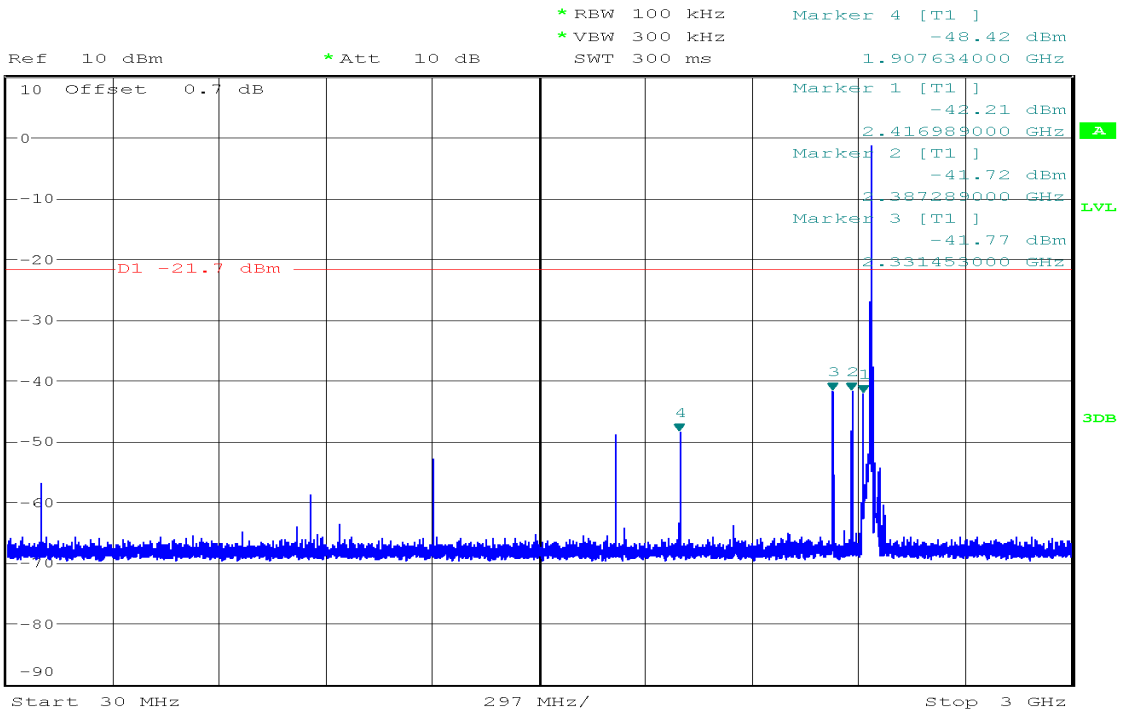
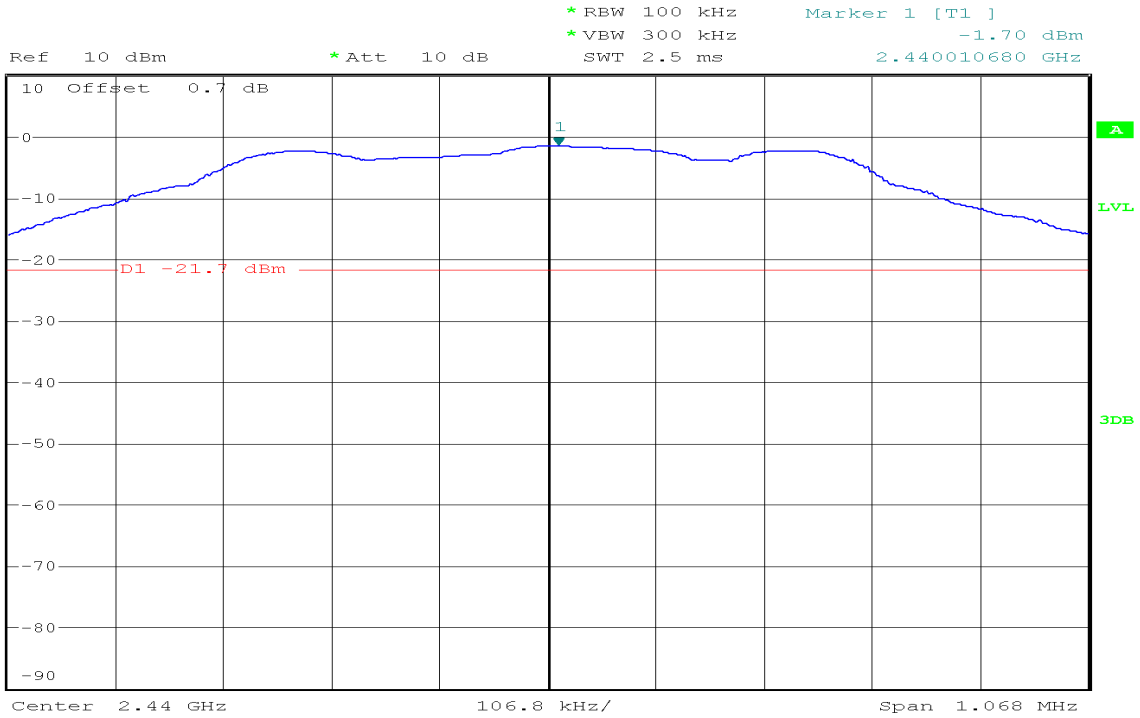

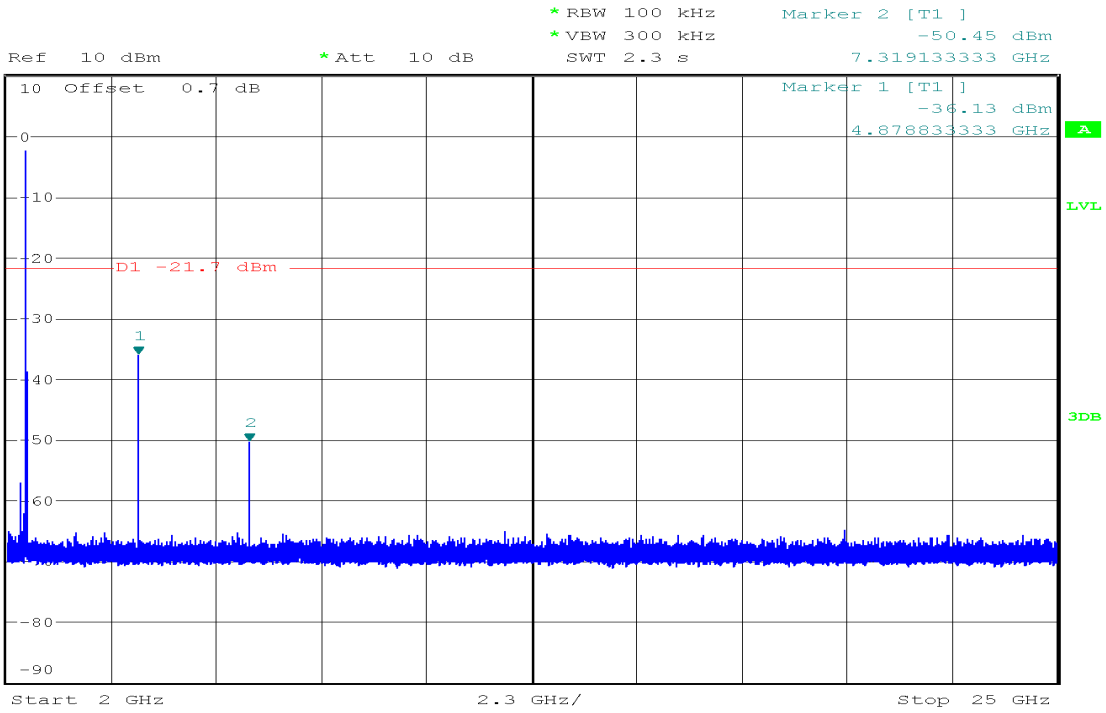

CH High

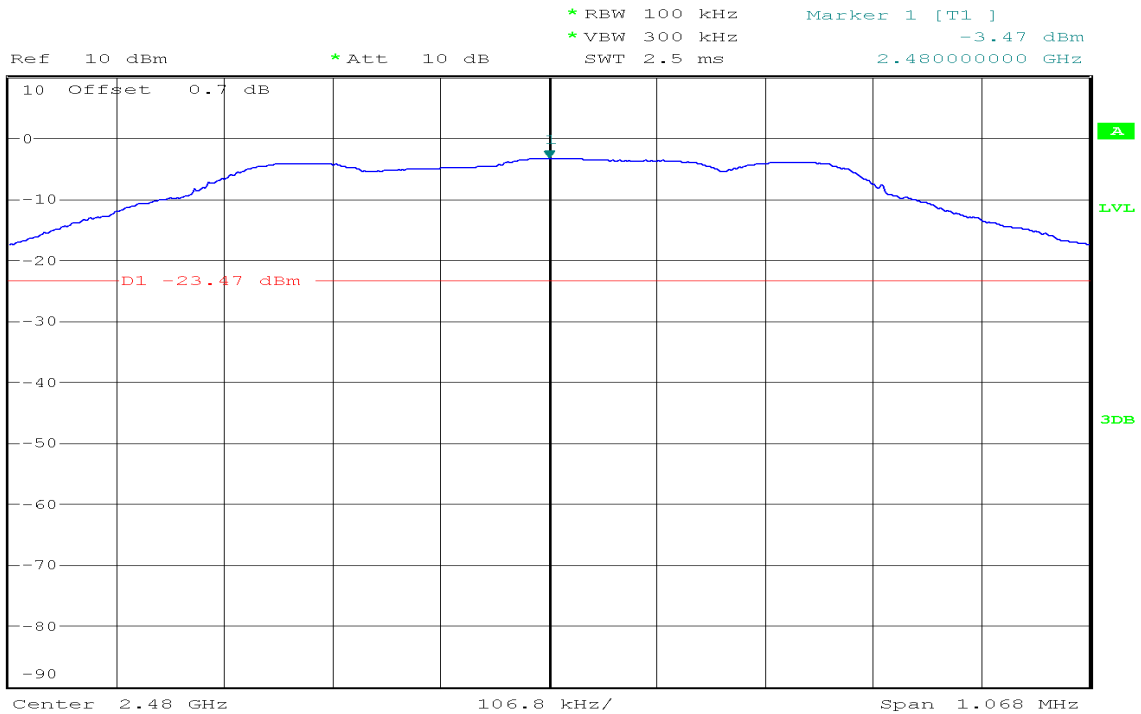



Ref 10 dBm * Att 10 dB * RBW 100 kHz Marker 2 [T1] -54.05 dBm
 * VBW 300 kHz 2.483592000 GHz
 SWT 45 ms

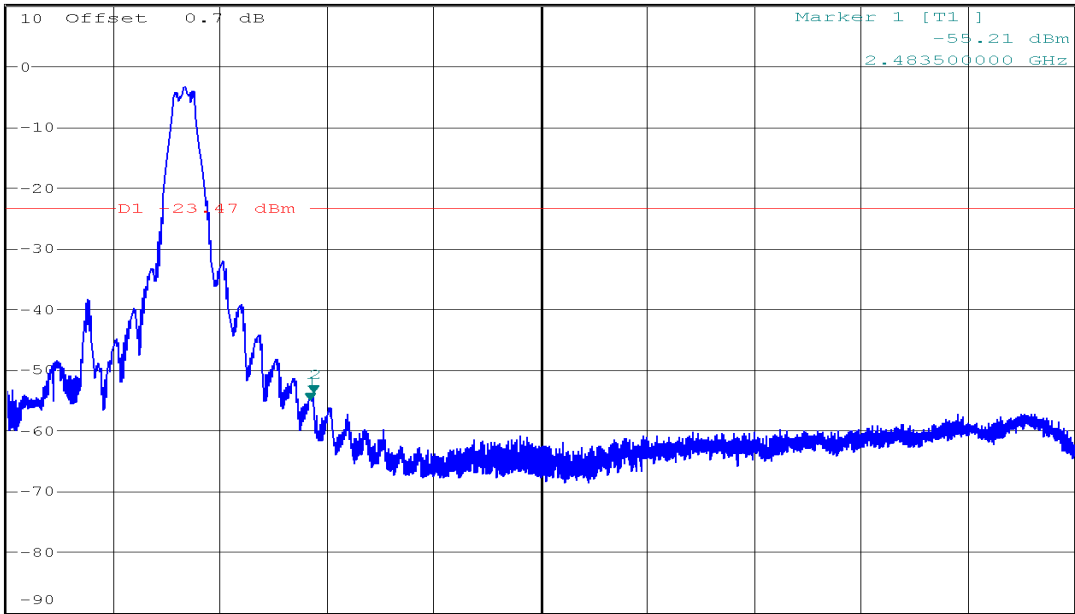

Ref 10 dBm * Att 10 dB * RBW 100 kHz Marker 1 [T1] -38.12 dBm
 * VBW 300 kHz 2.448174000 GHz
 SWT 300 ms

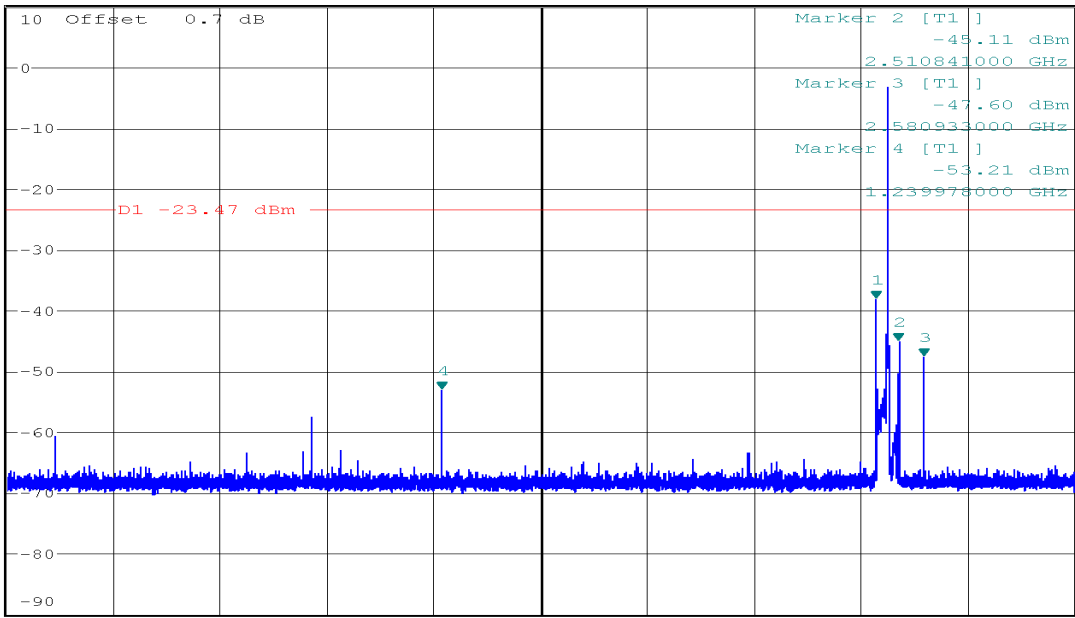



Ref 10 dBm * Att 10 dB * RBW 100 kHz Marker 3 [T1] -50.73 dBm
 * VBW 300 kHz SWT 2.3 s 7.440266667 GHz

1 PK
MATCH

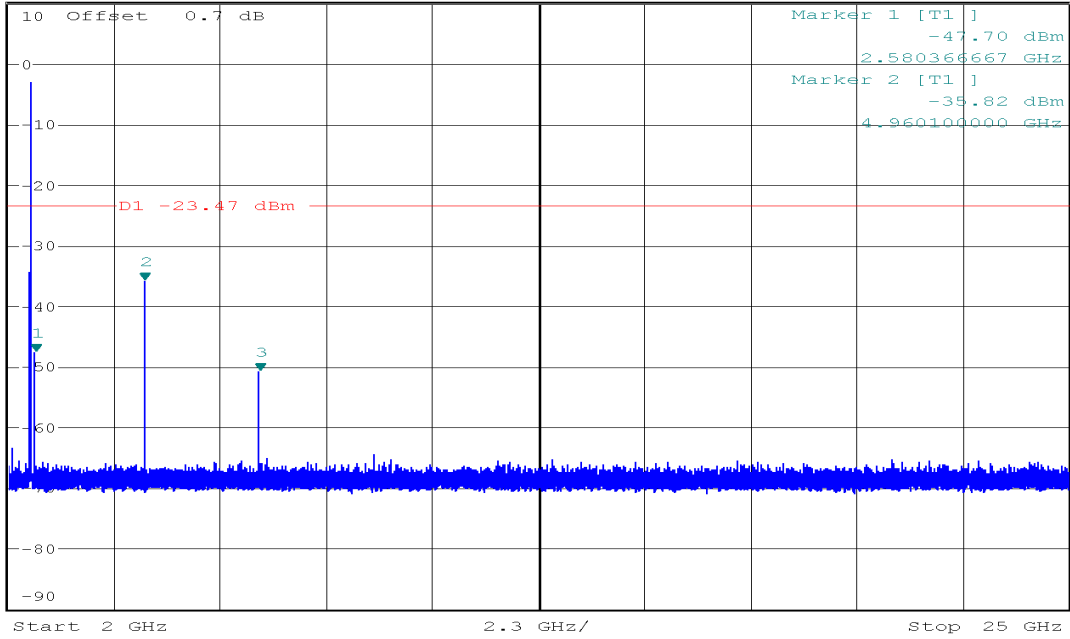

6.6 Radiated Band Edge and Spurious Emission Measurement

LIMIT

1). According to FCC rules:

In any 100 kHz bandwidth outside the intentional radiator frequency band, all harmonics/spurious must be at least 20 dB below the highest emission level within the authorized band. If the output power of this device was measured by spectrum analyzer, the attenuation under this paragraph shall be 30 dB instead of 20 dB. In addition, radiated emissions which fall in the restricted bands must also comply with the FCC section 15.209 limits as below.

Frequency (MHz)	Field Strength (mV/m)	Measurement Distance (m)
30-88	100*	3
88-216	150*	3
216-960	200*	3
Above 960	500	3

Remark: Except as provided in paragraph (g), fundamental emissions from intentional radiators operating under this Section shall not be located in the frequency bands 54-72 MHz, 76-88 MHz, 174-216 MHz or 470-806 MHz. However, operation within these frequency bands is permitted under other sections of this Part, e.g., Sections 15.231 and 15.241.

In the above emission table, the tighter limit applies at the band edges.

Frequency (Hz)	Field Strength ($\mu\text{V}/\text{m}$ at 3-meter)	Field Strength ($\text{dB}\mu\text{V}/\text{m}$ at 3-meter)
30-88	100	40
88-216	150	43.5
216-960	200	46
Above 960	500	54

2). According to IC rules:

According to RSS-Gen section 8.9, Except where otherwise indicated in the applicable RSS, radiated emissions shall comply with the field strength limits shown in table below. Additionally, the level of any transmitter unwanted emission shall not exceed the level of the transmitter's fundamental emission.

Frequency	Magnetic field strength (H-Field) ($\mu\text{A/m}$)	Measurement distance (m)
9 - 490 kHz 1	6.37/F (F in kHz)	300
490 - 1705 kHz	63.7/F (F in kHz)	30
1.705 - 30 MHz	0.08	30

Note: The emission limits for the bands 9-90 kHz and 110-490 kHz are based on measurements employing a linear average detector. Transmitting devices are not permitted in restricted frequency bands unless stated otherwise in the relevant RSS.

In the emission table above, the tighter limit applies at the band edges.

Frequency (MHz)	Field Strength ($\mu\text{v/m}$ at 3 metres)
30-88	100
88-216	150
216-960	200
Above 960*	500

Note: Transmitting devices are not permitted in restricted frequency bands unless stated otherwise in the specific RSS.

Test Configuration

Below 30MHz

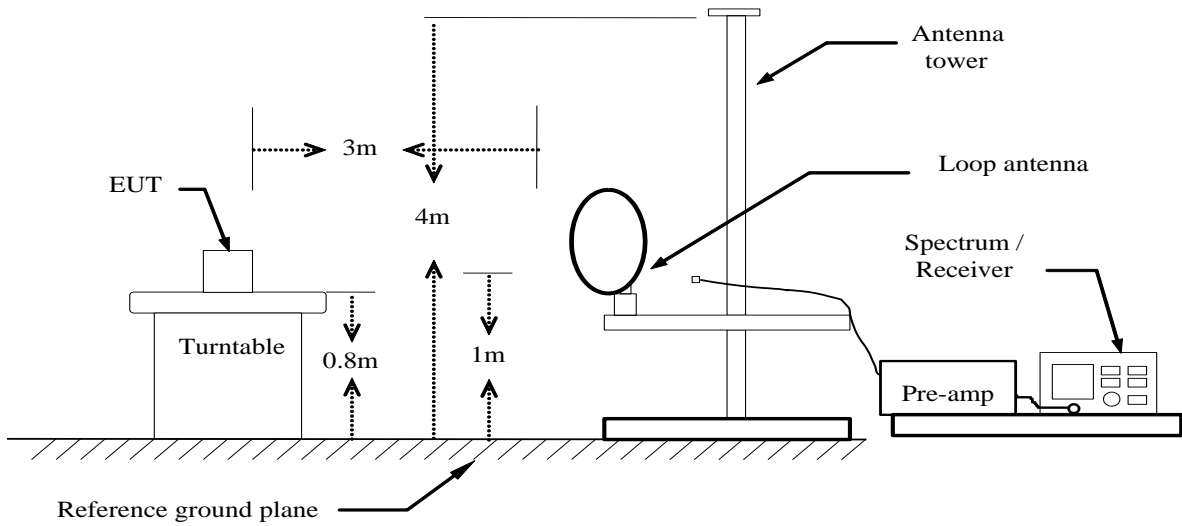

Below 1 GHz

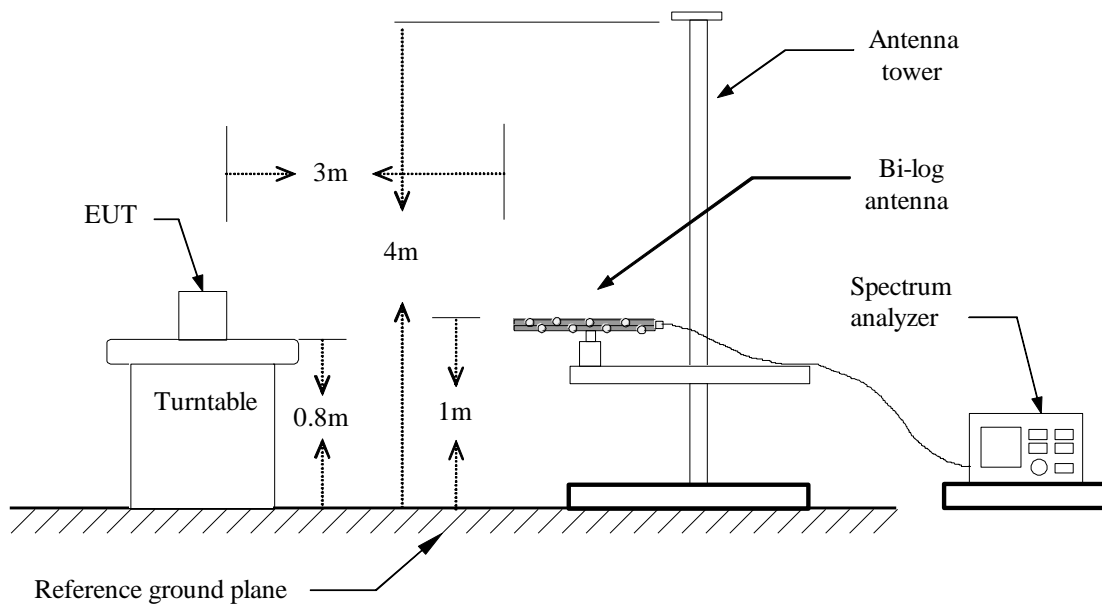

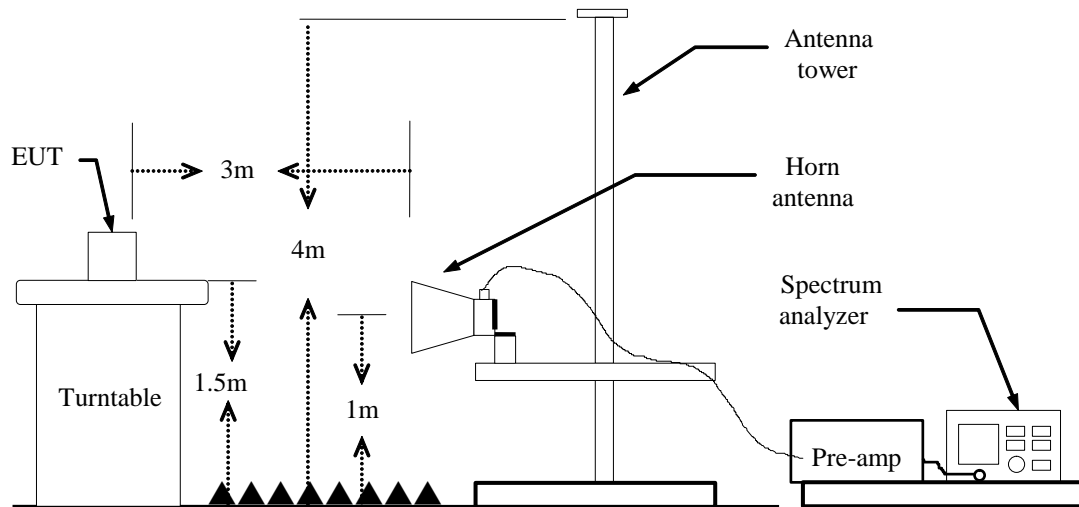
Above 1 GHz**TEST PROCEDURE**

1. The EUT is placed on a turntable above ground plane, which is 0.8 meter for frequency below 1GHz and 1.5 meter for frequency above 1GHz.
2. The turntable shall be rotated for 360 degrees to determine the position of maximum emission level.
3. EUT is set 3m away from the receiving antenna, which is varied from 1m to 4m to find out the highest emissions.
4. Maximum procedure was performed on the six highest emissions to ensure EUT compliance.
5. And also, each emission was to be maximized by changing the polarization of receiving antenna both horizontal and vertical.
6. Set the spectrum analyzer in the following setting as:

Below 1GHz:

RBW=100kHz / VBW=300kHz / Sweep=AUTO

Above 1GHz:

PEAK: RBW=VBW=1MHz / Sweep=AUTO

AVERAGE: RBW=1MHz / Sweep=AUTO

VBW=10Hz, when duty cycle is no less than 98 percent.

VBW $\geq 1/T$, when duty cycle is less than 98 percent, where T is the minimum transmission duration over which the transmitter is on and is transmitting at its Maximum power control level for the tested mode of operation.

Configuration	Duty Cycle (%)	VBW
BLE	75.57	3kHz

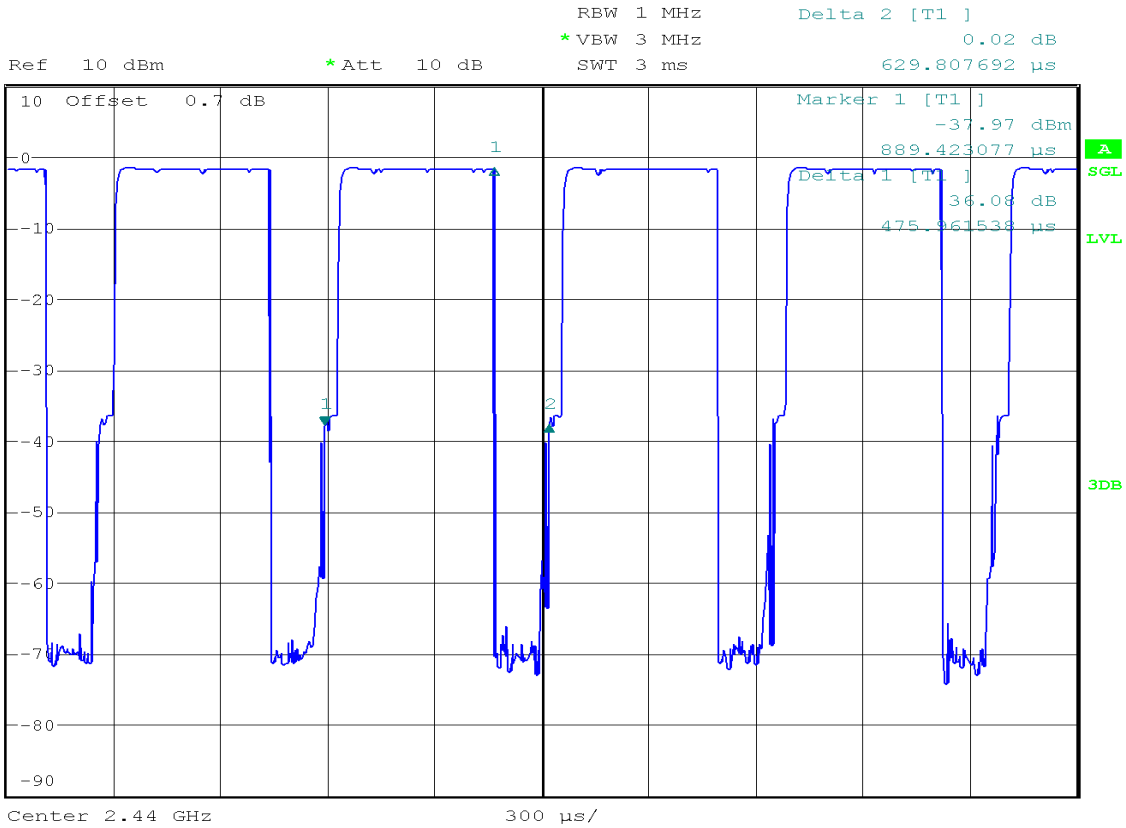

RESTRICTED BANDEDGE (BLE4.1 on Channel 0, Horizontal)

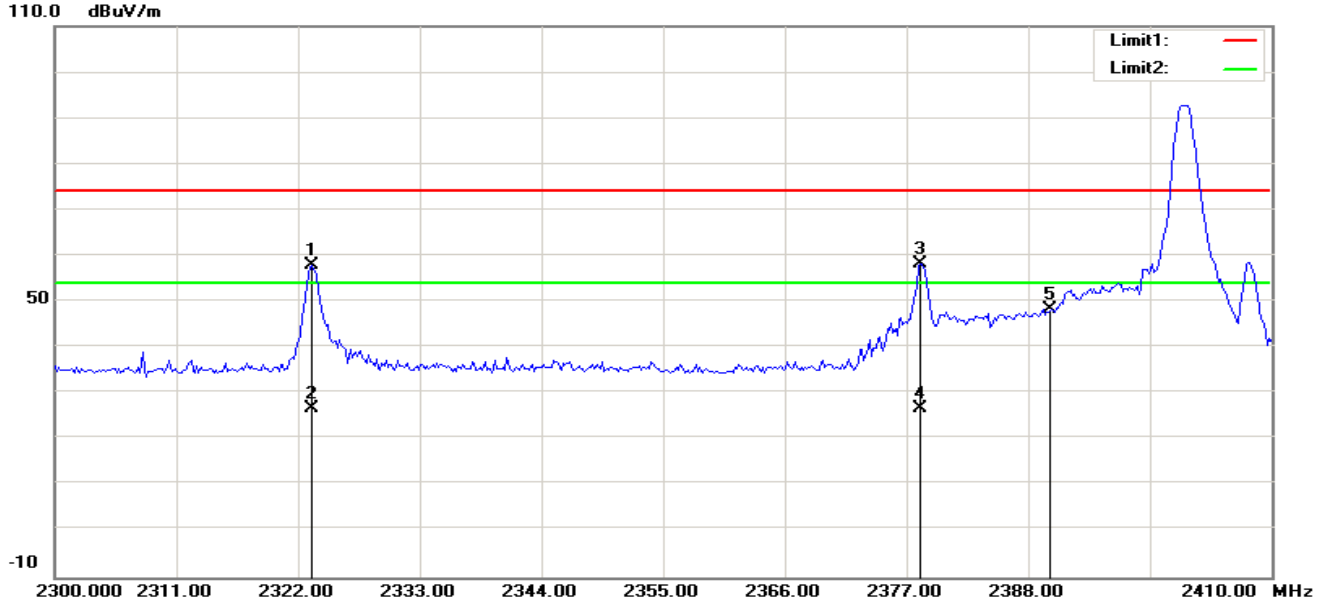

No.	Frequency (MHz)	Reading (dBuV)	Correct Factor(dB/m)	Result (dBuV/m)	Limit (dBuV/m)	Margin (dB)	Height (cm)	Degree (deg.)	Remark
1	2323.269	65.76	-7.79	57.97	74.00	-16.03	100	235	peak
2	2323.269	34.52	-7.79	26.73	54.00	-27.27	100	235	AVG
3	2378.269	65.85	-7.61	58.24	74.00	-15.76	100	229	peak
4	2378.269	34.41	-7.61	26.80	54.00	-27.20	100	229	AVG
5	2390.000	55.78	-7.57	48.21	74.00	-25.79	100	251	peak

RESTRICTED BANDEDGE (BLE4.1 on Channel 0, Vertical)

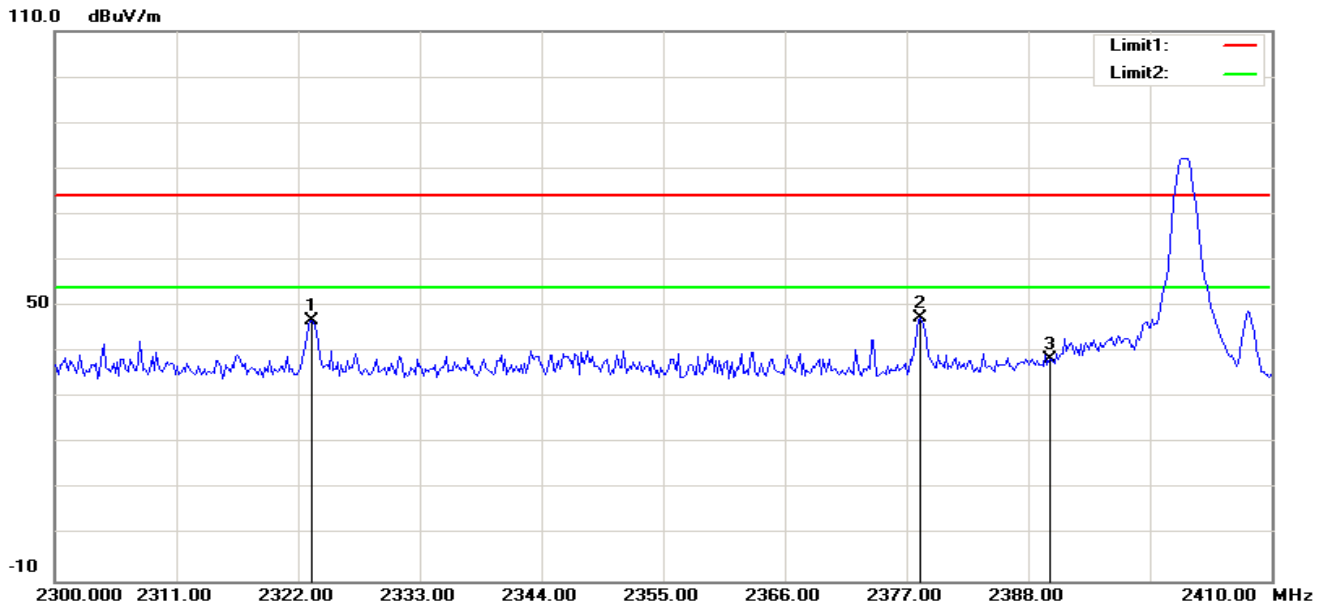

No.	Frequency (MHz)	Reading (dBuV)	Correct Factor(dB/m)	Result (dBuV/m)	Limit (dBuV/m)	Margin (dB)	Height (cm)	Degree (deg.)	Remark
1	2323.269	54.67	-7.79	46.88	74.00	-27.12	100	214	peak
2	2378.269	55.02	-7.61	47.41	74.00	-26.59	200	206	peak
3	2390.000	46.08	-7.57	38.51	74.00	-35.49	100	191	peak

RESTRICTED BANDEDGE (BLE4.1 on Channel 39, Horizontal)

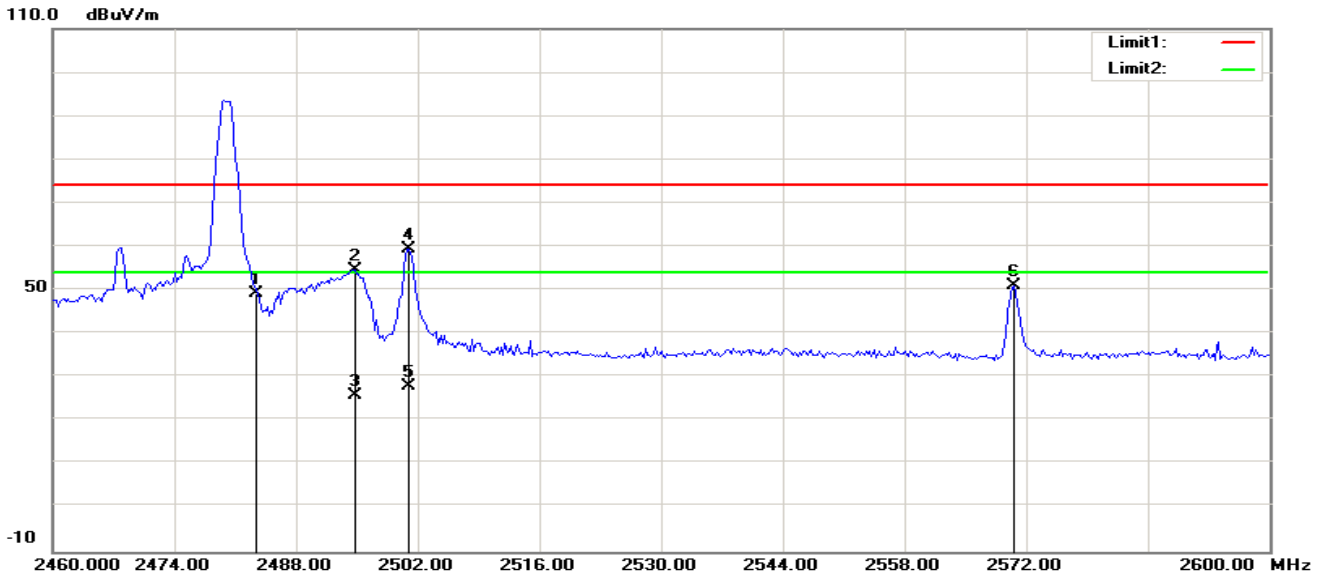

No.	Frequency (MHz)	Reading (dBuV)	Correct Factor(dB/m)	Result (dBuV/m)	Limit (dBuV/m)	Margin (dB)	Height (cm)	Degree (deg.)	Remark
1	2483.500	56.44	-7.26	49.18	74.00	-24.82	100	228	peak
2	2494.776	61.86	-7.23	54.63	74.00	-19.37	100	205	peak
3	2494.776	33.14	-7.23	25.91	54.00	-28.09	100	205	AVG
4	2501.058	66.79	-7.21	59.58	74.00	-14.42	100	232	peak
5	2501.058	35.22	-7.21	28.01	54.00	-25.99	100	232	AVG
6	2570.609	58.04	-7.02	51.02	74.00	-22.98	100	194	peak

RESTRICTED BANDEDGE (BLE4.1 on Channel 39, Vertical)

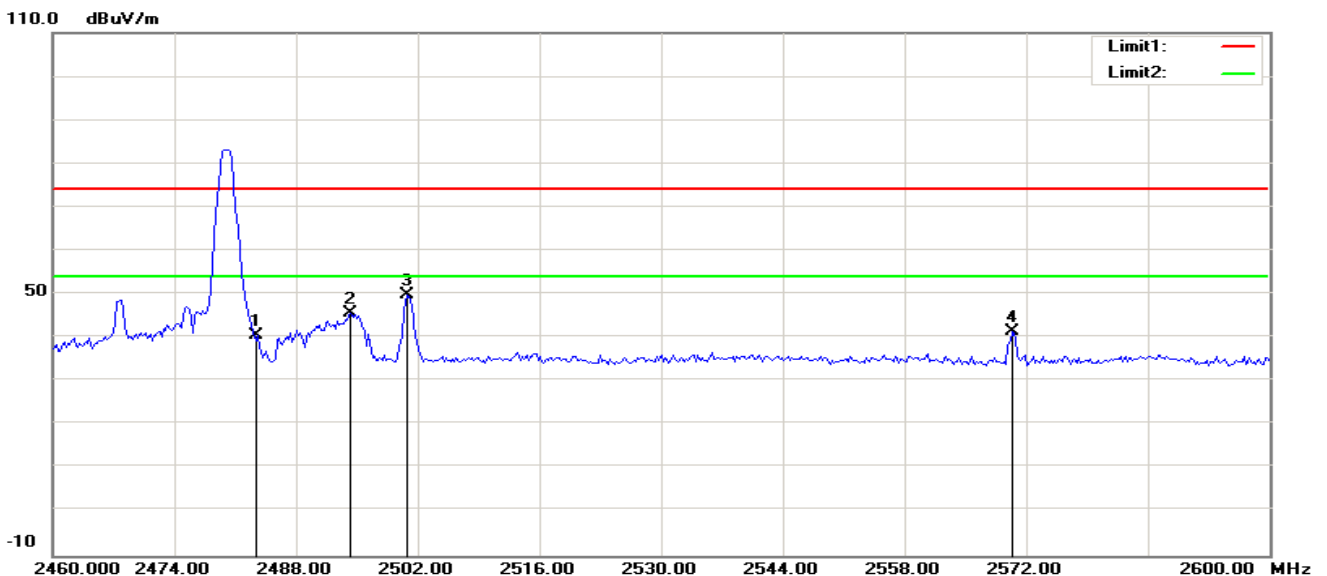

No.	Frequency (MHz)	Reading (dBuV)	Correct Factor(dB/m)	Result (dBuV/m)	Limit (dBuV/m)	Margin (dB)	Height (cm)	Degree (deg.)	Remark
1	2483.500	47.74	-7.26	40.48	74.00	-33.52	100	189	peak
2	2494.327	52.82	-7.23	45.59	74.00	-28.41	100	152	peak
3	2500.833	56.95	-7.21	49.74	74.00	-24.26	100	155	peak
4	2570.385	48.44	-7.02	41.42	74.00	-32.58	100	30	peak

Test Result of Radiated Emission

Below 30MHz

The interference of the frequency value is lower than the limit below 20 db, measured as the background noise values and will not be recorded.

30MHz-1GHz

Operation Mode:	Normal Link	Test Date:	2018-5-8
Temperature:	25°C	Tested by:	Lily.Wang
Humidity:	48% RH	Polarity:	Hor.

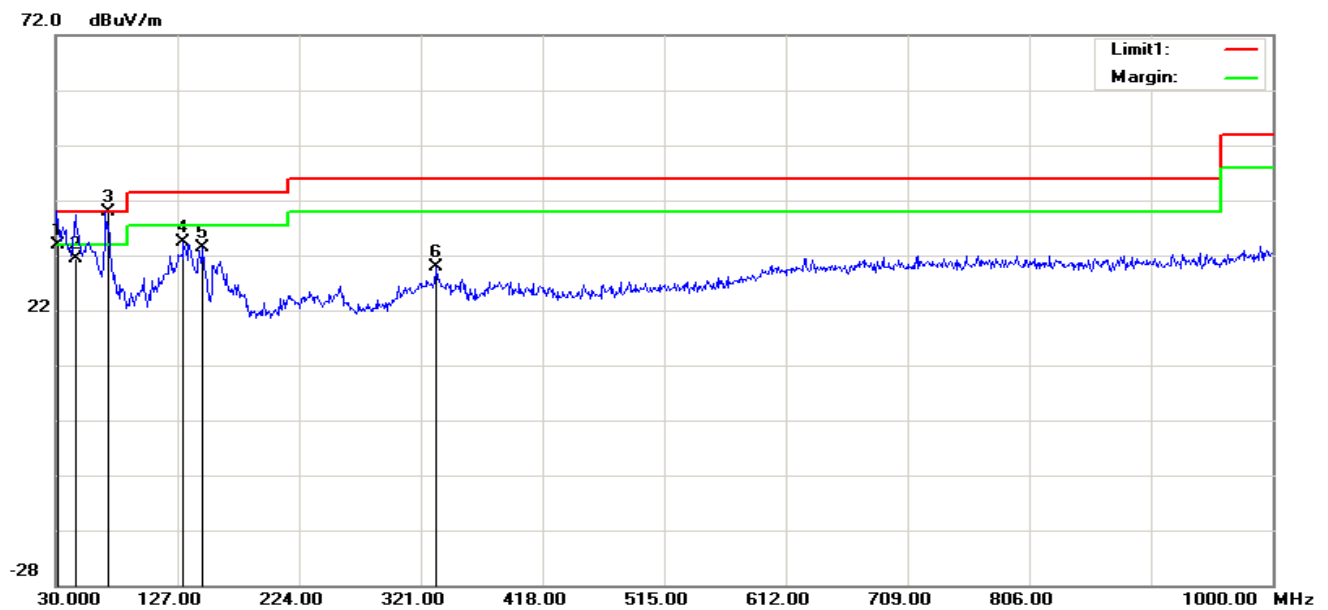

Frequency (MHz)	Ant. Pol. (H/V)	Reading (dBuV)	Correction Factor (dB/m)	Result (dBuV/m)	Limit (dBuV/m)	Margin (dB)	Remark
31.3600	H	10.46	23.51	33.97	40.00	-6.03	QP
46.6040	H	13.85	17.65	31.50	40.00	-8.50	QP
71.7870	H	29.62	10.23	39.85	40.00	-0.15	QP
131.8500	H	20.39	14.08	34.47	43.50	-9.03	peak
147.3700	H	19.05	14.30	33.35	43.50	-10.15	peak
333.6100	H	11.75	18.05	29.80	46.00	-16.20	peak

Operation Mode:	Normal Link	Test Date:	2018-5-8
Temperature:	25°C	Tested by:	Lily.Wang
Humidity:	48% RH	Polarity:	Ver.

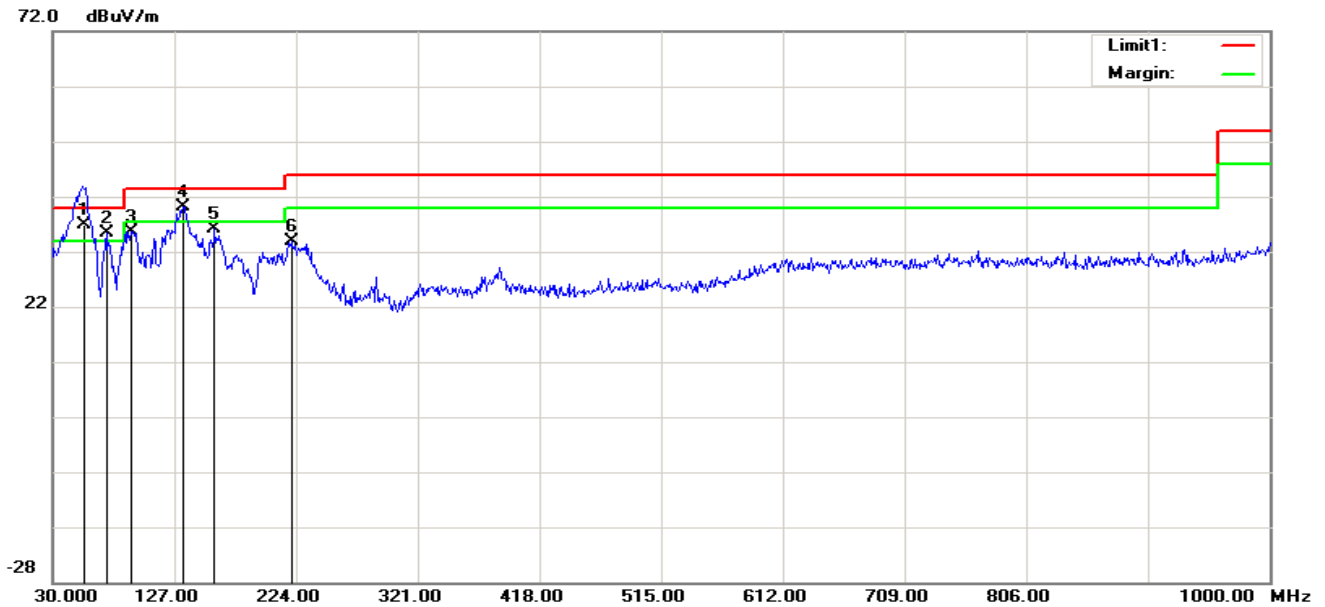

Frequency (MHz)	Ant. Pol. (H/V)	Reading (dBuV)	Correction Factor (dB/m)	Result (dBuV/m)	Limit (dBuV/m)	Margin (dB)	Remark
54.6770	V	22.83	14.12	36.95	40.00	-3.05	QP
72.6800	V	25.11	10.37	35.48	40.00	-4.52	peak
93.0500	V	22.71	12.92	35.63	43.50	-7.87	peak
133.7900	V	26.14	14.11	40.25	43.50	-3.25	peak
159.0100	V	21.65	14.40	36.05	43.50	-7.45	peak
220.1200	V	18.89	15.01	33.90	46.00	-12.10	peak

Notes:

1. Measurements above show only up to maximum emissions noted, if no specific emissions from the EUT are recorded (ie: margin>20dB from the applicable limit) and considered that's already beyond the background noise floor.
2. Radiated emissions measured in frequency range from 9 KHz to 1000MHz were made with an instrument using Peak detector mode.
3. Data of measurement within this frequency range shown " --- " in the table above means the reading of emissions are attenuated more than 20dB below the permissible limits or the field strength is too small to be measured.
4. The IF bandwidth of SPA between 30MHz to 1GHz was 100kHz.

Above 1 GHz

Operation Mode: Bluetooth LE4.1 **Test Date:** 2018-5-7
Test Channel: CH00 **Tested by:** Lily.Wang
Temperature: 25°C **Polarity:** Ver. / Hor.

Horizontal

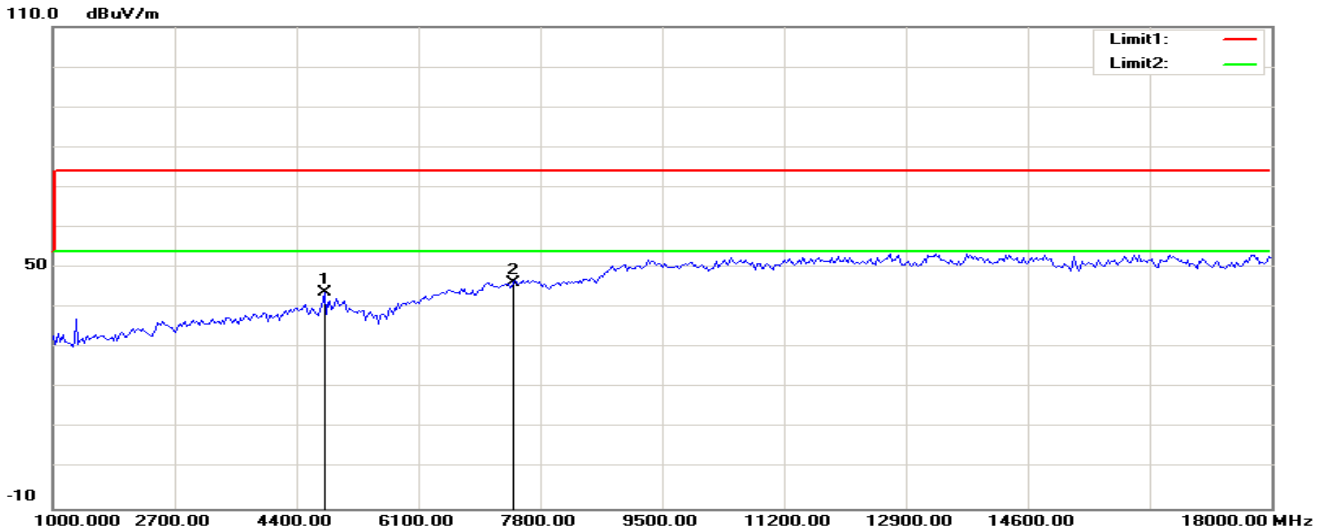

No.	Frequency (MHz)	Reading (dBuV)	Correct Factor(dB/m)	Result (dBuV/m)	Limit (dBuV/m)	Margin (dB)	Height (cm)	Degree (deg.)	Remark
1	4786.859	44.41	-0.43	43.98	74.00	-30.02	100	149	peak
2	7429.487	40.27	5.84	46.11	74.00	-27.89	100	134	peak
N/A									

Vertical

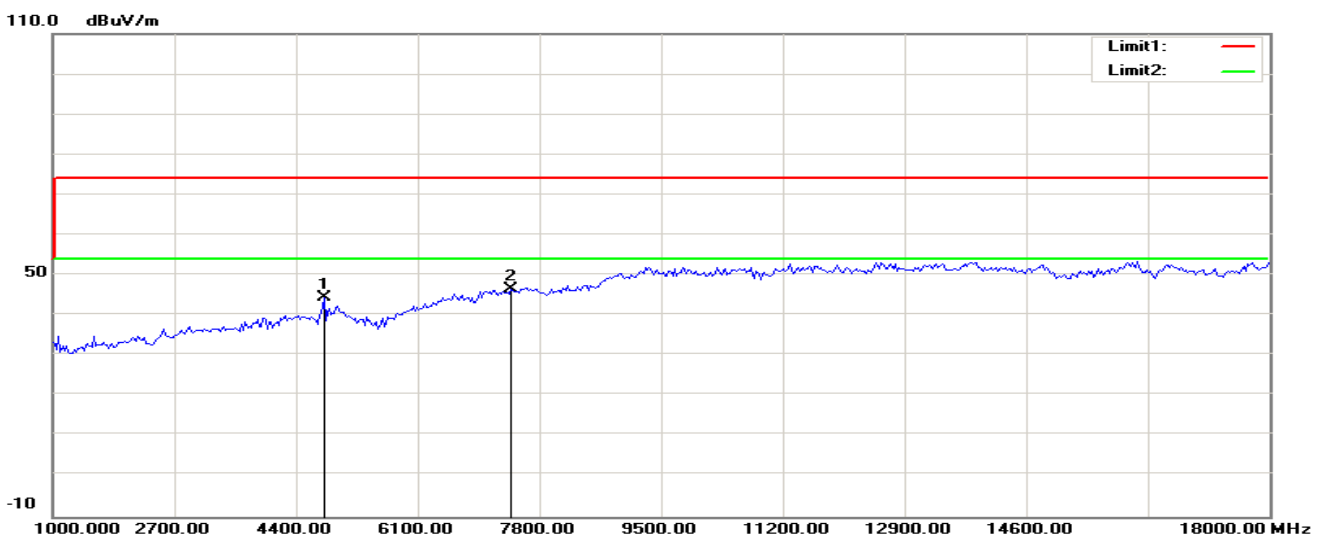

No.	Frequency (MHz)	Reading (dBuV)	Correct Factor(dB/m)	Result (dBuV/m)	Limit (dBuV/m)	Margin (dB)	Height (cm)	Degree (deg.)	Remark
1	4786.859	44.99	-0.43	44.56	74.00	-29.44	100	156	peak
2	7402.244	40.81	5.74	46.55	74.00	-27.45	100	76	peak
N/A									

Operation Mode: Bluetooth LE4.1
Test Channel: CH19
Temperature: 25°C

Test Date: 2018-5-7
Tested by: Lily.Wang
Polarity: Ver. / Hor.

Horizontal

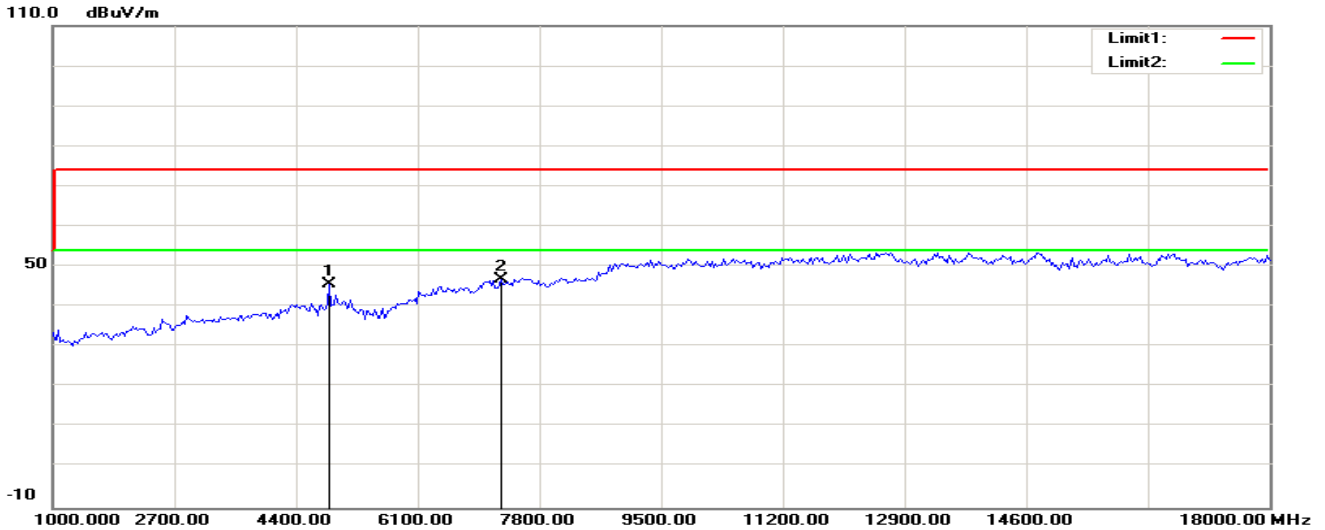

No.	Frequency (MHz)	Reading (dBuV)	Correct Factor(dB/m)	Result (dBuV/m)	Limit (dBuV/m)	Margin (dB)	Height (cm)	Degree (deg.)	Remark
1	4868.590	45.82	-0.12	45.70	74.00	-28.30	100	144	peak
2	7266.026	41.61	5.26	46.87	74.00	-27.13	100	67	peak
N/A									

Vertical

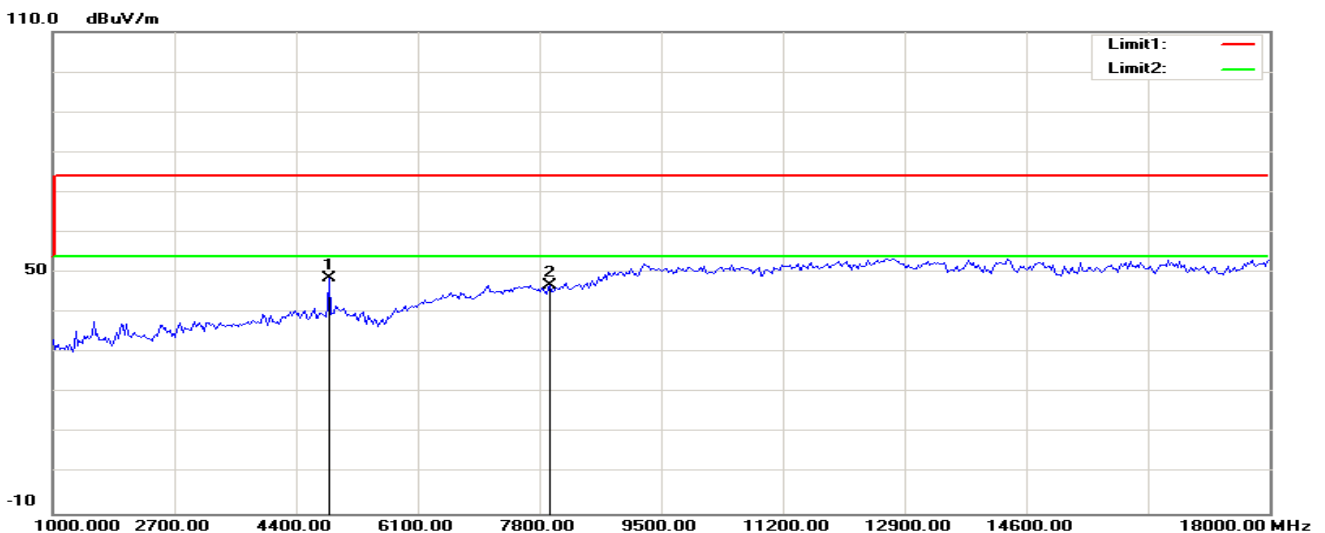

No.	Frequency (MHz)	Reading (dBuV)	Correct Factor(dB/m)	Result (dBuV/m)	Limit (dBuV/m)	Margin (dB)	Height (cm)	Degree (deg.)	Remark
1	4868.590	48.78	-0.12	48.66	74.00	-25.34	100	14	peak
2	7947.115	41.00	5.81	46.81	74.00	-27.19	100	231	peak
N/A									

Operation Mode: Bluetooth LE4.1
Test Channel: CH39
Temperature: 25°C

Test Date: 2018-5-7
Tested by: Lily.Wang
Polarity: Ver. / Hor.

Horizontal

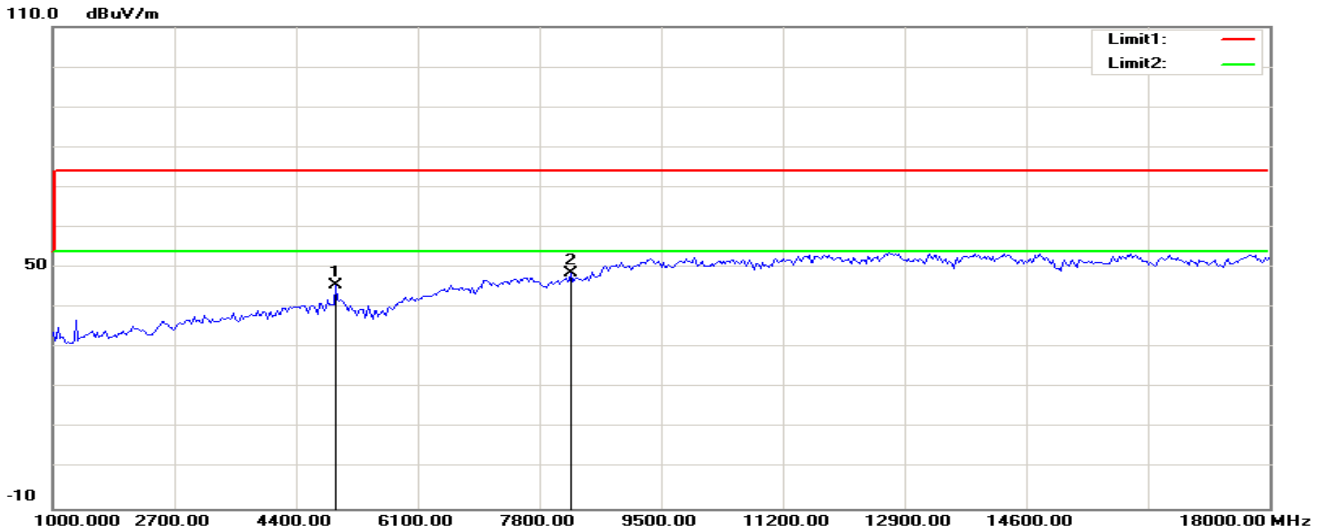

No.	Frequency (MHz)	Reading (dBuV)	Correct Factor(dB/m)	Result (dBuV/m)	Limit (dBuV/m)	Margin (dB)	Height (cm)	Degree (deg.)	Remark
1	4950.320	45.45	0.18	45.63	74.00	-28.37	100	140	peak
2	8246.795	42.07	6.56	48.63	74.00	-25.37	100	184	peak
N/A									

Vertical

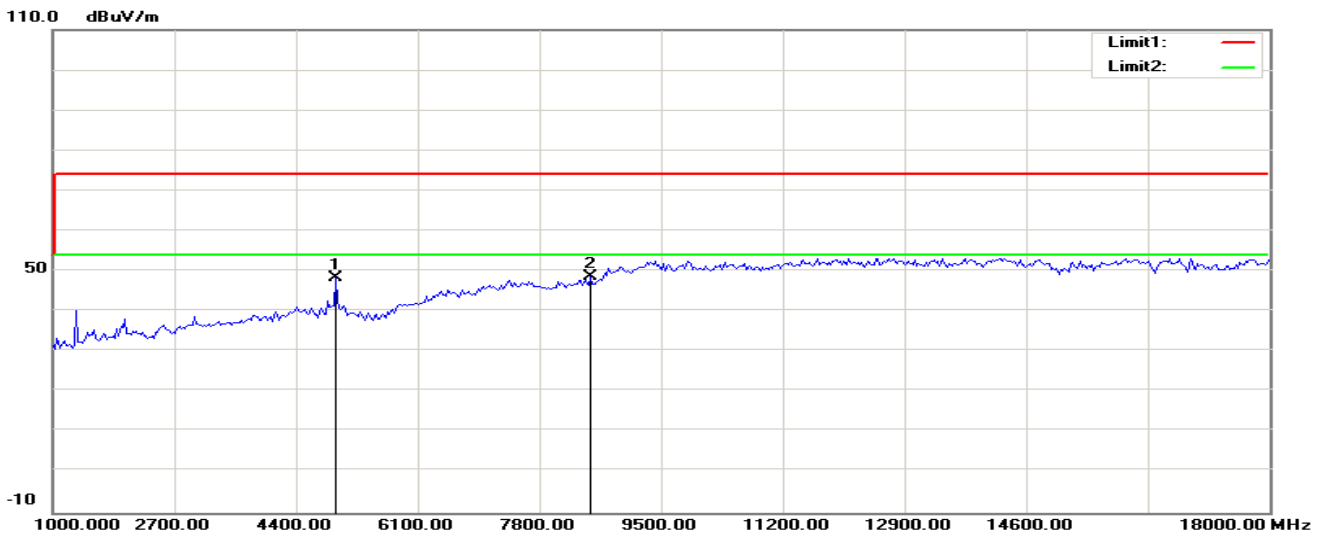

No.	Frequency (MHz)	Reading (dBuV)	Correct Factor(dB/m)	Result (dBuV/m)	Limit (dBuV/m)	Margin (dB)	Height (cm)	Degree (deg.)	Remark
1	4950.320	48.05	0.18	48.23	74.00	-25.77	100	13	peak
2	8519.231	41.09	7.47	48.56	74.00	-25.44	100	118	peak
N/A									

Above 18GHz

The interference of the frequency value is lower than the limit below 20 db, measured as the background noise values and will not be recorded.

6.7 POWERLINE CONDUCTED EMISSIONS

LIMIT

1). According to FCC rules:

For an intentional radiator which is designed to be connected to the public utility (AC) power line, the radio frequency voltage that is conducted back onto the AC power line on any frequency or frequencies within the band 150 kHz to 30 MHz shall not exceed 250 microvolts (The limit decreases linearly with the logarithm of the frequency in the range 0.15 MHz to 0.50 MHz). The limits at specific frequency range is listed as follows:

Frequency Range (MHz)	Limits (dB μ V)	
	Quasi-peak	Average
0.15 to 0.50	66 to 56	56 to 46
0.50 to 5	56	46
5 to 30	60	50

Compliance with this provision shall be based on the measurement of the radio frequency voltage between each power line (LINE and NEUTRAL) and ground at the power terminals.

Test Configuration

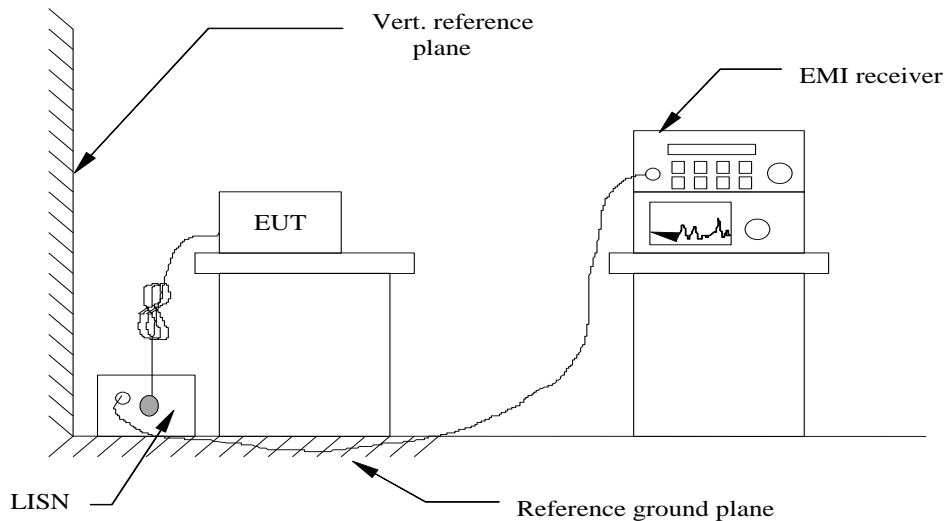

See test photographs attached in Appendix 1 for the actual connections between EUT and support equipment.

2). According to IC rules:

Unless stated otherwise in the applicable RSS, for radio apparatus that are designed to be connected to the public utility AC power network, the radio frequency voltage that is conducted back onto the AC power line on any frequency or frequencies within the range 150 kHz to 30 MHz shall not exceed the limits in table 4, as measured using a 50 μ H / 50 Ω line impedance stabilization network. This requirement applies for the radio frequency voltage measured between each power line and the ground terminal of each AC power-line mains cable of the EUT.

For an EUT that connects to the AC power lines indirectly, through another device, the requirement for compliance with the limits in table 4 shall apply at the terminals of the AC power-line mains cable of a representative support device, while it provides power to the EUT. The lower limit applies at the boundary between the frequency ranges. The device used to power the EUT shall be representative of typical applications.

Frequency (MHz)	Conducted limit (dB μ V)	Frequency (MHz)
	Quasi-peak	Average
0.15-0.5	66 to 56 ¹	56 to 46 ¹
0.5-5	56	46
5-30	60	50

Note 1: The level decreases linearly with the logarithm of the frequency

TEST PROCEDURE

1. The EUT was placed on a table, which is 0.8m above ground plane.
2. Maximum procedure was performed on the six highest emissions to ensure EUT compliance.
3. Repeat above procedures until all frequency measured were complete.

TEST RESULTS

The initial step in collecting conducted data is a spectrum analyzer peak scan of the measurement range. Significant peaks are then marked as shown on the following data page, and these signals are then quasi-peaked.

Test Data

Job No.:	C180502R01	Date:	2018/5/7
Model No.:	N4MZ98	Time:	16:20:05
Standard:	FCC Class B	Temp.(C)/Hum.(%):	22(C)/41%
Test item:	Conduction test	Test By:	Lily.Wang
Line:	L1	Test Voltage:	AC 120V/60Hz
Model:		Description:	

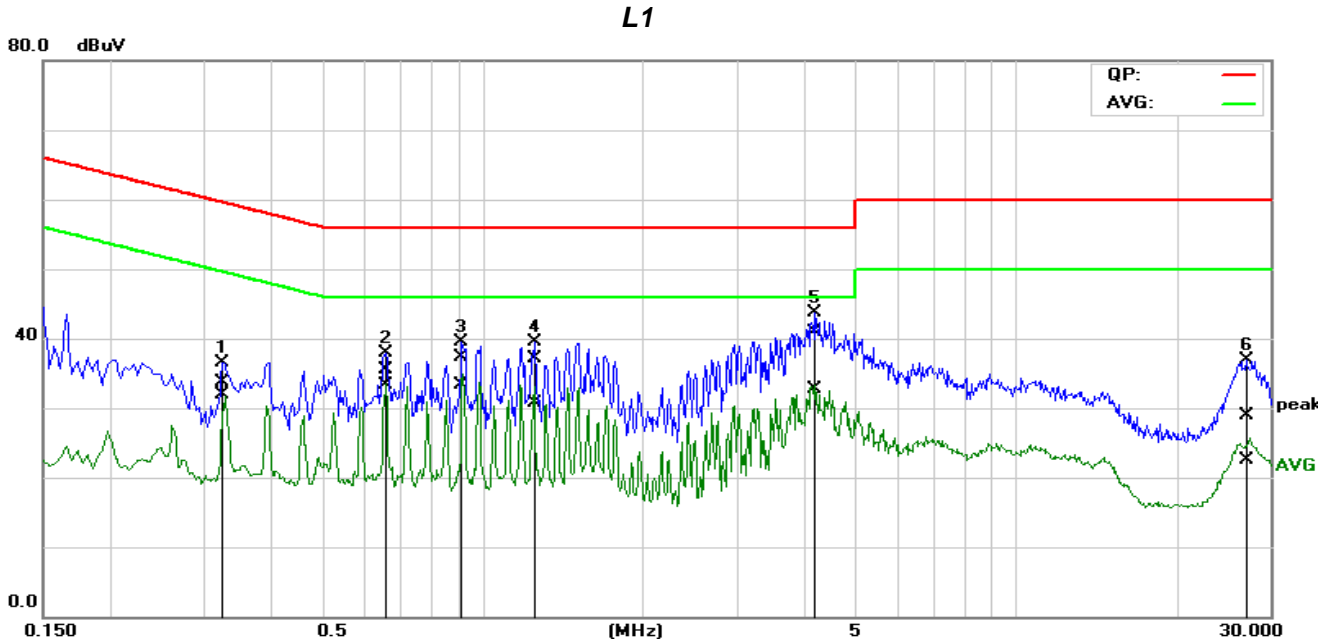

No.	Frequency (MHz)	QuasiPeak reading (dBuV)	Average reading (dBuV)	Correction factor (dB)	QuasiPeak result (dBuV)	Average result (dBuV)	QuasiPeak limit (dBuV)	Average limit (dBuV)	QuasiPeak margin (dB)	Average margin (dB)	Remark
1	0.3286	14.27	12.50	19.48	33.75	31.98	59.48	49.49	-25.73	-17.51	Pass
2*	0.6570	15.99	13.81	19.52	35.51	33.33	56.00	46.00	-20.49	-12.67	Pass
3	0.9170	17.85	13.72	19.55	37.40	33.27	56.00	46.00	-18.60	-12.73	Pass
4	1.2559	17.60	11.09	19.57	37.17	30.66	56.00	46.00	-18.83	-15.34	Pass
5	4.2264	21.19	13.04	19.67	40.86	32.71	56.00	46.00	-15.14	-13.29	Pass
6	27.1104	8.79	2.37	20.07	28.86	22.44	60.00	50.00	-31.14	-27.56	Pass

Note: 1. L1 = Line One (Live Line) / L2 = Line Two (Neutral Line).

Job No.:	C180502R01	Date:	2018/5/7
Model No.:	N4MZ98	Time:	16:24:38
Standard:	FCC Class B	Temp.(C)/Hum.(%):	22(C)/41%
Test item:	Conduction test	Test By:	Lily.Wang
Line:	L2	Test Voltage:	AC 120V/60Hz
Model:		Description:	

L2

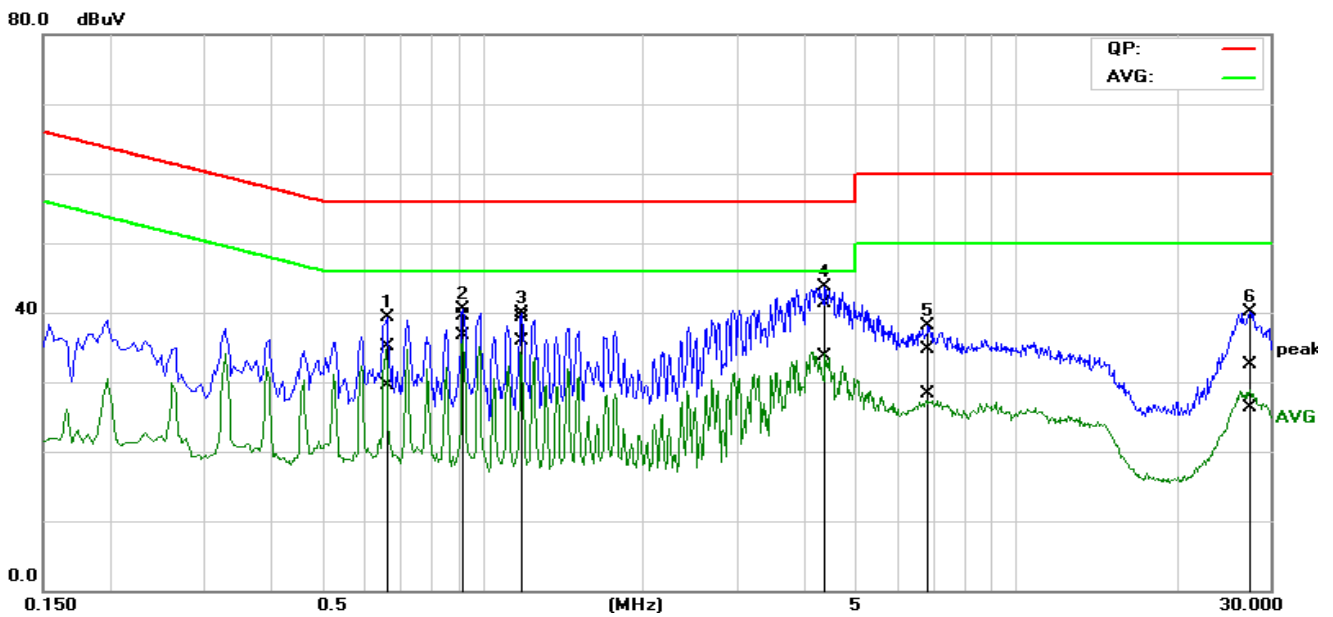

No.	Frequency (MHz)	QuasiPeak reading (dBuV)	Average reading (dBuV)	Correction factor (dB)	QuasiPeak result (dBuV)	Average result (dBuV)	QuasiPeak limit (dBuV)	Average limit (dBuV)	QuasiPeak margin (dB)	Average margin (dB)	Remark
1	0.6524	15.60	9.92	19.51	35.11	29.43	56.00	46.00	-20.89	-16.57	Pass
2*	0.9234	20.06	17.18	19.54	39.60	36.72	56.00	46.00	-16.40	-9.28	Pass
3	1.1849	19.71	16.40	19.55	39.26	35.95	56.00	46.00	-16.74	-10.05	Pass
4	4.3900	21.74	14.11	19.66	41.40	33.77	56.00	46.00	-14.60	-12.23	Pass
5	6.8771	14.92	8.56	19.74	34.66	28.30	60.00	50.00	-25.34	-21.70	Pass
6	27.5226	12.49	6.31	20.04	32.53	26.35	60.00	50.00	-27.47	-23.65	Pass

Note: 1. L1 = Line One (Live Line) / L2 = Line Two (Neutral Line).

Job No.:	C180502R01	Date:	2018/5/7
Model No.:	N4MZ98	Time:	16:30:43
Standard:	FCC Class B	Temp.(C)/Hum.(%):	22(C)/48%
Test item:	Conduction test	Test By:	Lily.Wang
Line:	L1	Test Voltage:	AC 240V/60Hz
Model:		Description:	

L1

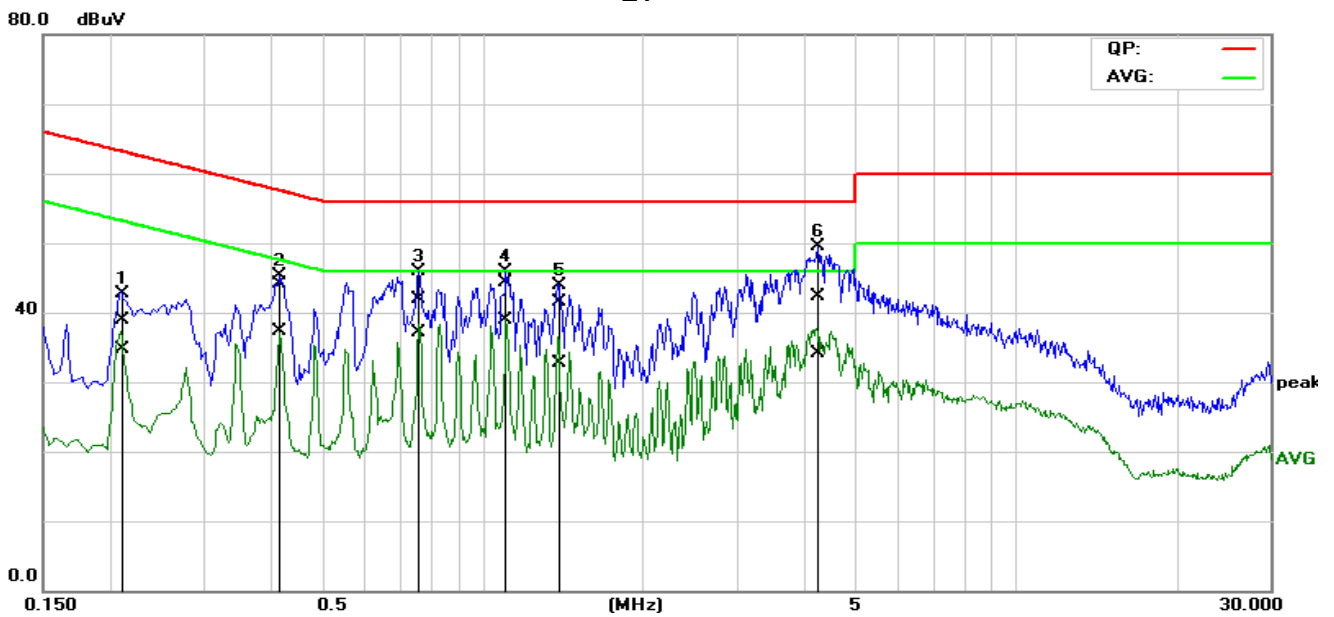

No.	Frequency (MHz)	QuasiPeak reading (dBuV)	Average reading (dBuV)	Correction factor (dB)	QuasiPeak result (dBuV)	Average result (dBuV)	QuasiPeak limit (dBuV)	Average limit (dBuV)	QuasiPeak margin (dB)	Average margin (dB)	Remark
1	0.2123	19.39	15.35	19.45	38.84	34.80	63.11	53.11	-24.27	-18.31	Pass
2	0.4162	24.55	17.88	19.49	44.04	37.37	57.52	47.52	-13.48	-10.15	Pass
3	0.7601	22.28	17.63	19.54	41.82	37.17	56.00	46.00	-14.18	-8.83	Pass
4*	1.1130	24.76	19.37	19.56	44.32	38.93	56.00	46.00	-11.68	-7.07	Pass
5	1.3988	21.87	13.10	19.57	41.44	32.67	56.00	46.00	-14.56	-13.33	Pass
6	4.2776	22.60	14.43	19.67	42.27	34.10	56.00	46.00	-13.73	-11.90	Pass

Note: 1. L1 = Line One (Live Line) / L2 = Line Two (Neutral Line).

Job No.:	C180502R01	Date:	2018/5/7
Model No.:	N4MZ98	Time:	16:35:32
Standard:	FCC Class B	Temp.(C)/Hum.(%):	22(C)/48%
Test item:	Conduction test	Test By:	Lily.Wang
Line:	L2	Test Voltage:	AC 240V/60Hz
Model:		Description:	

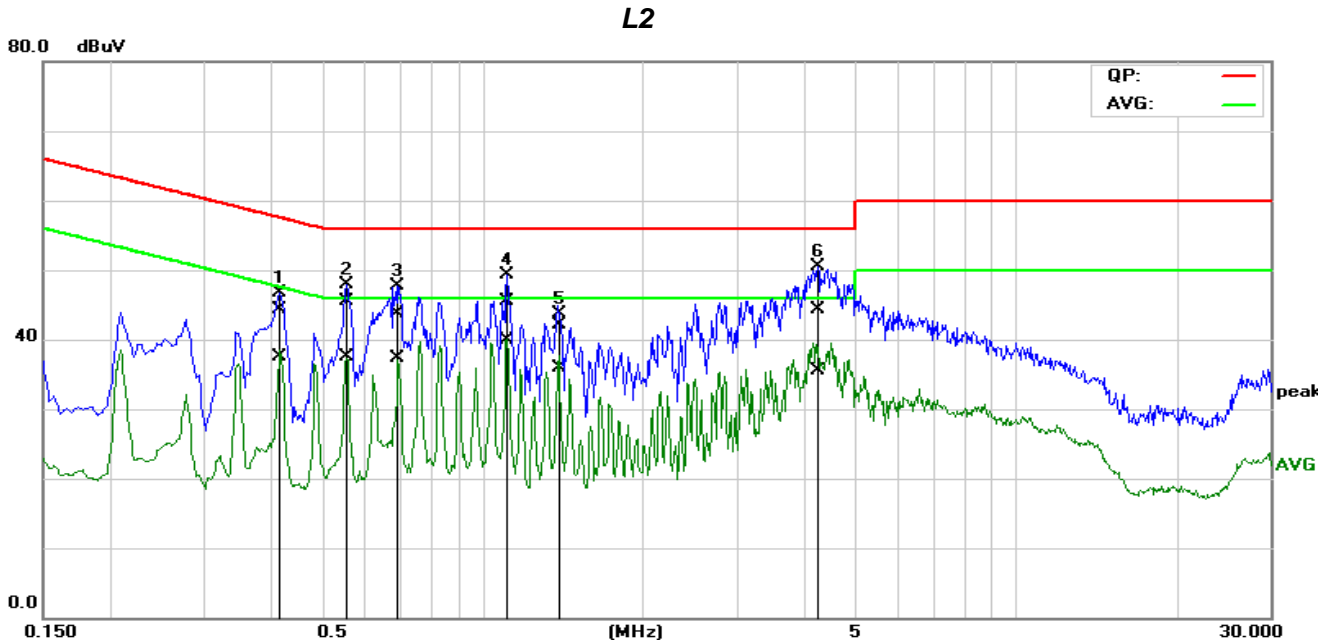

No.	Frequency (MHz)	QuasiPeak reading (dBuV)	Average reading (dBuV)	Correction factor (dB)	QuasiPeak result (dBuV)	Average result (dBuV)	QuasiPeak limit (dBuV)	Average limit (dBuV)	QuasiPeak margin (dB)	Average margin (dB)	Remark
1	0.4192	24.93	17.96	19.47	44.40	37.43	57.46	47.46	-13.06	-10.03	Pass
2	0.5579	26.01	17.92	19.49	45.50	37.41	56.00	46.00	-10.50	-8.59	Pass
3	0.6957	24.28	17.85	19.52	43.80	37.37	56.00	46.00	-12.20	-8.63	Pass
4*	1.1155	25.96	20.31	19.54	45.50	39.85	56.00	46.00	-10.50	-6.15	Pass
5	1.3981	22.51	16.40	19.55	42.06	35.95	56.00	46.00	-13.94	-10.05	Pass
6	4.2874	24.58	15.83	19.65	44.23	35.48	56.00	46.00	-11.77	-10.52	Pass

Note: 1. L1 = Line One (Live Line) / L2 = Line Two (Neutral Line).

Remark:

1. The measuring frequencies range between 0.15 MHz and 30 MHz.
2. The emissions measured in the frequency range between 0.15 MHz and 30 MHz were made with an instrument using Quasi-peak detector and Average detector.
3. "---" denotes the emission level was or more than 2dB below the Average limit, and no re-check was made.
4. The IF bandwidth of SPA between 0.15 MHz and 30 MHz was 10 KHz. The IF bandwidth of Test Receiver between 0.15 MHz and 30 MHz was 9 KHz.

END OF REPORT