

Test Report

FCC ID:2ALQR-CTT5601

Date of issue: July 30, 2020

Report number: MTi20031911-5E1

Sample description: 5-in-1 Emergency Hub

Model(s): 5601-00T, 5601-001, 5601-002, 5601-003, 5601-004, 5601-005,
5601-006, 5601-007, 5601-008, 5601-009, 5601-00P, 5601-00A,
5601-00V

Applicant: NLU Products, LLC dba BGZ brands

Address: 2801 N Thanksgiving Way #300, Lehi, UT 84043, U.S.A.

Date of test: May 22, 2020 to July 06, 2020

Shenzhen Microtest Co., Ltd.
<http://www.mtitest.com>

Table of Contents

| | | |
|----------|---|-----------|
| 1 | GENERAL INFORMATION | 5 |
| 1.1 | DESCRIPTION OF EUT | 5 |
| 1.2 | OPERATION CHANNEL LIST | 6 |
| 1.3 | TEST CHANNEL LIST | 6 |
| 1.4 | ANCILLARY EQUIPMENT LIST | 6 |
| 1.5 | DESCRIPTION OF SUPPORT UNITS | 6 |
| 2 | SUMMARY OF TEST RESULTS | 7 |
| 3 | TEST FACILITIES AND ACCREDITATIONS | 8 |
| 3.1 | TEST LABORATORY | 8 |
| 3.2 | ENVIRONMENTAL CONDITIONS | 8 |
| 3.3 | MEASUREMENT UNCERTAINTY | 8 |
| 3.4 | TEST SOFTWARE | 8 |
| 4 | EQUIPMENT LIST | 9 |
| 5 | TEST RESULT | 11 |
| 5.1 | ANTENNA REQUIREMENT | 11 |
| 5.1.1 | <i>Standard requirement</i> | 11 |
| 5.1.2 | <i>EUT antenna</i> | 11 |
| 5.2 | PEAK OUTPUT POWER | 12 |
| 5.2.1 | <i>Limit</i> | 12 |
| 5.2.2 | <i>Test setup</i> | 12 |
| 5.2.3 | <i>Test procedure</i> | 12 |
| 5.2.4 | <i>Test results</i> | 13 |
| 5.3 | POWER SPECTRAL DENSITY | 14 |
| 5.3.1 | <i>Limit</i> | 14 |
| 5.3.2 | <i>Test setup</i> | 14 |
| 5.3.3 | <i>Test procedure</i> | 14 |
| 5.3.4 | <i>Test results</i> | 15 |
| 5.4 | CONDUCTED EMISSION | 18 |
| 5.4.1 | <i>Limits</i> | 18 |
| 5.4.2 | <i>Test setup</i> | 18 |
| 5.4.3 | <i>Test procedure</i> | 19 |
| 5.4.4 | <i>Test results</i> | 19 |
| 5.5 | RADIATED SPURIOUS | 24 |
| 5.5.1 | <i>Limits</i> | 24 |
| 5.5.2 | <i>Test setup</i> | 25 |
| 5.5.3 | <i>Test procedure</i> | 26 |
| 5.5.4 | <i>Test results</i> | 27 |
| 5.5.4.1 | <i>Radiation emission</i> | 27 |
| 5.5.4.2 | <i>Band edge - radiated</i> | 31 |
| 5.6 | BAND EDGE - CONDUCTED | 34 |
| 5.6.1 | <i>Limits</i> | 34 |
| 5.6.2 | <i>Test setup</i> | 34 |
| 5.6.3 | <i>Test procedure</i> | 34 |
| 5.6.4 | <i>Test results</i> | 35 |
| 5.7 | 6dB BANDWIDTH | 38 |
| 5.7.1 | <i>Limit</i> | 38 |
| 5.7.2 | <i>Test setup</i> | 38 |
| 5.7.3 | <i>Test procedure</i> | 38 |
| 5.7.4 | <i>Test results</i> | 38 |
| 5.8 | DUTY CYCLE | 45 |
| 5.8.1 | <i>Limit</i> | 45 |
| 5.8.2 | <i>Measuring instruments</i> | 45 |
| 5.8.3 | <i>Test setup</i> | 45 |



| | | |
|--|---------------------------------------|-----------|
| 5.8.4 | Test procedure..... | 45 |
| 5.8.5 | Test Results..... | 46 |
| 5.9 | SPURIOUS RF CONDUCTED EMISSIONS | 47 |
| 5.9.1 | Limit | 47 |
| 5.9.2 | Measuring instruments..... | 47 |
| 5.9.3 | Test setup | 47 |
| 5.9.4 | Test procedure..... | 47 |
| 5.9.5 | Test results | 47 |
| PHOTOGRAPHS OF THE TEST SETUP | | 50 |
| PHOTOGRAPHS OF THE EUT | | 52 |

Test Result Certification

Applicant's name: NLU Products, LLC dba BGZ brands

Address: 2801 N Thanksgiving Way #300, Lehi, UT 84043, U.S.A.

Manufacture's name: CTT Co., Ltd

Address: Building 2 of Industril park No 197 Xinhua Blvd Tongqiao town Zhongkai High-teck zone Huizhou, Guangdong, China

Product name: 5-in-1 Emergency Hub

Trademark: BodyGuardz

Model name: 5601-00T, 5601-001, 5601-002, 5601-003, 5601-004, 5601-005, 5601-006, 5601-007, 5601-008, 5601-009, 5601-00P, 5601-00A, 5601-00V

Standards: FCC Part 15.247

Test procedure: ANSI C63.10-2013
KDB 558074 D01 D15.247 Meas Guidance v05r02

This device described above has been tested by Shenzhen Microtest Co., Ltd. and the test results show that the equipment under test (EUT) compliance with the FCC requirements. And it is applicable only to the tested sample identified in the report.

Tested by:



Danny Xu

July 06, 2020

Reviewed by:

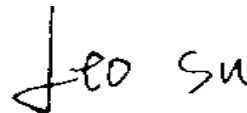

Leo Su

July 30, 2020

Approved by:



Tom Xue

July 30, 2020

1 General information

1.1 Description of EUT

| | |
|--------------------------|--|
| Product name: | 5-in-1 Emergency Hub |
| Model name: | 5601-00T |
| Serial model: | 5601-001, 5601-002, 5601-003, 5601-004, 5601-005, 5601-006, 5601-007, 5601-008, 5601-009, 5601-00P, 5601-00A, 5601-00V |
| Model difference: | All the model are the same circuit and RF module, except the color and model No.. |
| Operation frequency: | 802.11b/g/n20:2412~2462 MHz |
| Modulation type: | IEEE 802.11b : DSSS (DBPSK, DQPSK, CCK) IEEE 802.11g/n (HT20) : OFDM (64QAM, 16QAM, QPSK, BPSK) |
| Bit Rate of transmitter: | 802.11b:11/5.5/2/1 Mbps 802.11g:54/48/36/24/18/12/9/6Mbps 802.11n(20MHz) use 800 ns GI: 65.0/58.5/52.0/39.0/26.0/19.5/13.0/6.5 Mbps (MCS0~MCS7) |
| Antenna type: | PCB Antenna |
| Antenna gain: | 1.7dBi |
| Max. output power: | 14.36dBm |
| Power supply: | AC 120V/60Hz |
| Battery: | DC 3.7V 6600mAh |
| Adapter information: | N/A |
| Hardware version: | V1.2 |
| Software version: | TV5601_ESP32_V2 |
| Serial number: | MTi20031911-5-S0001 |

1.2 Operation channel list

Channel List for 802.11b/g/n (20)

| Channel | Frequency (MHz) | Channel | Frequency (MHz) |
|---------|-----------------|---------|-----------------|
| 01 | 2412 | 07 | 2442 |
| 02 | 2417 | 08 | 2447 |
| 03 | 2422 | 09 | 2452 |
| 04 | 2427 | 10 | 2457 |
| 05 | 2432 | 11 | 2462 |
| 06 | 2437 | \ | \ |
| 06 | 2437 | \ | \ |

1.3 Test channel list

Channel List for 802.11b/g/n (20)

| Channel | Channel | Frequency (MHz) |
|---------|---------|-----------------|
| Low | 01 | 2412 |
| Middle | 06 | 2437 |
| High | 11 | 2462 |

1.4 Ancillary equipment list

| Equipment | Model | S/N | Manufacturer | Certificate type |
|-----------|-------|-----|--------------|------------------|
| / | / | / | / | / |

1.5 Description of Support Units

The EUT has been tested as an independent unit together with other necessary accessories or support units. The following support units or accessories were used to form a representative test configuration during the tests.

| Item | Equipment | Brand | Model/Type No. | Series No. | Note |
|------|-----------|-------|----------------|------------|------|
| / | / | / | / | / | / |
| / | / | / | / | / | / |

Note:

(1) The support equipment was authorized by Declaration of Confirmation.

(2) For detachable type I/O cable should be specified the length in cm in 『Length』 column.

2 Summary of Test Results

Test procedures according to the technical standards:

| No. | Standard Section | Test Item | Result | Remark |
|-----|--|------------------------------------|--------|--------|
| 1 | 15.203 | Antenna Requirement | Pass | |
| 2 | 15.247 (b) | Peak Output Power | Pass | |
| 3 | 15.247 (e) | Power Spectral Density | Pass | |
| 4 | 15.207 | Conducted Emission | Pass | |
| 5 | 15.247 (d) & 15.209 | Radiated Spurious Emission | Pass | |
| 6 | 15.205 | Band Edge Emission | Pass | |
| 7 | 15.247 (a)(2) | 6dB Bandwidth | Pass | |
| 8 | 558074 D01 15.247 Meas Guidance v05r02 Chapter 6 | Duty Cycle | Pass | |
| 9 | 15.247(d) | Spurious RF Conducted Emissions | Pass | |

3 Test Facilities and Accreditations

3.1 Test laboratory

| | |
|-----------------------|---|
| Test Laboratory | Shenzhen Microtest Co., Ltd |
| Location | No.102A & 302A, East Block, Hengfang Industrial Park, Xingye Road, Xixiang, Bao'an District, Shenzhen, Guangdong, China |
| FCC Registration No.: | 448573 |

3.2 Environmental conditions

| | |
|----------------------|--------------|
| Temperature: | 15°C~35°C |
| Humidity | 20%~75% |
| Atmospheric pressure | 98kPa~101kPa |

3.3 Measurement uncertainty

The reported uncertainty of measurement $y \pm U$ where expanded uncertainty U is based on a standard uncertainty multiplied by a coverage factor of $k=2$ providing a level of confidence of approximately 95 %

| No. | Item | Uncertainty |
|-----|-------------------------------|-------------------------|
| 1 | Conducted Emission Test | $\pm 1.38\text{dB}$ |
| 2 | RF power, conducted | $\pm 0.16\text{dB}$ |
| 3 | Spurious emissions, conducted | $\pm 0.21\text{dB}$ |
| 4 | All emissions, radiated(<1G) | $\pm 4.68\text{dB}$ |
| 5 | All emissions, radiated(>1G) | $\pm 4.89\text{dB}$ |
| 6 | Temperature | $\pm 0.5^\circ\text{C}$ |
| 7 | Humidity | $\pm 2\%$ |

3.4 Test software

| Software Name | Manufacturer | Model | Version |
|--------------------------------|-------------------------------|----------|-------------|
| Bluetooth and WiFi Test System | Shenzhen JS tonskend co., ltd | JS1120-3 | 2.5.77.0418 |

4 Equipment list

| Equipment No. | Equipment Name | Manufacturer | Model | Serial No. | Calibration date | Due date |
|---------------|--|-------------------------------|----------------|------------|------------------|------------|
| MTI-E004 | EMI Test Receiver | Rohde&schwarz | ESPI7 | 100314 | 2019/10/09 | 2020/10/08 |
| MTI-E006 | TRILOG Broadband Antenna | schwarzbeck | VULB 9163 | 9163-872 | 2019/10/15 | 2020/10/14 |
| MTI-E014 | amplifier | Hewlett-Packard | 8447D | 3113A06150 | 2019/10/09 | 2020/10/08 |
| MTI-E036 | Single path vehicle AMN(LISN) | Schwarzbeck | NNBM 8124 | 01175 | 2019/10/09 | 2020/10/08 |
| MTI-E038 | Low noise active vertical monopole antenna | Schwarzbeck | VAMP 9243 | #565 | 2019/10/16 | 2020/10/15 |
| MTI-E039 | Biconical antenna | Schwarzbeck | BBA 9106 | #164 | 2019/10/15 | 2020/10/14 |
| MTI-E041 | MXG Vector Signal Generator | Agilent | N5182A | MY49060455 | 2020/04/16 | 2021/04/15 |
| MTI-E042 | ESG Series Analog signal generator | Agilent | E4421B | GB40051240 | 2020/05/21 | 2021/05/20 |
| MTI-E044 | Thermometer clock humidity monitor | - | HTC-1 | / | 2020/04/17 | 2021/04/16 |
| MTI-E062 | Log Periodic Antenna | Schwarzbeck | VUSLP 9111B | #312 | 2020/04/11 | 2022/04/10 |
| MTI-E063 | Log Periodic Dipole Array Antenna | ETS-LINDGREN | 3148B | 00224524 | 2020/04/11 | 2022/04/10 |
| MTI-E065 | Amplifier | EMtrace | RP06A | 00117 | 2020/04/29 | 2021/04/28 |
| MTI-E071 | PXA Signal Analyzer | Agilent | N9030A | MY51350296 | 2020/10/25 | 2021/10/24 |
| MTI-E076 | EMI Test Receiver | Rohde&schwarz | ESIB26 | 100273 | 2020/04/16 | 2021/04/15 |
| MTI-E078 | Synthesized Sweeper | Agilent | 83752A | 3610A01957 | 2020/04/16 | 2021/04/15 |
| MTI-E079 | DC Power Supply | Agilent | E3632A | MY40027695 | 2020/04/16 | 2021/04/15 |
| MTI-E093 | Artificial mains network | 3ctest | LISN J50 | ES3911805 | 2020/04/16 | 2021/04/15 |
| MTI-E096 | Power amplifier | Space-Dtronics | EWLNA0118G-P40 | 1852001 | 2020/04/29 | 2021/04/28 |
| MTI-E097 | Current Probe | SOLAR ELECTRONICS CO. | 9207-1 | 220095-1 | 2020/04/17 | 2021/04/16 |
| MTI-E098 | Loop Sensor | SOLAR ELECTRONICS CO. | 7334-1 | 220095-2 | 2020/04/21 | 2021/04/20 |
| MTI-E081 | EPM Series Power Meter | Agilent | E4419B | MY50000438 | 2020/04/16 | 2021/04/15 |
| MTI-E052 | 18-40GHz amplifier | Chengdu step Micro Technology | ZLNA-18-40G-21 | 1608001 | 2020/04/16 | 2021/04/15 |



| | | | | | | |
|----------|--------------------------|-------------|----------|-------------|------------|------------|
| MTI-E053 | 15-40G Antenna | Schwarzbeck | BBHA9170 | BBHA9170582 | 2019/04/16 | 2021/04/15 |
| MTI-E058 | Artificial power network | Schwarzbeck | NSLK8127 | #841 | 2019/04/16 | 2021/04/15 |
| MTI-E109 | Band Reject Filter Group | Tonscend | JS0806-F | 19D8060160 | 2019/04/16 | 2021/04/15 |

Note: the calibration interval of the above test instruments is 12 or 24 months and the calibrations are traceable to international system unit (SI).

5 Test Result

5.1 Antenna requirement

5.1.1 Standard requirement

15.203 requirement: For intentional device, according to 15.203: an intentional radiator shall be designed to ensure that no antenna other than that furnished by the responsible party shall be used with the device

5.1.2 EUT antenna

The EUT antenna is PCB antenna (1.7dBi). It comply with the standard requirement. In case of replacement of broken antenna the same antenna type must be used.

5.2 Peak output power

5.2.1 Limit

| Section | Test Item | Limit | Frequency Range (MHz) |
|--------------|-------------------|-----------------|-----------------------|
| 15.247(b)(3) | Peak output power | 1 watt or 30dBm | 2400-2483.5 |

5.2.2 Test setup

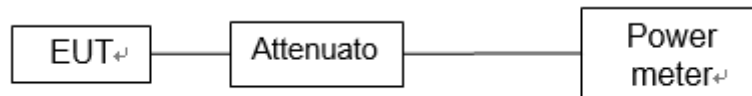

5.2.3 Test procedure

The EUT was directly connected to the Power meter.

5.2.4 Test results
802.11b

| Test Channel | Frequency (MHz) | Maximum Peak Conducted Output Power(dBm) | Limit (dBm) |
|--------------|-----------------|--|-------------|
| CH01 | 2412 | 13.84 | 30 |
| CH06 | 2437 | 14.36 | 30 |
| CH11 | 2462 | 14.25 | 30 |

802.11g

| Test Channel | Frequency (MHz) | Maximum Peak Conducted Output Power(dBm) | Limit (dBm) |
|--------------|-----------------|--|-------------|
| CH01 | 2412 | 12.43 | 30 |
| CH06 | 2437 | 12.50 | 30 |
| CH11 | 2462 | 12.23 | 30 |

802.11n20

| Test Channel | Frequency (MHz) | Maximum Peak Conducted Output Power(dBm) | Limit (dBm) |
|--------------|-----------------|--|-------------|
| CH01 | 2412 | 12.39 | 30 |
| CH06 | 2437 | 12.37 | 30 |
| CH11 | 2462 | 12.18 | 30 |

5.3 Power spectral density

5.3.1 Limit

| Section | Test Item | Limit | Frequency Range (MHz) |
|-----------|------------------------|------------------------|-----------------------|
| 15.247(e) | Power Spectral Density | 8 dBm (in any 3kHz) | 2400-2483.5 |

5.3.2 Test setup



5.3.3 Test procedure

- a. The EUT tested system was configured as the statements of 2.1 unless otherwise a special operating condition is specified in the follows during the testing.
- b. Set analyzer center frequency to DTS channel center frequency.
- c. Set the span to 1.5 times the DTS channel bandwidth.
- d. Set the RBW ≥ 3 kHz.
- e. Set the VBW $\geq 3 \times$ RBW.
- f. Detector = peak.
- g. Sweep time = auto couple.
- h. Trace mode = max hold.
- i. Allow trace to fully stabilize.
- j. Use the peak marker function to determine the maximum amplitude level.
- k. If measured value exceeds limit, reduce RBW (no less than 3 kHz) and repeat.

5.3.4 Test results

| 802.11b | | | |
|-----------|--------------------------|------------------|--------|
| Frequency | Power Density (dBm/3kHz) | Limit (dBm/3kHz) | Result |
| 2412 MHz | -8.762 | 8 | Pass |
| 2437 MHz | -7.945 | 8 | Pass |
| 2462 MHz | -7.040 | 8 | Pass |

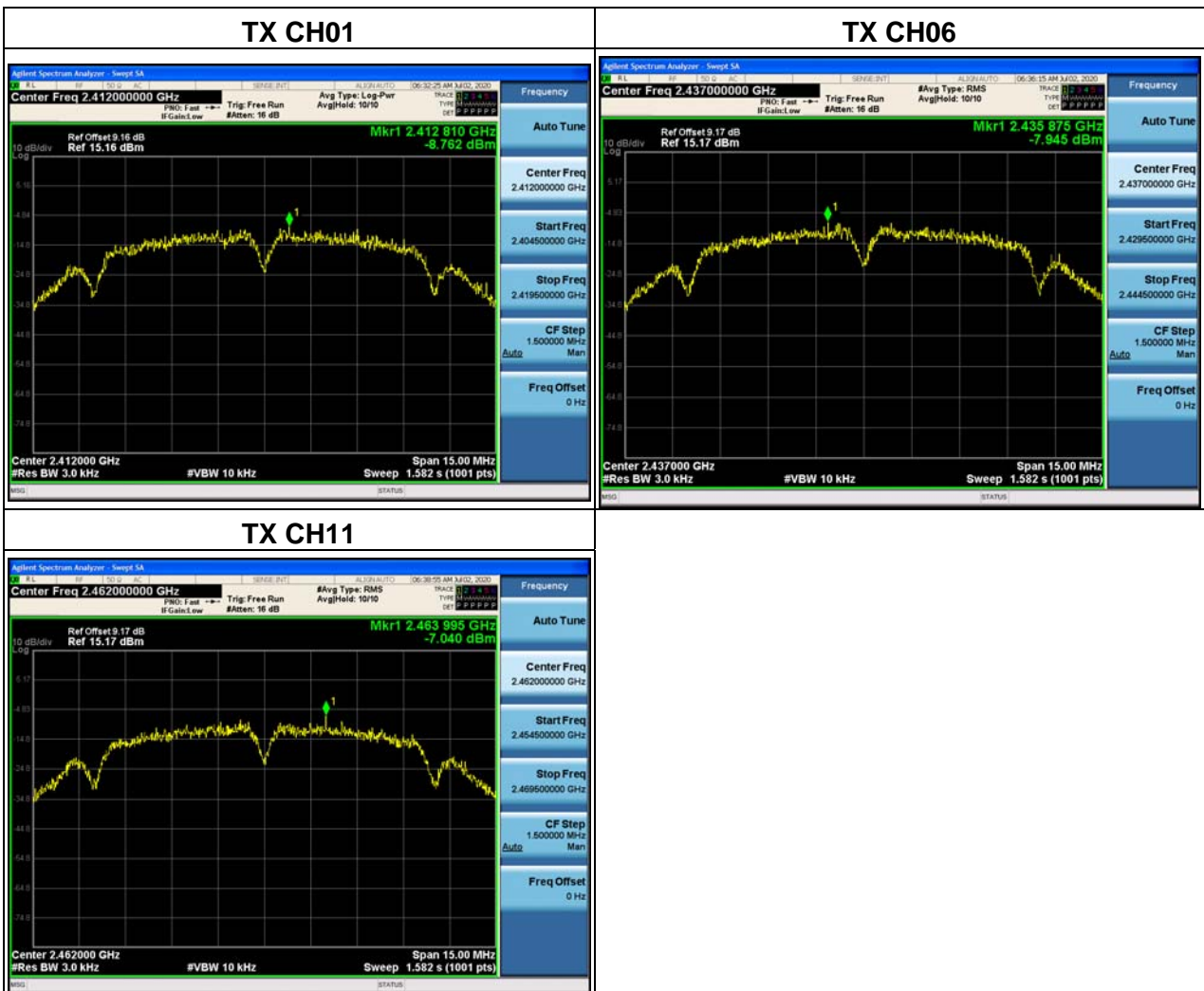

| 802.11g | | | |
|-----------|--------------------------|------------------|--------|
| Frequency | Power Density (dBm/3kHz) | Limit (dBm/3kHz) | Result |
| 2412 MHz | -15.261 | 8 | Pass |
| 2437 MHz | -11.617 | 8 | Pass |
| 2462 MHz | -12.422 | 8 | Pass |

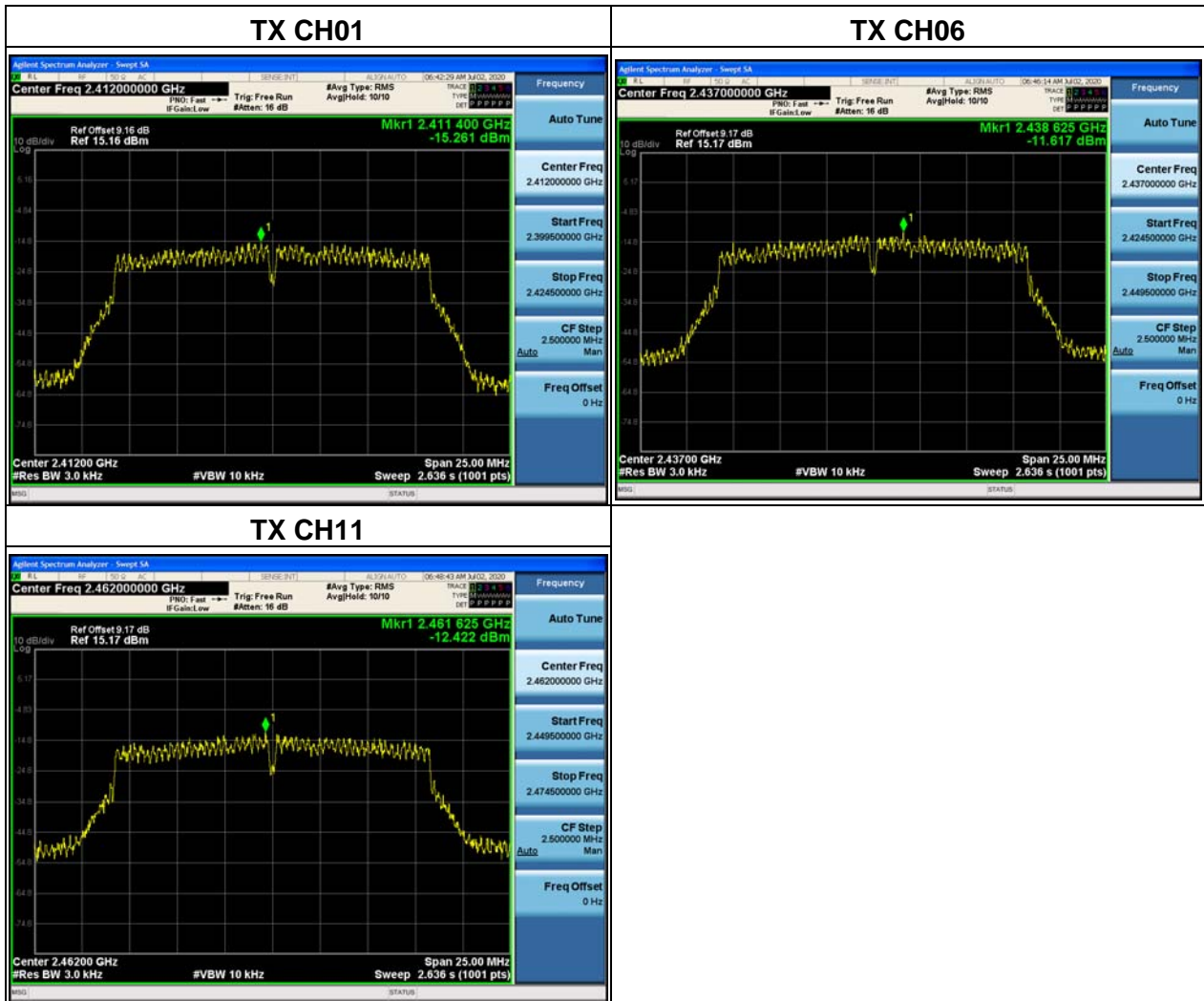

| 802.11n20 | | | |
|-----------|--------------------------|------------------|--------|
| Frequency | Power Density (dBm/3kHz) | Limit (dBm/3kHz) | Result |
| 2412 MHz | -15.384 | 8 | Pass |
| 2437 MHz | -12.292 | 8 | Pass |
| 2462 MHz | -11.727 | 8 | Pass |

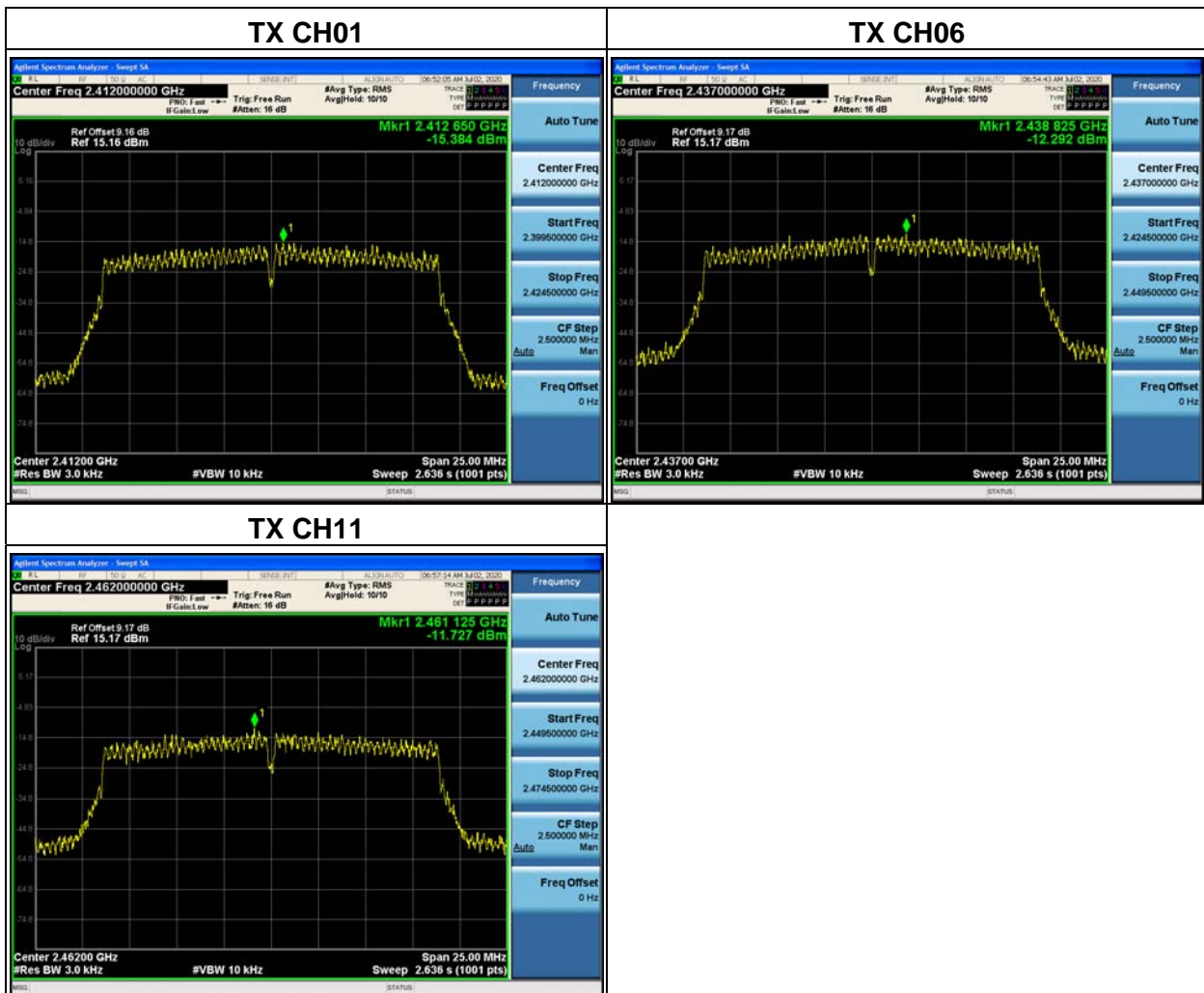

5.4 Conducted emission

5.4.1 Limits

According to FCC Part 15.207(a) and KDB 174176 D01 Line Conducted FAQ v01r01.

| FREQUENCY (MHz) | Class B (dBuV) | |
|-----------------|----------------|-----------|
| | Quasi-peak | Average |
| 0.15 -0.5 | 66 - 56 * | 56 - 46 * |
| 0.50 -5.0 | 56.00 | 46.00 |
| 5.0 -30.0 | 60.00 | 50.00 |

Note: *Decreases with the logarithm of the frequency.

5.4.2 Test setup

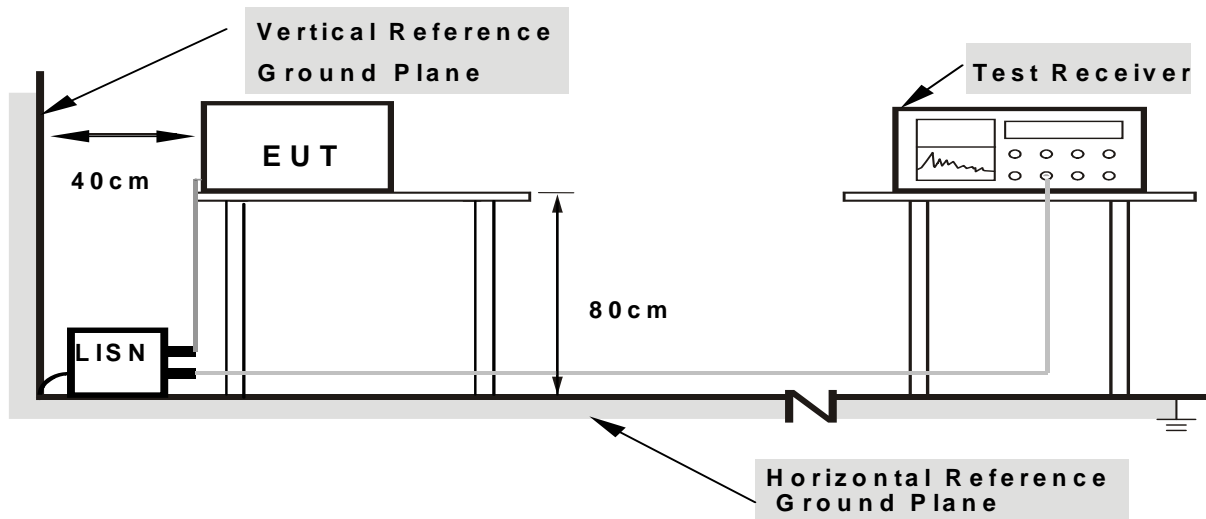

Note: 1. Support units were connected to second LISN.

2. Both of LISNs (AMN) are 80 cm from EUT and at least 80 cm from other units and other metal planes

5.4.3 Test procedure

a. EUT Operating Conditions

The EUT was configured for testing in a typical fashion (as a customer would normally use it). The EUT has been programmed to continuously transmit during test. This operating condition was tested and used to collect the included data.

b. The following table is the setting of the receiver

| Receiver Parameters | Setting |
|---------------------|----------|
| Attenuation | 10 dB |
| Start Frequency | 0.15 MHz |
| Stop Frequency | 30 MHz |
| IF Bandwidth | 9 kHz |

- c. The EUT was placed 0.8 meters from the horizontal ground plane with EUT being connected to the power mains through a line impedance stabilization network (LISN). All other support equipments powered from additional LISN(s). The LISN provide 50 Ohm/ 50uH of coupling impedance for the measuring instrument.
- d. Interconnecting cables that hang closer than 40 cm to the ground plane shall be folded back and forth in the center forming a bundle 30 to 40 cm long.
- e. I/O cables that are not connected to a peripheral shall be bundled in the center. The end of the cable may be terminated, if required, using the correct terminating impedance. The overall length shall not exceed 1 m.
- f. LISN at least 80 cm from nearest part of EUT chassis.

For the actual test configuration, please refer to the related Item –EUT Test Photos.

5.4.4 Test results

Note:

1: All the modulation modes have been tested, the report only shows the worst mode. The worst mode is 802.11b CH06

2: Emission Level = Reading Level + Factor, Margin = Emission Level - Limit, Factor = LISN modulus + Cable Loss

Test data

| | | | |
|---------------|----------------------|-------------|----------|
| EUT: | 5-in-1 Emergency Hub | Model Name: | 5601-00T |
| Pressure: | 1010hPa | Phase:: | L |
| Test Voltage: | AC 120V/60Hz | Test Mode: | TX |

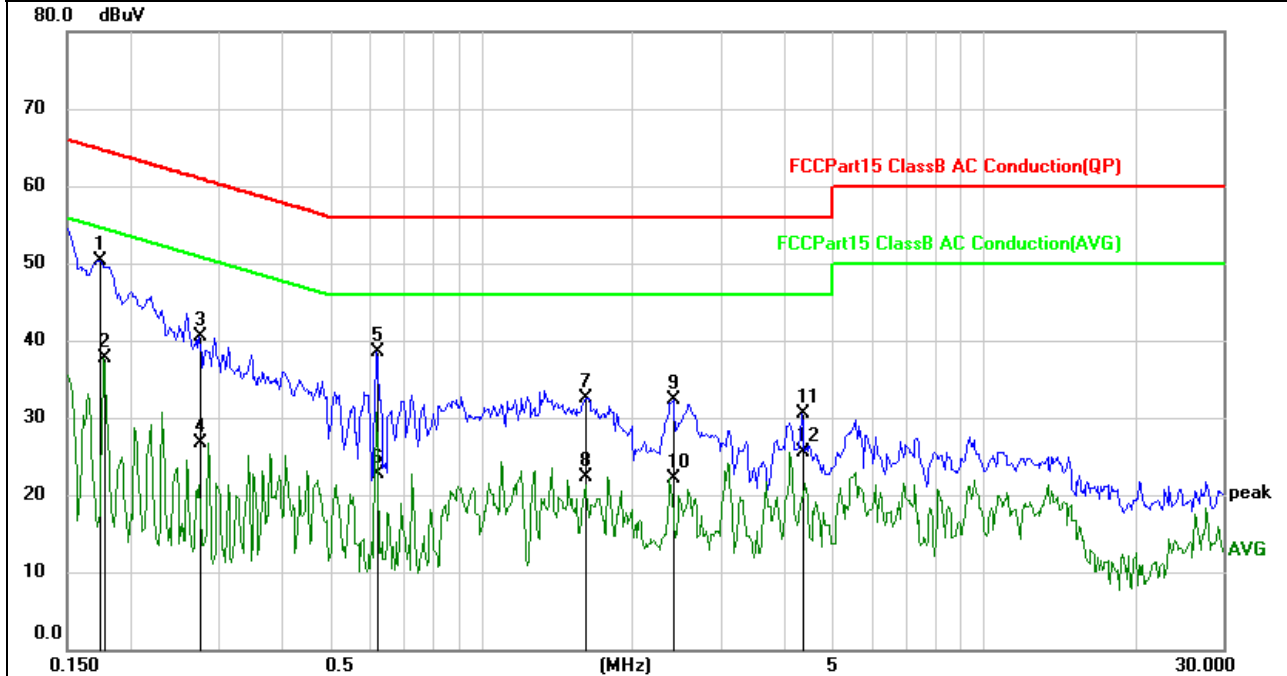

| No. | Mk. | Freq. MHz | Reading Level dBuV | Correct Factor dB | Measure- ment dBuV | Limit dBuV | Over dB | Detector |
|-----|-----|--------------|--------------------------|-------------------------|--------------------------|---------------|------------|----------|
| 1 | * | 0.1733 | 40.62 | 9.73 | 50.35 | 64.80 | -14.45 | QP |
| 2 | | 0.1773 | 27.94 | 9.73 | 37.67 | 54.61 | -16.94 | AVG |
| 3 | | 0.2750 | 30.84 | 9.75 | 40.59 | 60.97 | -20.38 | QP |
| 4 | | 0.2750 | 16.90 | 9.75 | 26.65 | 50.97 | -24.32 | AVG |
| 5 | | 0.6187 | 28.60 | 9.89 | 38.49 | 56.00 | -17.51 | QP |
| 6 | | 0.6187 | 12.87 | 9.89 | 22.76 | 46.00 | -23.24 | AVG |
| 7 | | 1.6108 | 22.59 | 9.96 | 32.55 | 56.00 | -23.45 | QP |
| 8 | | 1.6108 | 12.42 | 9.96 | 22.38 | 46.00 | -23.62 | AVG |
| 9 | | 2.4155 | 22.32 | 9.98 | 32.30 | 56.00 | -23.70 | QP |
| 10 | | 2.4155 | 12.09 | 9.98 | 22.07 | 46.00 | -23.93 | AVG |
| 11 | | 4.3437 | 20.49 | 10.04 | 30.53 | 56.00 | -25.47 | QP |
| 12 | | 4.3437 | 15.40 | 10.04 | 25.44 | 46.00 | -20.56 | AVG |

| | | | |
|---------------|----------------------|-------------|----------|
| EUT: | 5-in-1 Emergency Hub | Model Name: | 5601-00T |
| Pressure: | 1010hPa | Phase:: | N |
| Test Voltage: | AC 120V/60Hz | Test Mode: | TX |

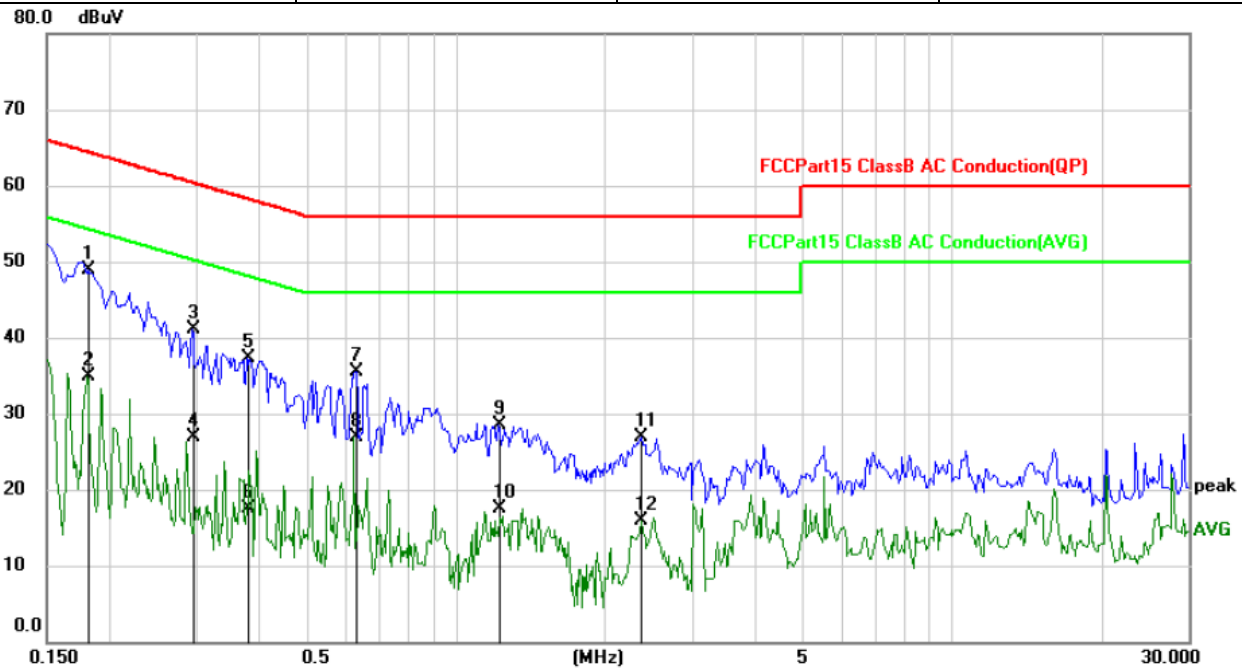

| No. | Mk. | Freq. | Reading Level | Correct Factor | Measurement | Limit | Over | Detector |
|-----|-----|--------|---------------|----------------|-------------|-------|--------|----------|
| | | MHz | dBuV | dB | dBuV | dBuV | dB | |
| 1 | * | 0.1814 | 39.26 | 9.73 | 48.99 | 64.42 | -15.43 | QP |
| 2 | | 0.1814 | 25.23 | 9.73 | 34.96 | 54.42 | -19.46 | AVG |
| 3 | | 0.2943 | 31.27 | 9.75 | 41.02 | 60.40 | -19.38 | QP |
| 4 | | 0.2943 | 17.25 | 9.75 | 27.00 | 50.40 | -23.40 | AVG |
| 5 | | 0.3803 | 27.45 | 9.81 | 37.26 | 58.27 | -21.01 | QP |
| 6 | | 0.3803 | 7.72 | 9.81 | 17.53 | 48.27 | -30.74 | AVG |
| 7 | | 0.6301 | 25.63 | 9.90 | 35.53 | 56.00 | -20.47 | QP |
| 8 | | 0.6301 | 17.07 | 9.90 | 26.97 | 46.00 | -19.03 | AVG |
| 9 | | 1.2200 | 18.54 | 9.95 | 28.49 | 56.00 | -27.51 | QP |
| 10 | | 1.2200 | 7.58 | 9.95 | 17.53 | 46.00 | -28.47 | AVG |
| 11 | | 2.3687 | 16.93 | 9.98 | 26.91 | 56.00 | -29.09 | QP |
| 12 | | 2.3687 | 5.89 | 9.98 | 15.87 | 46.00 | -30.13 | AVG |

| | | | |
|---------------|----------------------|-------------|----------|
| EUT: | 5-in-1 Emergency Hub | Model Name: | 5601-00T |
| Pressure: | 1010hPa | Phase: | L |
| Test Voltage: | AC 240V/60Hz | Test Mode: | TX |

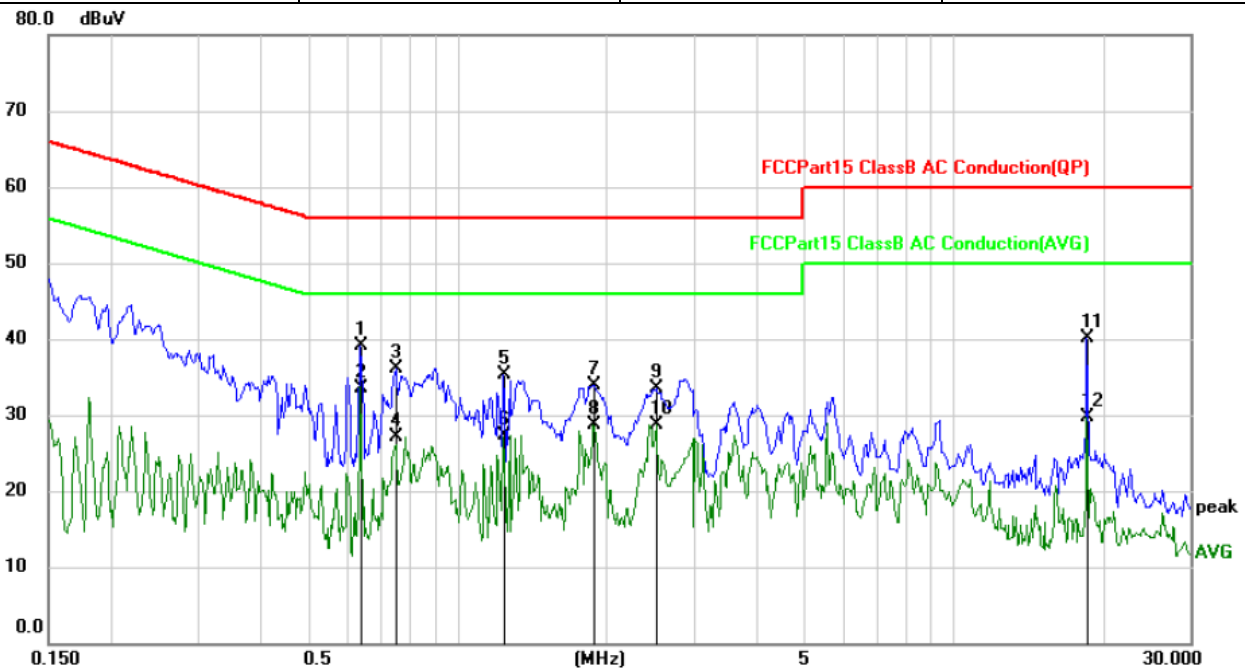

| No. | Mk. | Freq. MHz | Reading Level dBuV | Correct Factor dB | Measure- ment dBuV | Limit dBuV | Over dB | Detector |
|-----|-----|--------------|--------------------------|-------------------------|--------------------------|---------------|------------|----------|
| 1 | | 0.6381 | 29.23 | 9.90 | 39.13 | 56.00 | -16.87 | QP |
| 2 | * | 0.6381 | 23.70 | 9.90 | 33.60 | 46.00 | -12.40 | AVG |
| 3 | | 0.7511 | 26.14 | 9.91 | 36.05 | 56.00 | -19.95 | QP |
| 4 | | 0.7511 | 17.29 | 9.91 | 27.20 | 46.00 | -18.80 | AVG |
| 5 | | 1.2398 | 25.33 | 9.96 | 35.29 | 56.00 | -20.71 | QP |
| 6 | | 1.2398 | 17.35 | 9.96 | 27.31 | 46.00 | -18.69 | AVG |
| 7 | | 1.8843 | 24.01 | 9.97 | 33.98 | 56.00 | -22.02 | QP |
| 8 | | 1.8843 | 18.71 | 9.97 | 28.68 | 46.00 | -17.32 | AVG |
| 9 | | 2.5171 | 23.59 | 9.98 | 33.57 | 56.00 | -22.43 | QP |
| 10 | | 2.5171 | 18.81 | 9.98 | 28.79 | 46.00 | -17.21 | AVG |
| 11 | | 18.5504 | 29.98 | 10.12 | 40.10 | 60.00 | -19.90 | QP |
| 12 | | 18.5504 | 19.66 | 10.12 | 29.78 | 50.00 | -20.22 | AVG |

| | | | |
|---------------|----------------------|-------------|----------|
| EUT: | 5-in-1 Emergency Hub | Model Name: | 5601-00T |
| Pressure: | 1010hPa | Phase: | N |
| Test Voltage: | AC 240V/60Hz | Test Mode: | TX |

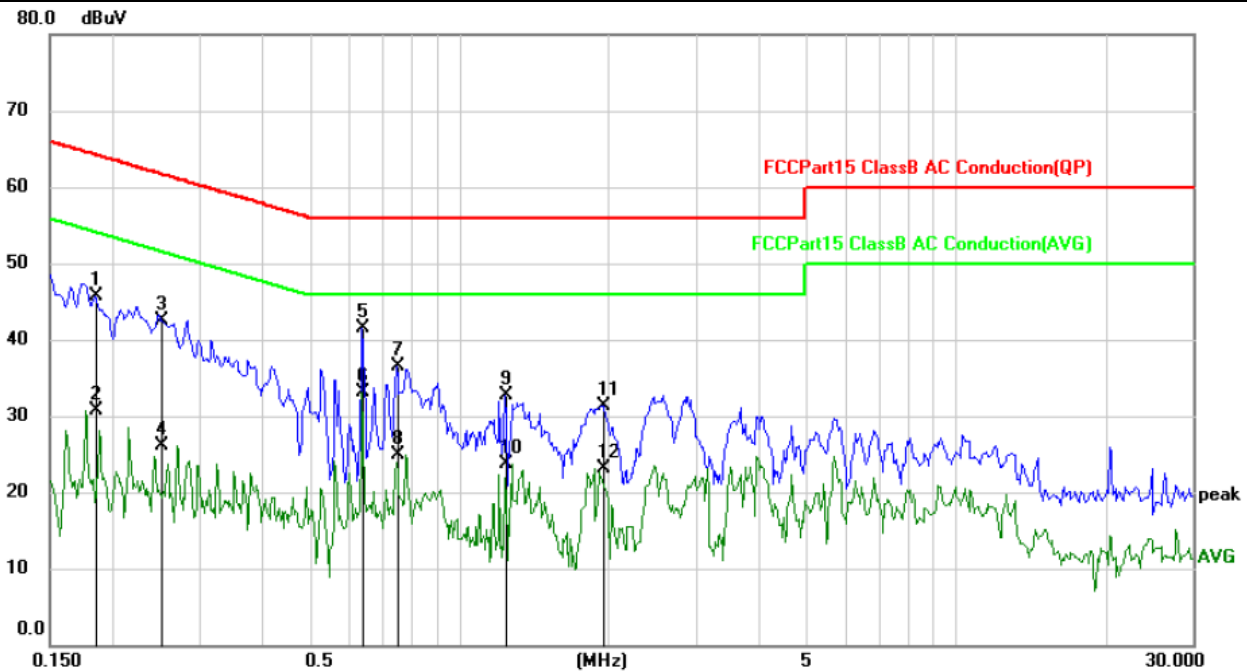

| No. | Mk. | Freq. | Reading Level | Correct Factor | Measurement | Limit | Over | Detector |
|-----|-----|--------|---------------|----------------|-------------|-------|--------|----------|
| | | MHz | dBuV | dB | dBuV | dBuV | dB | |
| 1 | | 0.1849 | 35.92 | 9.73 | 45.65 | 64.26 | -18.61 | QP |
| 2 | | 0.1849 | 21.01 | 9.73 | 30.74 | 54.26 | -23.52 | AVG |
| 3 | | 0.2515 | 32.72 | 9.73 | 42.45 | 61.71 | -19.26 | QP |
| 4 | | 0.2515 | 16.39 | 9.73 | 26.12 | 51.71 | -25.59 | AVG |
| 5 | | 0.6381 | 31.63 | 9.90 | 41.53 | 56.00 | -14.47 | QP |
| 6 | * | 0.6381 | 23.18 | 9.90 | 33.08 | 46.00 | -12.92 | AVG |
| 7 | | 0.7476 | 26.67 | 9.91 | 36.58 | 56.00 | -19.42 | QP |
| 8 | | 0.7476 | 14.93 | 9.91 | 24.84 | 46.00 | -21.16 | AVG |
| 9 | | 1.2398 | 22.78 | 9.96 | 32.74 | 56.00 | -23.26 | QP |
| 10 | | 1.2398 | 13.77 | 9.96 | 23.73 | 46.00 | -22.27 | AVG |
| 11 | | 1.9543 | 21.31 | 9.97 | 31.28 | 56.00 | -24.72 | QP |
| 12 | | 1.9543 | 13.19 | 9.97 | 23.16 | 46.00 | -22.84 | AVG |

5.5 Radiated spurious

5.5.1 Limits

20dBc in any 100 kHz bandwidth outside the operating frequency band. In case the emission fall within the restricted band specified on 15.205(a), then the 15.209(a) limit in the table below has to be followed.

| Frequency (MHz) | Field Strength (micovolts/meter) | Measurement Distance (meters) |
|-----------------|----------------------------------|-------------------------------|
| 0.009~0.490 | 2400/F(kHz) | 300 |
| 0.490~1.705 | 24000/F(kHz) | 30 |
| 1.705~30.0 | 30 | 30 |
| 30~88 | 100 | 3 |
| 88~216 | 150 | 3 |
| 216~960 | 200 | 3 |
| Above 960 | 500 | 3 |

| Spectrum Parameter | Setting |
|---------------------------------------|--|
| Attenuation | Auto |
| Start Frequency | 1000 MHz |
| Stop Frequency | 10th carrier harmonic |
| RB / VB (emission in restricted band) | 1 MHz / 1 MHz for Peak, 1 MHz / 10Hz for Average |

| Receiver Parameter | Setting |
|------------------------|----------------------------------|
| Attenuation | Auto |
| Start ~ Stop Frequency | 9kHz~150kHz / RB 200Hz for QP |
| Start ~ Stop Frequency | 150kHz~30MHz / RB 9kHz for QP |
| Start ~ Stop Frequency | 30MHz~1000MHz / RB 120kHz for QP |

5.5.2 Test setup

Radiated emission test-up frequency below 30MHz

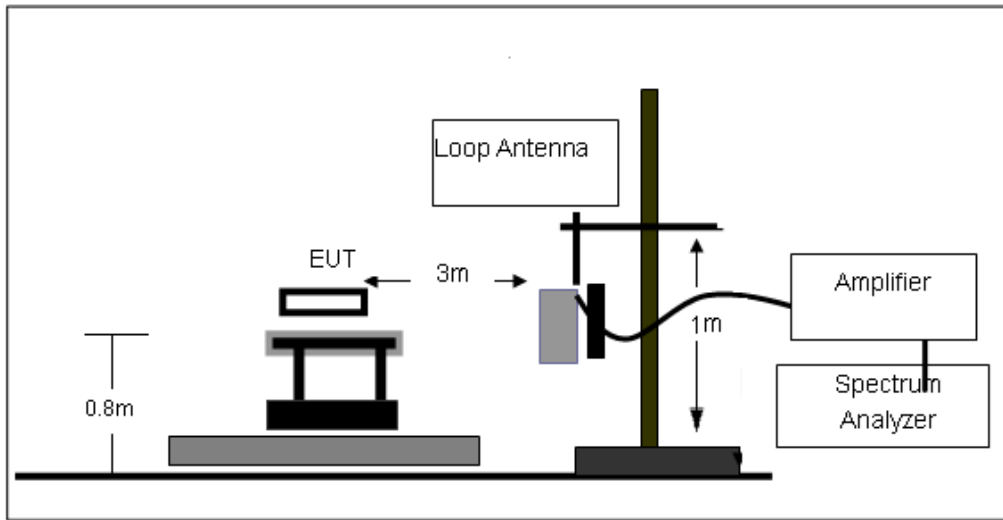

Radiated emission test-up frequency 30MHz~1GHz

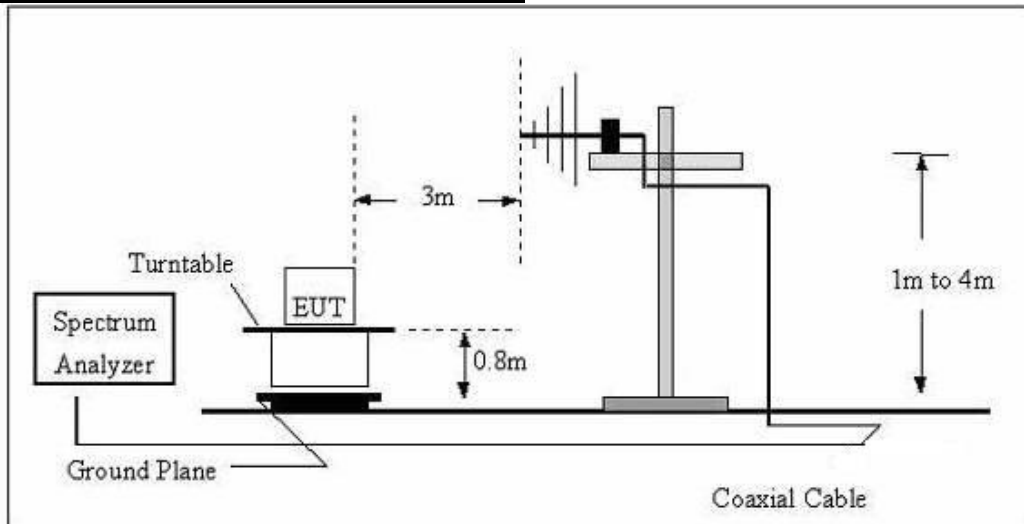

Radiated emission test-up frequency above 1GHz

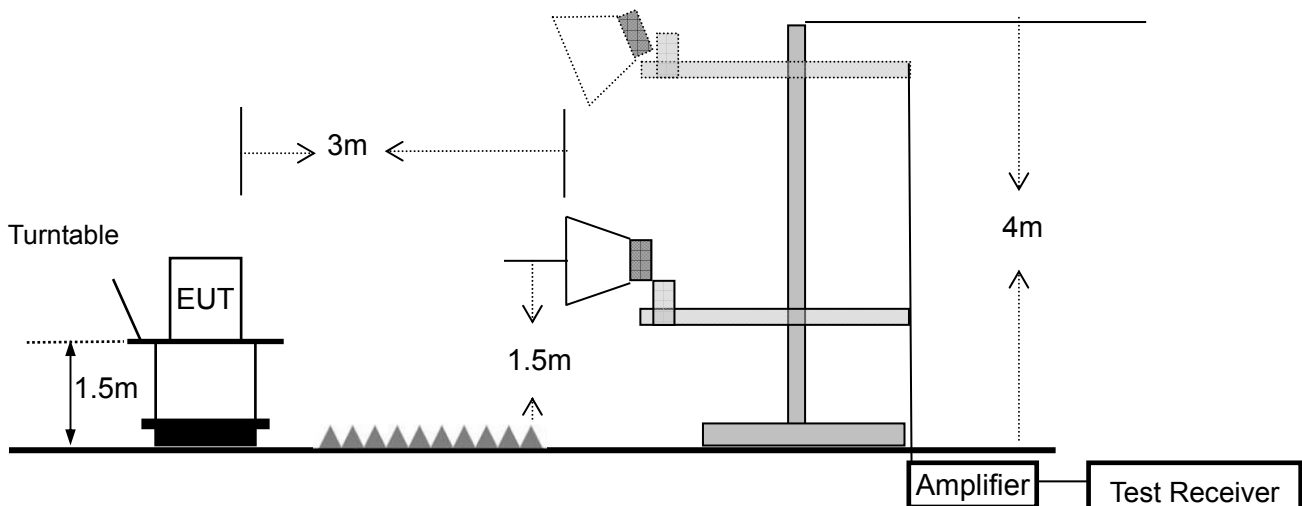

5.5.3 Test procedure

- a. EUT operating conditions. The EUT tested system was configured as the statements of 2.4 unless otherwise a special operating condition is specified in the follows during the testing.
- b. The measuring distance of at 3 m shall be used for measurements at frequency up to 1GHz. For frequencies above 1GHz, any suitable measuring distance may be used.
- c. The EUT was placed on the top of a rotating table 0.8 meters above the ground at a 3 meter open area test site. The table was rotated 360 degrees to determine the position of the highest radiation.
- d. The height of the equipment or of the substitution antenna shall be 0.8 m; the height of the test antenna shall vary between 1 m to 4 m. Both horizontal and vertical polarizations of the antenna are set to make the measurement.
- e. For emission measurements above 1 GHz, the EUT shall be placed at a height of 1.5 m above the floor on a support that is RF transparent for the frequencies of interest. Final measurements for the EUT require a measurement antenna height scan of 1 m to 4 m.
- f. The initial step in collecting conducted emission data is a spectrum analyzer peak detector mode pre-scanning the measurement frequency range. Significant peaks are then marked and then Quasi Peak detector mode re-measured.
- g. If the Peak Mode measured value compliance with and lower than Quasi Peak Mode Limit, the EUT shall be deemed to meet QP Limits and then no additional QP Mode measurement performed.
- h. For the actual test configuration, please refer to the related Item –EUT Test photos.

Note: Both horizontal and vertical antenna polarities were tested and performed pretest to three orthogonal axis. The worst case emissions were reported

5.5.4 Test results

5.5.4.1 Radiation emission

Below 30MHz

| | | | |
|------------|----------------------|---------------|--------------|
| EUT: | 5-in-1 Emergency Hub | Model Name: | 5601-00T |
| Pressure: | 1010 hPa | Phase: | H |
| Test Mode: | TX | Test Voltage: | AC 120V/60Hz |

| Freq. | Reading | Limit | Margin | State |
|-------|----------|----------|--------|-------|
| (MHz) | (dBuV/m) | (dBuV/m) | (dB) | P/F |
| -- | -- | -- | -- | Pass |
| -- | -- | -- | -- | Pass |

Note:

For 9k-30MHz, the amplitude of spurious emissions which are attenuated by more than 20dB below the permissible value has no need to be reported.

Distance extrapolation factor = $40 \log(\text{specific distance}/\text{test distance})$ (dB);

Limit line = specific limits (dBuV) + distance extrapolation factor.

Between 30MHz – 1GHz

Note1: Emission Level = Meter Reading + Factor, Margin= Emission Level- Limit, Factor = Antenna Factor + Cable Loss – Pre-amplifier.

Note2: The three modulated high, medium and low channels have been tested. The report only shows the worst mode. The worst mode is 802.11b CH06.

| | | | |
|------------|----------------------|---------------|--------------|
| EUT: | 5-in-1 Emergency Hub | Model Name: | 5601-00T |
| Pressure: | 1010 hPa | Phase: | H |
| Test Mode: | TX | Test Voltage: | AC 120V/60Hz |

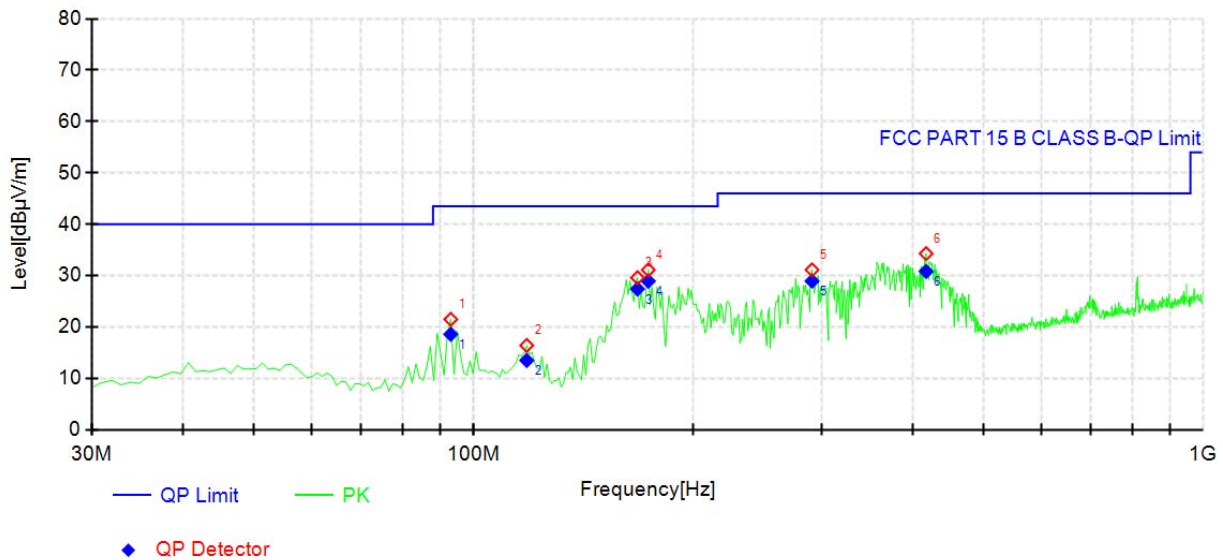

| NO. | Freq. [MHz] | Factor [dB] | QP Value [dBµV/m] | QP Limit [dBµV/m] | QP Margin [dB] | Height [cm] | Angle [°] | Polarity |
|-----|-------------|-------------|-------------------|-------------------|----------------|-------------|-----------|------------|
| 1 | 93.0500 | -16.11 | 18.58 | 43.50 | 24.92 | 200 | 165 | Horizontal |
| 2 | 118.2700 | -16.03 | 13.49 | 43.50 | 30.01 | 200 | 133 | Horizontal |
| 3 | 167.7400 | -16.50 | 27.40 | 43.50 | 16.10 | 100 | 136 | Horizontal |
| 4 | 173.5600 | -16.20 | 28.92 | 43.50 | 14.58 | 200 | 138 | Horizontal |
| 5 | 290.9300 | -11.13 | 28.93 | 46.00 | 17.07 | 100 | 143 | Horizontal |
| 6 | 417.0300 | -9.17 | 30.81 | 46.00 | 15.19 | 200 | 203 | Horizontal |



| | | | |
|------------|----------------------|---------------|--------------|
| EUT: | 5-in-1 Emergency Hub | Model Name: | 5601-00T |
| Pressure: | 1010 hPa | Phase: | V |
| Test Mode: | TX | Test Voltage: | AC 120V/60Hz |

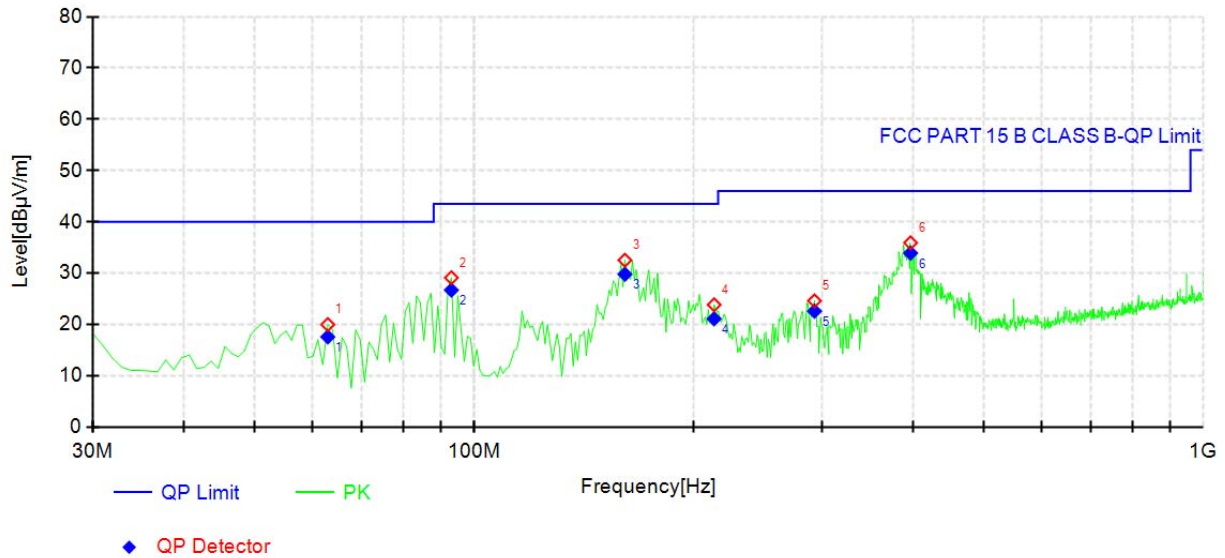

| NO. | Freq. [MHz] | Factor [dB] | QP Value [dBµV/m] | QP Limit [dBµV/m] | QP Margin [dB] | Height [cm] | Angle [°] | Polarity |
|-----|-------------|-------------|-------------------|-------------------|----------------|-------------|-----------|----------|
| 1 | 62.9800 | -15.99 | 17.56 | 40.00 | 22.44 | 100 | 176 | Vertical |
| 2 | 93.0500 | -16.11 | 26.69 | 43.50 | 16.81 | 100 | 304 | Vertical |
| 3 | 160.9500 | -16.84 | 29.78 | 43.50 | 13.72 | 100 | 227 | Vertical |
| 4 | 213.3300 | -13.63 | 21.09 | 43.50 | 22.41 | 100 | 47 | Vertical |
| 5 | 292.8700 | -11.07 | 22.58 | 46.00 | 23.42 | 100 | 86 | Vertical |
| 6 | 396.6600 | -9.55 | 33.89 | 46.00 | 12.11 | 100 | 40 | Vertical |

1-25GHz

Note:

- (1) Emission Level= Antenna Factor + Cable Loss + Read Level - Preamp Factor
- (2) All other emissions more than 20dB below the limit.
- (3) The three modulated high, medium and low channels have been tested. The report only shows the worst mode. The worst mode is 802.11b.

All the modulation modes have been tested, and the worst result was report as below:

| Frequency (MHz) | Read Level (dBμV) | Cable loss (dB) | Antenna Factor dB/m | Preamp Factor (dB) | Emission Level (dBμV/m) | Limits (dBμV/m) | Margin (dB) | Remark | Comment |
|---|-------------------------|-----------------------|---------------------------|--------------------------|-------------------------------|--------------------|----------------|--------|------------|
| Low Channel (2412 MHz)(802.11b)--Above 1G | | | | | | | | | |
| 4824.161 | 63.46 | 4.36 | 32.92 | 45.53 | 55.21 | 74.00 | -18.79 | Pk | Vertical |
| 4824.161 | 43.81 | 4.36 | 32.92 | 45.53 | 35.56 | 54.00 | -18.44 | AV | Vertical |
| 7236.396 | 60.45 | 5.02 | 37.63 | 45.56 | 57.54 | 74.00 | -16.46 | Pk | Vertical |
| 7236.396 | 40.71 | 5.02 | 37.63 | 45.56 | 37.80 | 54.00 | -16.20 | AV | Vertical |
| 4824.154 | 62.49 | 4.36 | 32.92 | 45.53 | 54.24 | 74.00 | -19.76 | Pk | Horizontal |
| 4824.154 | 43.08 | 4.36 | 32.92 | 45.53 | 34.83 | 54.00 | -19.17 | AV | Horizontal |
| 7236.168 | 64.20 | 5.02 | 37.63 | 45.56 | 61.29 | 74.00 | -12.71 | Pk | Horizontal |
| 7236.168 | 42.97 | 5.02 | 37.63 | 45.56 | 40.06 | 54.00 | -13.94 | AV | Horizontal |
| Middle Channel (2437 MHz)(802.11b)--Above 1G | | | | | | | | | |
| 4874.112 | 62.99 | 4.41 | 33.01 | 45.76 | 54.65 | 74.00 | -19.35 | Pk | Vertical |
| 4874.112 | 43.82 | 4.41 | 33.01 | 45.76 | 35.48 | 54.00 | -18.52 | AV | Vertical |
| 7311.247 | 60.27 | 5.02 | 37.68 | 45.59 | 57.38 | 74.00 | -16.62 | Pk | Vertical |
| 7311.247 | 41.33 | 5.02 | 37.68 | 45.59 | 38.44 | 54.00 | -15.56 | AV | Vertical |
| 4874.132 | 62.67 | 4.41 | 33.01 | 45.76 | 54.33 | 74.00 | -19.67 | Pk | Horizontal |
| 4874.132 | 44.06 | 4.41 | 33.01 | 45.76 | 35.72 | 54.00 | -18.28 | AV | Horizontal |
| 7311.085 | 61.17 | 5.02 | 37.68 | 45.59 | 58.28 | 74.00 | -15.72 | Pk | Horizontal |
| 7311.085 | 43.02 | 5.02 | 37.68 | 45.59 | 40.13 | 54.00 | -13.87 | AV | Horizontal |
| High Channel (2462 MHz)(802.11b)--Above 1G | | | | | | | | | |
| 4924.169 | 64.00 | 4.50 | 33.26 | 46.07 | 55.69 | 74.00 | -18.31 | Pk | Vertical |
| 4924.169 | 43.41 | 4.50 | 33.26 | 46.07 | 35.10 | 54.00 | -18.90 | AV | Vertical |
| 7386.215 | 60.60 | 5.02 | 37.78 | 45.77 | 57.63 | 74.00 | -16.37 | Pk | Vertical |
| 7386.215 | 40.71 | 5.02 | 37.78 | 45.77 | 37.74 | 54.00 | -16.26 | AV | Vertical |
| 4924.045 | 63.79 | 4.50 | 33.26 | 46.07 | 55.48 | 74.00 | -18.52 | Pk | Horizontal |
| 4924.045 | 45.50 | 4.50 | 33.26 | 46.07 | 37.19 | 54.00 | -16.81 | AV | Horizontal |
| 7386.132 | 60.89 | 5.02 | 37.78 | 45.77 | 57.92 | 74.00 | -16.08 | Pk | Horizontal |
| 7386.132 | 42.71 | 5.02 | 37.78 | 45.77 | 39.74 | 54.00 | -14.26 | AV | Horizontal |

5.5.4.2 Band edge - radiated

- Note: (1) All Readings are Peak Value (VBW=3MHz) and AV Value (VBW=10Hz).
 (2) Emission Level= Antenna Factor + Cable Loss + Read Level - Preamp Factor
 (3) All other emissions more than 20dB below the limit.

All the modulation modes have been tested, and the worst result was report as below:

| Frequency | Meter Reading | Cable Loss | Antenna Factor | Preamp Factor | Emission Level | Limits | Margin | Detector | Comment |
|----------------|---------------|------------|----------------|---------------|----------------|----------------|--------|----------|------------|
| (MHz) | (dB μ V) | (dB) | dB/m | (dB) | (dB μ V/m) | (dB μ V/m) | (dB) | Type | |
| 802.11b | | | | | | | | | |
| 2310.00 | 58.96 | 2.40 | 27.70 | 40.40 | 48.66 | 74 | -25.34 | Pk | Horizontal |
| 2310.00 | 43.89 | 2.40 | 27.70 | 40.40 | 33.59 | 54 | -20.41 | AV | Horizontal |
| 2310.00 | 58.84 | 2.40 | 27.70 | 40.40 | 48.54 | 74 | -25.46 | Pk | Vertical |
| 2310.00 | 41.86 | 2.40 | 27.70 | 40.40 | 31.56 | 54 | -22.44 | AV | Vertical |
| 2390.00 | 57.47 | 2.44 | 28.30 | 40.10 | 48.11 | 74 | -25.89 | Pk | Vertical |
| 2390.00 | 42.41 | 2.44 | 28.30 | 40.10 | 33.05 | 54 | -20.95 | AV | Vertical |
| 2390.00 | 56.65 | 2.44 | 28.30 | 40.10 | 47.29 | 74 | -26.71 | Pk | Horizontal |
| 2390.00 | 41.98 | 2.44 | 28.30 | 40.10 | 32.62 | 54 | -21.38 | AV | Horizontal |
| 2483.50 | 57.99 | 2.48 | 28.70 | 39.80 | 49.37 | 74 | -24.63 | Pk | Vertical |
| 2483.50 | 43.17 | 2.48 | 28.70 | 39.80 | 34.55 | 54 | -19.45 | AV | Vertical |
| 2483.50 | 58.70 | 2.48 | 28.70 | 39.80 | 50.08 | 74 | -23.92 | Pk | Horizontal |
| 2483.50 | 42.12 | 2.48 | 28.70 | 39.80 | 33.50 | 54 | -20.50 | AV | Horizontal |
| 802.11g | | | | | | | | | |
| 2310.00 | 58.74 | 2.40 | 27.70 | 40.40 | 48.44 | 74 | -25.56 | Pk | Horizontal |
| 2310.00 | 44.24 | 2.40 | 27.70 | 40.40 | 33.94 | 54 | -20.06 | AV | Horizontal |
| 2310.00 | 56.98 | 2.40 | 27.70 | 40.40 | 46.68 | 74 | -27.32 | Pk | Vertical |
| 2310.00 | 42.78 | 2.40 | 27.70 | 40.40 | 32.48 | 54 | -21.52 | AV | Vertical |
| 2390.00 | 57.87 | 2.44 | 28.30 | 40.10 | 48.51 | 74 | -25.49 | Pk | Vertical |
| 2390.00 | 42.08 | 2.44 | 28.30 | 40.10 | 32.72 | 54 | -21.28 | AV | Vertical |
| 2390.00 | 57.71 | 2.44 | 28.30 | 40.10 | 48.35 | 74 | -25.65 | Pk | Horizontal |
| 2390.00 | 43.65 | 2.44 | 28.30 | 40.10 | 34.29 | 54 | -19.71 | AV | Horizontal |
| 2483.50 | 58.40 | 2.48 | 28.70 | 39.80 | 49.78 | 74 | -24.22 | Pk | Vertical |
| 2483.50 | 44.26 | 2.48 | 28.70 | 39.80 | 35.64 | 54 | -18.36 | AV | Vertical |
| 2483.50 | 58.52 | 2.48 | 28.70 | 39.80 | 49.90 | 74 | -24.10 | Pk | Horizontal |
| 2483.50 | 42.25 | 2.48 | 28.70 | 39.80 | 33.63 | 54 | -20.37 | AV | Horizontal |



| 802.11n20 | | | | | | | | | |
|-----------|-------|------|-------|-------|-------|----|--------|----|------------|
| 2310.00 | 58.34 | 2.40 | 27.70 | 40.40 | 48.04 | 74 | -25.96 | Pk | Horizontal |
| 2310.00 | 43.54 | 2.40 | 27.70 | 40.40 | 33.24 | 54 | -20.76 | AV | Horizontal |
| 2310.00 | 59.16 | 2.40 | 27.70 | 40.40 | 48.86 | 74 | -25.14 | Pk | Vertical |
| 2310.00 | 42.45 | 2.40 | 27.70 | 40.40 | 32.15 | 54 | -21.85 | AV | Vertical |
| 2390.00 | 58.30 | 2.44 | 28.30 | 40.10 | 48.94 | 74 | -25.06 | Pk | Vertical |
| 2390.00 | 42.06 | 2.44 | 28.30 | 40.10 | 32.70 | 54 | -21.30 | AV | Vertical |
| 2390.00 | 56.96 | 2.44 | 28.30 | 40.10 | 47.60 | 74 | -26.40 | Pk | Horizontal |
| 2390.00 | 42.72 | 2.44 | 28.30 | 40.10 | 33.36 | 54 | -20.64 | AV | Horizontal |
| 2483.50 | 57.90 | 2.48 | 28.70 | 39.80 | 49.28 | 74 | -24.72 | Pk | Vertical |
| 2483.50 | 42.26 | 2.48 | 28.70 | 39.80 | 33.64 | 54 | -20.36 | AV | Vertical |
| 2483.50 | 59.06 | 2.48 | 28.70 | 39.80 | 50.44 | 74 | -23.56 | Pk | Horizontal |
| 2483.50 | 42.02 | 2.48 | 28.70 | 39.80 | 33.40 | 54 | -20.60 | AV | Horizontal |

5.5.5 Spurious Emission in Restricted Band 3260MHz-18000MHz

All the modulation modes have been tested, and the worst result was report as below:

| Frequency | Reading Level | Cable Loss | Antenna Factor | Preamp Factor | Emission Level | Limits | Margin | Detector | Comment |
|-----------|---------------|------------|----------------|---------------|----------------|----------------|--------|----------|------------|
| (MHz) | (dB μ V) | (dB) | dB/m | (dB) | (dB μ V/m) | (dB μ V/m) | (dB) | Type | |
| 3260 | 60.68 | 3.27 | 30.02 | 38.05 | 55.92 | 74 | -18.08 | Pk | Vertical |
| 3260 | 39.98 | 3.27 | 30.02 | 38.05 | 35.22 | 54 | -18.78 | AV | Vertical |
| 3260 | 59.54 | 3.27 | 30.02 | 38.05 | 54.78 | 74 | -19.22 | Pk | Horizontal |
| 3260 | 36.75 | 3.27 | 30.02 | 38.05 | 31.99 | 54 | -22.01 | AV | Horizontal |
| 3332 | 60.62 | 3.31 | 30.00 | 37.91 | 56.02 | 74 | -17.98 | Pk | Vertical |
| 3332 | 38.95 | 3.31 | 30.00 | 37.91 | 34.35 | 54 | -19.65 | AV | Vertical |
| 3332 | 59.55 | 3.31 | 30.00 | 37.91 | 54.95 | 74 | -19.05 | Pk | Horizontal |
| 3332 | 36.23 | 3.31 | 30.00 | 37.91 | 31.63 | 54 | -22.37 | AV | Horizontal |
| 17797 | 42.96 | 8.63 | 44.23 | 39.60 | 56.22 | 74 | -17.78 | Pk | Vertical |
| 17797 | 29.00 | 8.63 | 44.23 | 39.60 | 42.26 | 54 | -11.74 | AV | Vertical |
| 17788 | 42.36 | 8.63 | 44.23 | 39.60 | 55.62 | 74 | -18.38 | Pk | Horizontal |
| 17788 | 27.70 | 8.63 | 44.23 | 39.60 | 40.96 | 54 | -13.04 | AV | Horizontal |

5.6 Band edge - Conducted

5.6.1 Limits

In any 100 kHz bandwidth outside the frequency band in which the spread spectrum or digitally modulated intentional radiator is operating, the radio frequency power that is produced by the intentional radiator shall be at least 20 dB below that in the 100 kHz bandwidth within the band that contains the highest level of the desired power, based on either an RF conducted or a radiated measurement, provided the transmitter demonstrates compliance with the peak conducted power limits. If the transmitter complies with the conducted power limits based on the use of RMS averaging over a time interval, as permitted under paragraph (b)(3) of this section, the attenuation required under this paragraph shall be 30 dB instead of 20 dB. Attenuation below the general limits specified in §15.209(a) is not required. In addition, radiated emissions which fall in the restricted bands, as defined in §15.205(a), must also comply with the radiated emission limits specified in §15.209(a) (see §15.205(c)).

5.6.2 Test setup



5.6.3 Test procedure

- a) Check the calibration of the measuring instrument using either an internal calibrator or a known signal from an external generator.
- b) Position the EUT without connection to measurement instrument. Turn on the EUT and connect its antenna terminal to measurement instrument via a low loss cable. Then set it to any one measured frequency within its operating range, and make sure the instrument is operated in its linear range.
- c) Set RBW to 100 kHz and VBW of spectrum analyzer to 300 kHz with a convenient frequency span including 100 kHz bandwidth from band edge.
- d) Measure the highest amplitude appearing on spectral display and set it as a reference level. Plot the graph with marking the highest point and edge frequency.
- e) Repeat above procedures until all measured frequencies were complete.

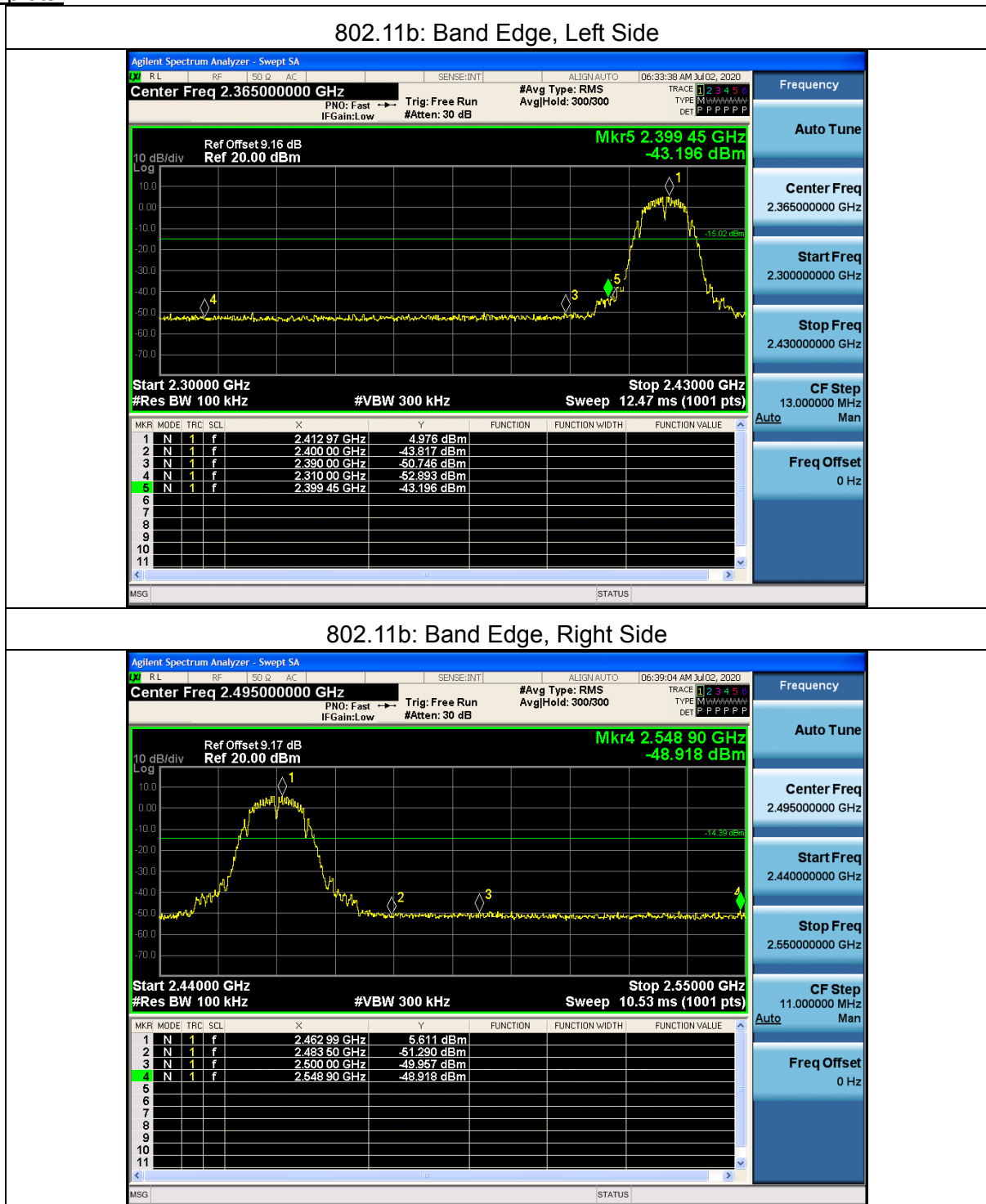
5.6.4 Test results
Test plots:

802.11g: Band Edge, Left Side

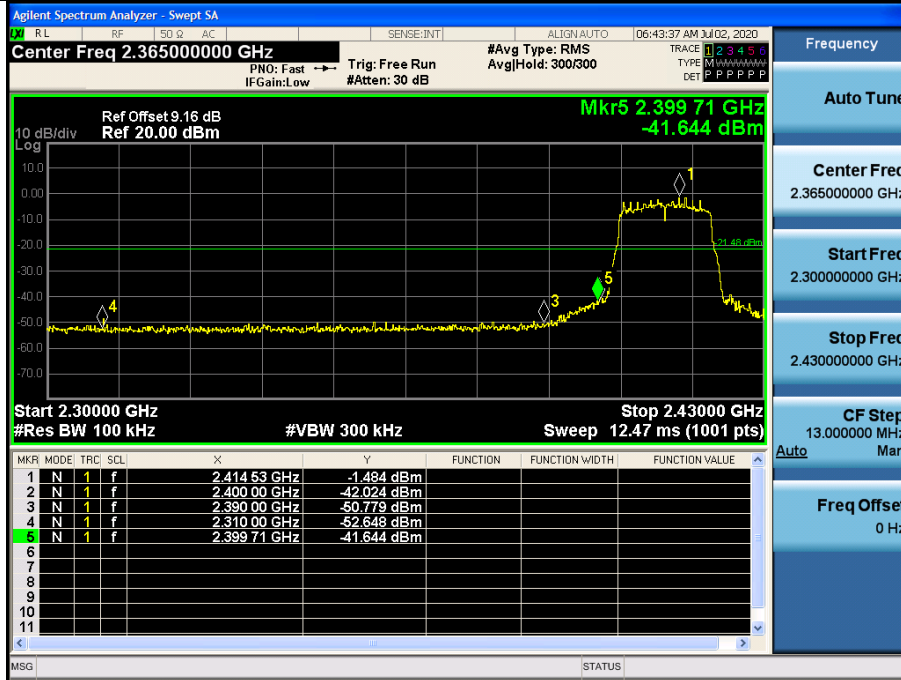

802.11g: Band Edge, Right Side





802.11n20: Band Edge, Left Side

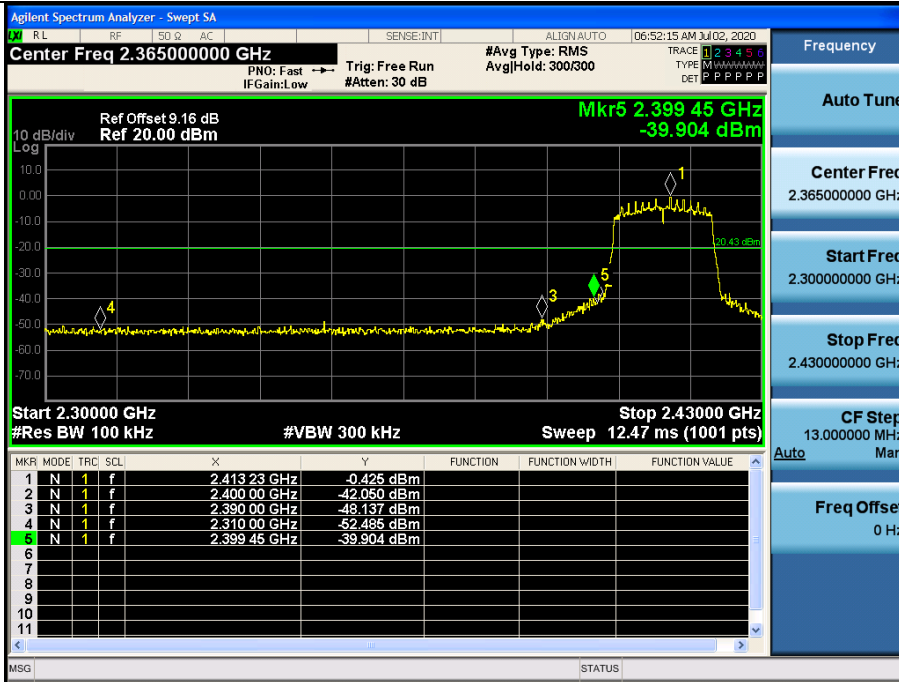

802.11n20: Band Edge, Right Side

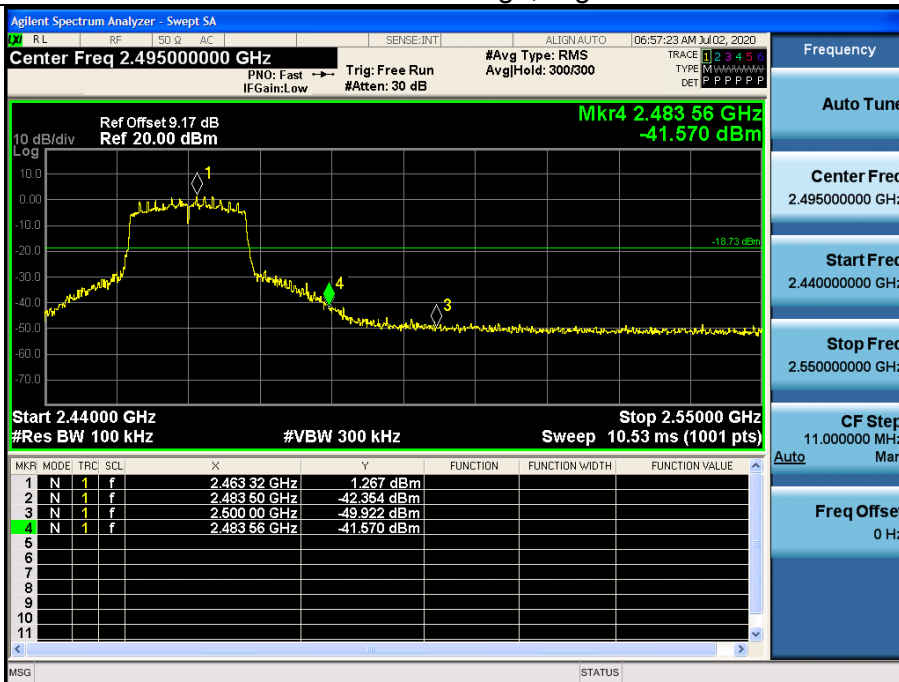

5.7 6dB bandwidth

5.7.1 Limit

| Section | Test Item | Limit | Frequency Range (MHz) |
|--------------|-----------|---|-----------------------|
| 15.247(a)(2) | Bandwidth | $\geq 500\text{kHz}$ (6dB bandwidth) | 2400-2483.5 |

5.7.2 Test setup

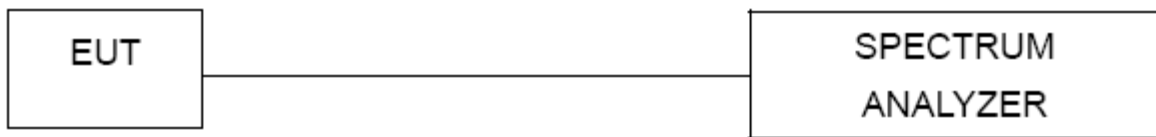

5.7.3 Test procedure

- a. Set RBW= 100 kHz.
- b. Set the video bandwidth (VBW) $\geq 3 \times$ RBW.
- c. Detector = Peak.
- d. Trace mode = max hold.
- e. Sweep = auto couple.
- f. Allow the trace to stabilize.
- g. Measure the maximum width of the emission that is constrained by the frequencies associated with the two outermost amplitude points (upper and lower) that are attenuated by 6 dB relative to the maximum level measured in the fundamental emission.

5.7.4 Test results

| | | | |
|------------|-----------------------------|---------------|----------------------|
| EUT: | 5-in-1 Emergency Hub | Model Name: | 5601-00T |
| Pressure: | 1012 hPa | Test Voltage: | DC 3.7V from battery |
| Test Mode: | TX b Mode /CH01, CH06, CH11 | | |

| Channel | Frequency (MHz) | 6dB bandwidth (MHz) | Limit (kHz) | Result |
|---------|-----------------|---------------------|-------------|--------|
| Low | 2412 | 9.576 | 500 | Pass |
| Middle | 2437 | 9.110 | 500 | Pass |
| High | 2462 | 9.585 | 500 | Pass |

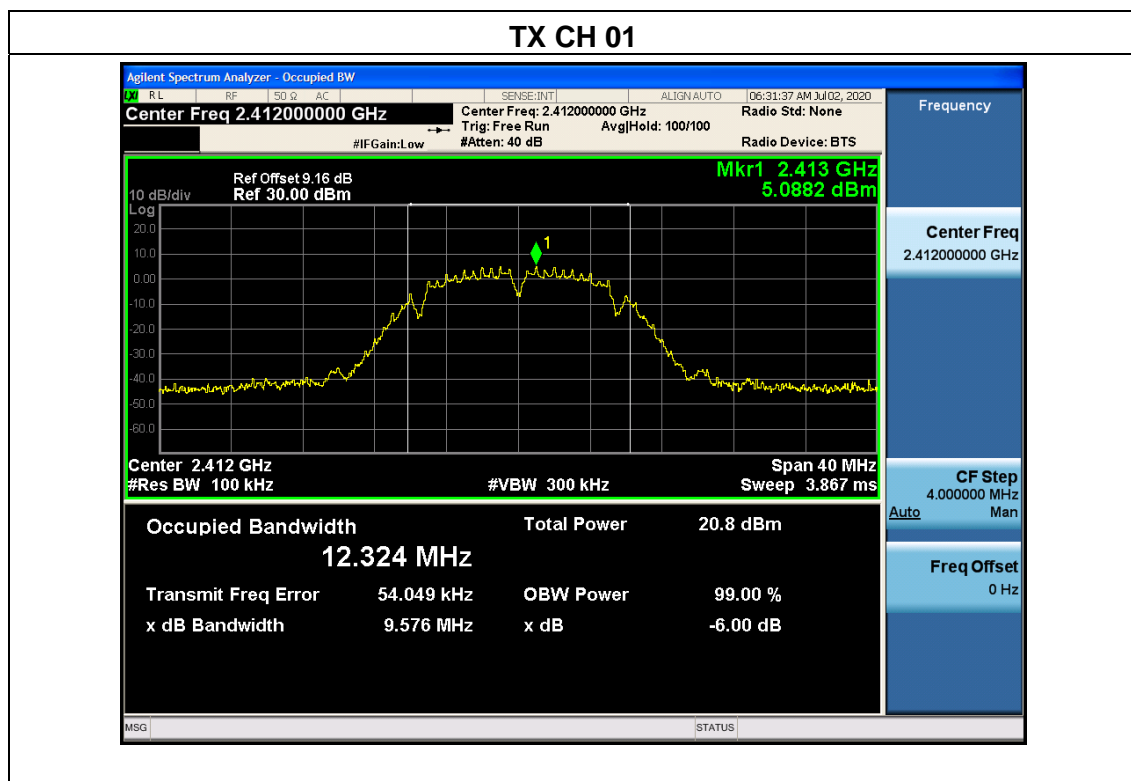



TX CH 06

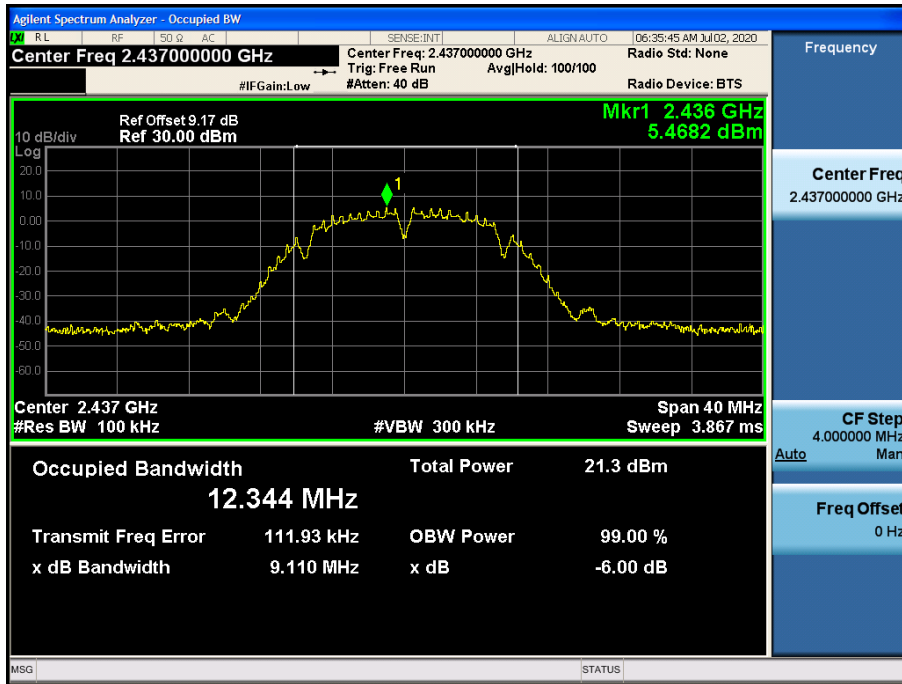

TX CH 11

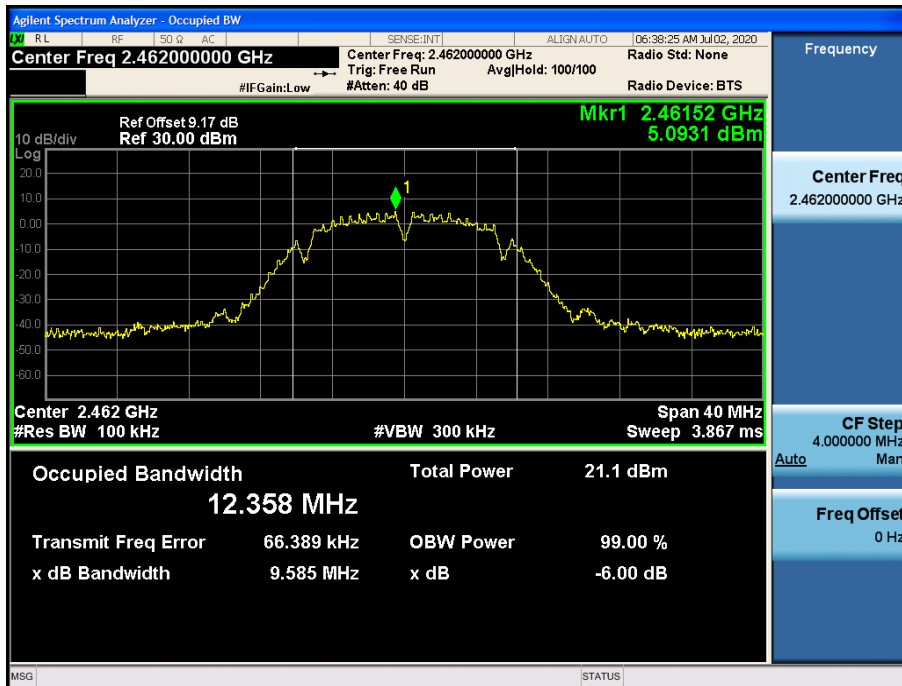

| | | | |
|------------|-----------------------------|---------------|----------------------|
| EUT: | 5-in-1 Emergency Hub | Model Name: | 5601-00T |
| Pressure: | 1012 hPa | Test Voltage: | DC 3.7V from battery |
| Test Mode: | TX g Mode /CH01, CH06, CH11 | | |

| Channel | Frequency (MHz) | 6dB bandwidth (MHz) | Limit (kHz) | Result |
|---------|-----------------|---------------------|-------------|--------|
| Low | 2412 | 15.74 | 500 | Pass |
| Middle | 2437 | 15.63 | 500 | Pass |
| High | 2462 | 16.07 | 500 | Pass |

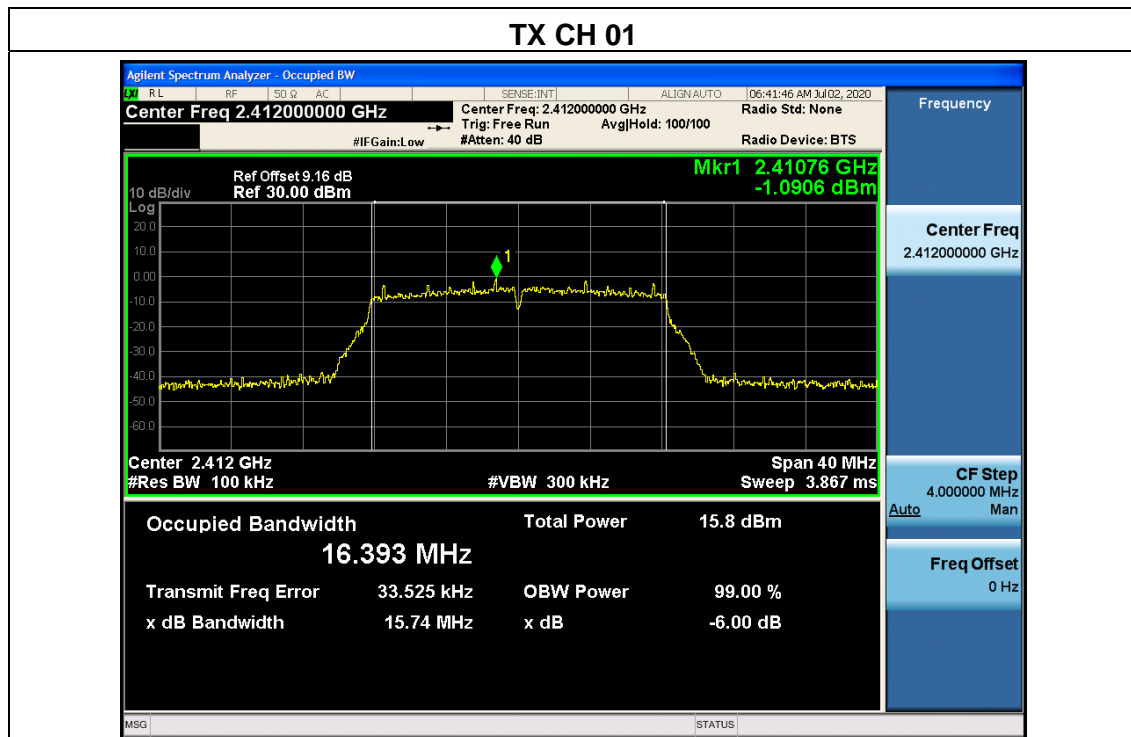

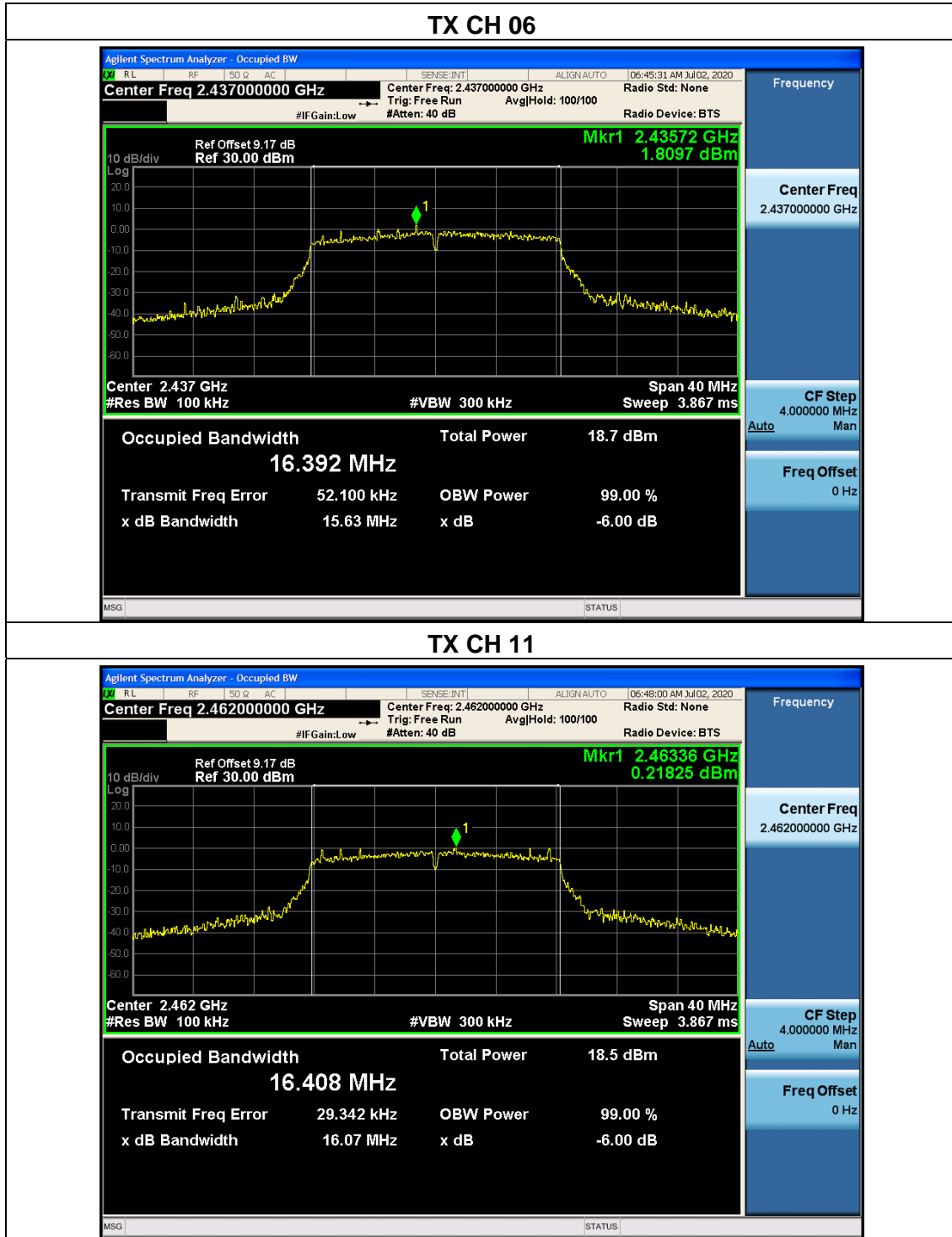

| | | | |
|------------|-------------------------------|---------------|----------------------|
| EUT: | 5-in-1 Emergency Hub | Model Name: | 5601-00T |
| Pressure: | 1012 hPa | Test Voltage: | DC 3.7V from battery |
| Test Mode: | TX n20 Mode /CH01, CH06, CH11 | | |

| Channel | Frequency (MHz) | 6dB bandwidth (MHz) | Limit (kHz) | Result |
|---------|-----------------|---------------------|-------------|--------|
| Low | 2412 | 15.39 | 500 | Pass |
| Middle | 2437 | 15.15 | 500 | Pass |
| High | 2462 | 16.27 | 500 | Pass |

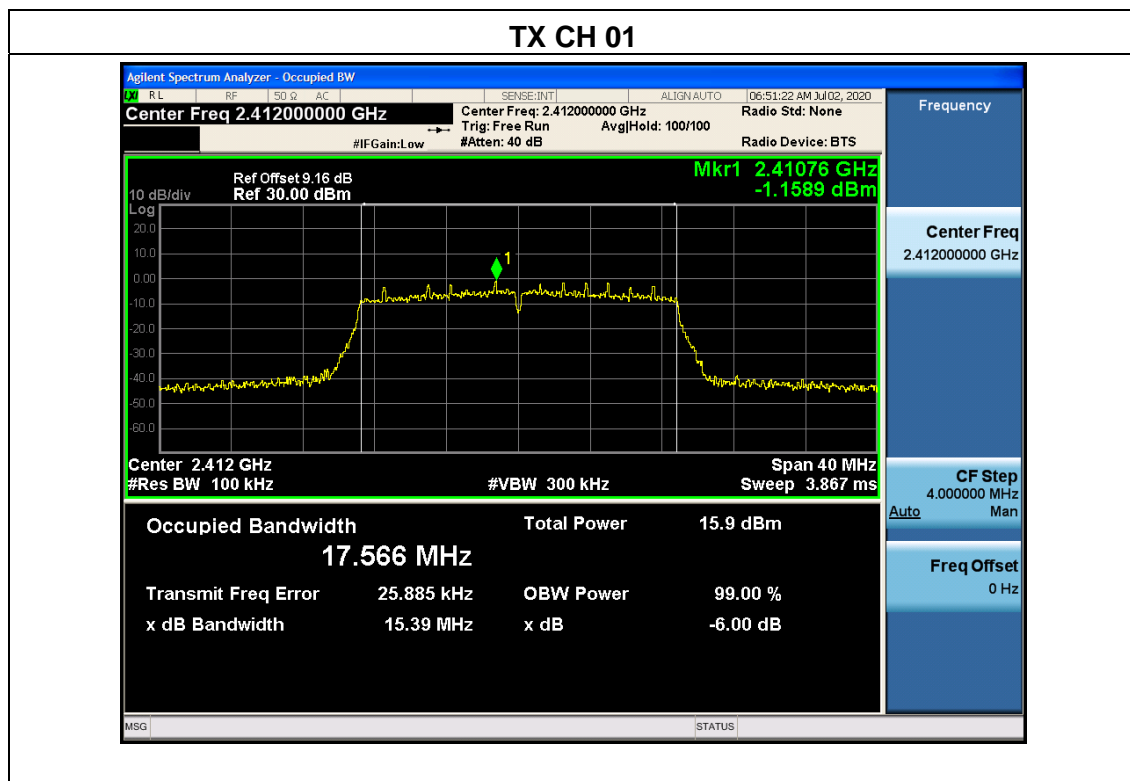

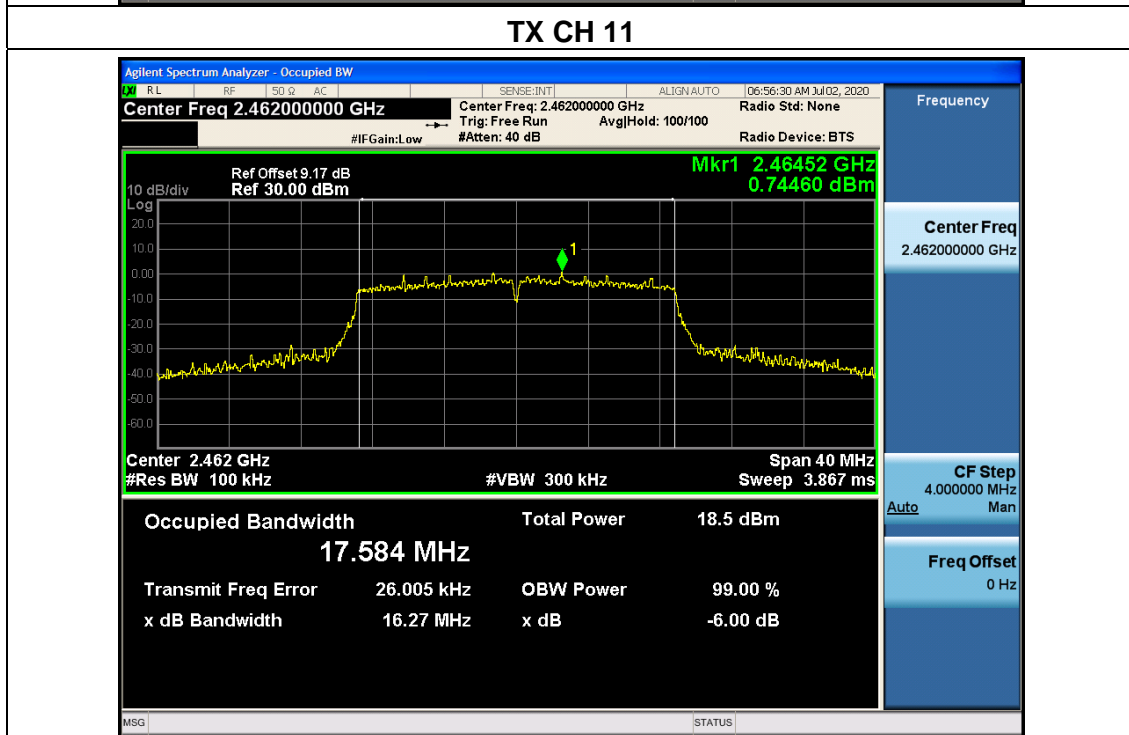
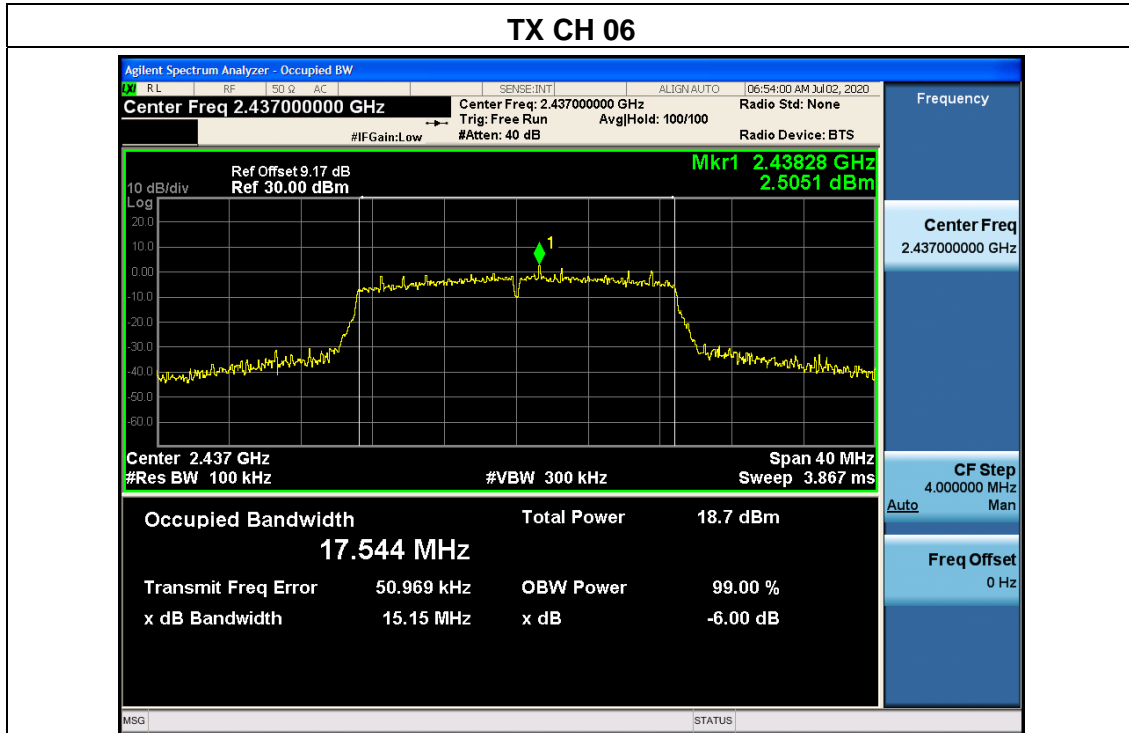

5.8 Duty Cycle

5.8.1 Limit

No limit requirement.

5.8.2 Measuring instruments

The Measuring equipment is listed in the section 4 of this test report.

5.8.3 Test setup



5.8.4 Test procedure

The zero-span mode on a spectrum analyzer or EMI receiver if the response time and spacing between bins on the sweep are sufficient to permit accurate measurements of the on and off times of the transmitted signal. Set the center frequency of the instrument to the center frequency of the transmission. Set $RBW \geq OBW$ if possible; otherwise, set RBW to the largest available value. Set $VBW \geq RBW$. Set detector = peak or average. The zero-span measurement method shall not be used unless both RBW and VBW are $> 50/T$ and the number of sweep points across duration T exceeds 100. (For example, if VBW and/or RBW are limited to 3 MHz, then the zero-span method of measuring duty cycle shall not be used if $T \leq 16.7$ microseconds.)

The transmitter output is connected to the Spectrum Analyzer. We tested according to the zero-span measurement method, 6.0(b) in KDB 558074

The largest available value of RBW is 8 MHz and VBW is 50 MHz. The zero-span method of measuring duty cycle shall not be used if $T \leq 6.25$ microseconds. ($50/6.25 = 8$)

The zero-span method was used because all measured T data are > 6.25 microseconds and both RBW and VBW are $> 50/T$.

The RF output of EUT was connected to the spectrum analyzer by RF cable and attenuator.

The path loss was compensated to the results for each measurement.

Set to the maximum power setting and enable the EUT transmit continuously.

The EUT was operating in controlled its channel.

Use the following spectrum analyzer settings:

Span = Zero Span

RBW = 8MHz (the largest available value)

VBW = 8MHz (\geq RBW)

Number of points in Sweep > 100

Detector function = peak

Trace = Clear write

Measure T total and Ton

Calculate Duty Cycle = Ton / T total

5.8.5 Test Results

| | | | |
|------------|--------------------------|---------------|----------------------|
| EUT: | 5-in-1 Emergency Hub | Model Name: | 5601-00T |
| Pressure: | 1012 hPa | Test Voltage: | DC 3.7V from battery |
| Test Mode: | TX b/g/n(20) Mode / CH06 | | |

| Mode | Data rate | Channel | Ton | Ttotal | Duty Cycle | Duty Cycle Factor (dB) | VBW Setting |
|--------------|-----------|---------|-----|--------|------------|------------------------|-------------|
| 802.11b | 1Mbps | 6 | - | - | 100% | 0 | 8MHz |
| 802.11g | 6Mbps | 6 | - | - | 100% | 0 | 8MHz |
| 802.11n HT20 | MCS0 | 6 | - | - | 100% | 0 | 8MHz |

5.9 Spurious RF Conducted Emissions

5.9.1 Limit

Below -20dB of the highest emission level in operating band.

5.9.2 Measuring instruments

The Measuring equipment is listed in the section 4 of this test report.

5.9.3 Test setup



5.9.4 Test procedure

The Spurious RF conducted emissions compliance of RF radiated emission should be measured by following the guidance in ANSI C63.10-2013 with respect to maximizing the emission by rotating the EUT, measuring the emission while the EUT is situated in three orthogonal planes (if appropriate), adjusting the measurement antenna height and polarization etc. Set RBW=100kHz and VBW= 300kHz to measure the peak field strength, and measure frequency range from 9kHz to 26.5GHz.

5.9.5 Test results

Note:

- 1: The measurement frequency range is from 9kHz to the 10th harmonic of the fundamental frequency. The lowest, middle and highest channels are tested to verify the spurious emissions and band edge measurement data.
- 2: The three modulated high, medium and low channels have been tested. The report only shows the worst mode. The worst mode is 802.11b CH01/06/11.

802.11b on Channel 01

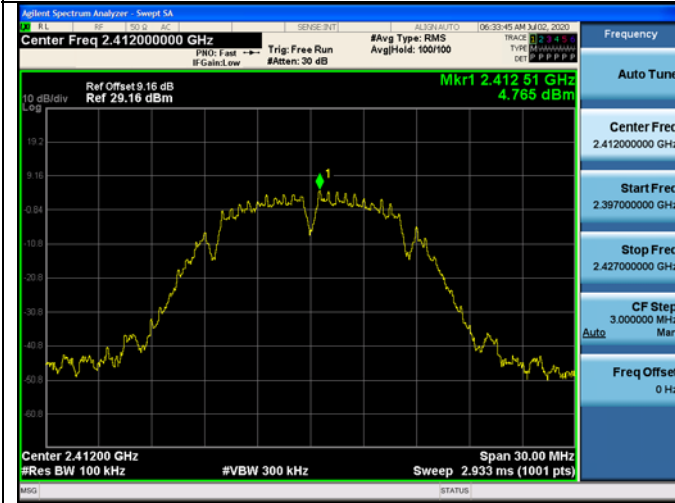

802.11b on Channel 01

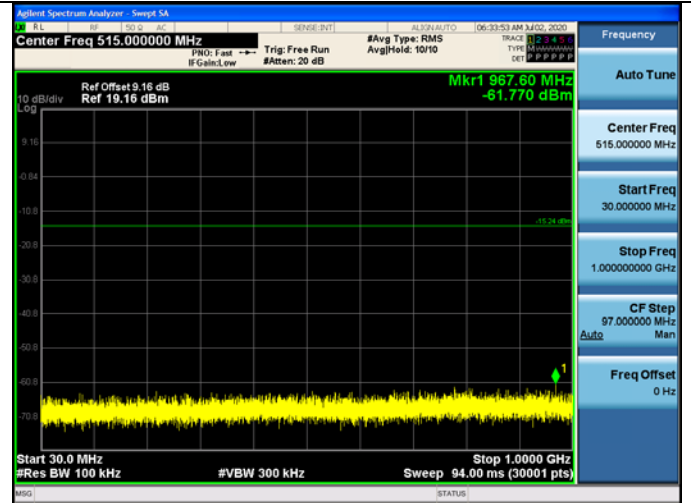

802.11b on Channel 01

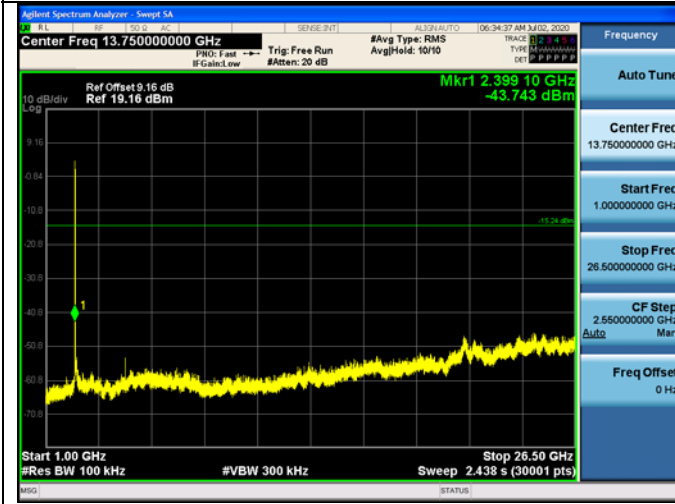

802.11b on Channel 06

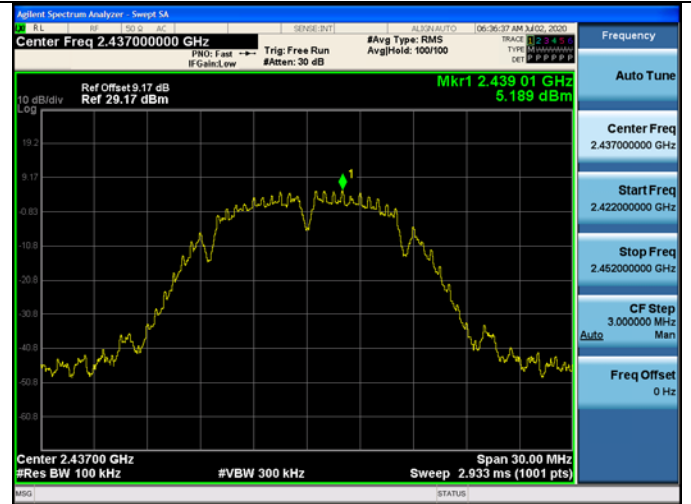

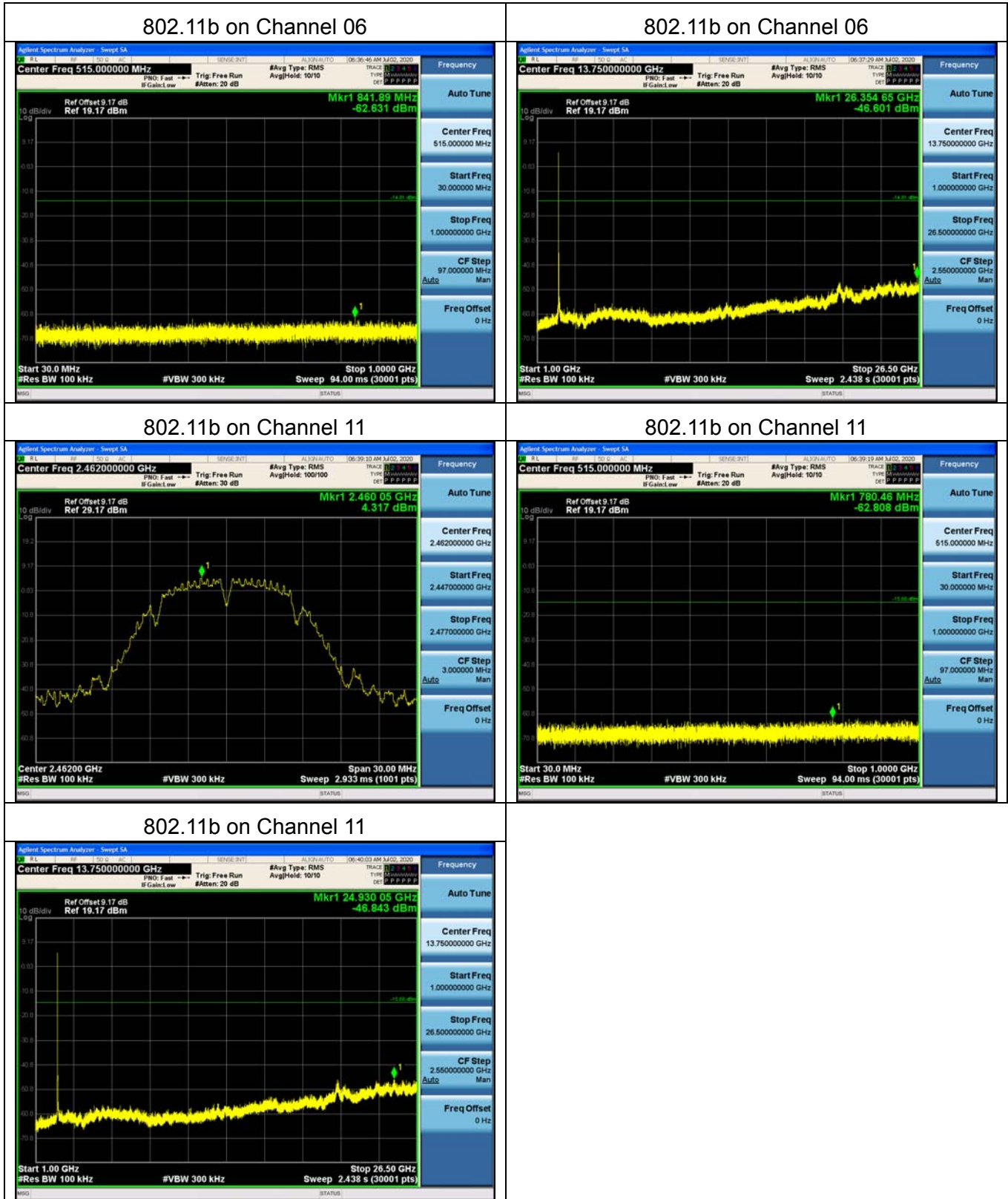

Photographs of the Test Setup

Radiated emission

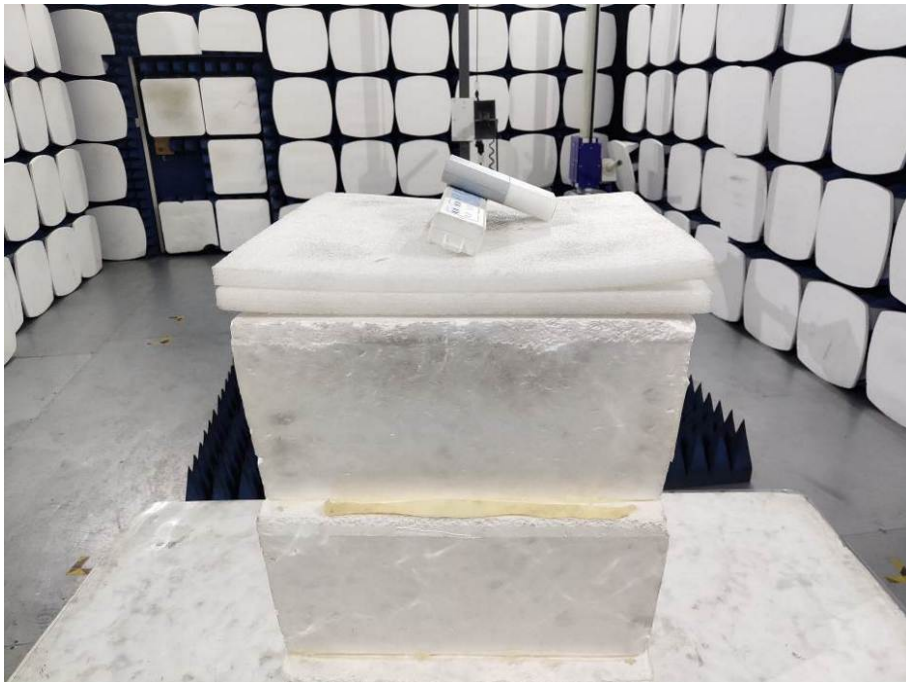

Conducted emission





Photographs of the EUT

See the APPENDIX 1: EUT PHOTO in the report No.: MTi20031911-5E1-1.

----END OF REPORT----