

Laser Projector

User Manual

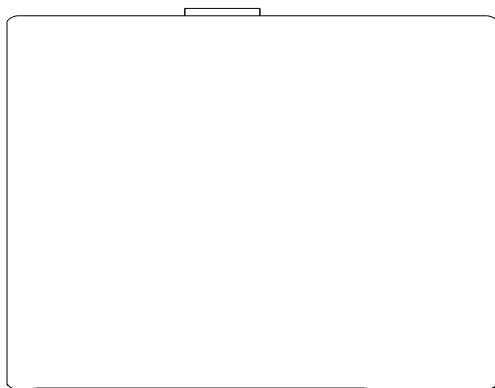

- Please read this manual carefully before using this product and keep it for future reference.
- Please read "Important Safety Instructions" carefully before using this product.

Declaration

Copyright

The company reserves all rights. No part of this document may be reproduced, transmitted, translated or stored in a retrieval system or translated into any text or computer language in any form or by any means, including electronic, mechanical, magnetic, optical, chemical, handwritten or otherwise, without the prior written permission of the company.

All trademarks and registered trademarks are the property of their respective owners.

Disclaimer

The products, services or features, etc., you purchased shall be subject to the company's commercial contracts and terms, and all or some of the products, services or features described in this manual may not be within the scope of your purchase or use. Unless otherwise agreed in the contract, the company makes no representations or warranties, express or implied, regarding the contents of the manual.

The contents of this manual may be updated from time to time due to product version upgrades or other reasons. Unless otherwise agreed, this manual is intended as a guide for use only, and all statements, information and recommendations in this manual do not constitute any express or implied warranty.

Repair

Under normal use and storage conditions, the company provides warranty on any materials and process defects of this product. Proof of purchase date must be provided when you require the warranty service. If any product defect is found during the warranty period, the sole obligation of the company and the exclusive remedy are to replace the defective parts (including the service charge). When you find that the product is defective, please immediately notify the dealer to obtain the warranty service.

IMPORTANT: If the customer fails to use the product in accordance with the written instructions, the above warranty will not apply. Ensure that the ambient humidity is between 10% and 85% and the ambient temperature is between 0° C and 40° C. Avoid using the product in a dusty environment.

For additional information, please visit www.appotronics.com.



This mark warns users that the uninsulated voltage in the projector may be sufficient to cause an electric shock. Therefore, there is a risk of electric shock for any contact with any component inside the projector.



This symbol alerts users to notice important information about the operation and maintenance. Please read this information carefully to avoid problems.

Contents

Declaration.....	2	Operation	19
Contents	3	Main Page	19
Important Safety Instructions.....	4	Signal Source.....	19
General Safety Instructions	4	Apps.....	20
Safety Tips.....	4	File Explorer	20
Important Safety Precautions.....	5	System	25
Environmental Protection Instructions	8	Network	25
Harmful Substances Declaration.....	8	Bluetooth.....	27
Electrical and Electronic Waste Product Recycling Management Regulations ...	8	Display Settings	28
Laser Safety Label	9	General.....	33
Sticking Area of Laser Safety Label.....	9	Sound.....	41
Meaning of Laser Safety Label	9	Signal Source	42
Overview.....	10	Maintenance	43
Product Overview	10	Projector Maintenance.....	43
Projector Appearance.....	11	Troubleshooting.....	44
Terminal Ports and Connections.....	12	Product Specification	45
Remote Control	13	Appendix: Control port.....	46
Replacing the Battery of the Remote Control	15	Serial port.....	46
Installation	16	LAN port settings.....	46
Installation Methods.....	16	Reference Command List.....	47
Projection Distance.....	17		
Installation Procedure.....	18		

Important Safety Instructions

General Safety Instructions

- ♦ Please read this manual carefully before using this product and keep it for future reference.
- ♦ The device shall be installed, operated and maintained by a qualified authorized technical personnel.
- ♦ All warnings listed on this projector and listed in this manual should be observed.
- ♦ Strictly observe all instructions on operations and usage.
- ♦ Strictly observe all local installation standards.

Security Tips

This equipment complies with safety standards stipulated for information technology equipment that are subject to stringent requirements for the use of critical safety assemblies, components, materials, and insulators in order to protect users and operators from the following hazards:

- Electric shock
- Energy-related hazards
- Fire
- Heat-related hazards
- Mechanical hazards
- Radiation
- Chemical hazards

In addition, these standards also raise limitations in many ways, such as internal and external temperature rise levels, radiation levels, mechanical stability and intensity, peripheral construction and fire protection devices. Even if the normal operation of the equipment fails, the single-point fault simulation test can also ensure that the device can use the fuse, thermal circuit breakers, overcurrent protection devices and similar devices to provide adequate protection of the human body.

This manual is for authorized use only for professional purposes and these persons should be familiar with the potential hazards that may arise from this product. Only qualified maintenance personnel who are familiar with such hazards can open the product shell to perform maintenance operations.

Important Safety Instructions

Terms:

- ◆ Maintenance personnel:
Refer to the professional personnel who may use the training and skills to avoid possible harms to themselves or others when they are in the maintenance contact area or the device in the restricted contact area has obvious dangers.
- ◆ Users:
Refer to all persons except maintenance personnel.
- ◆ Restricted Access Area:
Only maintenance personnel can enter the restricted access area or only if a user is aware of the reasons for restricting access to the area and has taken preventive measures. Refer to an area where an operator must use a specific tool, lock, or key or take other safety measures to access; in addition, the access to this area is controlled by the specified agency.

Important Safety Precautions

- Preventing the risk of electric shock
 - ◆ The projector should use AC power. Make sure that the main voltage and capacitance match the rated power of the projector. If the installation environment cannot meet the AC power requirements, please contact the electrician.
 - ◆ The installation can only be carried out by qualified technical personnel in accordance with local electrical codes and regulations.
 - ◆ This device uses a three-terminal power cable that includes a single-phase line that protects the ground wire (PE). If the installation environment cannot meet the AC power requirements, please contact the electrician. Please do not ignore the role of PE.
 - ◆ Turn off the power to the projector and unplug the power cord to cut off all power connections from the projector.
 - ◆ If you need to extend the cable, use a power cable with the current rated value not lower than that of the projector. If the rated value of the power cable is lower than the current value of the projector, it may cause overheating.
 - ◆ Do not disassemble the projector. When it needs to be maintained or repaired, hand it over to a trained and authorized service person.
 - ◆ Do not spill any liquid on the projector.
 - ◆ To better protect the product during thunderstorms or when it is not used for a long period of time, unplug the power plug from the wall socket. This can prevent lightning or power line surges from causing damage to the projector.

- Preventing battery explosion
 - ◆ If the battery is improperly installed, an explosion may occur.
 - ◆ Replace the battery with the manufacturer's recommended or equivalent type of battery.
 - ◆ When disposing used batteries, be sure to refer to the rules and regulations on disposal of hazardous wastes at the national, provincial and local levels to ensure proper disposal of waste.

Important Safety Instructions

■ Preventing personal injury

- ◆ To prevent personal injury and physical damage, refer to this manual and all the labels on the system before plugging the power plug into the electrical outlet, or commissioning the projector.
- ◆ To prevent injury, ensure that the lens and all covers are installed correctly.
- ◆ Before attempting to move or remove the projector, turn off the projector and unplug the power plug from the wall socket.
- ◆ When you need to turn off the projector to access internal parts, you must disconnect the power cable from the power supply and unplug the power cable from the UPS power input socket (authorized maintenance personnel only). If the projector's power input is not accessible (for example, in ceiling-mounted installation mode), install a common disconnect device that is easily accessible in the fixed wiring.
- ◆ Warning: High intensity light. Do not look into the lens! High brightness will cause damage to the eyes.
- ◆ Warning: This projector uses a high-brightness laser light source. Do not try to look directly at the lens or laser light source.
- ◆ Do not observe the end of the laser beam while the device is running. Laser radiation is harmful to the human eye and may cause injury.
- ◆ Invisible infrared LEDs radiation may be emitted from disconnected optical fibers or connectors. Do not look directly at the beam or look straight to the optical instruments.
- ◆ The laser has high density energy. These may be dangerous for skin tissue and may cause electrical, and chemical and non-ionizing radiation hazards.
- ◆ The product shell has an air outlet for heat dissipation. When you approach or touch the outer surface of the product, avoid getting close to the air outlet to protect your skin from being burned by the heat dissipation airflow.

■ Preventing damages to the projector

- ◆ When using the projector, be sure to open the lens shutter or remove the lens cover.
- ◆ If there is any abnormality in the projector, unplug the power cable immediately. Do not continue to use the projector when it comes to smoke or makes strange noise or odor. In this case, immediately unplug the power cable and then contact the dealer.
- ◆ Keep the original shipping box and packing material. You can use them again when you need to transport the equipment. In order to maximize the protection of the equipment, re-package it in accordance with the original packaging at the factory.
- ◆ Before cleaning the device, unplug the power plug from the electrical outlet. Do not use cleaners or spray cleaners, but use a damp cloth for cleaning. Do not use irritating solvents, such as thinners, gasoline, or corrosive cleaners, as they can cause damage to the case. You can use a damp cloth and a mild detergent to remove stubborn stains.
- ◆ To ensure maximum optical performance and resolution, the projection lens is coated with a special anti-reflective coating, so avoid touching the lens. If you need to remove dust from the lens, use a soft cloth instead of a damp cloth, cleanser or thinner.
- ◆ Do not place this projector on an unstable vehicle, shelf or table. Because it will cause serious damage once the projector is dropped. Functions may be affected. Therefore, you should replace them. For example, damages such as cracks or deep scratches may occur.

Important Safety Instructions

■ Preventing fire

- ◆ The design and manufacture of the projector conforms to the most stringent safety requirements. Putting the flammable material near the projector may cause the material to ignite itself, causing a fire. Once fire occurs, be sure to use sand, CO₂ or dry powder fire extinguishers. Please do not use water to extinguish a fire when an electrical fire occurs.
- ◆ It is advisable to leave a "quarantine" around all the outer surfaces of the projector. No flammable material shall be placed in this area. Do not use any material to cover the projector or lens while the projector is working.
- ◆ Do not block the vents around the projector. Do not place paper or other objects in the range of 1000 mm around the projector.
- ◆ The slots on the projector are used for ventilation and heat dissipation. To ensure reliable operation of the projector and to prevent it from overheating, do not block or cover these slots. The projector should not be attached to walls or other similar surfaces to prevent clogging of these slots. The projector should not be placed near the radiator or heat regulator. Unless the ventilation is good, the projector should not be placed in the embedded device or enclosed device.
- ◆ The projection room must be well ventilated or have a cooling device to avoid heat buildup. The hot air discharged from the projector must be able to be discharged to the outside of the building.
- ◆ If the projector is not used for a long period of time, remove the power cable.

■ About Repair

- ◆ Do not service this equipment privately because opening or removing the cover may expose you to high pressure and face an electric shock hazard.
- ◆ If you attempt to change the internal control functions set at the factory or to change other control settings that are not specifically addressed in this manual, it will cause permanent damage to the laser light source suite and warranty failure.
- ◆ When the following cases occur, unplug the device from the electrical outlet and allow qualified service personnel to service:
 - The power cable or power plug is damaged or worn out.
 - Liquid enters into the equipment.
 - The equipment is exposed to rain or water.
 - If the equipment cannot operate properly in accordance with the operation instructions, adjust only the adjustment apparatuses mentioned in the operation instructions because improper adjustment of other apparatuses may cause equipment damage.
 - The equipment falls to the ground or the housing is damaged.
 - If the equipment performance deteriorates significantly, ask the maintenance personnel for help.
- ◆ Replacement parts: When using replacement parts, ensure that the service technician uses approved replacement parts or approved replacement parts that are identical to the original parts. Unauthorized alternatives may result in deteriorated performance and stability, causing fire, electric shock, or other hazards. Unapproved alternatives may void the warranty.
- ◆ Safety check: When the projector is repaired, request the service technician to perform a safety check to ensure that the device has returned to the normal operation state.

Environmental Protection Instructions

Harmful Substances Declaration

Name and Content of Hazardous Substances in the Product						
Parts Name	Harmful Substances					
	Pb	Hg	Cadmium (Cd)	Hexavalent chromium Cr (VI)	Polybrominated biphenyls PBB	Polybrominated diphenyl ethers PBDE
Light source/light machine	○	○	○	○	○	○
PCBA assembly	×	○	○	○	○	○
Cables	○	○	○	○	○	○
Power assembly	×	○	○	○	○	○
Structure assembly	○	○	○	○	○	○
Lens	○	○	○	○	○	○
Remote control	○	○	○	○	○	○
Other metal pieces	×	○	○	○	○	○

This form is prepared in accordance with SJ/T 11364.

○ : Indicates that the content of the hazardous substance in all homogeneous materials of the part is below the limit specified in GB/T 26572.

× : Indicates that the content of the hazardous substance in at least one of the homogeneous materials of the part exceeds the limit specified in GB/T 26572.

Note: 1. The components marked with an "×" cannot be replaced by hazardous substances due to global technological development.
 2. PCBA assembly: Includes PCBs and their components, integrated circuits (ICs) and connectors.
 3. The product you purchased may not contain all of the above components due to different product models.



The numbers in the circle represent the normal environmental lifetime of the product. The company encourages users to hand over the product to local organizations with state-recognized recycling qualifications, in compliance with the state laws and regulations on the recycling of waste electrical and electronic products. The company provides a variety of programs and services to help equipment owners recycle the products.

Electrical and Electronic Waste Product Recycling Management Regulations

Notes on recycling of waste electrical appliances and electronic products:

When users no longer need this product or the life of the product ends, please comply with Electrical and Electronic Waste Product Recycling Management Regulations, and hand it over to the local manufacturer with -state-recognized recycling qualification in order to promote the comprehensive utilization of resources and the development of circular economy, and protect the environment and human health.

The CMIIT ID of SRRC model is shown on the product nameplate, which is attached to the product.

Laser Safety Label

Sticking Area of Laser Safety Label

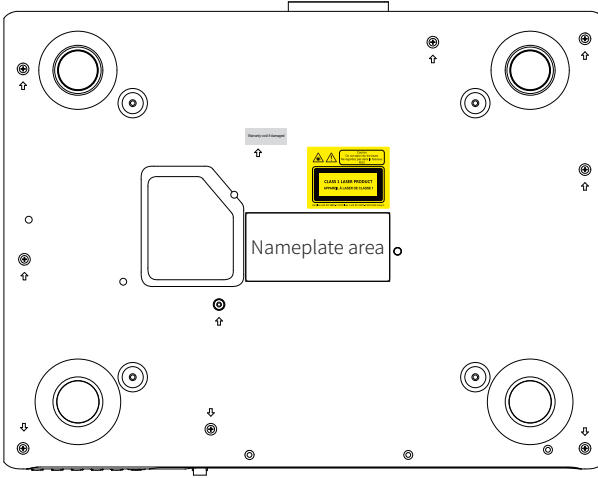

Meaning of Laser Safety Label



Caution

- Do not stare into the beam.
- Ne regardez pas dans le faisceau.
- RG2



Laser radiation warning sign

Overview

Product Overview

Thank you for choosing our projector. This product is a compact high brightness laser projector based on DLP display technology. With the new-generation APLD laser source technology, it features excellent color performance.

This product is delivered with all the items shown below. Check the packaging to ensure that the items are complete. If any items are missing, please contact the dealer immediately.

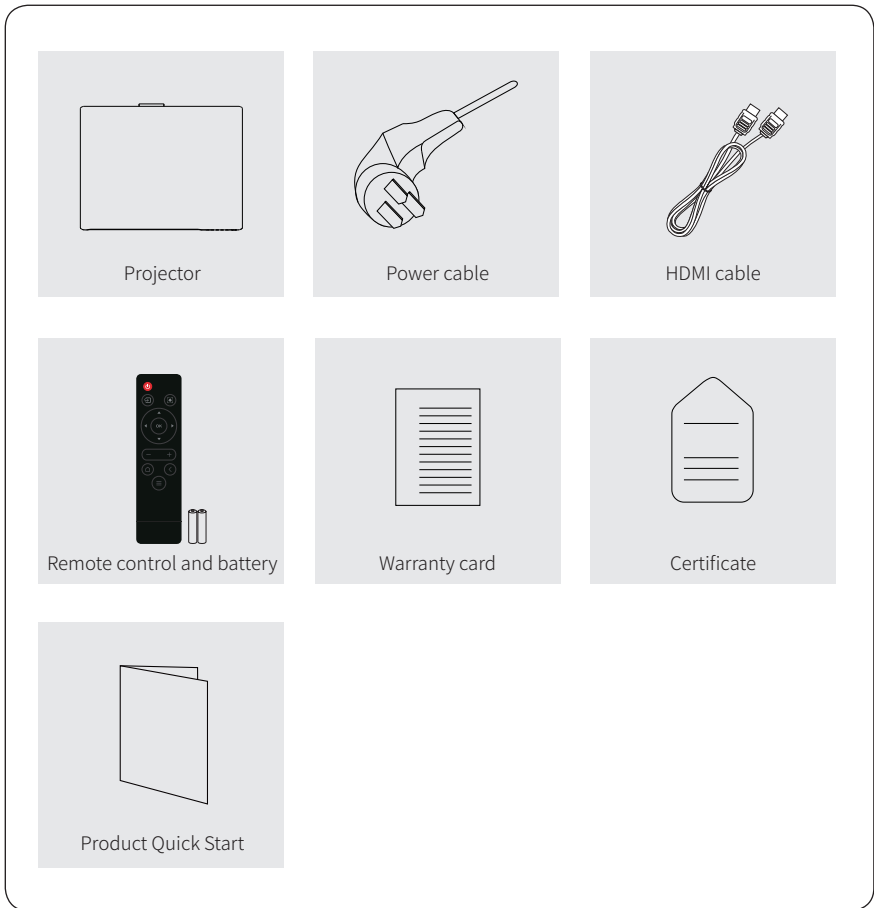

Caution

- The list of accessories varies depending on the countries (regions) where the products are sold and the models are selected, which is subject to the actual product.

Overview

Projector Appearance

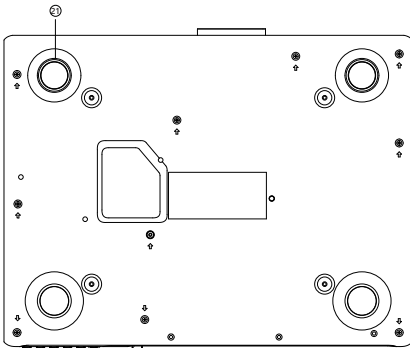
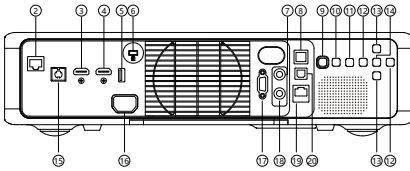
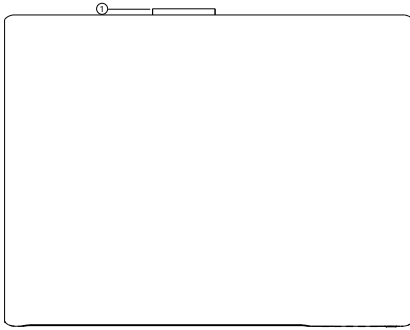

- 1 Projection lens
- 2 HDBaseT port
- 3 HDMI1 input port
- 4 HDMI2 input port
- 5 USB port
- 6 Kensington anti-theft lock slot
- 7 SYNC OUT port
- 8 S/PDIF output port
- 9 Power button (power-on/off)
Power on/off the projector.
- 10 Menu buttons
Access the screen display menu, exit the menu, and save the settings.
- 11 Back
Go back to the menu at the previous level.
- 12 Left/Right arrow key
Left arrow key: Select the left item or decrease the value.
Right arrow key: Select the right item or increase the value.
- 13 Up/Down arrow key
Select the up or down item.
- 14 OK
Press to select or confirm the current value or item.
- 15 IR 3D OUT port
- 16 Power cable port
- 17 RS232 control port
- 18 SYNC IN port
- 19 LAN cable port
- 20 USB-B terminal
- 21 Adjustable wheel

Warning

- This device must be grounded.
- When installing the device, add an existing power-off apparatus to the fixed wiring, or connect the power plug to a convenient outlet near the device. If the device is faulty during operation, use a power-off apparatus to cut off the power supply.

Overview

Terminal Ports and Connections

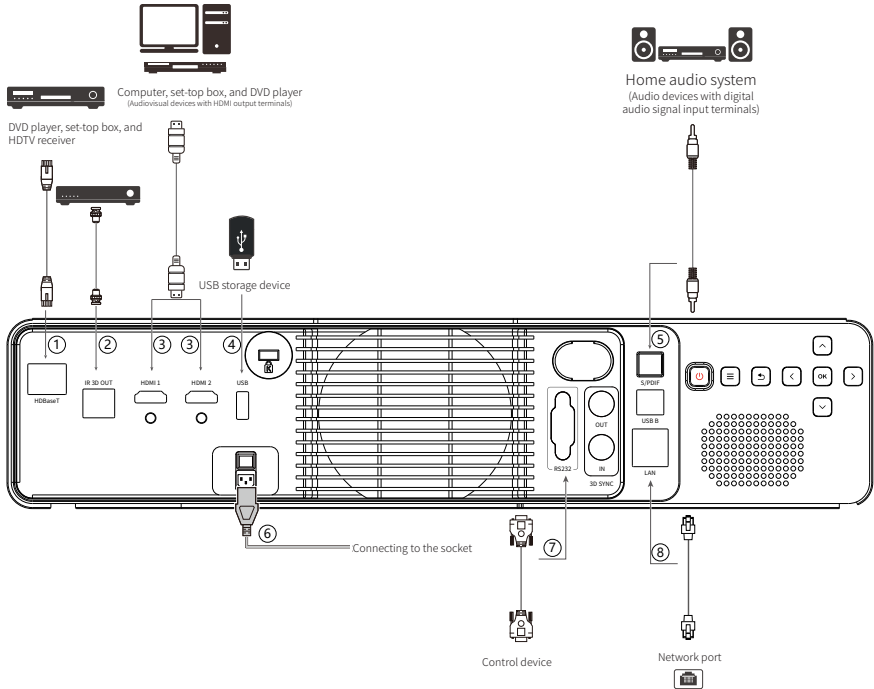

- 1 HDBaseT port
- 2 IR 3D OUT port
- 3 HDMI1 and HDMI2 input ports
 - HDMI signal input port
- 4 USB port
 - HOST port, used to connect to the USB flash drive, removable hard disk, keyboard, mouse, and other secondary USB devices
- 5 S/PDIF output port
 - S/PDIF optical digital audio output
- 6 Power cable port
 - Connect to power supply
- 7 RS232 control port
 - Connect to control device
- 8 LAN cable port

Overview

Remote Control

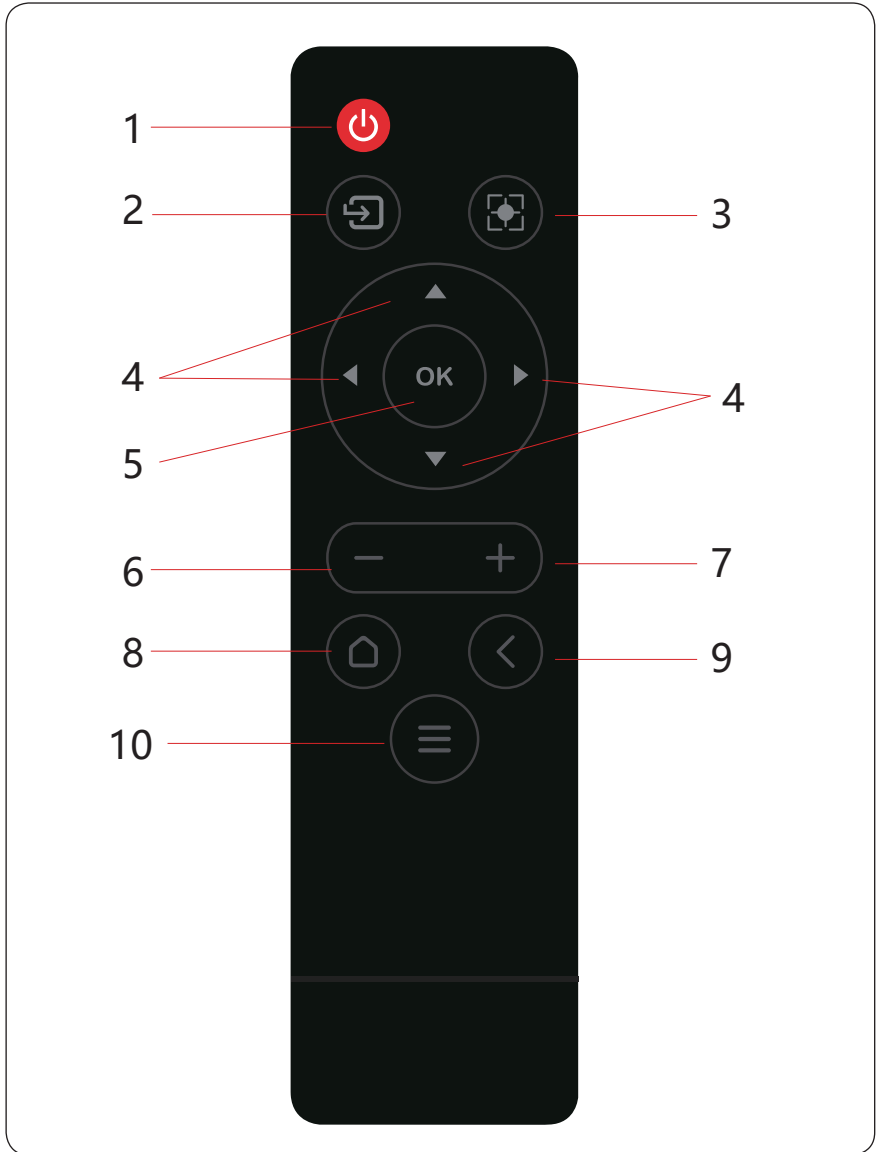

Overview

1. Power supply

In standby mode, if you press this key, the device is powered on; in power-on mode, if you press this key, the screen prompts for the power-off operation. Press the power button to shut down the device.

2. Signal source

If you press this key, you can select the projector input signal source.

3. Electric zoom

If you press this key, an electric zoom prompt box is displayed. You can press the Left or Right arrow key to adjust the focus.

4. ← ↑ ↓ → (arrow keys)

You can use ↑ and ↓ to scroll up and down, ← to select from the left or decrease the value, and → to select from the right or increase the value.

5. OK

Press to select or confirm the current value or item.

6. Volume-

Decrease the volume.

7. Volume+

Increase the volume.

8. Home page

Go back to the home page.

9. Back

Go back to the previous page.

10. Menu

Enter the menu of the product. The details on the menu page vary with product models.

Overview

Replacing the Battery of the Remote Control

- To open the battery cover, turn the remote control with the back facing up, and pull the battery cover as indicated by the arrowhead in the figure to remove the battery cover.
- Remove the old battery (if necessary) and install two new AAA alkaline dry batteries at the bottom of the battery compartment according to the polarity instructions. The anode of the battery towards the (+) direction, and the cathode towards the (-) direction.
- Reattach the battery cover as indicated by the arrowhead in the figure.

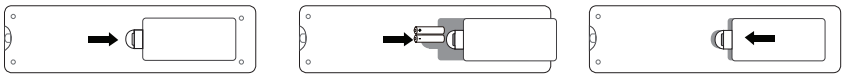

Warning

- Do not place the remote control and battery in high-temperature and high-humidity environments such as kitchens, bathrooms, saunas, solariums or closed cars.
- Use only the same or similar battery recommended by the battery manufacturer for the remote control.
- Deal with old and waste batteries according to the manufacturer's instructions and local environmental regulations.
- Do not throw the battery into the fire, since there may be a risk of explosion.
- If the battery is exhausted or the remote control is not used for a long period of time, take out the battery to avoid damage to the remote control due to liquid leakage.

Installation

Installation Methods

The projector supports four projection modes. Please install the projector according to the installation position. Shut down the projector before changing the projection mode and then start up the projector after changing the projection mode. The projection mode can be preset to desktop-mounted front projection. You can also select another projection mode from the menu.

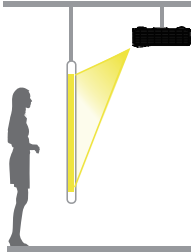

Ceiling rear

Hang the projector on the wall or ceiling and project the image from the rear of the semi-transparent projection screen.

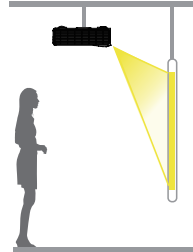

Ceiling front

Hang the projector on the wall or ceiling and project the image from the front of the projection screen.

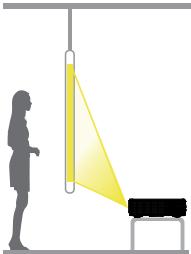

Desktop rear

The projection is on the rear of the semi-transparent projection screen.

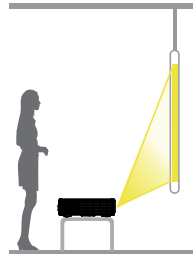

Desktop front

The projection is in the front of the projection screen.

Caution

- Please use four M4*12 screws to hang the projector from the wall or ceiling.
- If adhesive is used for hanging wall fixing points or ceiling hanger fixing points to prevent screws from loosening, or lubricating oil or other oils are used in the projector, the projector enclosure may break and cause the projector to fall. This may cause serious injury to the person standing under the hanger and damage to the projector. When installing or adjusting the hanger, do not use adhesive to prevent the screw from loosening, and do not use lubricating oil or other oils.
- When using the ceiling installation method, special installation method and correct tools are required. Please contact qualified personnel for installation, otherwise the product may fall and cause accidents and injuries.
- When the projector is hung on the wall or ceiling, please make sure that the product is more than 1.8m away from the ground.

Installation

Projection Distance

Determine the projection distance according to the model differences and screen dimensions as specified in the following table.

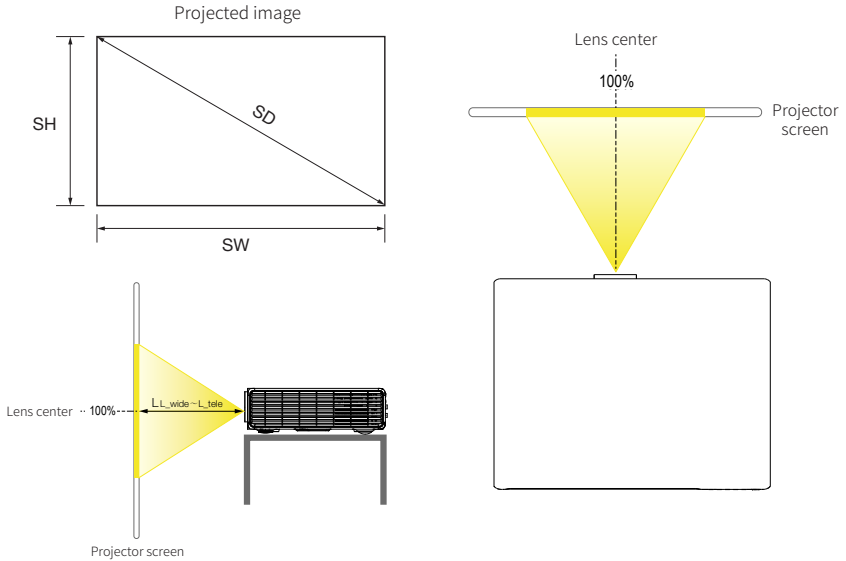

Screen Size				Projection Distance L _{wide} (±5%)	Projection Distance L _{tele} (±5%)	Projection Ratio
Diagonal (SD)		Length (SW)	Width (SH)			
Inch	Millimeter	Millimeter	Millimeter	Millimeter	Millimeter	
60	1524	1328	747	2019	3254	1.52 (wide) to 2.45 (tele)
80	2032	1771	996	2692	4339	
100	2540	2214	1245	3365	5424	
120	3048	2657	1494	4038	6509	
150	3810	3321	1868	5047	8136	
180	4572	3985	2241	6057	9763	
200	5080	4428	2491	6730	10848	
250	6350	5535	3113	8412	13560	

Caution

- Projection distance L indicates the distance from the surface of the projector lens to the screen.
- The maximum horizontal or vertical offset of an image indicates the maximum distance that the image can move horizontally or vertically. If the offset exceeds this distance, problems such as light blocking and interference will occur.
- The values in the table are approximate values, which may have a tolerance of ±5% from the actual measured values.

Installation

Installation Procedure

- 1 Ensure that all items are complete based on the packaging diagram.
- 2 Check whether all installation requirements are satisfied, such as the environmental conditions of the installation area, installation methods, projection distance, and safety regulation compliance of the electrical connection to the power grid.
- 3 It is prohibited to place the terminal surface of the projector on a table or a platform such as the ground when handling the projector.

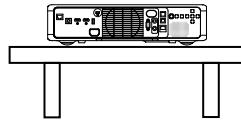
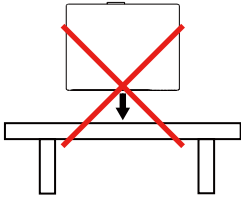
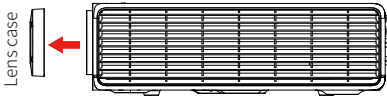

Diagram of the correct placement

- 4 Remove the lens case before turning on the projector. If the lens case blocks the strong light emitted by the projector, the surface of the lens may be damaged.



Caution

- The projector is cooled by a fan. Please do not place objects within 1000mm from the cooling hole of the projector to prevent the dissipation outlet from blocking and affecting the heat dissipation effect.
- The projector should be used in the area with ambient temperature not exceeding 40 °C (measured at the air inlet of the projector).
- Do not touch heat dissipation hole and ventilation hole where the temperature of is up to about 65 °C .

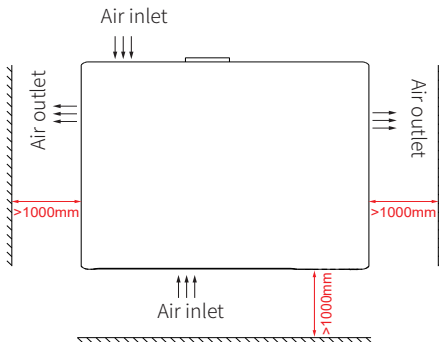

Operation

Main Page

After the device is energized, the main page is displayed. The upper right corner displays the icon of the connected external storage device (the icon of external storage device such as USB flash drive is displayed after connected), network connection icon, Bluetooth icon, and current time.

The main page displays the signal source icon, system settings icon, multiscreen icon, app icon, electric zoom icon, file management icon, office file icon and message icon.

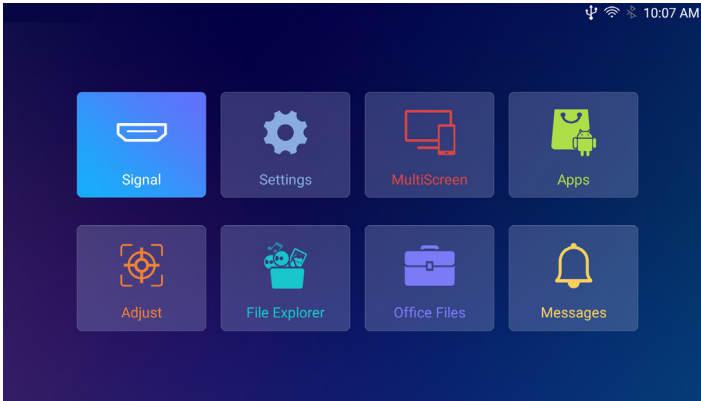

Signal Source

After the DVD, set-top box or laptop computer is connected to the HDMI port, select the corresponding HDMI option to enter the signal source page.

After you select Signal Source, HDMI1, HDMI2, and HDBaseT are displayed in sequence.

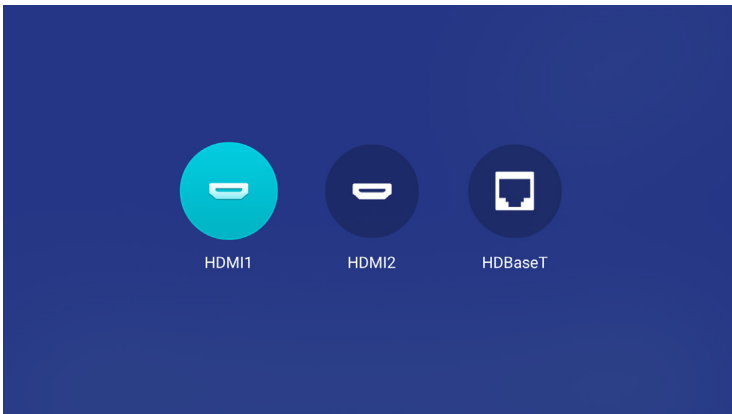

Operation

Apps

After you click the Apps icon, all apps preset in the system, including the apps installed by the user, are displayed.

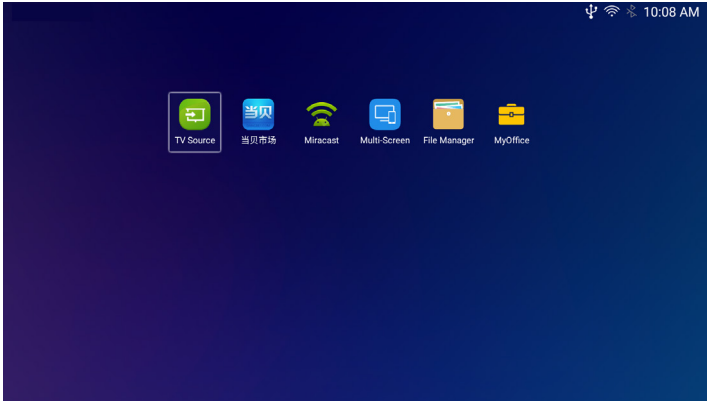

File Explorer

You can access the connected external storage devices on the File Explorer page, and access the images, music, videos, and files saved on the external storage devices.

1. After the external storage device is connected, the File Explorer page displays the name of the currently connected device.

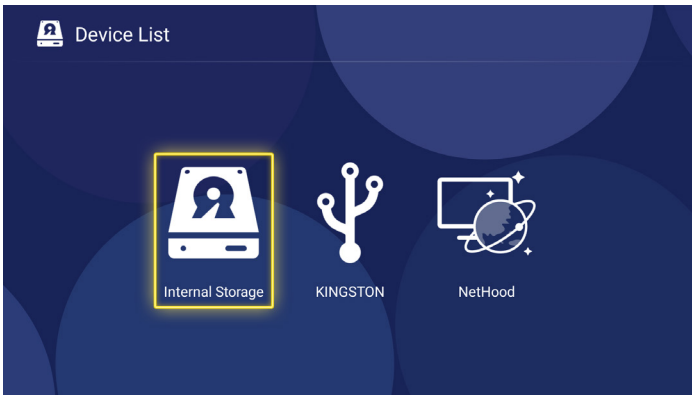

Operation

2. After you click the name of the external storage device, you can see the corresponding videos, music, files, APK and other content.

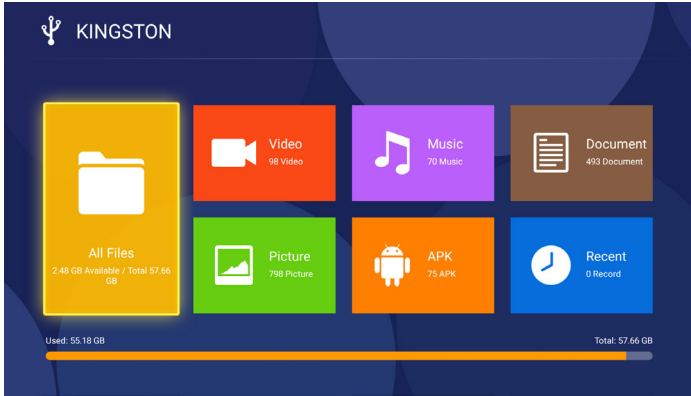

3. Select an image to browser. You can also press the menu button to perform the Delete, Rotate, Slide Show, and View Details operations.



Operation

- 4. When playing the music, you can switch to the previous/next song, pause the music, and switch the playback modes.

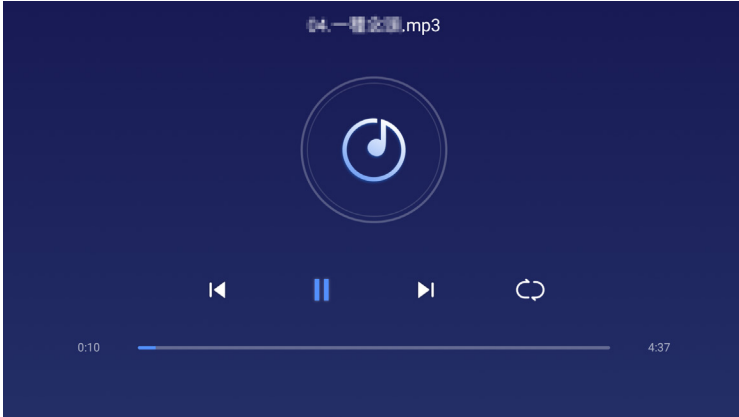

- 5. When playing the video, you can switch to the previous/next video, pause the video, or switch the videos.

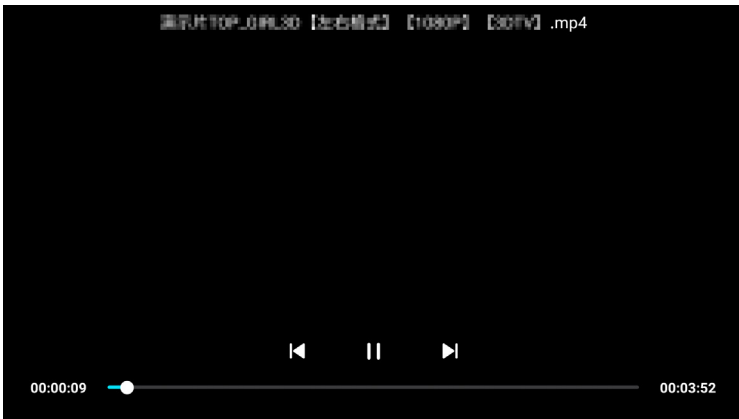

Operation

- If you press the menu button, you can set Image Parameter, Brightness, Video Ratio, Sound Track, Subtitle, and Playback Settings.

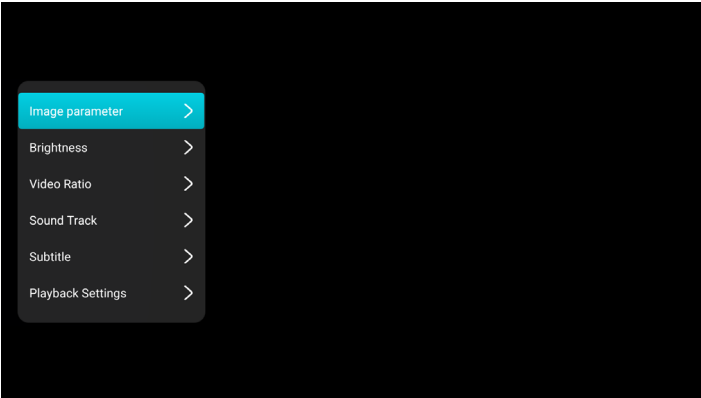

The image parameters are the same as those in Display Settings > Image Parameters.
 Brightness Mode: Standard, Demo, and Eco
 Video Ratio: Adaptive Screen and Full Screen
 Sound Track: You can select a sound track.
 Subtitle: You can select an add-on subtitle.
 The following figure shows the Playback Settings.

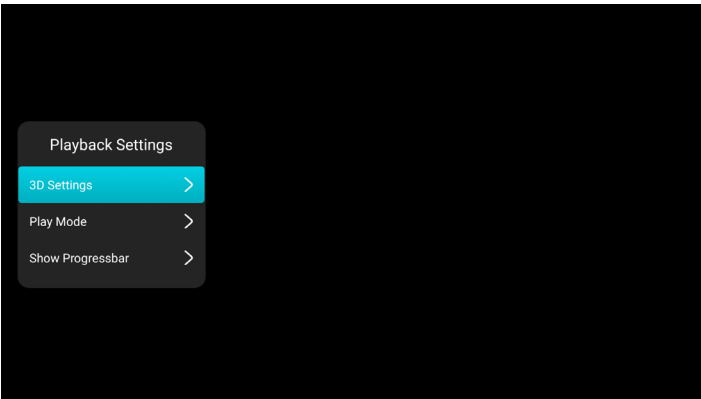

Playback Settings	
Function	Attribute Value
3D Settings	3D Off, Left Right, Top Bottom, Frame Encapsulation, 3D Type, Eye reversal, and 3D Sync
Playback Mode	Repeat All and Loop
Show Progress bar	On and Off

Operation

7. Press the menu button of HDMI to display the OSD menu.

HDMI OSD menu	
Function	Attribute Value
Image Parameter	Settings > Display Settings > Image Parameters
Brightness	Settings > Display Settings > Brightness
3D Settings	3D Settings in OSD of the played video
HDMI2.0	On and Off
Keystone Correction	Settings > Display Settings > Keystone Correction
Lens Focus	Settings > Display Settings > Lens Focus
Projection Mode	Settings > Display Settings > Projection Mode
Screen Ratio	Native, Full, 4:3, 16:6, 16:9, and 16:10
RGB Range	Auto, 0-255, and 16-235

8. If no local video is played, press and hold the menu button to display the local OSD menu.

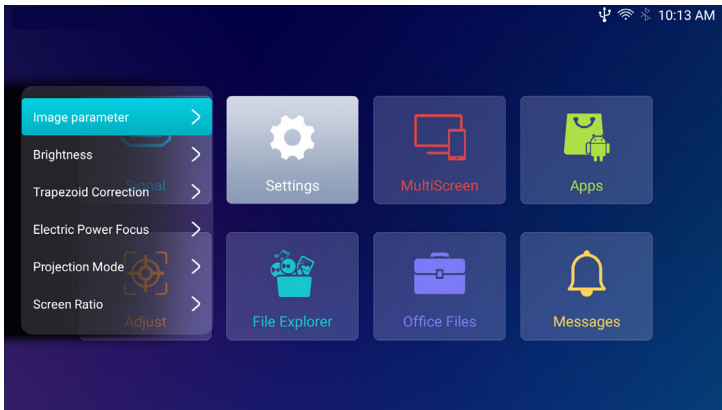

Operation

System

Click the System icon. The options on this page include Network, Bluetooth, Display, General, Sound, and Signal Source.

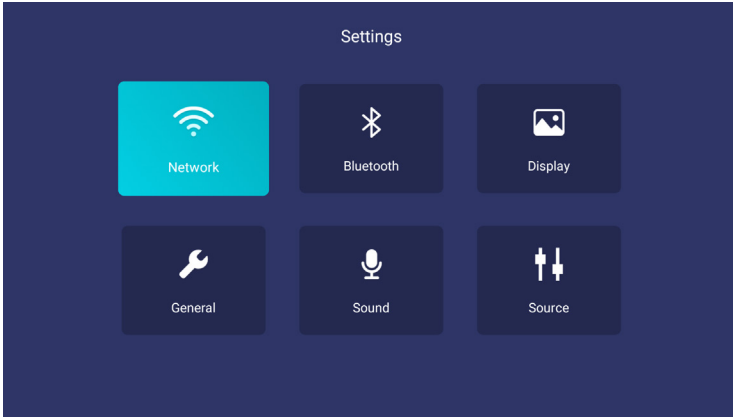

I. Network

Select Network and click the OK button to enter the network settings page.

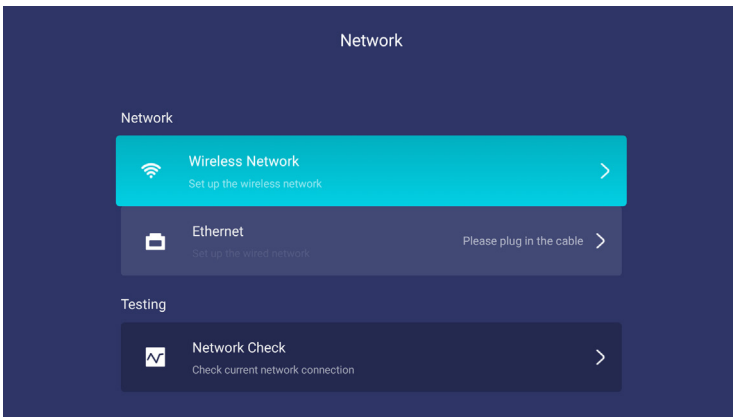

Operation

(1) Wi-Fi

On the Wi-Fi page, click the connected Wi-Fi network to set the static IP address.

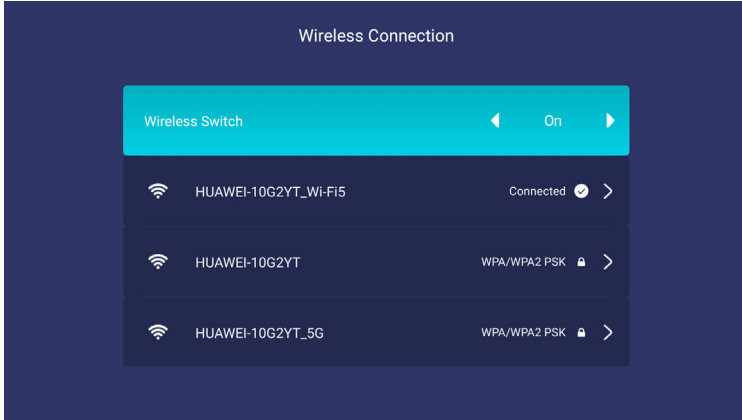

(2) Ethernet

After the Ethernet is successfully connected, click the Ethernet icon to set the static IP address.

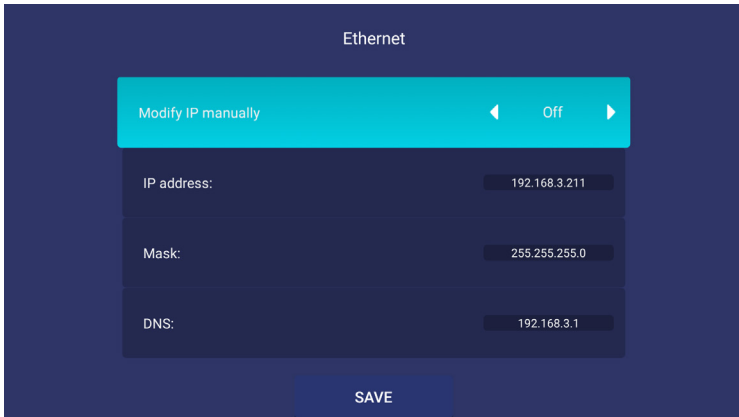

Operation

(3) Check network

Click the Check network icon to check the connected network and ensure that the network is successfully connected.

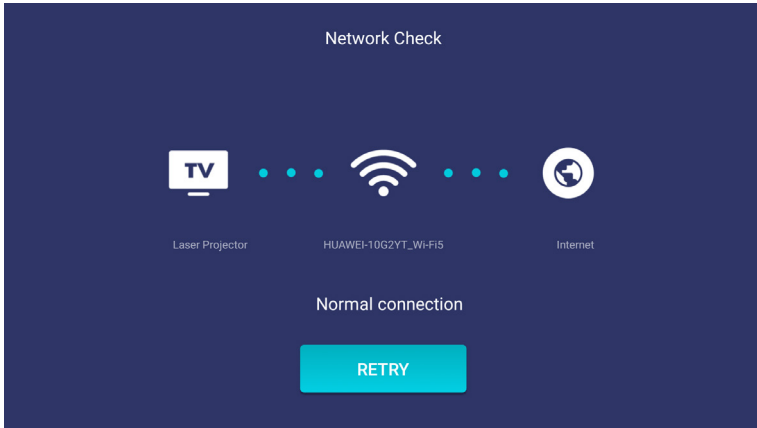

II. Bluetooth

If Bluetooth is set to On, audio can be output to the connected device through Bluetooth. You can enable Search for Devices to search for a device. The search result lists the found Bluetooth devices.

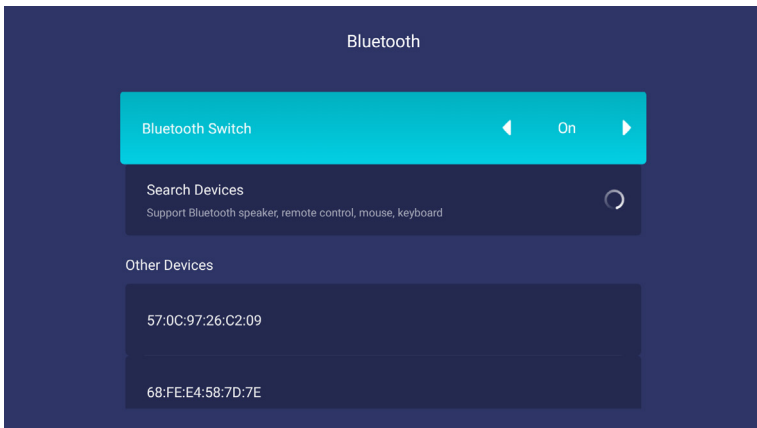

Operation

III. Display Settings

Select Display Settings and click the OK button to enter the display settings page. The options on this page include Brightness Mode, Image Parameters, Keystone Correction, Lens Focus, Projection Mode, Contrast Enhancement, High Altitude Mode, Test Picture, and Solid Color Picture.

(1) Brightness Mode

In the Brightness Mode option, you can set the brightness of the projected image to Standard, Demo, or Eco.

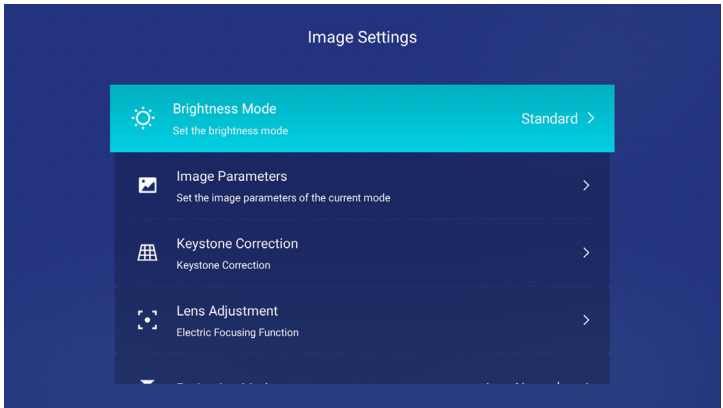

(2) Image Parameters

In the Image Parameters option, you can set the projected image to Standard, Cinema, Color, DICOM, and Custom.

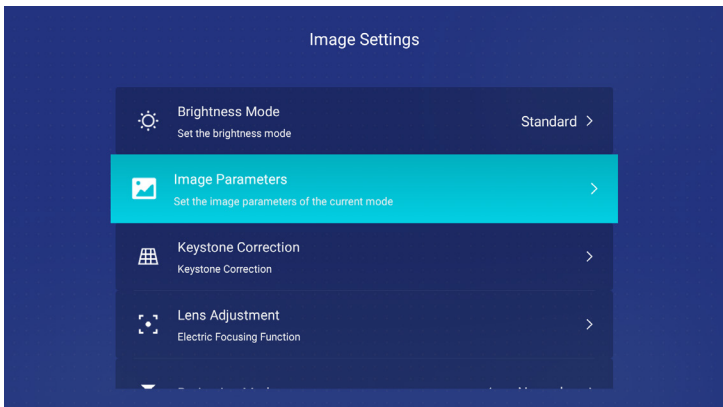

Operation

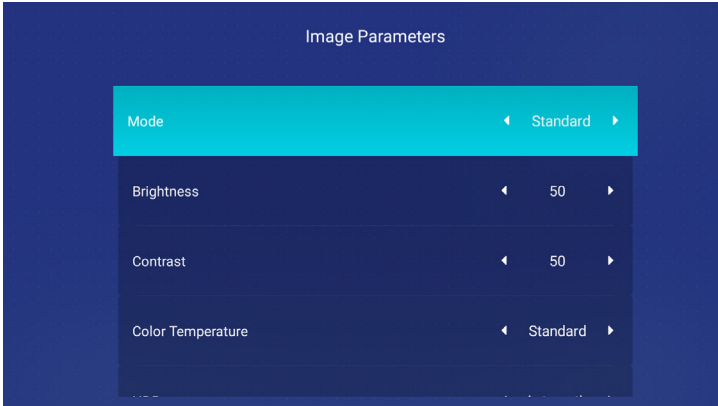
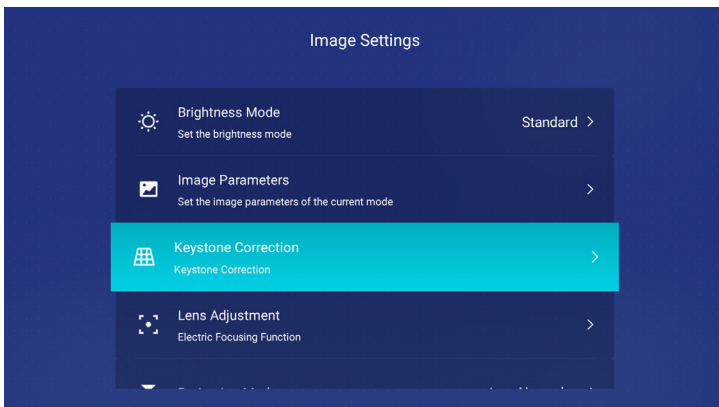

Image Parameters Menu	
Mode	Attribute value
Mode	Standard, Cinema, Color, DICOM, and Custom
Brightness	0-100
Contrast	0-100
Saturation	0-100
Sharpness	0-100
Tone	0-100
Color Temperature	Standard, Warm, Cool, and Custom
HDR	Auto, Off, and On

(3) Keystone Correction

You can correct the device in Keystone Correction. The options include Vertical & Horizontal, Eight Point, and Reset.



Operation

(4) Lens Focus

The options include Shift, Center, Zoom, and Focus.

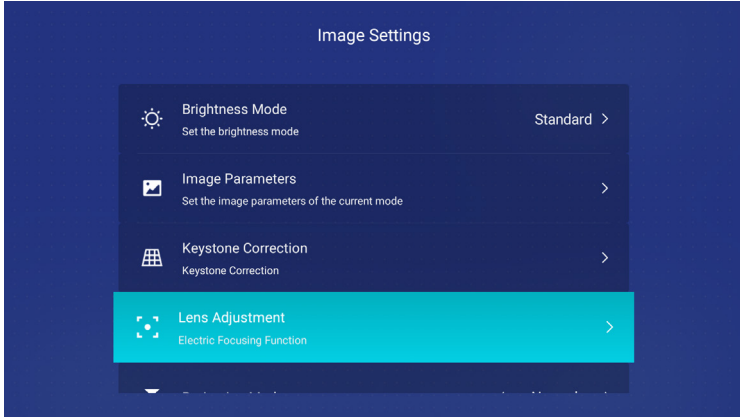

(5) Projection Mode

You can set the projection mode to Desktop front, Desktop rear, Ceiling front, Ceiling rear based on the device installation mode.

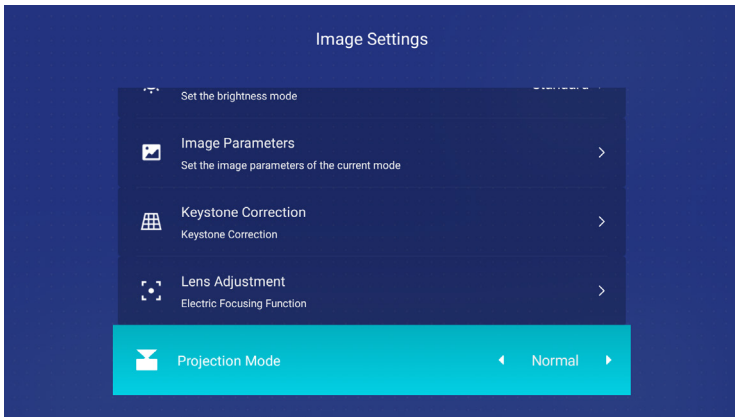

Operation

(6) Dynamic Contrast

When Dynamic Contrast is set to On, it can improve the real-time contrast of the display screen and improve the display effect.

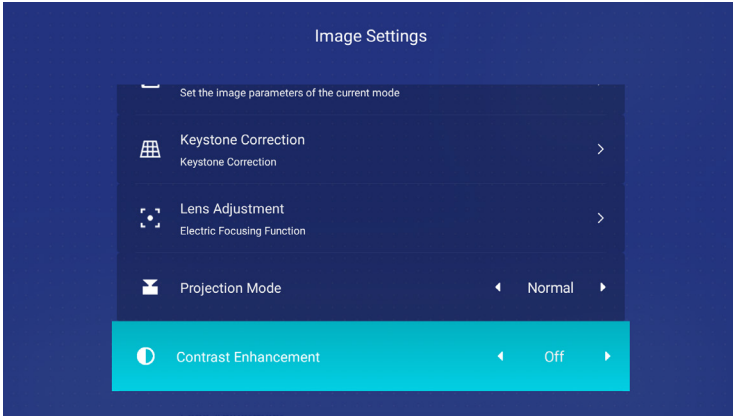

(7) High Altitude Mode

When using the projector in a high-altitude area, enable the high altitude mode.

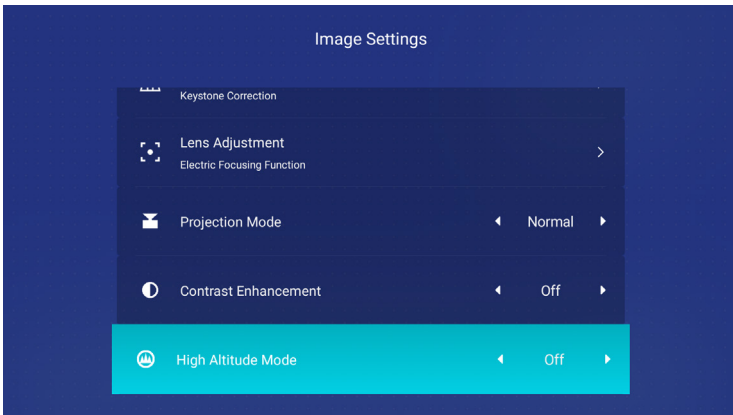

Operation

(8) Test Picture

You can display the test pattern to check the display performance of the projector.

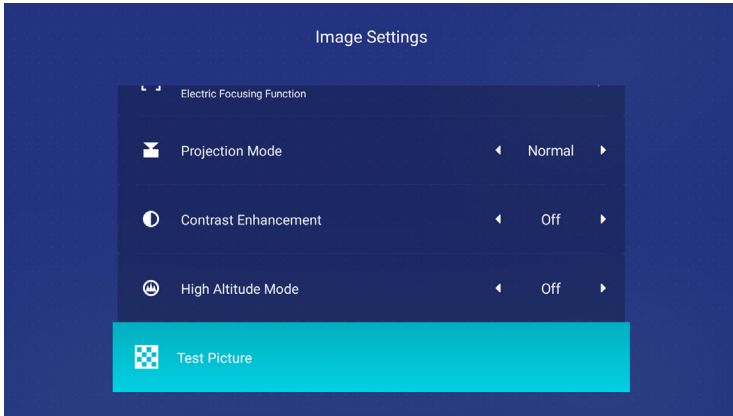

(9) Solid Color Picture

You can view the monochrome display effect of the projector in Solid Color Picture.

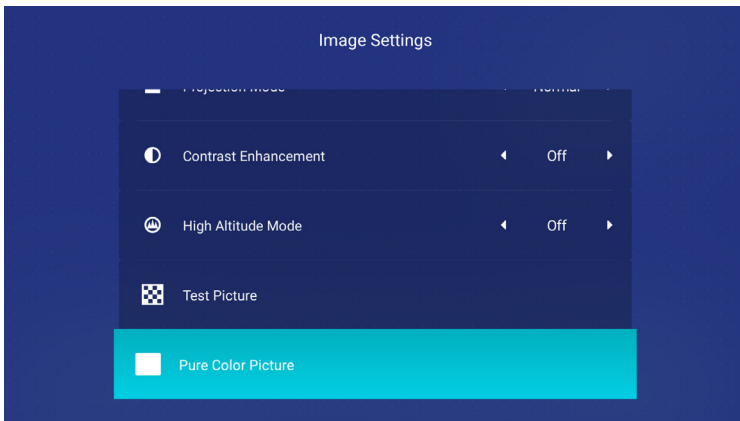

Operation

IV. General

The options include System Version, Update from USB Drive, Device Name, AppoCast Device Name, Network Control, Input Method, Lock Screen, Sleep, Time Form, Time Zone Selection, Language, Unknown Sources, About, and Restore to Factory Defaults.

(1) System Version

The system supports online update. Upon detecting a new system version, the system prompts for online update.

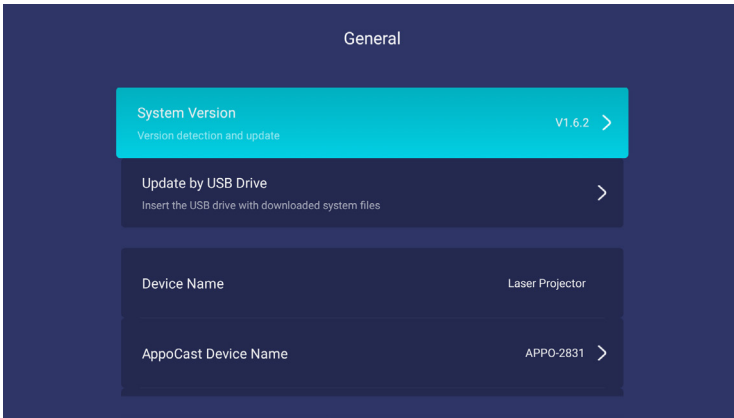

If the current version is the latest, a prompt is displayed.

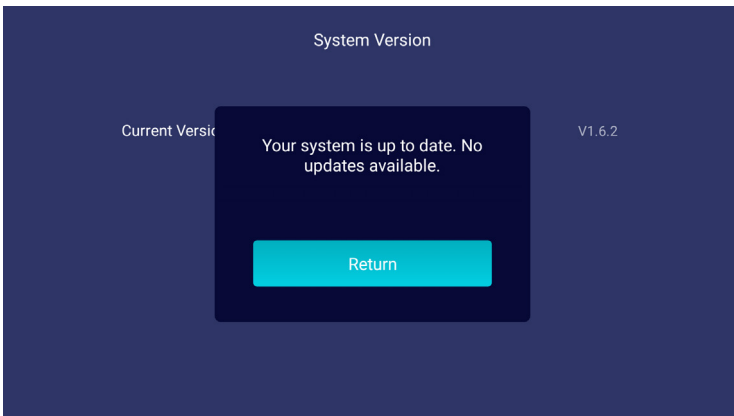

Operation

(2) Update from USB Drive

The system supports local update from the USB drive. You can place the latest system version in the root directory of the USB drive for local update.

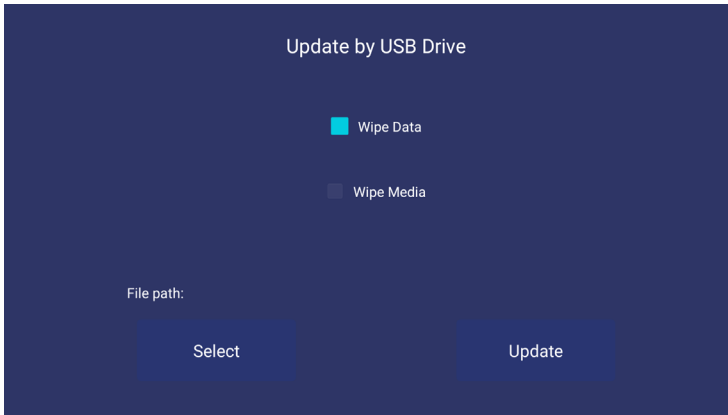
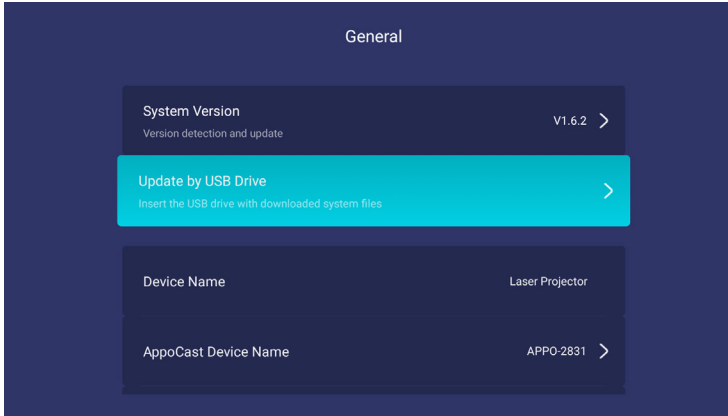

Operation

(3) Device Name

You can view the name of the current device.

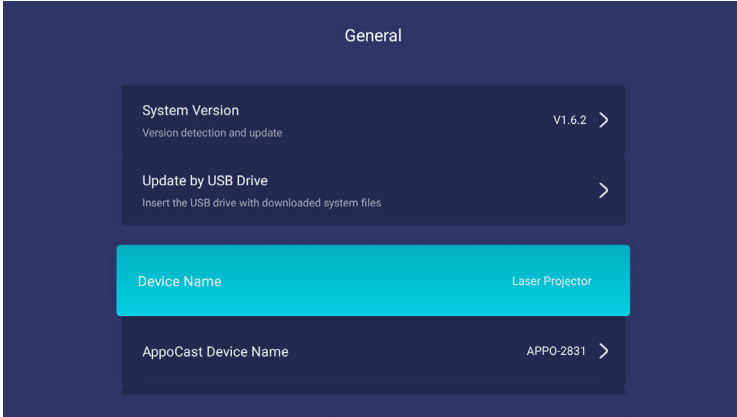

(4) AppoCast Device Name

You can set the AppoCast device name.

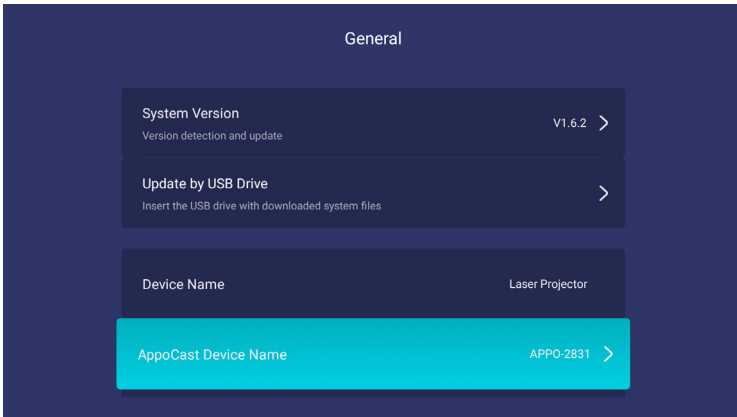

Operation

(5) Network Control

After Network Control is enabled, you can use the network control functions.

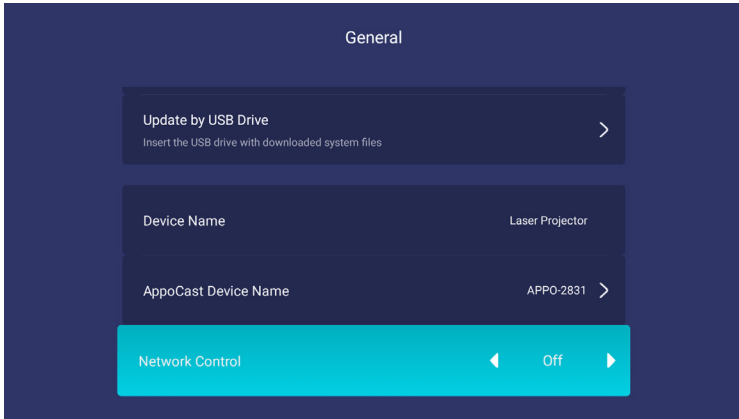

(6) Input Method

You can view the current input method. If another input method is downloaded, select the desired input method as the default input method on this page.

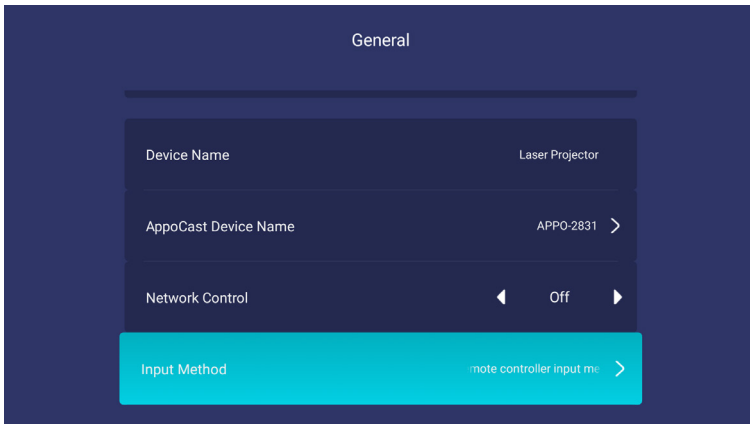

Operation

(7) Lock Screen

The screensaver time can be set to Close, 4 min, 8 min, and 12 min.

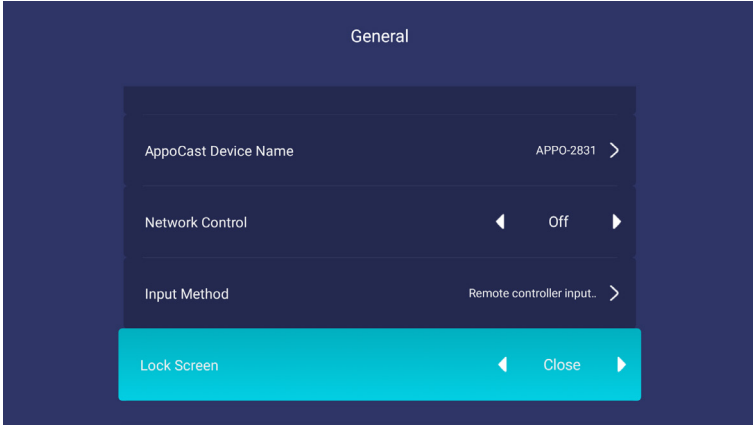

(8) Sleep

The options include Close, 30 min, or 1 hour. If the device is not operated within 30 min or 1 hour, the system automatically turns off the screen.

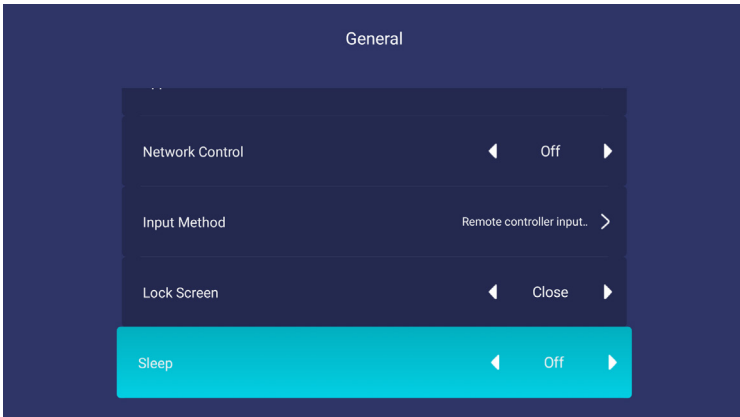

Operation

(9) Time Form

The options include 12-hour Format and 24-hour Format.

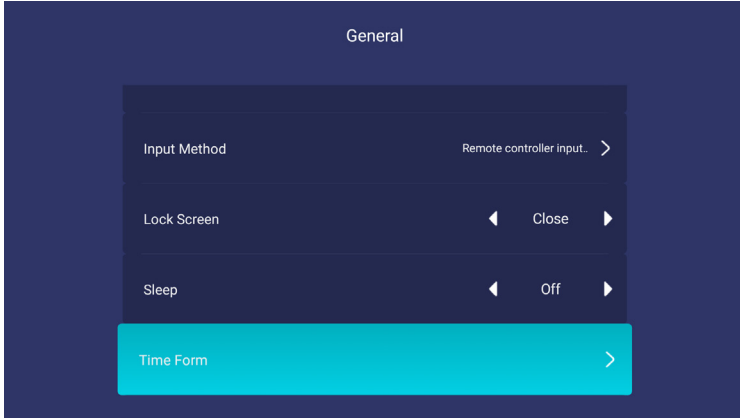

(10) Time Zone Selection

You can set the time zone based on the current location.

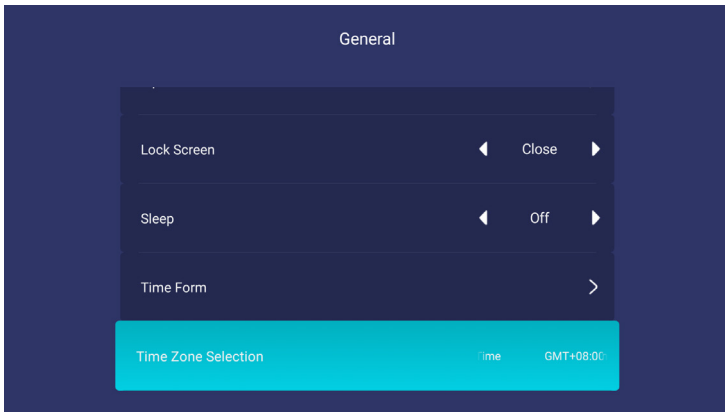

Operation

(11) Language

The language include Chinese Simplified, Chinese Traditional, and English.

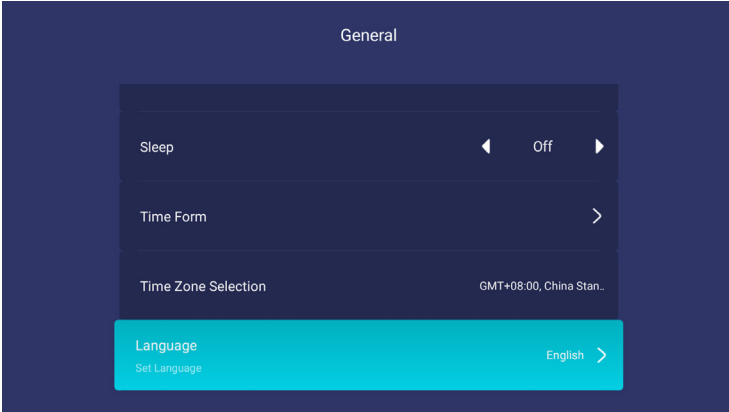

(12) Unknown Sources

To protect the security of user data, the system does not allow the installation of APKs from unknown sources by default. If you need to install a third-party APK, confirm its security, and then manually enable this option before installation.

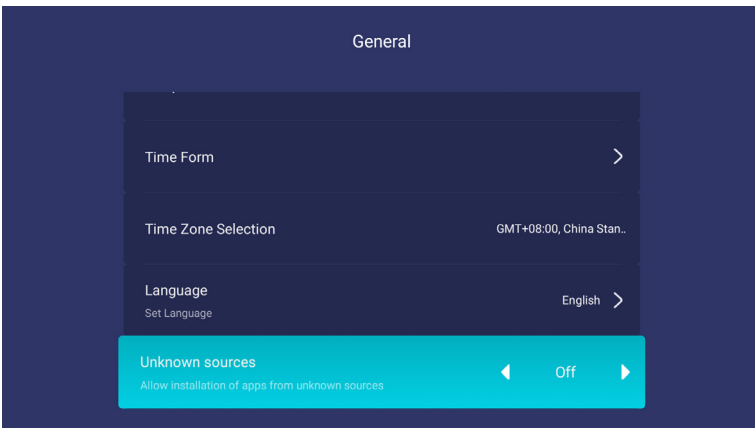

Operation

(13) About

The options include Product SN, Projector Use Time, System Version Information, Disk Information, and Network Information.

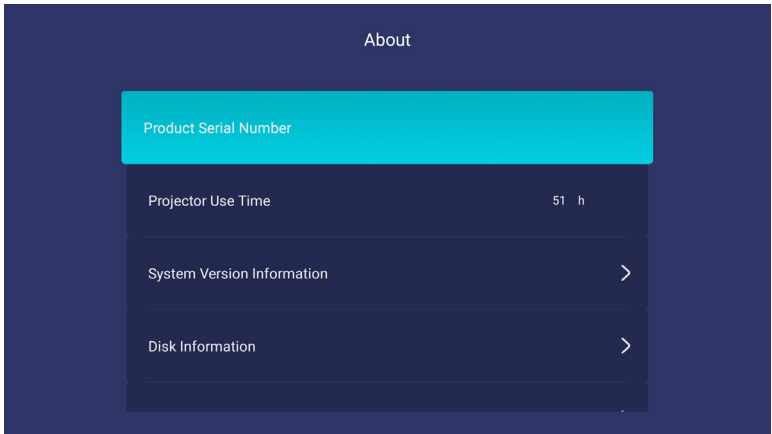
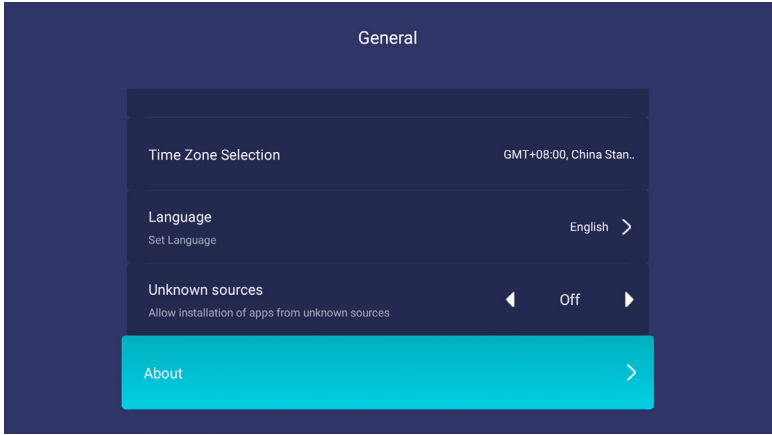

Operation

(14) Restore to Factory Defaults

You can restore the device to factory defaults. Before the restoration, please back up your personal data to avoid unnecessary losses.

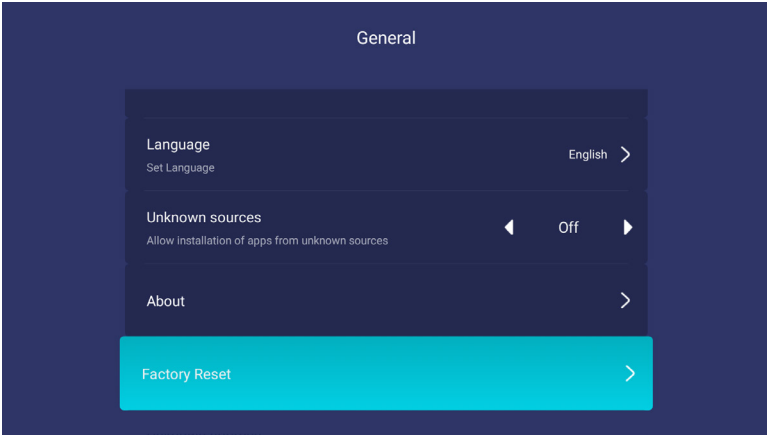

V. Sound

Select Sound and click the OK button to enter the sound settings page. The options include Button Tone and Audio Output.

(1) Button Tone

You can turn on or off the button tone.

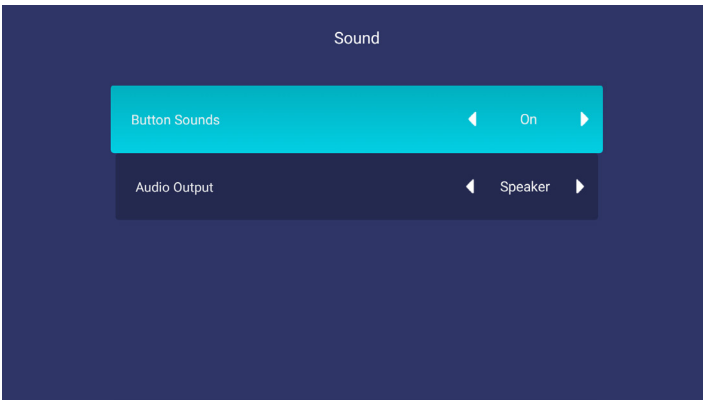

Operation

(2) Audio Output

You can set the audio output to Speaker and SPDIF according to actual situations.

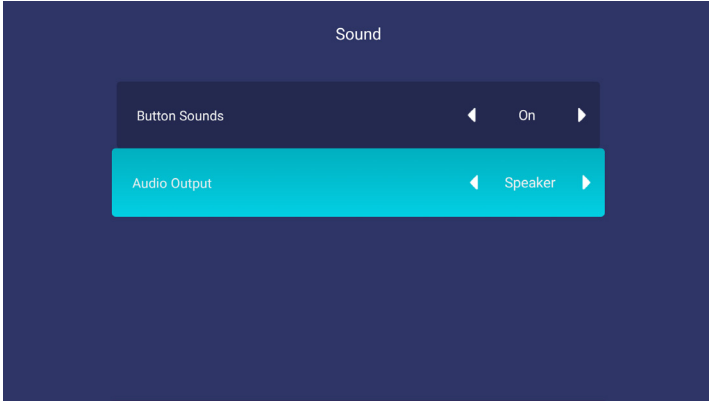

VI. Signal Source

After the DVD player, set-top box, or laptop computer is connected to the HDMI port, you can click the HDMI option corresponding to the Signal Source icon to enter the Signal Source page. The options include HDMI1, HDMI2, and HDBaseT.

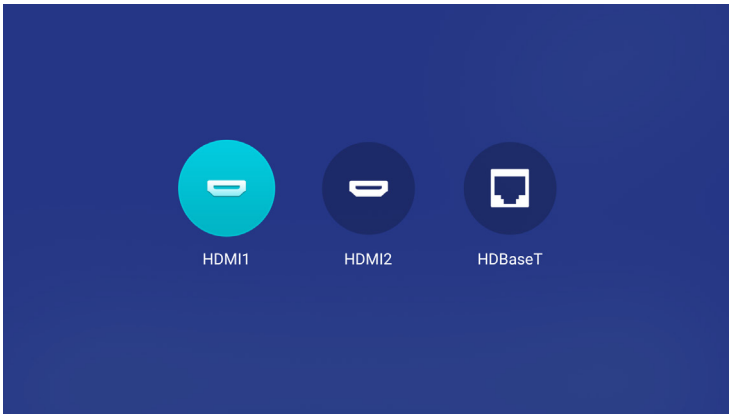

Maintenance

Projector Maintenance

■ Cleaning the lens

Clean the lens as below when the lens surface is stained or dusty.

- ◆ Method 1: Use a compressed air tank to remove dust.
- ◆ Method 2: Fold the cotton paper and dip it with a small amount of absolute ethyl alcohol. Gently rotate the surface of the lens clockwise to wipe it clean with the cotton paper as shown in the figure below:

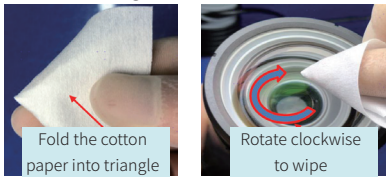

⚠ Caution

- Please do not wipe the lens using other methods.
- After the lens is cleaned, the projector shall be turned on and used after the surface moisture of the product is completely dry.

■ Cleaning the projector enclosure

- ◆ To remove dirt or dust, wipe the enclosure with a soft, lint-free cloth.
- ◆ To remove strong dirt or spots, wet the soft cloth using water and neutral pH detergent, and then wipe the enclosure.

⚠ Caution

- Do not use wax, alcohol, benzene, thinner, or other chemical cleaners which can damage the enclosure.

■ Storing the projector

If you need to store the projector for a long period of time, follow the instructions below:

- ◆ Ensure that the temperature and humidity of the storage area are within the recommended range for the projector.
- ◆ Retract the adjustment feet.
- ◆ Take out the battery from the remote control.
- ◆ Use the projector's original packaging or equivalent material to package the projector.

■ Transporting the projector

It is recommended to use the original packaging or equivalent material when transporting the projector.

Troubleshooting

Failure Symptoms	Causes	Solutions
Unable to power on	The indicator light does not light up	Replace the power cable and use the correct supply voltage
	The indicator light flashes	Read the flashing light messages and troubleshoot accordingly
	The indicator light is always on	Contact customer service for troubleshooting
No image	Wrong signal input source is selected	Select the correct input source
	Abnormal termination port of the signal source device	Replace the terminal port of signal source device
Fuzzy image	The focus is not set properly	Adjust the focus of the screen until it is clear
	Excessive use of the Keystone Correction function	Adjust the position of hanger to reduce the use of Keystone Correction function
	The Clear Type Text is turned on on the computer	Cancel the Clear Type function on computer
Deformed image	No matched signal source is input	Confirm whether the signal input matches the projection resolution
	The graphics card is not set correctly	Contact customer service for more information about changing graphics card settings
	The surface of lens is dirty	Refer to the "Cleaning the lens" section of this manual to clean the projector lens
Low brightness	Nonstandard mode is used	Switch to standard mode
	Brightness and contrast should be adjusted to below 50	Adjust the brightness and contrast to 50
Remote control problem	The remote control receiver is covered by blocking	Remove the blocking cover
	The operation angle of the remote control is too large or the remote control distance is too far	The operating angle shall be less than $\pm 30^\circ$ and the distance shall be less than 5 meters
	The remote control has no batteries in it, the batteries are reversed or the batteries are low	Place the new battery in the correct direction
	Interference from the infrared electronic whiteboard	Turn on the projector first, then turn on the whiteboard or use the central control device to control the projector
Uncontrollable serial port or network port	Central control command or baud rate is set improperly.	Check settings
	Unchecked Hexadecimal transmission	Check Hexadecimal transmission
	Bad or miswired serial cable	Replace the serial port cable or change the wire
	Network port number is not selected	Enter the correct network port number

Product Specification

Items	Specification Parameters
Projection display	DLP
Resolution	3840×2160
Light Source Type	Laser source
Light source technology	ALPD*
Lens projection ratio	1.52-2.45
Zoom magnification	1.6×
Projection dimension	50-300"
Lens adjustment	Electric displacement, zoom and focus
Projection mode	Desktop front, desktop rear, ceiling front, ceiling rear
Trapezoidal correction ^{*1}	Vertical, horizontal, four-point and eight-point
Video input ^{*2}	HDMI×2; HDBaseT×1
Projector Control	LAN(RJ45)×1; RS232(DB9)×1; USB(Type B)×1; 3D SYNC×2(in/out); 3D IR OUT×1
Audio interface	S/PDIF×1
Audio output	Built-in Speaker,1x10W
Projector noise ^{*3}	≤36dB(A)
Input voltage	100-240VAC, 50/60Hz
Rated power ^{*4}	450W
Standby power consumption	≤0.5W
Ambient Temperature ^{*5}	0°C-40°C
Ambient humidity	10%-85%, no condensation
Working altitude	0-5000m
Overall dimension	438mm×334mm×99mm(without support) 438mm×334mm×111mm(with support)
Weight	Approx. 10.1Kg
<p>*1 Some models do not support horizontal, four-point and eight-point correction functions. *2 The HDBaseT function is optional for some models. *3 The reference standard is ISO7779-2010, the ambient temperature is 25 degree and there is 1 meter away from the projector. The projector is set to the demo mode. *4 Set the projector to demo mode. *5 When the ambient temperature continues to be higher than 35°C, the output brightness of the projector will decrease.</p>	

Appendix: Control port

The interface board of the projector provides a RS232 serial port and a LAN cable port, through which you can control the projector on the external central control device.

Serial port

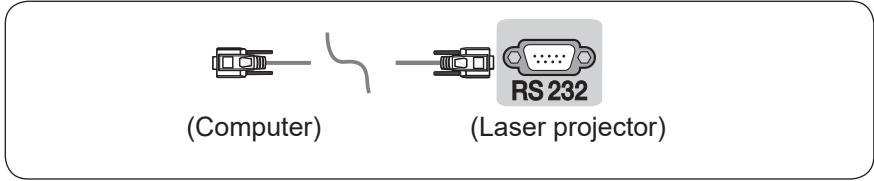

RS232 connection diagram

The projector is connected using the DB9 female connector.

One end of the straight-through cable connected to the projector is DB9 male connector, and the other end is DB9 female connector.

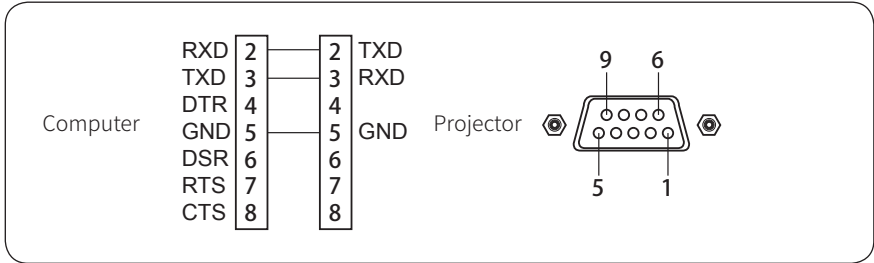

* Jack 1 and Jack 9 are not connected.

Serial port settings

Communication type	Serial port RS232
Baud rate	115200
Parity bit	None
Data bit	8 bits
Stop bit	1 bit

LAN port settings

The LAN port is the RJ45 port that adopts the TCP/IP protocol, and the network port is Port 4352.

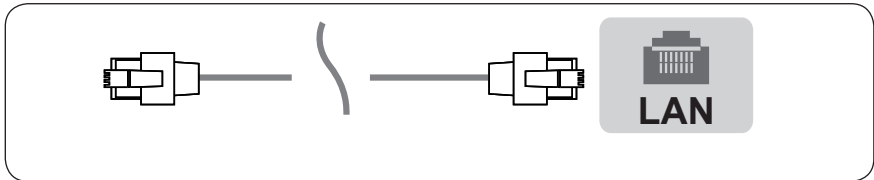

Appendix:Control port

Reference Command List

Function	Specific function	Hexadecimal instructions
Power-on/ off	Power-on	41 54 2B 53 79 73 74 65 6D 3D 4F 6E 0D
	Power-off	41 54 2B 53 79 73 74 65 6D 3D 4F 66 66 0D
	Querying the power-on/off status	41 54 2B 53 79 73 74 65 6D 3F 0D
Turning on/ off the laser	Turning on the laser	41 54 2B 4C 69 67 68 74 53 6F 75 72 63 65 3D 4F 6E 0D
	Turning off the laser	41 54 2B 4C 69 67 68 74 53 6F 75 72 63 65 3D 4F 66 66 0D
	Querying the laser status	41 54 2B 4C 69 67 68 74 53 6F 75 72 63 65 3F 0D
Switching signal sources	Main Page	41 54 2B 53 69 67 6E 61 6C 43 68 61 6E 6E 65 6C 3D 4E 6F 6E 65 3A 30 0D
	HDMI1	41 54 2B 53 69 67 6E 61 6C 43 68 61 6E 6E 65 6C 3D 48 44 4D 49 3A 31 0D
	HDMI2	41 54 2B 53 69 67 6E 61 6C 43 68 61 6E 6E 65 6C 3D 48 44 4D 49 3A 32 0D
	HDBaseT	41 54 2B 53 69 67 6E 61 6C 43 68 61 6E 6E 65 6C 3D 48 44 42 61 73 65 54 3A 31 0D
	Query	41 54 2B 53 69 67 6E 61 6C 43 68 61 6E 6E 65 6C 3F 0D
Volume	Setting the volume	41 54 2B 56 6F 6C 75 6D 65 3D [hexadecimal VAL] 0D
	Querying the volume	41 54 2B 56 6F 6C 75 6D 65 3F 0D
Volume control	Mute	41 54 2B 56 6F 6C 75 6D 65 43 6F 6E 74 72 6F 6C 3D 4D 75 74 65 0D
	Unmute	41 54 2B 56 6F 6C 75 6D 65 43 6F 6E 74 72 6F 6C 3D 55 6E 4D 75 74 65 0D
	Volume+*1	41 54 2B 56 6F 6C 75 6D 65 43 6F 6E 74 72 6F 6C 3D 50 6C 75 73 0D
	Volume-*1	41 54 2B 56 6F 6C 75 6D 65 43 6F 6E 74 72 6F 6C 3D 52 65 64 75 63 65 0D
Projection Mode	Desktop front	41 54 2B 49 6E 73 74 61 6C 6C 61 74 69 6F 6E 4D 6F 64 65 3D 54 61 62 6C 65 46 72 6F 6E 74 0D
	Desktop rear	41 54 2B 49 6E 73 74 61 6C 6C 61 74 69 6F 6E 4D 6F 64 65 3D 54 61 62 6C 65 52 65 61 72 0D
	Ceiling front	41 54 2B 49 6E 73 74 61 6C 6C 61 74 69 6F 6E 4D 6F 64 65 3D 43 65 69 6C 69 6E 67 46 72 6F 6E 74 0D
	Ceiling rear	41 54 2B 49 6E 73 74 61 6C 6C 61 74 69 6F 6E 4D 6F 64 65 3D 43 65 69 6C 69 6E 67 52 65 61 72 0D
	Querying projection mode	41 54 2B 49 6E 73 74 61 6C 6C 61 74 69 6F 6E 4D 6F 64 65 3F 0D

Appendix:Control port

Reference Command List

Function	Specific function	Hexadecimal instructions
Video ratio	Native	41 54 2B 41 73 70 65 63 74 52 61 74 69 6F 3D 4E 61 74 69 76 65 0D
	Fill	41 54 2B 41 73 70 65 63 74 52 61 74 69 6F 3D 46 69 6C 6C 0D
	4:3	41 54 2B 41 73 70 65 63 74 52 61 74 69 6F 3D 34 5F 33 0D
	16:6	41 54 2B 41 73 70 65 63 74 52 61 74 69 6F 3D 31 36 5F 36 0D
	16:9	41 54 2B 41 73 70 65 63 74 52 61 74 69 6F 3D 31 36 5F 39 0D
	16:10	41 54 2B 41 73 70 65 63 74 52 61 74 69 6F 3D 31 36 5F 31 30 0D
	Query	41 54 2B 41 73 70 65 63 74 52 61 74 69 6F 3F 0D
Lens shift	Shift to left	41 54 2B 4D 6F 74 6F 72 53 68 69 66 74 3D 4C 65 66 74 3A [hexadecimal VAL] 0D
	Shift to right	41 54 2B 4D 6F 74 6F 72 53 68 69 66 74 3D 52 69 67 68 74 3A [hexadecimal VAL] 0D
	Shift to up	41 54 2B 4D 6F 74 6F 72 53 68 69 66 74 3D 55 70 3A [hexadecimal VAL] 0D
	Shift to down	41 54 2B 4D 6F 74 6F 72 53 68 69 66 74 3D 44 6F 77 6E 3A [hexadecimal VAL] 0D
Center the lens	Vertical center	41 54 2B 4D 6F 74 6F 72 43 65 6E 74 65 72 3D 53 68 69 66 74 56 65 72 74 69 63 61 6C 3A 30 0D
	Horizontal center	41 54 2B 4D 6F 74 6F 72 43 65 6E 74 65 72 3D 53 68 69 66 74 48 6F 72 69 7A 6F 6E 74 61 6C 3A 30 0D
Lens zooming	Forward rotation for zooming (scale)	41 54 2B 4D 6F 74 6F 72 5A 6F 6F 6D 3D 46 72 6F 6E 74 3A [hexadecimal VAL] 0D
	Reverse rotation for zooming (scale)	41 54 2B 4D 6F 74 6F 72 5A 6F 6F 6D 3D 42 61 63 6B 3A [hexadecimal VAL] 0D
Lens focusing	Forward rotation for focusing	41 54 2B 4D 6F 74 6F 72 46 6F 63 75 73 3D 46 72 6F 6E 74 3A [hexadecimal VAL] 0D
	Reverse rotation for focusing	41 54 2B 4D 6F 74 6F 72 46 6F 63 75 73 3D 42 61 63 6B 3A [hexadecimal VAL] 0D
Information acquisition	Device info	41 54 2B 64 65 76 69 63 65 49 6E 66 6F 3F 0D
*1 The step length of each increase and decrease is 10.		

Federal Communications Commission (FCC) Statement

This device complies with part 15 of the FCC Rules. Operation is subject to the following two conditions: (1) This device may not cause harmful interference, and (2) this device must accept any interference received, including interference that may cause undesired operation.

Note: This equipment has been tested and found to comply with the limits for a Class B digital device, pursuant to part 15 of the FCC Rules. These limits are designed to provide reasonable protection against harmful interference in a residential installation. This equipment generates, uses and can radiate radio frequency energy and, if not installed and used in accordance with the instructions, may cause harmful interference to radio communications. However, there is no guarantee that interference will not occur in a particular installation. If this equipment does cause harmful interference to radio or television reception, which can be determined by turning the equipment off and on, the user is encouraged to try to correct the interference by one or more of the following measures:

- Reorient or relocate the receiving antenna.
- Increase the separation between the equipment and receiver.
- Connect the equipment into an outlet on a circuit different from that to which the receiver is connected.
- Consult the dealer or an experienced radio/TV technician for help.

Warning: Changes or modifications made to this device not expressly approved by APPOTRONICS CO., LTD may void the FCC authorization to operate this device.

Note: The manufacturer is not responsible for any radio or TV interference caused by unauthorized modifications to this equipment. Such modifications could void the user's authority to operate the equipment.

RF exposure statement:

The transmitter must not be colocated or operated in conjunction with any other antenna or transmitter. This equipment complies with the FCC RF radiation exposure limits set forth for an uncontrolled environment. This equipment should be installed and operated with a Minimum distance of 20cm between the radiator and any part of your body.

ISED Statement

- English: This device complies with Industry Canada license - exempt RSS standard(s). Operation is subject to the following two conditions: (1) This device may not cause interference, and (2) This device must accept any interference, including interference that may cause undesired operation of the device.

The digital apparatus complies with Canadian CAN ICES - 3 (B)/NMB - 3(B).

- French: Le présent appareil est conforme aux CNR d'Industrie Canada applicables aux appareils radio exempts de licence. L'exploitation est autorisée aux deux conditions suivantes: (1) l'appareil ne doit pas produire de brouillage, et (2) l'utilisateur de l'appareil doit accepter tout brouillage radioélectrique subi, même si le brouillage est susceptible d'en compromettre le fonctionnement.

l'appareil numérique du ciem conforme canadien peut - 3 (b) / nmb - 3 (b).

For Receiver:

This device meets the exemption from the routine evaluation limits in section 2.5 of RSS 102 and compliance with RSS 102 RF exposure, users can obtain Canadian information on RF exposure and compliance.

cet appareil est conforme à l'exemption des limites d'évaluation courante dans la section 2.5 du cnr - 102 et conformité avec rss 102 de l'exposition aux rf, les utilisateurs peuvent obtenir des données canadiennes sur l'exposition aux champs rf et la conformité.

This equipment complies with Canada radiation exposure limits set forth for an uncontrolled environment. The device is installed and operated without restriction.

Cet équipement est conforme Canada limites d'exposition aux radiations dans un environnement non contrôlé. Die Installation und der Betrieb der Ausrüstung sind uneingeschränkt.

For Transmitter:

This device meets the exemption from the routine evaluation limits in section 2.5 of RSS 102 and compliance with RSS 102 RF exposure, users can obtain Canadian information on RF exposure and compliance.

cet appareil est conforme à l'exemption des limites d'évaluation courante dans la section 2.5 du cnr - 102 et conformité avec rss 102 de l'exposition aux rf, les utilisateurs peuvent obtenir des données canadiennes sur l'exposition aux champs rf et la conformité.

This equipment complies with Canada radiation exposure limits set forth for an uncontrolled environment. The device is installed and operated without restriction.

Cet équipement est conforme Canada limites d'exposition aux radiations dans un environnement non contrôlé. Die Installation und der Betrieb der Ausrüstung sind uneingeschränkt.