

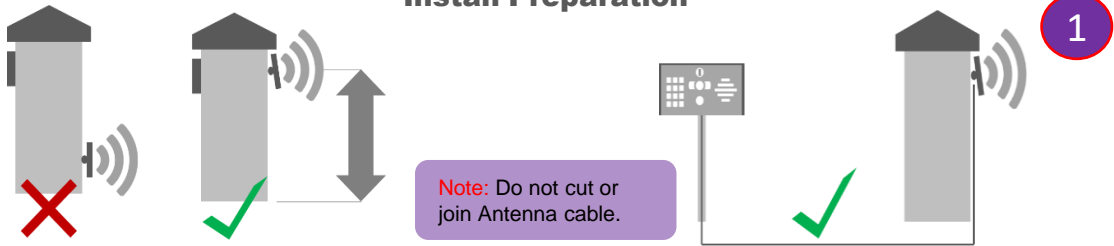

STILL HAVING TROUBLE?
Find all of our support options such as Web Chat, Full Manuals, Customer Helpline and more on our website:
WWW.AESGLOBALUS.COM

* ALWAYS TEST THE UNIT ON SITE BEFORE INSTALLATION TO AVOID RESTOCKING FEES *

Install Preparation



Mount the antenna as high as possible and away from obstructions such as vehicles, shrubs and trees to maximize signal strength.
Do NOT mount antenna at ground level.

SITE SURVEY (WiFi)



I have some WiFi signal at the gate with my phone! If not, STOP. Use LAN/CAT5 cable!

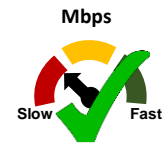

I have at least 1.5Mbps UPLOAD speed. If not, STOP!



My WiFi Internet Security is WPA, WPA2, WPA3 or better.

The Praetorian Guard is specially designed to transmit the video and audio stream using on average 400 KBit/sec (peaking to 1Mbps). This loosely translates to requiring a minimum of 1.5Mbps UPLOAD speed on the network that the intercom is connected to. The higher the upload speed the better quality of image up to approx. 4Mbps.

Relay Connections

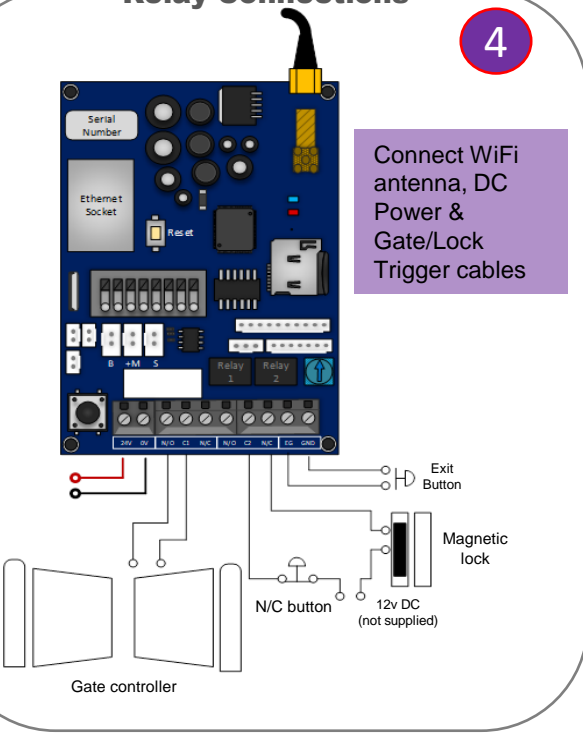

Connect WiFi antenna, DC Power & Gate/Lock Trigger cables

Site Wiring

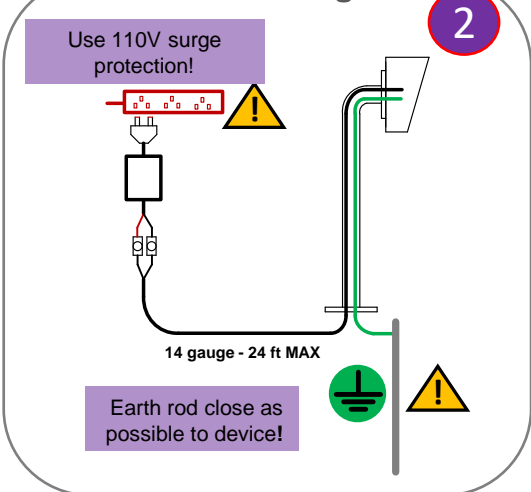

Use 110V surge protection!

Earth rod close as possible to device!

Power

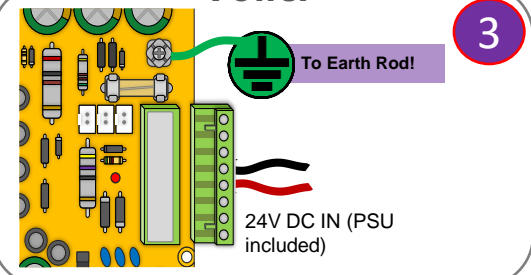

To Earth Rod!

24V DC IN (PSU included)

POWER CABLE

KEEP POWER SUPPLY AS CLOSE AS POSSIBLE.

TIP: Most technical calls received are due to installers using CAT5 or alarm cable to power the unit.

NEITHER are rated to carry enough power! (1.2amp peak)

Please use the following cable:

- Up to 2 metres (6 feet) – Use minimum 0.5mm² (18 gauge)
- Up to 4 metres (12 feet) – Use minimum 0.75mm² (16 gauge)
- Up to 8 metres (24 feet) – Use minimum 1.0mm² (14 gauge)

Power Consumption:
Standby = 96mA
Calling Out = 500mA

EARTHING & INGRESS

This product MUST be EARTHED in the following states in order to qualify for manufacturers warranty

- FL, LA, MS, AR, OK, MO, AL, IL, KY, TN, IN, KS, SC, GA, IA, TX, OH, NC, NE, MD, WV, VA, DE



We recommend sealing all entry holes for prevention of insects that can cause issues with a risk of shorting out components.



To maintain the IP55 rating please follow the sealing instructions included. (also available online)



EXTRA RESOURCES

NEED MORE ASSISTANCE?

+1 (631) 565-7288

SCAN THIS QR CODE TO BE BROUGHT TO OUR RESOURCES PAGE.

VIDEOS | HOW-TO GUIDES | MANUALS | QUICK START GUIDES

LIGHTNING PRONE AREAS MUST USE SURGE PROTECTION FOR POWER SUPPLY!

* ALWAYS TEST THE UNIT ON SITE BEFORE INSTALLATION TO AVOID RESTOCKING FEES *

Install Preparation

1

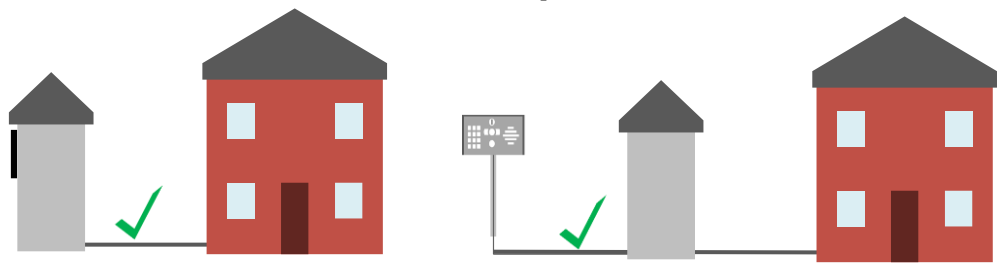

MAX DISTANCE 100m (320ft)

This can be extended by using an ethernet cable extender (purchased separately)

Relay Connections

4

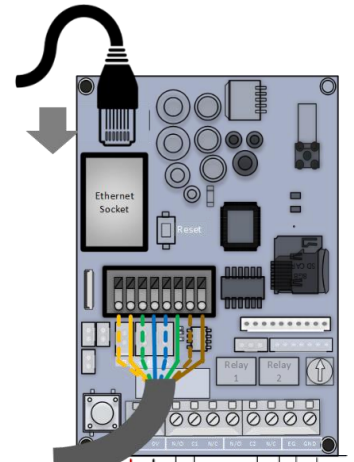

Connect LAN Cable via RJ45 or direct cable.

Connect DC Power & Gate/Lock Trigger cables

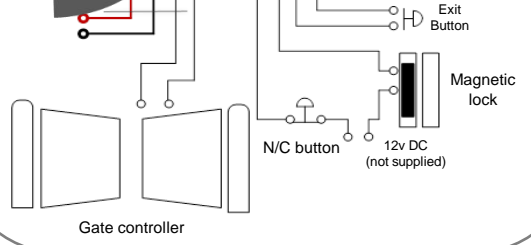

Site Wiring

2

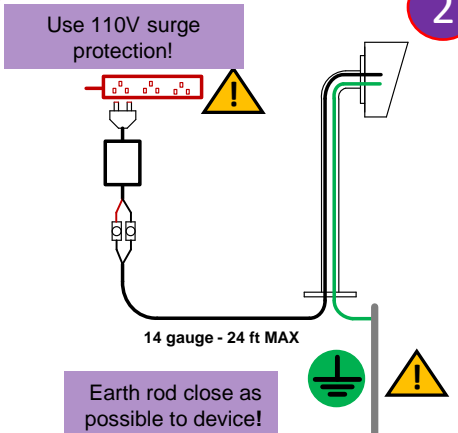

Use 110V surge protection!

14 gauge - 24 ft MAX

Earth rod close as possible to device!

Power

3

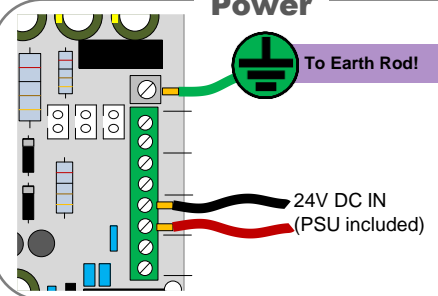

To Earth Rod!

24V DC IN (PSU included)

SITE SURVEY (LAN)



My cable run does not exceed 100m (320ft) in total distance. If it does, STOP!

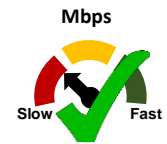

I have at least 1.5Mbps UPLOAD speed. If not, STOP!

POWER CABLE

KEEP POWER SUPPLY AS CLOSE AS POSSIBLE.

TIP: Most technical calls received are due to installers using CAT5 or alarm cable to power the unit.

NEITHER are rated to carry enough power! (1.2amp peak)

Please use the following cable:

- Up to 2 metres (6 feet) – Use minimum 0.5mm² (18 gauge)
- Up to 4 metres (12 feet) – Use minimum 0.75mm² (16 gauge)
- Up to 8 metres (24 feet) – Use minimum 1.0mm² (14 gauge)

Power Consumption:
Standby = 96mA
Calling Out = 500mA

EARTHING & INGRESS

This product MUST be EARTHED in the following states in order to qualify for manufacturers warranty

- FL, LA, MS, AR, OK, MO, AL, IL, KY, TN, IN, KS, SC, GA, IA, TX, OH, NC, NE, MD, WV, VA, DE



We recommend sealing all entry holes for prevention of insects that can cause issues with a risk of shorting out components.



To maintain the IP55 rating please follow the sealing instructions included. (also available online)

2

LIGHTNING PRONE AREAS MUST USE SURGE PROTECTION FOR POWER SUPPLY!



EXTRA RESOURCES

NEED MORE ASSISTANCE?

+1 (631) 565-7288

SCAN THIS QR CODE TO BE BROUGHT TO OUR RESOURCES PAGE.

VIDEOS | HOW-TO GUIDES | MANUALS | QUICK START GUIDES



* ALWAYS TEST THE UNIT ON SITE BEFORE INSTALLATION TO AVOID RESTOCKING FEES *

1 Download the programming/user app. 'Praetorian Guard'



Note: Slight differences will be seen between the Android and iOS app versions, any major differences will be highlighted in the screenshots below.



Add Intercom to Device

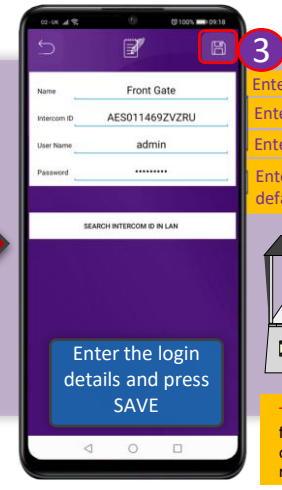
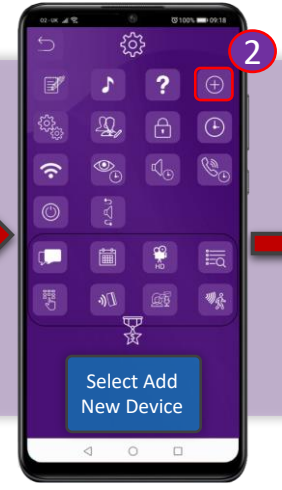
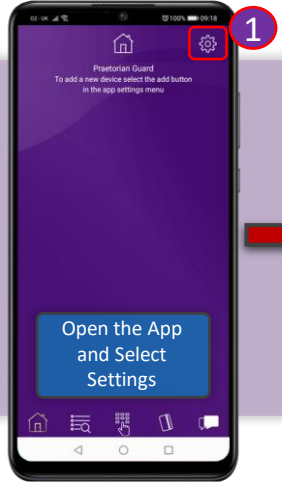

Enter Reference Name
Enter Intercom ID
Enter "admin" for the user
Enter "123456789" as the default password

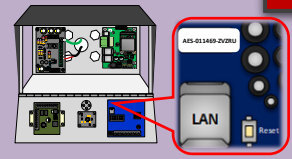

Tip: The intercom ID number can be found on a sticker beside the LAN port connection. (RJ45 connector may need removed to see the full ID.)

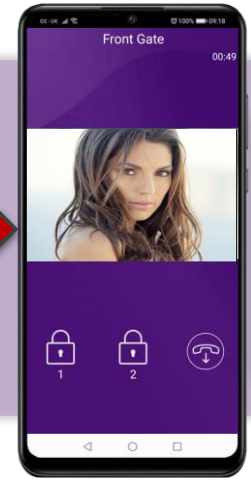
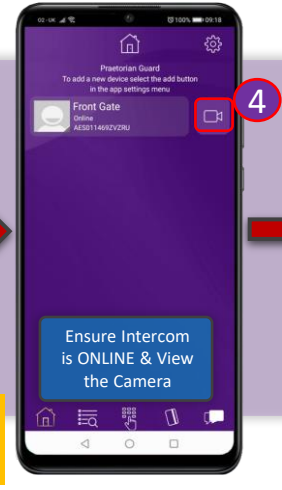

If you can see live video and hear audio, the intercom has successfully connected to the network. If for some reason this does not work, ensure the LAN cable is connected correctly or that you have entered the correct WIFI password.

Time Sync

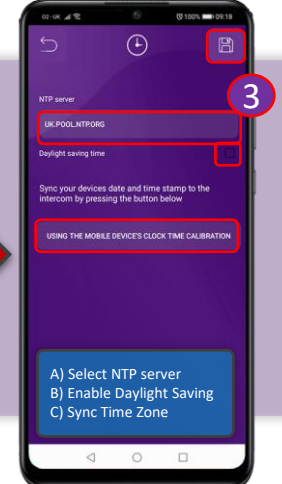
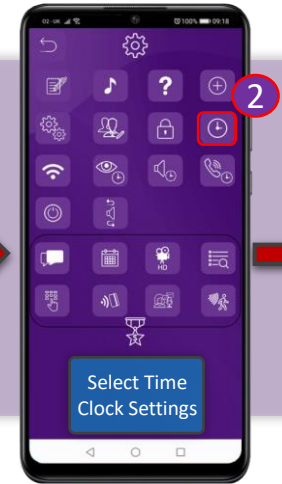
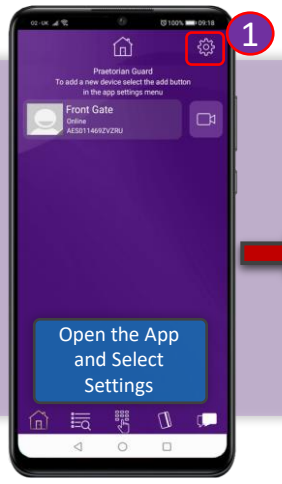

A) Select NTP server
B) Enable Daylight Saving
C) Sync Time Zone

Add Keypad Code *Keypad Models Only

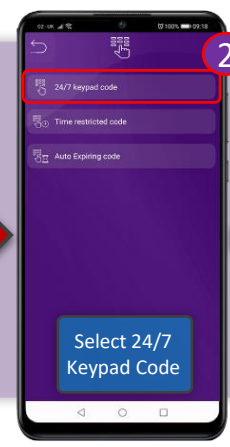
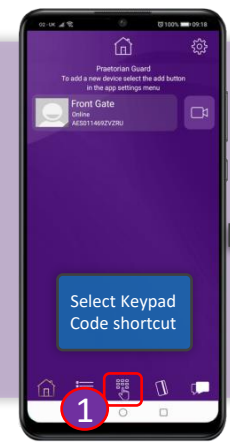

Enter Reference Name
Select Relay Option & Time
Enter 4-6 digit code



STILL HAVING TROUBLE?
Find all of our support options such as Web Chat, Full Manuals, Customer Helpline and more on our website:
WWW.AESGLOBALUS.COM

* ALWAYS TEST THE UNIT ON SITE BEFORE INSTALLATION TO AVOID RESTOCKING FEES *

Download the programming/user app. 'Praetorian Guard'



Note: Slight differences will be seen between the Android and iOS app versions, any major differences will be highlighted in the screenshots below.



Test Keypad Code

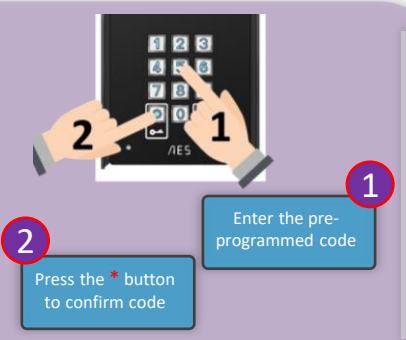

Test Push Notifications & Relay Code



Answering on Android

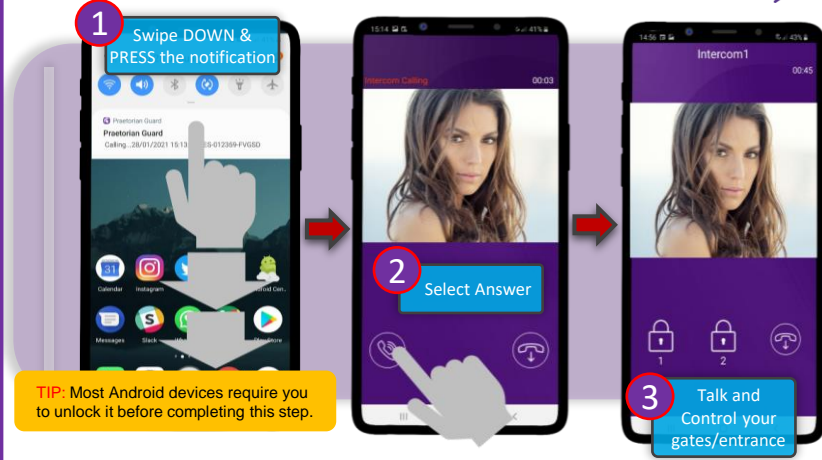

Additional Apple Settings

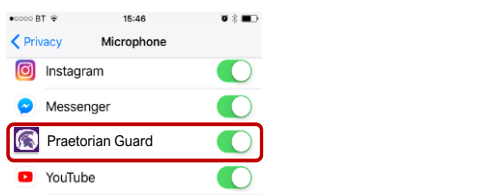

TIP: If there is no voice from the speaker at the gate, check the iPhone microphone permissions in Settings > Privacy / Microphone

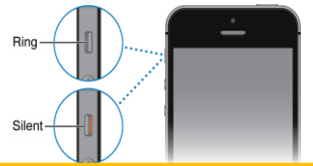

4 TIP: Make sure ringer switch is ON and volume is turned up.

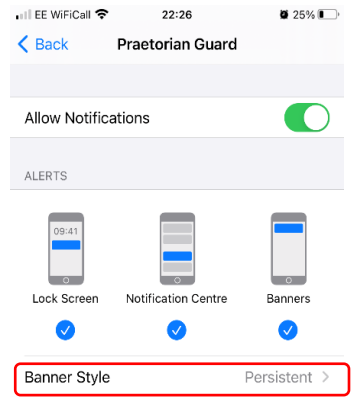

TIP: If you don't get notifications then check the banner style in Settings > Notifications and select Praetorian Guard.

Answering on iOS (Apple)

Note: Various versions of iOS and Android OS will have different notification acceptance techniques. Please refer to online support for your device if needed.

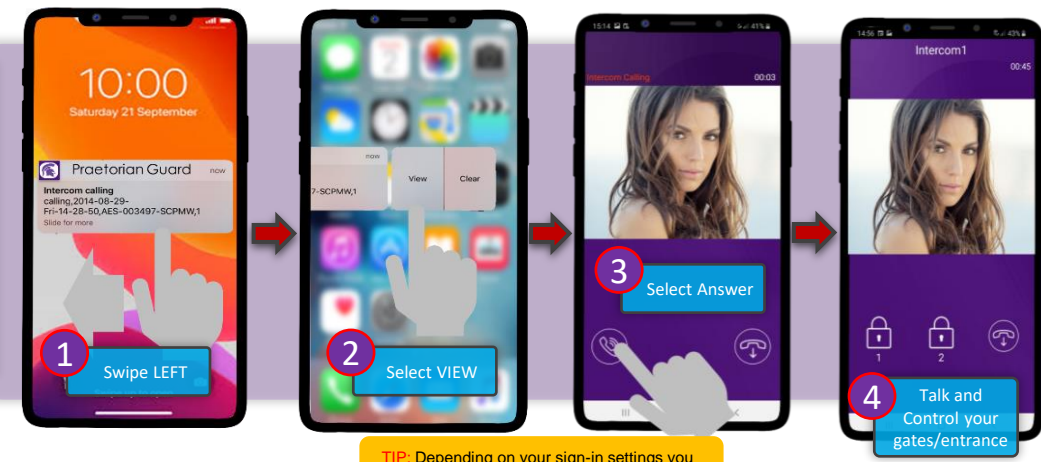



* ALWAYS TEST THE UNIT ON SITE BEFORE INSTALLATION TO AVOID RESTOCKING FEES *



Note: Slight differences will be seen between the Android and iOS app versions, any major differences will be highlighted in the screenshots below.



Adding Additional APP Users: Create User Account

1. Open the App and Select Settings

2. Select Users

3. Select Add New User

4. Enter a Username & Password & Click Save

Admin Device!

INTERCOM MAINTENANCE

Bug ingress is a common issue in unit failures. Ensure that all components are sealed accordingly and check occasionally. **(Do not open the panel in the rain / snow unless correctly equipped to keep the internals dry. Ensure the unit is securely closed after maintenance)**

If you have an AB, AS, ABK, ASK callpoint it will have silver edges which are marine grade stainless steel so in normal weather conditions should not rust however it can dull or discolor over time. This can be polished with a suitable stainless-steel cleaner and cloth.

ENVIRONMENTAL INFORMATION

The equipment that you bought has required the extraction and use of natural resources for its production. It may contain hazardous substances for the environment. In order to avoid the dissemination of those substances in our environment and to diminish the pressure on the natural resources, we encourage you to use the appropriate take-back systems. Those systems will reuse or recycle most of the materials of your end-of-life equipment.

The crossed-bin symbol marked in your device invites you to use those systems.



If you need more information on the collection, reuse and recycling systems, please contact your local or regional waste administration. You can also contact AES Global Ltd for more information on the environmental performances of our products.

Adding Additional APP Users: Add Intercom to New Device

1. Open the App and Select Settings

2. Select Add New Device

3. Enter Intercom details (Name, ID, User Name, Password)

NEW Device!

Note: Maximum 8 separate users and devices.

WARRANTY

Please note, by installing this product, you are accepting the following warranty terms:

1. The manufacturer's warranty is a "return to base" 2 year warranty from date of manufacture. This means that any suspected defective components or items are returned to the manufacturer's agent for investigation and diagnosis and returned at the cost of the customer.
2. The warranty does not cover, nor is the manufacturer or agent responsible for any of the following whatsoever: Storm damage, lightning or surge damage, flooding, accidental damage, vandalism or deliberate damage, un-explained corrosion or unusually harsh environments, failure of telephone networks, future un-interoperability between the product and network providers which cause malfunction due to changes implemented by the phone providers after manufacture of the product, or that which is outside of control of the manufacturer (e.g. 2G, 3G switch off, removal or inability to obtain VOLTE service), and damage due to not proper installation.
3. The manufacturer in no way accepts liability for any of the following incurred due to a product defect: Cost of attending site, inconveniences, labour rates, time lost, loss to or damage to property, security breaches, late payment clauses or breaches of any contracts between the installer and the client.
4. This is a profession install product only. The product is a component of an overall system. Therefore, it is the responsibility of the installer to certify the safety and compliance of the overall finished system. As soon as this product is fixed to another item, or connected to another third-party device, then the product has been modified, and compliance with local regulations in the country of install is strictly the responsibility of the installer.
5. Re-stocking fees may apply to items returned that are found to be non-defective. Complete units will also attract a re-stocking fee if returned for credit, regardless if a defect is discovered or not. Re-stocking fees may vary depending on the condition of the item being returned, and whether it can be determined as in brand new condition. The warranty terms do not entitle customers to an automatic full refund. For more details on returns procedures and re-stocking fees, contact the agent.
6. Items with physical signs of surge damage are not covered by warranty. Items with visible signs of surge damage will only be covered by warranty if photographic evidence is provided from site, showing surge protection has been installed.

Full warranty terms and conditions available upon request to AES Technical Department.

* ALWAYS TEST THE UNIT ON SITE BEFORE INSTALLATION TO AVOID RESTOCKING FEES *

TROUBLESHOOTING

Symptoms caused	Problem/error	Solution
App showing offline status, video image shows "fetching, long lag on calls, intermittently showing online/offline, delayed push notifications.	Wi-Fi too weak at gate	Increase the height of the antenna if possible, install a Wi-Fi booster either inside the house near the front of the property, or a loft or eaves mounted external Wi-Fi booster, or install a CAT5 cable from the intercom to the router.
Delayed push notifications, video lag, voice problems, freezing, relays not opening the gate.	Wrong power cable (too thin) installed from 24v adaptor to the intercom, or power adaptor too far from intercom.	Change the power cable to specifications shown within this manual.
Lagging video or audio, delayed notifications, status showing intermittently online/offline, no or randomly operation of push notifications.	Too many devices on home network	Turn off as many other devices as possible, reboot the router and then try again. If the unit works, it proves to the customer that their router needs to be upgraded to handle the demand.
Intercom works well sometimes and not well other times. The Wi-Fi signal strength on the app Wi-Fi screen can sometimes be strong and other times is weak.	Several Wi-Fi networks using the same SSID	The intercom is jumping between networks depending on traffic and other devices connected to the same node. It is advisable to change the SSID name of the Wi-Fi network closest to the intercom to something individual.
Offline status. Will not connect to the network	Incorrect Wi-Fi password entered during setup	Try process again. Check the same Wi-Fi password works on your phone (forget the network and re-connect using the same password).
Can randomly display status "id already in use"	Additional user added incorrectly.	When an additional user was being added, the process was done incorrectly. Additional users MUST be added by the admin device first, with separate usernames created for each. The new usernames and passwords must be used by the new devices as shown in this manual to logon to the intercom.
App shows online when phone is in the same network but offline when phone on 3G/4G or on a remote Wi-Fi network, App works fine remotely to view gates but push notifications are not working at all.	Commercial firewall	This will be a job for the IT provider for the business. A port will need opened to allow P2P and PUSH notification traffic to pass through the firewall. Recommended unassigned ports which your network administrator can open are 6806, 6809 and 9123, 9124.
App shows online status locally and when phone is remote, but push notifications may be delayed, or video lag, or showing "fetching" on video screen.	Insufficient upload speed	This will need discussed with the ISP / broadband provider.
Intercom is online and working even through the application, but I am receiving no notifications even for calls! I have checked my Wi-Fi/Ethernet and the intercom meets minimum requirements	Incorrect time.	Cycle to the settings menu and navigate to the clock settings and press "sync phone time" to sync current time from the cellphone. This should only ever need done once as the time is pulled from the server.
I think my intercom is not functioning correctly.	Potential conflict of interest/firmware/software bug.	This is not something that happens frequently and can only happen if a new firmware was pushed to the unit. Seldom instances can however occur resulting in a soft reboot needing done. Cycle to the settings menu and navigate to the power icon, pressing this will initiate a soft reboot. This soft reboot will remove any open communications or potential non-functioning features to be re-enabled.

Reset / Default Unit

Press & Hold for 10 seconds

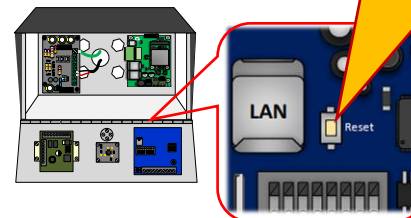

If you are experiencing problems with not receiving notifications, the system may need defaulted to factory settings. This will clear any programmed data such as keypad codes and Prox ID's and will also clear any users and default the ADMIN password.

Most importantly it will also clear all authentication tokens that have been issued from the server allowing new devices connected to now receive PUSH notifications from the system.

Note: Performing this process will remove all current programming including saved users & access codes. 

This product is not a complete product until fully installed. It is therefore considered a component part of an overall system. The installer is responsible to check that the end installation complies with local regulatory requirements. This equipment forms part of a "fixed installation".

STILL HAVING TROUBLE?

Find all of our support options such as Web Chat, Full Manuals, Customer Helpline and more on our website:

WWW.AESGLOBALUS.COM

+1 (631) 565-7288

FCC Statement

NOTE: This equipment has been tested and found to comply with the limits for a Class B digital device, pursuant to part 15 of the FCC Rules. These limits are designed to provide reasonable protection against harmful interference in a residential installation. This equipment generates uses and can radiate radio frequency energy and, if not installed and used in accordance with the instructions, may cause harmful interference to radio communications. However, there is no guarantee that interference will not occur in a particular installation. If this equipment does cause harmful interference to radio or television reception, which can be determined by turning the equipment off and on, the user is encouraged to try to correct the interference by one or more of the following measures:

- Reorient or relocate the receiving antenna.
- Increase the separation between the equipment and receiver.
- Connect the equipment into an outlet on a circuit different from that to which the receiver is connected.
- Consult the dealer or an experienced radio/TV technician for help

Changes or modifications not expressly approved by the party responsible for compliance could void the user's authority to operate the equipment.

This device complies with Part 15 of the FCC Rules. Operation is subject to the following two conditions: (1) this device may not cause harmful interference, and (2) this device must accept any interference received, including interference that may cause undesired operation.

RF Exposure Warning Statements:

This equipment complies with FCC radiation exposure limits set forth for an uncontrolled environment. This equipment shall be installed and operated with minimum distance 20cm between the radiator & body.

Operation of this device is restricted to indoor use only. (W52 band)