

FCC TEST REPORT
For
TOPTEN ELECTRONICS TECHNOLOGY LIMITED

OBD-II GPS Tracker
Model No.: TK228, TK228S, TK218, TK218S, TK208, TK208S

Prepared for : TOPTEN ELECTRONICS TECHNOLOGY LIMITED
Address : 5/F, Building B, No.3, Tangdong Guangtang West Rd., Tianhe
District, Guangzhou, China

Prepared By : Shenzhen Anbotek Compliance Laboratory Limited
Address : 1/F., Building 1, SEC Industrial Park, No.0409 Qianhai Road,
Nanshan District, Shenzhen, Guangdong, China
Tel: (86) 755-26066544
Fax: (86) 755-26014772

Report Number : R0217030019W1
Date of Test : Mar. 07~Apr.10, 2017
Date of Report : Apr. 10, 2017

TABLE OF CONTENT

Description	Page
Test Report	
1. GENERAL INFORMATION.....	5
1.1. Description of Device (EUT).....	5
1.2. Auxiliary Equipment Used during Test.....	6
1.3. Description of Test Facility.....	6
1.4. Measurement Uncertainty.....	6
2. TECHNICAL TEST.....	7
2.1. Summary of Test Results.....	7
2.2. Test Report.....	7
3. DESCRIPTION OF TEST MODES.....	7
4. TEST EQUIPMENT.....	8
5. OUTPUT POWER.....	9
5.1 Conducted Output Power.....	9
5.1.1 measurement method.....	9
5.1.2 Measurement Result.....	9
5.2 Radiated Output Power.....	14
5.2.1 measurement method.....	14
5.2.2 PROVISIONS APPLICABLE.....	14
5.2.3 Measurement Result.....	15
6. SPURIOUS EMISSION.....	19
6.1 CONDUCTED SPURIOUS EMISSION.....	19
6.1.2 PROVISIONS APPLICABLE.....	20
6.1.3 Measurement Result.....	20
6.2.1 measurement method.....	21
6.2.2 PROVISIONS APPLICABLE.....	22
6.2.3 Measurement Result.....	23
7. FREQUENCY STABILITY.....	27
7.1 measurement method.....	27
7.2 PROVISIONS APPLICABLE.....	27
7.2.1 For Hand carried battery powered equipment.....	27
7.2.2 For equipment powered by primary supply voltage.....	28
7.3 Measurement Result.....	28
8. BANDWIDTH.....	33
8.1 Applicable Standard.....	33
8.2 Test Procedure.....	33
8.3 Measurement Result.....	33

9. BAND EDGE	37
9.1 Applicable Standard	37
9.2 Test Procedure	37
9.3 Measurement Result	37
10. PEAK-TO-AVERAGE RATIO	38
10.1 MEASURING INSTRUMENTS	38
10.2 TEST PROCEDURES	38
10.3 TEST SETUP	38
10.4 TEST RESULT OF PEAK-TO-AVERAGE RATIO	39
APPENDIX I	44
APPENDIX II	68
APPENDIX III	81
APPENDIX IV (TEST PHOTOGRAPHS)	89
APPENDIX V (EXTERNAL PHOTOS)	90
APPENDIX VI (INTERNAL PHOTOS)	94

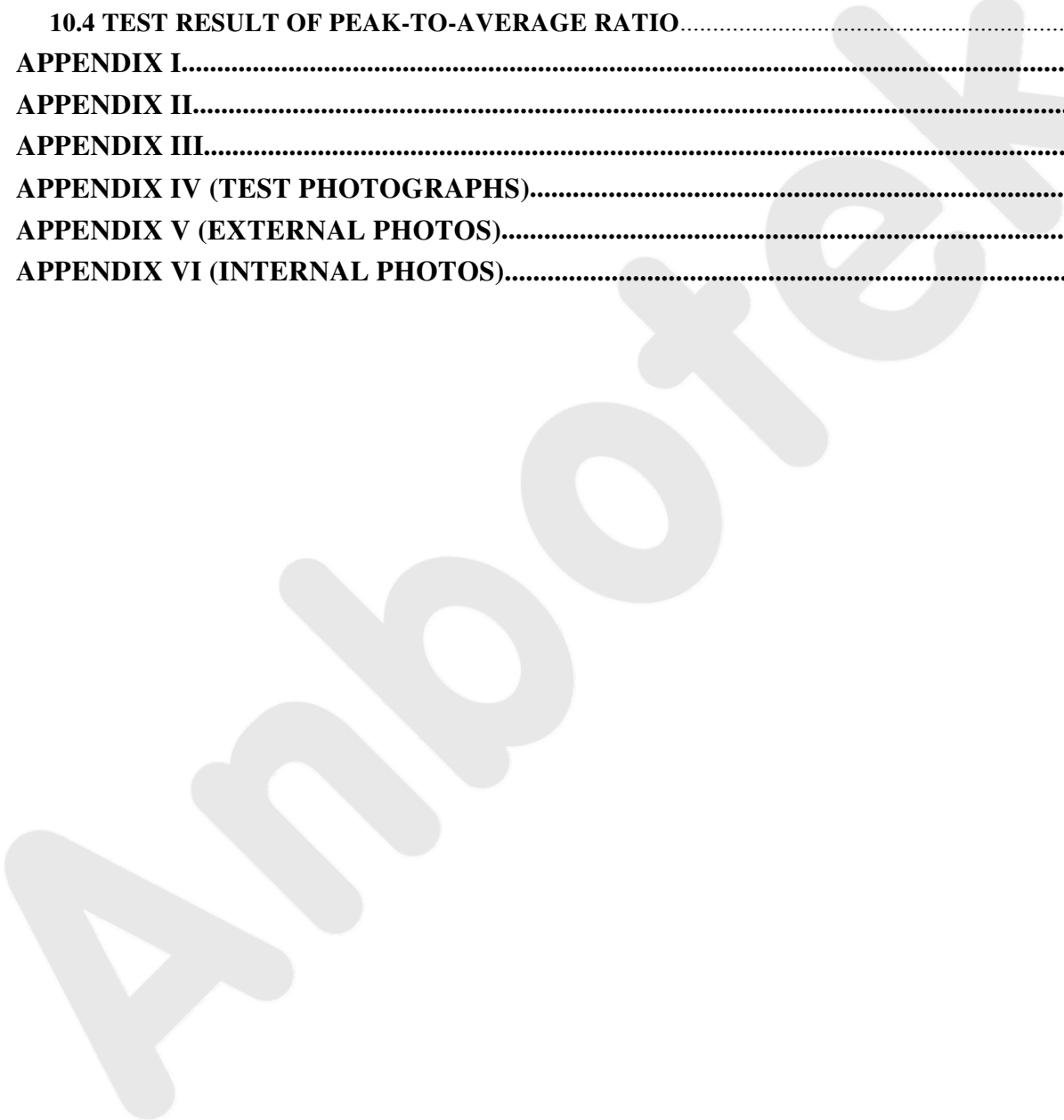

TEST REPORT

Applicant : TOPTEN ELECTRONICS TECHNOLOGY LIMITED
Manufacturer : Guangzhou Topten Electronics Factory
EUT : OBD-II GPS Tracker
Model No. : TK228, TK228S, TK218, TK218S, TK208, TK208S
Serial No. : N.A.
Trade Mark : TOPTEN
Rating : Input DC 12V

Measurement Procedure Used:

FCC Part 2, FCC Part 22 Subpart H, FCC Part 24 Subpart E, ANSI/TIA 603-D (2010)

The device described above is tested by Shenzhen Anbotek Compliance Laboratory Limited to determine the maximum emission levels emanating from the device and the severe levels of the device can endure and its performance criterion. The measurement results are contained in this test report and Shenzhen Anbotek Compliance Laboratory Limited is assumed full of responsibility for the accuracy and completeness of these measurements. Also, this report shows that the EUT (Equipment Under Test) is technically compliant with the FCC Part 22(H):2016; FCC Part 24(E):2016 requirements.

This report applies to above tested sample only and shall not be reproduced in part without written approval of Shenzhen Anbotek Compliance Laboratory Limited.

Date of Test : Mar. 07~Apr.10, 2017

Prepared by :  Kyle Xu
(Test Engineer / Kyle Xu)

Reviewer : Brown Lu
(Project Manager / Brown Lu)

Approved & Authorized Signer : Tom Chen
(Manager/ Tom Chen)

1. GENERAL INFORMATION

1.1. Description of Device (EUT)

EUT	: OBD-II GPS Tracker						
Model Number	: TK228, TK228S, TK218, TK218S, TK208, TK208S(Note: All samples are the same except the model number and colour, so we prepare “TK228” for test only.)						
Test Voltage	: DC 12V						
Frequency Bands:	<table border="1"> <thead> <tr> <th>Types of module</th> <th>Operating Frequency</th> </tr> </thead> <tbody> <tr> <td>WCDMA/GSM</td> <td>GSM850 ,PCS1900 ,UMTS FDD Band II, UMTS FDD Band V</td> </tr> <tr> <td>BT 4.0</td> <td>2402-2480MHz</td> </tr> </tbody> </table>	Types of module	Operating Frequency	WCDMA/GSM	GSM850 ,PCS1900 ,UMTS FDD Band II, UMTS FDD Band V	BT 4.0	2402-2480MHz
Types of module	Operating Frequency						
WCDMA/GSM	GSM850 ,PCS1900 ,UMTS FDD Band II, UMTS FDD Band V						
BT 4.0	2402-2480MHz						
Modulation Type:	: GSM / GPRS: GMSK EGPRS: GMSK, 8PSK UMTS-FDD: QPSK, 16QAM BT 4.0: GFSK						
Antenna Type	: WCDMA/GSM: FPCB Antenna BT 4.0: PCB Antenna						
Antenna Gain	: WCDMA/GSM: 1.0 dBi BT 4.0: 1.0 dBi						
Applicant Address	: TOPTEN ELECTRONICS TECHNOLOGY LIMITED 5/F, Building B, No.3, Tangdong Guangtang West Rd., Tianhe District, Guangzhou, China						
Manufacturer Address	: Guangzhou Topten Electronics Factory 5/F, Building B, No.3, Tangdong Guangtang West Rd., Tianhe District, Guangzhou, China						
Date of receipt	: Mar. 07, 2017						
Date of Test	: Mar. 07~29, 2017						
Note	: This report is for WCDMA/GSM.						

1.2. Auxiliary Equipment Used during Test

N/A

1.3. Description of Test Facility

The test facility is recognized, certified, or accredited by the following organizations:

FCC-Registration No.: 752021

Shenzhen Anbotek Compliance Laboratory Limited, EMC Laboratory has been registered and fully described in a report filed with the (FCC) Federal Communications Commission. The acceptance letter from the FCC is maintained in our files. Registration 752021, July 06, 2016.

IC-Registration No.: 8058A-1

Shenzhen Anbotek Compliance Laboratory Limited., EMC Laboratory has been registered and fully described in a report filed with the (IC) Industry Canada. The acceptance letter from the IC is maintained in our files. Registration 8058A, Jun. 13, 2016.

Test Location

All Emissions tests were performed at
Shenzhen Anbotek Compliance Laboratory Limited. at 1/F., Building 1, SEC
Industrial Park, No.0409 Qianhai Road, Nanshan District, Shenzhen, Guangdong,
China

1.4. Measurement Uncertainty

Radiation Uncertainty : Ur = 4.1 dB (Horizontal)
Ur = 4.3 dB (Vertical)

Conduction Uncertainty : Uc = 3.4dB

2. Technical test

2.1. Summary of Test Results

No Deviations from the technical specification(s) were ascertained in the course of the tests Performed	
Final Verdict: (only “Pass” if all single measurements are “Pass”)	Pass

2.2. Test Report

The EUT has been tested according to the following specifications:
 The radiated emission testing was performed according to the procedures of TIA/EIA 603D and FCC CFR 47 Rules of 2.1046, 2.1047, 2.1049, 2.1051, 2.1053, 2.1055, 2.1057.

Item Number	Item Description	FCC Rules
1	Output Power	Conducted output power
		Radiated output power
		22.913(a) / 24.232 (b)
2	Spurious Emission	Conducted spurious emission
		Radiated spurious emission
		2.1051 / 22.917 / 24.238
3	Frequency Stability	2.1055 /24.235
4	Occupied Bandwidth	2.1049 (h)(i)
5	Emission Bandwidth	22.917(b) / 24.238 (b)
6	Band Edge	22.917(b) / 24.238 (b)
7	Peak-to-Average Ratio	24.232(d)

3. DESCRIPTION OF TEST MODES

During the testing, the EUT was controlled via Rhode & Schwarz Digital Radio Communication Tester (CMU 200) to ensure max power transmission and proper modulation. Three channels (The top channel, the middle channel and the bottom channel) were chosen for testing on both GSM850 and GSM1900 frequency band.

Note: GSM/GPRS 850, GSM/GPRS 1900, HSDPA band II, HSUPA band II, HSDPA band V, HSUPA band V modes have been tested during the test. the worst condition (GSM850 + GSM1900 RMC 12.2k) be recorded in the test report if no other modes test data.

4. TEST EQUIPMENT

Item	Equipment	Manufacturer	Model No.	Serial No.	Last Cal.	Cal. Interval
1	Spectrum Analysis	Agilent	E4407B	US39390582	Jul. 12, 2016	1 Year
2	Preamplifier	Instruments corporation	EMC011830	980100	Jun. 17, 2016	1 Year
3	EMI Test Receiver	Rohde & Schwarz	ESPI	101604	Jun. 17, 2016	1 Year
4	Double Ridged Horn Antenna	Instruments corporation	GTH-0118	351600	May 06, 2016	1 Year
5.	Bilog Broadband Antenna	Schwarzbeck	VULB9163	VULB 9163-289	May 06, 2016	1 Year
6	Pre-amplifier	SONOMA	310N	186860	Jun. 17, 2016	1 Year
7.	EMI Test Software EZ-EMC	SHURPLE	N/A	N/A	N/A	N/A
8	MXA Spectrum Analysis	Agilent	N9020A	MY51170037	Jun. 17, 2016	1 Year
9	MXG RF Vector Signal Generator	Agilent	N5182A	MY48180656	Jun. 17, 2016	1 Year
10	DC Power supply	IV	IV-8080	YQSB0096	Jun. 17, 2016	1 Year
11	TEMP&HUMI PROGRAMMABLE CHAMBER	Bell Group	BE-THK-150M8	SE-0137	Jun. 17, 2016	1 Year
12	UNIVERSAL RADIO COMMUNICATION TESTER	Rohde & Schwarz	CMU 200	117888	Jun. 17, 2016	1 Year
13	UNIVERSAL RADIO COMMUNICATION TESTER	Rohde & Schwarz	CMU 500	104209	Jun. 17, 2016	1 Year
14	Filter	COM-MW	ZHPF-BM 1100-4000-0730	1307006523	Jun. 17, 2016	1 Year
15	Filter	COM-MW	ZHPT-M35-18G-3834	B2015094550	Jun. 17, 2016	1 Year

5. OUTPUT POWER

5.1 Conducted Output Power

5.1.1 measurement method

The EUT was setup for the max output power with pseudo random data modulation. Power was measured with Spectrum Analyzer. The measurements were performed on all modes(GSM/GPRS 850, GSM/GPRS 1900, HSDPA band II, HSUPA band II, HSDPA band V, HSUPA band V) at 3 typical channels(the Top Channel, the Middle Channel and the Bottom Channel) for each band.

5.1.2 Measurement Result

GSM850:

Mode	Frequency(MHz)	Maximum Burst-Average Output Power
GSM850	824.2	32.54
	836.6	32.33
	848.8	32.26
GPRS850(1 Slot)	824.2	32.43
	836.6	32.26
	848.8	32.59
GPRS850(2 Slot)	824.2	31.45
	836.6	31.32
	848.8	31.54
GPRS850(3 Slot)	824.2	29.74
	836.6	29.66
	848.8	29.52
GPRS850(4 Slot)	824.2	28.35
	836.6	28.84
	848.8	28.10
EGPRS850(1 Slot)	824.2	32.35
	836.6	32.86
	848.8	32.45
EGPRS850(2 Slot)	824.2	31.62
	836.6	31.65
	848.8	31.74
EGPRS850(3 Slot)	824.2	29.64
	836.6	29.53
	848.8	29.57
EGPRS850(4 Slot)	824.2	28.48
	836.6	28.29
	848.8	28.71

PCS1900:

Mode	Frequency(MHz)	Maximum Burst-Average Output Power
GSM1900	1850.2	29.15
	1880	28.48
	1909.8	29.64
GPRS1900(1 Slot)	1850.2	28.52
	1880	28.31
	1909.8	28.54
GPRS1900(2 Slot)	1850.2	27.37
	1880	27.55
	1909.8	27.24
GPRS1900(3 Slot)	1850.2	27.64
	1880	27.73
	1909.8	27.84
GPRS1900(4 Slot)	1850.2	26.82
	1880	26.79
	1909.8	26.48
EGPRS1900(1 Slot)	1850.2	29.45
	1880	29.38
	1909.8	29.57
EGPRS1900(2 Slot)	1850.2	28.64
	1880	28.51
	1909.8	28.30
EGPRS1900(3 Slot)	1850.2	27.36
	1880	27.74
	1909.8	27.22
EGPRS1900(4 Slot)	1850.2	26.69
	1880	26.27
	1909.8	26.68

UMTS BAND II

Mode	Frequency(MHz)	MaximumBurst-Average Output Power
WCDMA 1900RMC	1852.4	21.54
	1880.0	21.63
	1907.6	21.42
WCDMA 1900AMR	1852.4	21.48
	1880.0	21.19
	1907.6	21.36
HSDPA Subtest 1	1852.4	20.48
	1880	20.25
	1907.6	20.79
HSDPA Subtest 2	1852.4	20.65
	1880	20.36
	1907.6	20.44
HSDPA Subtest 3	1852.4	20.87
	1880	20.45
	1907.6	20.36
HSDPA Subtest 4	1852.4	19.56
	1880	19.42
	1907.6	19.76
HSUPA Subtest 1	1852.4	21.54
	1880.0	21.66
	1907.6	21.21
HSUPA Subtest 2	1852.4	20.05
	1880.0	20.23
	1907.6	20.11
HSUPA Subtest 3	1852.4	20.75
	1880.0	20.23
	1907.6	20.25
HSUPA Subtest 4	1852.4	19.32
	1880.0	19.54
	1907.6	19.33
HSUPA Subtest 5	1852.4	19.23
	1880.0	19.32
	1907.6	19.34

UMTS BAND V

Mode	Frequency(MHz)	Maximum Burst-Average Output Power
WCDMA 850 RMC	826.4	22.16
	835.0	22.37
	846.6	22.08
WCDMA 850 AMR	826.4	21.43
	835.0	21.21
	846.6	21.35
HSDPA Subtest 1	826.4	20.64
	835.0	20.29
	846.6	20.31
HSDPA Subtest 2	826.4	20.36
	835.0	20.52
	846.6	20.49
HSDPA Subtest 3	826.4	20.24
	835.0	20.37
	846.6	20.35
HSDPA Subtest 4	826.4	19.19
	835.0	19.54
	846.6	19.20
HSUPA Subtest 1	826.4	21.15
	835.0	21.72
	846.6	21.43
HSUPA Subtest 2	826.4	20.66
	835.0	20.51
	846.6	20.20
HSUPA Subtest 3	826.4	20.13
	835.0	20.68
	846.6	20.29
HSUPA Subtest 4	826.4	19.54
	835.0	19.74
	846.6	19.45
HSUPA Subtest 5	826.4	19.58
	835.0	19.67
	846.6	19.36

5.2 Radiated Output Power

5.2.1 measurement method

The measurements procedures specified in TIA-603-D-2010 were applied.

- 1 In an anechoic antenna test chamber, a half-wave dipole antenna for the frequency band of interest is placed at the reference centre of the chamber. An RF Signal source for the frequency band of interest is connected to the dipole with a cable that has been constructed to not interfere with the radiation pattern of the antenna. A known (measured) power (P_{in}) is applied to the input of the dipole, and the power received (P_r) at the chamber's probe antenna is recorded.
- 2 The substitution method is used. Substitution values at each frequency are measured before and saved to the test software. A "reference path loss" is established as $AR_{pl} = P_{in} - P_r$. The AR_{pl} is the attenuation of "reference path loss", and including the gain of receive antenna, the cable loss and the air loss. The measurement results are obtained as described below: $Power = P_{Mea} + AR_{pl}$
- 3 The EUT is substituted for the dipole at the reference centre of the chamber and a scan is performed to obtain the radiation pattern.
- 4 From the radiation pattern, the co-ordinates where the maximum antenna gain occurs are identified.
- 5 The EUT is then put into continuously transmitting mode at its maximum power level.
- 6 Power mode measurements are performed with the receiving antenna placed at the coordinates determined in Step 3 to determine the output power as defined in Rule 24.232 (b) and (c). The "reference path loss" from Step1 is added to this result.
- 7 This value is EIRP since the measurement is calibrated using a half-wave dipole antenna of known gain (2.15 dBi) and known input power (P_{in}).
- 8 ERP can be calculated from EIRP by subtracting the gain of the dipole, $ERP = EIRP - 2.15dBi$.
9. Both horizontal and vertical antenna polarities were tested and performed pretest to three orthogonal axis. The worst case emissions were reported

5.2.2 PROVISIONS APPLICABLE

This is the test for the maximum radiated power from the EUT. Rule Part 24.232(b) specifies, "Mobile/portable stations are limited to 2 watts e.i.r.p. Peak power" and 24.232(c) specifies that "Peak transmit power must be measured over any interval of continuous transmission using instrumentation calibrated in terms of an rms-equivalent voltage." Rule Part 22.913(a) specifies "Maximum ERP. The effective radiated power (ERP) of base transmitters and cellular repeaters must not exceed 500 Watts. The ERP of mobile transmitters and auxiliary test transmitters must not exceed 7 Watts."

Mode	Nominal Peak Power
GSM 850	≤ 38.45 dBm (7W)
PCS 1900	≤ 33 dBm (2W)
UMTS BANDV	≤ 38.45 dBm (7W)

5.2.3 Measurement Result

Radiated Power (E.R.P) for GSM 850 MHZ							
Mode	Frequency	Substituted Level (dBm)	Antenna Polarization	Antenna Gain (dBi)	Cable loss (dB)	Absolute Level (dBm)	Conclusion
GSM 850	824.2	24.25	Horizontal	6.4	0.52	30.13	Pass
	824.2	24.34	Vertical	6.4	0.52	30.22	Pass
	836.6	24.04	Horizontal	6.4	0.52	29.92	Pass
	836.6	24.05	Vertical	6.4	0.52	29.93	Pass
	848.8	24.07	Horizontal	6.5	0.52	30.05	Pass
	848.8	24.09	Vertical	6.5	0.52	30.07	Pass

Radiated Power (E.R.P) for GPRS 850 MHZ							
Mode	Frequency	Substituted Level (dBm)	Antenna Polarization	Antenna Gain (dBi)	Cable loss (dB)	Absolute Level (dBm)	Conclusion
GPRS 850	824.2	24.03	Horizontal	6.4	0.52	29.91	Pass
	824.2	24.27	Vertical	6.4	0.52	30.15	Pass
	836.6	23.74	Horizontal	6.4	0.52	29.62	Pass
	836.6	24.06	Vertical	6.4	0.52	29.94	Pass
	848.8	23.81	Horizontal	6.5	0.52	29.79	Pass
	848.8	23.94	Vertical	6.5	0.52	29.92	Pass

Radiated Power (E.R.P) for EGPRS 850 MHZ							
Mode	Frequency	Substituted Level (dBm)	Antenna Polarization	Antenna Gain (dBi)	Cable loss (dB)	Absolute Level (dBm)	Conclusion
EGPRS 850	824.2	23.88	Horizontal	6.4	0.52	29.76	Pass
	824.2	24.13	Vertical	6.4	0.52	30.01	Pass
	836.6	23.63	Horizontal	6.4	0.52	29.51	Pass
	836.6	23.9	Vertical	6.4	0.52	29.78	Pass
	848.8	23.75	Horizontal	6.5	0.52	29.73	Pass
	848.8	23.84	Vertical	6.5	0.52	29.82	Pass

Radiated Power (E.I.R.P) for PCS 1900 MHZ							
Mode	Frequency	Substituted Level (dBm)	Antenna Polarization	Antenna Gain (dBi)	Cable loss (dB)	Absolute Level (dBm)	Conclusion
PCS 1900	1850.2	22.37	Horizontal	8.13	0.96	29.54	Pass
	1850.2	21.72	Vertical	8.13	0.96	28.89	Pass
	1880.0	22.29	Horizontal	8.14	0.96	29.47	Pass
	1880.0	21.77	Vertical	8.14	0.96	28.95	Pass
	1909.8	21.83	Horizontal	8.14	0.96	29.01	Pass
	1909.8	21.48	Vertical	8.14	0.96	28.66	Pass

Radiated Power (E.I.R.P) for GPRS 1900 MHZ							
Mode	Frequency	Substituted Level (dBm)	Antenna Polarization	Antenna Gain (dBi)	Cable loss (dB)	Absolute Level (dBm)	Conclusion
GPRS 1900	1850.2	21.27	Horizontal	8.13	0.96	28.44	Pass
	1850.2	21.52	Vertical	8.13	0.96	28.69	Pass
	1880.0	20.79	Horizontal	8.14	0.96	27.97	Pass
	1880.0	20.83	Vertical	8.14	0.96	28.01	Pass
	1909.8	21.44	Horizontal	8.14	0.96	28.62	Pass
	1909.8	20.8	Vertical	8.14	0.96	27.98	Pass

Radiated Power (E.I.R.P) for EGPRS 1900 MHZ							
Mode	Frequency	Substituted Level (dBm)	Antenna Polarization	Antenna Gain (dBi)	Cable loss (dB)	Absolute Level (dBm)	Conclusion
EGPRS 1900	1850.2	21.24	Horizontal	8.13	0.96	28.41	Pass
	1850.2	21.46	Vertical	8.13	0.96	28.63	Pass
	1880.0	20.74	Horizontal	8.14	0.96	27.92	Pass
	1880.0	20.55	Vertical	8.14	0.96	27.73	Pass
	1909.8	21.24	Horizontal	8.14	0.96	28.42	Pass
	1909.8	20.45	Vertical	8.14	0.96	27.63	Pass

Radiated Power (E.I.R.P) for UMTS band II							
Mode	Frequency	Substituted Level (dBm)	Antenna Polarization	Antenna Gain (dBi)	Cable loss (dB)	Absolute Level (dBm)	Conclusion
RMC 12.2kbps	1852.4	15.47	Horizontal	8.13	0.96	22.64	Pass
	1852.4	15.27	Vertical	8.13	0.96	22.44	Pass
	1880.0	15.38	Horizontal	8.14	0.96	22.56	Pass
	1880.0	14.68	Vertical	8.14	0.96	21.86	Pass
	1907.6	14.79	Horizontal	8.14	0.96	21.97	Pass
	1907.6	14.83	Vertical	8.14	0.96	22.01	Pass

Radiated Power (E.R.P) for UMTS band V							
Mode	Frequency	Substituted Level (dBm)	Antenna Polarization	Antenna Gain (dBi)	Cable loss (dB)	Absolute Level (dBm)	Conclusion
RMC 12.2kbps	826.4	16.18	Horizontal	6.4	0.52	22.06	Pass
	826.4	16.61	Vertical	6.4	0.52	22.49	Pass
	836.6	15.93	Horizontal	6.4	0.52	21.81	Pass
	836.6	16.06	Vertical	6.4	0.52	21.94	Pass
	846.6	15.84	Horizontal	6.5	0.52	21.82	Pass
	846.6	16.17	Vertical	6.5	0.52	22.15	Pass

NOTE 1: in the part, result the worst case GPRS 1slot for GSM 850 and PCS1900, and RMC 12.2kbps for band II and band v.

6. SPURIOUS EMISSION

6.1 CONDUCTED SPURIOUS EMISSION

6.1.1 measurement method

The following steps outline the procedure used to measure the conducted emissions from the EUT.

1, Determine frequency range for measurements: From CFR 2.1057 the spectrum should be investigated from the lowest radio frequency generated in the equipment up to at least the 10th harmonic of the carrier frequency. For the equipment of PCS1900 band, this equates to a frequency range of 30 MHz to 19.1 GHz, data taken from 30 MHz to 20 GHz. For GSM850, data taken from 30 MHz to 9 GHz.

2, Determine EUT transmit frequencies: the following typical channels were chosen to conducted emissions testing.

Typical Channels for testing of GSM 850 MHz	
Channel	Frequency (MHz)
128	824.2
190	836.6
251	848.8

Typical Channels for testing of PCS 1900 MHz	
Channel	Frequency (MHz)
512	1850.2
661	1880.0
810	1909.8

Typical Channels for testing of UMTS band II	
Channel	Frequency (MHz)
9262	1852.4
9400	1880.0
9538	1907.6

Typical Channels for testing of UMTS band V	
Channel	Frequency (MHz)
4132	826.4
4183	836.6
4233	846.6

6.1.2 PROVISIONS APPLICABLE

On any frequency outside frequency band of the USPCS spectrum, the power of any emission shall be attenuated below the transmitter power (P, in Watts) by at least $43+10\text{Log}(P)$ dB. For all power levels +30 dBm to 0 dBm, this becomes a constant specification limit of -13 dBm.

6.1.3 Measurement Result

PLEASE REFER TO : APPENDIX I TEST PLOTS FOR CONDUCTED SPURIOUS EMISSION

- Note:**
1. Below 30MHZ no Spurious found and The GSM modes is the worst condition.
 2. As no emission found in standby or receive mode, no recording in this report.

Anbotek

6.2 Radiated Spurious Emission

6.2.1 measurement method

Radiated spurious emissions measurements are performed using the substitution method described in ANSI/TIA-603-D-2010 with the EUT transmitting into an integral antenna. Measurements on signals operating below 1GHz are performed using horizontally and vertically polarized tuned dipole antennas. Measurements on signals operating above 1GHz are performed using vertically and horizontally polarized horn antennas. All measurements are performed as peak measurements while the EUT is operating at maximum power and at the appropriate frequencies. It is measured by means of a calibrated spectrum analyzer and scanned from 30 MHz up to a frequency including its 10th harmonic.

The procedure of radiated spurious emissions is as follows:

1. The testing follows FCC KDB 971168 D01 Section 5.8 and ANSI/TIA-603-D-2010 – Section 2.2.12
2. RBW = 100kHz for emissions below 1GHz and 1MHz for emissions above 1GHz
3. VBW $\geq 3 \times$ RBW
4. Span = 1.5 times the OBW
5. No. of sweep points $> 2 \times$ span/RBW
6. Detector = Peak
7. Trace mode = max hold
8. The trace was allowed to stabilize

TEST SETUP

For radiated test from 30MHz to 1GHz

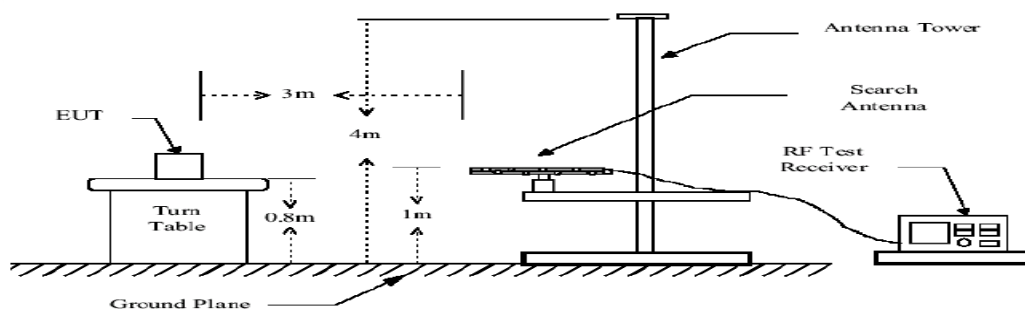

For radiated test from above 1GHz

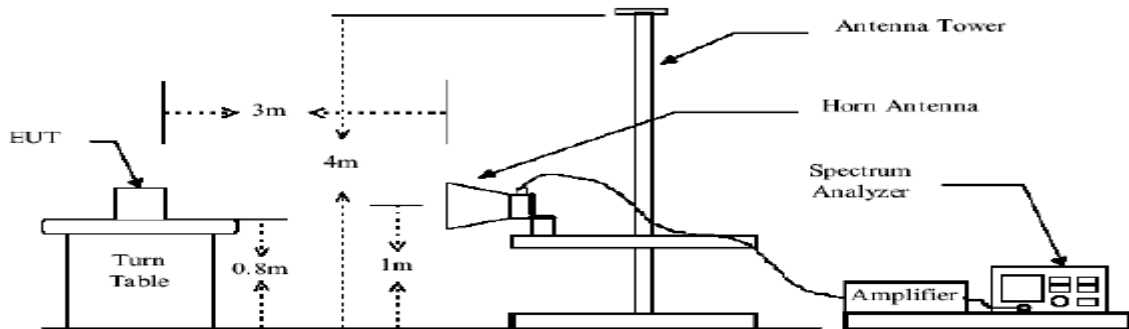

Radiated emissions measurements were made only at the upper, middle, and lower carrier frequencies of the PCS 1900 band (1850.2 MHz, 1880 MHz and 1909.8 MHz), GSM850 band (824.2MHz, 836.6MHz, 848.8MHz), UMTS band II(1852.4MHz, 1880MHz, 1907.6MHz), UMTS band V(826.4MHz, 836.6MHz, 846.6MHz). It was decided that measurements at these three carrier frequencies would be sufficient to demonstrate compliance with emissions limits because it was seen that all the significant spurs occur well outside the band and no radiation was seen from a carrier in one block of any band into any of the other blocks.

The substitution method is used. Substitution values at each frequency are measured before and saved to the test software. A "reference path loss" is established and the ARpl is the attenuation of "reference path loss", and including the gain of receive antenna, the gain of the preamplifier, the cable loss and the air loss. The measurement results are obtained as described below:

Power=PMea-Antenna gain+cable loss

6.2.2 PROVISIONS APPLICABLE

(a) On any frequency outside a licensee's frequency block (e.g. A, D, B, etc.) within the USPCS spectrum, the power of any emission shall be attenuated below the transmitter power (P, in Watts) by at least $43+10\log(P)$ dB. The specification that emissions shall be attenuated below the transmitter power (P) by at least $43 + 10 \log (P)$ dB, translates in the relevant power range (1 to 0.001 W) to -13 dBm. At 1 W the specified minimum attenuation becomes 43 dB and relative to a 30 dBm (1 W) carrier becomes a limit of -13 dBm. At 0.001 W (0 dBm) the minimum attenuation is 13 dB, which again yields a limit of -13 dBm. In this way a translation of the specification from relative to absolute terms is carried out.

Note: only result the worst condition of each test mode:

6.2.3 Measurement Result

GSM 850:

GSM 850						
Test Results for Channel 128/824.2 MHz						
Frequency(MHz)	Power(dBm)	Antenna Gain (dBi)	Cable loss(dB)	PMea (dBm)	Limit (dBm)	Polarity
1648.4	-31.21	8.42	0.62	-23.41	-13.00	Vertical
1648.4	-31.14	8.42	0.62	-23.34	-13.00	Horizontal
2472.6	-31.43	12.0	1.0	-20.43	-13.00	Vertical
2472.6	-31.17	12.0	1.0	-20.17	-13.00	Horizontal
3296.8	-31.35	13.8	1.5	-19.05	-13.00	Horizontal
3296.8	-31.12	13.8	1.5	-18.82	-13.00	Vertical
Test Results for Channel 190/836.6 MHz						
1673.2	-33.12	8.7	0.7	-25.12	-13.00	Vertical
1673.2	-32.35	8.7	0.7	-24.35	-13.00	Horizontal
2509.8	-31.34	12.2	1.0	-20.14	-13.00	Vertical
2509.8	-31.51	12.2	1.0	-20.31	-13.00	Horizontal
3346.4	-32.42	14.2	1.6	-19.82	-13.00	Horizontal
3346.4	-32.62	14.2	1.6	-20.02	-13.00	Vertical
Test Results for Channel 251/848.8 MHz						
1697.6	-30.43	8.78	0.68	-22.33	-13.00	Vertical
1697.6	-30.22	8.78	0.68	-22.12	-13.00	Horizontal
2546.4	-32.35	12.69	1.0	-20.66	-13.00	Vertical
2546.4	-33.12	12.69	1.0	-21.43	-13.00	Horizontal
3395.2	-33.41	14.52	1.6	-20.49	-13.00	Horizontal
3395.2	-32.34	14.52	1.6	-19.42	-13.00	Vertical

NOTE:1.All other emissions more than 30dB below the limit.

2.ALL mode were investigating.The results above show only the worst case.

PCS 1900:

PCS1900						
Test Results for Channel 512/1850.2MHz						
Frequency(MHz)	Power(dBm)	Antenna Gain (dBi)	Cable loss(dB)	PMea(dBm)	Limit (dBm)	Polarity
3700.4	-34.02	15.45	2.03	-20.6	-13.00	Horizontal
3700.4	-35.26	15.45	2.03	-21.84	-13.00	Vertical
5550.6	-33.96	19.63	2.51	-16.84	-13.00	Vertical
5550.6	-31.57	19.63	2.51	-14.45	-13.00	Horizontal
7400.8	-35.85	22.88	3.62	-16.59	-13.00	Horizontal
7400.8	-35.48	22.88	3.62	-16.22	-13.00	Vertical
Test Results for Channel 661/1880.0MHz						
3760	-36.95	15.83	2.07	-23.19	-13.00	Horizontal
3760	-34.74	15.83	2.07	-20.98	-13.00	Vertical
5640	-35.26	20.32	2.76	-17.7	-13.00	Vertical
5640	-39.98	20.32	2.76	-22.42	-13.00	Horizontal
7520	-38.97	23.48	3.88	-19.37	-13.00	Horizontal
7520	-39.41	23.48	3.88	-19.81	-13.00	Vertical
Test Results for Channel 810/1909.8MHz						
3819.6	-35.95	16.14	2.27	-22.08	-13.00	Horizontal
3819.6	-31.48	16.14	2.27	-17.61	-13.00	Vertical
5729.4	-36.59	20.43	2.77	-18.93	-13.00	Vertical
5729.4	-34.56	20.43	2.77	-16.9	-13.00	Horizontal
7639.2	-40.14	23.78	4.03	-20.39	-13.00	Horizontal
7639.2	-39.97	23.78	4.03	-20.22	-13.00	Vertical

NOTE:

- 1.All other emissions more than 30dB below the limit.
- 2.ALL mode were investigating.The results above show only the worst case.

UMTS band II:

Test Results for Channel 9262/1852.4MHz						
Frequency(MHz)	Power(dBm)	Antenna Gain (dBi)	Cable loss(dB)	PMea (dBm)	Limit (dBm)	Polarity
3700.8	-32.06	15.45	2.03	-18.64	-13.00	Horizontal
3700.8	-31.69	15.45	2.03	-18.27	-13.00	Vertical
5551.2	-36.55	19.63	2.51	-19.43	-13.00	Vertical
5551.2	-34.51	19.63	2.51	-17.39	-13.00	Horizontal
Test Results for Channel 9400/1880MHz						
3760	-32.26	15.83	2.07	-18.5	-13.00	Horizontal
3760	-31.41	15.83	2.07	-17.65	-13.00	Vertical
5640	-40.59	20.32	2.76	-23.03	-13.00	Vertical
5640	-39.68	20.32	2.76	-22.12	-13.00	Horizontal
Test Results for Channel 9538/1907.6MHz						
3819.6	-35.64	16.14	2.27	-21.77	-13.00	Horizontal
3819.6	-35.29	16.14	2.27	-21.42	-13.00	Vertical
5729.4	-39.67	20.43	2.77	-22.01	-13.00	Vertical
5729.4	-36.41	20.43	2.77	-18.75	-13.00	Horizontal

NOTE:

- 1.All other emissions more than 30dB below the limit.
- 2.ALL mode were investingated.The results above show only the worst case.

UMTS band V:

Test Results for Channel 4132/826.4MHz						
Frequency(MHz)	Power(dBm)	Antenna Gain (dBi)	Cable loss(dB)	PMea (dBm)	Limit (dBm)	Polarity
1652.8	-30.23	8.62	0.62	-22.23	-13.00	Vertical
1652.8	-31.42	8.62	0.62	-23.42	-13.00	Horizontal
2479.2	-31.41	12.2	1.0	-20.21	-13.00	Vertical
2479.2	-30.45	12.2	1.0	-19.25	-13.00	Horizontal
3305.6	-32.33	14.2	1.6	-19.73	-13.00	Horizontal
3305.6	-29.71	14.2	1.6	-17.11	-13.00	Vertical
Test Results for Channel 190/836.6 MHz						
1673.2	-31.36	8.7	0.7	-23.36	-13.00	Vertical
1673.2	-30.24	8.7	0.7	-22.24	-13.00	Horizontal
2509.8	-31.63	12.2	1.0	-20.43	-13.00	Vertical
2509.8	-33.46	12.2	1.0	-22.26	-13.00	Horizontal
3346.4	-31.25	14.2	1.6	-18.65	-13.00	Horizontal
3346.4	-32.31	14.2	1.6	-19.71	-13.00	Vertical
Test Results for Channel 4233/846.6MHz						
1673.2	-29.64	8.78	0.68	-21.54	-13.00	Vertical
1673.2	-30.45	8.78	0.68	-22.35	-13.00	Horizontal
2509.8	-32.23	12.69	1.0	-20.54	-13.00	Vertical
2509.8	-34.34	12.69	1.0	-22.65	-13.00	Horizontal
3346.4	-34.49	14.52	1.6	-21.57	-13.00	Horizontal
3346.4	-39.77	14.52	1.6	-26.85	-13.00	Vertical

Note: Below 30MHZ no Spurious found.

- 1.All other emissions more than 30dB below the limit.
- 2.ALL mode were investigating.The results above show only the worst case.

7. FREQUENCY STABILITY

7.1 measurement method

In order to measure the carrier frequency under the condition of AFC lock, it is necessary to make measurements with the EUT in a "call mode". This is accomplished with the use of R&S CMU200 DIGITAL RADIO COMMUNICATION TESTER.

- 1 Measure the carrier frequency at room temperature.
- 2 Subject the EUT to overnight soak at -10°C.
- 3 With the EUT, powered via nominal voltage, connected to the CMU200 and in a simulated call on channel 661 for PCS 1900 band, channel 190 for GSM 850 band, channel 9400 for UMTS band II and channel 4175 for UMTS band V measure the carrier frequency. These measurements should be made within 2 minutes of Powering up the EUT, to prevent significant self-warming.
- 4 Repeat the above measurements at 10°C increments from -10°C to +50°C. Allow at least 1 1/2 hours at each temperature, unpowered, before making measurements.
- 5 Re-measure carrier frequency at room temperature with nominal voltage. Vary supply voltage from minimum voltage to maximum voltage, in 0.1Volt increments re-measuring carrier frequency at each voltage. Pause at nominal voltage for 1 1/2 hours unpowered, to allow any self-heating to stabilize, before continuing.
- 6 Subject the EUT to overnight soak at +50°C.
- 7 With the EUT, powered via nominal voltage, connected to the CMU200 and in a simulated call on the centre channel, measure the carrier frequency. These measurements should be made within 2 minutes of Powering up the EUT, to prevent significant self-warming.
- 8 Repeat the above measurements at 10°C increments from +50°C to -10°C. Allow at least 1 1/2 hours at each temperature, unpowered, before making measurements.
- 9 At all temperature levels hold the temperature to +/- 0.5°C during the measurement procedure.

7.2 PROVISIONS APPLICABLE

7.2.1 For Hand carried battery powered equipment

According to the JTC standard the frequency stability of the carrier shall be accurate to within 0.1 ppm of the received frequency from the base station. This accuracy is sufficient to meet Sec. 24.235, Frequency Stability. The frequency stability shall be sufficient to ensure that the fundamental emission stays within the authorized frequency block. As this transceiver is considered "Hand carried, battery powered equipment" Section 2.1055(d)(2) applies. This requires that the lower voltage for frequency stability testing be specified by the manufacturer. This transceiver is specified to operate with an input voltage of between 3.5VDC and 4.2VDC, with a nominal voltage of 3.7VDC. Operation above or below these voltage limits is prohibited by transceiver software in order to prevent improper operation as well as to protect components from overstress. These voltages represent a tolerance of -10 % and +12.5 %. For the purposes of measuring frequency stability these voltage limits are to be used.

7.2.2 For equipment powered by primary supply voltage

According to the JTC standard the frequency stability of the carrier shall be accurate to within 0.1 ppm of the received frequency from the base station. This accuracy is sufficient to meet Sec. 24.235, Frequency Stability. The frequency stability shall be sufficient to ensure that the fundamental emission stays within the authorized frequency block. For this EUT section 2.1055(d)(1) applies. This requires varying primary supply voltage from 85 to 115 percent of the nominal value for other than hand carried battery equipment, the normal environment temperature is 20°C.

7.3 Measurement Result

Frequency Error Against Voltage for GSM 850 band			
Voltage (V)	Frequency Error (Hz)	Frequency Error (ppm)	Limit (ppm)
10.2	31	0.037	±2.5
12.0	19	0.023	±2.5
13.8	14	0.017	±2.5

Frequency Error Against Temperature for GSM 850 band			
Temperature (°C)	Frequency Error (Hz)	Frequency Error (ppm)	Limit (ppm)
-10	38	0.045	±2.5
0	27	0.032	±2.5
10	25	0.030	±2.5
20	19	0.023	±2.5
30	22	0.026	±2.5
40	27	0.032	±2.5
50	33	0.039	±2.5

Note: The EUT doesn't work below -10°C

Frequency Error Against Voltage for GPRS 850 band			
Voltage (V)	Frequency Error (Hz)	Frequency Error (ppm)	Limit (ppm)
10.2	33	0.039	±2.5
12.0	20	0.024	±2.5
13.8	17	0.020	±2.5

Frequency Error Against Temperature for GPRS 850 band			
Temperature (°C)	Frequency Error (Hz)	Frequency Error (ppm)	Limit (ppm)
-10	35	0.042	±2.5
0	24	0.029	±2.5
10	28	0.033	±2.5
20	17	0.020	±2.5
30	22	0.026	±2.5
40	26	0.031	±2.5
50	37	0.044	±2.5

Note: The EUT doesn't work below -10°C

Frequency Error Against Voltage for EGPRS 850 band			
Voltage (V)	Frequency Error (Hz)	Frequency Error (ppm)	Limit (ppm)
10.2	32	0.038	±2.5
12.0	24	0.029	±2.5
13.8	12	0.014	±2.5

Frequency Error Against Temperature for EGPRS 850 band			
Temperature (°C)	Frequency Error (Hz)	Frequency Error (ppm)	Limit (ppm)
-10	34	0.041	±2.5
0	23	0.027	±2.5
10	27	0.032	±2.5
20	15	0.018	±2.5
30	24	0.029	±2.5
40	25	0.030	±2.5
50	30	0.036	±2.5

Note: The EUT doesn't work below -10°C

Frequency Error Against Voltage for PCS 1900 band			
Voltage (V)	Frequency Error (Hz)	Frequency Error (ppm)	Limit (ppm)
10.2	21	0.011	±2.5
12.0	34	0.018	±2.5
13.8	25	0.013	±2.5

Frequency Error Against Temperature for PCS 1900 band			
Temperature (°C)	Frequency Error (Hz)	Frequency Error (ppm)	Limit (ppm)
-10	29	0.015	±2.5
0	24	0.013	±2.5
10	32	0.017	±2.5
20	37	0.020	±2.5
30	20	0.011	±2.5
40	18	0.010	±2.5
50	17	0.009	±2.5

Note: The EUT doesn't work below -10°C

Frequency Error Against Voltage for GPRS 1900 band			
Voltage (V)	Frequency Error (Hz)	Frequency Error (ppm)	Limit (ppm)
10.2	23	0.012	±2.5
12.0	31	0.016	±2.5
13.8	27	0.014	±2.5

Frequency Error Against Temperature for GPRS 1900 band			
Temperature (°C)	Frequency Error (Hz)	Frequency Error (ppm)	Limit (ppm)
-10	25	0.013	±2.5
0	23	0.012	±2.5
10	35	0.019	±2.5
20	33	0.018	±2.5
30	23	0.012	±2.5
40	12	0.006	±2.5
50	15	0.008	±2.5

Note: The EUT doesn't work below -10°C

Frequency Error Against Voltage for EGPRS 1900 band			
Voltage (V)	Frequency Error (Hz)	Frequency Error (ppm)	Limit (ppm)
10.2	27	0.014	±2.5
12.0	33	0.018	±2.5
13.8	22	0.012	±2.5

Frequency Error Against Temperature for EGPRS 1900 band			
Temperature (°C)	Frequency Error (Hz)	Frequency Error (ppm)	Limit (ppm)
-10	22	0.012	±2.5
0	27	0.014	±2.5
10	31	0.016	±2.5
20	35	0.019	±2.5
30	23	0.012	±2.5
40	12	0.006	±2.5
50	15	0.008	±2.5

Note: The EUT doesn't work below -10°C

Frequency Error Against Voltage for UMTS band II			
Voltage (V)	Frequency Error (Hz)	Frequency Error (ppm)	Limit (ppm)
10.2	22	0.012	±2.5
12.0	19	0.010	±2.5
13.8	26	0.014	±2.5

Frequency Error Against Temperature for UMTS band II			
Temperature (°C)	Frequency Error (Hz)	Frequency Error (ppm)	Limit (ppm)
-10	34	0.018	±2.5
0	31	0.016	±2.5
10	18	0.010	±2.5
20	36	0.019	±2.5
30	37	0.020	±2.5
40	25	0.013	±2.5
50	19	0.010	±2.5

Note: The EUT doesn't work below -10°C

Frequency Error Against Voltage for UMTS band V			
Voltage (V)	Frequency Error (Hz)	Frequency Error (ppm)	Limit (ppm)
10.2	28	0.033	±2.5
12.0	15	0.018	±2.5
13.8	23	0.027	±2.5

Frequency Error Against Temperature for UMTS band V			
Temperature (°C)	Frequency Error (Hz)	Frequency Error (ppm)	Limit (ppm)
-10	33	0.039	±2.5
0	26	0.031	±2.5
10	31	0.037	±2.5
20	19	0.023	±2.5
30	24	0.029	±2.5
40	19	0.023	±2.5
50	27	0.032	±2.5

Note: The EUT doesn't work below -10°C

8. BANDWIDTH

8.1 Applicable Standard

FCC §2.1049, §22.917, §22.905 and §24.238.

8.2 Test Procedure

1. The EUT was connected to Spectrum Analyzer and Base Station via power divider.
2. The 99% and 26 dB occupied bandwidth (BW) of the middle channel for the highest RF powers.
3. Details according with KDB 971168 section 4.1 & 4.2.

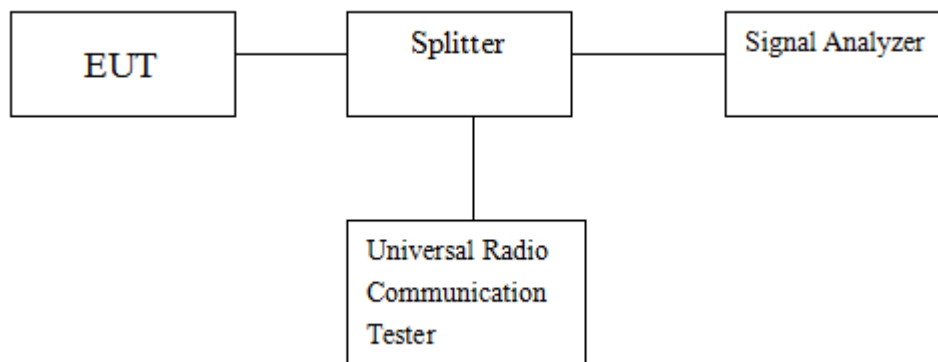

Test Equipment List and Details

Refer a test equipment and calibration data table in this test report.

8.3 Measurement Result

Occupied Bandwidth (99%) for GSM 850 band		
Mode	Frequency(MHz)	Occupied Bandwidth (99%)(kHz)
Low Channel	824.2	244.393
Middle Channel	836.6	245.689
High Channel	848.8	242.196

Occupied Bandwidth (99%) for PCS 1900 band		
Mode	Frequency(MHz)	Occupied Bandwidth (99%)(kHz)
Low Channel	1850.2	244.076
Middle Channel	1880.0	250.017
High Channel	1909.8	242.912

Occupied Bandwidth (99%) for GPRS 850 band		
Mode	Frequency(MHz)	Occupied Bandwidth (99%)(kHz)

Low Channel	824.2	244.537
Middle Channel	836.6	243.568
High Channel	848.8	247.644

Occupied Bandwidth (99%) for GPRS 1900 band		
Mode	Frequency(MHz)	Occupied Bandwidth (99%)(kHz)
Low Channel	1850.2	244.035
Middle Channel	1880.0	243.109
High Channel	1909.8	246.649

Occupied Bandwidth (99%) for EGPRS 850 band		
Mode	Frequency(MHz)	Occupied Bandwidth (99%)(kHz)
Low Channel	824.2	243.282
Middle Channel	836.6	240.883
High Channel	848.8	244.906

Occupied Bandwidth (99%) for EGPRS 1900 band		
Mode	Frequency(MHz)	Occupied Bandwidth (99%)(kHz)
Low Channel	1850.2	247.763
Middle Channel	1880.0	239.646
High Channel	1909.8	243.433

Occupied Bandwidth (99%) for UMTS band II		
Mode	Frequency(MHz)	Occupied Bandwidth (99%)(MHz)
Low Channel	1852.4	4.164
Middle Channel	1880.0	4.170
High Channel	1907.6	4.168

Occupied Bandwidth (99%) for UMTS band V		
Mode	Frequency(MHz)	Occupied Bandwidth (99%)(MHz)
Low Channel	826.4	4.162
Middle Channel	836.4	4.156
High Channel	846.6	4.152

Emission Bandwidth (-26dBc) for GSM 850 band		
-----------------------------------------------------	--	--

Mode	Frequency(MHz)	Emission Bandwidth (-26dBc)(kHz)
Low Channel	824.2	317.514
Middle Channel	836.6	318.268
High Channel	848.8	308.743

Emission Bandwidth (-26dBc) for PCS 1900 band		
Mode	Frequency(MHz)	Emission Bandwidth (-26dBc)(kHz)
Low Channel	1850.2	315.910
Middle Channel	1880.0	323.802
High Channel	1909.8	315.447

Emission Bandwidth (-26dBc) for GPRS 850 band		
Mode	Frequency(MHz)	Emission Bandwidth (-26dBc)(kHz)
Low Channel	824.2	318.316
Middle Channel	836.6	311.915
High Channel	848.8	322.406

Emission Bandwidth (-26dBc) for GPRS 1900 band		
Mode	Frequency(MHz)	Emission Bandwidth (-26dBc)(kHz)
Low Channel	1850.2	320.357
Middle Channel	1880.0	314.336
High Channel	1909.8	318.427

Emission Bandwidth (-26dBc) for EGPRS 850 band		
Mode	Frequency(MHz)	Emission Bandwidth (-26dBc)(kHz)
Low Channel	824.2	315.584
Middle Channel	836.6	313.986
High Channel	848.8	323.942

Emission Bandwidth (-26dBc) for EGPRS 1900 band		
Mode	Frequency(MHz)	Emission Bandwidth (-26dBc)(kHz)
Low Channel	1850.2	318.597
Middle Channel	1880.0	316.008
High Channel	1909.8	316.501

Emission Bandwidth (-26dBc) for UMTS band II		
Mode	Frequency(MHz)	Emission Bandwidth (-26dBc)(MHz)
Low Channel	1852.4	4.728
Middle Channel	1880.0	4.696
High Channel	1907.6	4.749

Emission Bandwidth (-26dBc) for UMTS band V		
Mode	Frequency(MHz)	Emission Bandwidth (-26dBc)(MHz)
Low Channel	826.4	4.715
Middle Channel	836.4	4.712
High Channel	846.6	4.691

9. BAND EDGE

9.1 Applicable Standard

According to § 22.917(a), the power of any emissions outside of the authorized operating frequency ranges must be attenuated below the transmitting power (P) by a factor of at least $43 + 10 \log(P)$ dB.

According to §24.238(a), the power of any emissions outside of the authorized operating frequency ranges must be attenuated below the transmitting power (P) by a factor of at least $43 + 10 \log(P)$ dB.

9.2 Test Procedure

1. The EUT was connected to Spectrum Analyzer and Base Station via power divider.
2. The Band Edges of low and high channels for the highest RF powers were measured. Setting RBW as roughly $BW/100$.
3. Details according with KDB 971168 section 6.0.

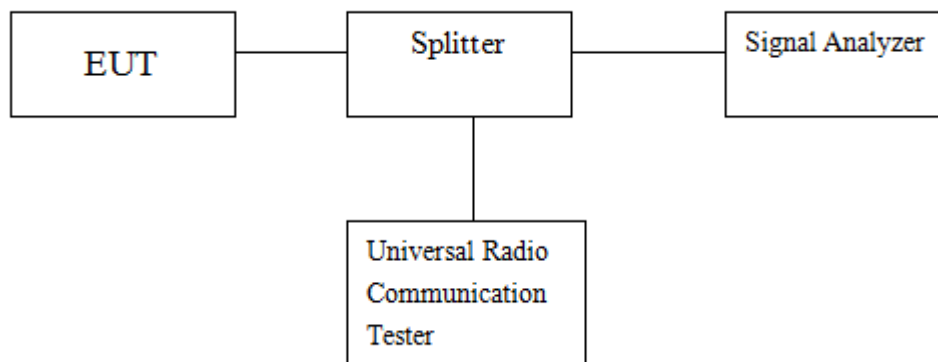

Test Equipment List and Details

Refer a test equipment and calibration data table in this test report.

9.3 Measurement Result

Please refers to Appendix III for compliance test plots for band edges

10. PEAK-TO-AVERAGE RATIO

10.1 MEASURING INSTRUMENTS

See list of measuring instruments of this test report.

The peak-to-average ratio (PAR) of the transmission may not exceed 13 dB.

10.2 TEST PROCEDURES

1. The EUT was connected to Spectrum Analyzer and Base Station via power divider.
2. The RF output of EUT was connected to the spectrum analyzer by RF cable and attenuator. The path loss was compensated to the results for each measurement.
3. For GSM/EGPRS operating modes:
 - a. Set the RBW = 1MHz, VBW = 1MHz, Peak detector in spectrum analyzer.
 - b. Set EUT in maximum power output, and triggered the burst signal.
 - c. Measured respectively the Peak level and Mean level, and the deviation was recorded as Peak to Average Ratio.
4. For UMTS operating modes:
 - a. Set the CCDF (Complementary Cumulative Distribution Function) option in spectrum analyzer.
 - b. The highest RF powers were measured and recorded the maximum PAPR level associated with a probability of 0.1 %.

10.3 TEST SETUP

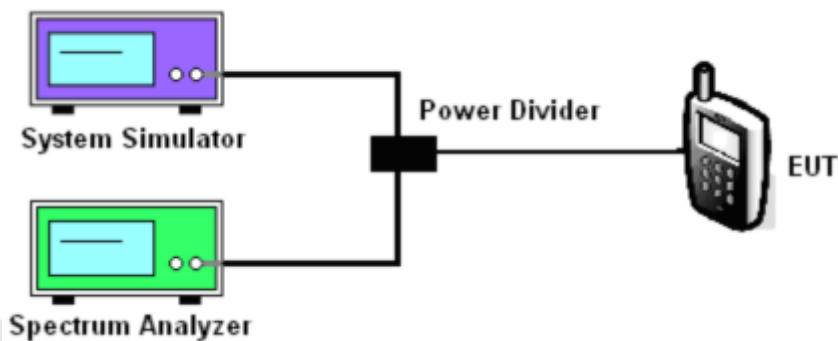

10.4 TEST RESULT OF PEAK-TO-AVERAGE RATIO

Cellular Band						
Modes	GSM850			GSM1900		
Channel	128 (Low)	190 (Mid)	251 (High)	512 (Low)	661 (Mid)	810 (High)
Frequency(MHz)	824.2	836.6	848.8	1850.2	1880	1909.8
Peak-to-Average Ratio (dB)	9.54	9.27	9.47	8.78	9.41	9.30

Cellular Band						
Modes	WCDMA Band II (RMC 12.2Kbps)			WCDMA Band V (RMC 12.2Kbps)		
Channel	9262 (Low)	9400 (Mid)	9538 (High)	4132 (Low)	4175 (Mid)	4233 (High)
Frequency(MHz)	1852.4	1880	1907.6	826.4	836.6	846.6
Peak-to-Average Ratio (dB)	3.08	3.05	2.96	3.29	3.55	3.31

Cellular Band						
Modes	GPRS850			GPRS1900		
Channel	128 (Low)	190 (Mid)	251 (High)	512 (Low)	661 (Mid)	810 (High)
Frequency(MHz)	824.2	836.6	848.8	1850.2	1880	1909.8
Peak-to-Average Ratio (dB)	9.74	9.88	9.98	9.48	9.20	9.67

Cellular Band						
Modes	EGPRS850			EGPRS1900		
Channel	128 (Low)	190 (Mid)	251 (High)	512 (Low)	661 (Mid)	810 (High)
Frequency(MHz)	824.2	836.6	848.8	1850.2	1880	1909.8
Peak-to-Average Ratio (dB)	12.43	12.55	11.88	12.14	11.93	12.79

GSM850

GSM1900



Low

Low



Mid

Mid

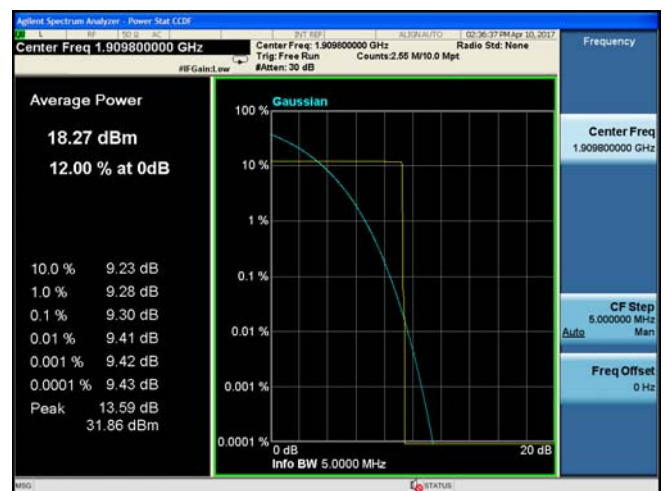

High

High

GPRS850

GPRS1900



Low

Low

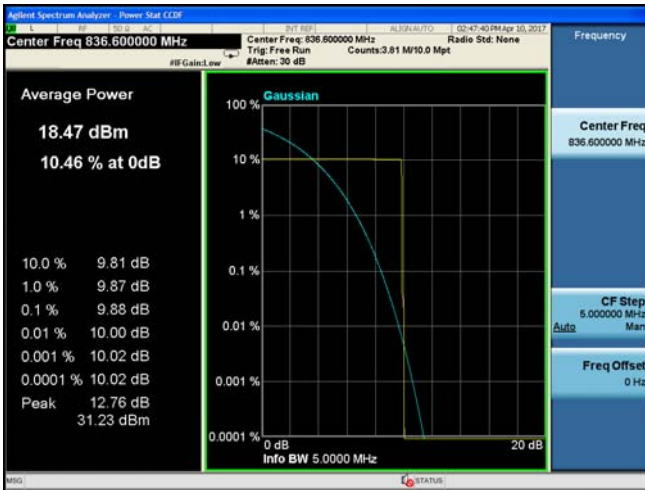

Mid

Mid



High

High

EGPRS850

EGPRS1900



Low

Low



Mid

Mid



High

High

WCDMA Band V

WCDMA Band II

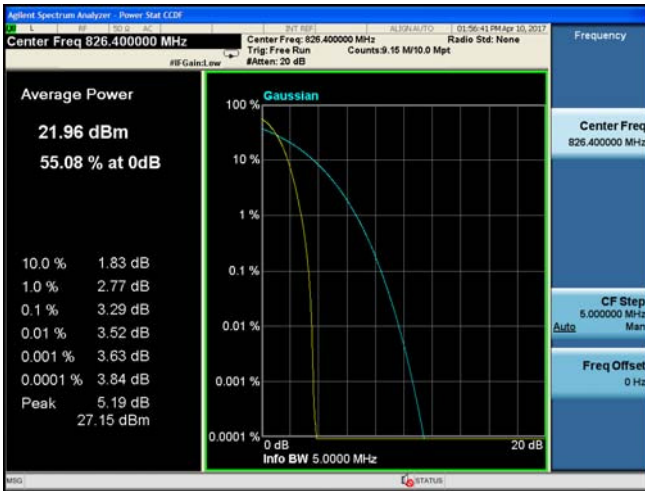

Low

Low



Mid

Mid

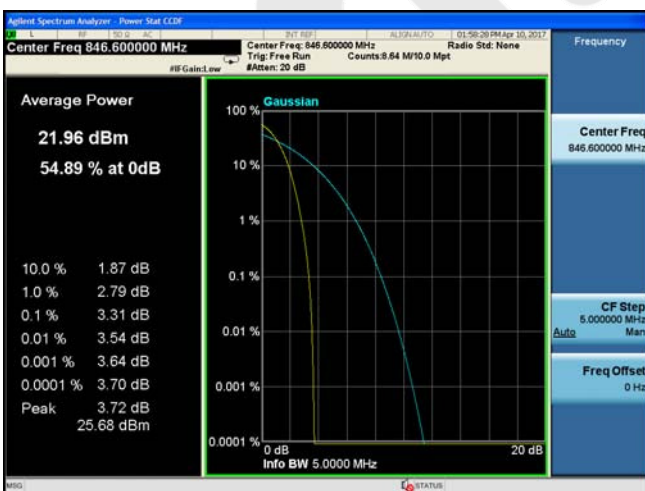

High

High

APPENDIX I

TEST PLOTS FOR CONDUCTED SPURIOUS EMISSION

CONDUCTED EMISSION IN GSM 850 BAND

Conducted Emission Transmitting Mode CH 128 30MHz – 5GHz

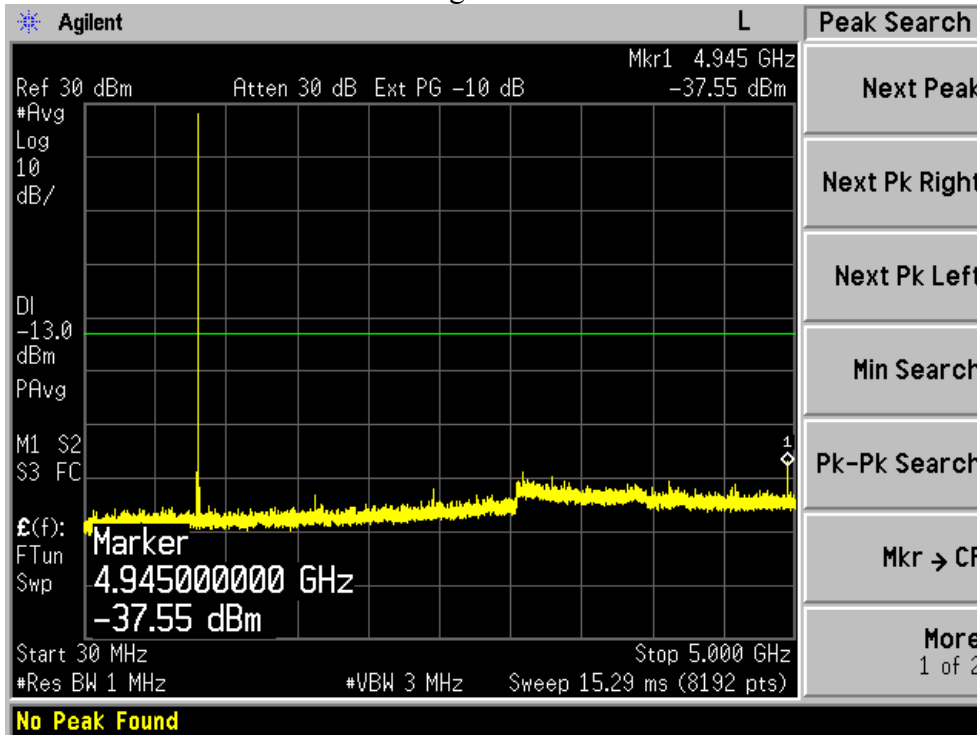

Conducted Emission Transmitting Mode CH 128 5GHz – 10GHz

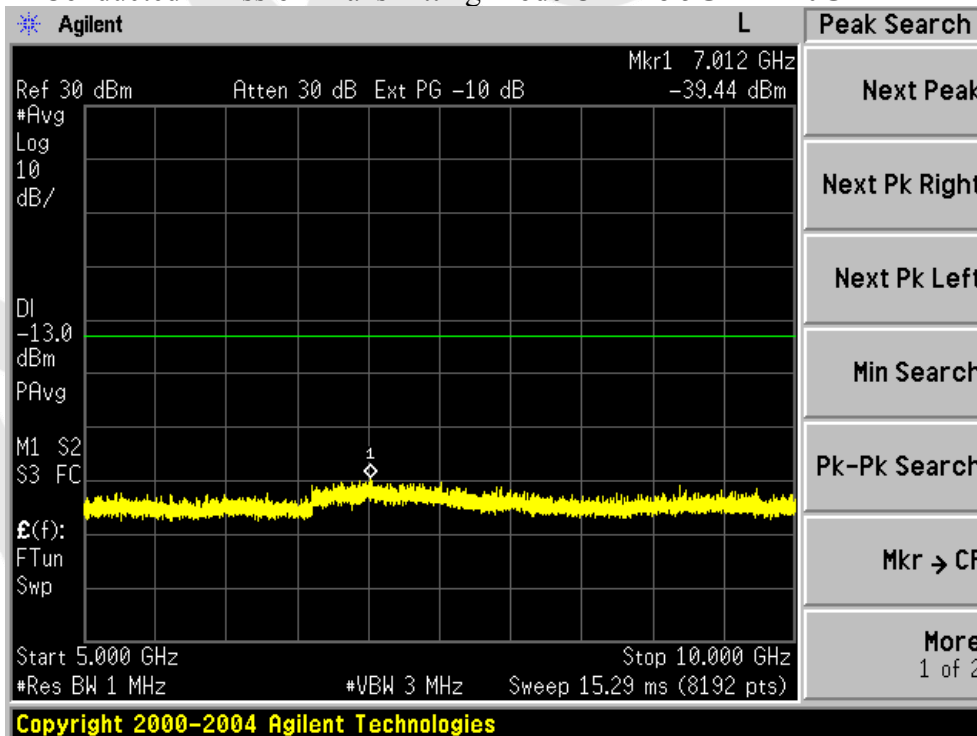

Conducted Emission Transmitting Mode CH 190 30MHz – 5GHz

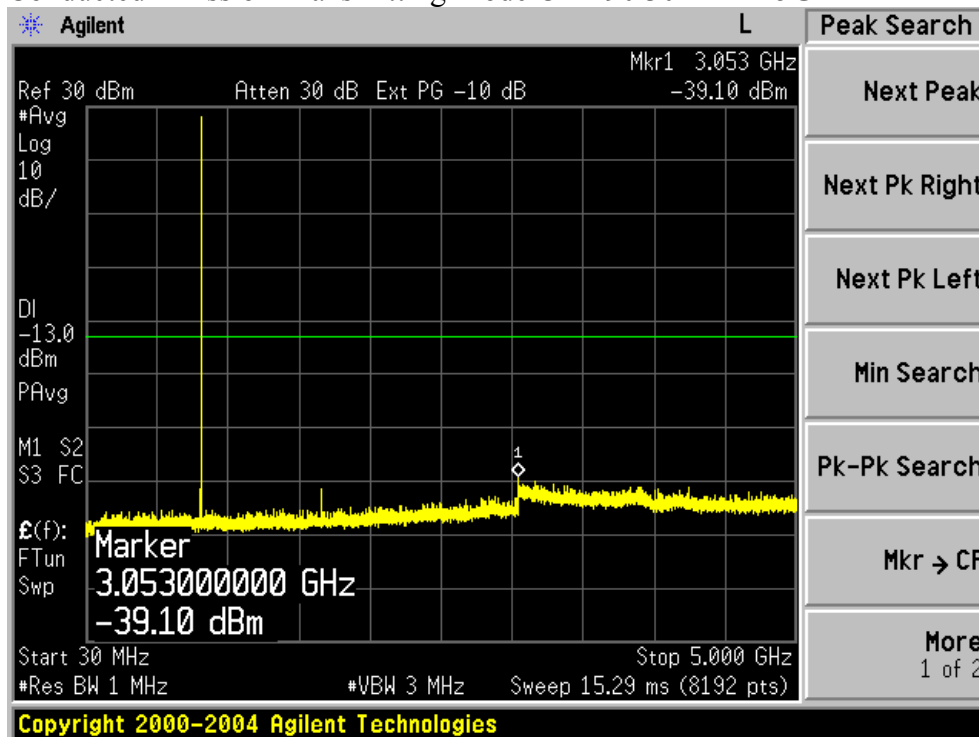

Conducted Emission Transmitting Mode CH 190 5GHz – 10GHz

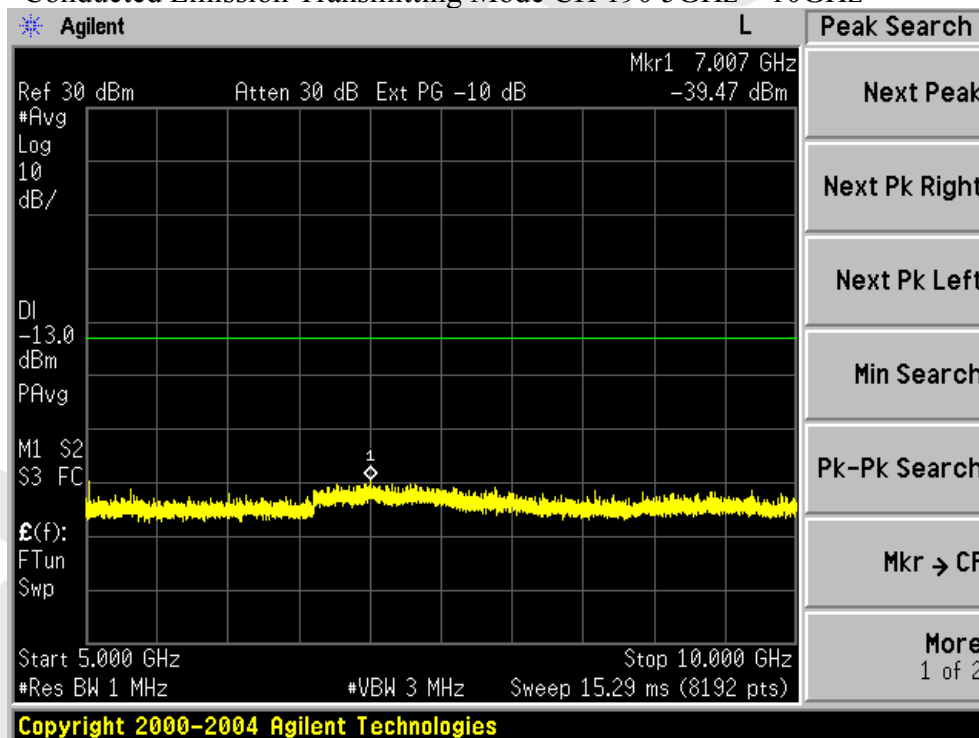

Conducted Emission Transmitting Mode CH 251 30MHz – 5GHz

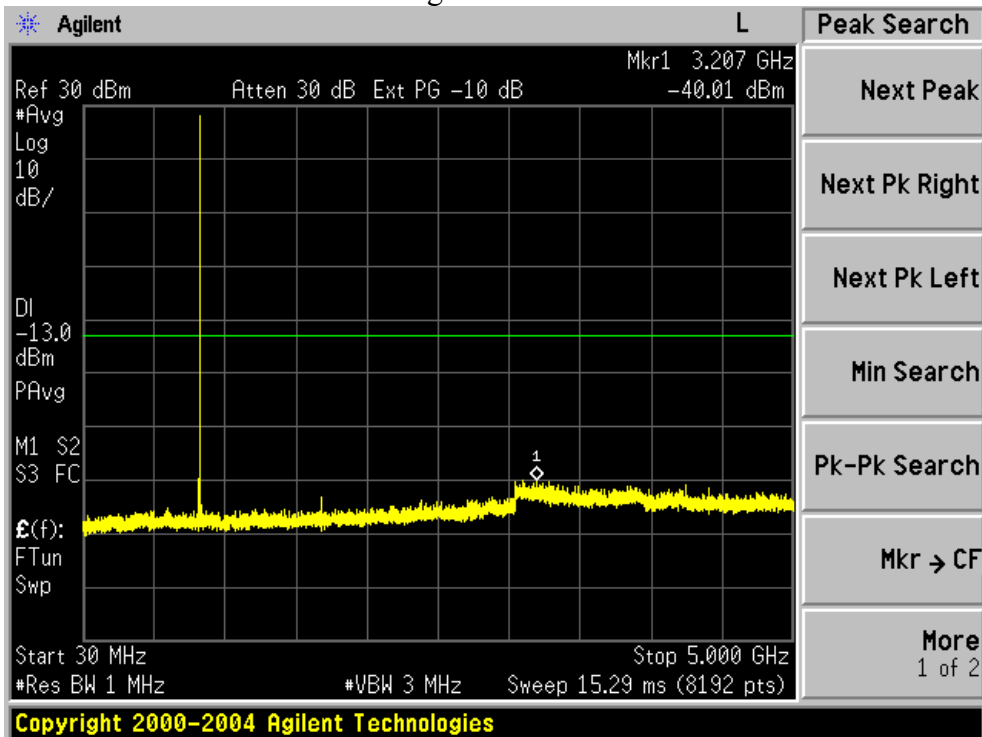

Conducted Emission Transmitting Mode CH 251 5GHz – 10GHz

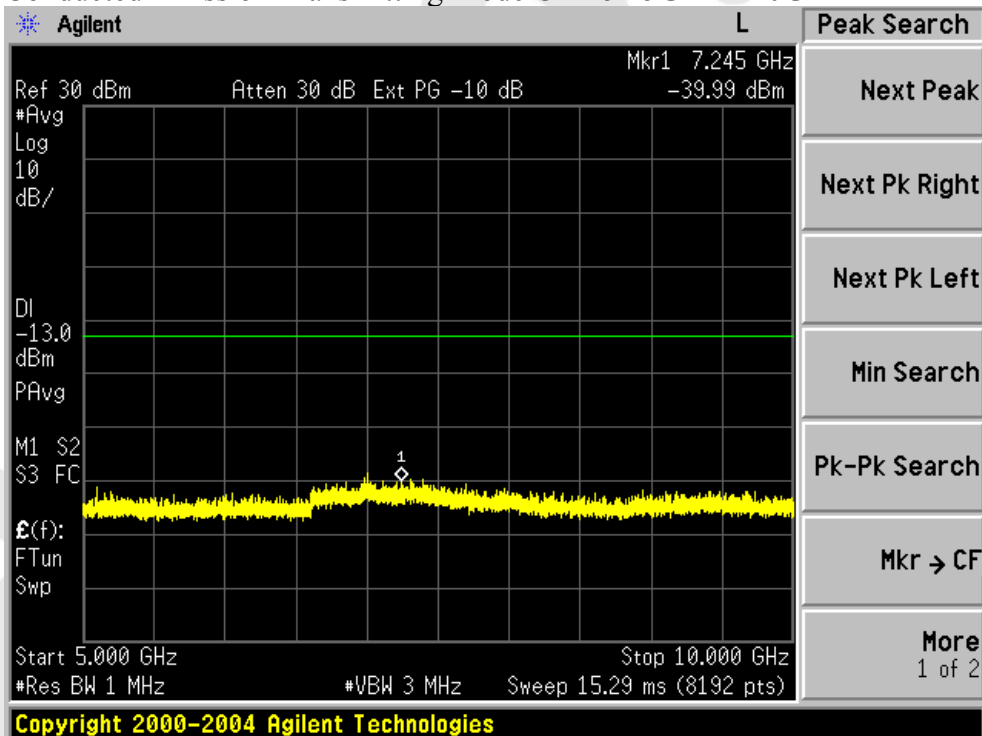

CONDUCTED EMISSION IN PCS1900 BAND
Conducted Emission Transmitting Mode CH 512 30MHz – 10GHz

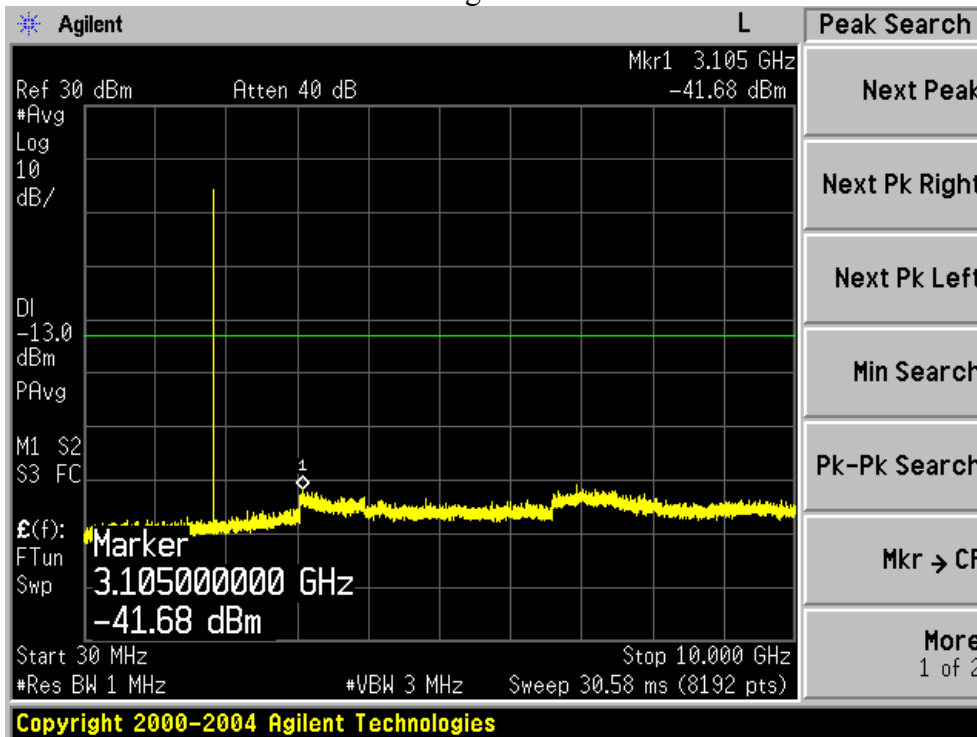

Conducted Emission Transmitting Mode CH 512 10GHz – 20GHz

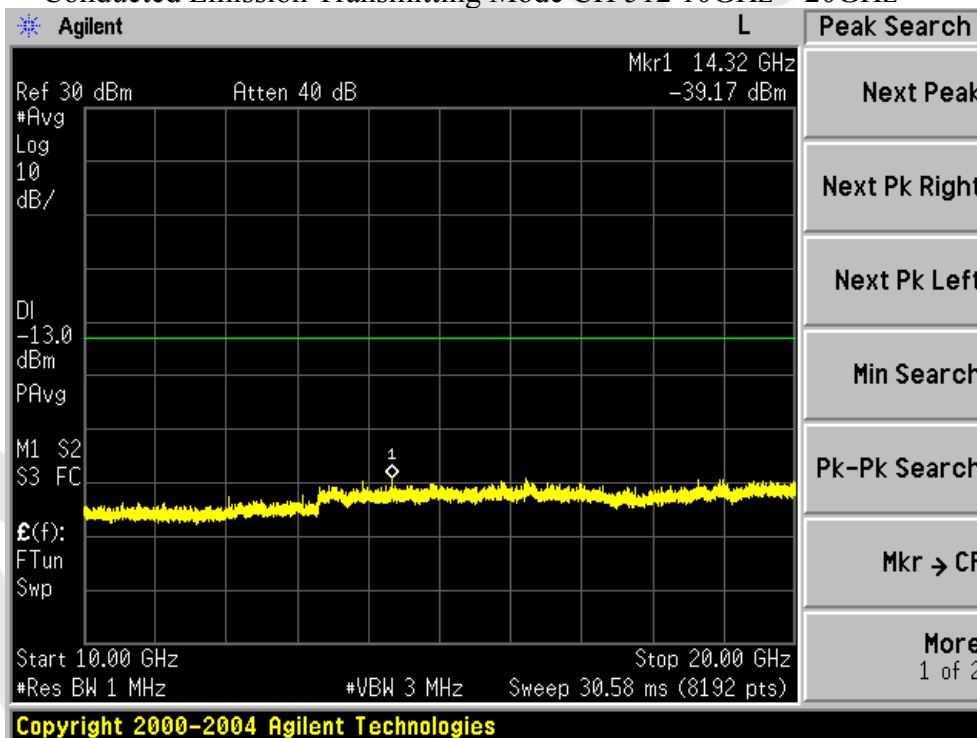

Conducted Emission Transmitting Mode CH 661 30MHz – 10GHz

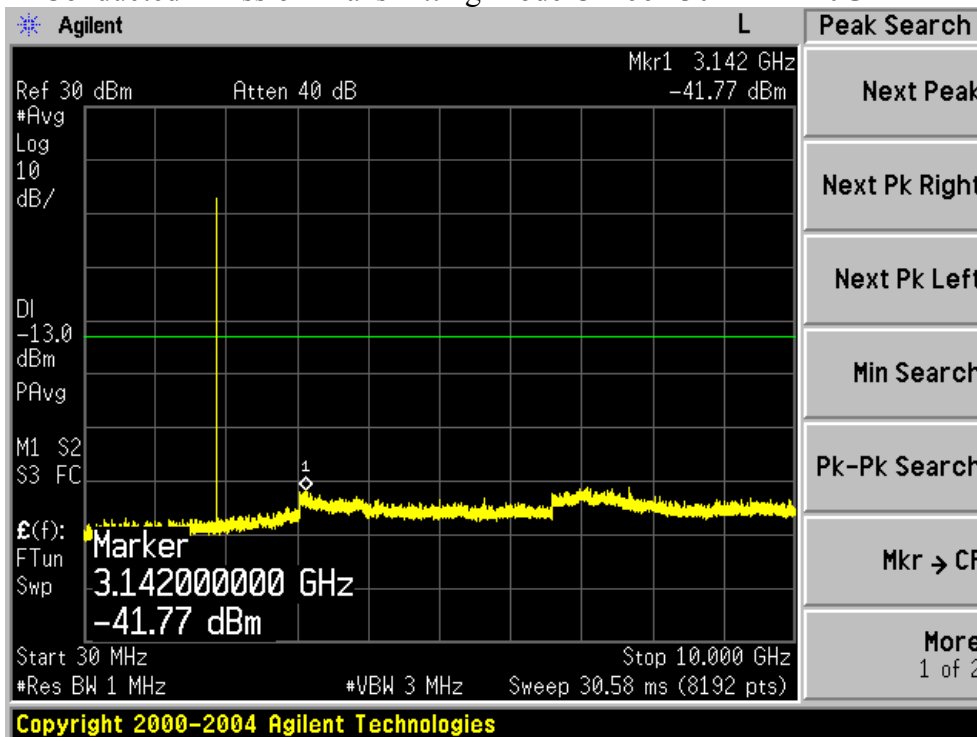

Conducted Emission Transmitting Mode CH 661 10GHz – 20GHz

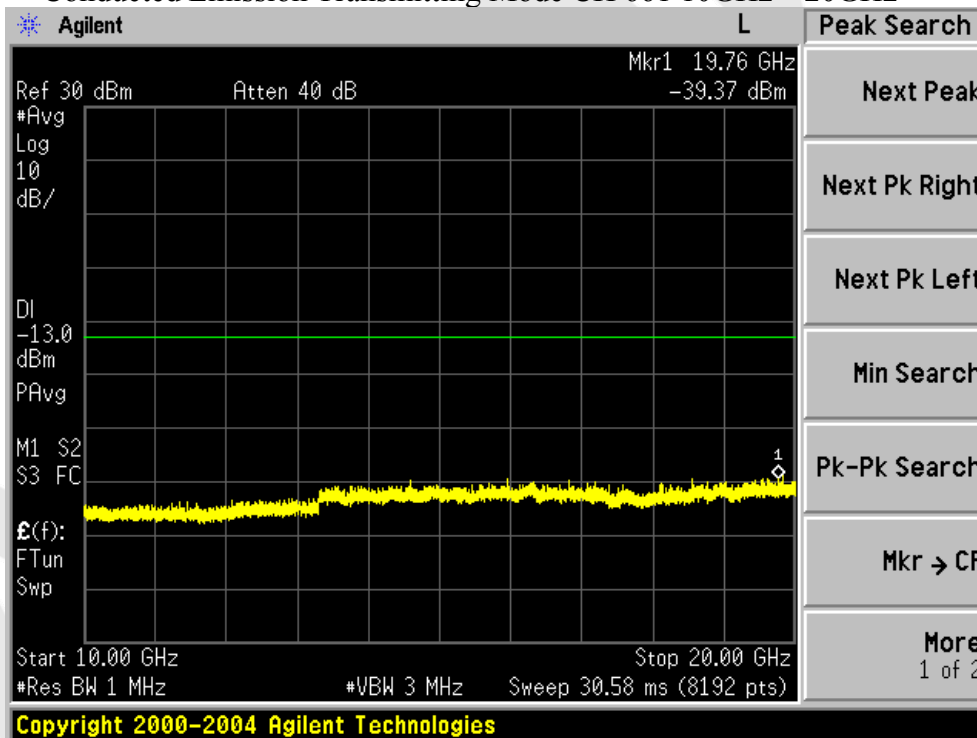

Conducted Emission Transmitting Mode CH 810 30MHz – 10GHz

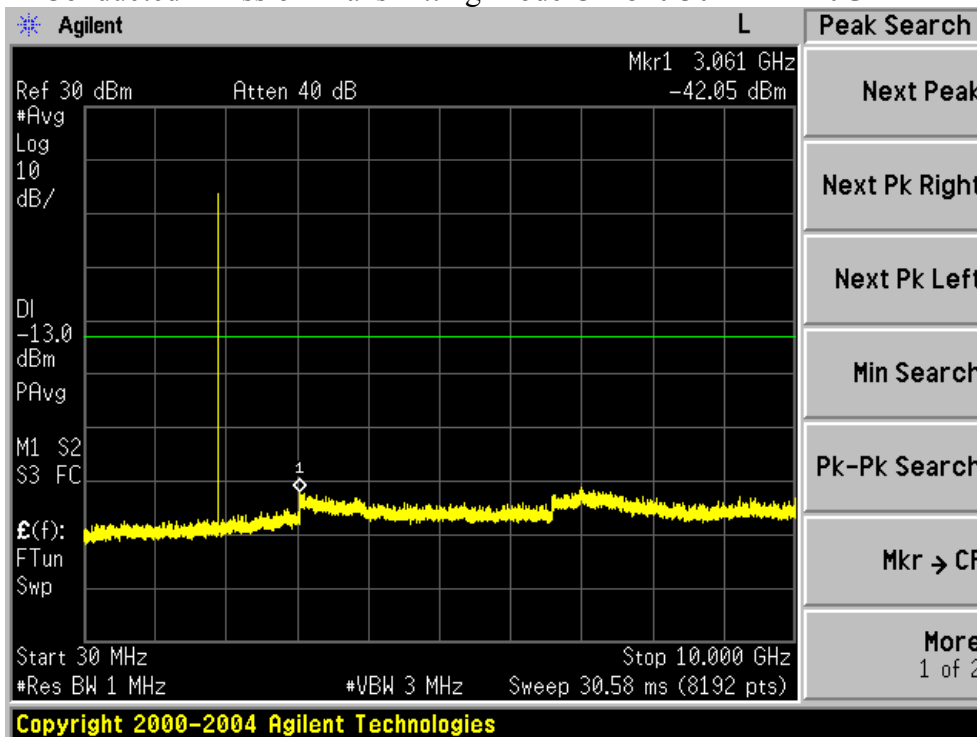

Conducted Emission Transmitting Mode CH 810 10GHz – 20GHz

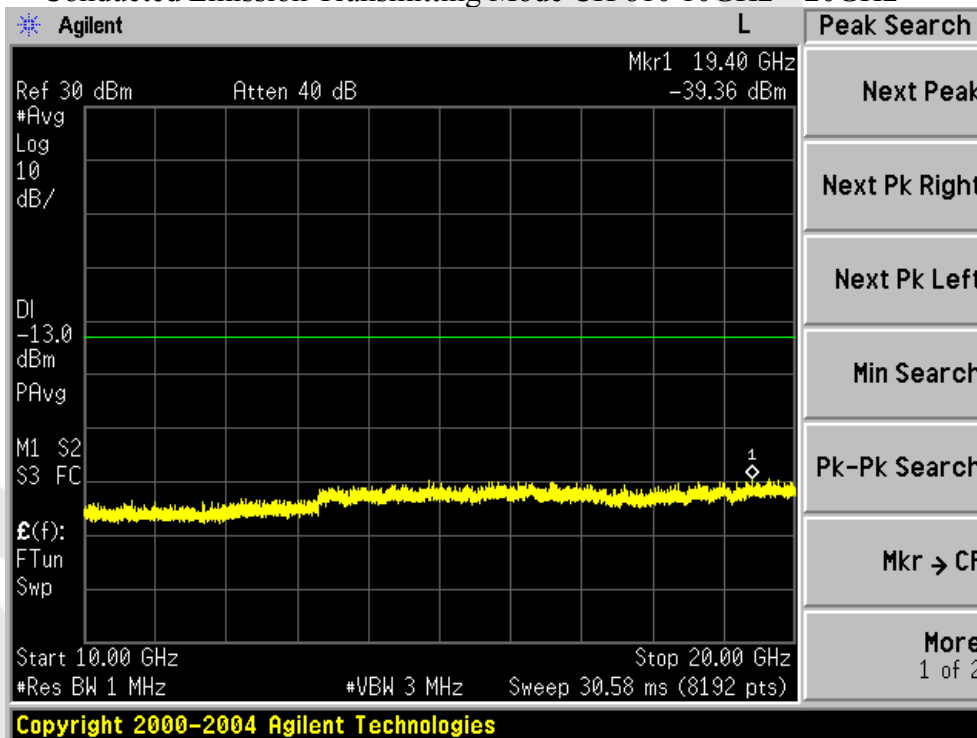

CONDUCTED EMISSION IN GPRS850 BAND

Conducted Emission Transmitting Mode CH 128 30MHz – 5GHz

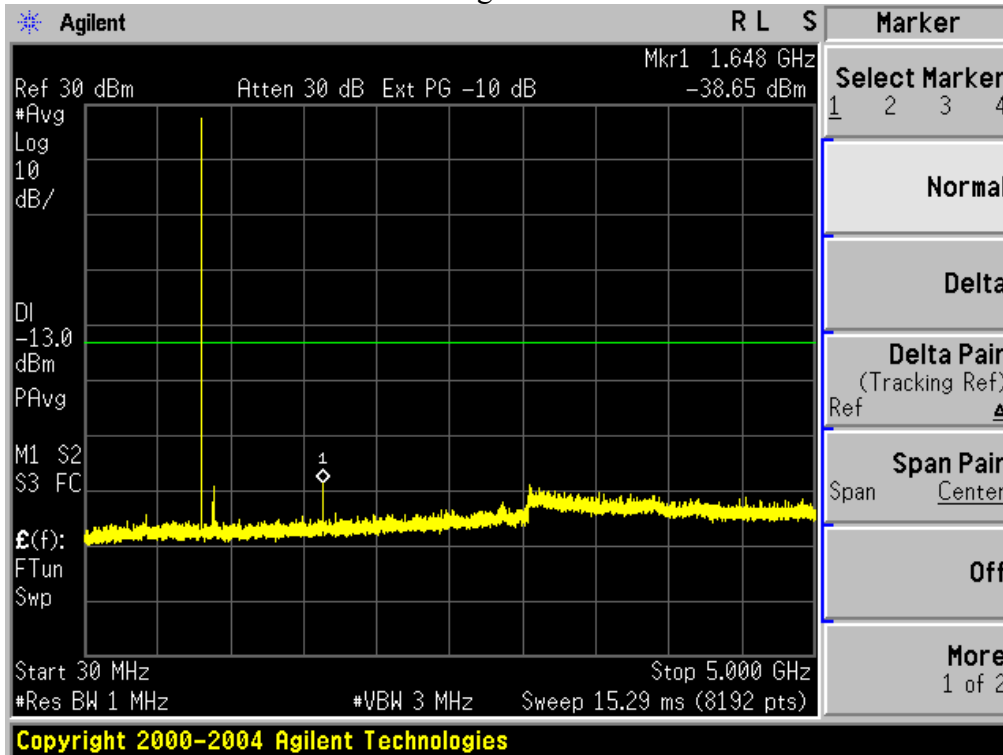

Conducted Emission Transmitting Mode CH 128 5GHz – 10GHz

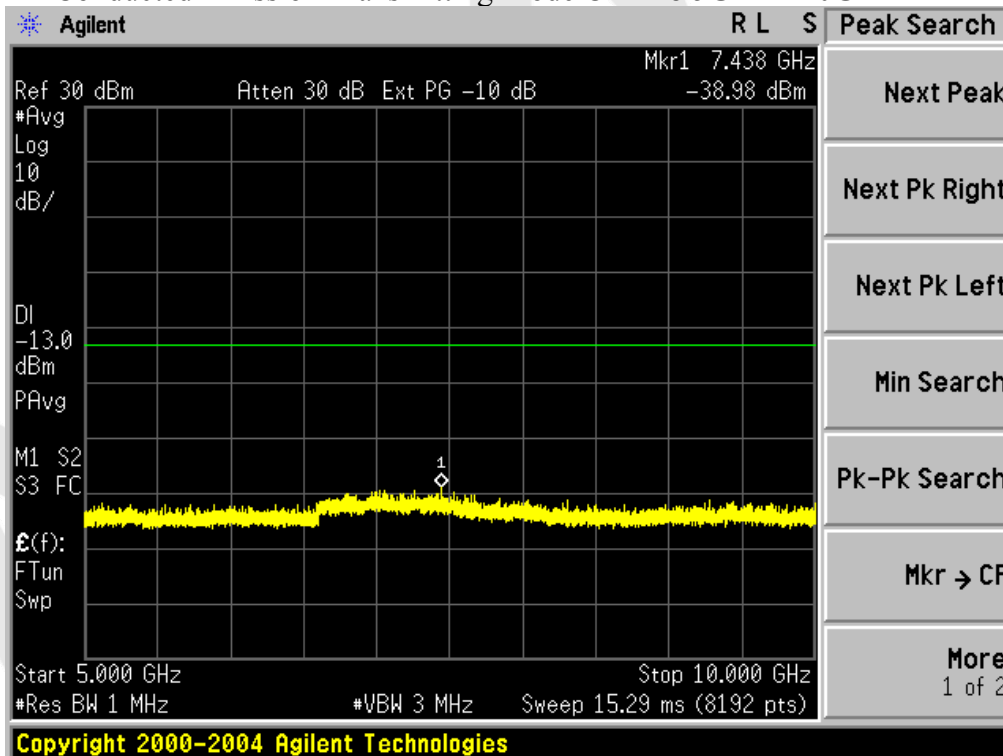

Conducted Emission Transmitting Mode CH 190 30MHz – 5GHz

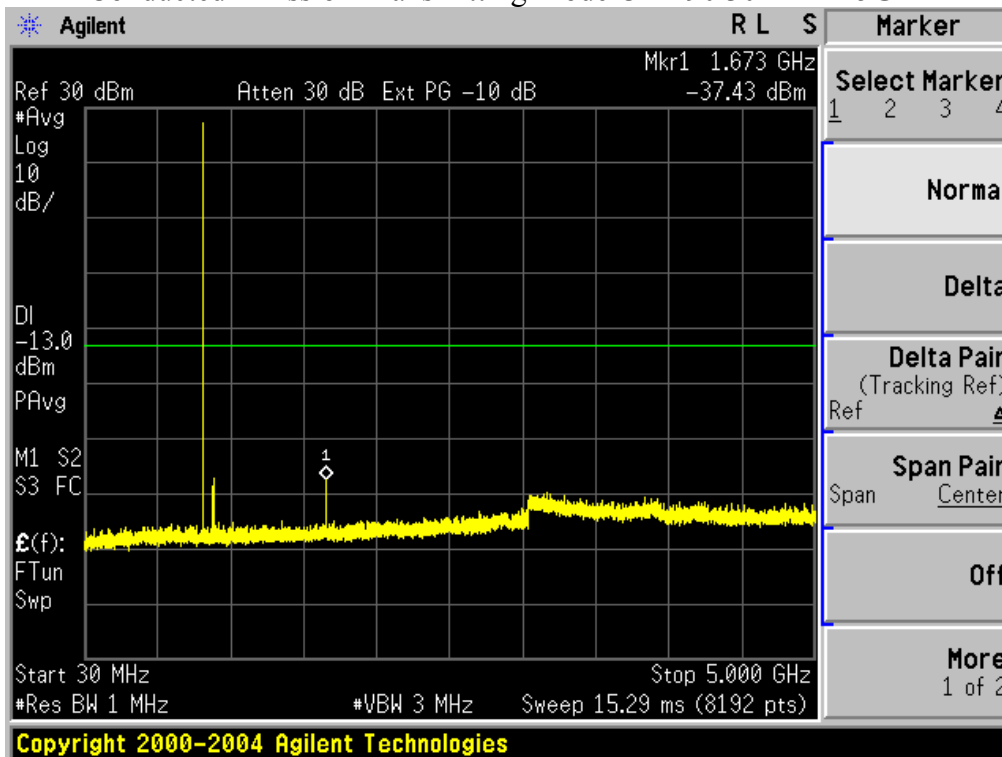

Conducted Emission Transmitting Mode CH 190 5GHz – 10GHz

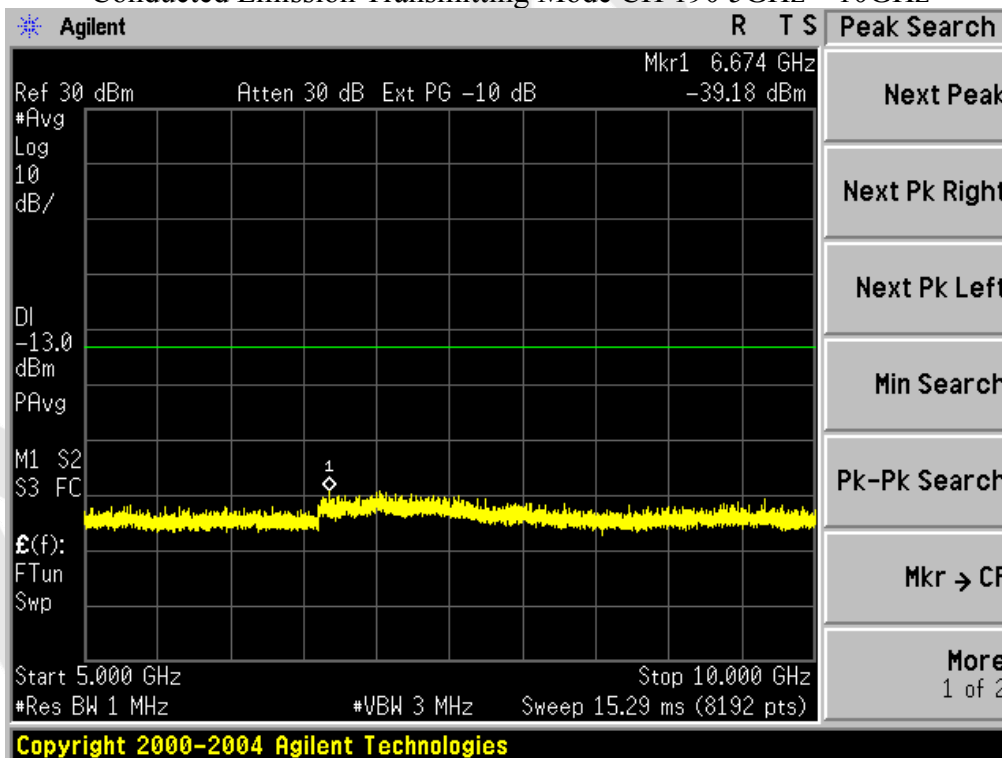

Conducted Emission Transmitting Mode CH 251 30MHz – 5GHz

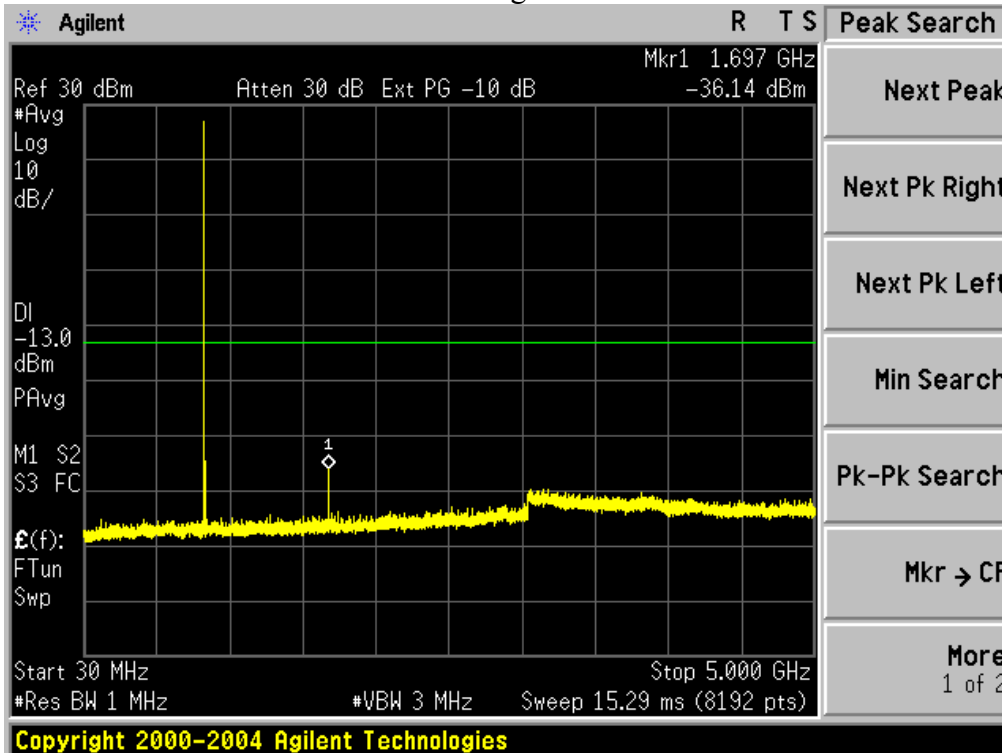

Conducted Emission Transmitting Mode CH 251 5GHz – 10GHz

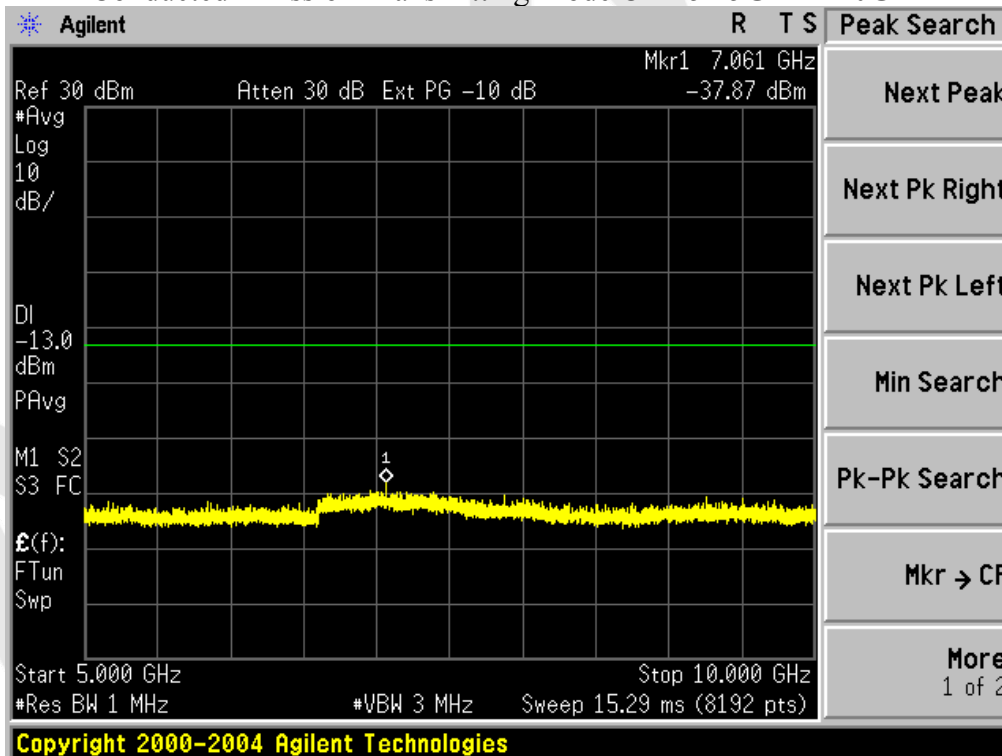

CONDUCTED EMISSION IN GPRS1900 BAND
Conducted Emission Transmitting Mode CH 512 30MHz – 10GHz

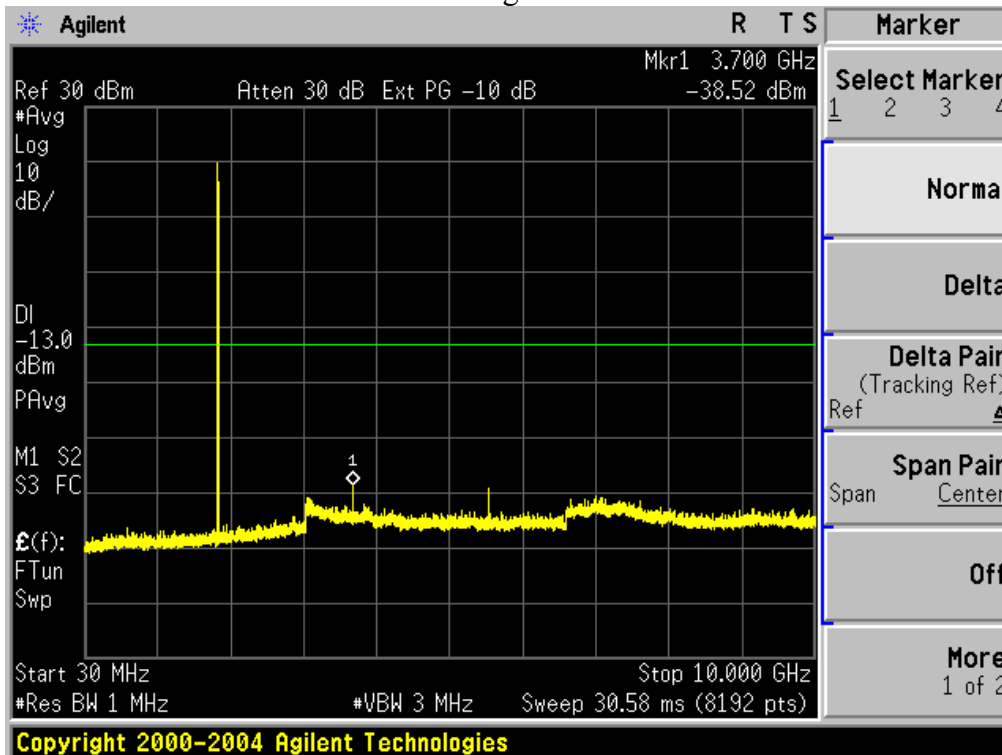

Conducted Emission Transmitting Mode CH 512 10GHz – 20GHz

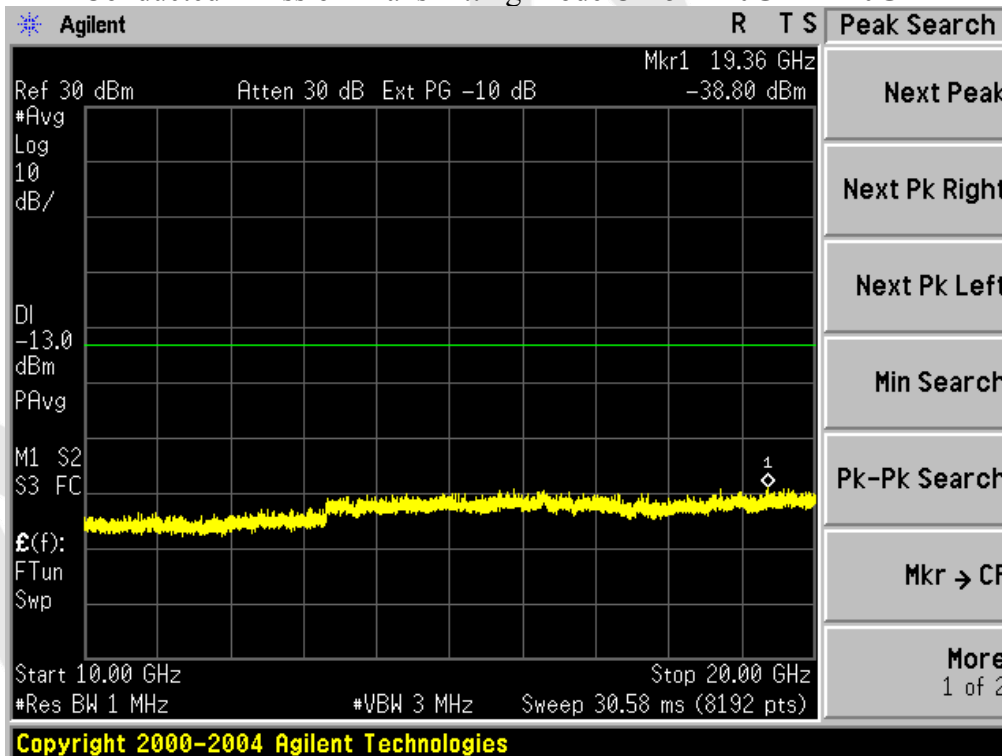

Conducted Emission Transmitting Mode CH 661 30MHz – 10GHz

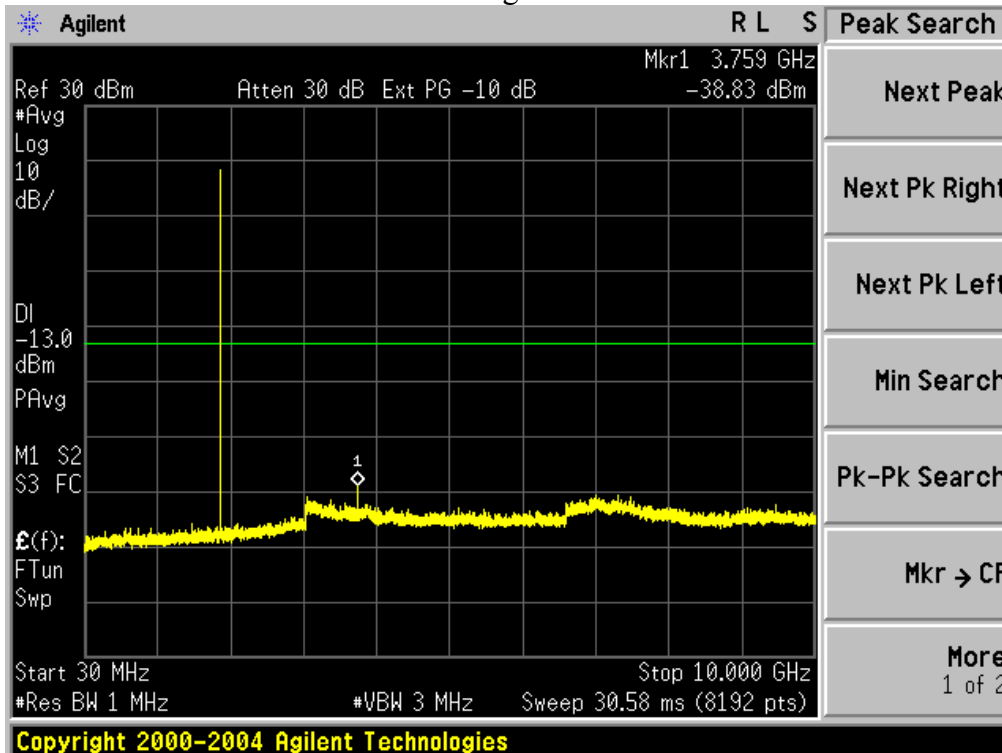

Conducted Emission Transmitting Mode CH 661 10GHz – 20GHz

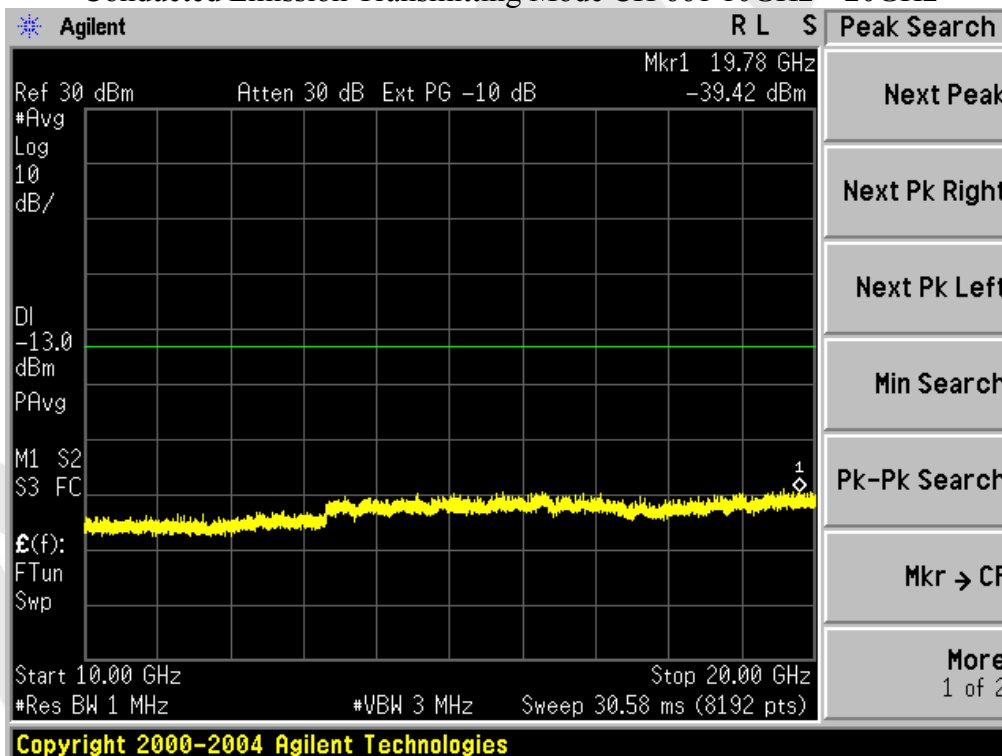

Conducted Emission Transmitting Mode CH 810 30MHz – 10GHz

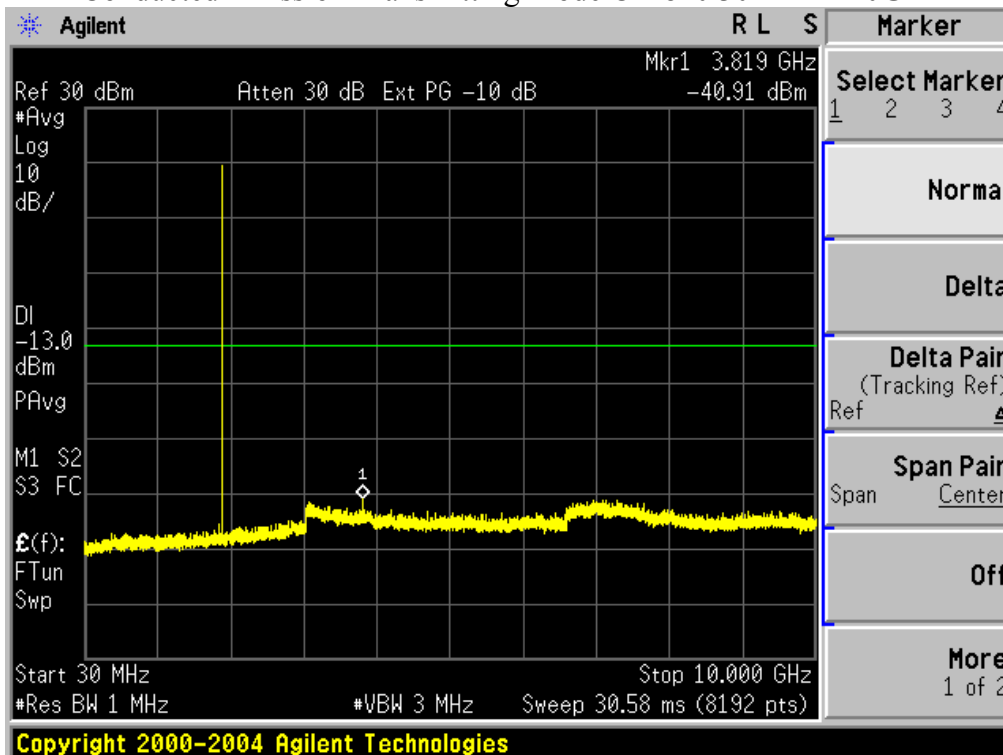

Conducted Emission Transmitting Mode CH 810 10GHz – 20GHz

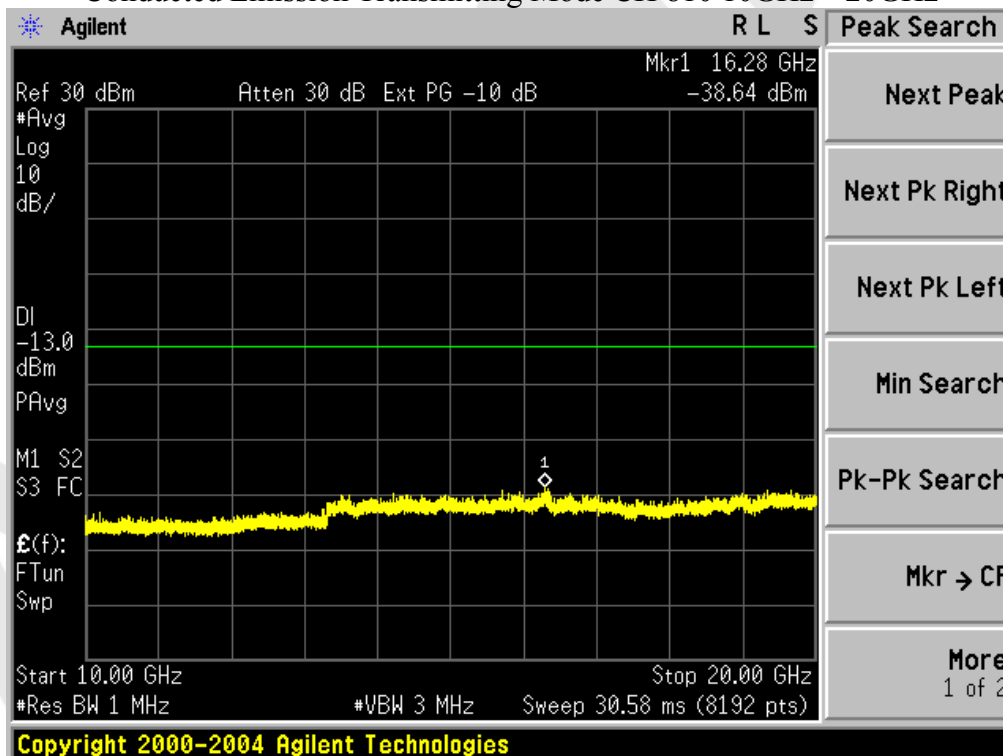

CONDUCTED EMISSION IN EGPRS 850 BAND
Conducted Emission Transmitting Mode CH 128 30MHz – 5GHz

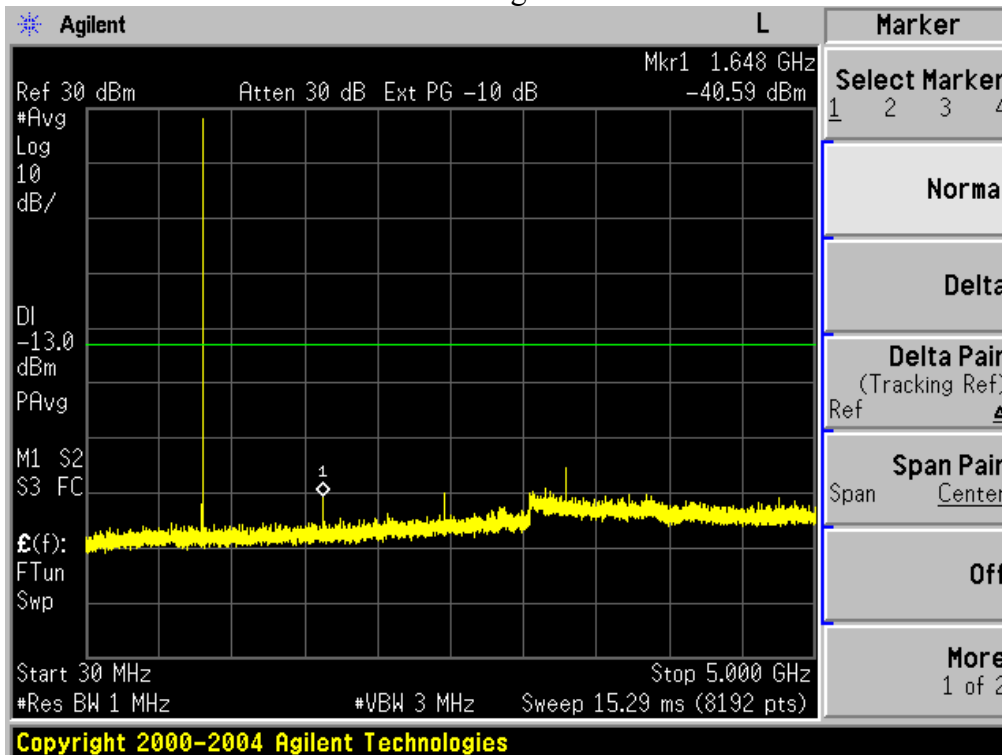

Conducted Emission Transmitting Mode CH 128 5GHz – 10GHz

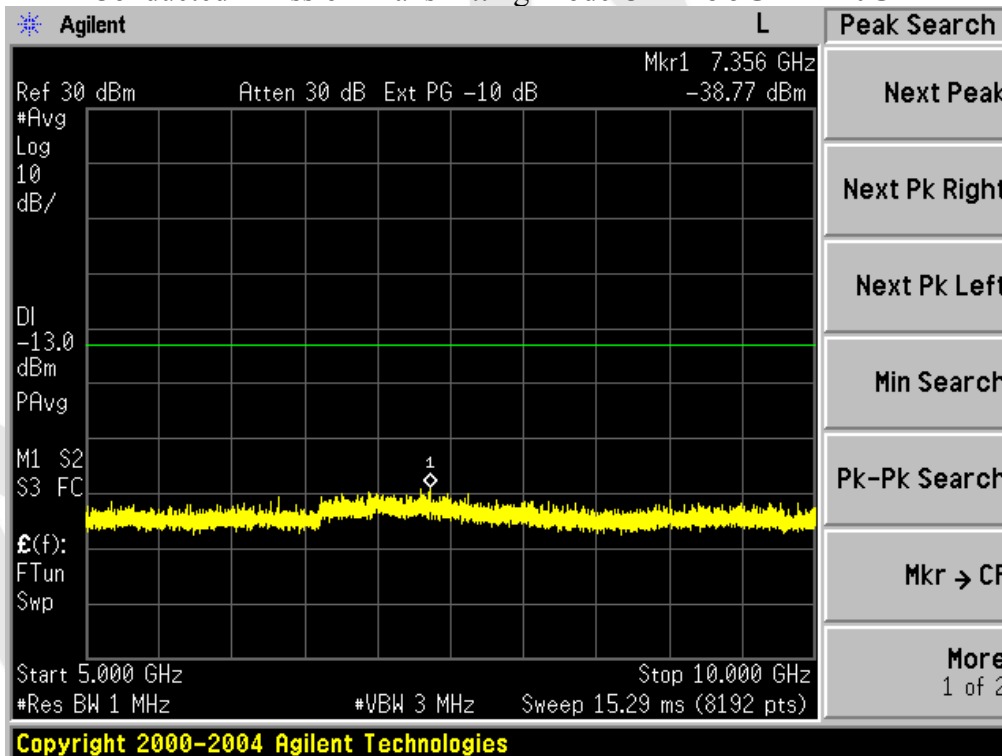

Conducted Emission Transmitting Mode CH 190 30MHz – 5GHz

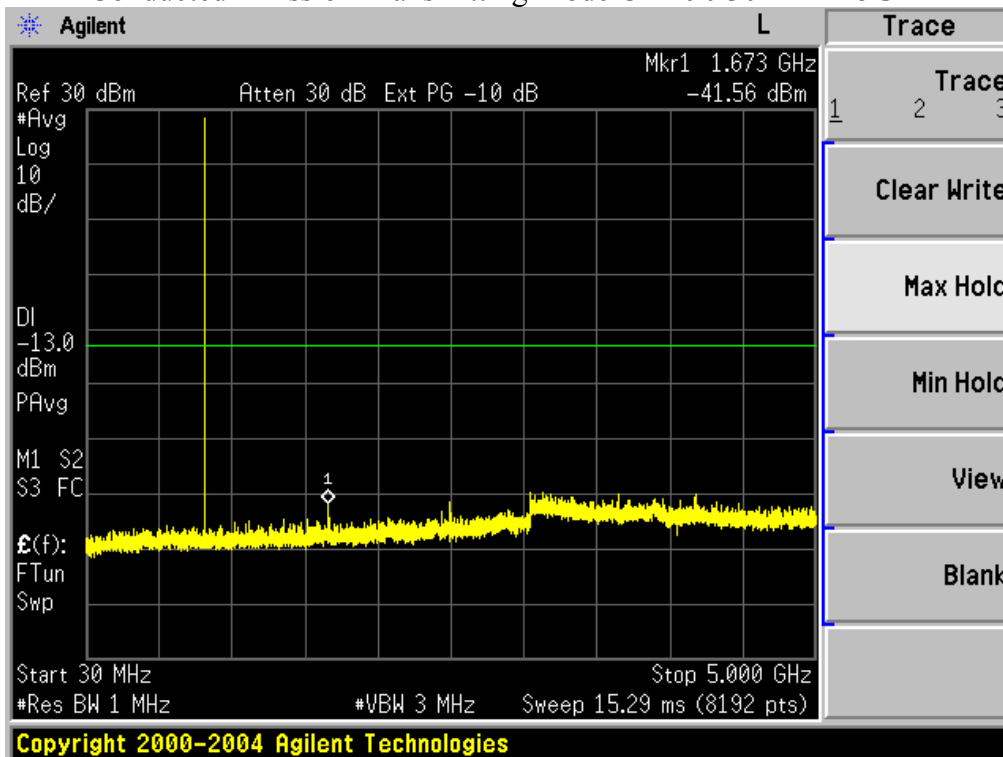

Conducted Emission Transmitting Mode CH 190 5GHz – 10GHz

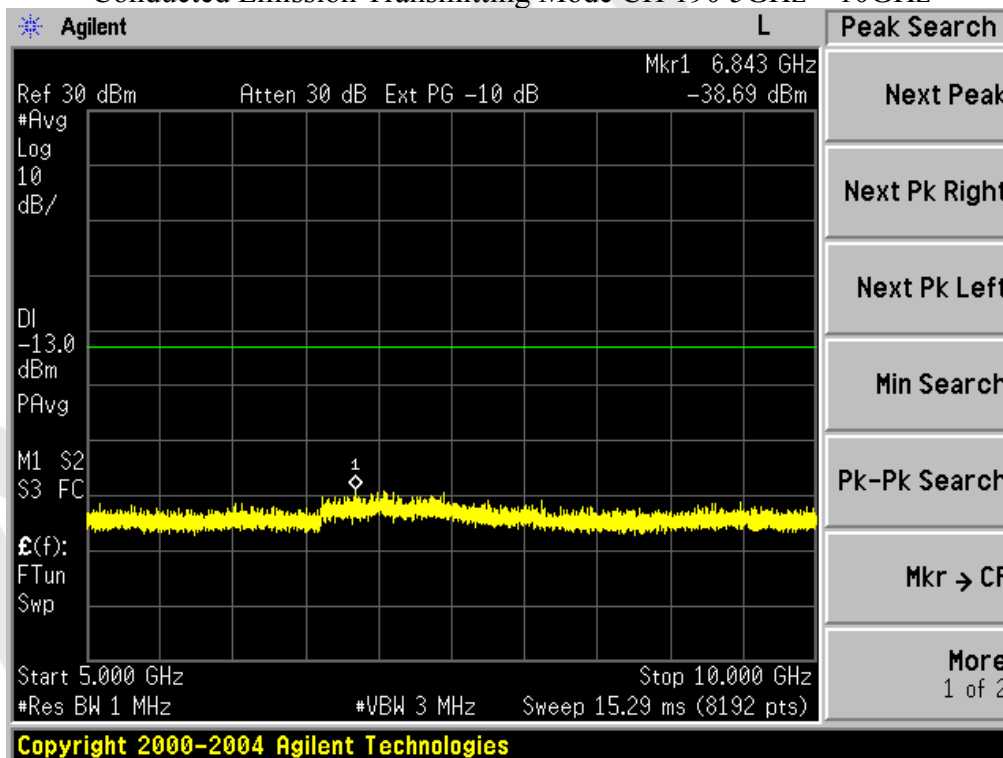

Conducted Emission Transmitting Mode CH 251 30MHz – 5GHz

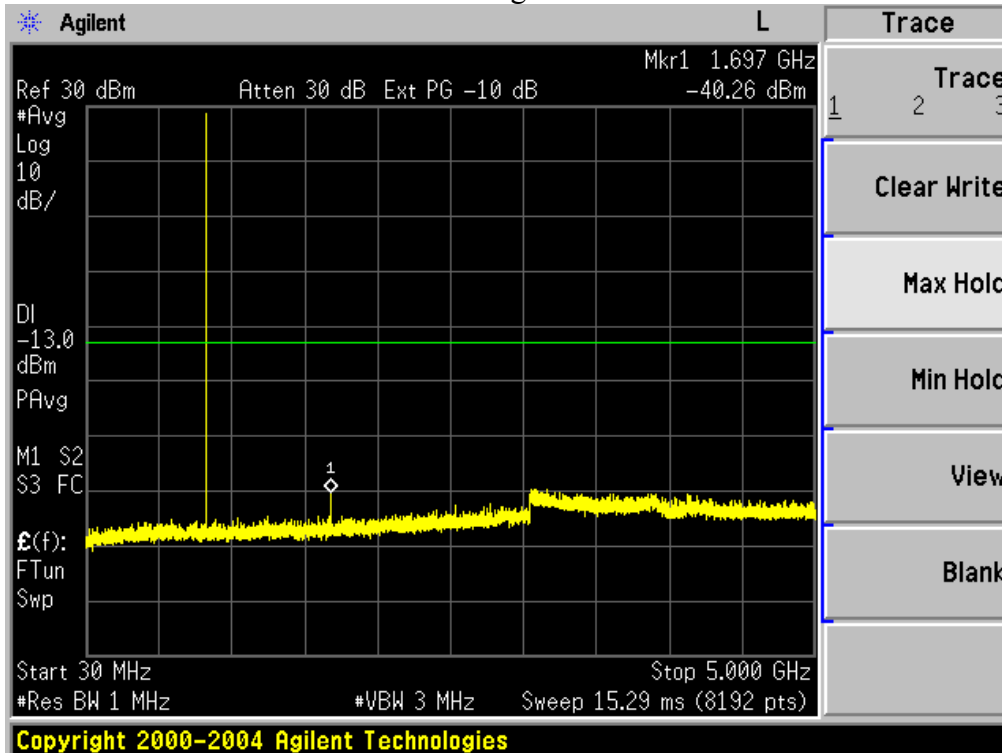

Conducted Emission Transmitting Mode CH 251 5GHz – 10GHz

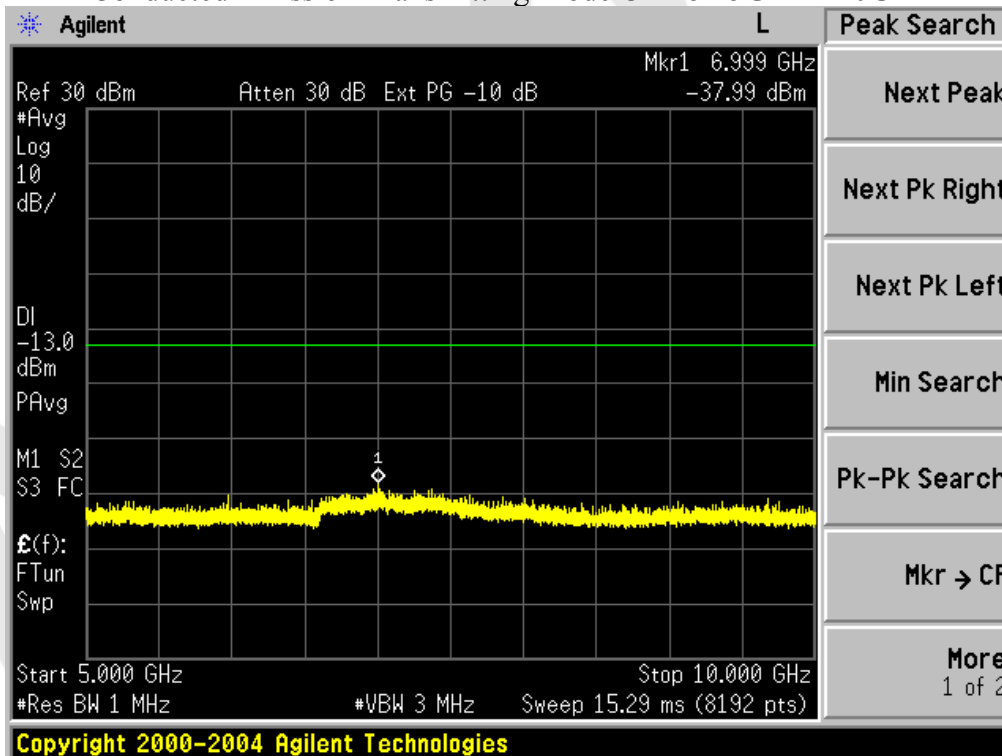

CONDUCTED EMISSION IN EGPRS1900 BAND
Conducted Emission Transmitting Mode CH 512 30MHz – 10GHz

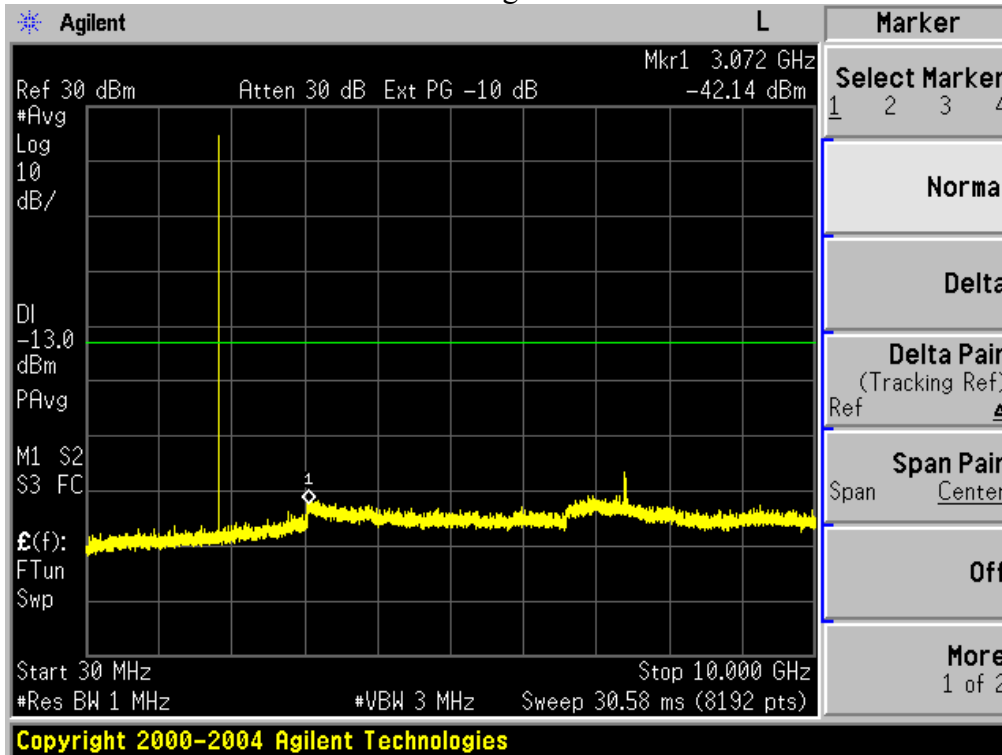

Conducted Emission Transmitting Mode CH 512 10GHz – 20GHz

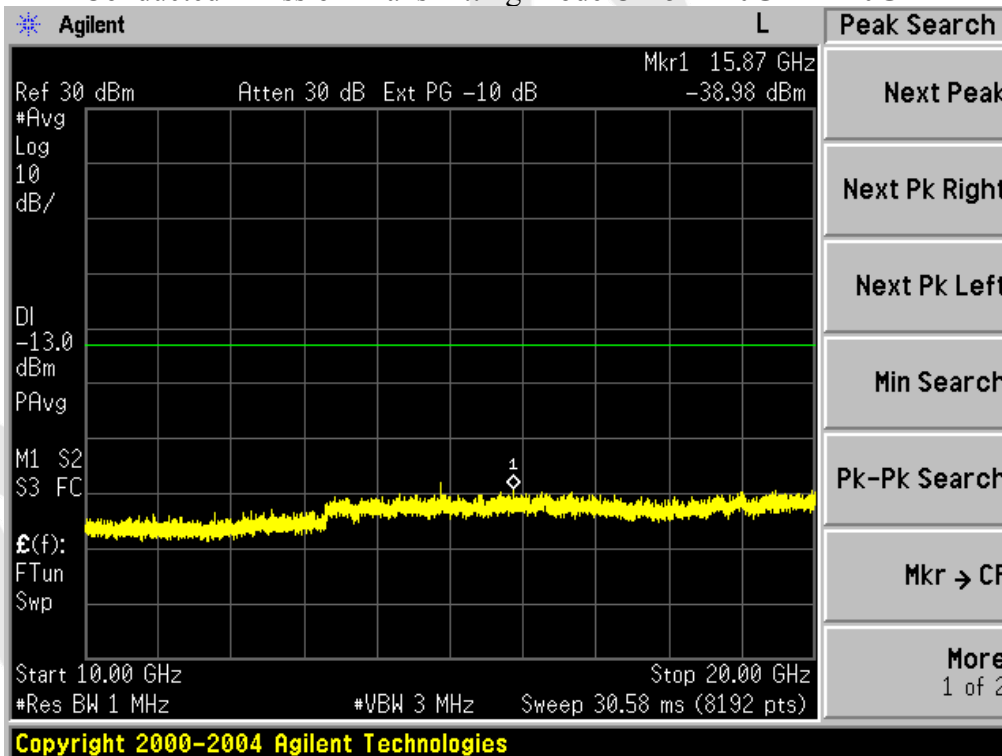

Conducted Emission Transmitting Mode CH 661 30MHz – 10GHz

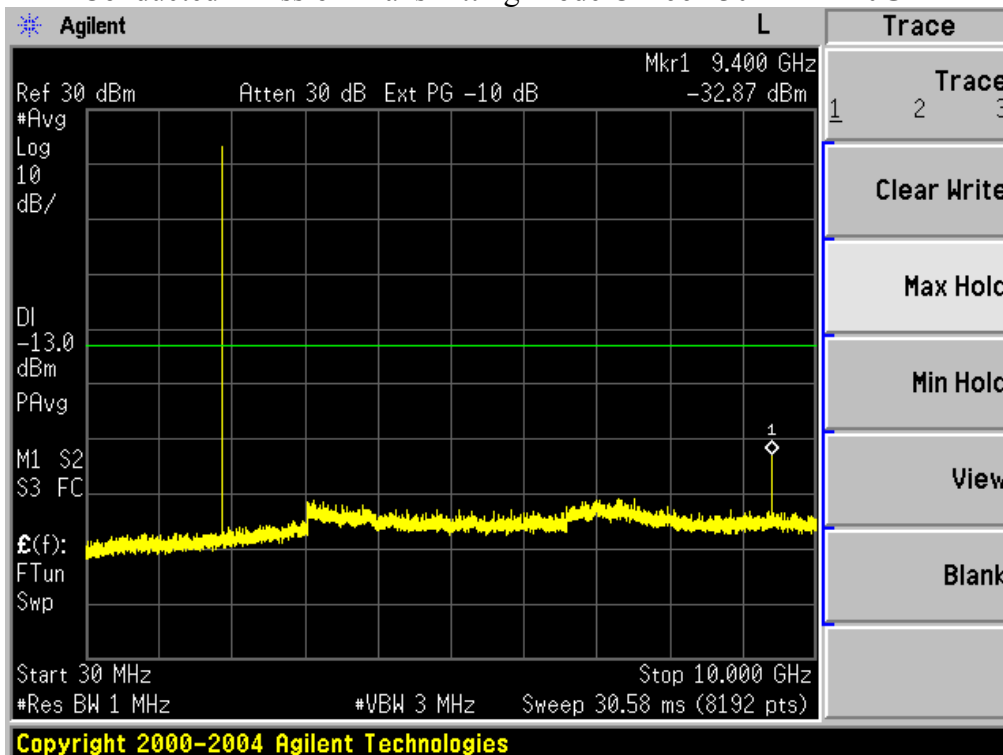

Conducted Emission Transmitting Mode CH 661 10GHz – 20GHz

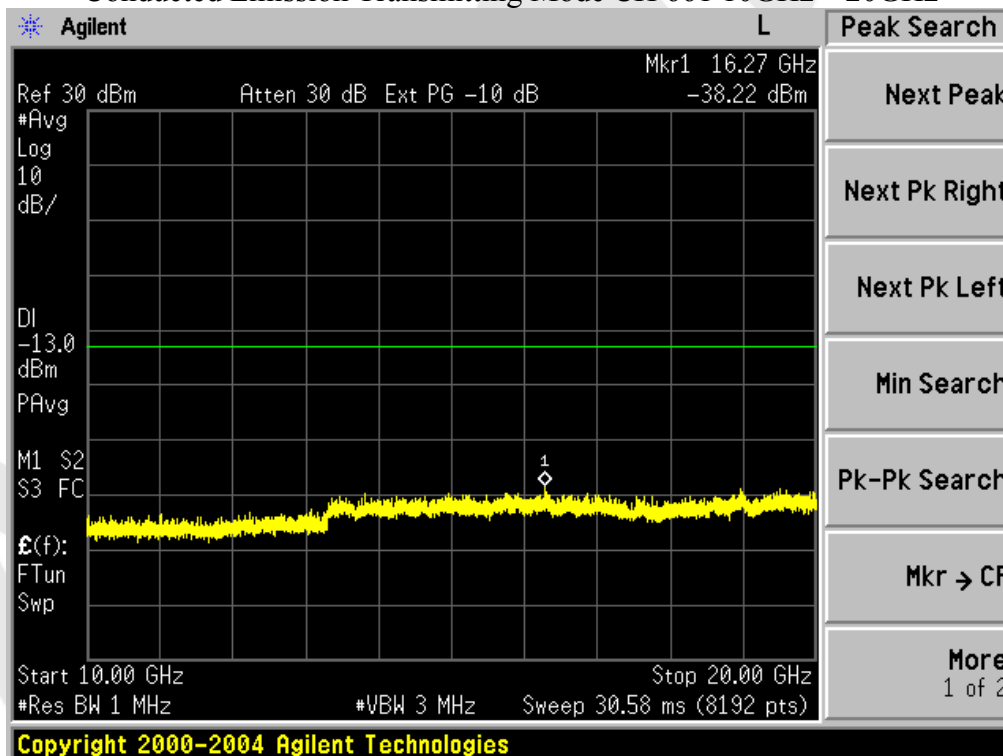

Conducted Emission Transmitting Mode CH 810 30MHz – 10GHz

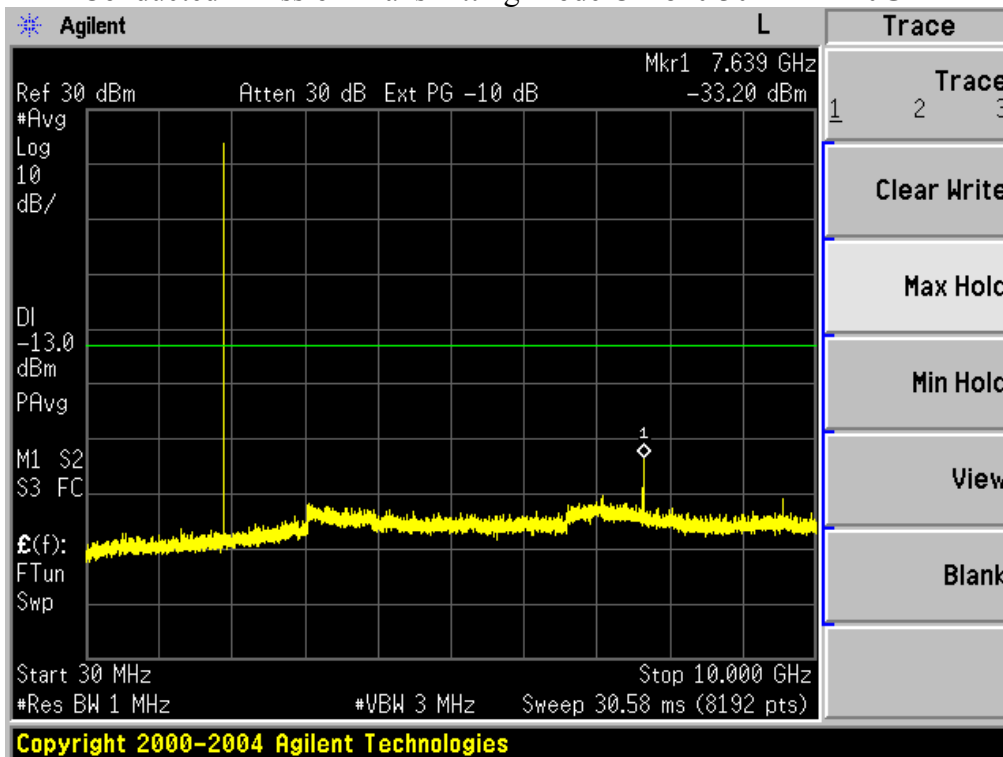

Conducted Emission Transmitting Mode CH 810 10GHz – 20GHz

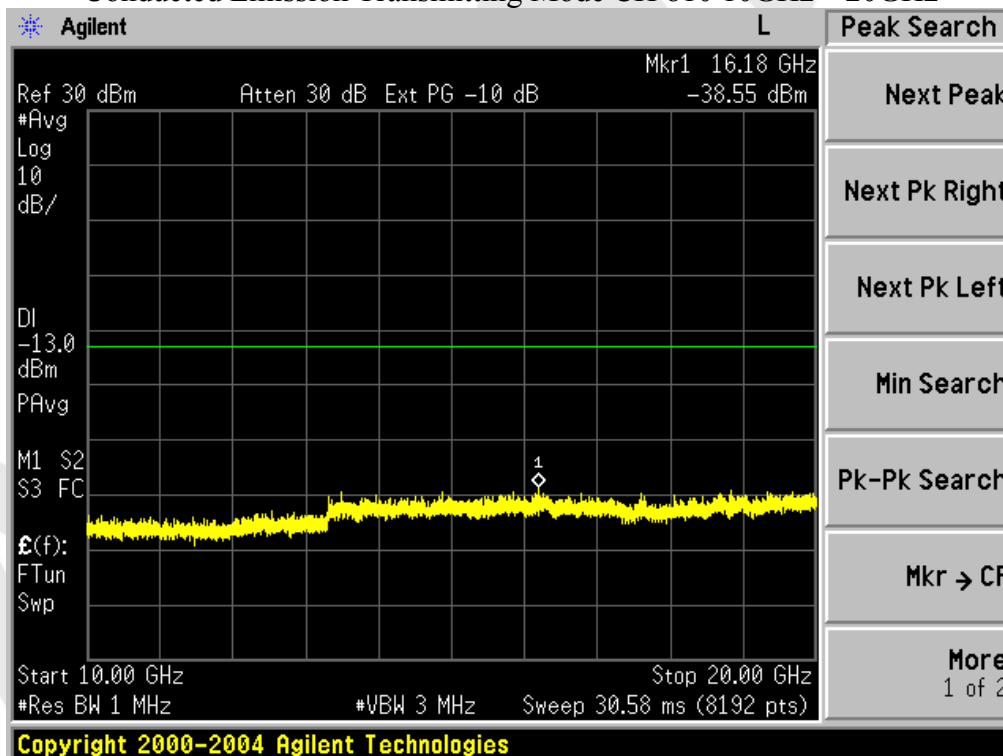

CONDUCTED EMISSION IN UMTS band II
Conducted Emission Transmitting Mode CH 9262 30MHz – 10GHz

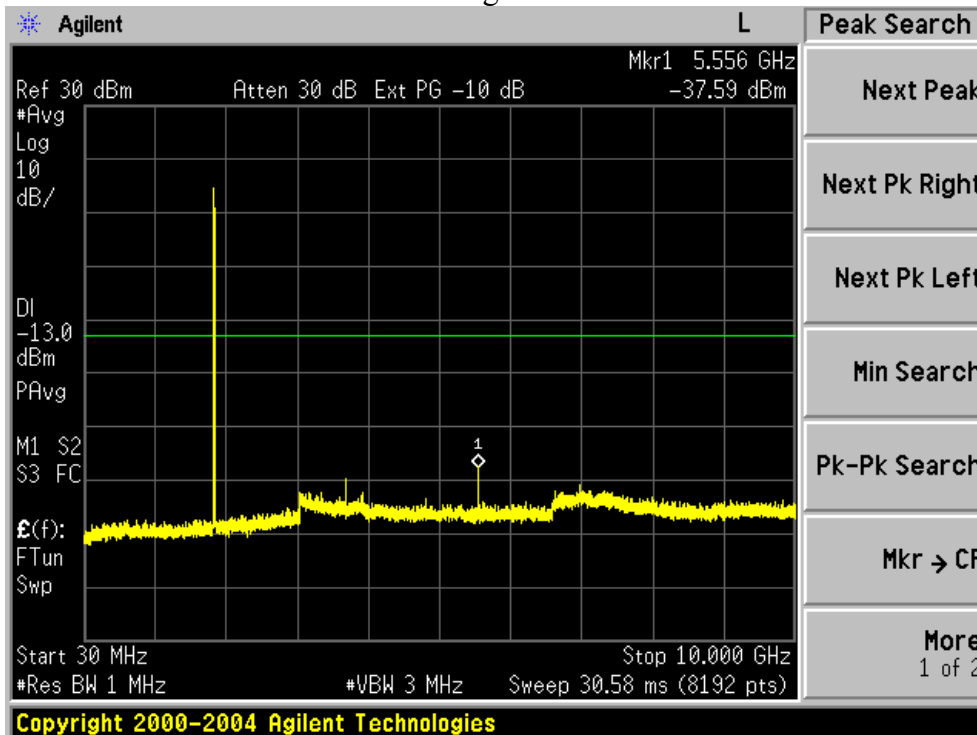

Conducted Emission Transmitting Mode CH 9262 10GHz – 20GHz

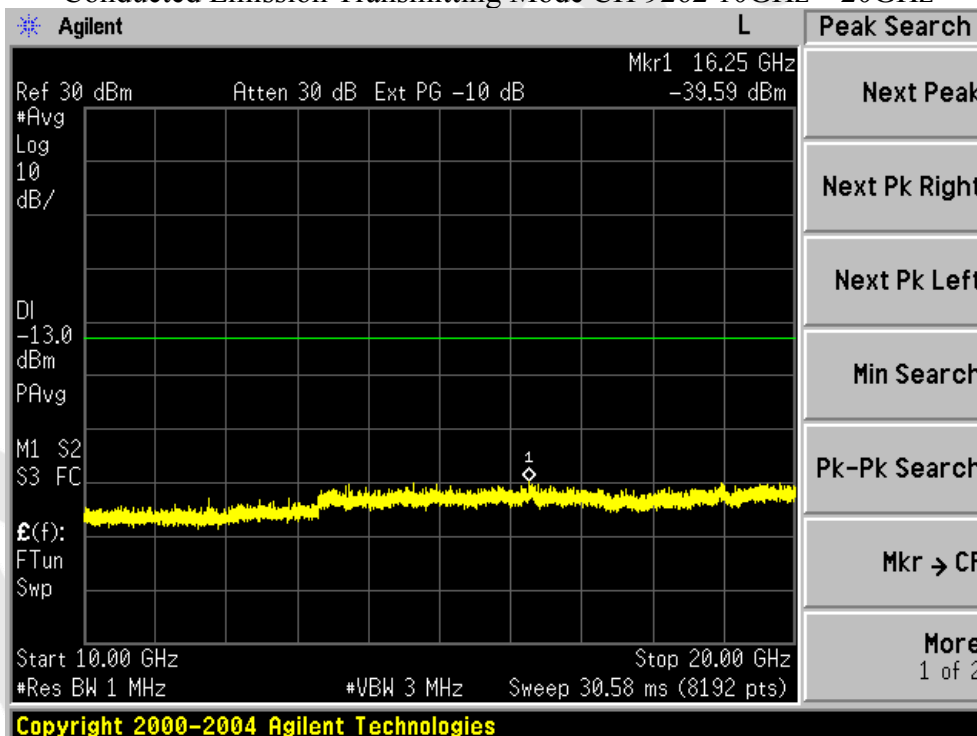

Conducted Emission Transmitting Mode CH 9400 30MHz – 10GHz

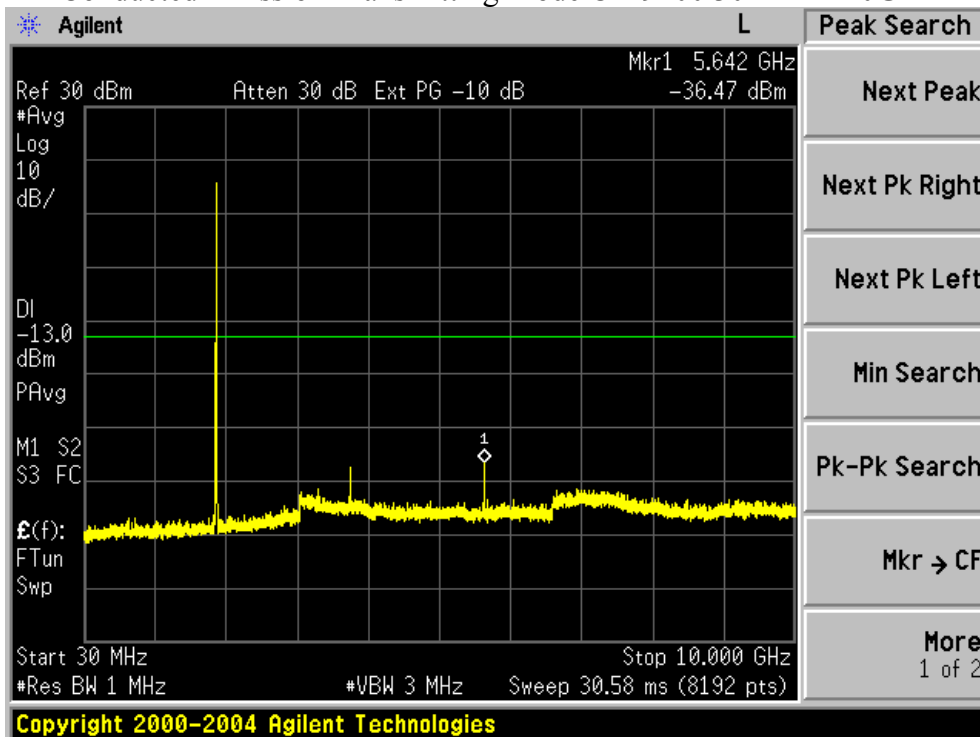

Conducted Emission Transmitting Mode CH 9400 10GHz – 20GHz

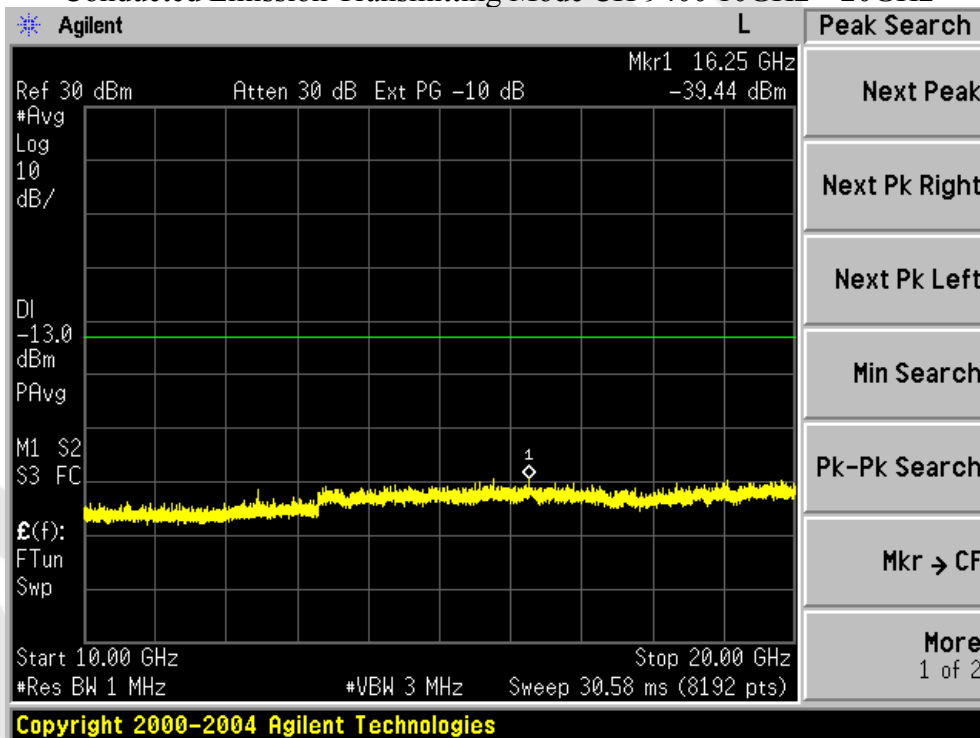

Conducted Emission Transmitting Mode CH 9538 30MHz – 10GHz

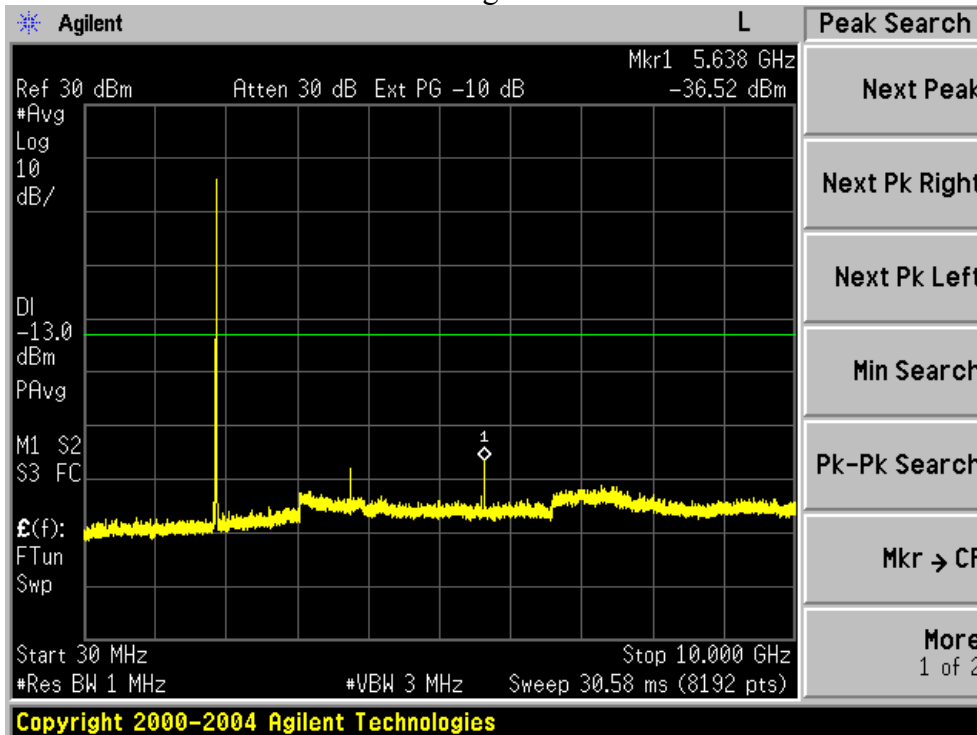

Conducted Emission Transmitting Mode CH 9538 10GHz – 20GHz

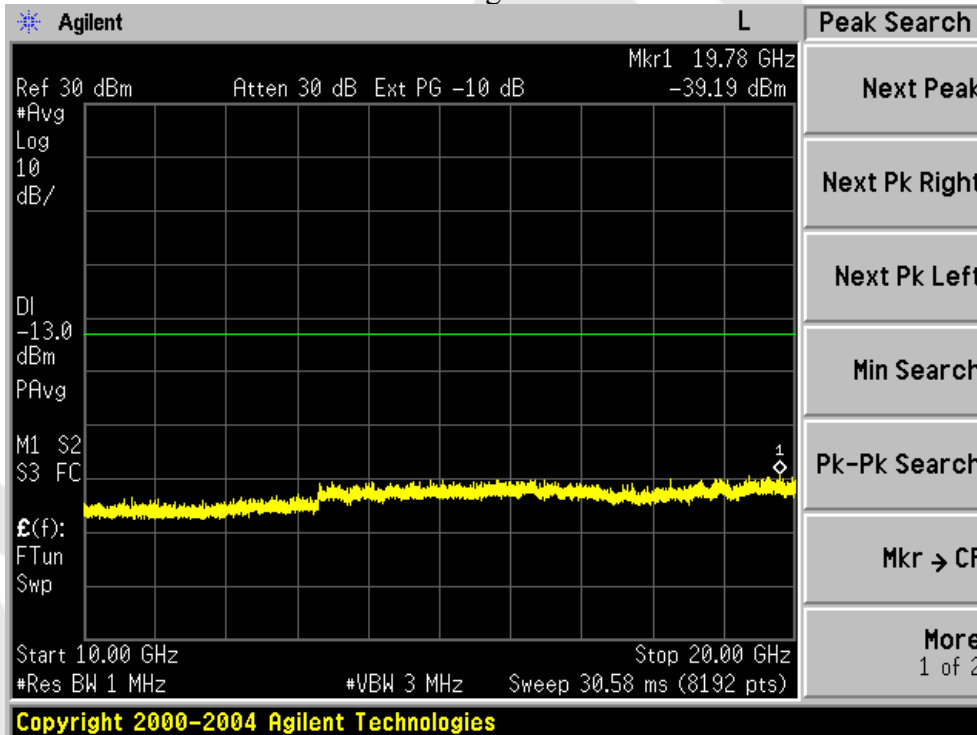

CONDUCTED EMISSION IN UMTS band V
Conducted Emission Transmitting Mode CH 4132 30MHz – 10GHz

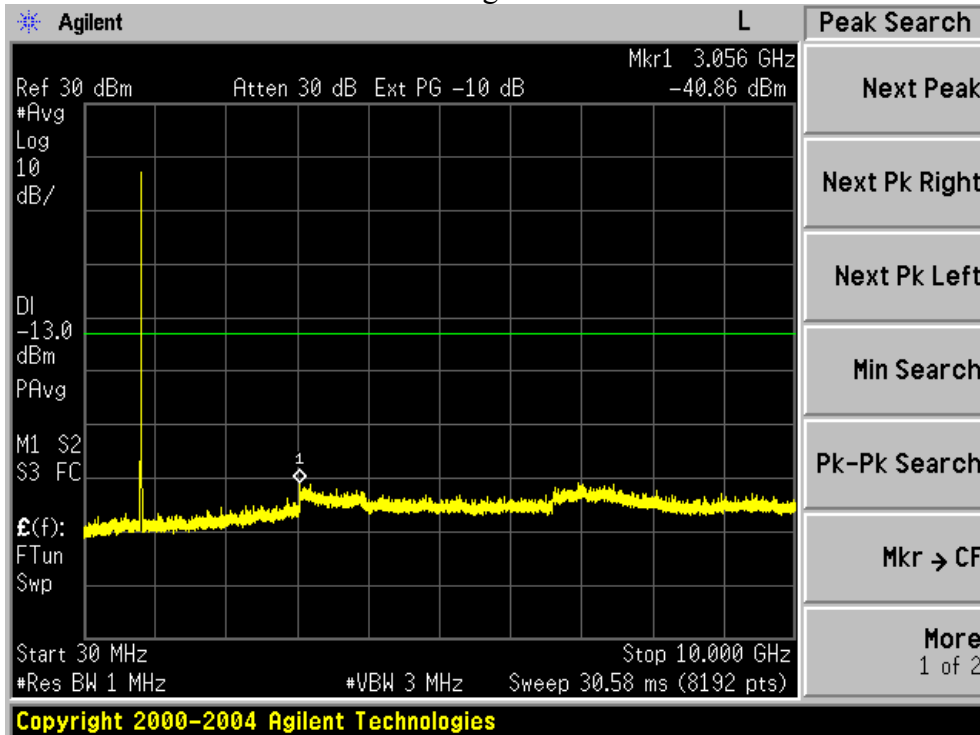

Conducted Emission Transmitting Mode CH 4132 10GHz – 20GHz

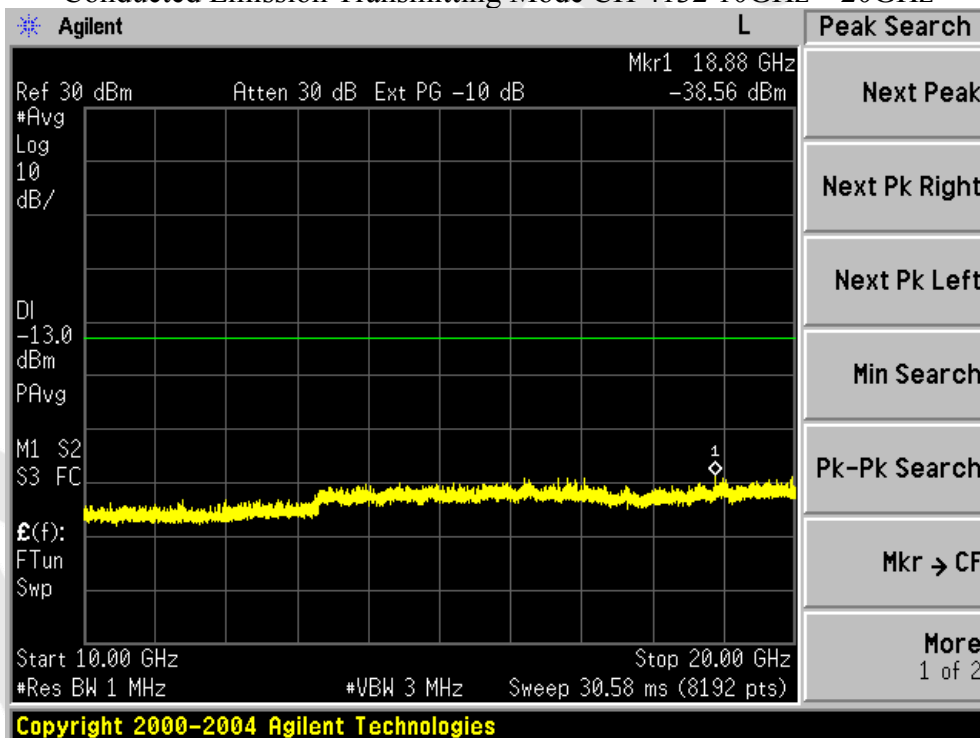

Conducted Emission Transmitting Mode CH 4183 30MHz –10GHz

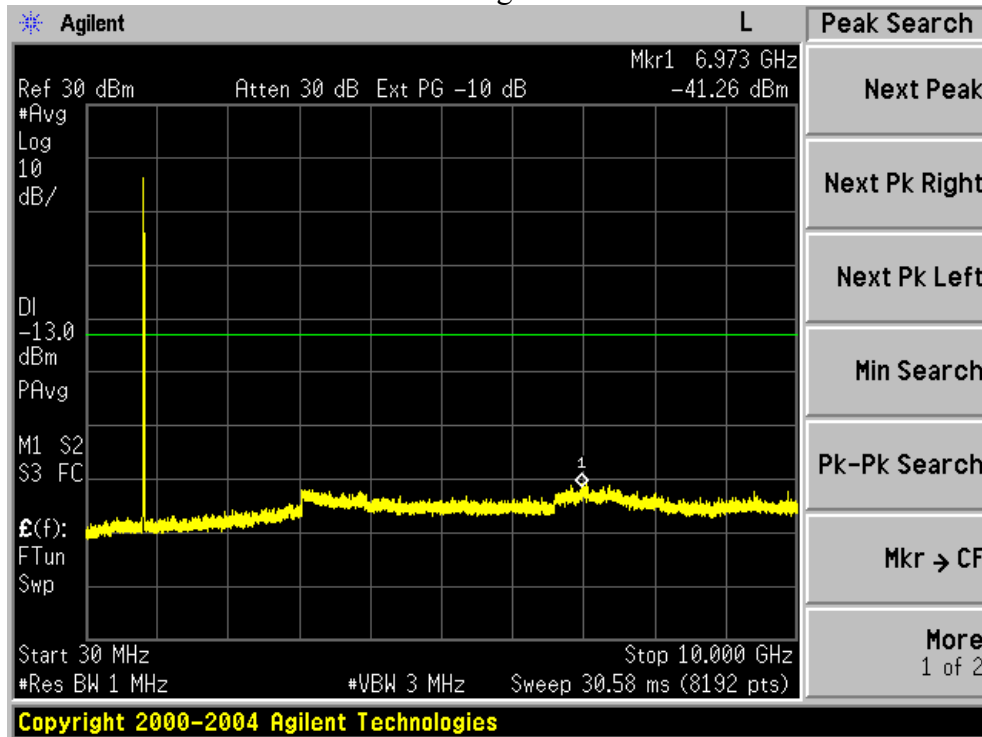

Conducted Emission Transmitting Mode CH 4183 10GHz – 20GHz

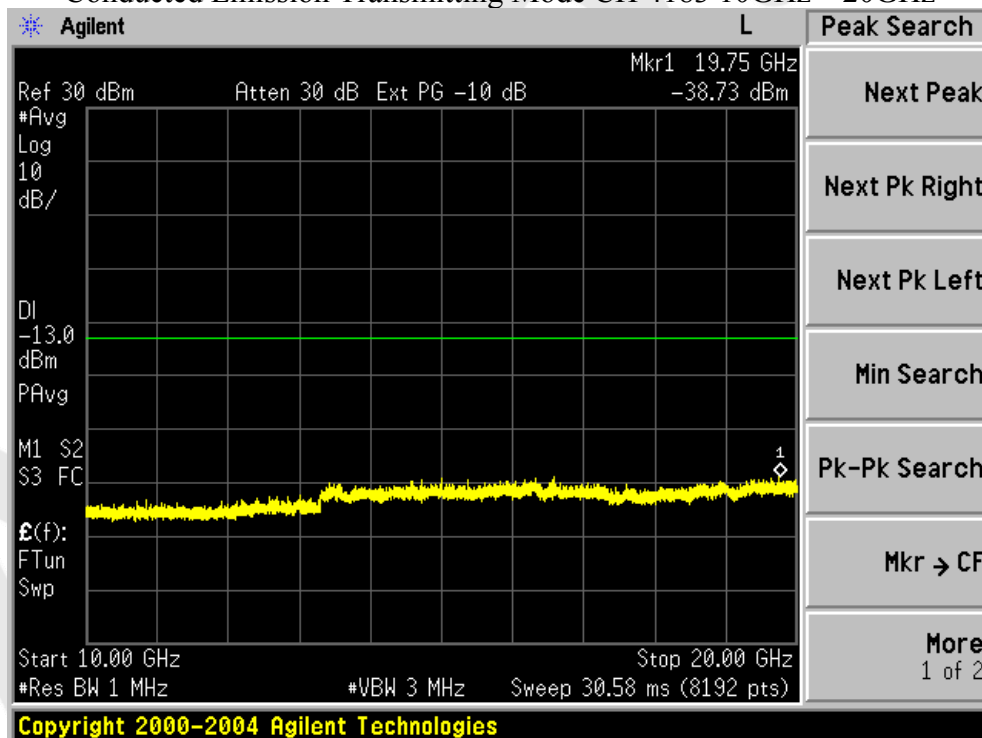

Conducted Emission Transmitting Mode CH 4233 30MHz – 10GHz

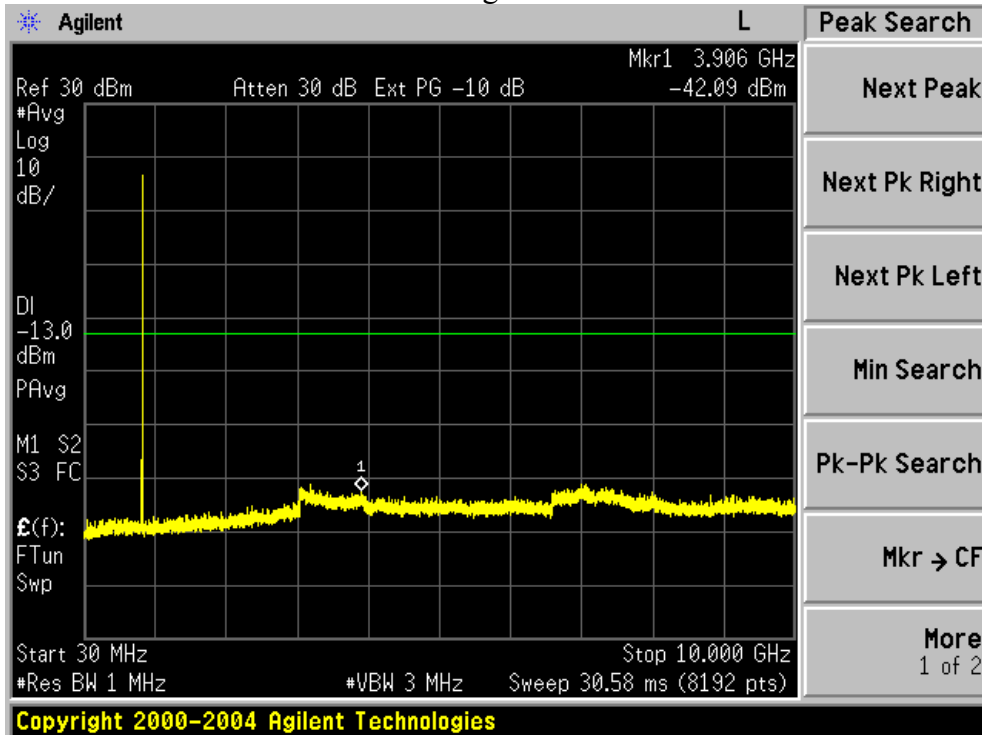

Conducted Emission Transmitting Mode CH 4233 10GHz – 20GHz

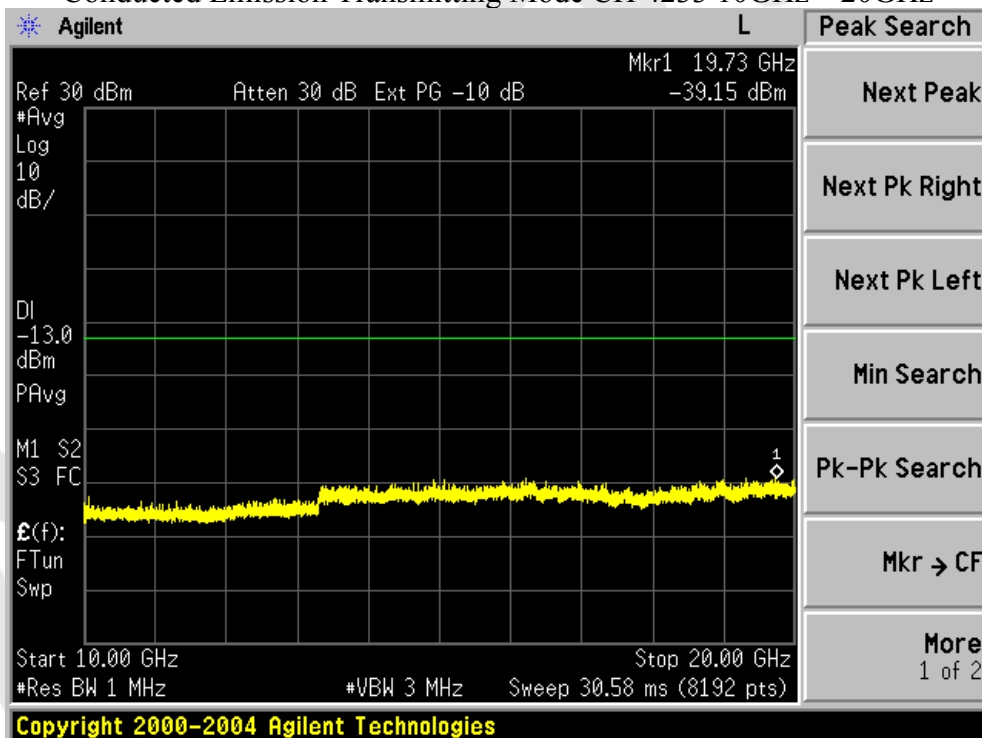

APPENDIX II

TEST PLOTS FOR OCCUPIED BANDWIDTH (99%) EMISSION BANDWIDTH (-26dB)

Occupied Bandwidth (99%) GSM 850 BAND CH 128

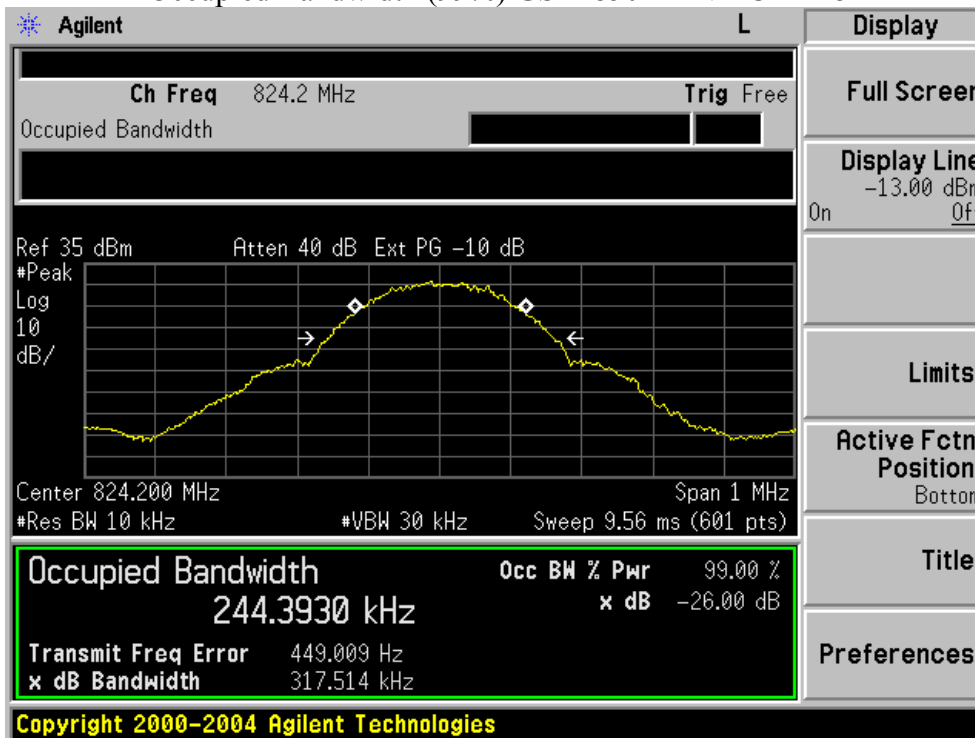

Occupied Bandwidth (99%) GSM 850 BAND CH 190

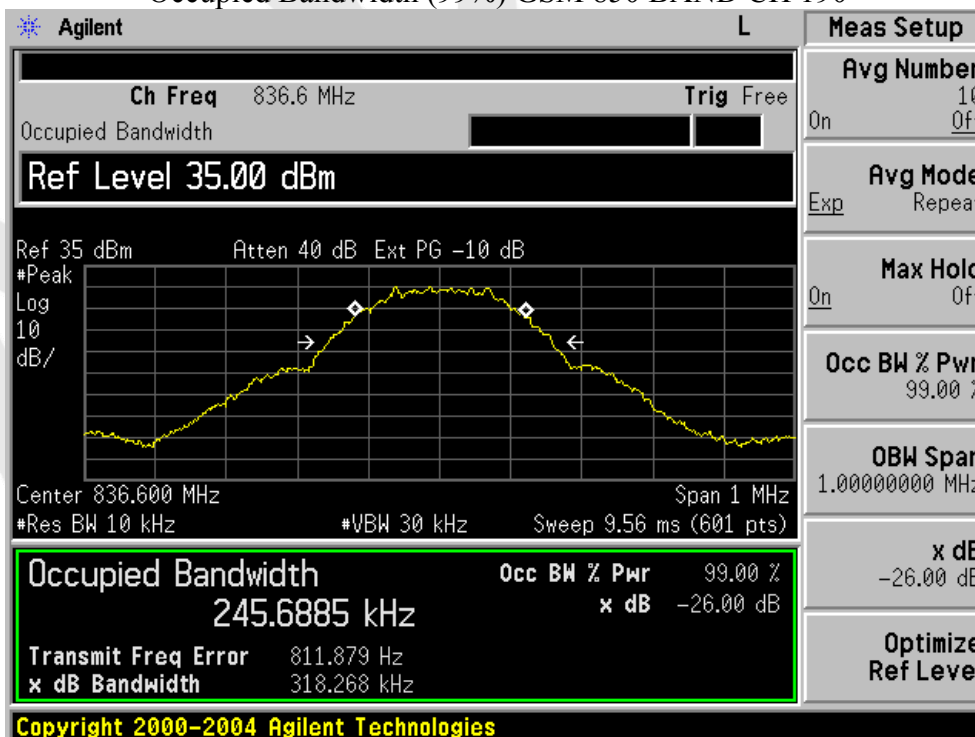

Occupied Bandwidth (99%) GSM 850 BAND CH 251

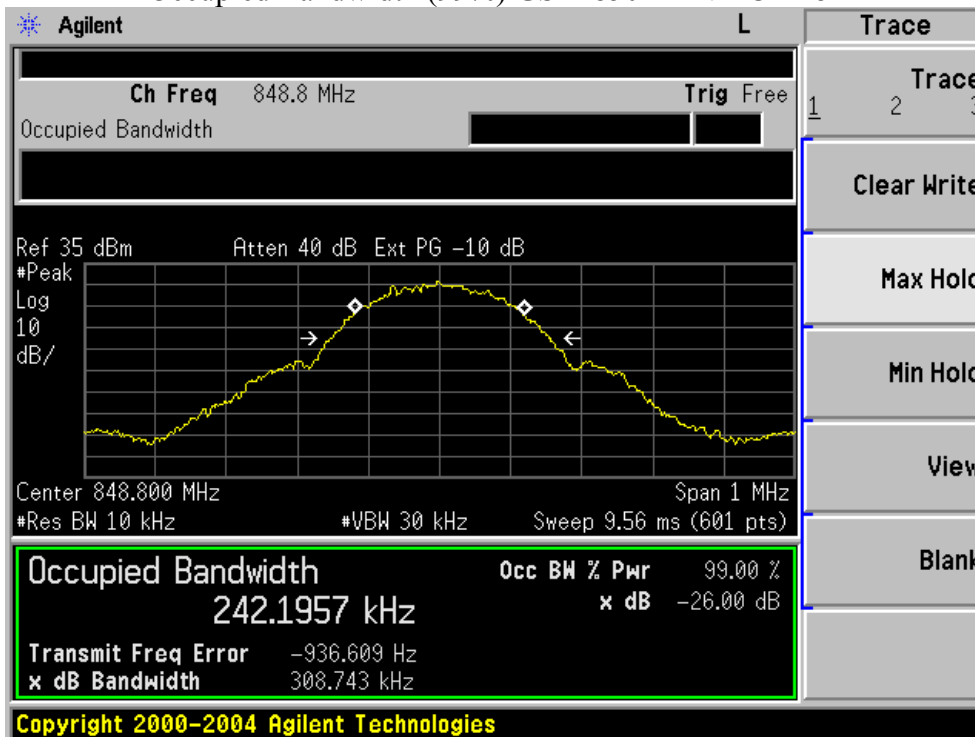

Occupied Bandwidth (99%) PCS 1900 BAND CH 512

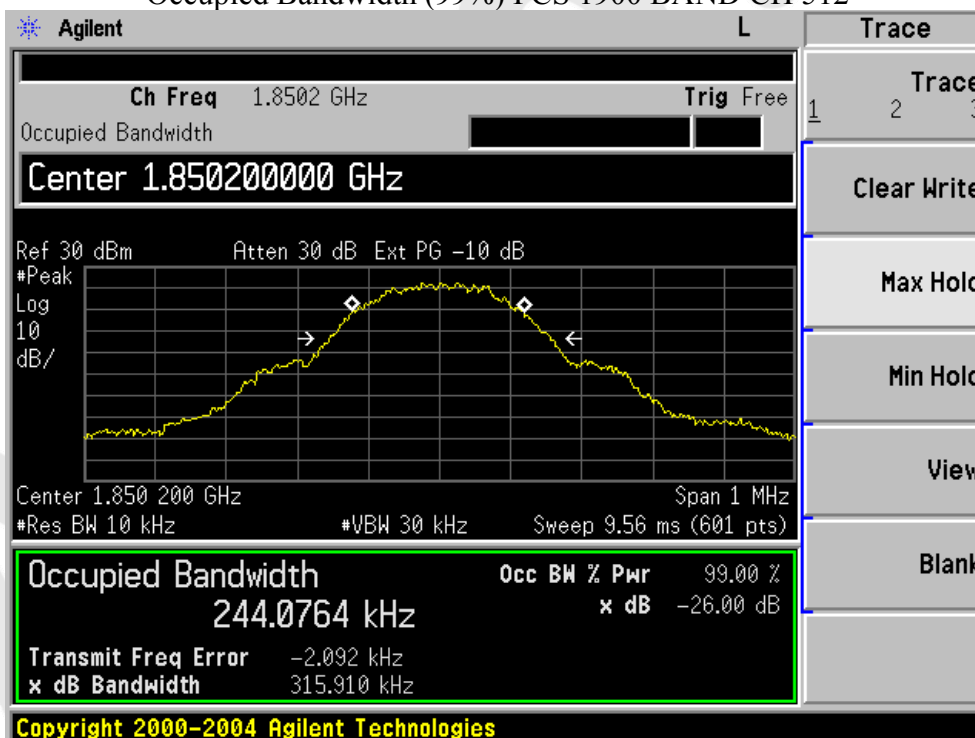

Occupied Bandwidth (99%) PCS 1900 BAND CH 661

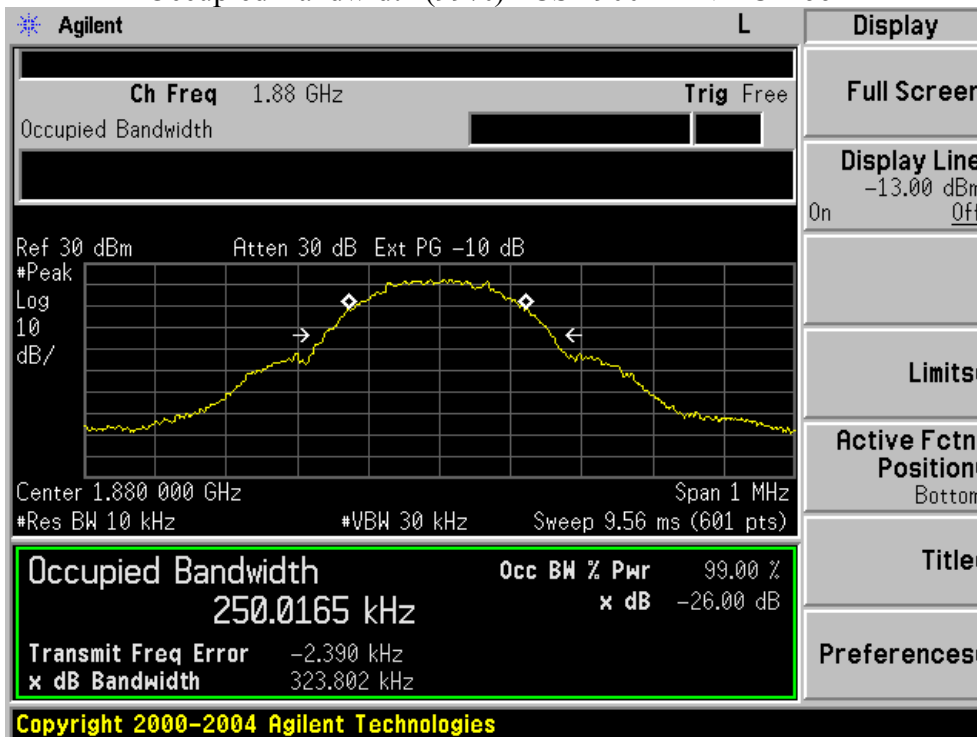

Occupied Bandwidth (99%) PCS 1900 BAND CH 810

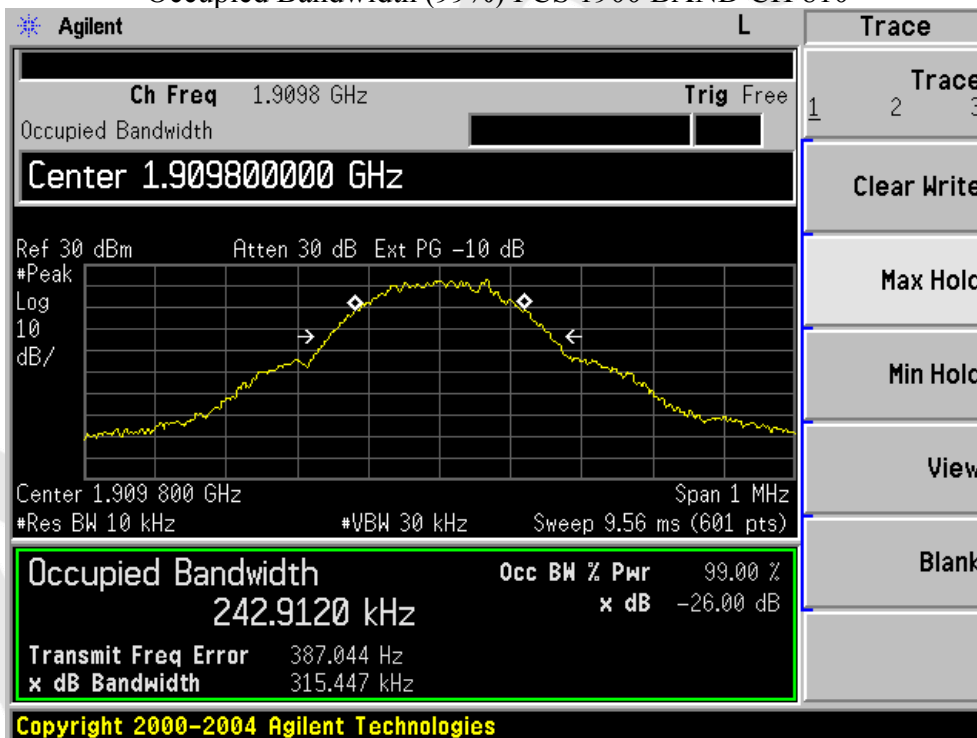

Occupied Bandwidth (99%) GPRS 850 BAND CH 128

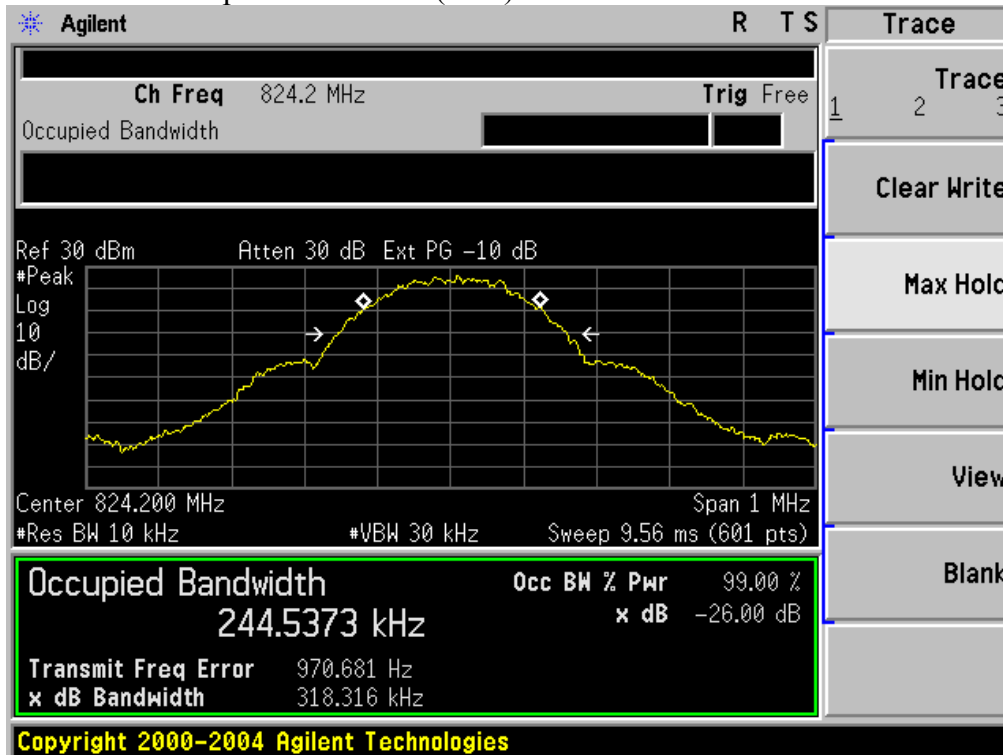

Occupied Bandwidth (99%) GPRS 850 BAND CH 190

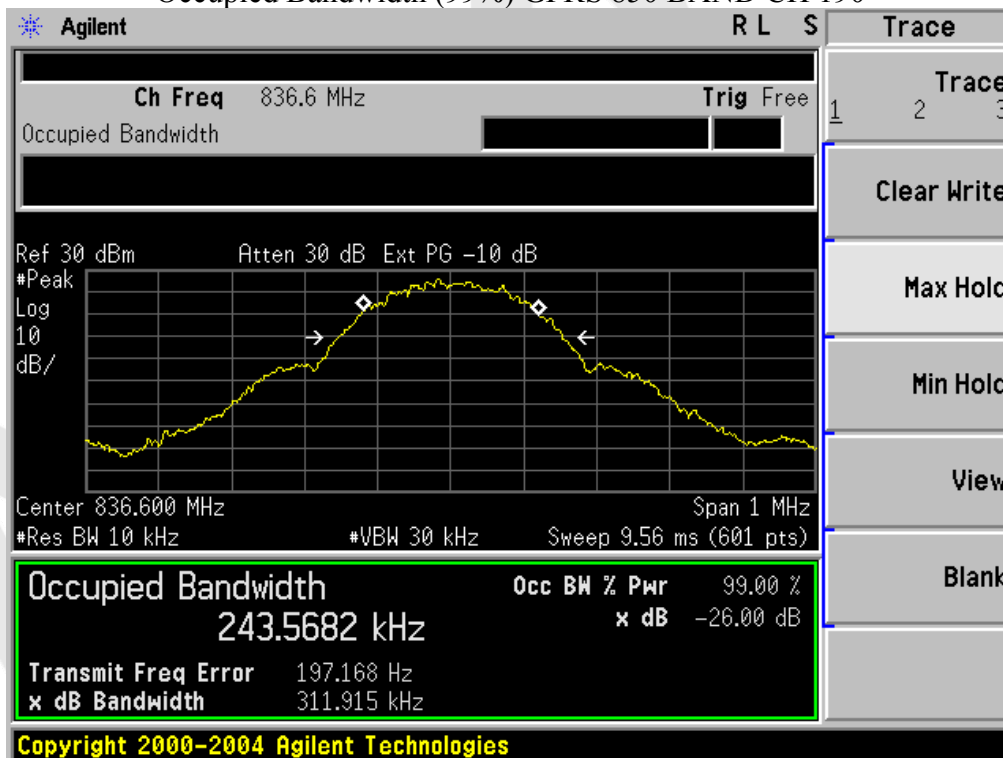

Occupied Bandwidth (99%) GPRS 850 BAND CH 251

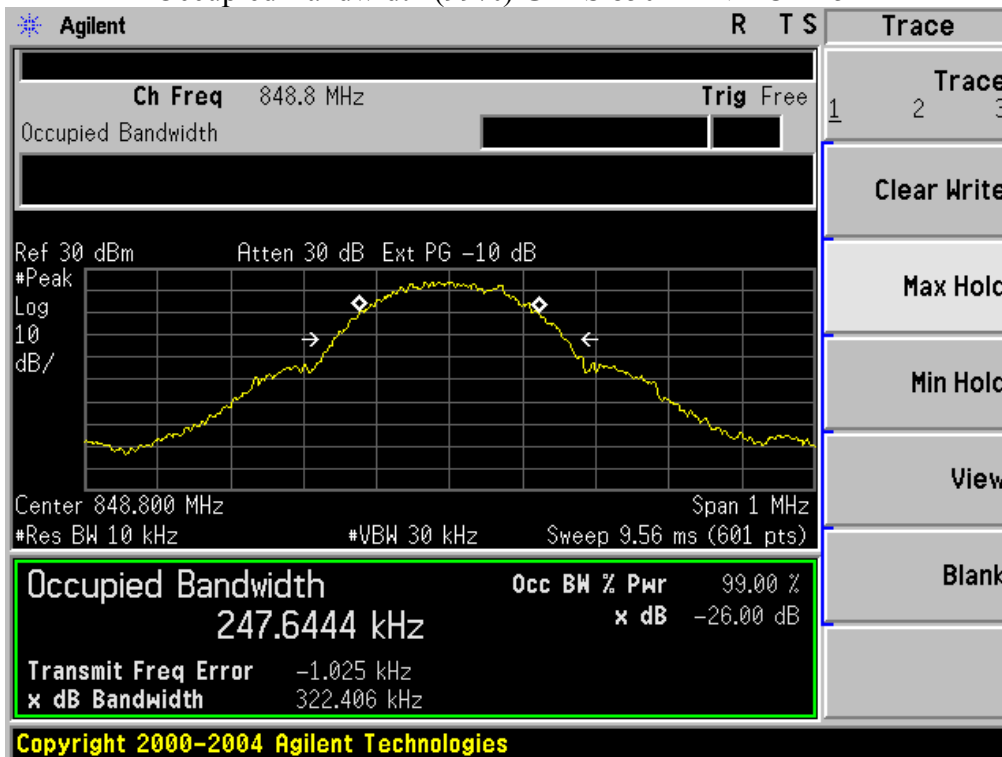

Occupied Bandwidth (99%) GPRS 1900 BAND CH 512

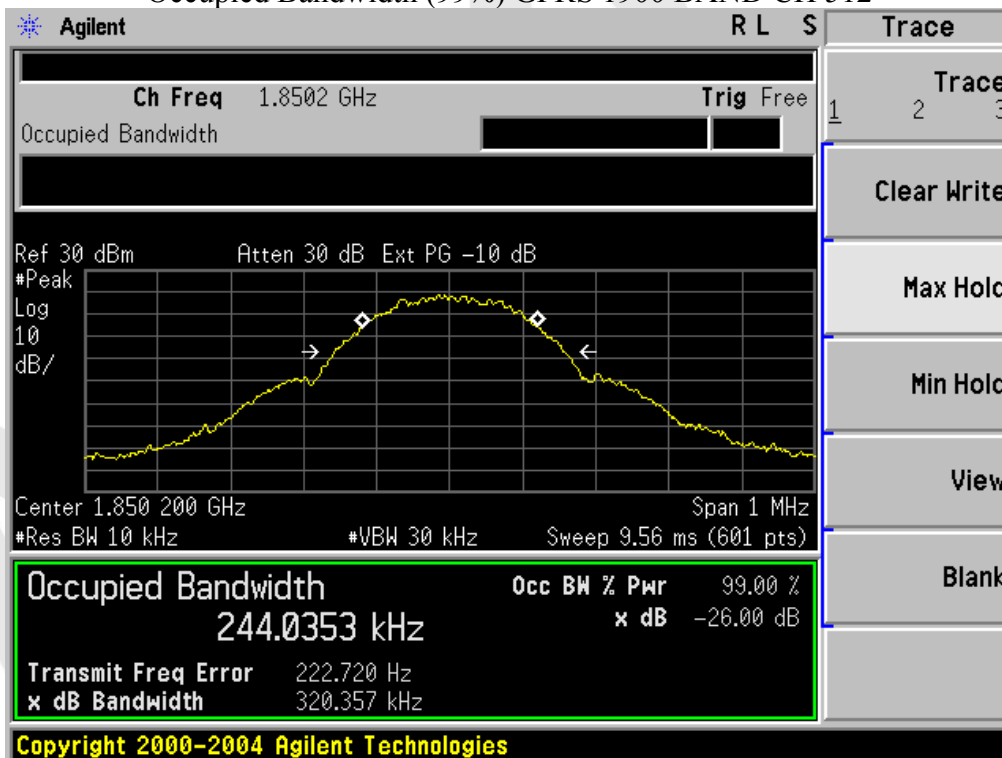

Occupied Bandwidth (99%) GPRS 1900 BAND CH 661

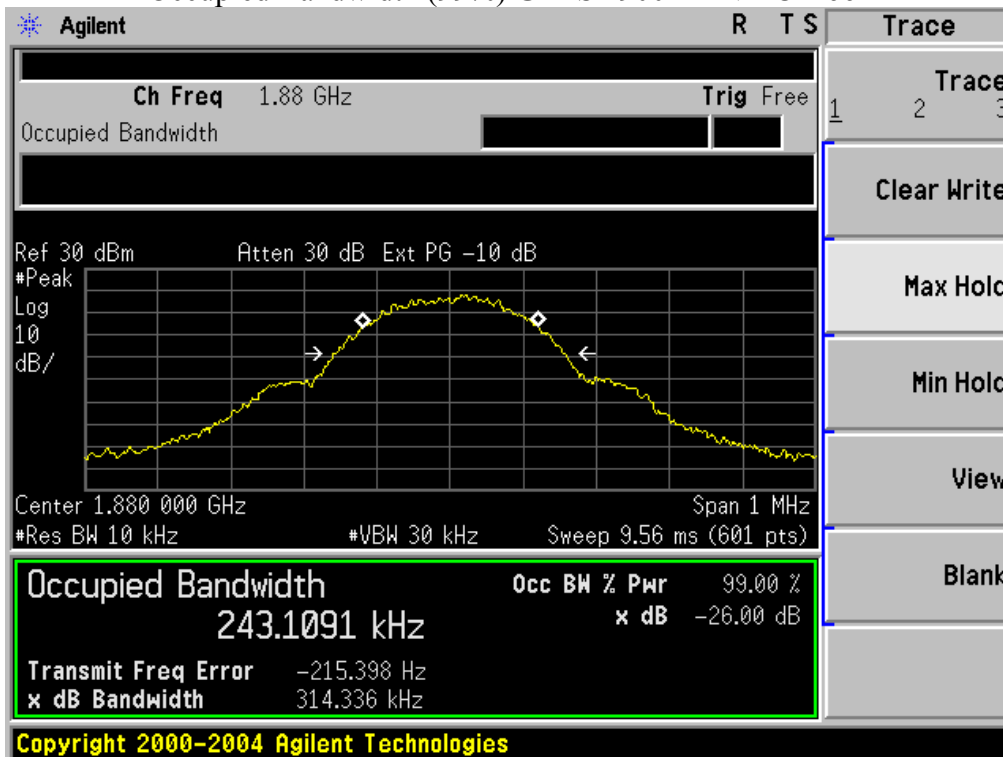

Occupied Bandwidth (99%) GPRS 1900 BAND CH 810

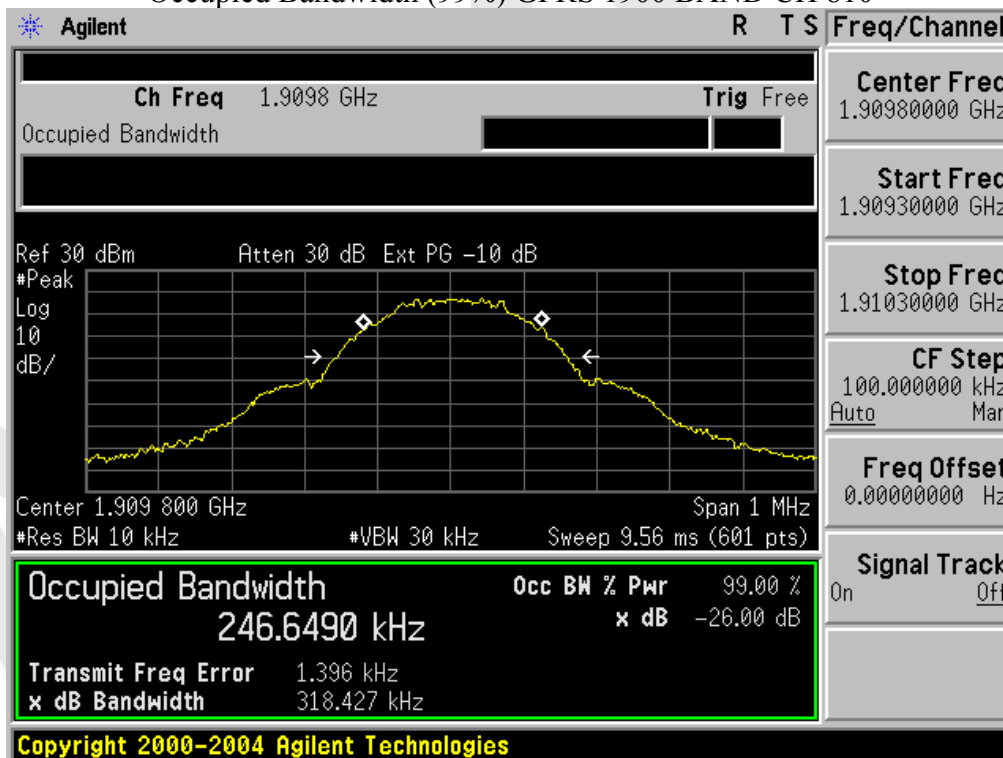

Occupied Bandwidth (99%) EGPRS 850 BAND CH 128

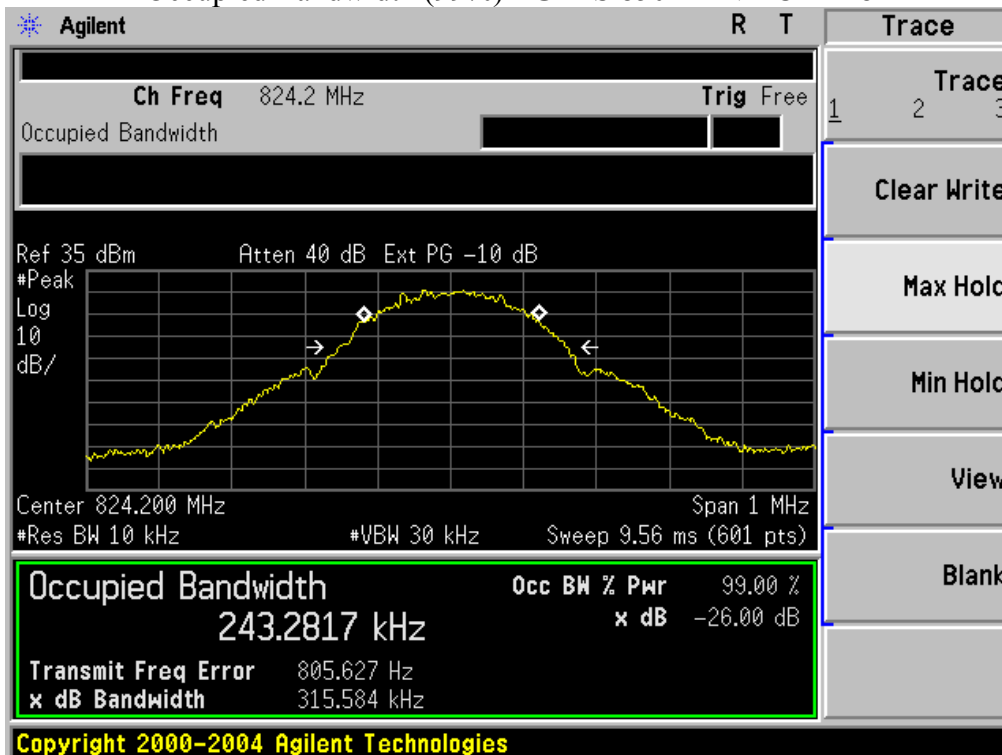

Occupied Bandwidth (99%) EGPRS 850 BAND CH 190

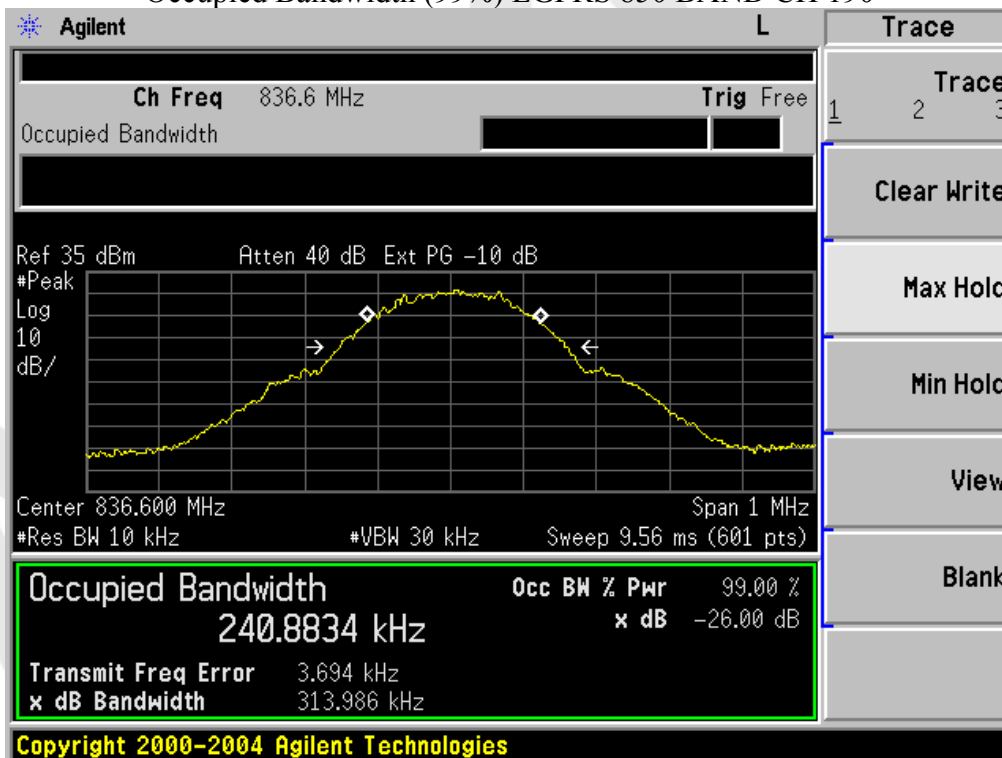

Occupied Bandwidth (99%) EGPRS 850 BAND CH 251

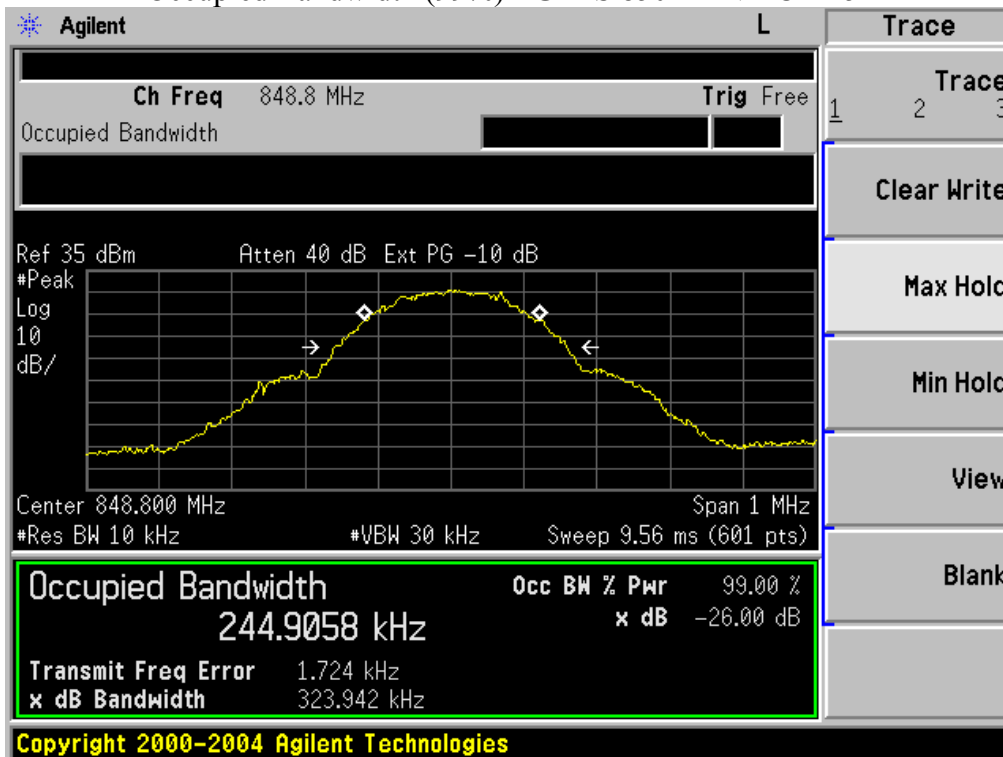

Occupied Bandwidth (99%) EGPRS 1900 BAND CH 512

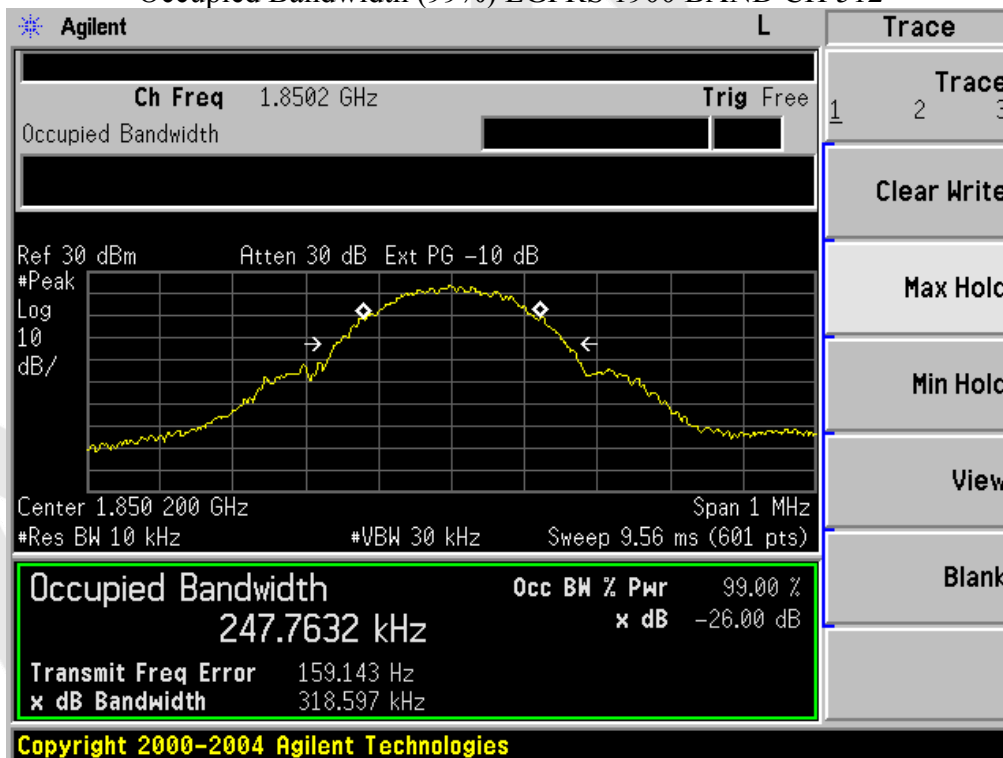

Occupied Bandwidth (99%) EGPRS 1900 BAND CH 661

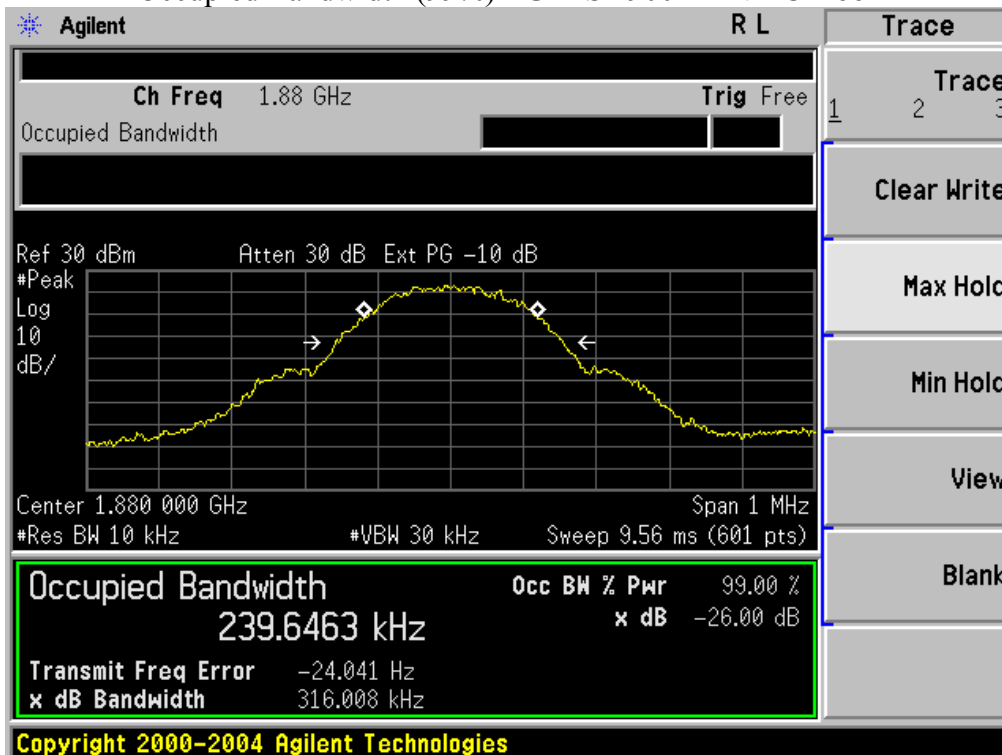

Occupied Bandwidth (99%) EGPRS 1900 BAND CH 810

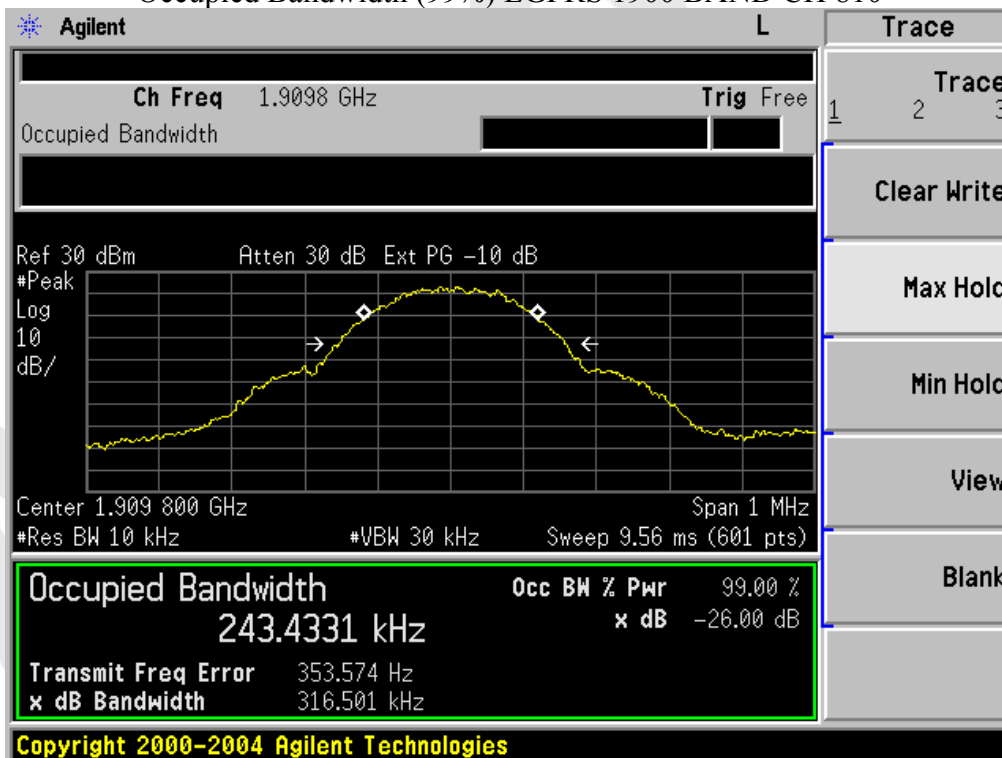

Occupied Bandwidth (99%) UMTS band II CH 9262

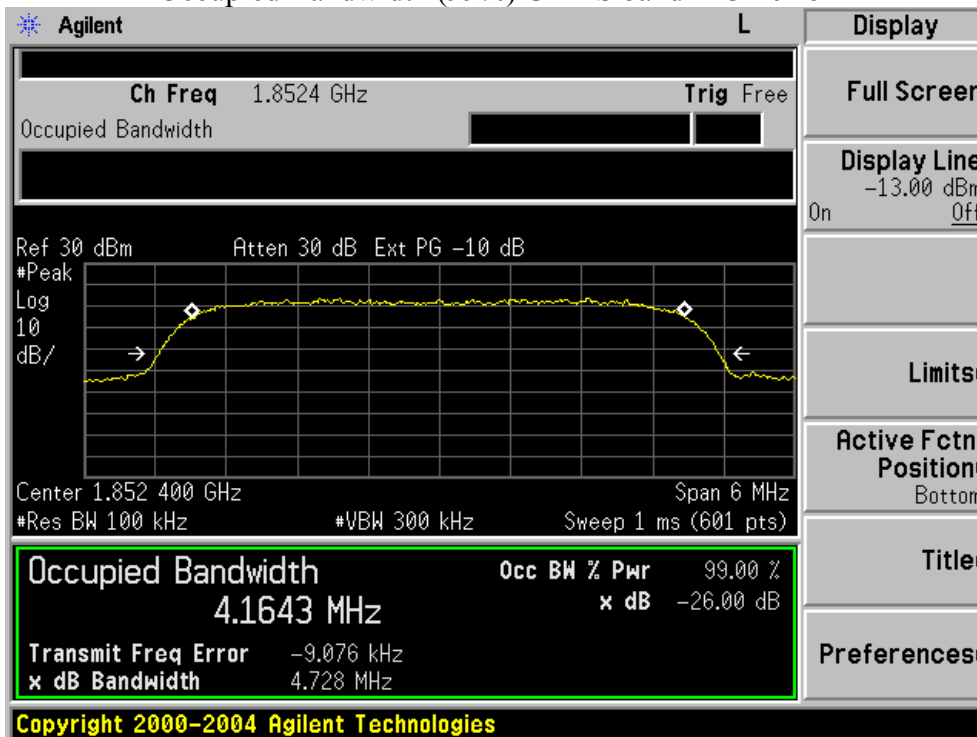

Occupied Bandwidth (99%) UMTS band II CH 9400

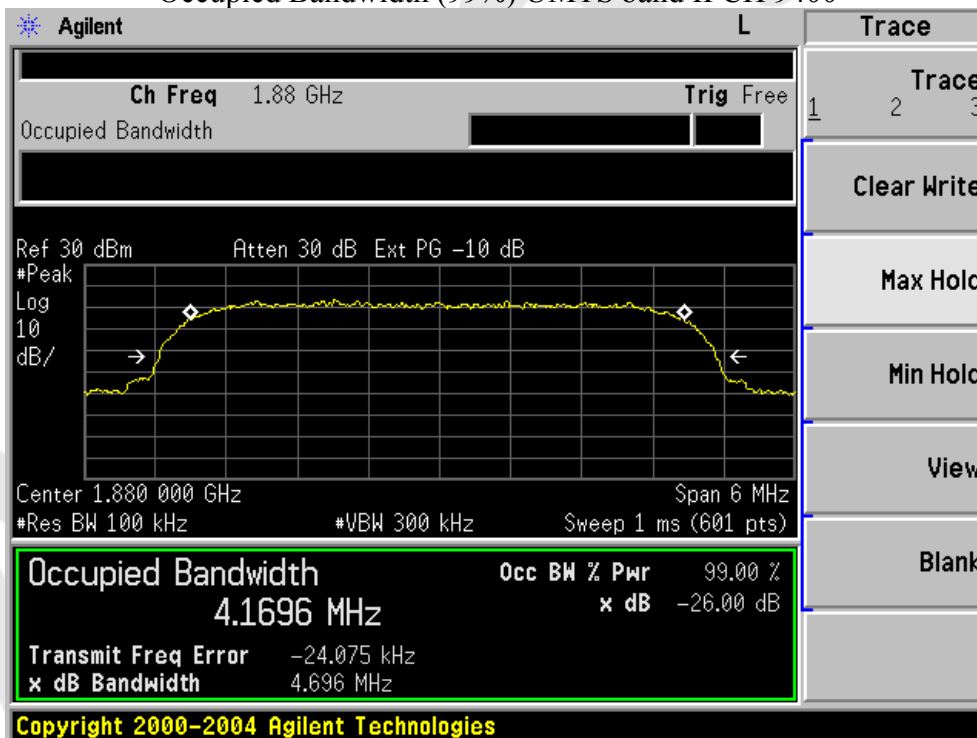

Occupied Bandwidth (99%) UMTS band II CH 9538

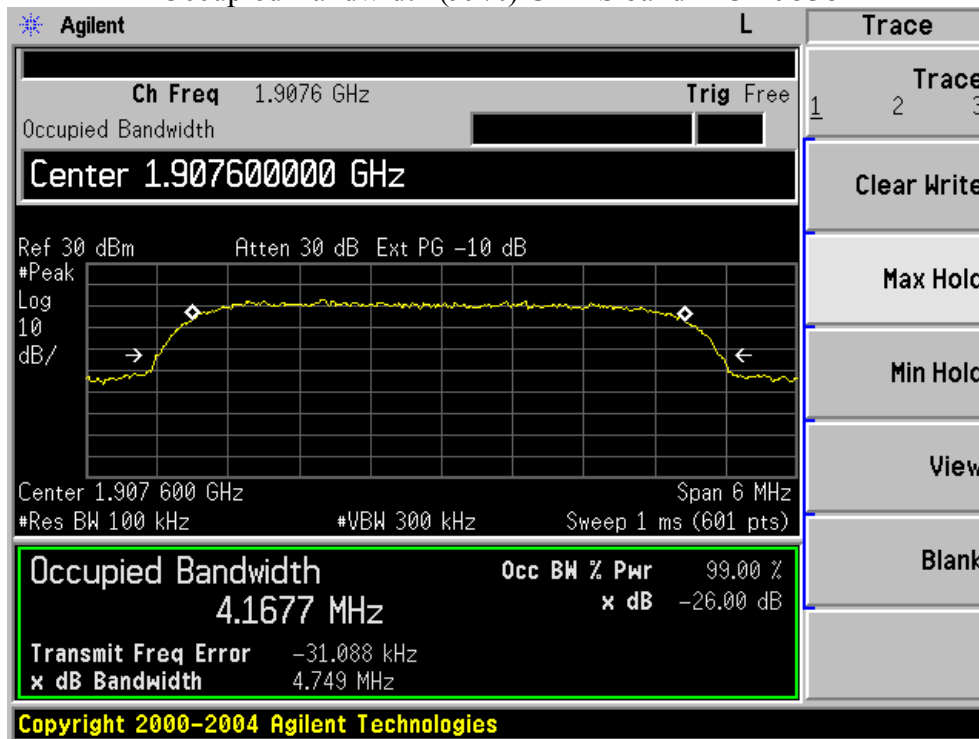

Occupied Bandwidth (99%) UMTS band V CH 4132

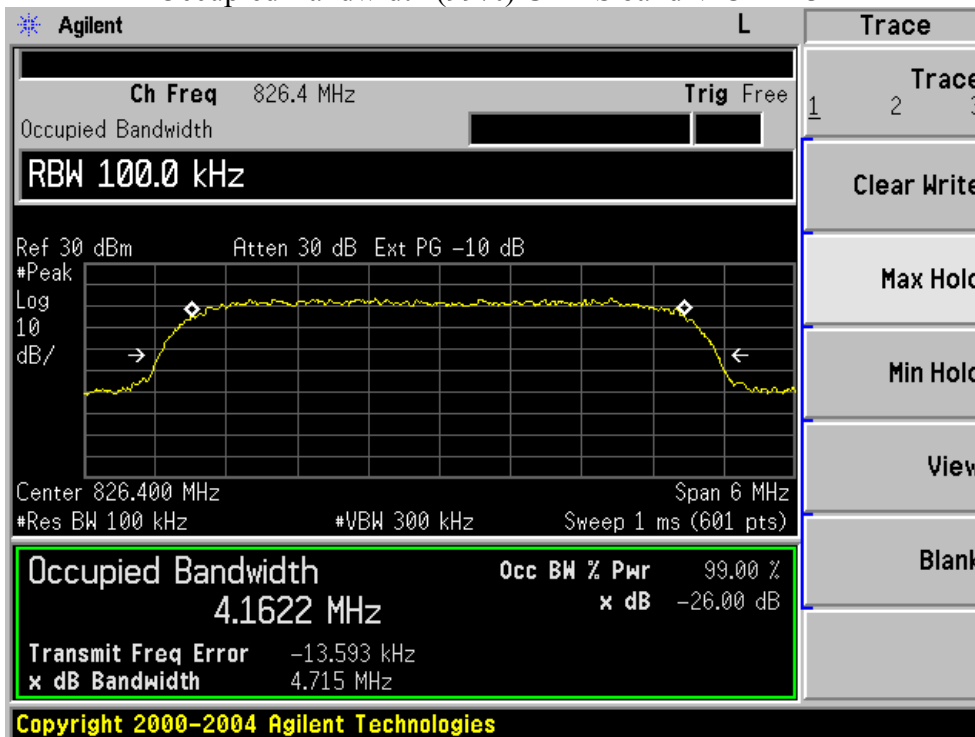

Occupied Bandwidth (99%) UMTS band V CH 4183

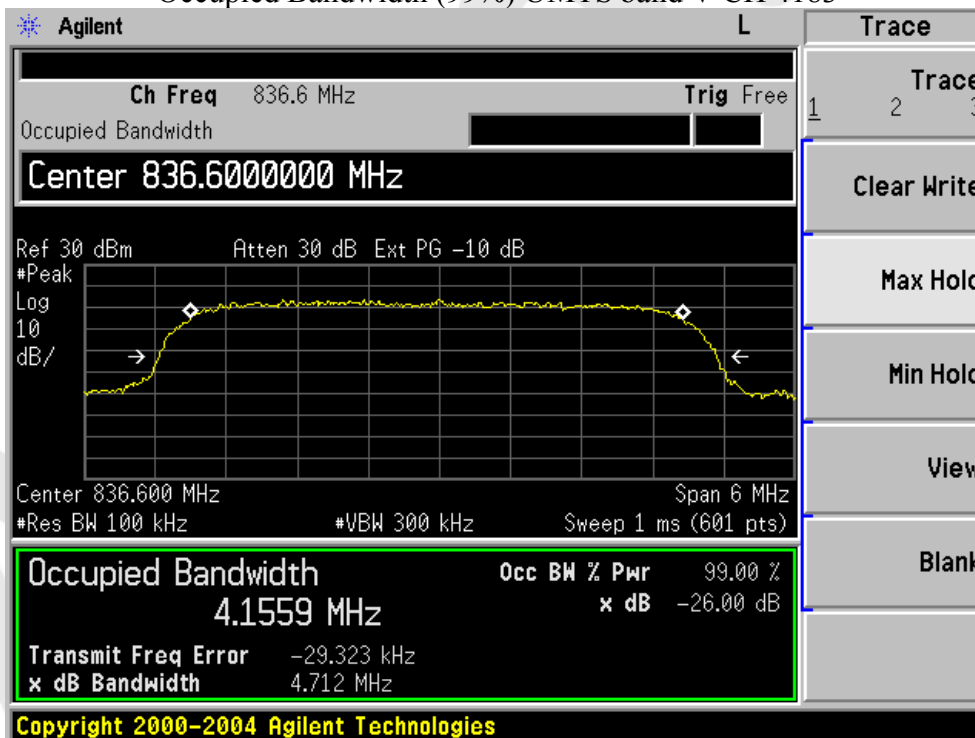

Occupied Bandwidth (99%) UMTS band V CH 4233

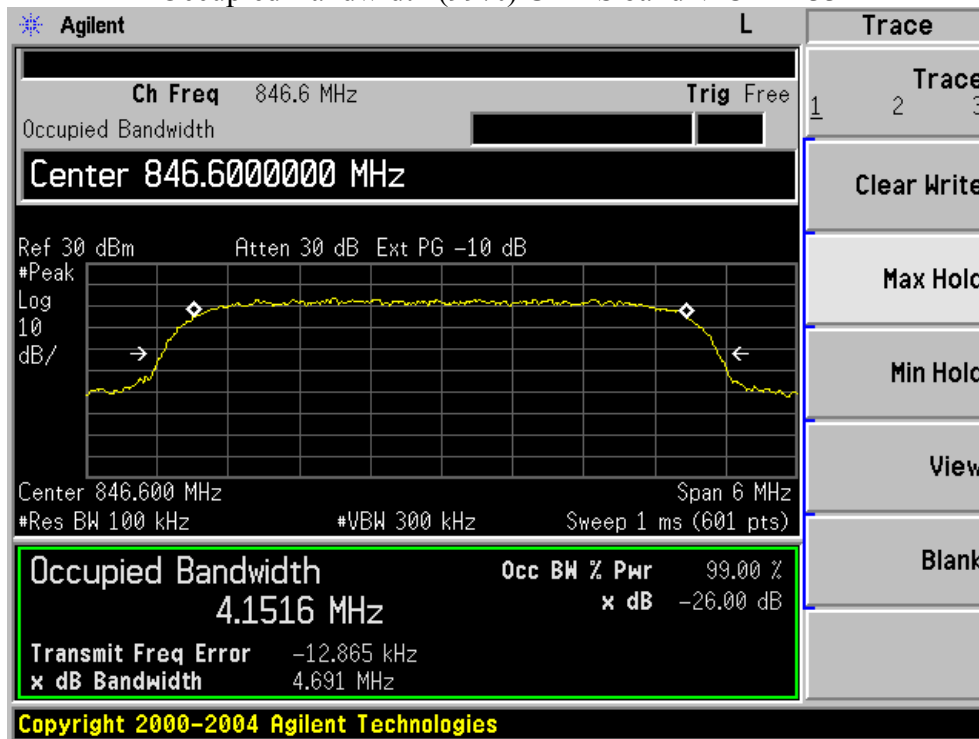

APPENDIX III TEST PLOTS FOR BAND EDGES

Low Band Edge GSM 850 BAND CH 128

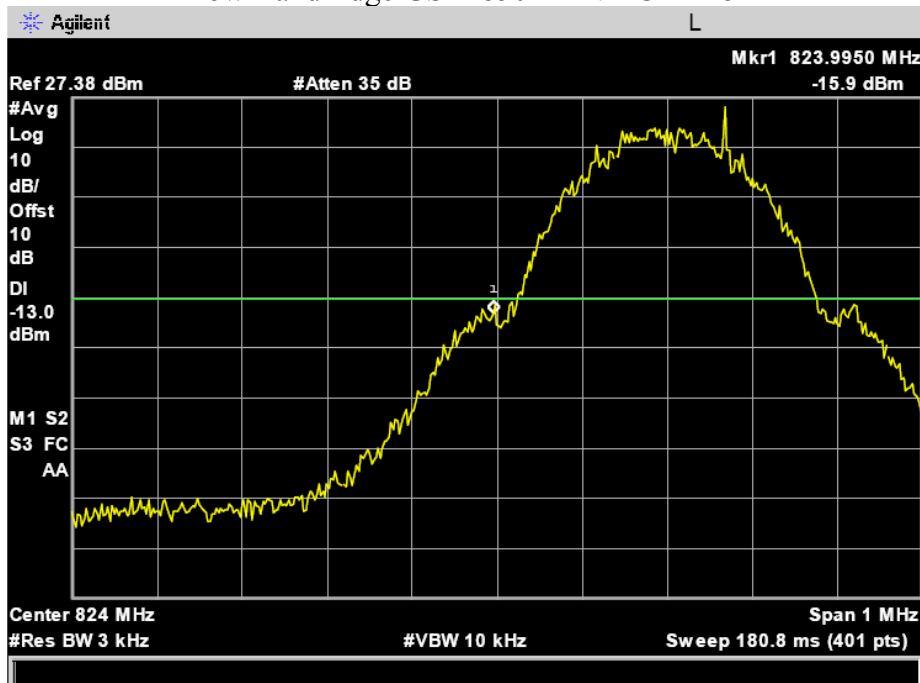

High Band Edge GSM 850 BAND CH 251

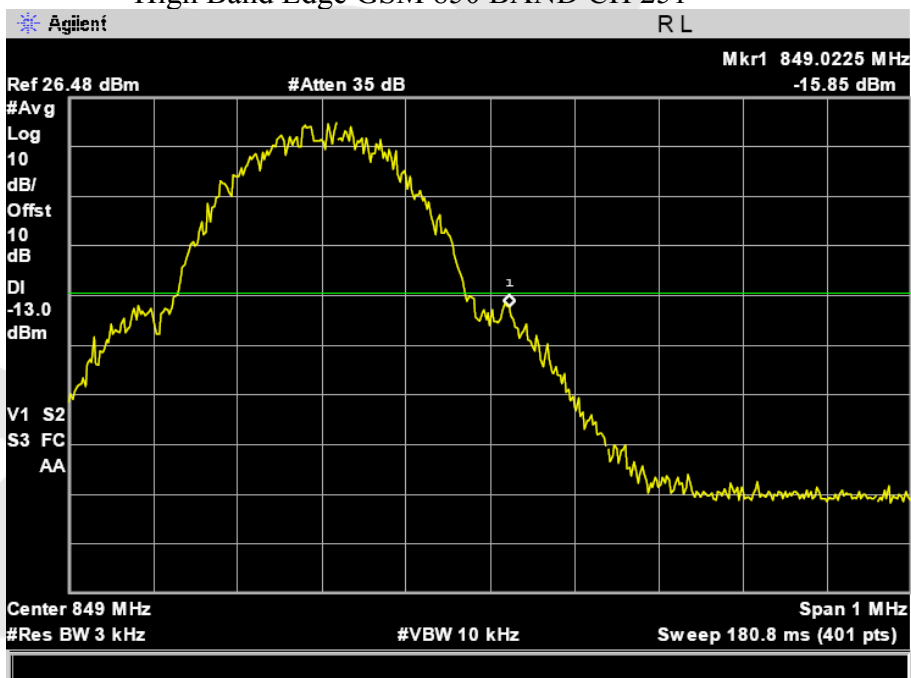

Low Band Edge PCS 1900 BAND CH 512

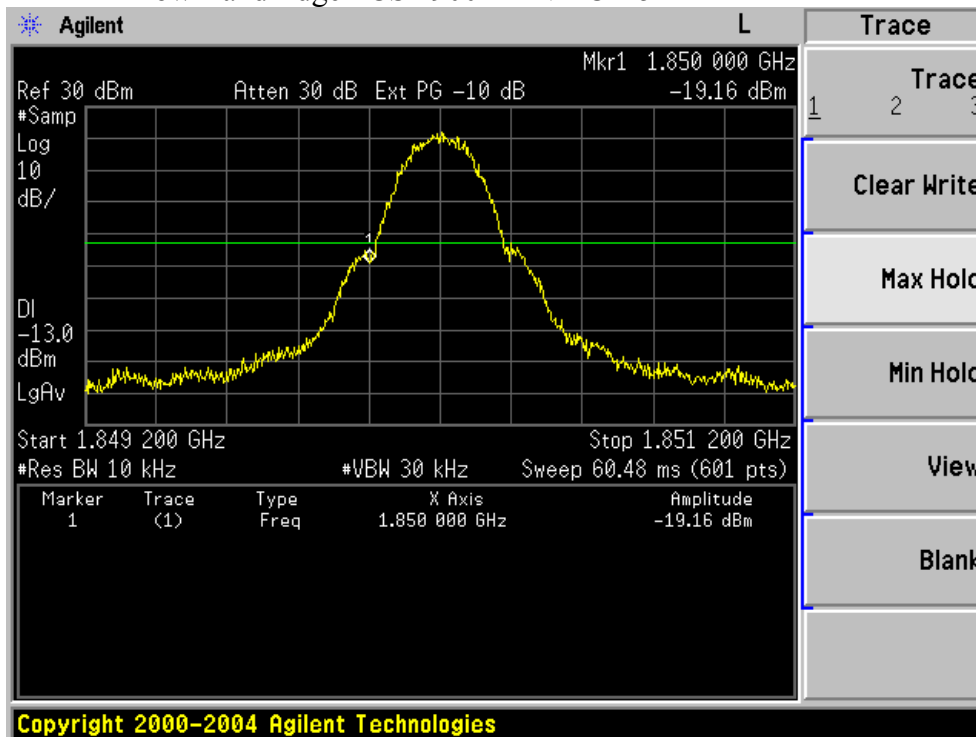

High Band Edge PCS 1900 BAND CH 810

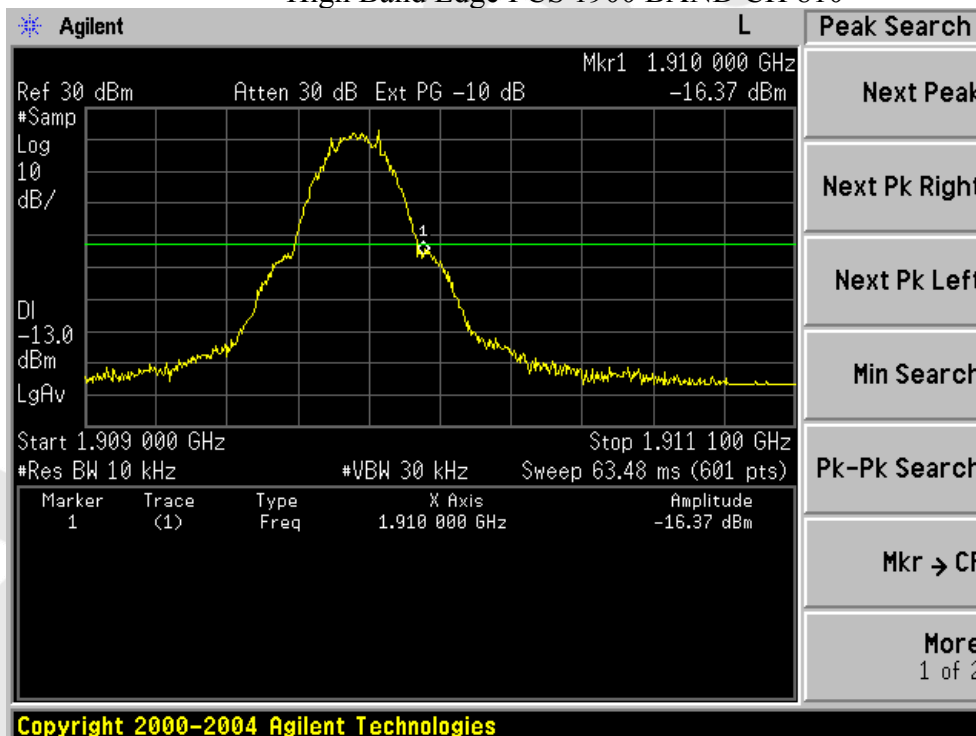

Low Band Edge GPRS 850 BAND CH 128

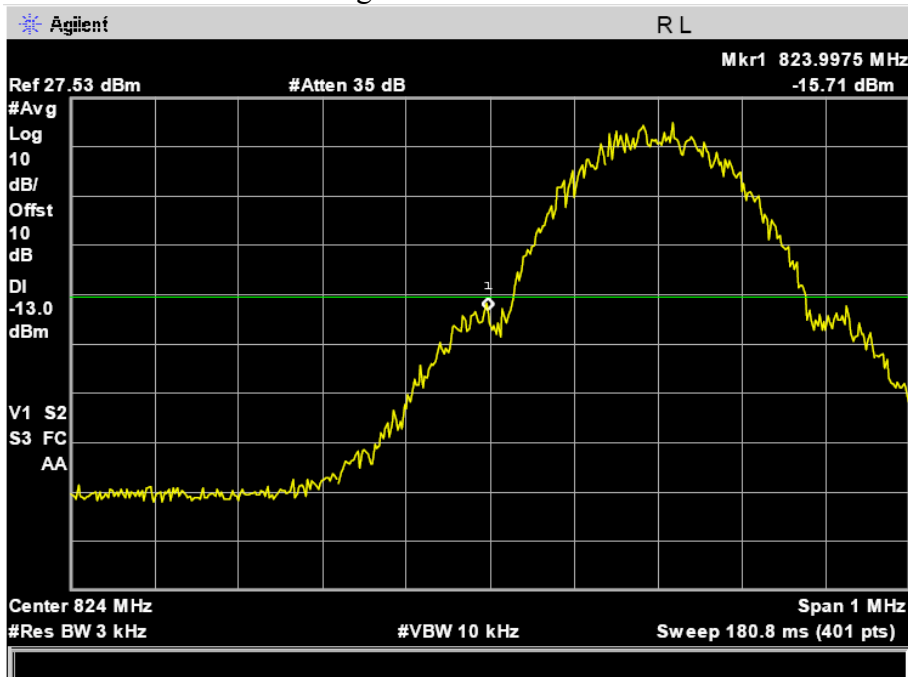

High Band Edge GPRS 850 BAND CH 251

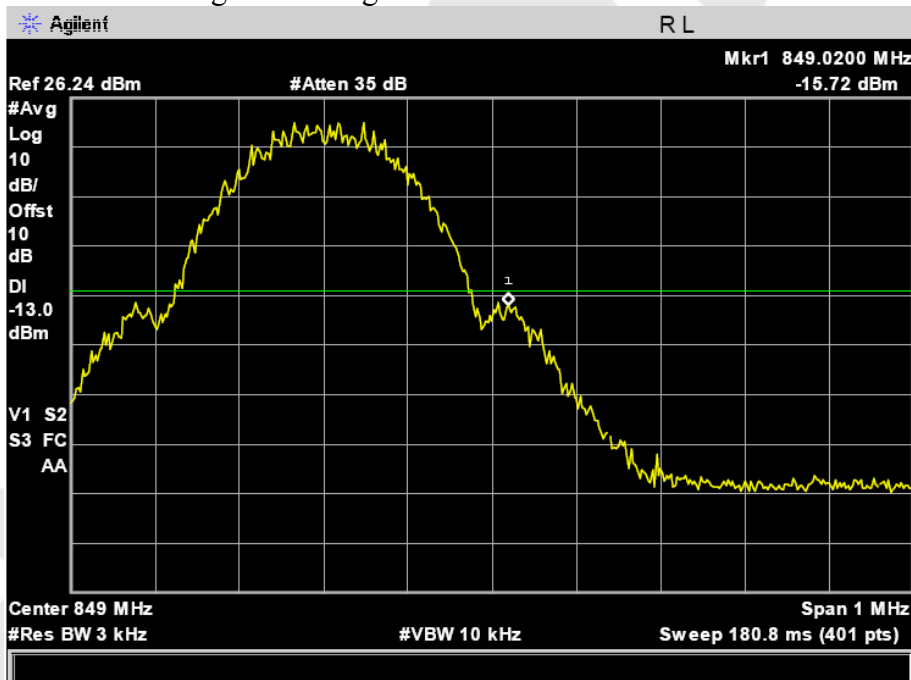

Low Band Edge GPRS 1900 BAND CH 512

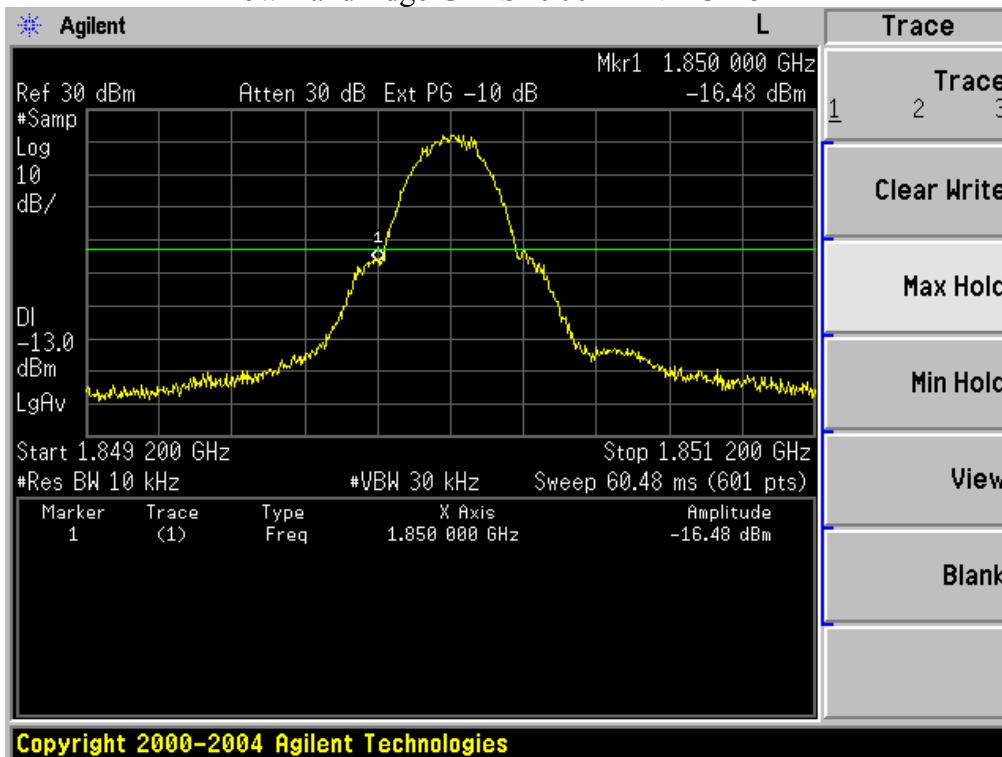

High Band Edge GPRS 1900 BAND CH 810

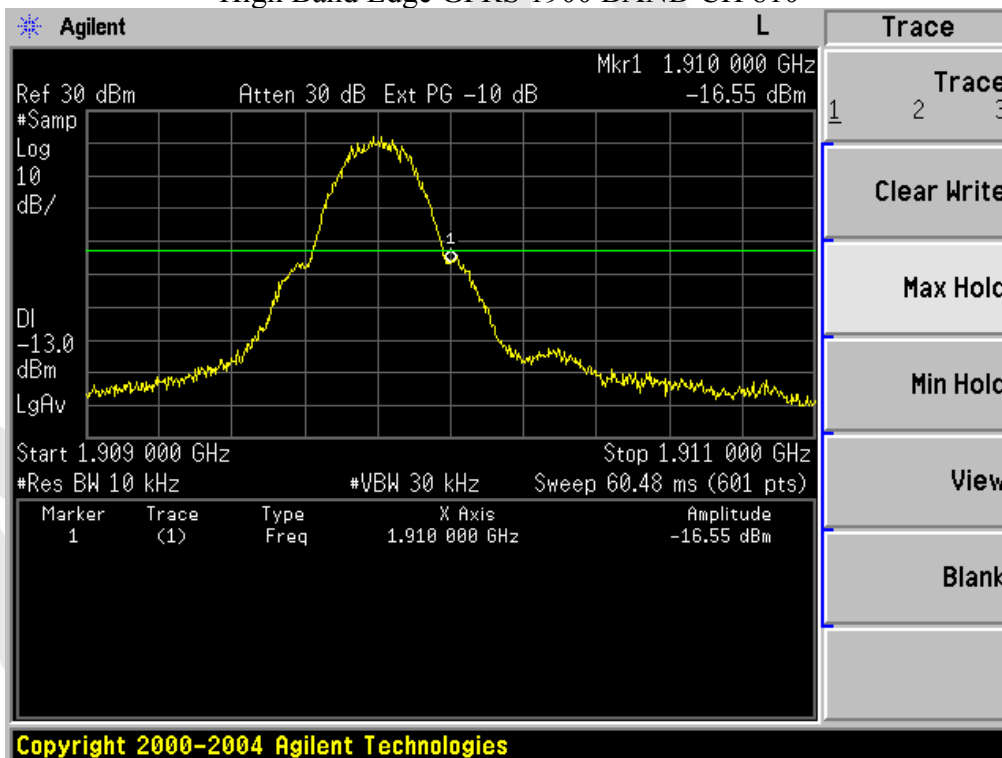

Low Band Edge EGPRS 850 BAND CH 128

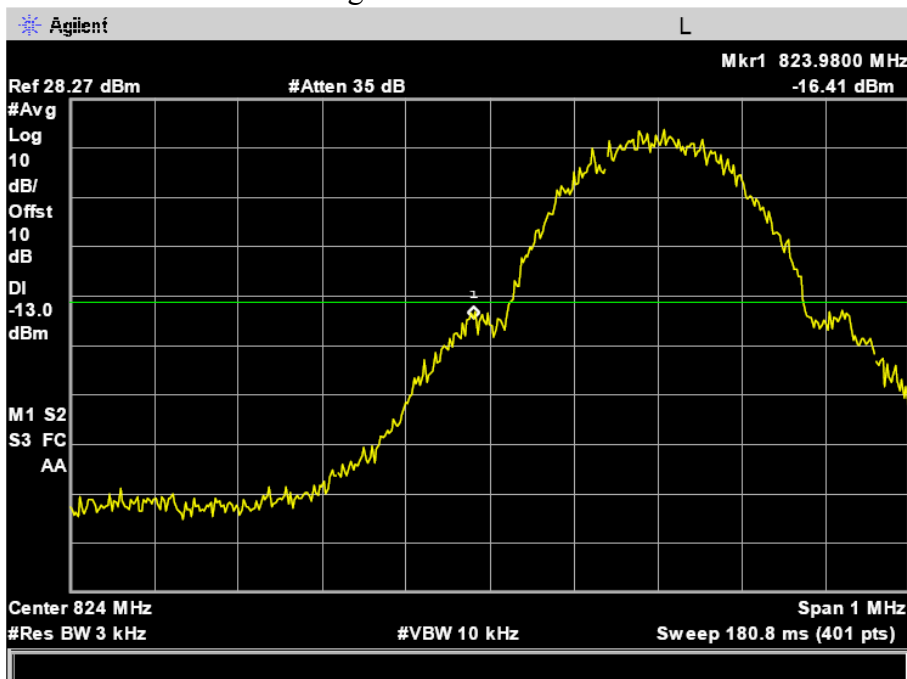

High Band Edge EGPRS 850 BAND CH 251

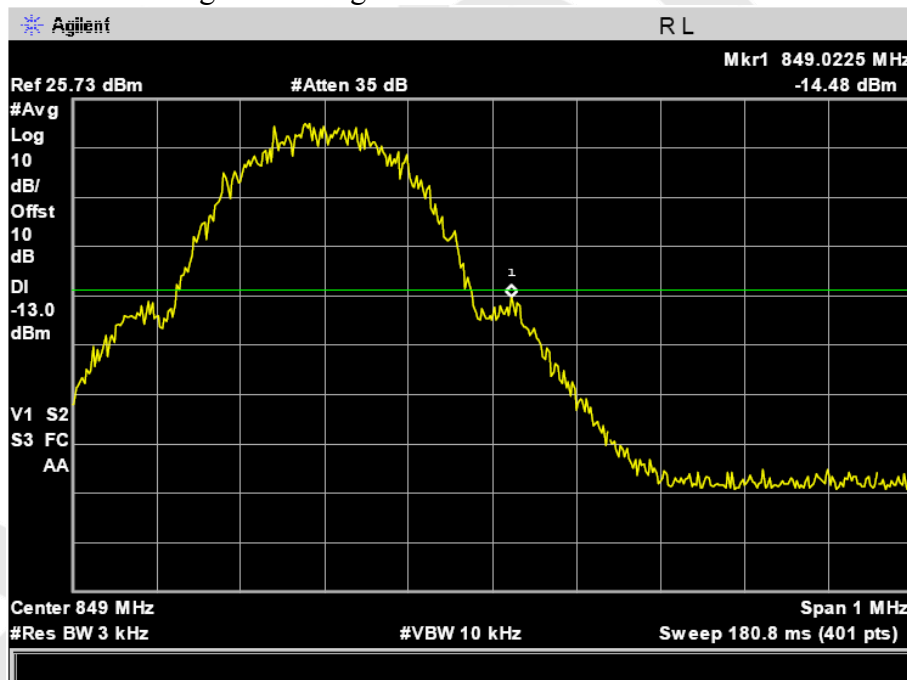

Low Band Edge EGPRS 1900 BAND CH 512

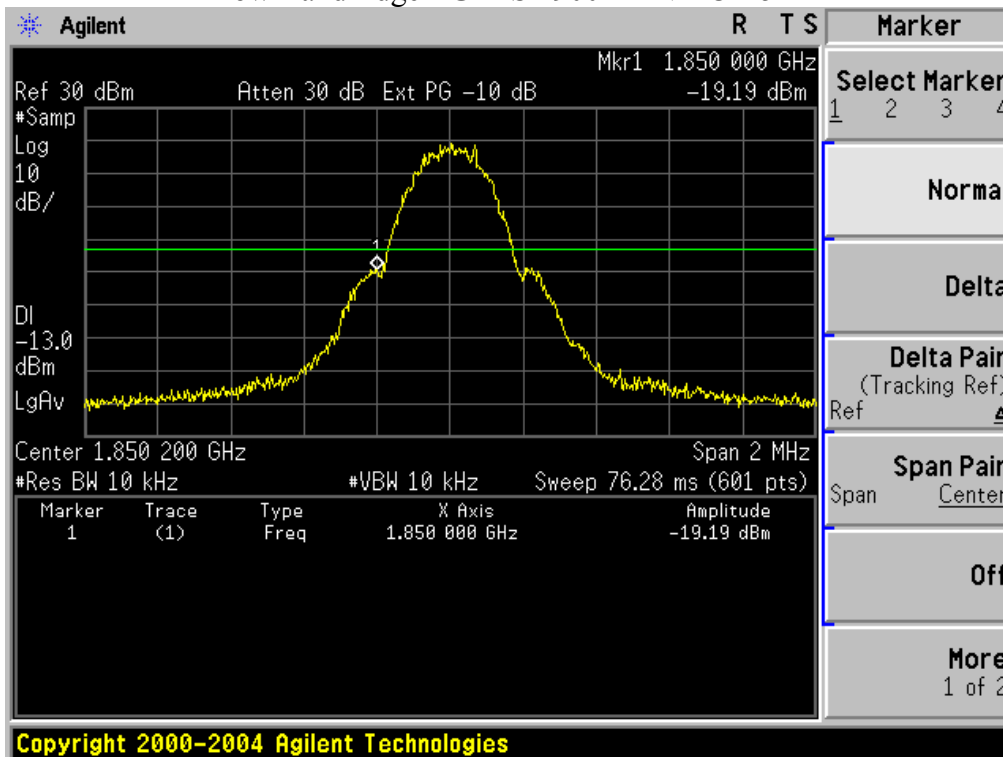

High Band Edge EGPRS 1900 BAND CH 810

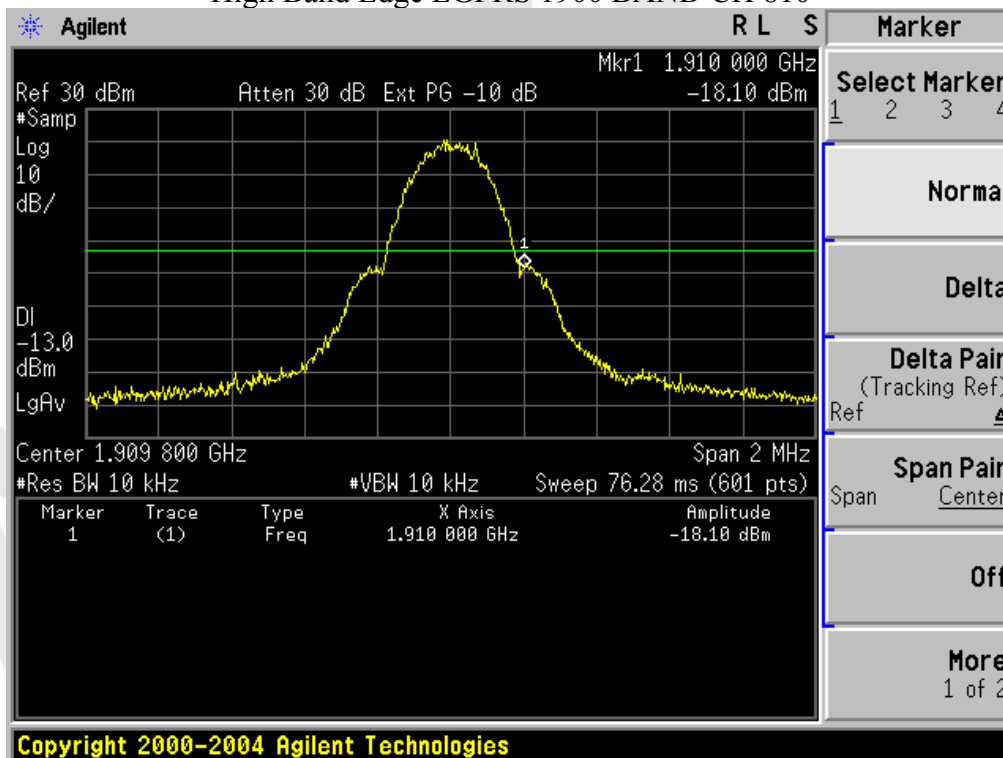

Low Band Edge UMTS BAND II CH 9262

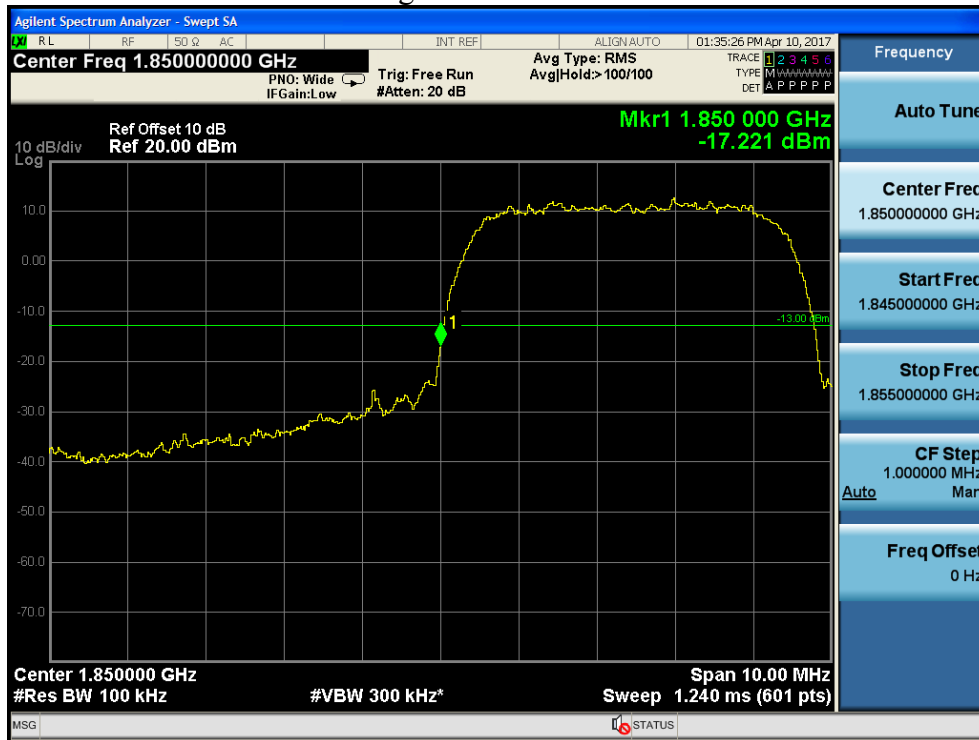

High Band Edge UMTS BAND II CH 9538



Low Band Edge UMTS BAND V CH 4132

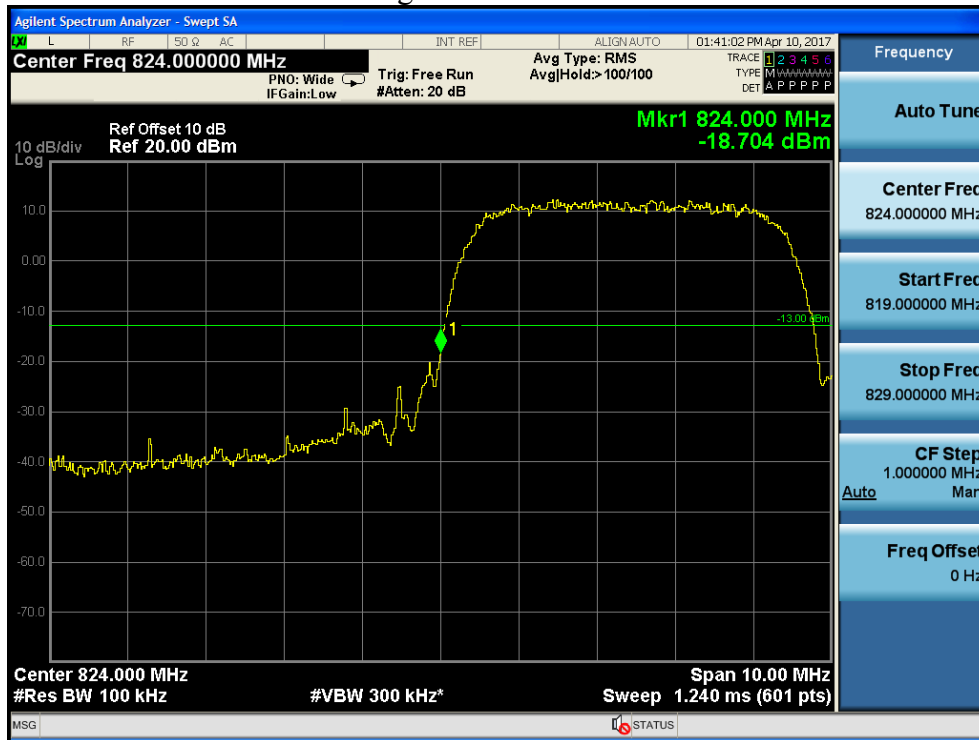

High Band Edge UMTS BAND V CH 4233



APPENDIX IV (TEST PHOTOGRAPHS)

Photo of Radiated Emission Test

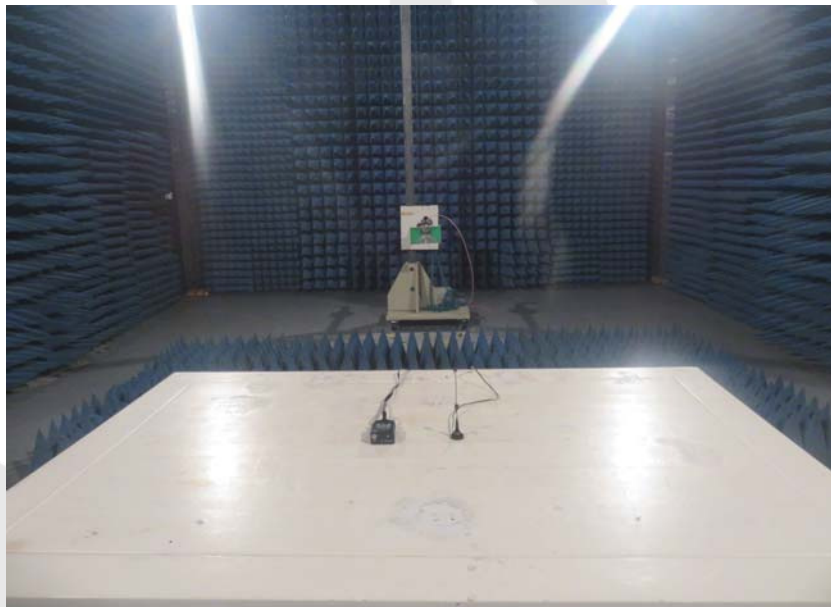
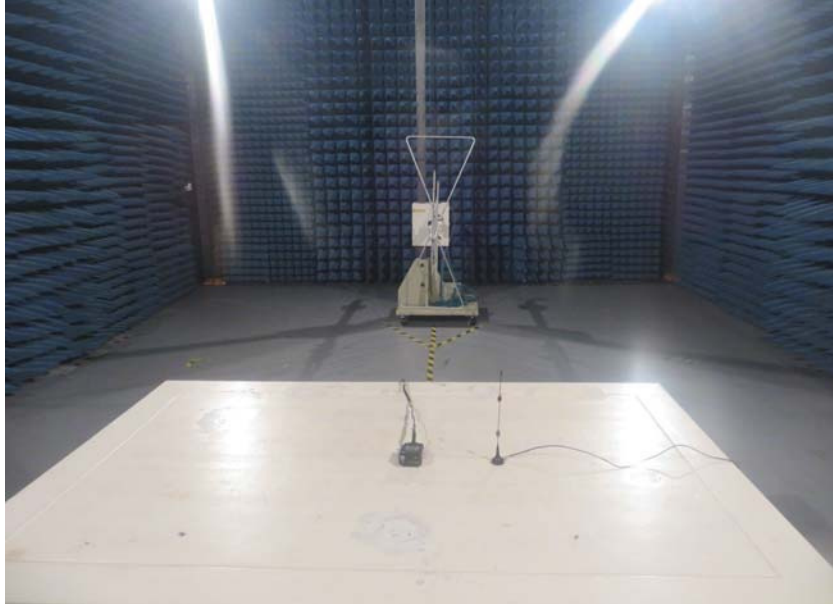

APPENDIX V (EXTERNAL PHOTOS)

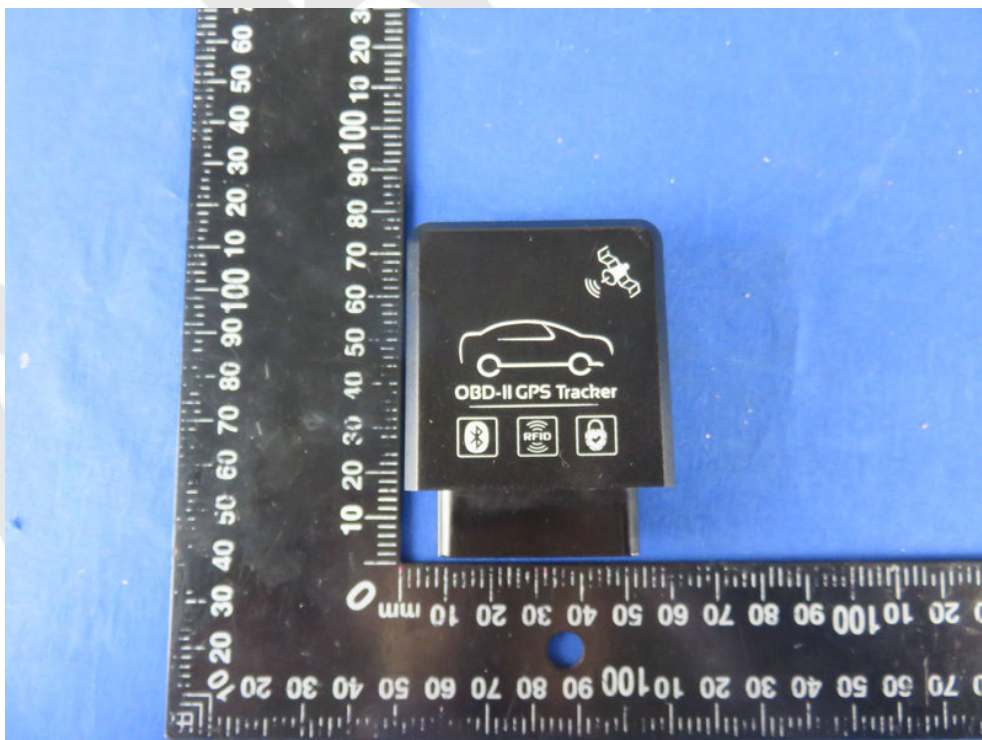
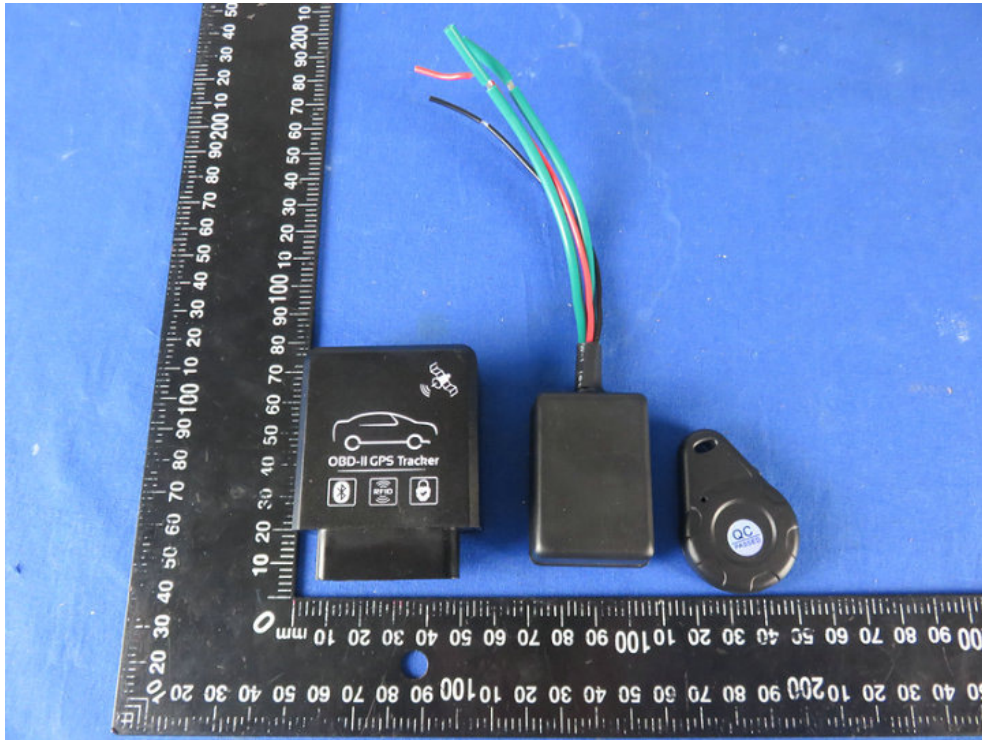

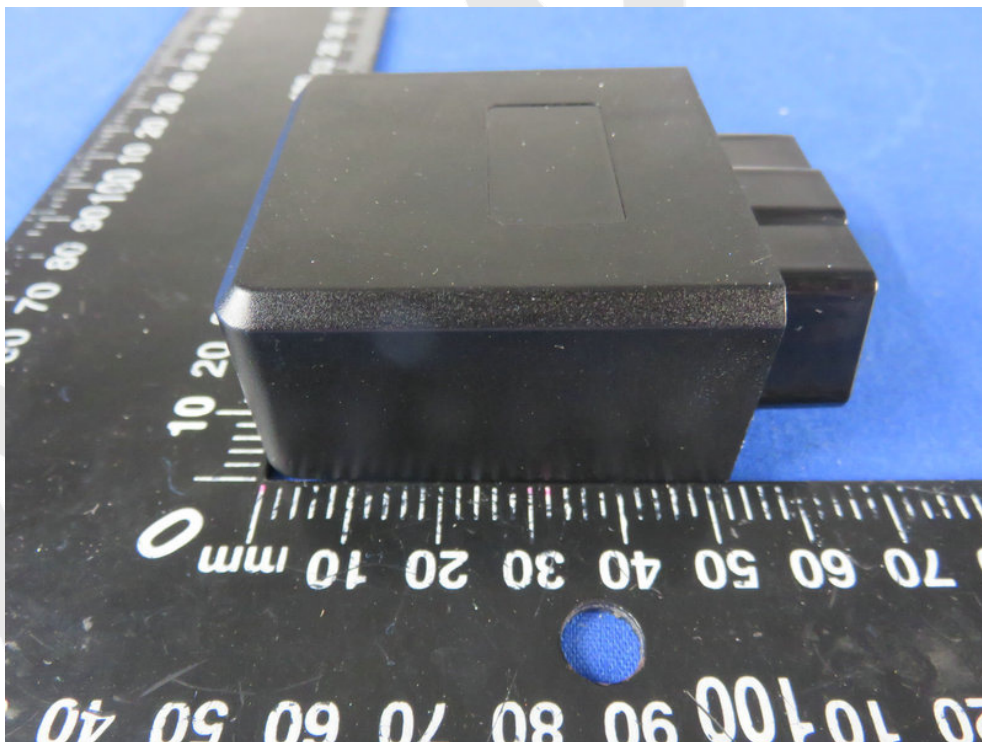
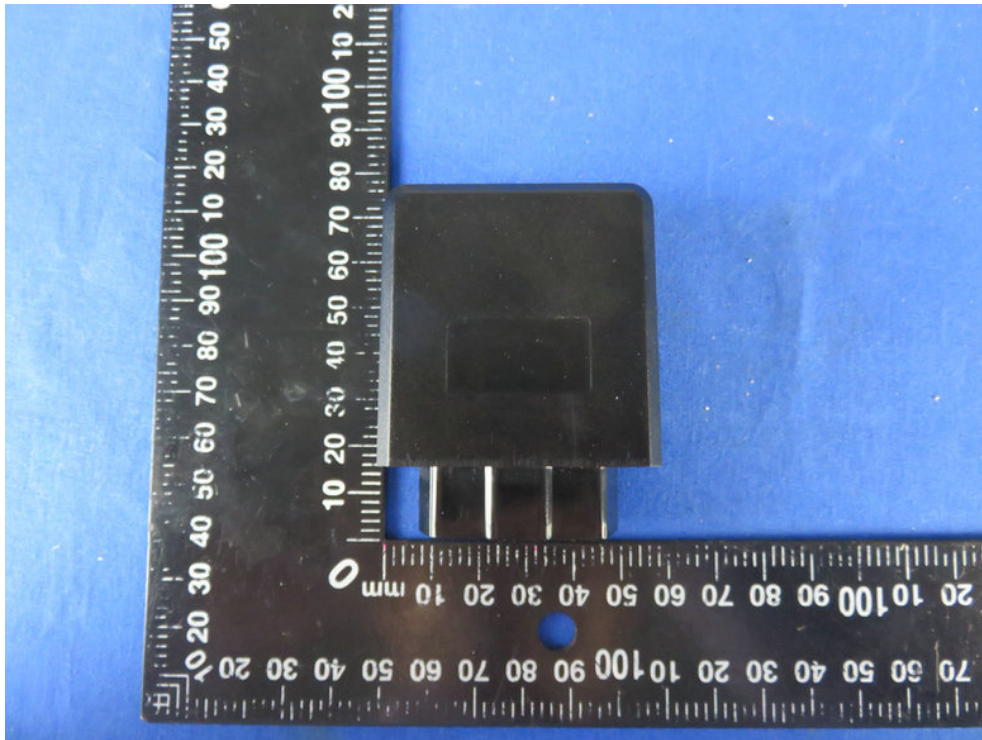

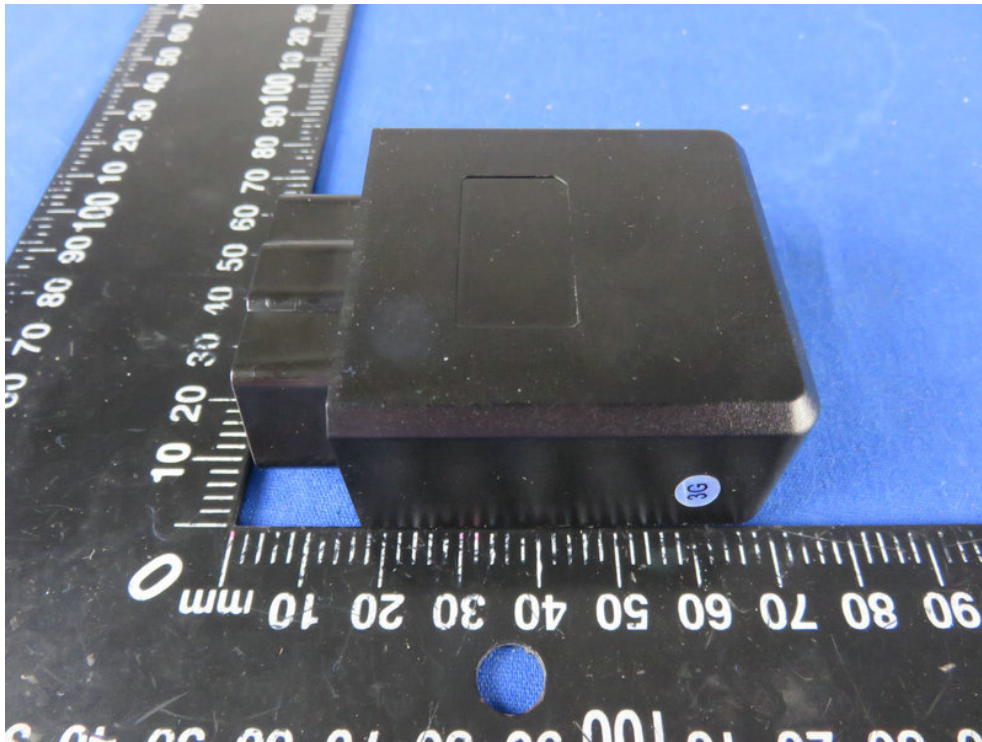

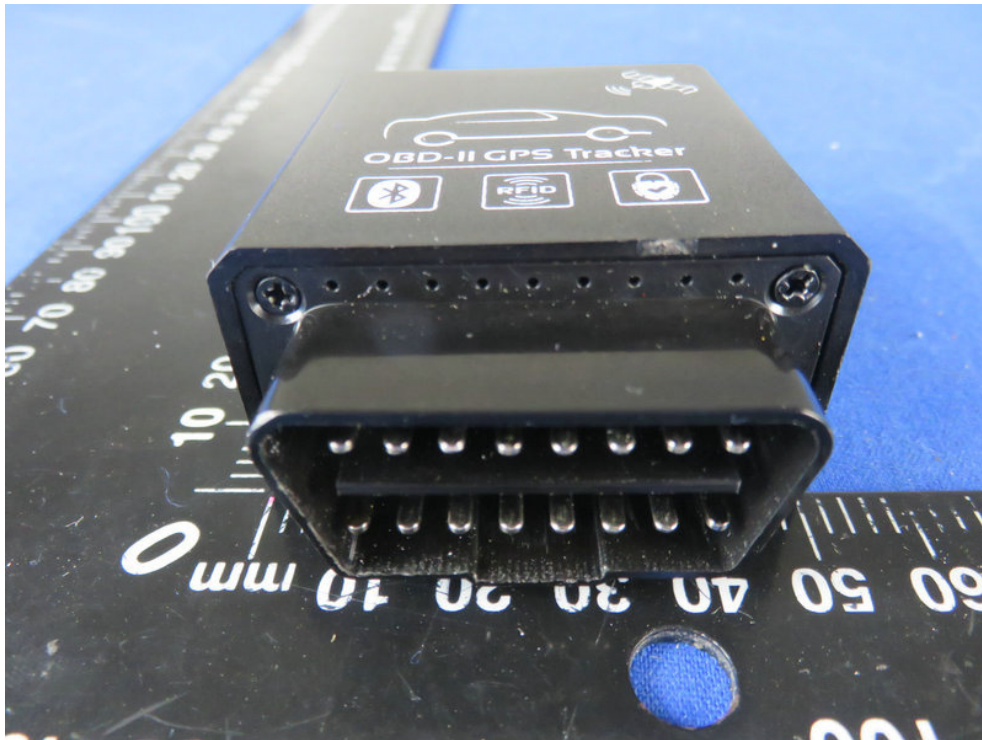

APPENDIX VI (INTERNAL PHOTOS)

