



FCC RADIO TEST REPORT

FCC ID:2ALPC-SV-86

Product : 8-Inch Fully Ruggedized Tablet

Trade Mark : N/A

Model Name : SV-86

Serial Model : N/A

Report No. : NTEK-2017NT03282288F5-01

Prepared for

Sinicvision Technology Co., Ltd.

Flat C 23/F Lucky Plaza, 315 - 321 Lockhart Road, Wan Chai, HK

Prepared by

Shenzhen NTEK Testing Technology Co., Ltd.

1/F, Building E, Fenda Science Park, Sanwei Community,
Xixiang Street Bao'an District, Shenzhen 518126 P.R. China

Tel.: +86-755-6115 9388

Fax.: +86-755-6115 6599

Website:<http://www.ntek.org.cn>

Table of Contents

	Page
1 . SUMMARY OF TEST RESULTS	5
1.1 TEST FACILITY	6
1.2 MEASUREMENT UNCERTAINTY	6
2 . GENERAL INFORMATION	7
2.1 GENERAL DESCRIPTION OF EUT	7
2.2 DESCRIPTION OF TEST MODES	10
2.3 BLOCK DIGRAM SHOWING THE CONFIGURATION OF SYSTEM TESTED	11
2.4 DESCRIPTION OF SUPPORT UNITS(CONDUCTED MODE)	12
2.5 EQUIPMENTS LIST FOR ALL TEST ITEMS	13
3 . EMC EMISSION TEST	15
3.1 CONDUCTED EMISSION MEASUREMENT	15
3.1.1 POWER LINE CONDUCTED EMISSION LIMITS	15
3.1.2 TEST PROCEDURE	16
3.1.3 DEVIATION FROM TEST STANDARD	16
3.1.4 TEST SETUP	16
3.1.5 EUT OPERATING CONDITIONS	16
3.1.6 TEST RESULTS	17
3.2 RADIATED EMISSION MEASUREMENT	21
3.2.1 APPLICABLE STANDARD	21
3.2.2 CONFORMANCE LIMIT	21
3.2.3 MEASURING INSTRUMENTS	21
3.2.4 TEST CONFIGURATION	22
3.2.5 TEST PROCEDURE	23
3.2.6 TEST RESULTS (BETWEEN 9KHZ – 30 MHZ)	24
3.2.7 TEST RESULTS (BETWEEN 30MHZ – 1GHZ)	25
3.2.8 TEST RESULTS (1GHZ-18GHZ)	27
4 . POWER SPECTRAL DENSITY TEST	33
4.1 APPLIED PROCEDURES / LIMIT	33
4.2 TEST PROCEDURE	34
4.3 DEVIATION FROM STANDARD	34
4.4 TEST SETUP	34
4.5 EUT OPERATION CONDITIONS	34
4.6 TEST RESULTS	35
5 . 26 DB & 99% EMISSION BANDWIDTH	43
5.1 APPLIED PROCEDURES / LIMIT	43
5.2 TEST PROCEDURE	43
5.3 EUT OPERATION CONDITIONS	44

Table of Contents

	Page
5.4 TEST RESULTS	45
6 . MINIMUM 6 DB BANDWIDTH	53
6.1 APPLIED PROCEDURES / LIMIT	53
6.2 TEST PROCEDURE	53
6.3 DEVIATION FROM STANDARD	53
6.4 TEST SETUP	53
6.5 EUT OPERATION CONDITIONS	53
6.6 TEST RESULTS	54
7 . MAXIMUM CONDUCTED OUTPUT POWER	62
7.1 PPLIED PROCEDURES / LIMIT	62
7.2 TEST PROCEDURE	62
7.3 DEVIATION FROM STANDARD	64
7.4 TEST SETUP	64
7.5 EUT OPERATION CONDITIONS	64
7.6 TEST RESULTS	65
8 . OUT OF BAND EMISSIONS	67
8.1 APPLICABLE STANDARD	67
8.2 TEST PROCEDURE	67
8.3 DEVIATION FROM STANDARD	67
8.4 TEST SETUP	67
8.5 EUT OPERATION CONDITIONS	67
8.6 TEST RESULTS	68
9.SPURIOUS RF CONDUCTED EMISSIONS	74
9.1CONFORMANCE LIMIT	74
9.2MEASURING INSTRUMENTS	74
9.3TEST SETUP	74
9.4TEST PROCEDURE	74
9.5TEST RESULTS	74
10. FREQUENCY STABILITY MEASUREMENT	89
10.1 LIMIT	89
10.2 TEST PROCEDURES	89
10.3 TEST SETUP LAYOUT	89
10.4 EUT OPERATION DURING TEST	89
10.5 TEST RESULTS	90
11. ANTENNA REQUIREMENT	96
11.1 STANDARD REQUIREMENT	96
11.2 EUT ANTENNA	96
APPENDIX-PHOTOGRAPHS OF EUT CONSTRUCTIONAL DETAILS	

1. SUMMARY OF TEST RESULTS

Test procedures according to the technical standards:

FCC Part15 (15.407) , Subpart E			
Standard Section	Test Item	Judgment	Remark
15.207	AC Power Line Conducted Emissions	PASS	
15.209(a), 15.407 (b)(1) 15.407 (b)(4) 15.407 (b)(6)	Spurious Radiated Emissions	PASS	
15.407 (a)(1) 15.407 (a)(3) 15.1049	26 dB and 99% Emission Bandwidth	PASS	
15.407(e)	Minimum 6 dB bandwidth	PASS	
15.407 (a)(1) 15.407 (a)(3)	Maximum Conducted Output Power	PASS	
2.1051, 15.407(b)(1) 15.407(b)(4)	Band Edges	PASS	
15.407 (a)(1) 15.407 (a)(3)	Power Spectral Density	PASS	
2.1051, 15.407(b)	Spurious Emissions at Antenna Terminals	PASS	
15.203	Antenna Requirement	PASS	

NOTE:

(1) "N/A" denotes test is not applicable in this Test Report

1.1 TEST FACILITY

Shenzhen NTEK Testing Technology Co., Ltd

Add.: 1/F, Building E, Fenda Science Park, Sanwei Community, Xixiang Street Bao'an District, Shenzhen 518126 P.R. China

FCC Registration No.:238937; IC Registration No.:9270A-1

CNAS Registration No.:L5516

1.2 MEASUREMENT UNCERTAINTY

The reported uncertainty of measurement $y \pm U$, where expanded uncertainty U is based on a standard uncertainty multiplied by a coverage factor of $k=2$, providing a level of confidence of approximately **95 %**.

No.	Item	Uncertainty
1	Conducted Emission Test	$\pm 1.38\text{dB}$
2	RF power,conducted	$\pm 0.16\text{dB}$
3	Spurious emissions,conducted	$\pm 0.21\text{dB}$
4	All emissions,radiated(<1G)	$\pm 4.68\text{dB}$
5	All emissions,radiated(>1G)	$\pm 4.89\text{dB}$
6	Temperature	$\pm 0.5^\circ\text{C}$
7	Humidity	$\pm 2\%$

2. GENERAL INFORMATION

2.1 GENERAL DESCRIPTION OF EUT

Equipment	8-Inch Fully Ruggedized Tablet		
Trade Mark	N/A		
Model Name	SV-86		
Product Description	IEEE 802.11 WLAN Mode Supported	<input checked="" type="checkbox"/> 802.11a(20MHz channel bandwidth) <input checked="" type="checkbox"/> 802.11n/AC(20MHz channel bandwidth) <input checked="" type="checkbox"/> 802.11n/AC(40MHz channel bandwidth) <input checked="" type="checkbox"/> 802.11AC(80MHz channel bandwidth)	
	Data Rate	802.11 a: 6,9,12,18,24,36,48,54Mbps; 802.11n(HT20):MCS0-MCS15; 802.11n(HT40):MCS0-MCS15; 802.11AC: NSS1,MCS0-MCS9,NSS2,MCS0-MCS9;	
	Modulation	OFDM with BPSK/QPSK/16QAM/64QAM/256QAM for 802.11a/n/ac;	
	Operating Frequency Range	<input checked="" type="checkbox"/> 5180-5240MHz for 802.11a/n(HT20)/AC20; 5190-5230MHz for 802.11n(HT40)/AC40; 5210MHz for 802.11 AC80; <input checked="" type="checkbox"/> 5745-5825 MHz for 802.11a/n(HT20)/AC20; 5755-5795 MHz for 802.11a/n(HT40)/AC40; 5775MHz for 802.11 AC80;	
	Number of Channels	<input checked="" type="checkbox"/> 4 channels for 802.11a/N20/AC20 in the 5180-5240MHz band ; 2 channels for 802.11 N40/AC40 in the 5190-5230MHz band ; 1 channels for 802.11 AC80 in the 5210MHz band ; <input checked="" type="checkbox"/> 5 channels for 802.11a/N20/AC20 in the 5745-5825MHz band ; 2 channels for 802.11 N40/AC40 in the 5755-5795MHz band ; 1 channels for 802.11 AC80 in the 5775MHz band ;	
	Antenna Type	FPCB Antenna	
	Smart system	<input checked="" type="checkbox"/> SISO for 802.11a <input checked="" type="checkbox"/> SISO for 802.11n/ac	
	Antenna Gain	See Table for Filed Antenna	
	Based on the application, features, or specification exhibited in User's Manual, More details of EUT technical specification, please refer to the User's Manual.		
	Ratings	DC 3.7V/8500mAh from Battery or DC 5V from Adapter.	
Adapter	Model:HNSC050300WX Input:100-240V 50/60Hz 0.45A Output:DC 5V, 3A		
Battery	DC 3.7V/8500mAh		
Connecting I/O Port(s)	Please refer to the User's Manual		

Note:

1. For a more detailed features description, please refer to the manufacturer's specifications or the User's Manual.
2. Frequency and Channel list for 802.11 a/n/ac (20MHz) (5180-5240MHz):

802.11a/n/ac(20MHz) Carrier Frequency Channel							
Channel	Frequen cy (MHz)	Channel	Frequen cy (MHz)	Channel	Frequen cy (MHz)	Channel	Frequen cy (MHz)
36	5180	44	5220	-	-	-	-
40	5200	48	5240	-	-	-	-

Frequency and Channel list for 802.11 n /ac (40MHz) (5190-5230MHz):

802.11n /ac(40MHz) Carrier Frequency Channel							
Channel	Frequen cy (MHz)	Channel	Frequen cy (MHz)	Channel	Frequen cy (MHz)	Channel	Frequen cy (MHz)
38	5190	-	-	-	-	-	-
46	5230	-	-	-	-	-	-

802.11ac (80MHz) Carrier Frequency Channel	
Channel	Frequency (MHz)
42	5210

Frequency and Channel list for 802.11 a/n/ac (20 MHz) (5745-5825MHz):

802.11a/n/ac(20 MHz) Carrier Frequency Channel							
Channel	Frequen cy (MHz)	Channel	Frequen cy (MHz)	Channel	Frequen cy (MHz)	Channel	Frequen cy (MHz)
149	5745	153	5765	157	5785	161	5805
165	5825	-	-	-	-	-	-

Frequency and Channel list for 802.11n/ac (40MHz) (5755-5795MHz):

802.11n/ac 40MHz Carrier Frequency Channel					
Channel	Frequency (MHz)	Channel	Frequency (MHz)	Channel	Frequency (MHz)
151	5755	159	5795	-	-

802.11ac 80MHz Carrier Frequency Channel	
Channel	Frequency (MHz)
155	5775

The EUT has two types of antenna.

Tx Antenna

Antenna	Antenna Type	Antenna Gain(dBi)	
		2.4G	5.0G
	FPCB	1	1

2.2 DESCRIPTION OF TEST MODES

To investigate the maximum EMI emission characteristics generates from EUT, the test system was pre-scanning tested base on the consideration of following EUT operation mode or test configuration mode which possible have effect on EMI emission level. Each of these EUT operation mode(s) or test configuration mode(s) mentioned above was evaluated respectively.

Pretest Mode	Description
Mode 1	Link Mode
Mode 2	802.11a / n/ ac 20 CH36/ CH40/ CH 48 802.11a /n/ ac 20 CH149/ CH157/ CH 165
Mode 3	802.11n/ ac40 CH38/ CH 46 802.11n/ ac40 CH 151 / CH 159
Mode 4	802.11 ac80 CH42/CH 155

For Radiated Emission	
Final Test Mode	Description
Mode 1	Link Mode
Mode 2	802.11a / n/ ac 20 CH36/ CH40/ CH 48 802.11a /n/ ac 20 CH149/ CH157/ CH 165
Mode 3	802.11n/ ac40 CH38/ CH 46 802.11n/ ac40 CH 151 / CH 159
Mode 4	802.11 ac80 CH42/CH 155

Note:

- (1) The measurements are performed at the highest, middle, lowest available channels.
- (2) The measurements are performed at all Bit Rate of Transmitter, the worst data was reported

2.3 BLOCK DIGRAM SHOWING THE CONFIGURATION OF SYSTEM TESTED

For AC Conducted Emission Mode

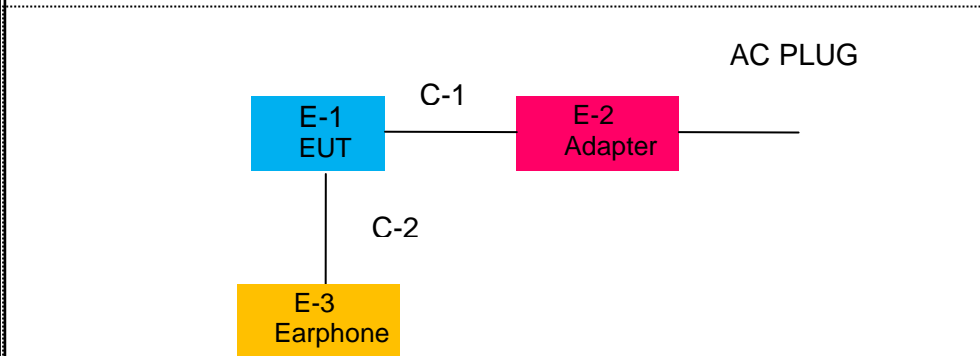

Radiated Spurious Emission Test



For Conducted Test Cases

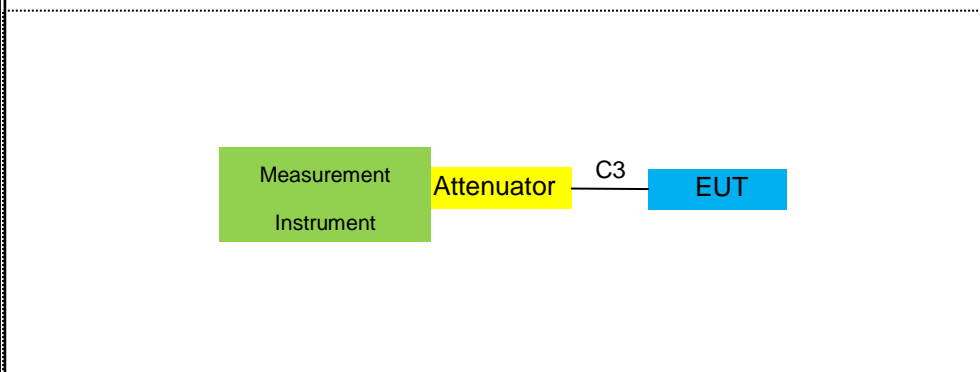

2.4 DESCRIPTION OF SUPPORT UNITS(CONDUCTED MODE)

The EUT has been tested as an independent unit together with other necessary accessories or support units. The following support units or accessories were used to form a representative test configuration during the tests.

Item	Equipment	Brand	Model/Type No.	Series No.	Note
E-1	8-Inch Fully Ruggedized Tablet	N/A	SV-86	N/A	EUT
E-2	Adapter	N/A	HNSC050300WX	N/A	Peripherals
E-3	Earphone	N/A	2688	N/A	

Item	Cable Type	Shielded Type	Ferrite Core	Length	Note
C-1	USB Cable	NO	NO	1.2m	
C-2	Earphone Cable	NO	NO	0.8m	
C-3	RF Cable	NO	NO	0.5m	

Note:

- (1) The support equipment was authorized by Declaration of Confirmation.
- (2) For detachable type I/O cable should be specified the length in cm in 『Length』 column.

2.5 EQUIPMENTS LIST FOR ALL TEST ITEMS

Radiation Test equipment

Item	Kind of Equipment	Manufacturer	Type No.	Serial No.	Last calibration	Calibrated until	Calibration period
1	Spectrum Analyzer	Agilent	E4407B	MY45108040	2016.07.06	2017.07.05	1 year
2	Spectrum Analyzer	Agilent	N9020A	MY49100060	2016.07.06	2017.07.05	1 year
3	EMI Test Receiver	Agilent	N9038A	MY53227146	2016.07.06	2017.07.05	1 year
4	Test Receiver	R&S	ESPI	101318	2016.07.06	2017.07.05	1 year
5	Bilog Antenna	TESEQ	CBL6111D	31216	2016.07.06	2017.07.05	1 year
6	50Ω Coaxial Switch	Anritsu	MP59B	6200264416	2016.07.06	2017.07.05	1 year
7	Spectrum Analyzer	ADVANTEST	R3132	150900201	2016.07.06	2017.07.05	1 year
8	Horn Antenna	EM	EM-AH-10180	2011071402	2016.07.06	2017.07.05	1 year
9	Horn Ant	Schwarzbeck	BBHA 9170	9170-181	2016.07.06	2017.07.05	1 year
10	Amplifier	EM	EM-30180	060538	2016.12.22	2017.12.21	1 year
11	Amplifier	MITEQ	TTA1840-35-HG	177156	2016.07.06	2017.07.05	1 year
12	Loop Antenna	ARA	PLA-1030/B	1029	2016.07.06	2017.07.05	1 year
13	Power Meter	R&S	NRVS	100696	2016.07.06	2017.07.05	1 year
14	Power Sensor	R&S	URV5-Z4	0395.1619.05	2016.07.06	2017.07.05	1 year
15	Test Cable	N/A	R-01	N/A	2016.07.06	2017.07.05	1 year
16	Test Cable	N/A	R-02	N/A	2016.07.06	2017.07.05	1 year
17	High Test Cable(1G-40 GHz)	N/A	R-03	N/A	2016.07.06	2017.07.05	1 year
18	High Test Cable(1G-40 GHz)	N/A	R-04	N/A	2016.07.06	2017.07.05	1 year

Conduction Test equipment

Item	Kind of Equipment	Manufacturer	Type No.	Serial No.	Last calibration	Calibrated until	Calibration period
1	Test Receiver	R&S	ESCI	101160	2016.07.06	2017.07.05	1 year
2	LISN	R&S	ENV216	101313	2016.08.24	2017.08.23	1 year
3	LISN	EMCO	3816/2	00042990	2016.07.06	2017.07.05	1 year
4	50Ω Coaxial Switch	Anritsu	MP59B	6200264417	2016.07.06	2017.07.05	1 year
5	Passive Voltage Probe	R&S	ESH2-Z3	100196	2016.07.06	2017.07.05	1 year
6	Absorbing clamp	R&S	MOS-21	100423	2016.07.06	2017.07.05	1 year
7	Test Cable	N/A	C01	N/A	2017.06.08	2018.06.07	1 year
8	Test Cable	N/A	C02	N/A	2017.06.08	2018.06.07	1 year
9	Test Cable	N/A	C03	N/A	2017.06.08	2018.06.07	1 year

1	Attenuation	MCE	24-10-34	BN9258	2016.07.06	2017.07.05	1 year
---	-------------	-----	----------	--------	------------	------------	--------

3. EMC EMISSION TEST

3.1 CONDUCTED EMISSION MEASUREMENT

3.1.1 POWER LINE CONDUCTED EMISSION Limits (Frequency Range 150KHz-30MHz)

FREQUENCY (MHz)	Class A (dBuV)		Class B (dBuV)		Standard
	Quasi-peak	Average	Quasi-peak	Average	
0.15 -0.5	79.00	66.00	66 - 56 *	56 - 46 *	CISPR
0.50 -5.0	73.00	60.00	56.00	46.00	CISPR
5.0 -30.0	73.00	60.00	60.00	50.00	CISPR

0.15 -0.5	79.00	66.00	66 - 56 *	56 - 46 *	FCC/ RSS-247
0.50 -5.0	73.00	60.00	56.00	46.00	FCC/ RSS-247
5.0 -30.0	73.00	60.00	60.00	50.00	FCC/ RSS-247

Note:

- (1) The tighter limit applies at the band edges.
- (2) The limit of " * " marked band means the limitation decreases linearly with the logarithm of the frequency in the range.

The following table is the setting of the receiver

Receiver Parameters	Setting
Attenuation	10 dB
Start Frequency	0.15 MHz
Stop Frequency	30 MHz
IF Bandwidth	9 kHz

3.1.2 TEST PROCEDURE

- a. The EUT was placed 0.8 meters from the horizontal ground plane with EUT being connected to the power mains through a line impedance stabilization network (LISN). All other support equipments powered from additional LISN(s). The LISN provide 50 Ohm/ 50uH of coupling impedance for the measuring instrument.
- b. Interconnecting cables that hang closer than 40 cm to the ground plane shall be folded back and forth in the center forming a bundle 30 to 40 cm long.
- c. I/O cables that are not connected to a peripheral shall be bundled in the center. The end of the cable may be terminated, if required, using the correct terminating impedance. The overall length shall not exceed 1 m.
- d. LISN at least 80 cm from nearest part of EUT chassis.
- e. For the actual test configuration, please refer to the related Item –EUT Test Photos.

3.1.3 DEVIATION FROM TEST STANDARD

No deviation

3.1.4 TEST SETUP

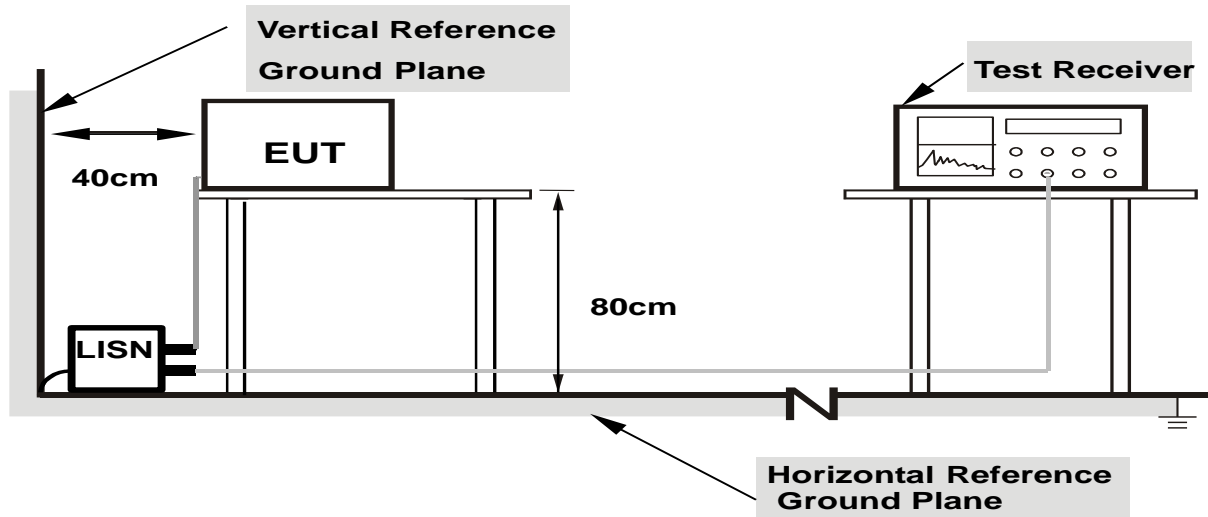

- Note:**
- 1. Support units were connected to second LISN.
 - 2. Both of LISNs (AMN) are 80 cm from EUT and at least 80 from other units and other metal planes

3.1.5 EUT OPERATING CONDITIONS

The EUT was configured for testing in a typical fashion (as a customer would normally use it). The EUT has been programmed to continuously transmit during test. This operating condition was tested and used to collect the included data.

3.1.6 TEST RESULTS

EUT :	8-Inch Fully Ruggedized Tablet	Model Name. :	SV-86
Temperature :	26 °C	Relative Humidity :	56%
Pressure :	1010hPa	Phase :	L
Test Voltage :	DC 5V from Adapter AC120V/60Hz	Test Mode :	Mode 1

Frequency (MHz)	Meter Reading (dBμV)	Factor (dB)	Emission Level (dBμV)	Limits (dBμV)	Margin (dB)	Detector Type
0.1555	49.20	9.70	58.90	65.70	-6.80	QP
0.1555	34.98	9.70	44.68	55.70	-11.02	AVG
0.1882	44.20	9.70	53.90	64.11	-10.21	QP
0.1882	30.19	9.70	39.89	54.11	-14.22	AVG
0.2220	41.30	9.70	51.00	62.74	-11.74	QP
0.2220	30.35	9.70	40.05	52.74	-12.69	AVG
0.2519	38.80	9.70	48.50	61.69	-13.19	QP
0.2519	26.87	9.70	36.57	51.69	-15.12	AVG
0.2819	35.70	9.70	45.40	60.76	-15.36	QP
0.2819	22.51	9.70	32.21	50.76	-18.55	AVG
10.5259	32.78	9.92	42.70	60.00	-17.30	QP
10.5259	24.19	9.92	34.11	50.00	-15.89	AVG

Remark:

1. All readings are Quasi-Peak and Average values.
2. Factor = Insertion Loss + Cable Loss.

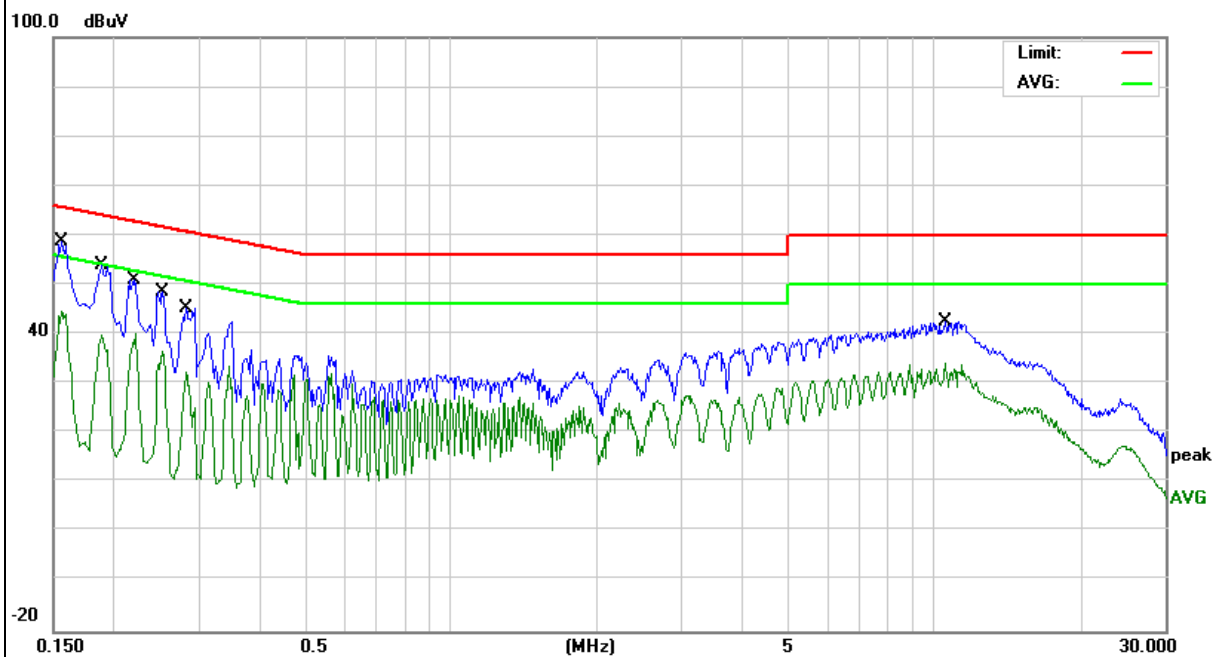

EUT :	8-Inch Fully Ruggedized Tablet	Model Name. :	SV-86
Temperature :	26 °C	Relative Humidity :	56%
Pressure :	1010hPa	Phase :	N
Test Voltage :	DC 5V from Adapter AC120V/60Hz	Test Mode :	Mode 1

Frequency (MHz)	Meter Reading (dBμV)	Factor (dB)	Emission Level (dBμV)	Limits (dBμV)	Margin (dB)	Detector Type
0.1580	46.60	9.80	56.40	65.56	-9.16	QP
0.1580	31.71	9.80	41.51	55.56	-14.05	AVG
0.1985	44.70	9.80	54.50	63.67	-9.17	QP
0.1985	17.32	9.80	27.12	53.67	-26.55	AVG
0.2139	41.10	9.80	50.90	63.05	-12.15	QP
0.2139	22.54	9.80	32.34	53.05	-20.71	AVG
0.2859	35.20	9.80	45.00	60.64	-15.64	QP
0.2859	21.73	9.80	31.53	50.64	-19.11	AVG
1.2980	23.08	9.82	32.90	56.00	-23.10	QP
1.2980	5.59	9.82	15.41	46.00	-30.59	AVG
10.9059	33.87	10.03	43.90	60.00	-16.10	QP
10.9059	24.74	10.03	34.77	50.00	-15.23	AVG

Remark:

1. All readings are Quasi-Peak and Average values.
2. Factor = Insertion Loss + Cable Loss.

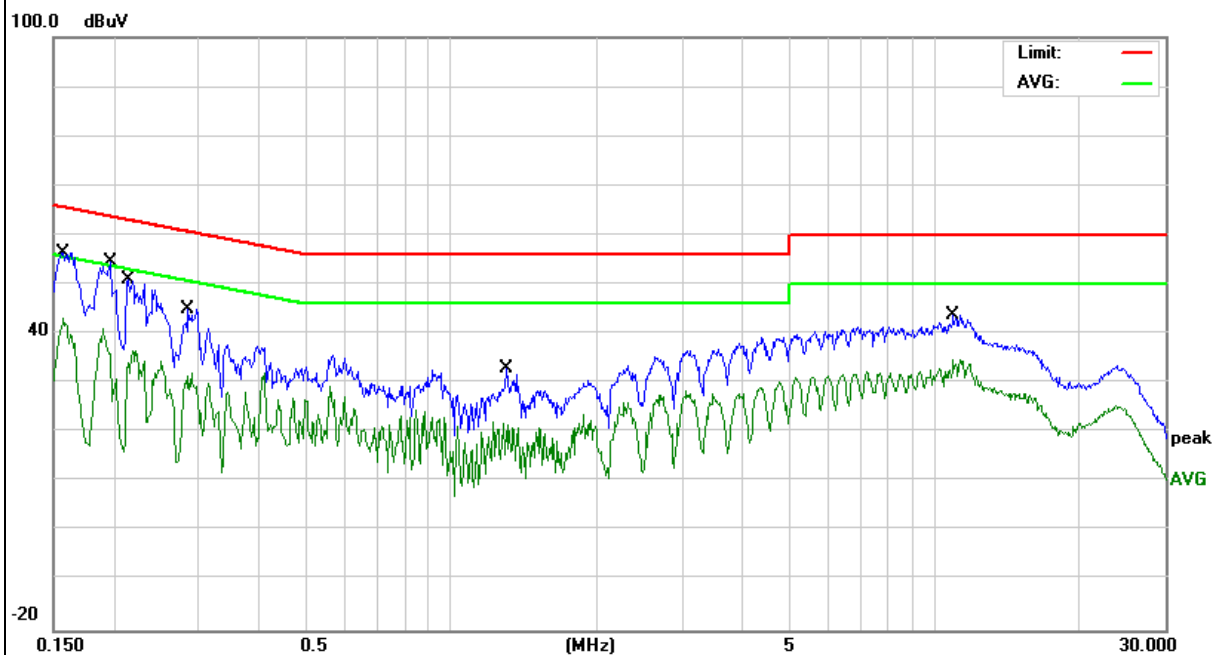

EUT :	8-Inch Fully Ruggedized Tablet	Model Name. :	SV-86
Temperature :	26 °C	Relative Humidity :	56%
Pressure :	1010hPa	Phase :	L
Test Voltage :	DC 5V from Adapter AC240V/60Hz	Test Mode :	Mode 1

Frequency (MHz)	Meter Reading (dBμV)	Factor (dB)	Emission Level (dBμV)	Limits (dBμV)	Margin (dB)	Detector Type
0.1516	45.40	9.70	55.10	65.91	-10.81	QP
0.1516	26.91	9.70	36.61	55.91	-19.30	AVG
0.1685	45.30	9.70	55.00	65.03	-10.03	QP
0.1685	31.48	9.70	41.18	55.03	-13.85	AVG
0.2099	41.80	9.70	51.50	63.21	-11.71	QP
0.2099	20.71	9.70	30.41	53.21	-22.80	AVG
0.2419	39.00	9.70	48.70	62.03	-13.33	QP
0.2419	27.38	9.70	37.08	52.03	-14.95	AVG
0.3180	32.20	9.70	41.90	59.76	-17.86	QP
0.3180	12.26	9.70	21.96	49.76	-27.80	AVG
3.2179	27.94	9.95	37.89	56.00	-18.11	QP
3.2179	19.98	9.95	29.93	46.00	-16.07	AVG

Remark:

1. All readings are Quasi-Peak and Average values.
2. Factor = Insertion Loss + Cable Loss.

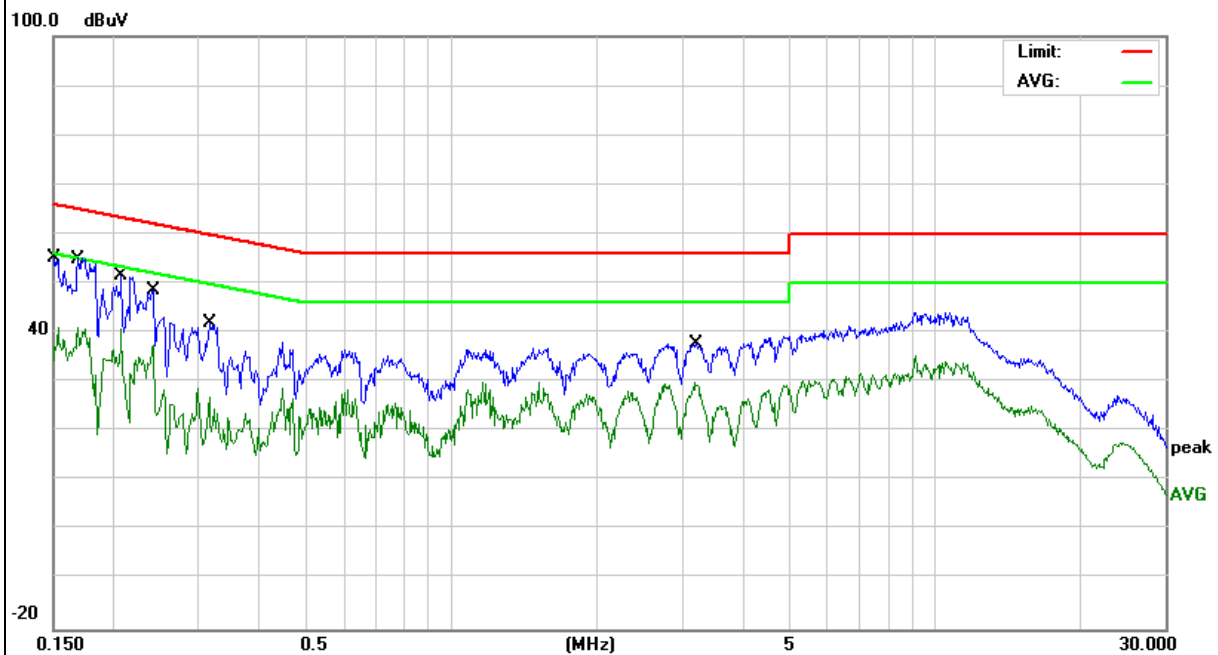

EUT :	8-Inch Fully Ruggedized Tablet	Model Name. :	SV-86
Temperature :	26 °C	Relative Humidity :	56%
Pressure :	1010hPa	Phase :	N
Test Voltage :	DC 5V from Adapter AC240V/60Hz	Test Mode :	Mode 1

Frequency (MHz)	Meter Reading (dBμV)	Factor (dB)	Emission Level (dBμV)	Limits (dBμV)	Margin (dB)	Detector Type
0.1547	0.1547	0.1547	0.1547	0.1547	0.1547	QP
0.1547	0.1547	0.1547	0.1547	0.1547	0.1547	AVG
0.1721	0.1721	0.1721	0.1721	0.1721	0.1721	QP
0.1721	0.1721	0.1721	0.1721	0.1721	0.1721	AVG
0.2260	0.2260	0.2260	0.2260	0.2260	0.2260	QP
0.2260	0.2260	0.2260	0.2260	0.2260	0.2260	AVG
0.2520	0.2520	0.2520	0.2520	0.2520	0.2520	QP
0.2520	0.2520	0.2520	0.2520	0.2520	0.2520	AVG
0.4979	0.4979	0.4979	0.4979	0.4979	0.4979	QP
0.4979	0.4979	0.4979	0.4979	0.4979	0.4979	AVG
10.2939	10.2939	10.2939	10.2939	10.2939	10.2939	QP
10.2939	10.2939	10.2939	10.2939	10.2939	10.2939	AVG

Remark:

1. All readings are Quasi-Peak and Average values.
2. Factor = Insertion Loss + Cable Loss.

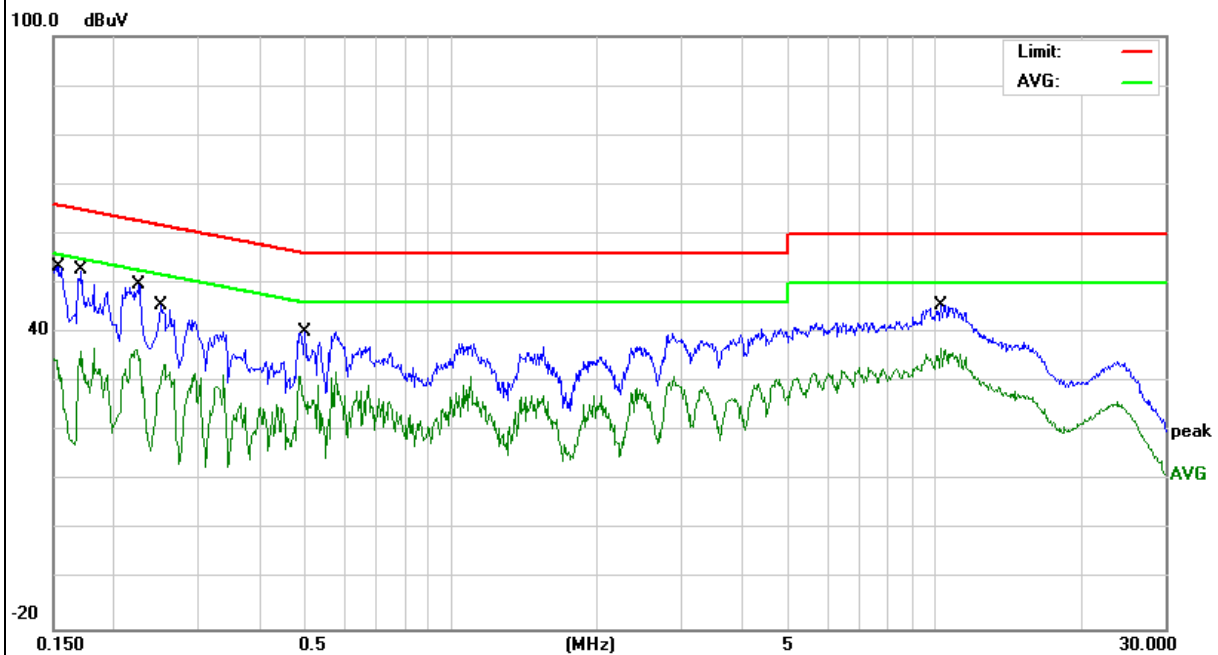

3.2 RADIATED EMISSION MEASUREMENT

3.2.1 APPLICABLE STANDARD

According to FCC Part 15.407(d) and 15.209

3.2.2 CONFORMANCE LIMIT

According to FCC Part 15.407(b)(7): radiated emissions which fall in the restricted bands, as defined in §15.205(a), must also comply with the radiated emission limits specified in §15.209(a) (see §15.205(c)). According to FCC Part 15.205, Restricted bands

MHz	MHz	MHz	GHz
0.090-0.110	16.42-16.423	399.9-410	4.5-5.15
10.495-0.505	16.69475-16.69525	608-614	5.35-5.46
2.1735-2.1905	16.80425-16.80475	960-1240	7.25-7.75
4.125-4.128	25.5-25.67	1300-1427	8.025-8.5
4.17725-4.17775	37.5-38.25	1435-1626.5	9.0-9.2
4.20725-4.20775	73-74.6	1645.5-1646.5	9.3-9.5
6.215-6.218	74.8-75.2	1660-1710	10.6-12.7
6.26775-6.26825	123-138	2200-2300	14.47-14.5
8.291-8.294	149.9-150.05	2310-2390	15.35-16.2
8.362-8.366	156.52475-156.52525	2483.5-2500	17.7-21.4
8.37625-8.38675	156.7-156.9	2690-2900	22.01-23.12
8.41425-8.41475	162.0125-167.17	3260-3267	23.6-24.0
12.29-12.293	167.72-173.2	3332-3339	31.2-31.8
12.51975-12.52025	240-285	3345.8-3358	36.43-36.5
12.57675-12.57725	322-335.4	3600-4400	(2)
13.36-13.41			

20dBc in any 100 kHz bandwidth outside the operating frequency band. In case the emission fall within the restricted band specified on 15.205(a), then the 15.209(a) limit in the table below has to be followed.

Restricted Frequency(MHz)	Field Strength (µV/m)	Field Strength (dBµV/m)	Measurement Distance
0.009~0.490	2400/F(KHz)	20 log (uV/m)	300
0.490~1.705	2400/F(KHz)	20 log (uV/m)	30
1.705~30.0	30	29.5	30
30-88	100	40	3
88-216	150	43.5	3
216-960	200	46	3
Above 960	500	54	3

Limits of Radiated Emission Measurement(Above 1000MHz)

Frequency(MHz)	Class B (dBuV/m) (at 3M)	
	PEAK	AVERAGE
Above 1000	74	54

- Remark :1. Emission level in dBuV/m=20 log (uV/m)
 2. Measurement was performed at an antenna to the closed point of EUT distance of meters.
 3. Distance extrapolation factor =40log(Specific distance/ test distance)(dB);
 Limit line=Specific limits(dBuV) + distance extrapolation factor.

3.2.3 MEASURING INSTRUMENTS

The Measuring equipment is listed in the section 6.3 of this test report.

3.2.4 TEST CONFIGURATION

(a) For radiated emissions below 30MHz

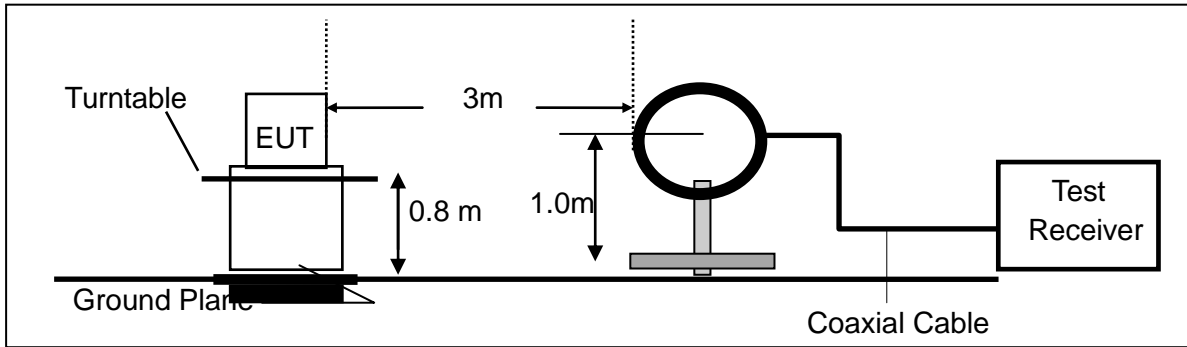

(b) For radiated emissions from 30MHz to 1000MHz

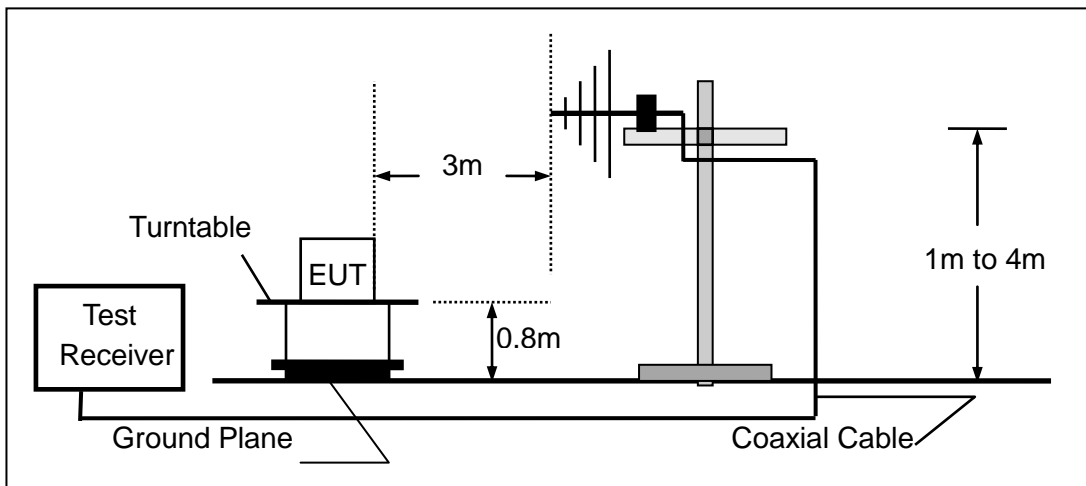

(c) For radiated emissions above 1000MHz

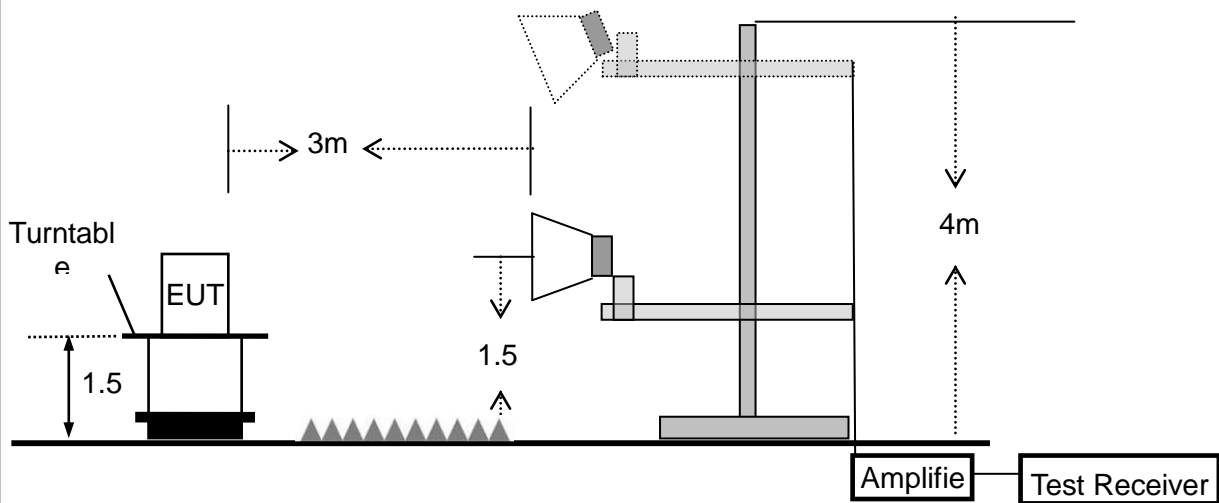

3.2.5 TEST PROCEDURE

The test site semi-anechoic chamber has met the requirement of NSA tolerance 4 dB according to the standards: ANSI C63.10-2013. The test distance is 3m. The setup is according to the requirements in Section 13.1.4.1 of ANSI C63.10-2013 and CAN/CSA-CEI/IEC CISPR 22.

This test is required for any spurious emission that falls in a Restricted Band, as defined in Section 15.205. It must be performed with the highest gain of each type of antenna proposed for use with the EUT.

Use the following spectrum analyzer settings:

Spectrum Parameter	Setting
Attenuation	Auto
Start Frequency	1000 MHz
Stop Frequency	10th carrier harmonic
RB / VB (emission in restricted band)	1 MHz / 1 MHz for Peak, 1 MHz / 10Hz for Average

Receiver Parameter	Setting
Attenuation	Auto
Start ~ Stop Frequency	9kHz~150kHz / RB 200Hz for QP
Start ~ Stop Frequency	150kHz~30MHz / RB 9kHz for QP
Start ~ Stop Frequency	30MHz~1000MHz / RB 120kHz for QP

- The measuring distance of at 3 m shall be used for measurements at frequency up to 1GHz. For frequencies above 1GHz, any suitable measuring distance may be used.
- The EUT was placed on the top of a rotating table 0.8 m for below 1GHz and 1.5m for above 1GHz the ground at a 3 meter. The table was rotated 360 degrees to determine the position of the highest radiation.
- The height of the equipment or of the substitution antenna shall be 0.8 m for below 1GHz and 1.5m for above 1GHz; the height of the test antenna shall vary between 1 m to 4 m. Both horizontal and vertical polarizations of the antenna are set to make the measurement.
- The initial step in collecting conducted emission data is a spectrum analyzer peak detector mode pre-scanning the measurement frequency range. Significant peaks are then marked and then Quasi Peak detector mode re-measured.
- If the Peak Mode measured value compliance with and lower than Quasi Peak Mode Limit, the EUT shall be deemed to meet QP Limits and then no additional QP Mode measurement performed.
- For the actual test configuration, please refer to the related Item –EUT Test Photos.

Note:

Both horizontal and vertical antenna polarities were tested and performed pretest to three orthogonal axis. The worst case emissions were reported

During the radiated emission test, the Spectrum Analyzer was set with the following configurations:

Frequency Band (MHz)	Function	Resolution bandwidth	Video Bandwidth
30 to 1000	QP	120 kHz	300 kHz
Above 1000	Peak	1 MHz	1 MHz
	Average	1 MHz	10 Hz

Note: for the frequency ranges below 30 MHz, a narrower RBW is used for these ranges but the measured value should add a RBW correction factor (RBWCF) where $RBWCF [dB] = 10 \cdot \lg(100 [kHz] / \text{narrower RBW [kHz]})$. , the narrower RBW is 1 kHz and RBWCF is 20 dB for the frequency 9 kHz to 150 kHz, and the narrower RBW is 10 kHz and RBWCF is 10 dB for the frequency 150 kHz to 30 MHz.

3.2.6 TEST RESULTS (BETWEEN 9KHZ – 30 MHZ)

EUT:	8-Inch Fully Ruggedized Tablet	Model Name. :	SV-86
Temperature:	20 °C	Relative Humidity:	48%
Pressure:	1010 hPa	Test Voltage :	DC 3.7V
Test Mode :	TX	Polarization :	--

Freq. (MHz)	Reading (dBuV/m)	Limit (dBuV/m)	Margin (dB)	State P/F
--	--	--	--	N/A
--	--	--	--	N/A

NOTE:

The amplitude of spurious emissions which are attenuated by more than 20dB below the permissible value has no need to be reported.

Distance extrapolation factor = $40 \log (\text{specific distance}/\text{test distance})(\text{dB})$;

Limit line = specific limits(dBuv) + distance extrapolation factor.

3.2.7 TEST RESULTS (BETWEEN 30MHZ – 1GHZ)

EUT :	8-Inch Fully Ruggedized Tablet	Model Name :	SV-86
Temperature :	20 °C	Relative Humidity :	48%
Pressure :	1010 hPa	Test Voltage :	DC 3.7V
Test Mode :	TX- 802.11a (High CH)		

Polar (H/V)	Frequency	Meter Reading	Factor	Emission Level	Limits	Margin	Remark
	(MHz)	(dBuV)	(dB)	(dBuV/m)	(dBuV/m)	(dB)	
V	78.4133	20.32	8.48	28.80	40.00	-11.20	QP
V	93.4402	14.30	11.21	25.51	43.50	-17.99	QP
V	148.4410	16.12	13.04	29.16	43.50	-14.34	QP
V	230.0985	18.27	12.23	30.50	46.00	-15.50	QP
V	550.9479	9.23	24.88	34.11	46.00	-11.89	QP
V	633.9071	10.47	25.18	35.65	46.00	-10.35	QP

Remark:

Absolute Level= ReadingLevel+ Factor, Margin= Absolute Level - Limit

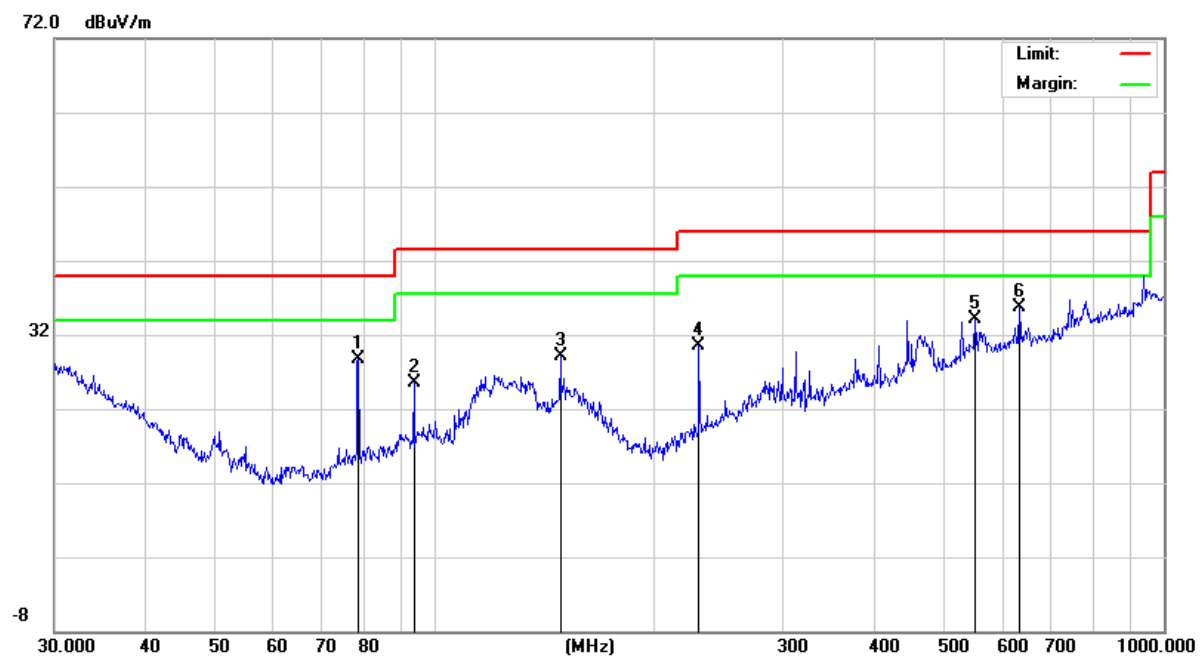

Polar (H/V)	Frequency	Meter Reading	Factor	Emission Level	Limits	Margin	Remark
	(MHz)	(dBuV)	(dB)	(dBuV/m)	(dBuV/m)	(dB)	
H	171.9944	14.74	11.56	26.30	43.50	-17.20	QP
H	203.5226	18.10	10.60	28.70	43.50	-14.80	QP
H	326.7395	17.40	17.10	34.50	46.00	-11.50	QP
H	444.8514	12.50	20.83	33.33	46.00	-12.67	QP
H	526.3967	12.68	23.22	35.90	46.00	-10.10	QP
H	633.9071	14.19	25.18	39.37	46.00	-6.63	QP

Remark:

Absolute Level= ReadingLevel+ Factor, Margin= Absolute Level - Limit

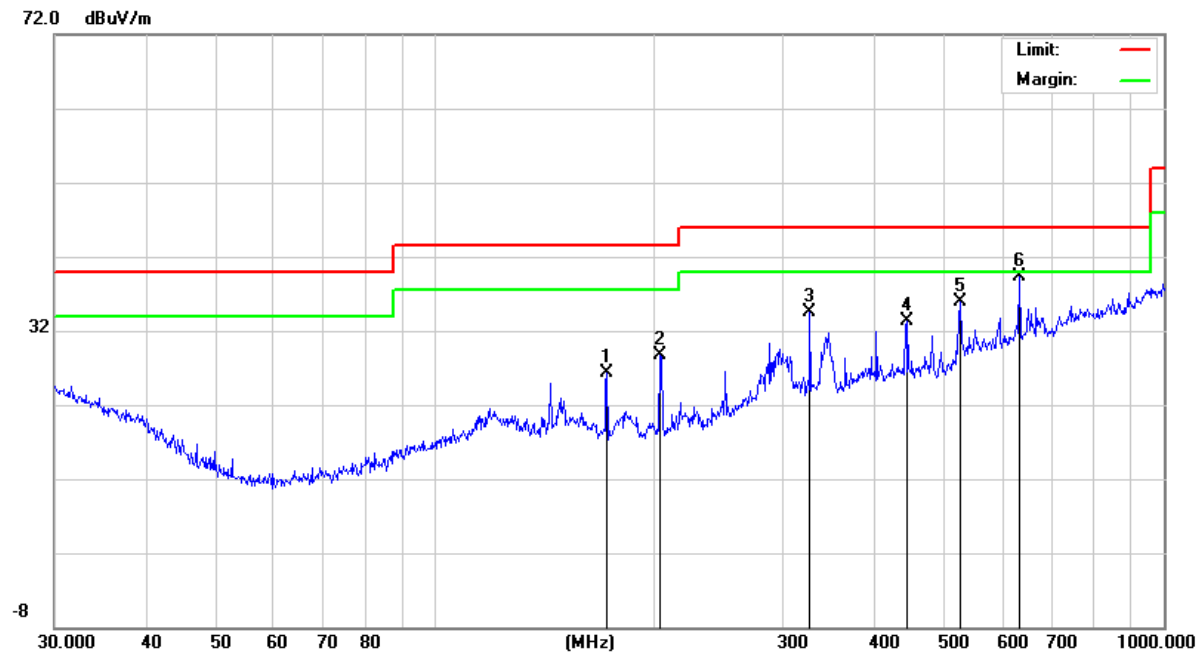

3.2.8 TEST RESULTS (1GHz-18GHz)

EUT :	8-Inch Fully Ruggedized Tablet	Model Name :	SV-86
Temperature :	20 °C	Relative Humidity :	48%
Pressure :	1010 hPa	Test Voltage :	DC 3.7V
Test Mode :	TX -802.11N(20) 5180MHz~5240MHz		

Polar	Frequency	Meter Reading	Cable loss	Antenna Factor	Preamp Factor	Emission Level	Limits	Margin	Detector Type
(H/V)	(MHz)	(dBuV)	(dB)	dB/m	(dB)	(dBuV/m)	(dBuV/m)	(dB)	
Low Channel (5180 MHz)-Above 1G									
Vertical	4434.127	56.45	5.94	35.40	44.00	53.79	74.00	-20.21	Pk
Vertical	4434.127	43.59	5.94	35.40	44.00	40.93	54.00	-13.07	AV
Vertical	10370.24	53.74	8.46	39.75	44.50	57.45	74.00	-16.55	Pk
Vertical	10370.24	43.53	8.46	39.75	44.50	47.24	54.00	-6.76	AV
Vertical	15540.12	51.53	10.12	38.80	44.10	56.35	74.00	-17.65	Pk
Vertical	15540.12	43.04	10.12	38.80	42.70	49.26	54.00	-4.74	AV
Horizontal	4434.238	49.47	5.94	35.18	44.00	46.59	74.00	-27.41	Pk
Horizontal	4434.238	43.71	5.94	35.18	44.00	40.83	54.00	-13.17	AV
Horizontal	10370.12	56.21	8.46	38.71	44.50	58.88	74.00	-15.12	Pk
Horizontal	10730.12	43.91	8.46	38.71	44.50	46.58	54.00	-7.42	AV
Horizontal	15540.28	54.57	10.12	38.38	44.10	58.97	74.00	-15.03	Pk
Horizontal	15540.28	42.56	10.12	38.38	44.10	46.96	54.00	-7.04	AV
middle Channel (5200 MHz)-Above 1G									
Vertical	4592.232	51.55	6.48	36.35	44.05	50.33	74.00	-23.67	Pk
Vertical	4592.232	43.49	6.48	36.35	44.05	42.27	54.00	-11.73	AV
Vertical	10401.22	50.63	8.47	37.88	44.51	52.47	74.00	-21.53	Pk
Vertical	10401.22	42.62	8.47	37.88	44.51	44.46	54.00	-9.54	AV
Vertical	15600.17	50.93	10.12	38.8	44.10	55.75	74.00	-18.25	Pk
Vertical	15600.17	40.20	10.12	38.8	42.70	46.42	54.00	-7.58	AV
Horizontal	4592.416	50.19	6.48	36.37	44.05	48.99	74.00	-25.01	Pk
Horizontal	4592.416	41.81	6.48	36.37	44.05	40.61	54.00	-13.39	AV
Horizontal	10400.16	53.15	8.47	38.64	44.50	55.76	74.00	-18.24	Pk
Horizontal	10400.16	40.36	8.47	38.64	44.50	42.97	54.00	-11.03	AV
Horizontal	15600.18	49.81	10.12	38.38	44.10	54.21	74.00	-19.79	Pk
Horizontal	15600.18	42.06	10.12	38.38	44.10	46.46	54.00	-7.54	AV
High Channel (5240 MHz)-Above 1G									
Vertical	4739.218	53.30	7.10	37.24	43.50	54.14	74.00	-19.86	Pk
Vertical	4739.218	42.34	7.10	37.24	43.50	43.18	54.00	-10.82	AV
Vertical	10480.27	53.43	8.46	37.68	44.50	55.07	74.00	-18.93	Pk
Vertical	10480.27	43.58	8.46	37.68	44.50	45.22	54.00	-8.78	AV
Vertical	15720.13	54.11	10.12	38.8	44.10	58.93	74.00	-15.07	Pk
Vertical	15720.13	42.66	10.12	38.8	42.70	48.88	54.00	-5.12	AV
Horizontal	4739.154	53.95	7.10	37.24	43.50	54.79	74.00	-19.21	Pk
Horizontal	4739.154	40.23	7.10	37.24	43.50	41.07	54.00	-12.93	AV
Horizontal	10481.62	52.55	8.46	38.57	44.50	55.08	74.00	-18.92	Pk
Horizontal	10481.62	42.11	8.46	38.57	44.50	44.64	54.00	-9.36	AV
Horizontal	15720.25	50.04	10.12	38.38	44.10	54.44	74.00	-19.56	Pk
Horizontal	15720.25	41.04	10.12	38.38	44.10	45.44	54.00	-8.56	AV

Note: "802.11N(20)(5G)" mode is the worst mode. PK value is lower than the Average value limit, So average didn't record.

The amplitude of spurious emissions that are attenuated by more than 20dB below the permissible value has no need to be reported.

Emission level (dBuV/m) = 20 log Emission level (uV/m).

Corrected Reading: Antenna Factor + Cable Loss + Read Level - Preamp Factor = Level.

TEST RESULTS (18GHz-40GHz)

EUT :	8-Inch Fully Ruggedized Tablet	Model Name :	SV-86
Temperature :	20 °C	Relative Humidity :	48%
Pressure :	1010 hPa	Test Voltage :	DC 3.7V
Test Mode :	TX (5.2G)-802.11N(20) 5180MHz~5240MHz , TX (5.8G) -802.11N(20) 5745MHz~5825MHz		

All the modulation modes have been tested, and the worst result was report as below:
 Channel (5180 MHz) 18-26.5G

Horizontal

FCC Electric Field Strength 18-26.5GHz

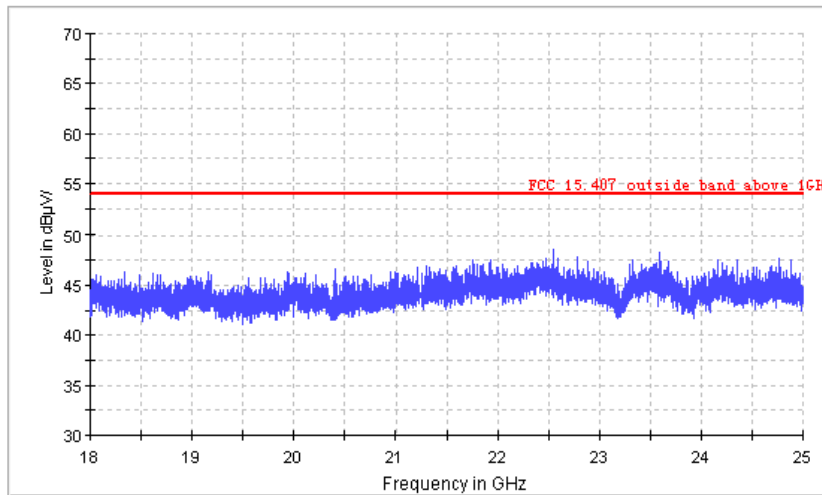

Vertical

FCC Electric Field Strength 18-26.5GHz

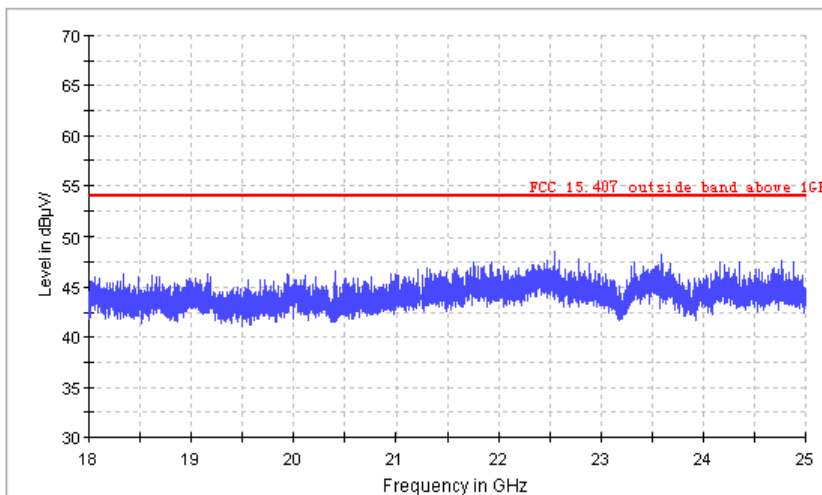

Channel (5180 MHz) 26.5-40G

Horizontal

FCC Electric Field Strength 26.5-40GHz

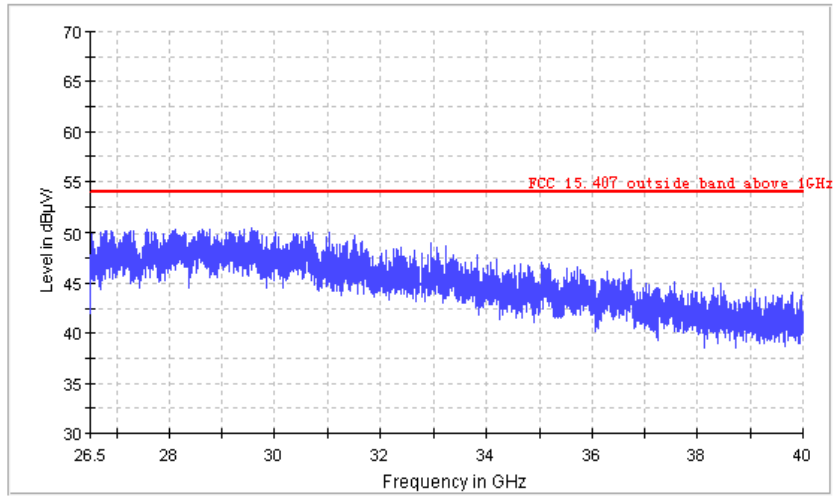

Vertical

FCC Electric Field Strength 26.5-40GHz

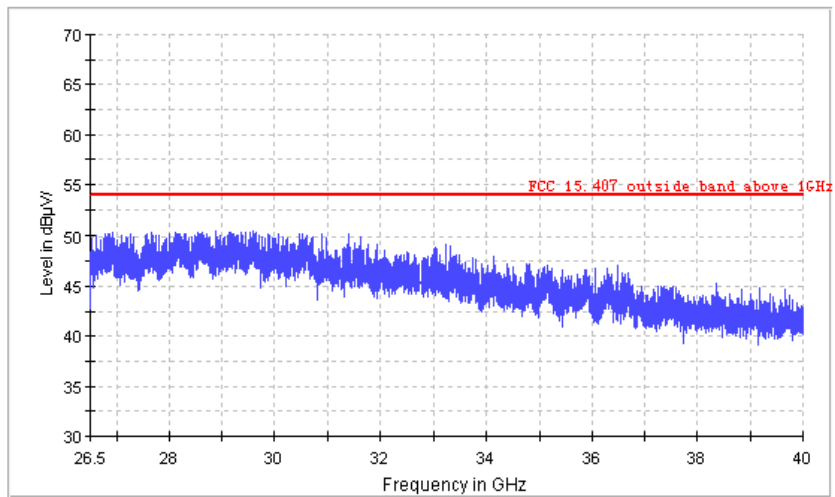

Channel (5745 MHz) 18-26.5G

Horizontal

FCC Electric Field Strength 18-26.5GHz

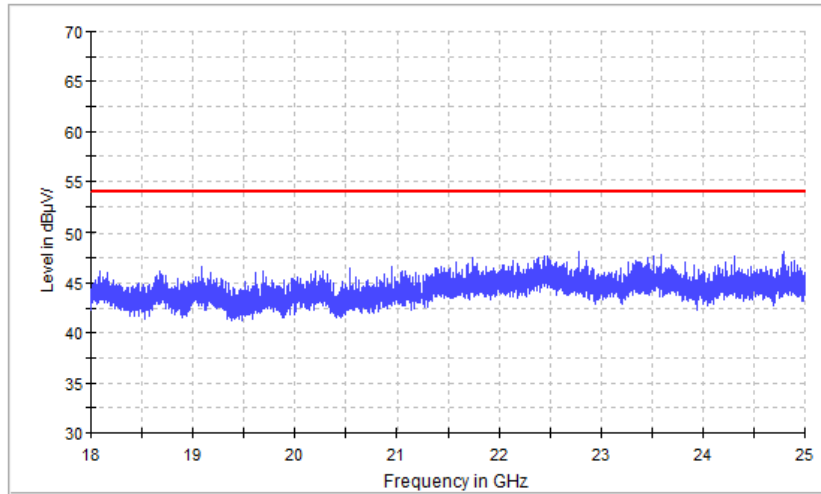

Vertical

FCC Electric Field Strength 18-26.5GHz

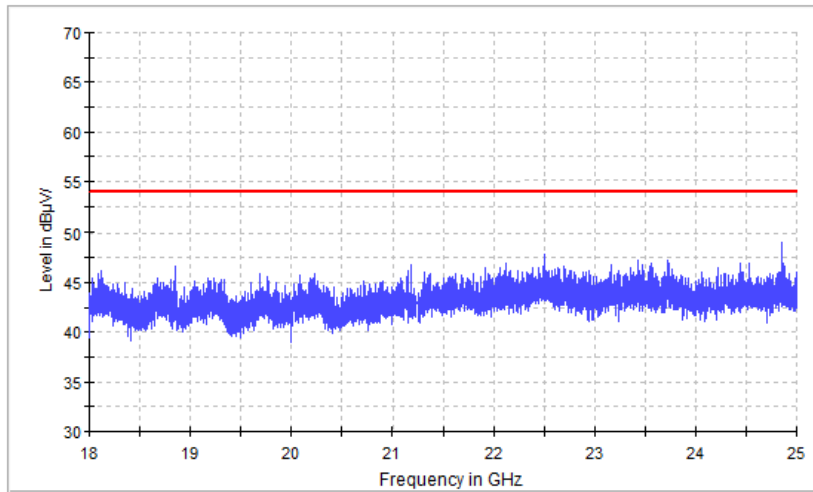

Channel (5745 MHz) 26.5-40G

Horizontal

FCC Electric Field Strength 26.5-40GHz

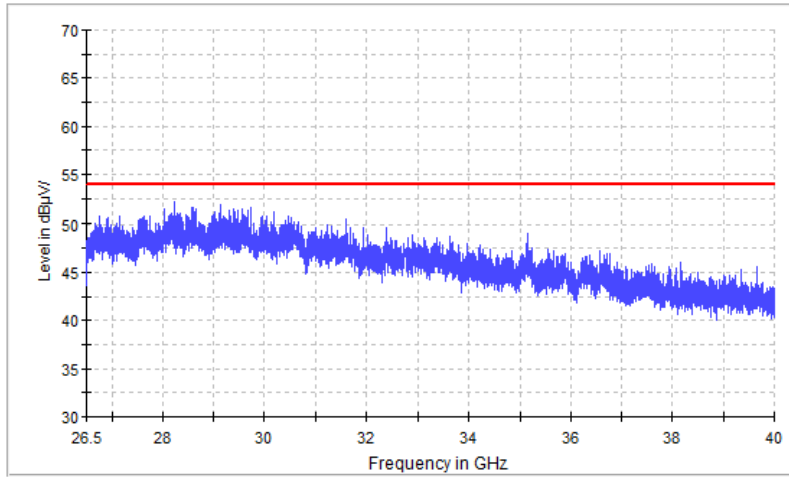

Vertical

FCC Electric Field Strength 26.5-40GHz

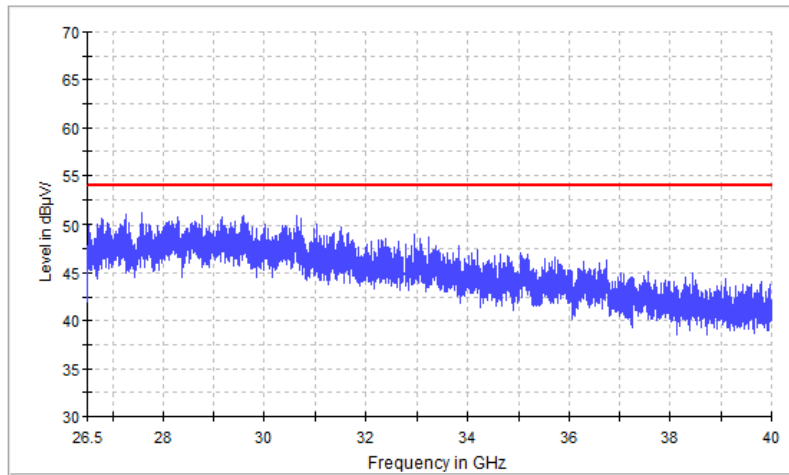

4. POWER SPECTRAL DENSITY TEST

4.1 APPLIED PROCEDURES / LIMIT

According to FCC §15.407(a)(3)

For the band 5.15-5.25 GHz,

(i) For an outdoor access point operating in the band 5.15-5.25 GHz, the maximum power spectral density shall not exceed 17 dBm in any 1 megahertz band. If transmitting antennas of directional gain greater than 6 dBi are used, both the maximum conducted output power and the maximum power spectral density shall be reduced by the amount in dB that the directional gain of the antenna exceeds 6 dBi. The maximum e.i.r.p. at any elevation angle above 30 degrees as measured from the horizon must not exceed 125 mW (21 dBm).

(ii) For an indoor access point operating in the band 5.15-5.25 GHz, the maximum power spectral density shall not exceed 17 dBm in any 1 megahertz band. If transmitting antennas of directional gain greater than 6 dBi are used, both the maximum conducted output power and the maximum power spectral density shall be reduced by the amount in dB that the directional gain of the antenna exceeds 6 dBi.

(iii) For fixed point-to-point access points operating in the band 5.15-5.25 GHz, the maximum power spectral density shall not exceed 17 dBm in any 1 megahertz band. Fixed point-to-point U-NII devices may employ antennas with directional gain up to 23 dBi without any corresponding reduction in the maximum conducted output power or maximum power spectral density. For fixed point-to-point transmitters that employ a directional antenna gain greater than 23 dBi, a 1 dB reduction in maximum conducted output power and maximum power spectral density is required for each 1 dB of antenna gain in excess of 23 dBi. Fixed, point-to-point operations exclude the use of point-to-multipoint systems, omnidirectional applications, and multiple collocated transmitters transmitting the same information. The operator of the U-NII device, or if the equipment is professionally installed, the installer, is responsible for ensuring that systems employing high gain directional antennas are used exclusively for fixed, point-to-point operations.

(iv) For mobile and portable client devices in the 5.15-5.25 GHz band, the maximum power spectral density shall not exceed 11 dBm in any 1 megahertz band. If transmitting antennas of directional gain greater than 6 dBi are used, both the maximum conducted output power and the maximum power spectral density shall be reduced by the amount in dB that the directional gain of the antenna exceeds 6 dBi.

For the band 5.725-5.85 GHz

(3) For the band 5.725-5.85 GHz, the maximum power spectral density shall not exceed 30 dBm in any 500-kHz band. If transmitting antennas of directional gain greater than 6 dBi are used, both the maximum conducted output power and the maximum power spectral density shall be reduced by the amount in dB that the directional gain of the antenna exceeds 6 dBi.

4.2 TEST PROCEDURE

For devices operating in the bands 5.15-5.25 GHz, 5.25-5.35 GHz, and 5.47-5.725 GHz, the above procedures make use of 1 MHz RBW to satisfy directly the 1 MHz reference bandwidth specified in § 15.407(a)(5). For devices operating in the band 5.725-5.85 GHz, the rules specify a measurement bandwidth of 500 kHz. Many spectrum analyzers do not have 500 kHz RBW, thus a narrower RBW may need to be used. The rules permit the use of a RBWs less than 1 MHz, or 500 kHz, “provided that the measured power is integrated over the full reference bandwidth” to show the total power over the specified measurement bandwidth (i.e., 1 MHz, or 500 kHz). If measurements are performed using a reduced resolution bandwidth (< 1 MHz, or < 500 kHz) and integrated over 1 MHz, or 500 KHz bandwidth, the following adjustments to the procedures apply:

- a) Set $RBW \geq 1/T$, where T is defined in section II.B.I.a).
- b) Set $VBW \geq 3 RBW$.
- c) If measurement bandwidth of Maximum PSD is specified in 500 kHz, add $10\log(500\text{kHz}/RBW)$ to the measured result, whereas $RBW (< 500 \text{ KHz})$ is the reduced resolution bandwidth of the spectrum analyzer set during measurement.
- d) If measurement bandwidth of Maximum PSD is specified in 1 MHz, add $10\log(1\text{MHz}/RBW)$ to the measured result, whereas $RBW (< 1 \text{ MHz})$ is the reduced resolution bandwidth of spectrum analyzer set during measurement.
- e) Care must be taken to ensure that the measurements are performed during a period of continuous transmission or are corrected upward for duty cycle.

Note: As a practical matter, it is recommended to use reduced RBW of 100 KHz for the sections 5.c) and 5.d) above, since $RBW=100 \text{ KHZ}$ is available on nearly all spectrum analyzers.

4.3 DEVIATION FROM STANDARD

No deviation.

4.4 TEST SETUP

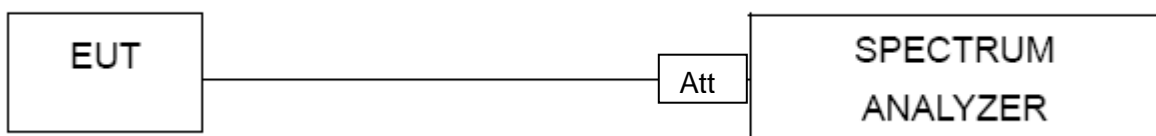

4.5 EUT OPERATION CONDITIONS

The EUT tested system was configured as the statements of 2.1 Unless otherwise a special operating condition is specified in the follows during the testing.

4.6 TEST RESULTS

EUT :	8-Inch Fully Ruggedized Tablet	Model Name :	SV-86
Temperature :	25 °C	Relative Humidity :	56%
Pressure :	1015 hPa	Test Voltage :	DC 3.7V
Test Mode :	TX Frequency (5150-5250MHz)		

Mode	Frequency	Measured Power Density (dBm)	Limit (dBm)	Result
802.11 a	5185 MHz	4.86	11	PASS
	5200 MHz	4.75	11	PASS
	5240 MHz	5.22	11	PASS
802.11 n20	5185 MHz	1.39	11	PASS
	5200 MHz	1.39	11	PASS
	5240 MHz	2.56	11	PASS
802.11 n40	5190 MHz	-0.44	11	PASS
	5230 MHz	-0.15	11	PASS
802.11 AC20	5185 MHz	1.05	11	PASS
	5200 MHz	0.93	11	PASS
	5240 MHz	1.69	11	PASS
802.11 AC40	5190 MHz	-3.20	11	PASS
	5230 MHz	-2.26	11	PASS
802.11 AC80	5210 MHz	-8.69	11	PASS

Note: 1. Calculate power density= Measured Power Density+10log(1MHz/RBW)
 RBW=1MHz

(802.11a) PSD plot on channel 36

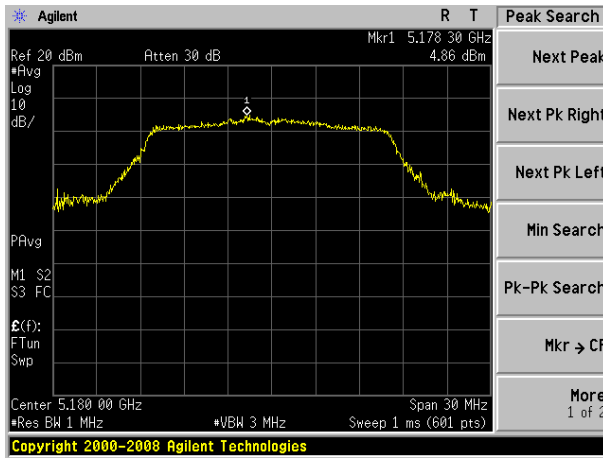

(802.11n20) PSD plot on channel 36

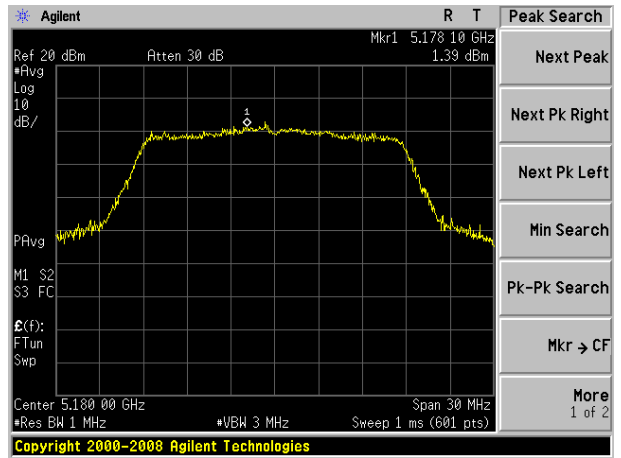

(802.11a) PSD plot on channel 40

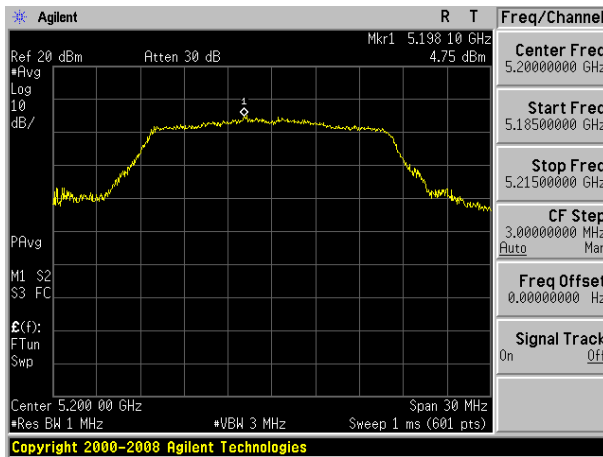

(802.11n20) PSD plot on channel 40

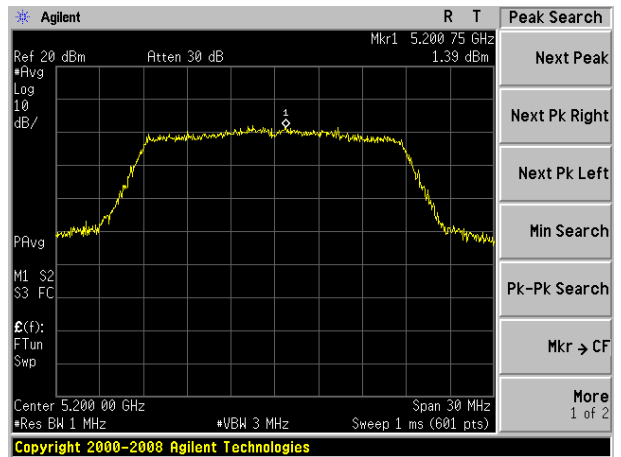

(802.11a) PSD plot on channel 48

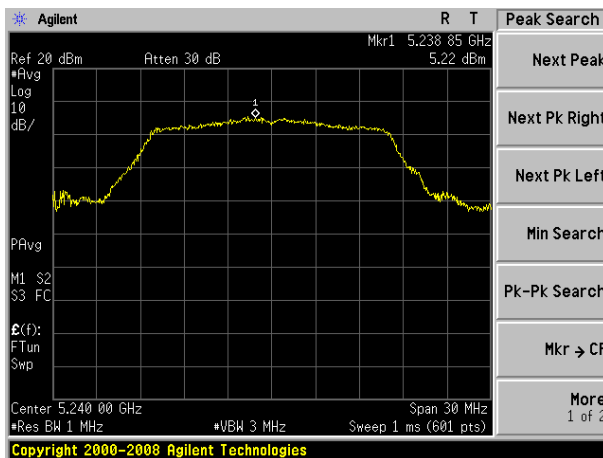

(802.11n20) PSD plot on channel 48

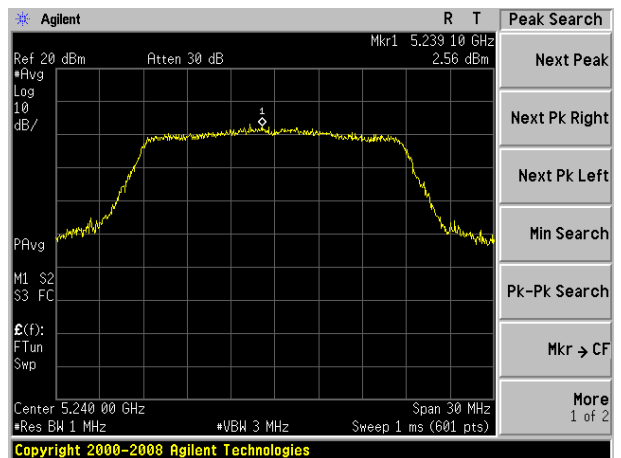

(802.11n40) PSD plot on channel 38

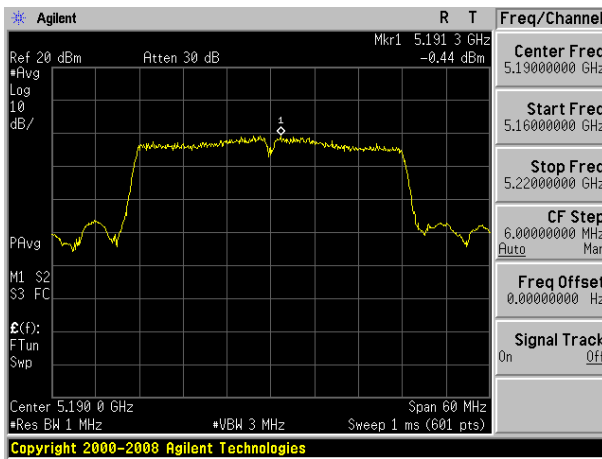

(802.11ac20) PSD plot on channel 36

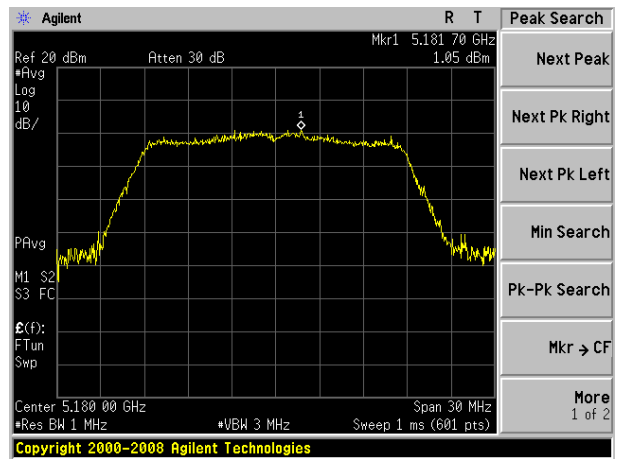

(802.11n40) PSD plot on channel 46

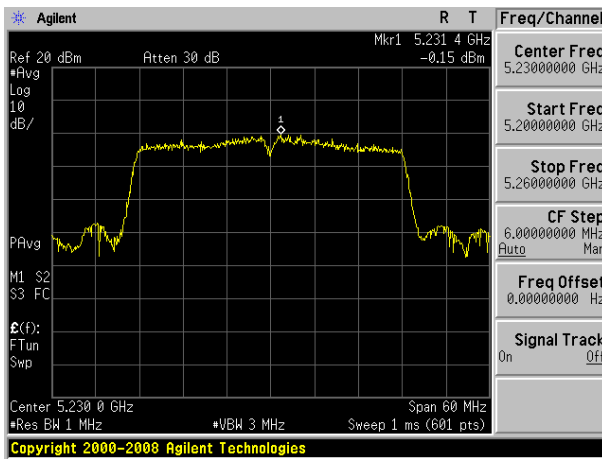

(802.11ac20) PSD plot on channel 40

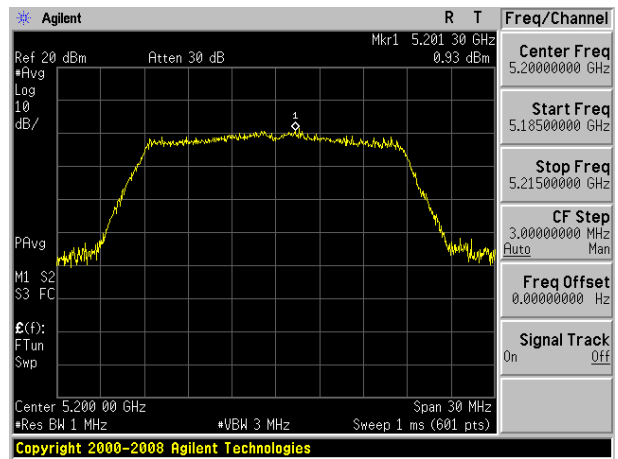

(802.11ac20) PSD plot on channel 48

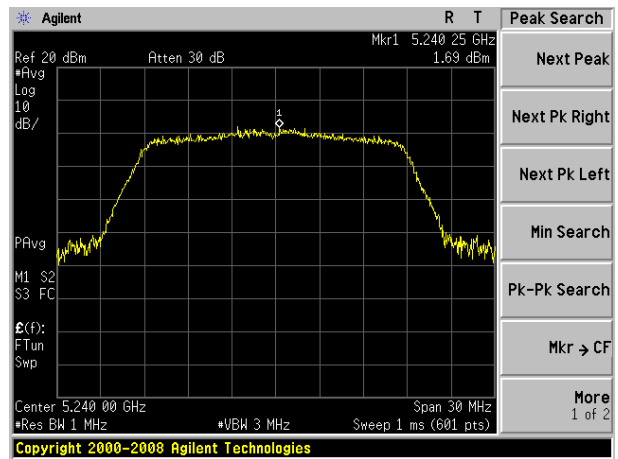

(802.11ac40) PSD plot on channel 38

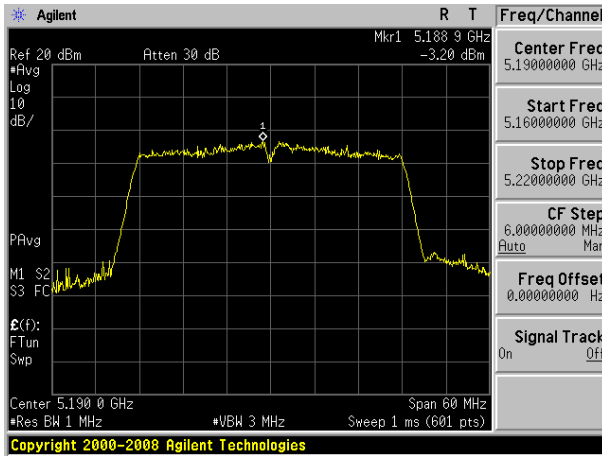

(802.11ac80) PSD plot on channel 42

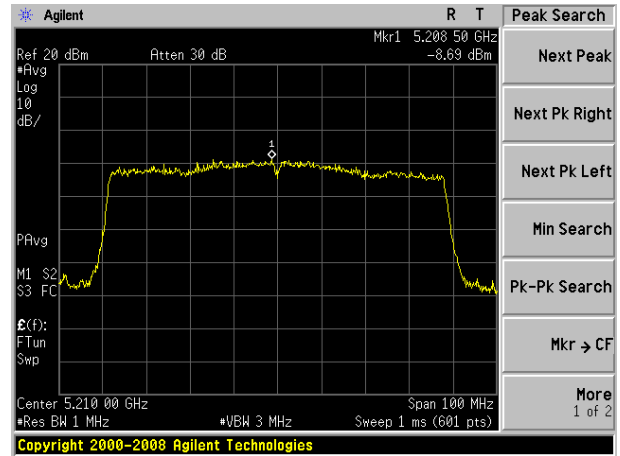

(802.11ac40) PSD plot on channel 46

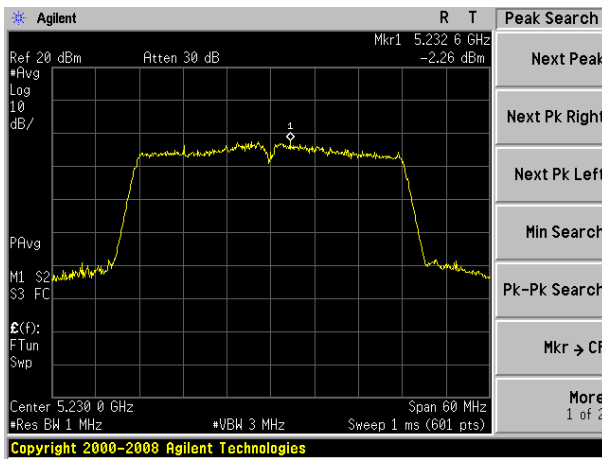

EUT :	8-Inch Fully Ruggedized Tablet	Model Name :	SV-86
Temperature :	25 °C	Relative Humidity :	56%
Pressure :	1015 hPa	Test Voltage :	DC 3.7V
Test Mode :	TX Frequency (5725-5825MHz)		

Mode	Frequency	Measured Power Density(dBm)	Factor (dBm)	Calculate power density (dBm)	Limit (dBm)	Result
		ANT A				
802.11 a	5745 MHz	-1.763	2.924	5.62	30	PASS
	5785 MHz	-2.079	2.924	5.55	30	PASS
	5825 MHz	-2.376	2.924	4.82	30	PASS
802.11 n20	5745 MHz	-2.658	2.924	1.85	30	PASS
	5785 MHz	-3.313	2.924	2.10	30	PASS
	5825 MHz	-4.297	2.924	2.36	30	PASS
802.11 n40	5755 MHz	-6.652	2.924	-0.99	30	PASS
	5795 MHz	-6.524	2.924	-1.29	30	PASS
802.11 AC20	5745 MHz	-2.582	2.924	2.74	30	PASS
	5785 MHz	-2.184	2.924	2.31	30	PASS
	5825 MHz	-3.504	2.924	1.06	30	PASS
802.11 AC40	5755 MHz	-5.968	2.924	-3.65	30	PASS
	5795 MHz	-6.608	2.924	-2.54	30	PASS
802.11 AC80	5775 MHz	-7.427	2.924	-8.63	30	PASS

Note:

- (1) Calculate power density= Measured Power Density+10log(1MHz/RBW)
RBW=0.51MHz

(802.11a) PSD plot on channel 149

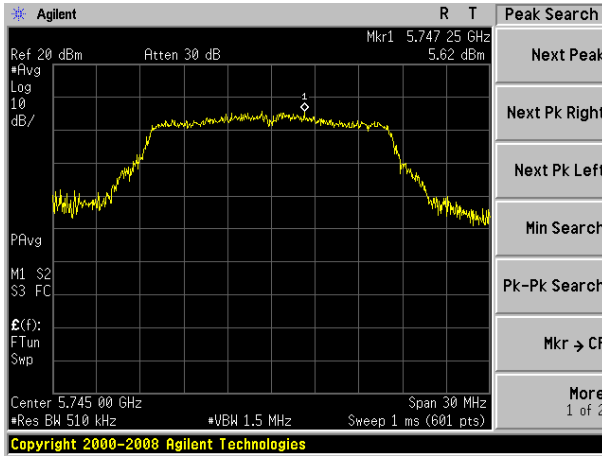

(802.11n20) PSD plot on channel 149

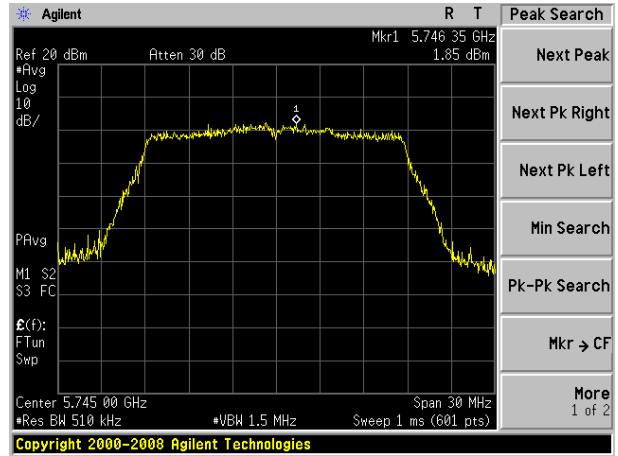

(802.11a) PSD plot on channel 157

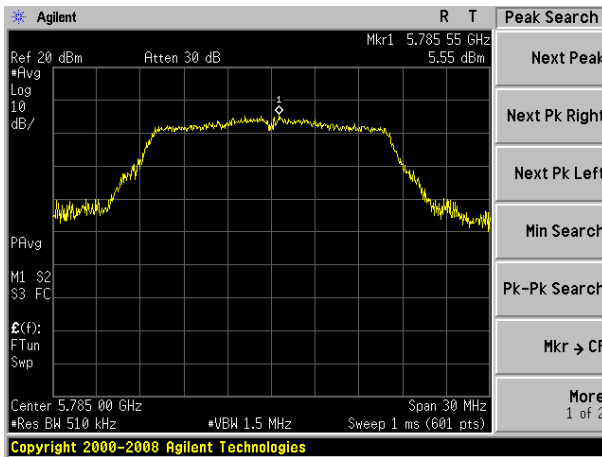

(802.11n20) PSD plot on channel 157

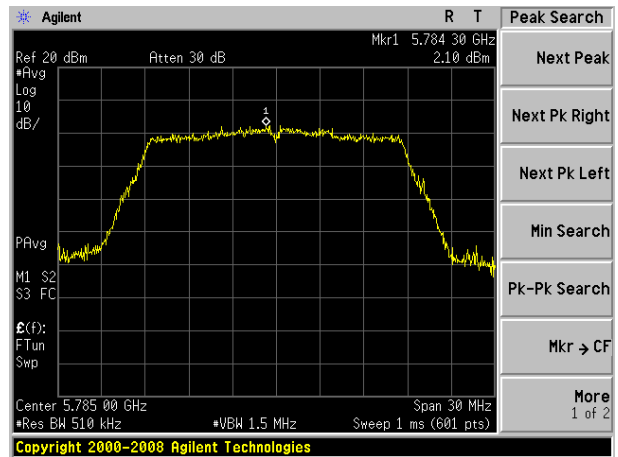

(802.11a) PSD plot on channel 165

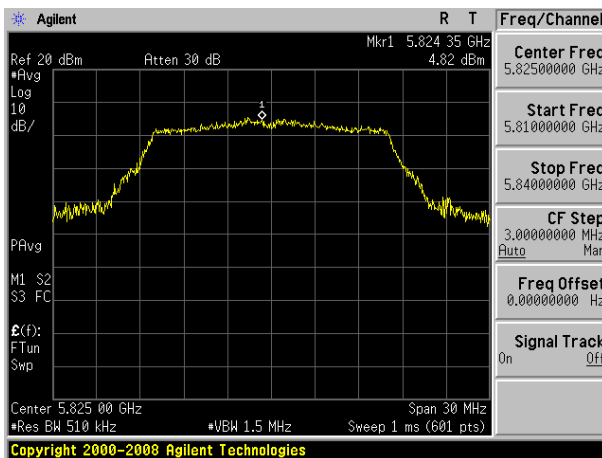

(802.11n20) PSD plot on channel 165

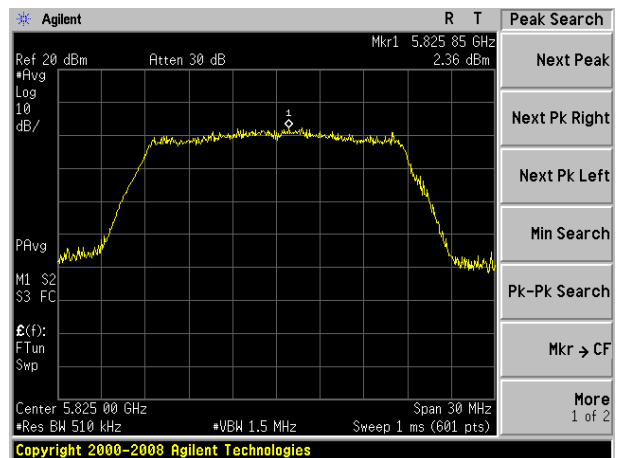

(802.11n40) PSD plot on channel 151

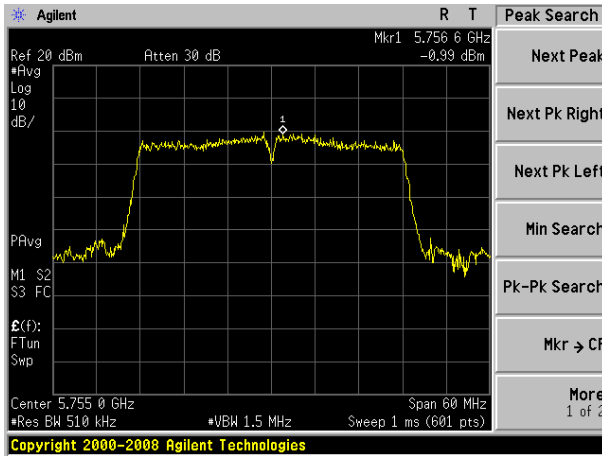

(802.11ac20) PSD plot on channel 149

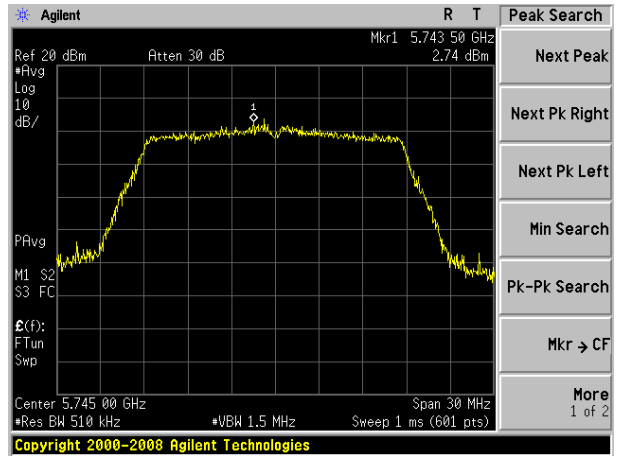

(802.11n40) PSD plot on channel 159

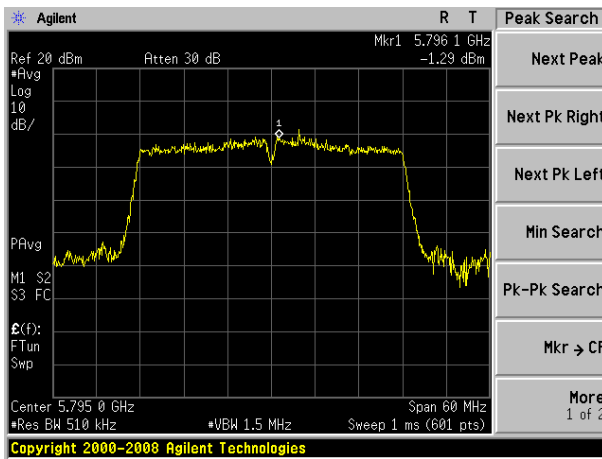

(802.11ac20) PSD plot on channel 157

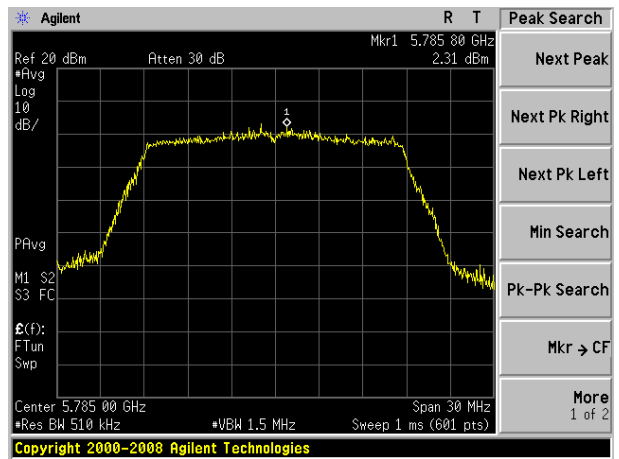

(802.11ac20) PSD plot on channel 165

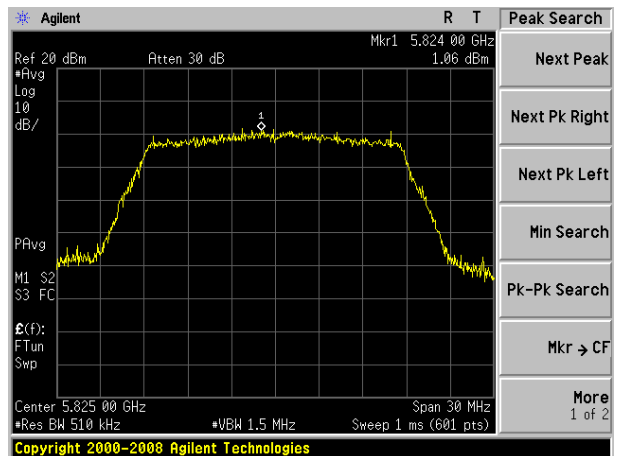

(802.11ac40) PSD plot on channel 151

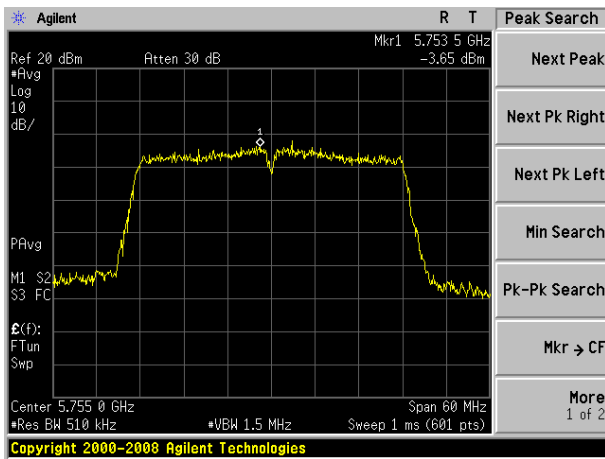

(802.11ac80) PSD plot on channel 155

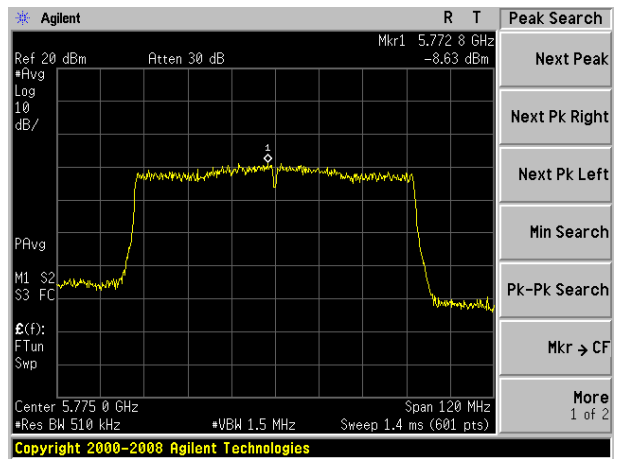

(802.11ac40) PSD plot on channel 159

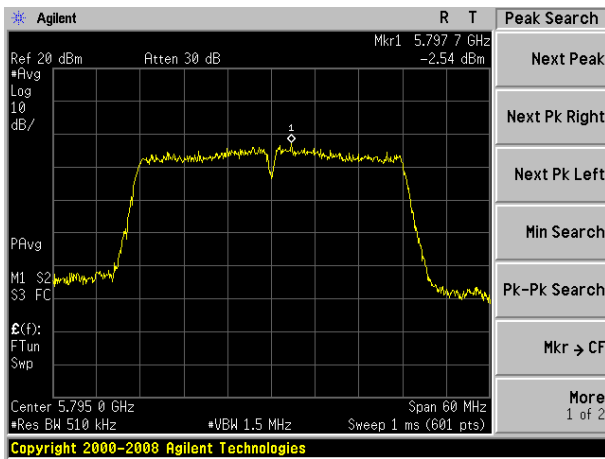

5. 26 DB & 99% EMISSION BANDWIDTH

5.1 APPLIED PROCEDURES / LIMIT

The maximum power spectral density is measured as a conducted emission by direct connection of a calibrated test instrument to the equipment under test. If the device cannot be connected directly, alternative techniques acceptable to the Commission may be used. Measurements in the 5.725-5.85 GHz band are made over a reference bandwidth of 500 kHz or the 26 dB emission bandwidth of the device, whichever is less. Measurements in the 5.15-5.25 GHz, 5.25-5.35 GHz, and the 5.47-5.725 GHz bands are made over a bandwidth of 1 MHz or the 26 dB emission bandwidth of the device, whichever is less. A narrower resolution bandwidth can be used, provided that the measured power is integrated over the full reference bandwidth.

5.2 TEST PROCEDURE

- a) Set RBW = approximately 1% of the emission bandwidth.
- b) Set the VBW > RBW.
- c) Detector = Peak.
- d) Trace mode = max hold.
- e) Measure the maximum width of the emission that is 26 dB down from the maximum of the emission. Compare this with the RBW setting of the analyzer. Readjust RBW and repeat measurement as needed until the RBW/EBW ratio is approximately 1%.

The following procedure shall be used for measuring (99 %) power bandwidth:

1. Set center frequency to the nominal EUT channel center frequency.
2. Set span = 1.5 times to 5.0 times the OBW.
3. Set RBW = 1 % to 5 % of the OBW
4. Set VBW $\geq 3 \cdot$ RBW
5. Video averaging is not permitted. Where practical, a sample detection and single sweep mode shall be used. Otherwise, peak detection and max hold mode (until the trace stabilizes) shall be used.
6. Use the 99 % power bandwidth function of the instrument (if available).
7. If the instrument does not have a 99 % power bandwidth function, the trace data points are recovered and directly summed in power units. The recovered amplitude data points, beginning at the lowest frequency, are placed in a running sum until 0.5 % of the total is reached; that frequency is recorded as the lower frequency. The process is repeated until 99.5 % of the total is reached; that frequency is recorded as the upper frequency. The 99% occupied bandwidth is the difference between these two frequencies.

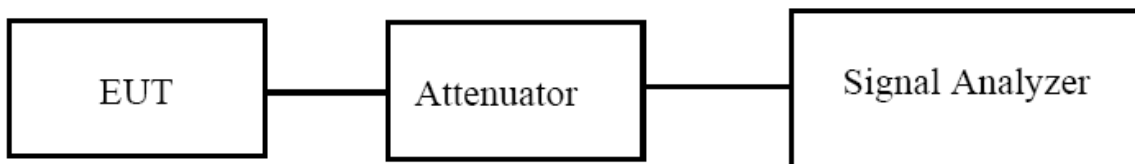

5.3 EUT OPERATION CONDITIONS

The EUT tested system was configured as the statements of 2.4 Unless otherwise a special operating condition is specified in the follows during the testing.

5.4 TEST RESULTS

EUT :	8-Inch Fully Ruggedized Tablet	Model Name :	SV-86
Temperature :	25 °C	Relative Humidity :	56%
Pressure :	1012 hPa	Test Voltage :	DC 3.7V
Test Mode :	TX Frequency (5150-5250MHz)		

Mode	Channel	Frequency (MHz)	99% bandwidth (MHz)	26dB bandwidth (MHz)	Result
802.11a	CH36	5180	17.3594	29.037	Pass
	CH40	5200	17.3847	27.621	Pass
	CH48	5240	17.3632	27.556	Pass
802.11 n20	CH36	5180	17.9005	21.593	Pass
	CH40	5200	17.9139	21.419	Pass
	CH48	5240	17.8857	21.472	Pass
802.11 n40	CH 38	5190	36.1393	39.311	Pass
	CH 46	5230	36.1495	39.231	Pass
802.11 AC20	CH36	5180	17.8910	21.290	Pass
	CH40	5200	17.8672	21.405	Pass
	CH48	5240	17.8617	21.412	Pass
802.11 AC40	CH 38	5190	36.1968	39.608	Pass
	CH 46	5230	36.2717	39.655	Pass
802.11 AC80	CH 42	5210	75.4273	79.340	Pass

(802.11a) -26dB&99% Bandwidth plot on channel 36

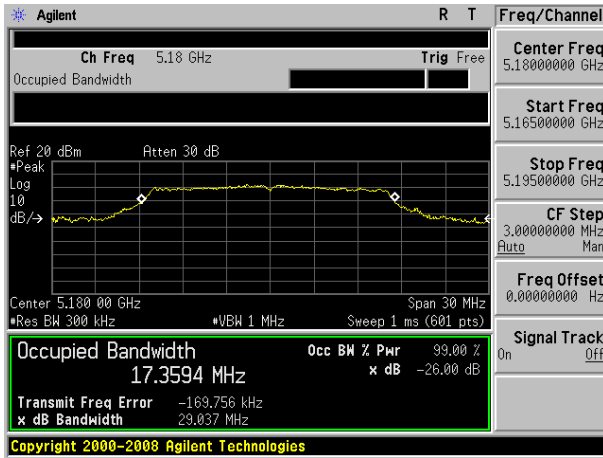

(802.11n20) -26dB&99% Bandwidth plot on channel 36

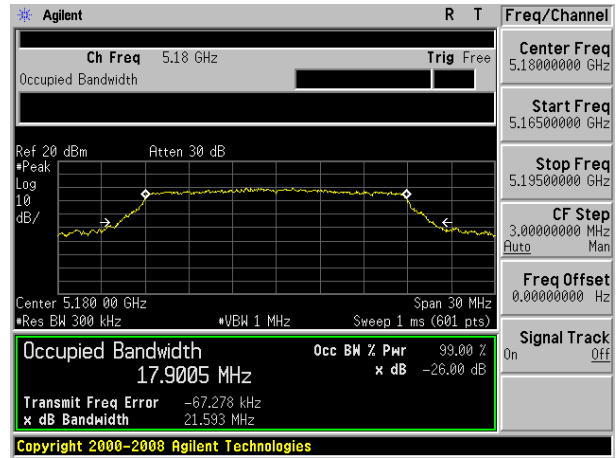

(802.11a) -26dB&99% Bandwidth plot on channel 40

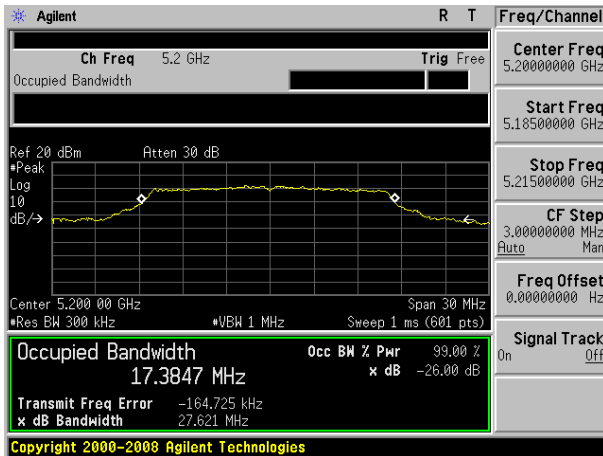

(802.11n20) -26dB&99% Bandwidth plot on channel 40

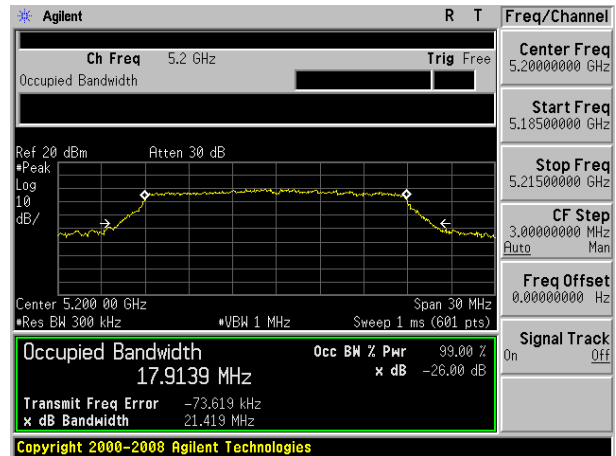

(802.11a) -26dB&99% Bandwidth plot on channel 48

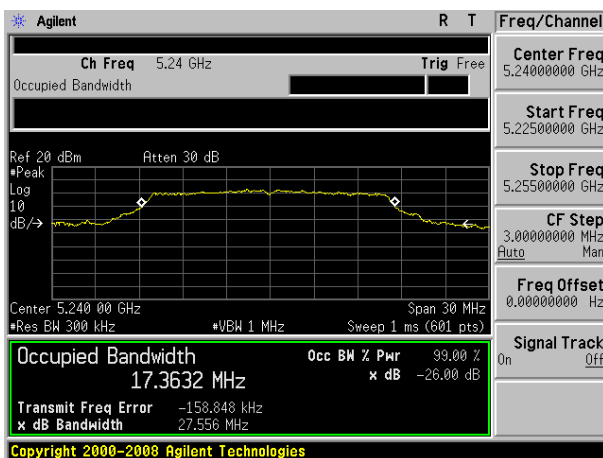

(802.11n20) -26dB&99% Bandwidth plot on channel 48

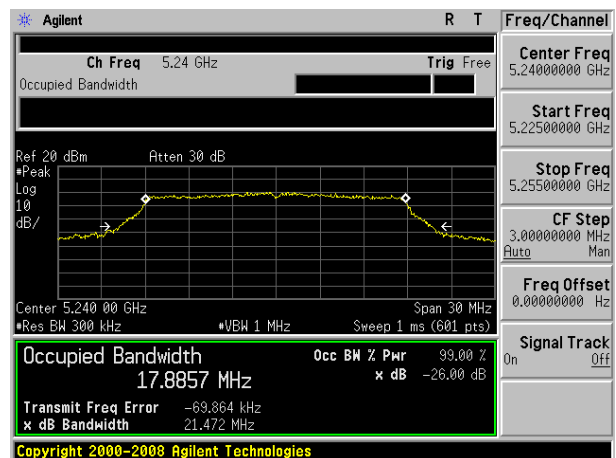

(802.11n40) -26dB&99% Bandwidth plot on channel 38

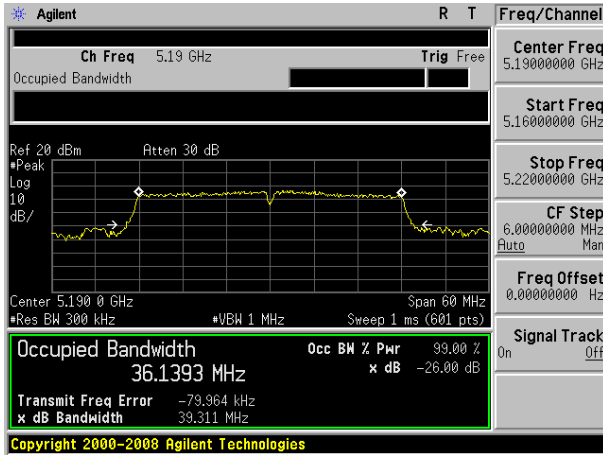

(802.11ac20) -26dB&99% Bandwidth plot on channel 36

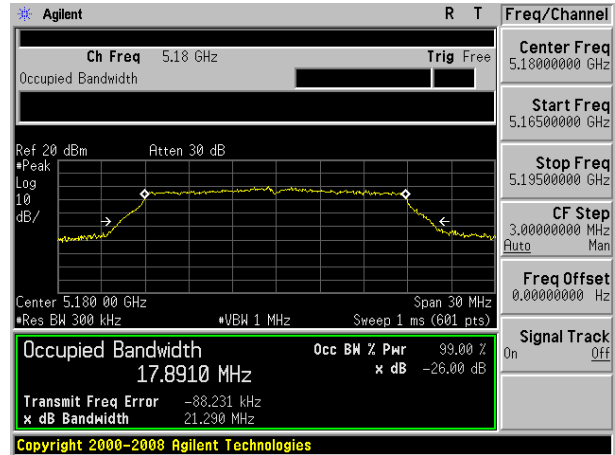

(802.11n40) -26dB&99% Bandwidth plot on channel 46

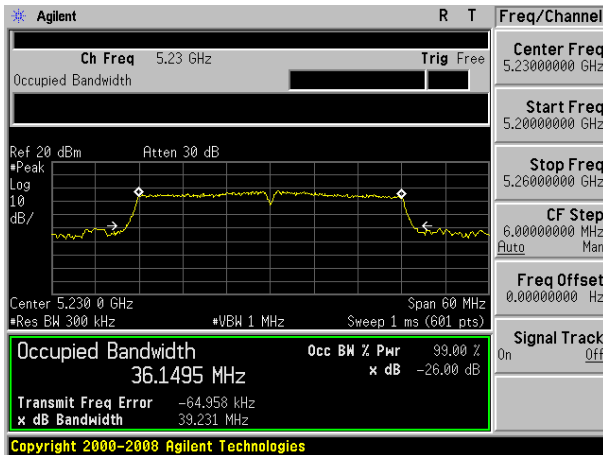

(802.11ac20) -26dB&99% Bandwidth plot on channel 40

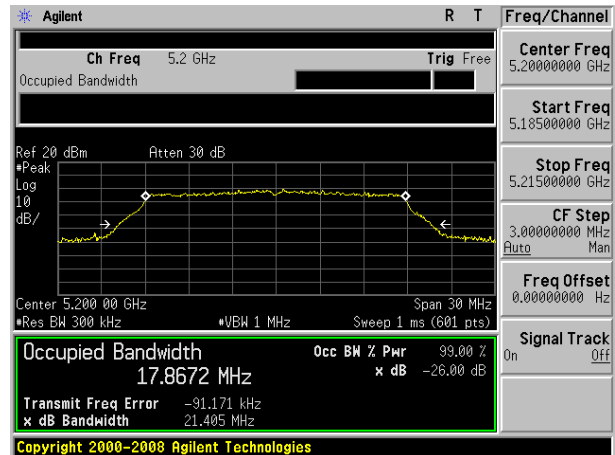

(802.11ac20) -26dB&99% Bandwidth plot on channel 48

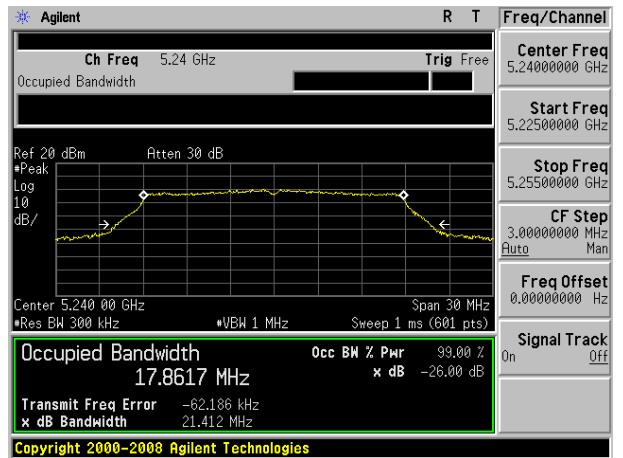

(802.11ac40) -26dB&99% Bandwidth plot on channel 38

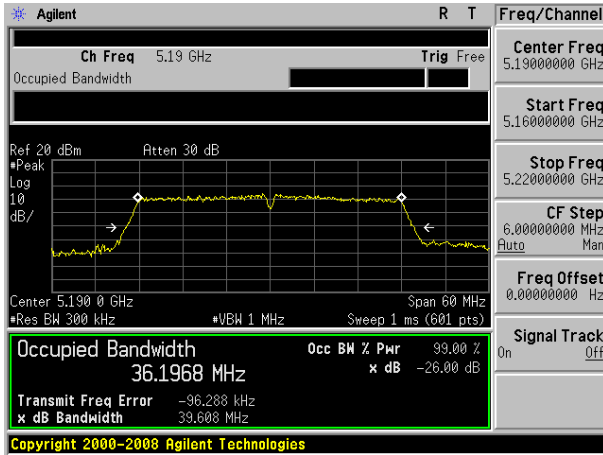

(802.11ac80) -26dB&99% Bandwidth plot on channel 42

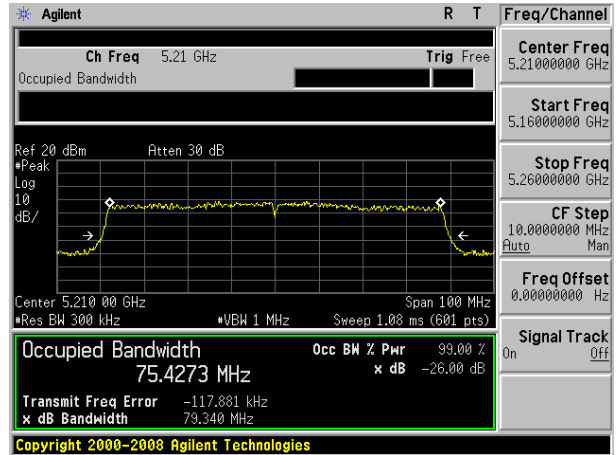

(802.11ac40) -26dB&99% Bandwidth plot on channel 46

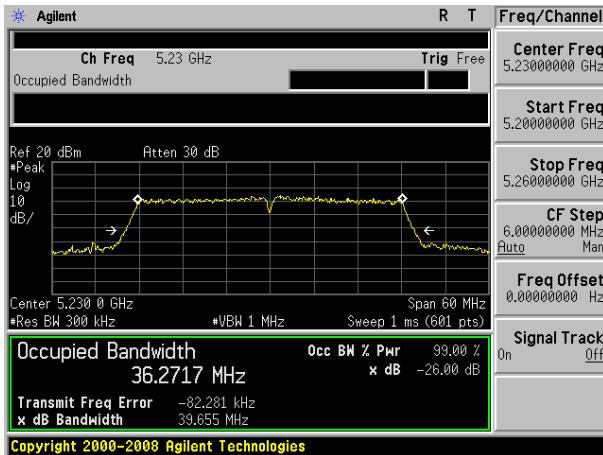

EUT :	8-Inch Fully Ruggedized Tablet	Model Name :	SV-86
Temperature :	25 °C	Relative Humidity :	56%
Pressure :	1012 hPa	Test Voltage :	DC 3.7V
Test Mode :	TX Frequency (5745-5850MHz)		

Mode	Channel	Frequency (MHz)	99% bandwidth (MHz)	26dB bandwidth (MHz)	Result
802.11a	CH149	5745	17.0812	21.874	Pass
	CH157	5785	17.0349	23.295	Pass
	CH165	5825	17.1226	25.513	Pass
802.11 n20	CH149	5745	17.8853	21.533	Pass
	CH157	5785	17.9054	21.302	Pass
	CH165	5825	17.8515	21.421	Pass
802.11 n40	CH151	5755	36.1396	39.117	Pass
	CH159	5795	36.1298	38.754	Pass
802.11 AC20	CH149	5745	17.8599	21.435	Pass
	CH157	5785	17.9057	21.368	Pass
	CH165	5825	17.8651	21.379	Pass
802.11 AC40	CH151	5755	36.2778	39.545	Pass
	CH159	5795	36.2040	39.468	Pass
802.11 AC80	CH155	5775	75.4430	79.793	Pass

(802.11a) -26dB&99% Bandwidth plot on channel 149

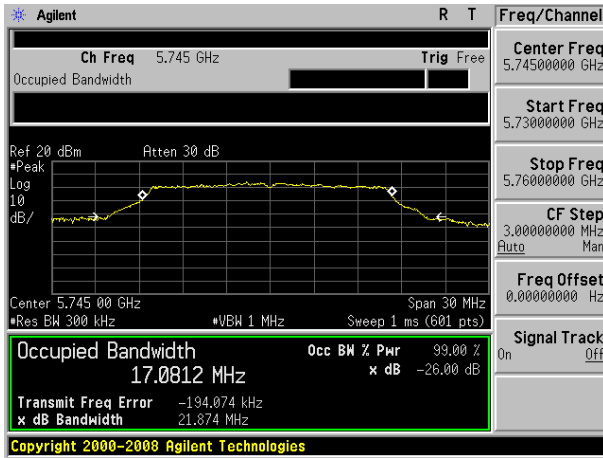

(802.11n20) -26dB&99% Bandwidth plot on channel 149

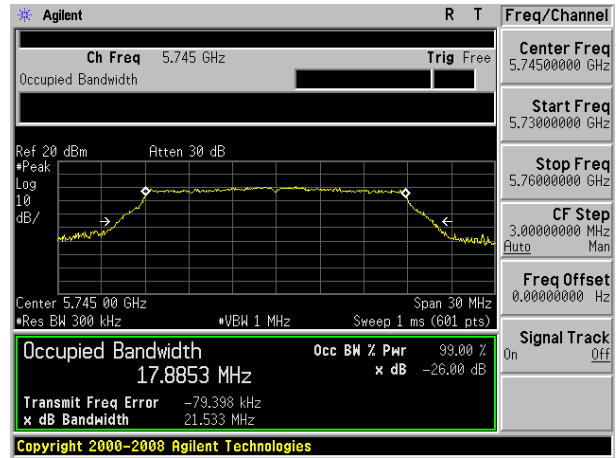

(802.11a) -26dB&99% Bandwidth plot on channel 157

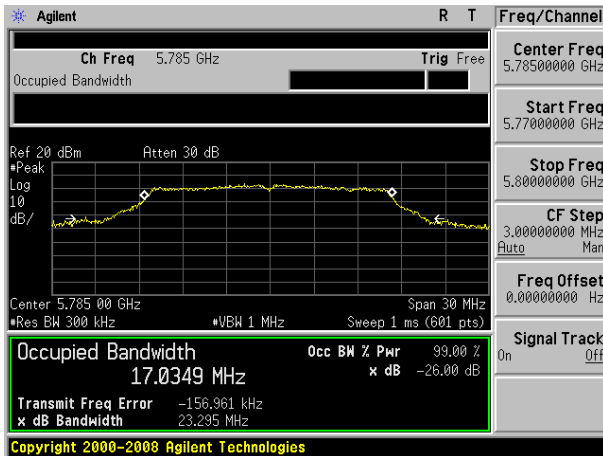

(802.11n20) -26dB&99% Bandwidth plot on channel 157

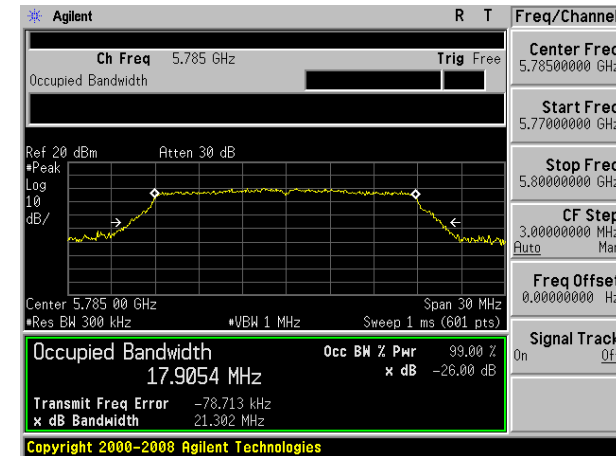

(802.11a) -26dB&99% Bandwidth plot on channel 165

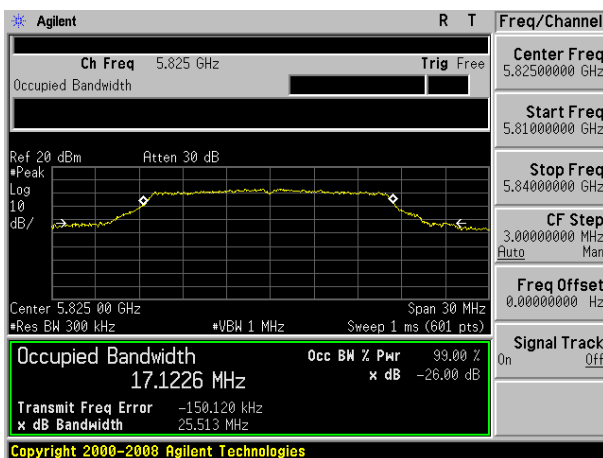

(802.11n20) -26dB&99% Bandwidth plot on channel 165

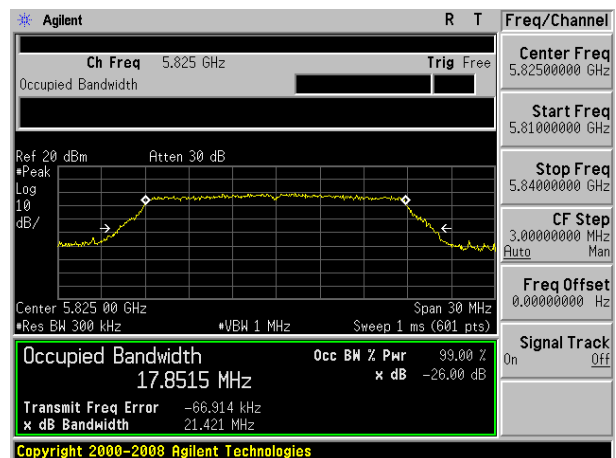

(802.11n40) -26dB&99% Bandwidth plot on channel 151

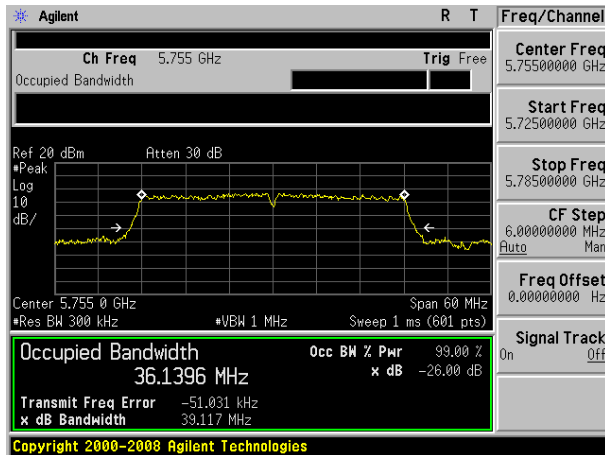

(802.11ac20) -26dB&99% Bandwidth plot on channel 149

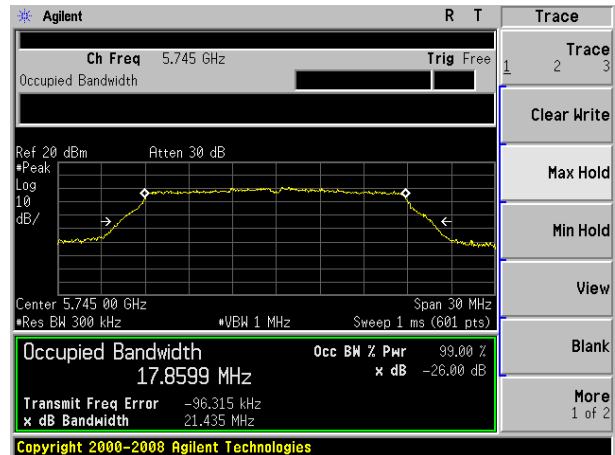

(802.11n40) -26dB&99% Bandwidth plot on channel 159

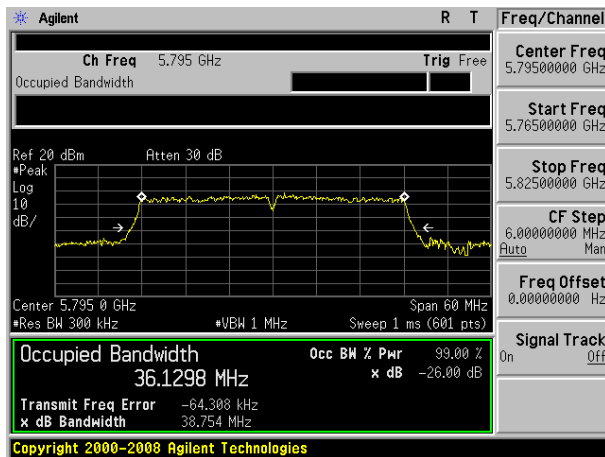

(802.11ac20) -26dB&99% Bandwidth plot on channel 157

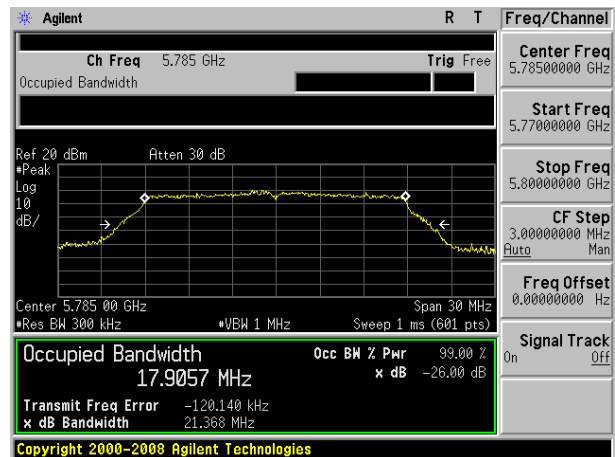

(802.11ac20) -26dB&99% Bandwidth plot on channel 165

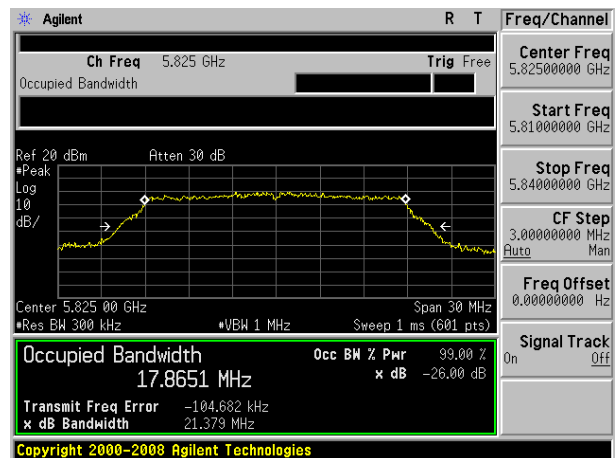

(802.11ac40) -26dB&99% Bandwidth plot on channel 151

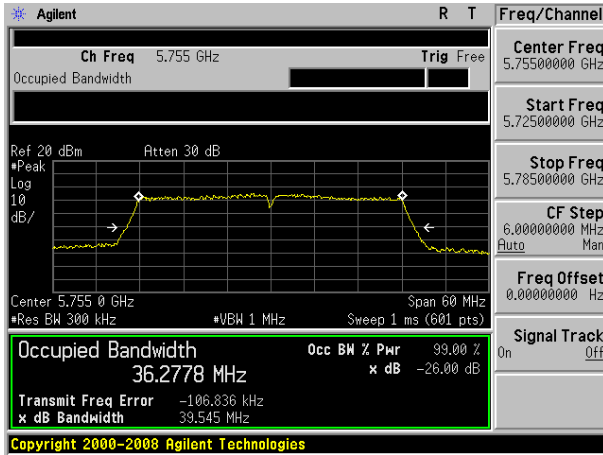

(802.11ac80) -26dB&99% Bandwidth plot on channel 155

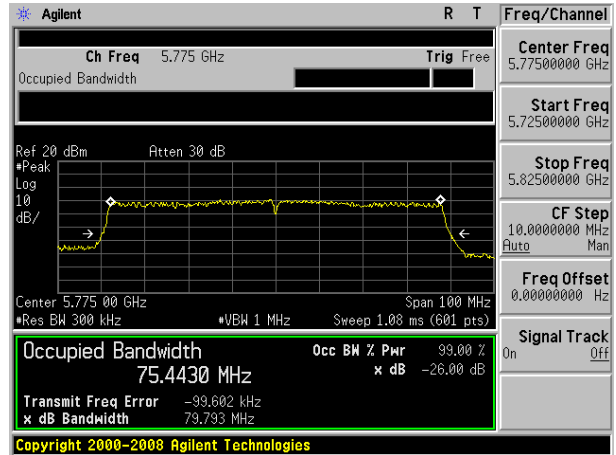

(802.11ac40) -26dB&99% Bandwidth plot on channel 159

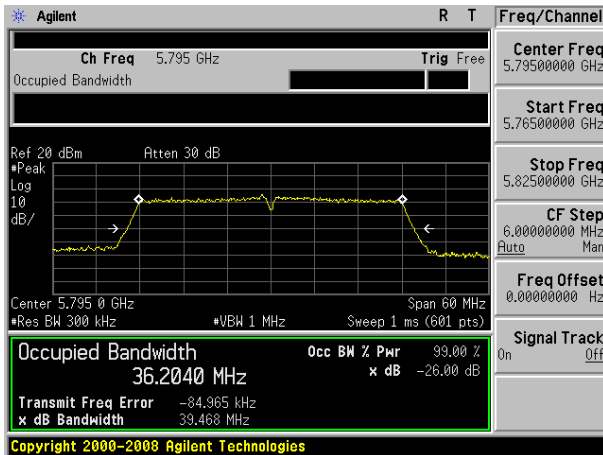

6. MINIMUM 6 DB BANDWIDTH

6.1 APPLIED PROCEDURES / LIMIT

According to FCC §15.407(e)

(e) Within the 5.725-5.85 GHz band, the minimum 6 dB bandwidth of U-NII devices shall be at least 500 kHz.

6.2 TEST PROCEDURE

Section 15.407(e) specifies the minimum 6 dB emission bandwidth of at least 500 KHz for the band 5.715-5.85 GHz. The following procedure shall be used for measuring this bandwidth:

- a) Set RBW = 100 kHz.
- b) Set the video bandwidth (VBW) $\geq 3 \times$ RBW.
- c) Detector = Peak.
- d) Trace mode = max hold.
- e) Sweep = auto couple.
- f) Allow the trace to stabilize.
- g) Measure the maximum width of the emission that is constrained by the frequencies associated with the two outermost amplitude points (upper and lower frequencies) that are attenuated by 6 dB relative to the maximum level measured in the fundamental emission.

6.3 DEVIATION FROM STANDARD

No deviation.

6.4 TEST SETUP

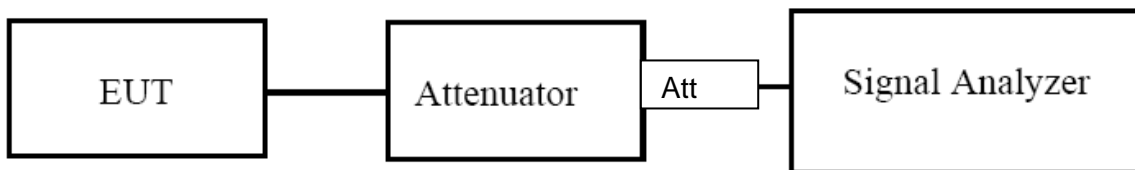

6.5 EUT OPERATION CONDITIONS

The EUT tested system was configured as the statements of 2.4 Unless otherwise a special operating condition is specified in the follows during the testing.

6.6 TEST RESULTS

EUT :	8-Inch Fully Ruggedized Tablet	Model Name :	SV-86
Temperature :	25 °C	Relative Humidity :	56%
Pressure :	1012 hPa	Test Voltage :	DC 3.7V
Test Mode :	TX Frequency (5150-5250MHz)		

Mode	Channel	Frequency (MHz)	-6dB bandwidth(MHz)	Result
802.11a	CH36	5180	16.115	Pass
	CH40	5200	16.065	Pass
	CH48	5240	16.361	Pass
802.11 n20	CH36	5180	17.675	Pass
	CH40	5200	17.675	Pass
	CH48	5240	17.703	Pass
802.11 n40	CH 38	5190	36.400	Pass
	CH 46	5230	36.370	Pass
802.11 AC20	CH36	5180	17.664	Pass
	CH40	5200	17.676	Pass
	CH48	5240	17.703	Pass
802.11 AC40	CH 38	5190	36.398	Pass
	CH 46	5230	36.086	Pass
802.11 AC80	CH 42	5210	75.857	Pass

(802.11a) -6dB Bandwidth plot on channel 36

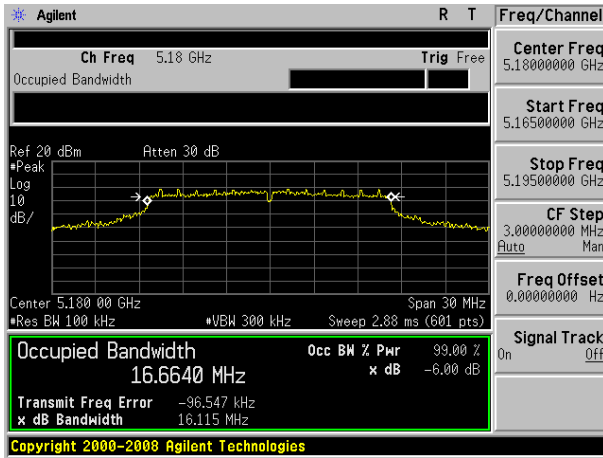

(802.11n20) -6dB Bandwidth plot on channel 36

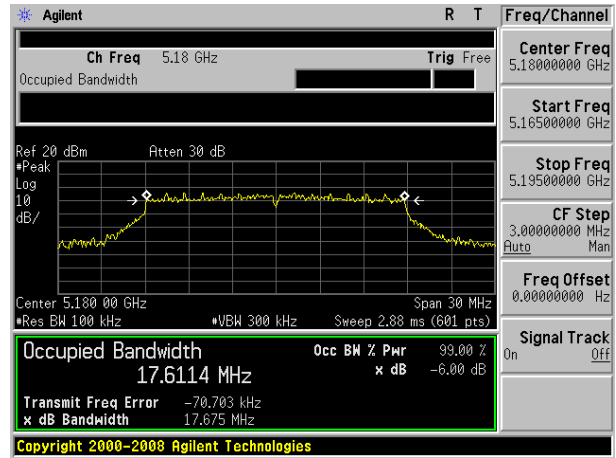

(802.11a) -6dB Bandwidth plot on channel 40

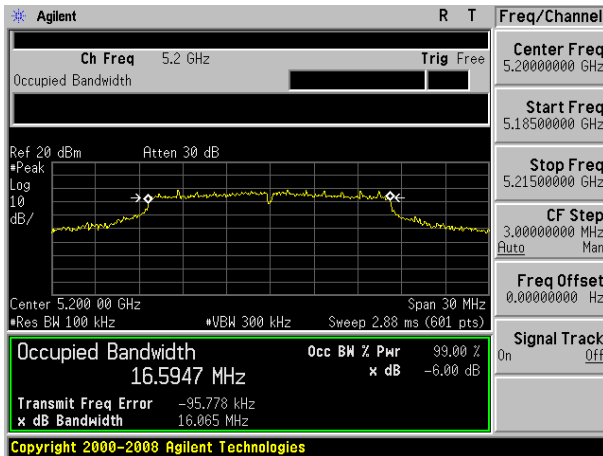

(802.11n20) -6dB Bandwidth plot on channel 40

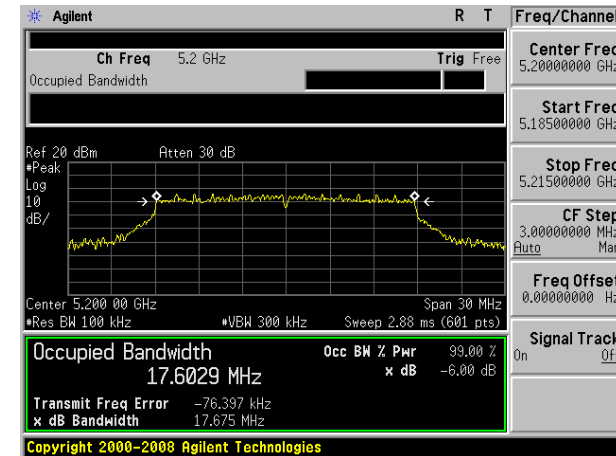

(802.11a) -6dB Bandwidth plot on channel 48

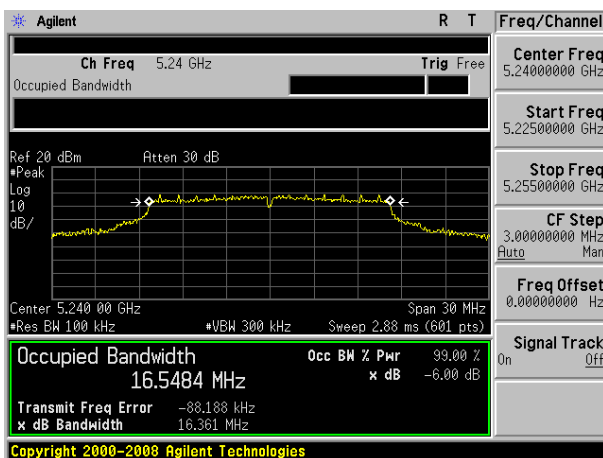

(802.11n20) -6dB Bandwidth plot on channel 48

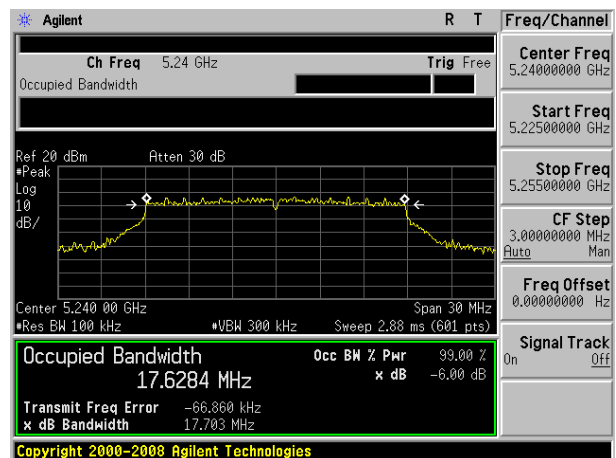

(802.11n40) -6dB Bandwidth plot on channel 38

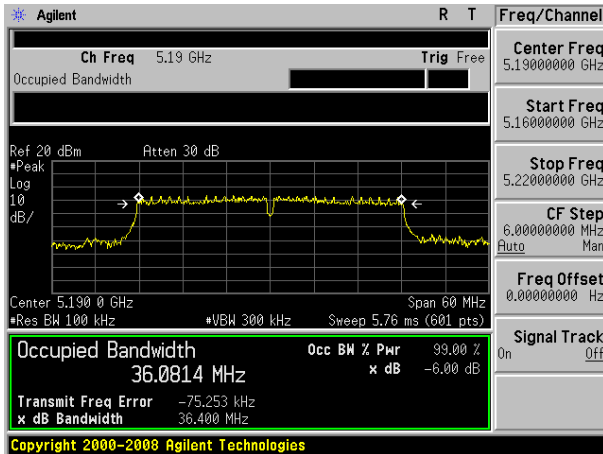

(802.11ac20) -6dB Bandwidth plot on channel 36

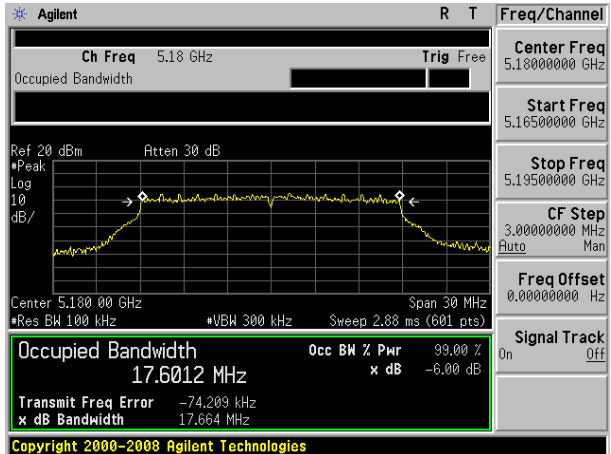

(802.11n40) -6dB Bandwidth plot on channel 46

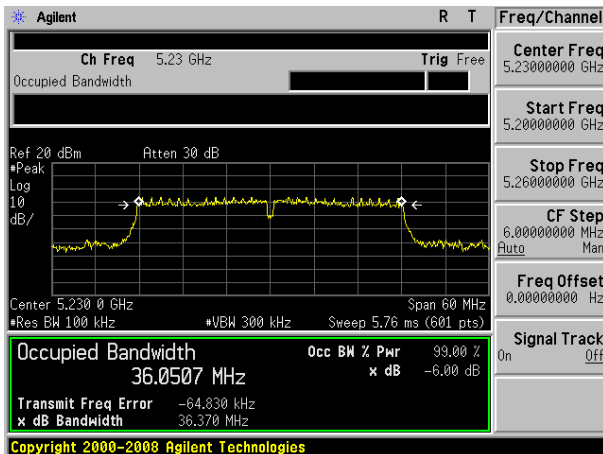

(802.11ac20) -6dB Bandwidth plot on channel 40

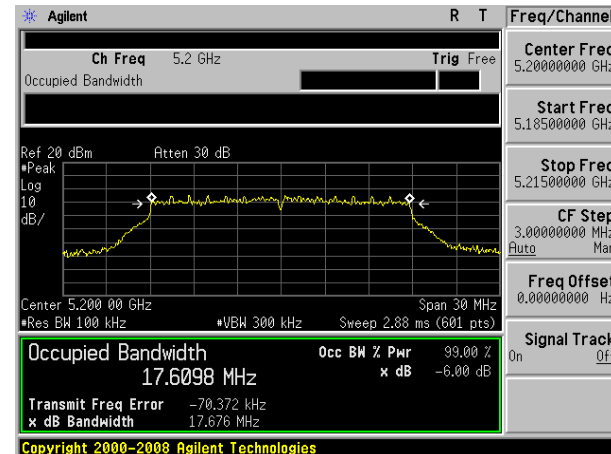

(802.11ac20) -6dB Bandwidth plot on channel 48

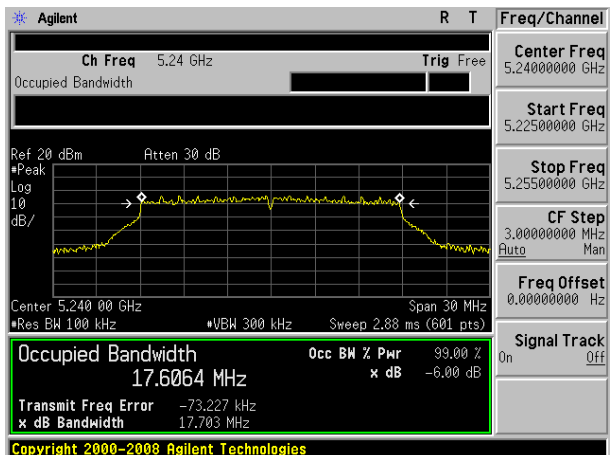

(802.11ac40) -6dB Bandwidth plot on channel 38

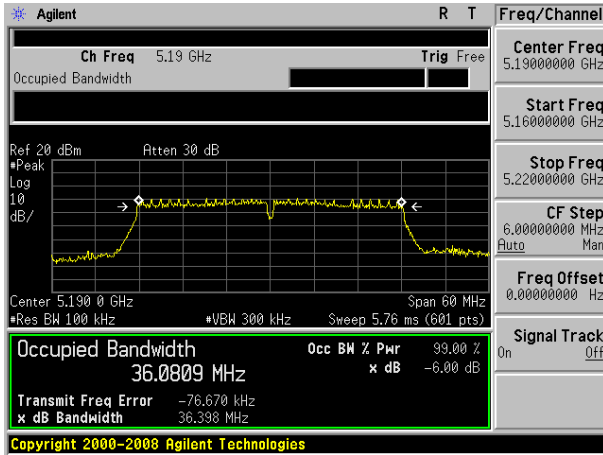

(802.11ac80) -6dB Bandwidth plot on channel 42

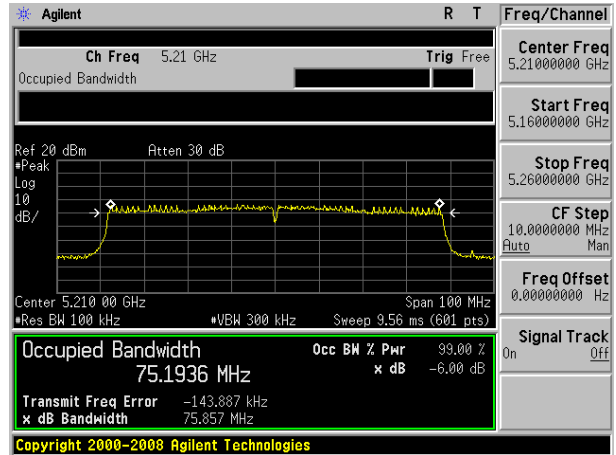

(802.11ac40) -6dB Bandwidth plot on channel 46

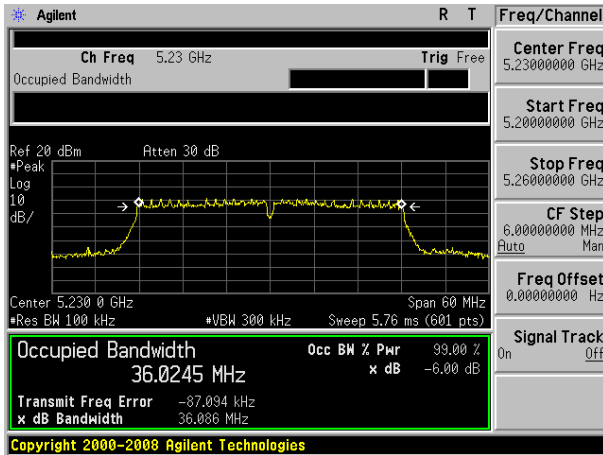

EUT :	8-Inch Fully Ruggedized Tablet	Model Name :	SV-86
Temperature :	25 °C	Relative Humidity :	60%
Pressure :	1012 hPa	Test Voltage :	DC 3.7V
Test Mode :	TX (5G) Mode Frequency (5725-5825MHz)		

Mode	Channel	Frequency (MHz)	-6dB bandwidth(MHz)	Limit (KHz)	Result
802.11a	149	5745	16.336	500	Pass
	157	5785	16.334	500	Pass
	165	5825	16.374	500	Pass
802.11 n20	149	5745	17.613	500	Pass
	157	5785	17.280	500	Pass
	165	5825	17.670	500	Pass
802.11 n40	151	5755	36.389	500	Pass
	159	5795	36.410	500	Pass
802.11 AC20	149	5745	17.624	500	Pass
	157	5785	17.660	500	Pass
	165	5825	17.683	500	Pass
802.11 AC40	149	5745	36.418	500	Pass
	157	5785	36.483	500	Pass
802.11 AC80	155	5775	75.484	500	Pass

(802.11a) -6dB Bandwidth plot on channel 149

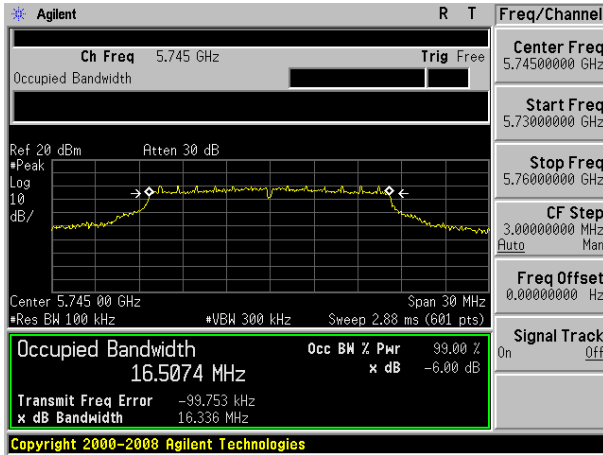

(802.11n20) -6dB Bandwidth plot on channel 149

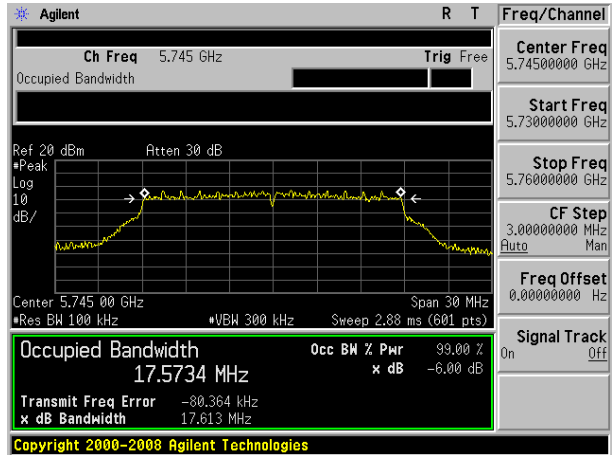

(802.11a) -6dB Bandwidth plot on channel 157

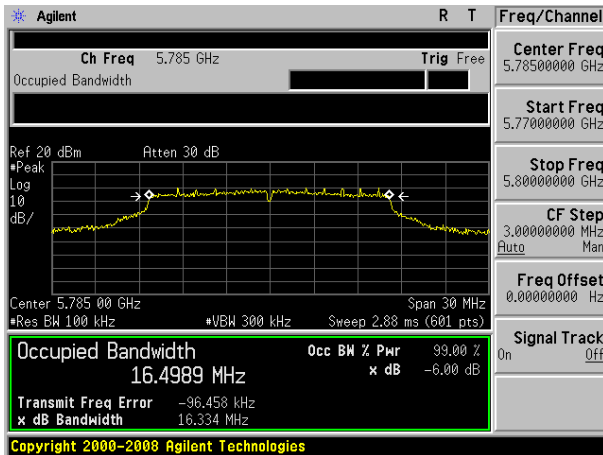

(802.11n20) -6dB Bandwidth plot on channel 157

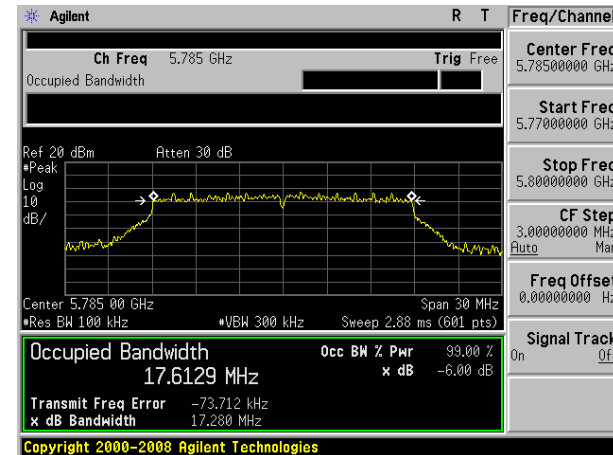

(802.11a) -6dB Bandwidth plot on channel 165

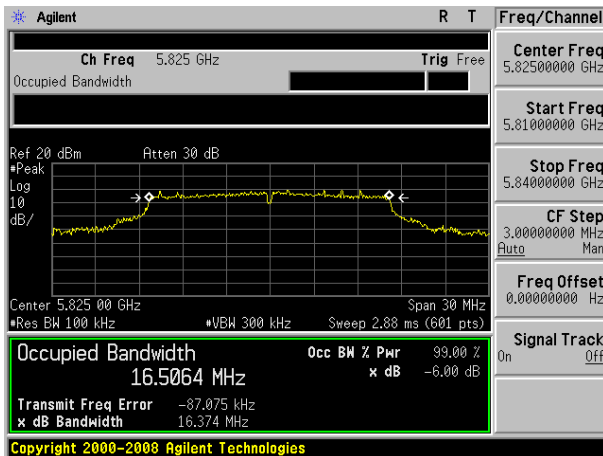

(802.11n20) -6dB Bandwidth plot on channel 165

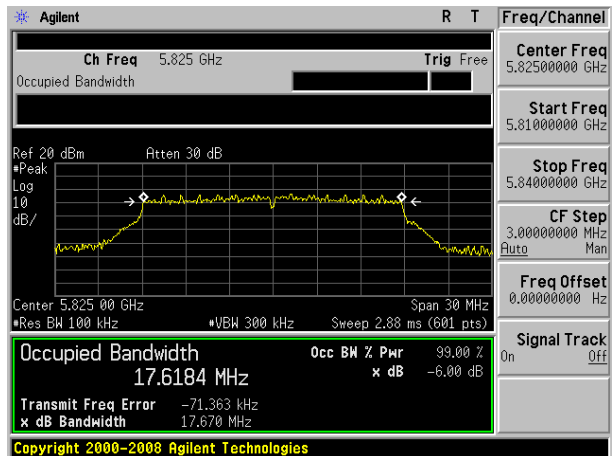

(802.11n40) -6dB Bandwidth plot on channel 151

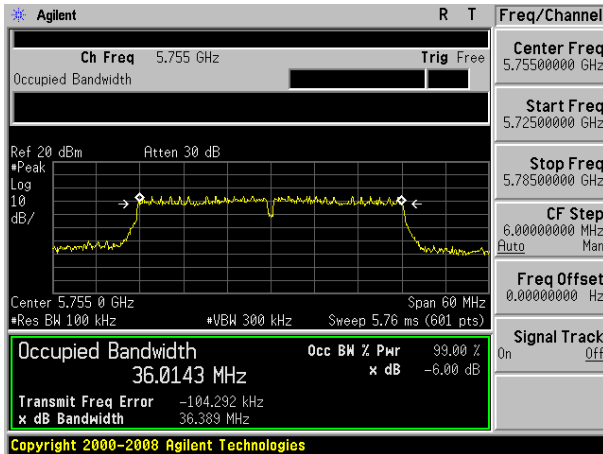

(802.11ac20) -6dB Bandwidth plot on channel 149

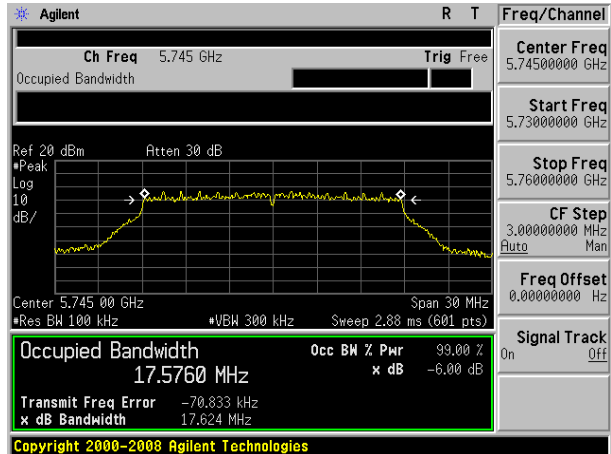

(802.11n40) -6dB Bandwidth plot on channel 159

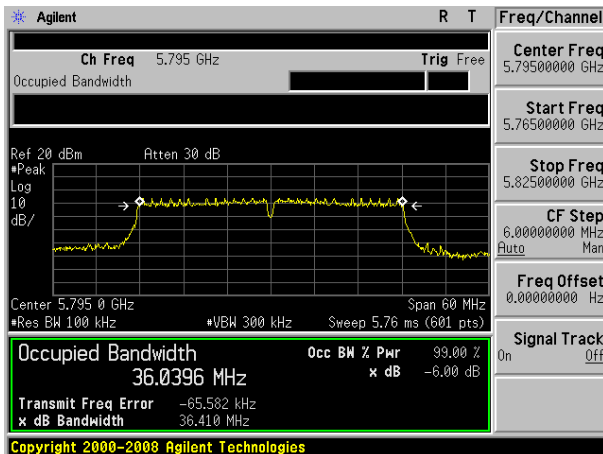

(802.11ac20) -6dB Bandwidth plot on channel 157

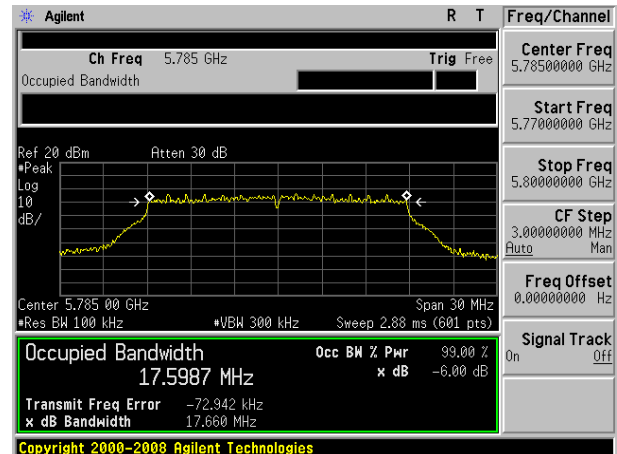

(802.11ac20) -6dB Bandwidth plot on channel 165

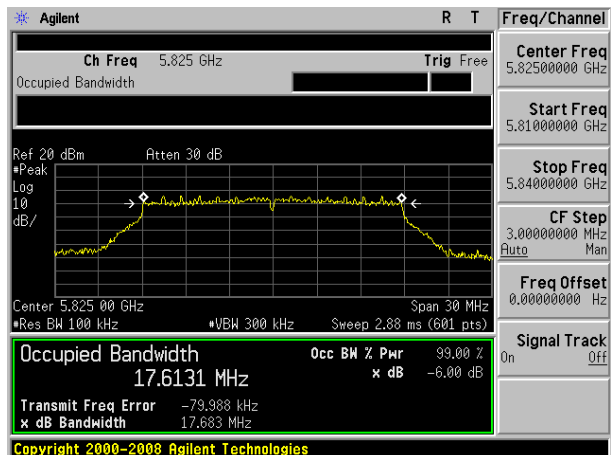

(802.11ac40) -6dB Bandwidth plot on channel 151

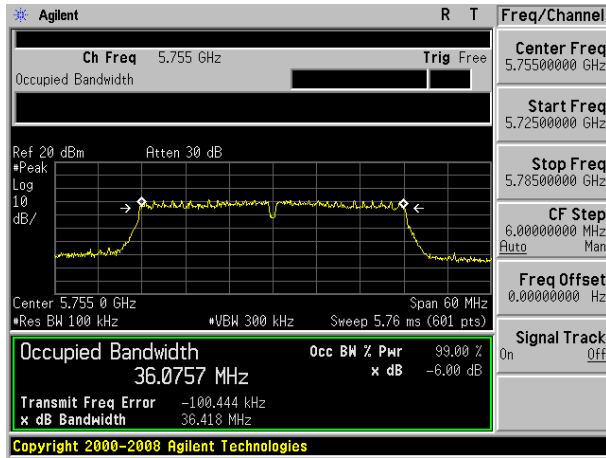

(802.11ac80) -6dB Bandwidth plot on channel 155

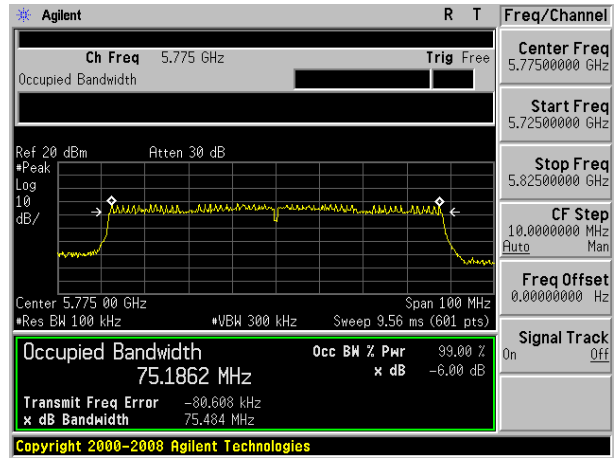

(802.11ac40) -6dB Bandwidth plot on channel 159

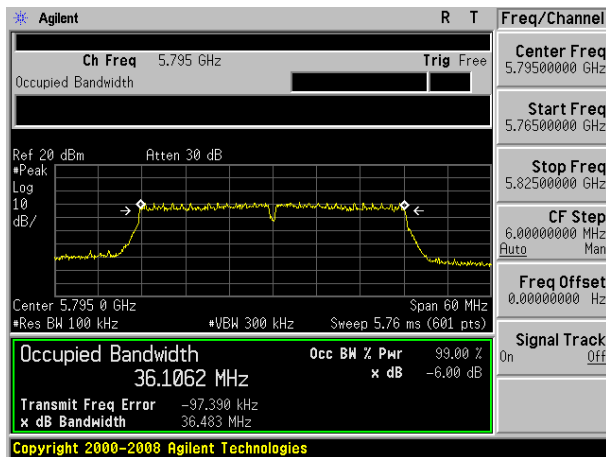

7. MAXIMUM CONDUCTED OUTPUT POWER

7.1 PPLIED PROCEDURES / LIMIT

According to FCC §15.407

According to FCC §15.407

The maximum conducted output power should not exceed:

Frequency Band(MHz)	Limit
5150~5250	250mW
5725~5850	1W

The maximum e.i.r.p should not exceed:

Frequency Band(MHz)	Limit
5150~5250	200mW or 10dBm +10logB whichever is less
5725~5850	N/A

Note: Where “B” is the 99% emission bandwidth in MHz

7.2 TEST PROCEDURE

- Maximum conducted output power may be measured using a spectrum analyzer/EMI receiver or an RF power meter.

1. Device Configuration

If possible, configure or modify the operation of the EUT so that it transmits continuously at its maximum power control level (see section II.B.).

a) The intent is to test at 100 percent duty cycle; however a small reduction in duty cycle (to no lower than 98 percent) is permitted if required by the EUT for amplitude control purposes. Manufacturers are expected to provide software to the test lab to permit such continuous operation.

b) If continuous transmission (or at least 98 percent duty cycle) cannot be achieved due to hardware limitations (e.g., overheating), the EUT shall be operated at its maximum power control level with the transmit duration as long as possible and the duty cycle as high as possible.

2. Measurement using a Spectrum Analyzer or EMI Receiver (SA)

Measurement of maximum conducted output power using a spectrum analyzer requires integrating the spectrum across a frequency span that encompasses, at a minimum, either the EBW or the 99-percent occupied bandwidth of the signal.¹ However, the EBW must be used to determine bandwidth dependent limits on maximum conducted output power in accordance with § 15.407(a).

a) The test method shall be selected as follows: (i) Method SA-1 or SA-1 Alternative (averaging with the EUT transmitting at full power throughout each sweep) shall be applied if either of the following conditions can be satisfied:

- The EUT transmits continuously (or with a duty cycle ≥ 98 percent).
- Sweep triggering or gating can be implemented in a way that the device transmits at the maximum power control level throughout the duration of each of the instrument sweeps to be averaged. This condition can generally be achieved by triggering the instrument's sweep if the duration of the sweep (with the analyzer configured as in Method SA-1, below) is equal to or shorter than the duration T of each transmission from the EUT and if those transmissions exhibit full power throughout their durations.

(ii) Method SA-2 or SA-2 Alternative (averaging across on and off times of the EUT transmissions, followed by duty cycle correction) shall be applied if the conditions of (i) cannot be achieved and the transmissions exhibit a constant duty cycle during the measurement duration. Duty cycle will be considered to be constant if variations are less than ± 2 percent.

(iii) Method SA-3 (RMS detection with max hold) or SA-3 Alternative (reduced VBW with max hold) shall be applied if the conditions of (i) and (ii) cannot be achieved.

b) Method SA-1 (trace averaging with the EUT transmitting at full power throughout each sweep): (i) Set span to encompass the entire emission bandwidth (EBW) (or, alternatively, the entire 99% occupied bandwidth) of the signal.

(ii) Set RBW = 1 MHz.

(iii) Set VBW ≥ 3 MHz.

(iv) Number of points in sweep ≥ 2 Span / RBW. (This ensures that bin-to-bin spacing is \leq RBW/2, so that narrowband signals are not lost between frequency bins.)

(v) Sweep time = auto.

(vi) Detector = RMS (i.e., power averaging), if available. Otherwise, use sample detector mode.

(vii) If transmit duty cycle < 98 percent, use a video trigger with the trigger level set to enable triggering only on full power pulses. Transmitter must operate at maximum power control level for the entire duration of every sweep. If the EUT transmits continuously (i.e., with no off intervals) or at duty cycle ≥ 98 percent, and if each transmission is entirely at the maximum power control level, then the trigger shall be set to "free run".

(viii) Trace average at least 100 traces in power averaging (i.e., RMS) mode.

(ix) Compute power by integrating the spectrum across the EBW (or, alternatively, the entire 99% occupied bandwidth) of the signal using the instrument's band power measurement function with band limits set equal to the EBW (or occupied bandwidth) band edges. If the instrument does not have a band power function, sum the spectrum

7.3 DEVIATION FROM STANDARD

No deviation.

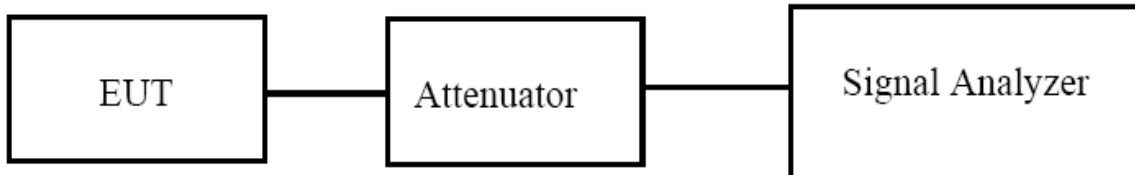
7.4 TEST SETUP**7.5 EUT OPERATION CONDITIONS**

The EUT tested system was configured as the statements of 2.4 Unless otherwise a special operating condition is specified in the follows during the testing.

7.6 TEST RESULTS

EUT :	8-Inch Fully Ruggedized Tablet	Model Name :	SV-86
Temperature :	25 °C	Relative Humidity :	60%
Pressure :	1012 hPa	Test Voltage :	DC 3.7V
Test Mode :	TX (5G) Mode Frequency (5150-5250MHz)		

Test Channel	Frequency (MHz)	Maximum output power. Antenna port (AV)	LIMIT dBm	Result
		(dBm)		
		TX 802.11a Mode		
CH36	5180	11.2	23.98	Pass
CH40	5200	11.2	23.98	Pass
CH48	5240	12.0	23.98	Pass
TX 802.11 n20M Mode				
CH36	5180	8.3	21.42	Pass
CH40	5200	8.3	21.42	Pass
CH48	5240	9.1	21.42	Pass
TX 802.11 n40M Mode				
CH38	5190	8.5	21.42	Pass
CH46	5230	9.1	21.42	Pass
TX 802.11 AC20M Mode				
CH36	5180	7.4	21.42	Pass
CH40	5200	7.4	21.42	Pass
CH48	5240	8.2	21.42	Pass
TX 802.11 AC40M Mode				
CH38	5190	6.1	21.42	Pass
CH46	5230	6.6	21.42	Pass
TX 802.11 AC80M Mode				
CH42	5210	5.1	21.42	Pass

EUT :	8-Inch Fully Ruggedized Tablet	Model Name :	SV-86
Temperature :	25 °C	Relative Humidity :	60%
Pressure :	1012 hPa	Test Voltage :	DC 3.7V
Test Mode :	TX (5G) Mode Frequency (5725-5825MHz)		

Test Channel	Frequency (MHz)	Maximum output power. Antenna port (AV)	LIMIT dBm	Result
		(dBm)		
		TX 802.11a Mode		
CH 149	5745	11.8	30	Pass
CH 157	5785	11.6	30	Pass
CH 165	5825	11.1	30	Pass
TX 802.11 n20M Mode				
CH 149	5745	8.3	27.44	Pass
CH 157	5785	7.8	27.44	Pass
CH 165	5825	7.4	27.44	Pass
TX 802.11 n40M Mode				
CH 151	5755	5.5	27.44	Pass
CH 159	5795	5.1	27.44	Pass
TX 802.11 AC20M Mode				
CH 149	5745	8.3	27.44	Pass
CH 157	5785	7.8	27.44	Pass
CH 165	5825	7.4	27.44	Pass
TX 802.11 AC40M Mode				
CH 151	5755	8.3	27.44	Pass
CH 159	5795	8.1	27.44	Pass
TX 802.11 AC80M Mode				
CH 155	5775	5.1	27.44	Pass

8. OUT OF BAND EMISSIONS

8.1 APPLICABLE STANDARD

According to FCC §15.407(b)

Undesirable emission limits. Except as shown in paragraph (b)(7) of this section, the maximum emissions outside of the frequency bands of operation shall be attenuated in accordance with the following limits:

(1) For transmitters operating in the 5.15-5.25 GHz band: All emissions outside of the 5.15-5.35 GHz band shall not exceed an e.i.r.p. of -27 dBm/MHz.

(2) For transmitters operating in the 5.725-5.85 GHz band: All emissions shall be limited to a level of -27 dBm/MHz at 75 MHz or more above or below the band edge increasing linearly to 10 dBm/MHz at 25 MHz above or below the band edge, and from 25 MHz above or below the band edge increasing linearly to a level of 15.6 dBm/MHz at 5 MHz above or below the band edge, and from 5 MHz above or below the band edge increasing linearly to a level of 27 dBm/MHz at the band edge.

8.2 TEST PROCEDURE

1. Check the calibration of the measuring instrument using either an internal calibrator or a known signal from an external generator.
2. Position the EUT without connection to measurement instrument. Turn on the EUT and connect its antenna terminal to measurement instrument via a low loss cable. Then set it to any one measured frequency within its operating range, and make sure the instrument is operated in its linear range.
3. Set RBW of spectrum analyzer to 1 MHz with a convenient frequency span.
4. Measure the highest amplitude appearing on spectral display and set it as a reference level. Plot the graph with marking the highest point and edge frequency.
5. Repeat above procedures until all measured frequencies were complete.

8.3 DEVIATION FROM STANDARD

No deviation.

8.4 TEST SETUP



8.5 EUT OPERATION CONDITIONS

The EUT tested system was configured as the statements of 2.4 Unless otherwise a special operating condition is specified in the follows during the testing.

8.6 TEST RESULTS

EUT :	8-Inch Fully Ruggedized Tablet	Model Name :	SV-86
Temperature :	25 °C	Relative Humidity :	56%
Pressure :	1012 hPa	Test Voltage :	DC 3.7V

5.2G

5.15~5.25 GHz

(802.11a) Band Edge, Left Side

(802.11n20) Band Edge, Left Side

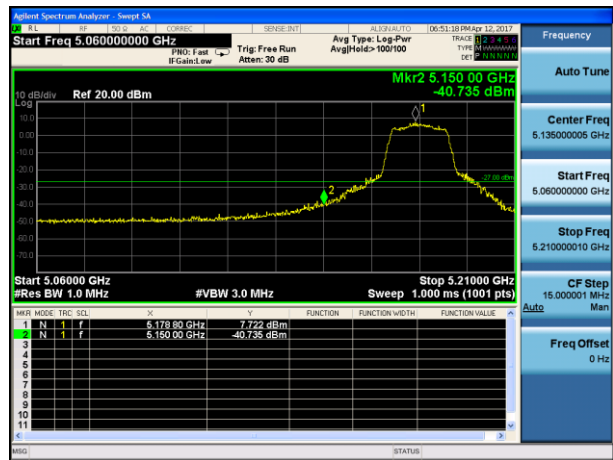

(802.11a) Band Edge, Right Side

(802.11n20) Band Edge, Right Side

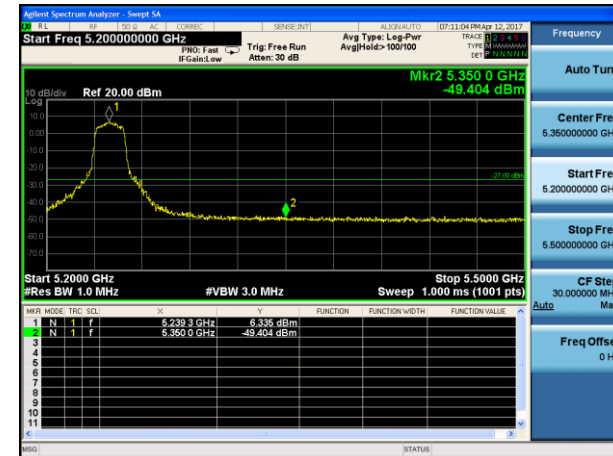
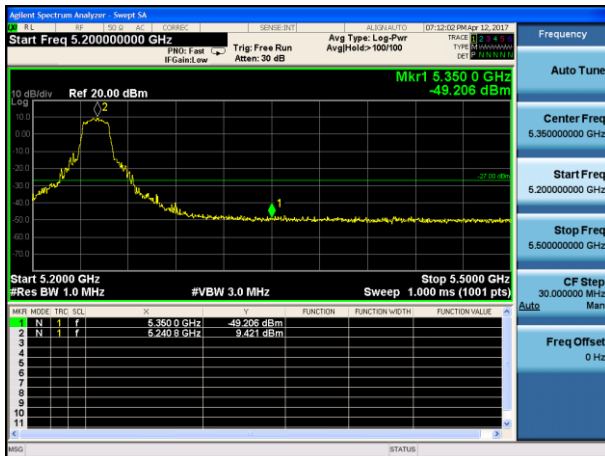

5.15~5.25 GHz

(802.11n40) Band Edge, Left Side



(802.11ac20) Band Edge, Left Side

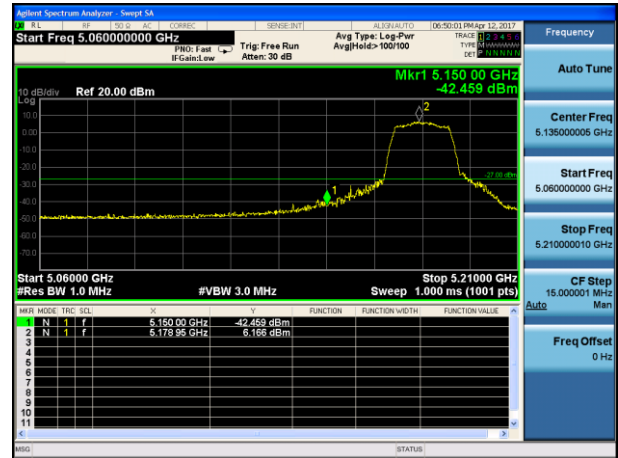

(802.11n40) Band Edge, Right Side

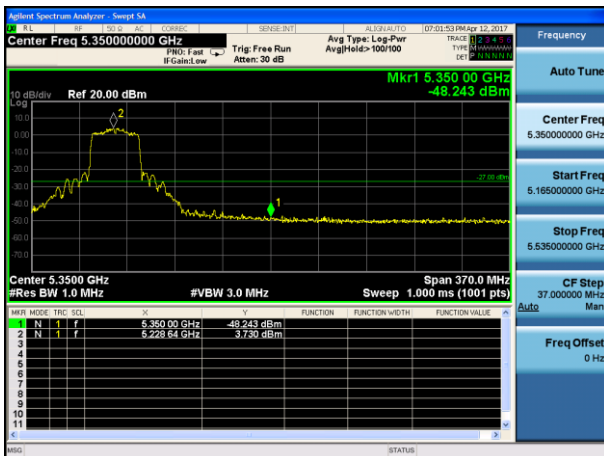

(802.11ac20) Band Edge, Right Side

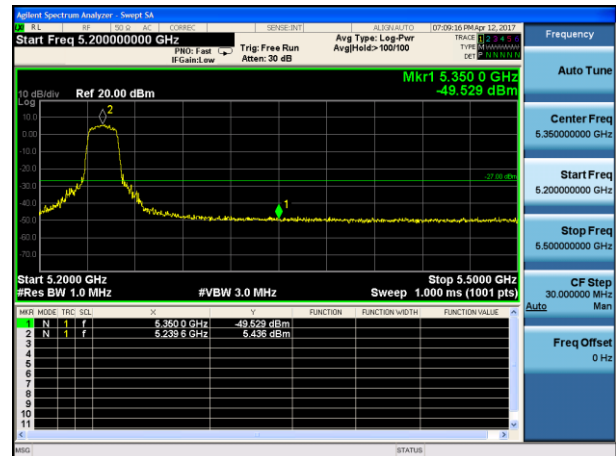

5.15~5.25 GHz

(802.11ac40) Band Edge, Left Side

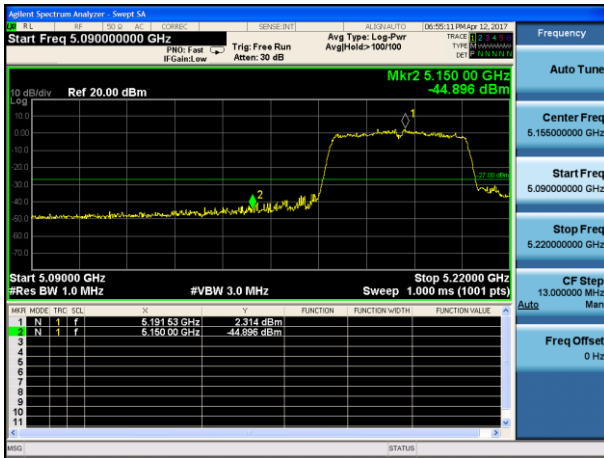

(802.11ac80) Band Edge, Left Side

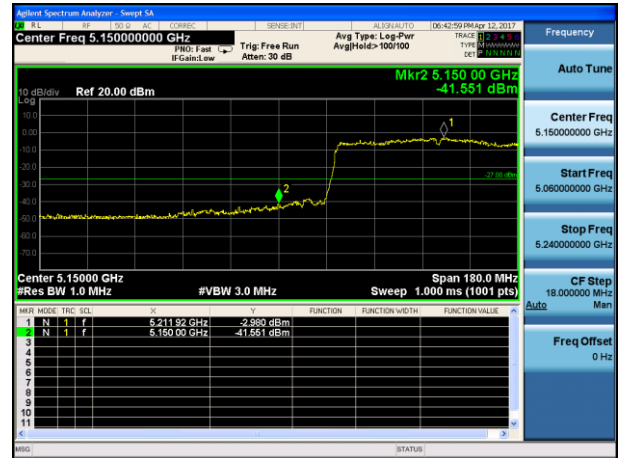

(802.11ac40) Band Edge, Right Side

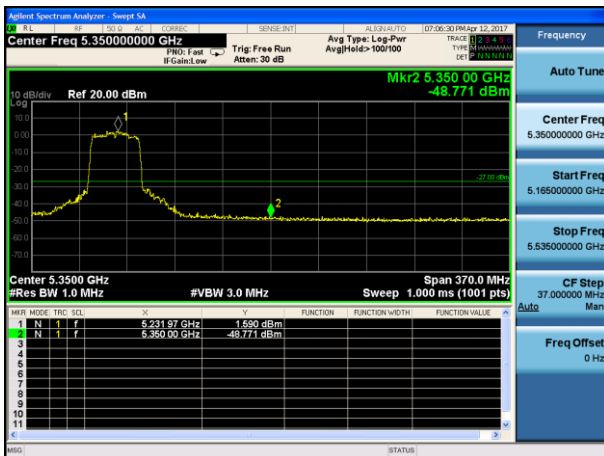

(802.11ac80) Band Edge, Right Side

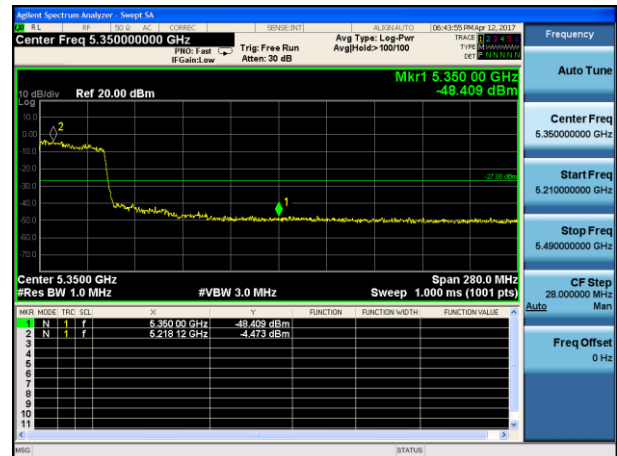

5.8G

5.725-5.85 GHz

(802.11a) Band Edge, Left Side

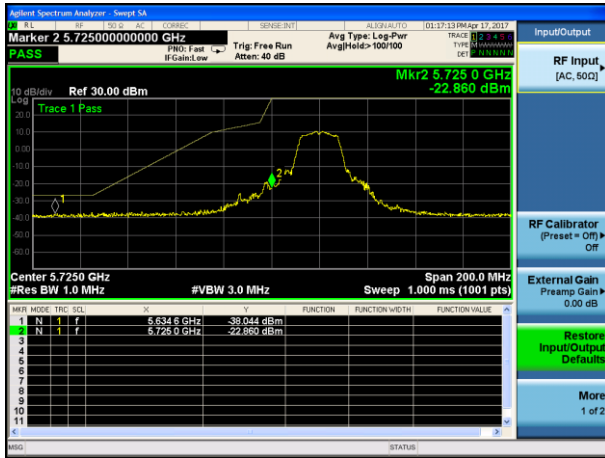

(802.11n20) Band Edge, Left Side

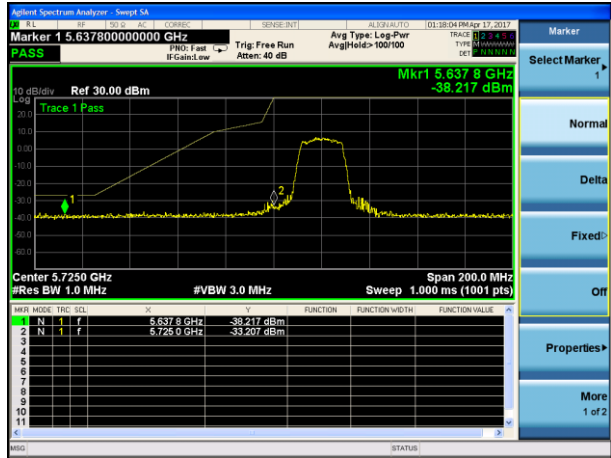

(802.11a) Band Edge, Right Side

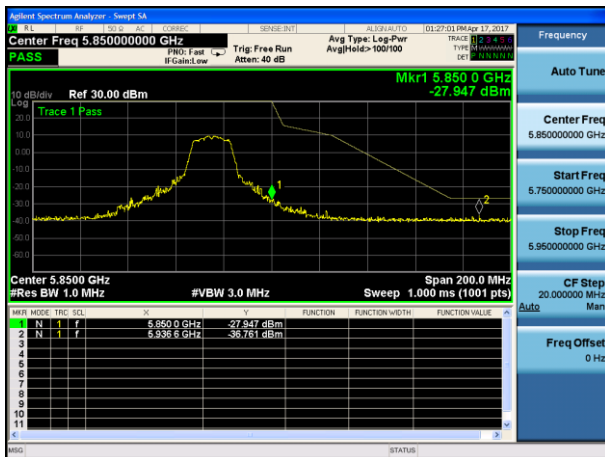

(802.11n20) Band Edge, Right Side

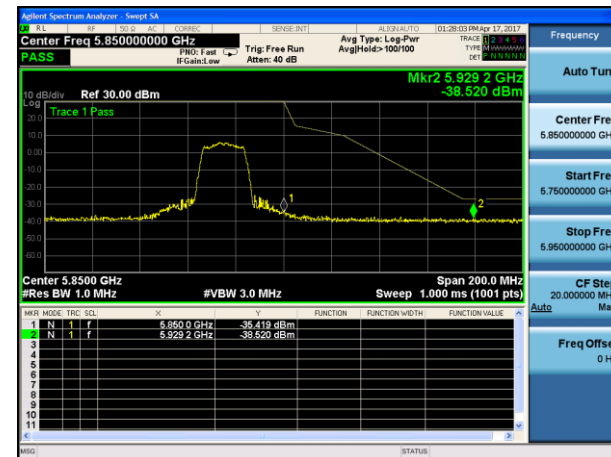

5.725-5.85 GHz

(802.11n40) Band Edge, Left Side

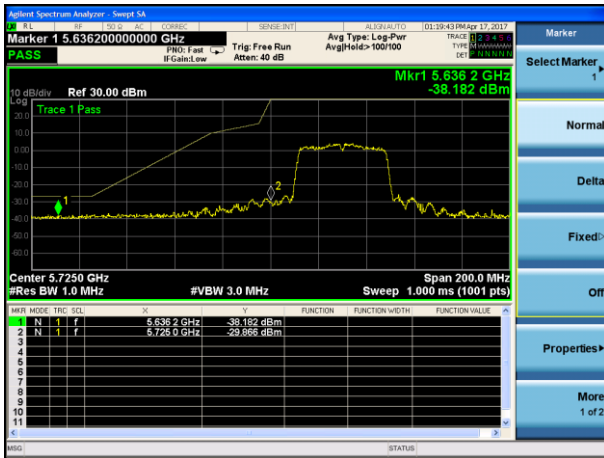

(802.11ac20) Band Edge, Left Side

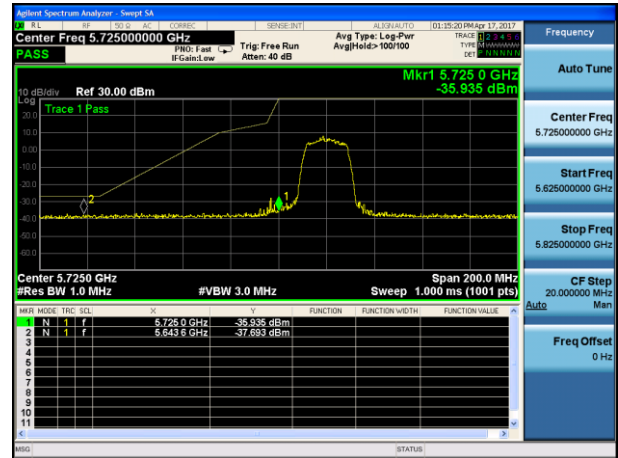

(802.11n40) Band Edge, Right Side

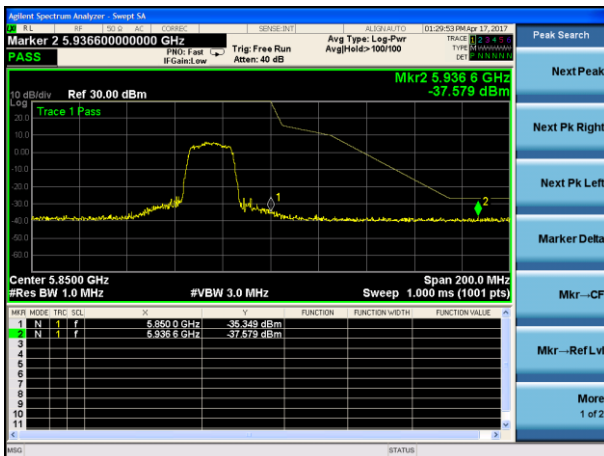

(802.11ac20) Band Edge, Right Side

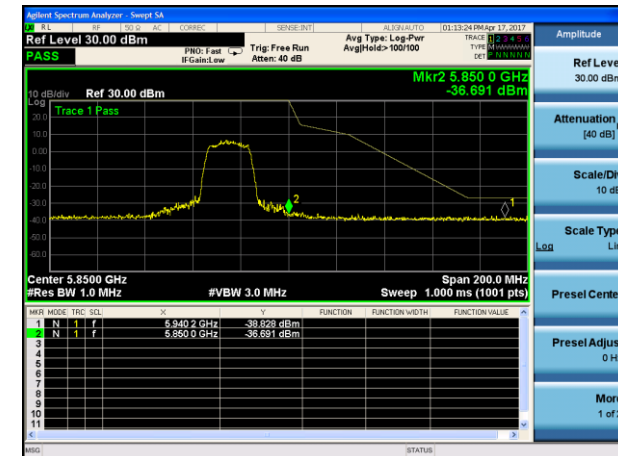

5.725-5.85 GHz

(802.11ac40) Band Edge, Left Side

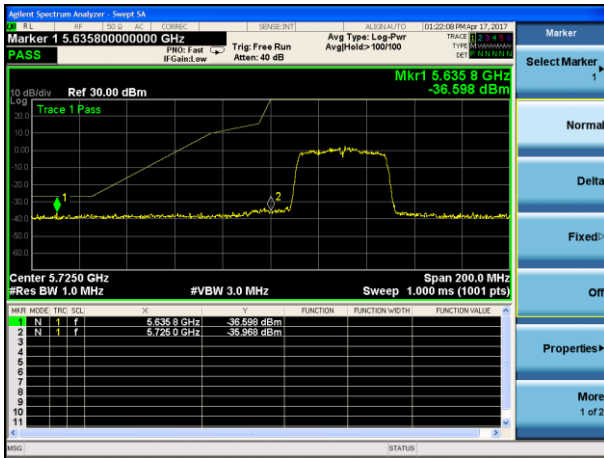

(802.11ac80) Band Edge, Left Side

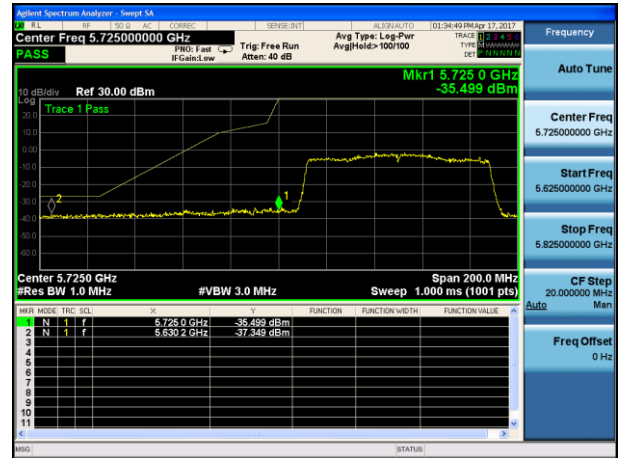

(802.11ac40) Band Edge, Right Side



(802.11ac80) Band Edge, Right Side

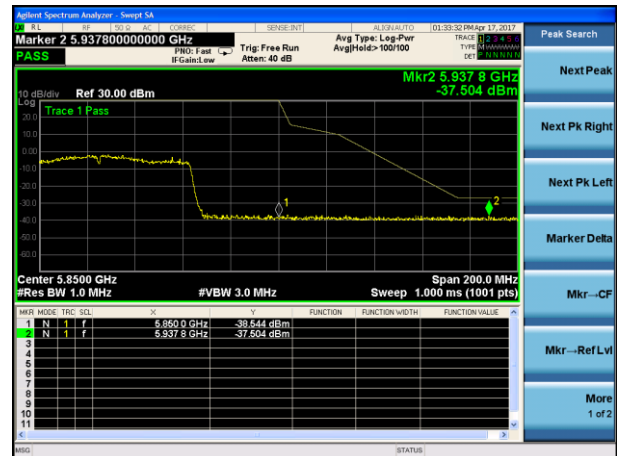

9.SPURIOUS RF CONDUCTED EMISSIONS

9.1 CONFORMANCE LIMIT

1. Below -20dB of the highest emission level in operating band.
2. Fall in the restricted bands listed in section 15.205. The maximum permitted average field strength is listed in section 15.209.

9.2 MEASURING INSTRUMENTS

The Measuring equipment is listed in the section 6.3 of this test report.

9.3 TEST SETUP

Please refer to Section 6.1 of this test report.

9.4 TEST PROCEDURE

The Spurious RF conducted emissions compliance of RF radiated emission should be measured by following the guidance in ANSI C63.10-2013 with respect to maximizing the emission by rotating the EUT, measuring the emission while the EUT is situated in three orthogonal planes (if appropriate), adjusting the measurement antenna height and polarization etc. Set RBW=100kHz and VBW= 300KHz to measure the peak field strength , and mwasure frequeny range from 9KHz to 26.5GHz.

9.5 TEST RESULTS

Remark: The measurement frequency range is from 9KHz to the 10th harmonic of the fundamental frequency. The lowest, middle and highest channels are tested to verify the spurious emissions and bandedge measurement data.

5.2G

Test Plot

802.11a on channel 36

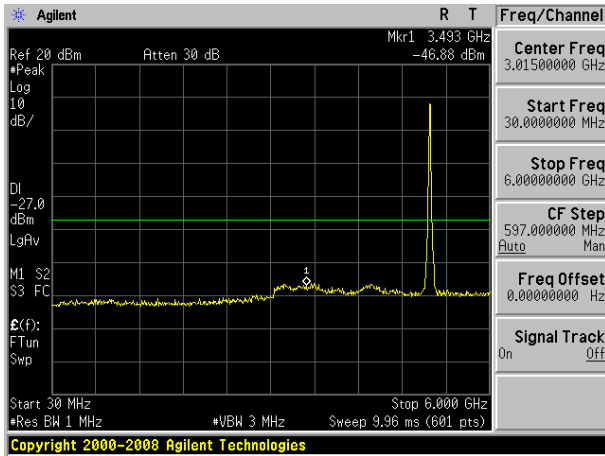

802.11a on channel 40

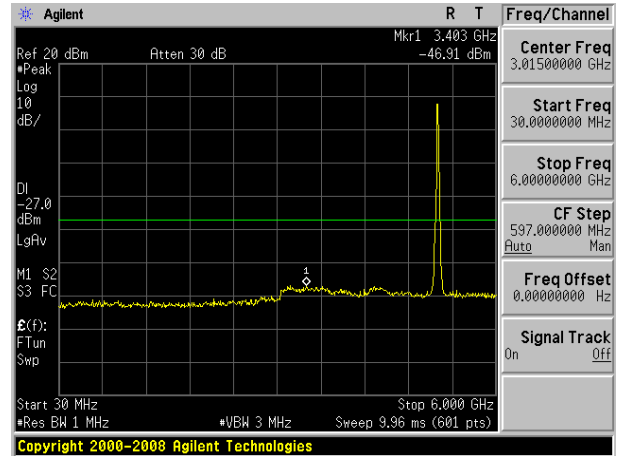

802.11a on channel 36

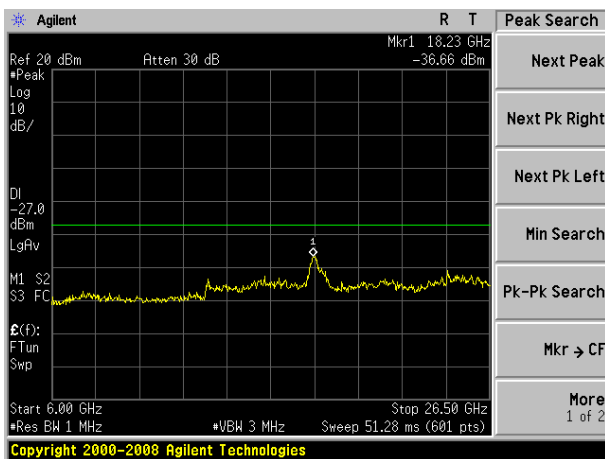

802.11a on channel 40

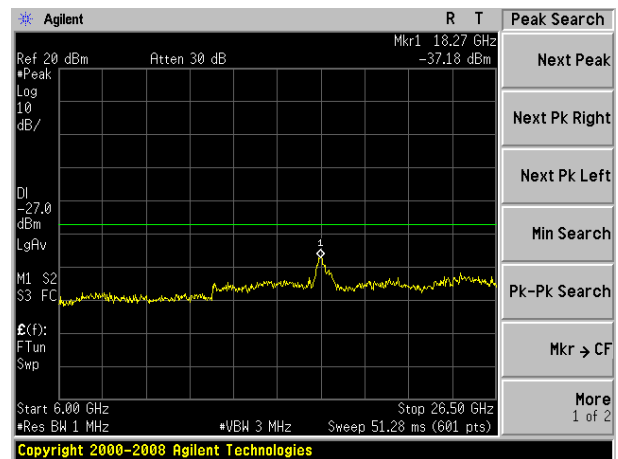

Test Plot

802.11a on channel 48

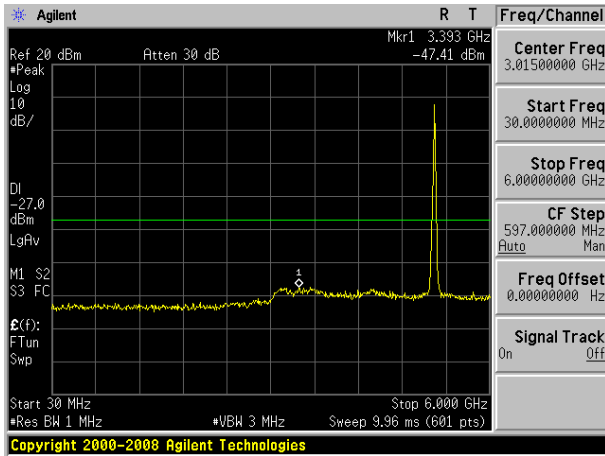

802.11n20 on channel 36

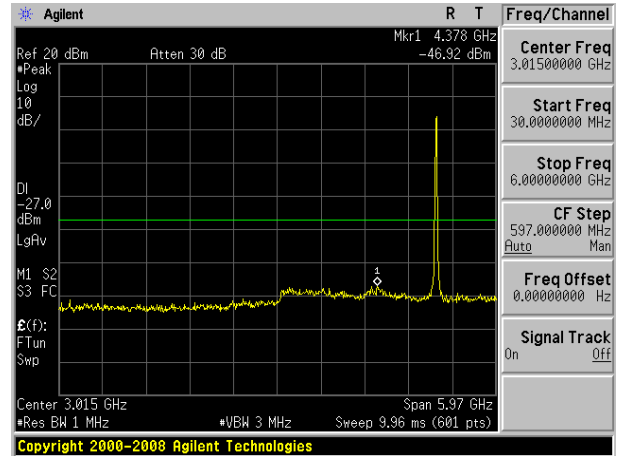

802.11a on channel 48

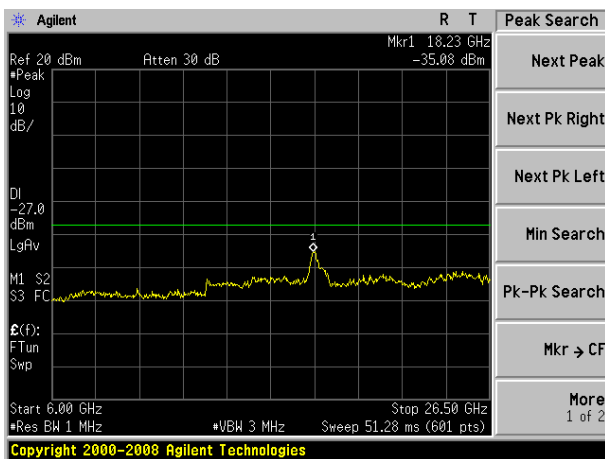

802.11n20 on channel 36

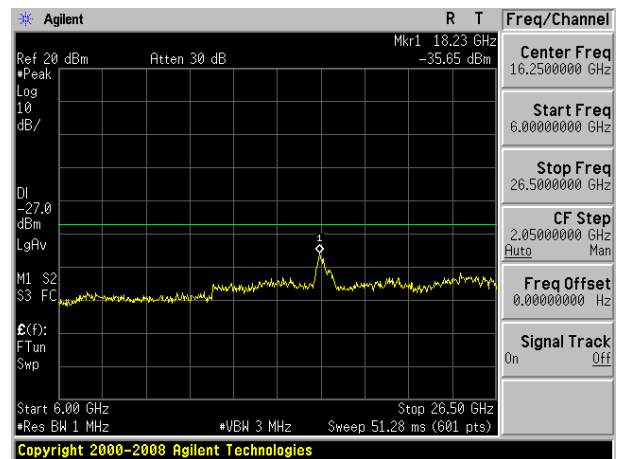

Test Plot

802.11n20 on channel 40

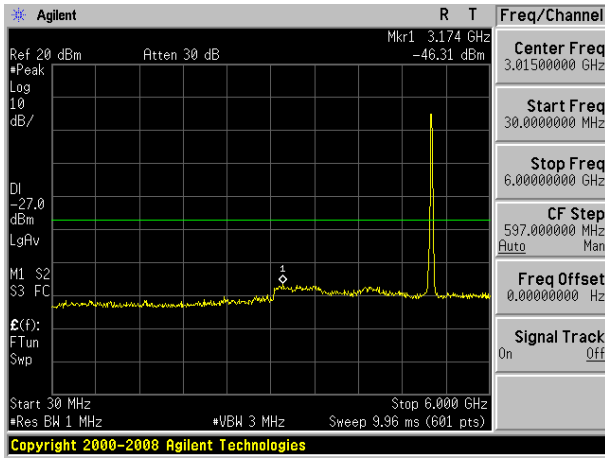

802.11n20 on channel 48

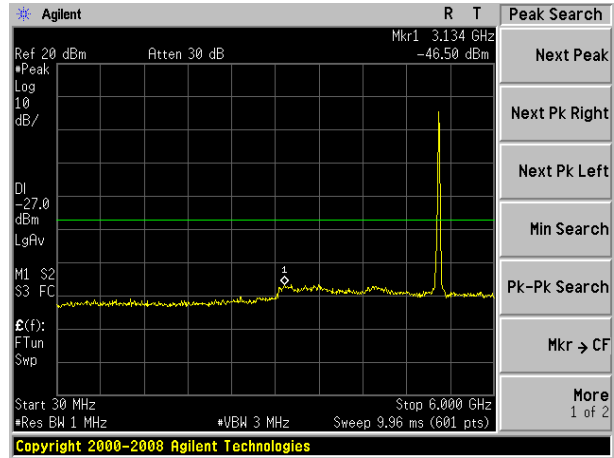

802.11n20 on channel 40

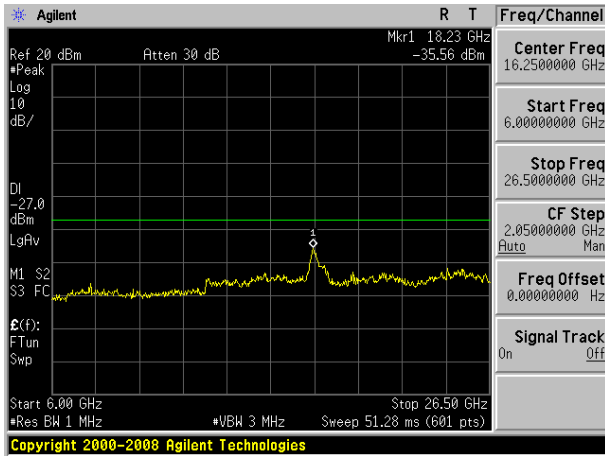

802.11n20 on channel 48

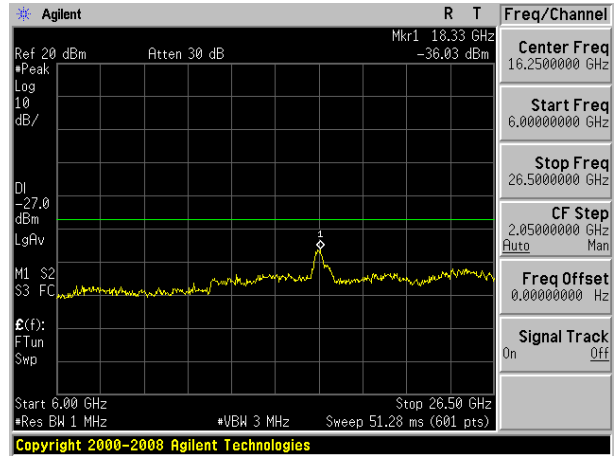

Test Plot

802.11n40 on channel 38

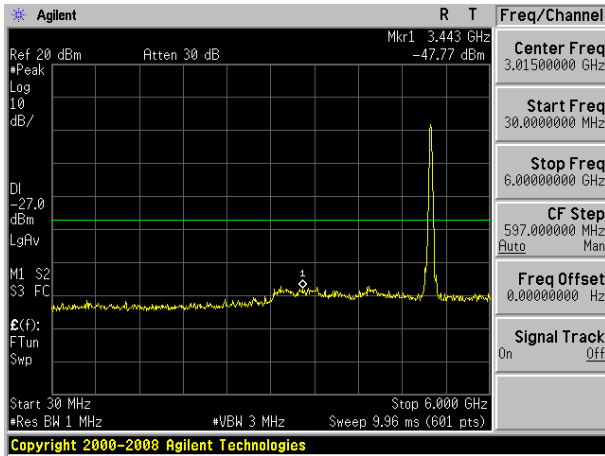

802.11n40 on channel 46

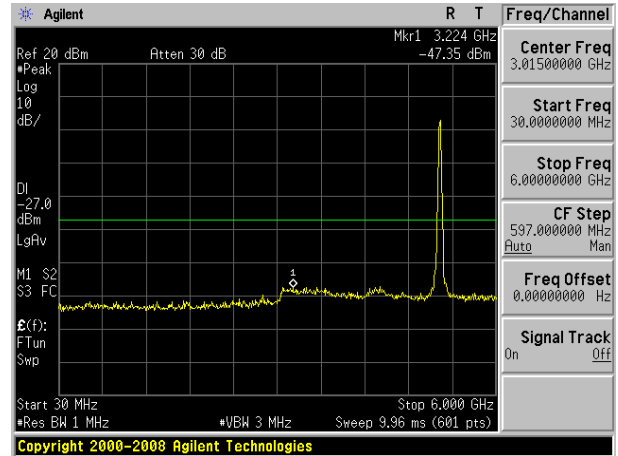

802.11n40 on channel 38

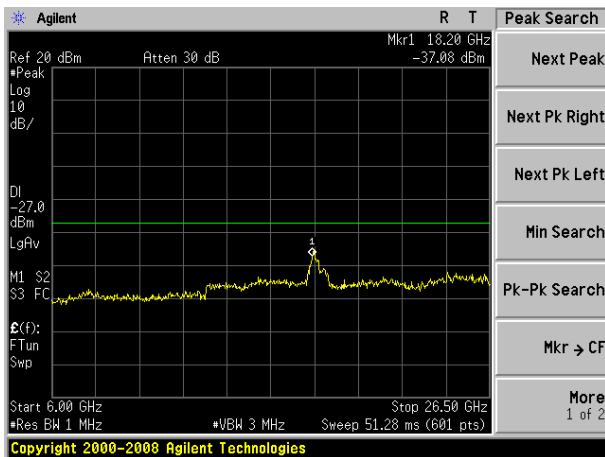

802.11n40 on channel 46

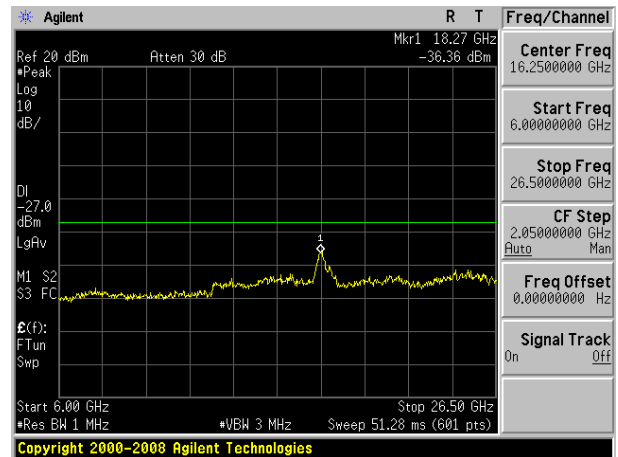

Test Plot

802.11ac20 on channel 36

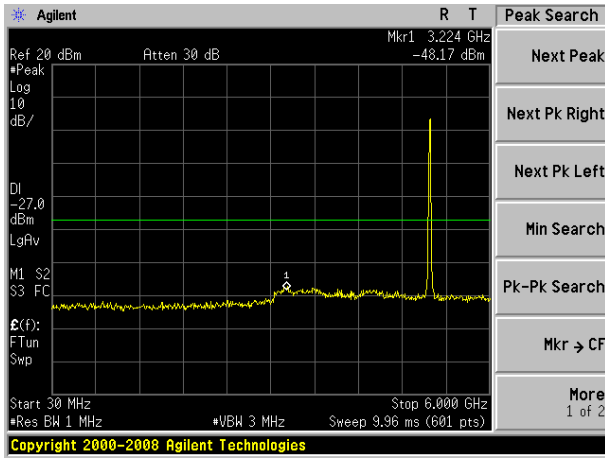

802.11ac20 on channel 40

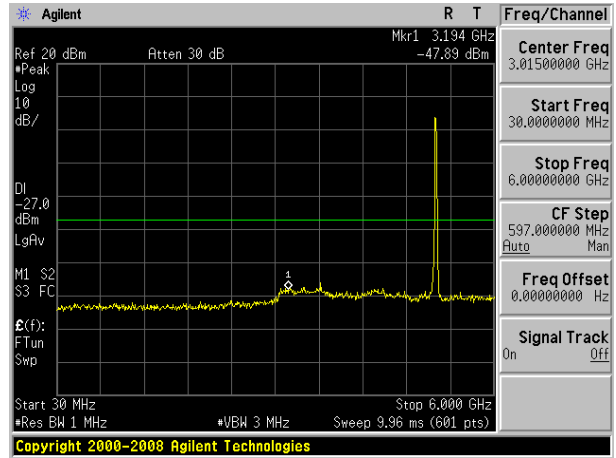

802.11ac20 on channel 36

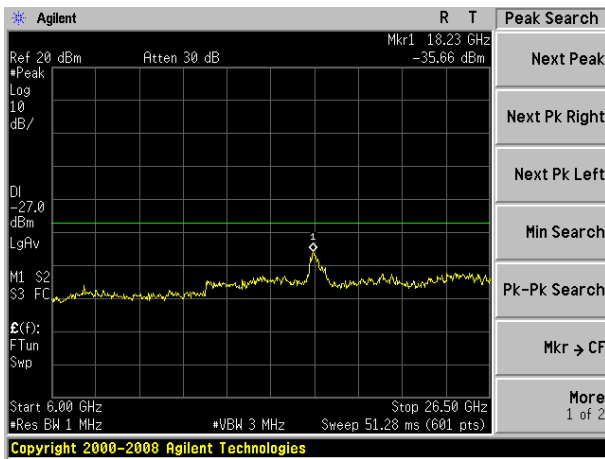

802.11ac20 on channel 40

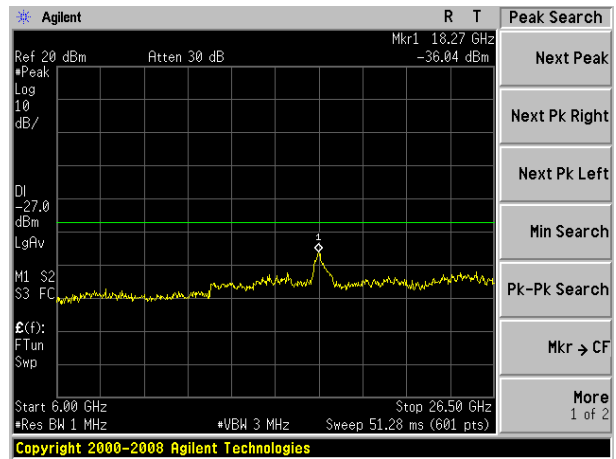

Test Plot

802.11ac20 on channel 48

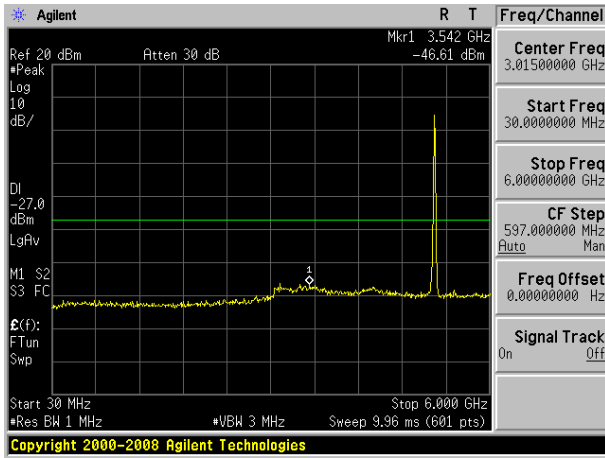

802.11ac40 on channel 38

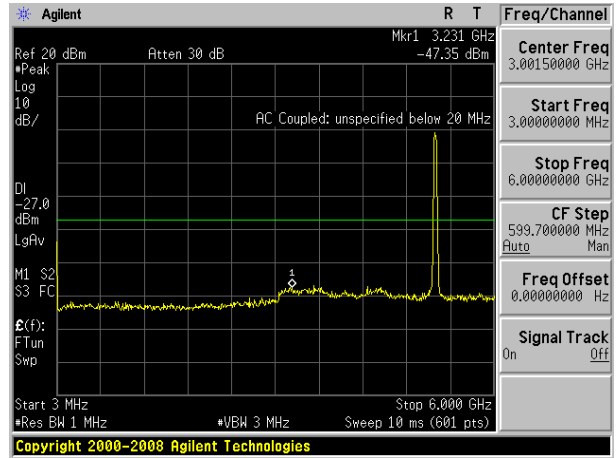

802.11ac20 on channel 48

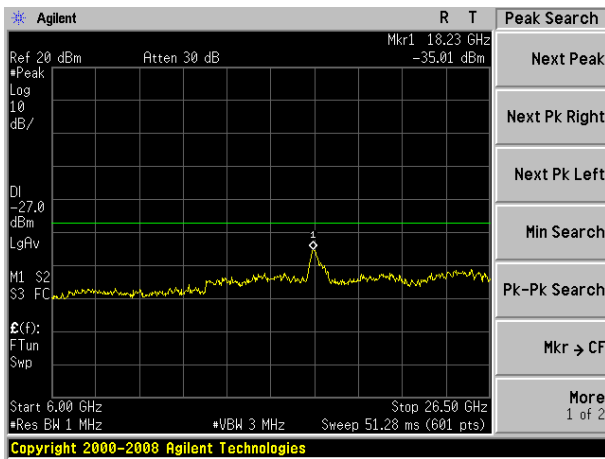

802.11ac40 on channel 38

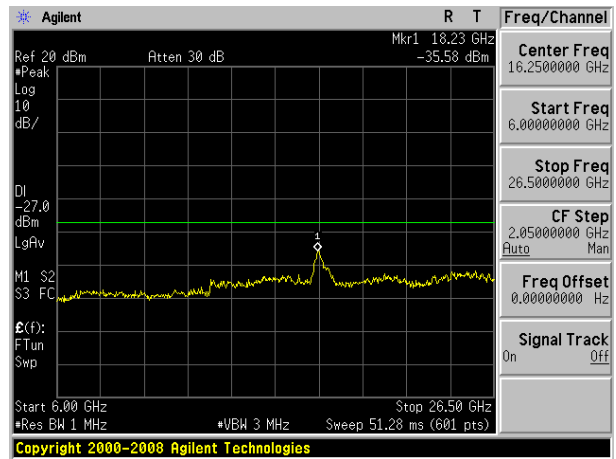

Test Plot

802.11ac40 on channel 46

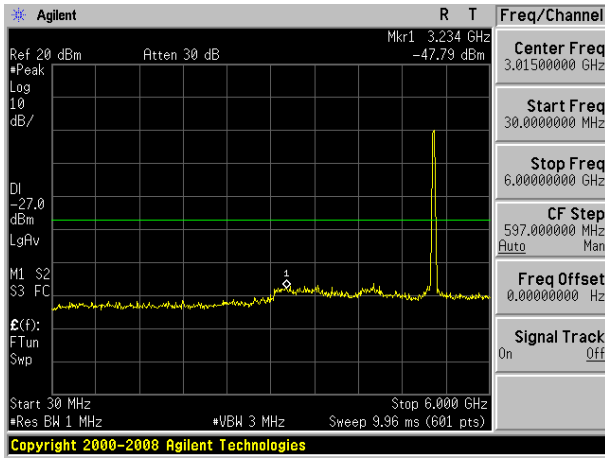

802.11ac80 on channel 42

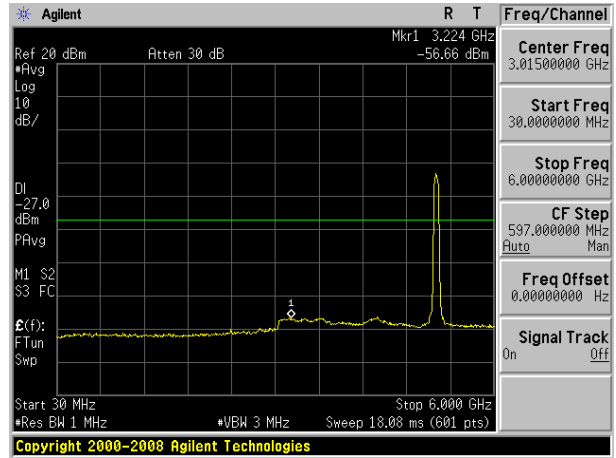

802.11 ac40 on channel 46

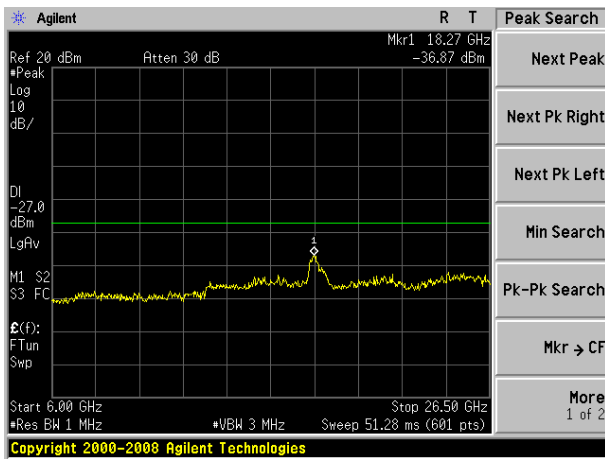

802.11 ac80 on channel 42

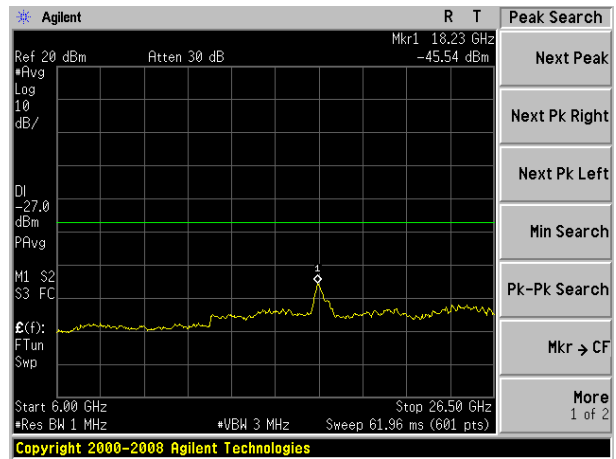

5.8G

Test Plot

802.11a on channel 149

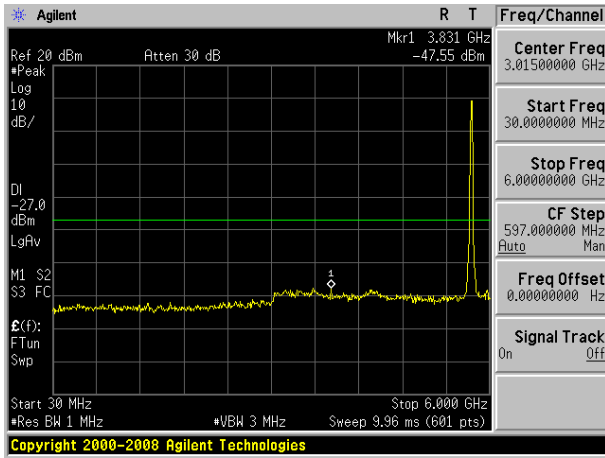

802.11a on channel 157

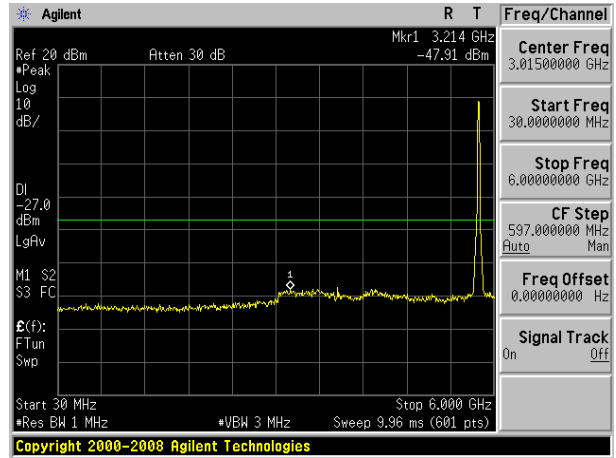

802.11a on channel 149

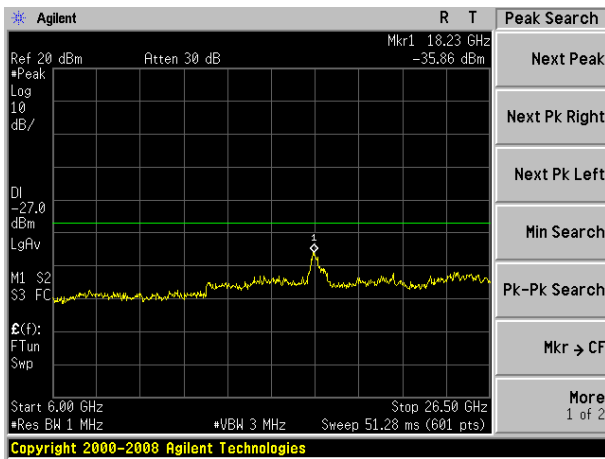

802.11a on channel 157

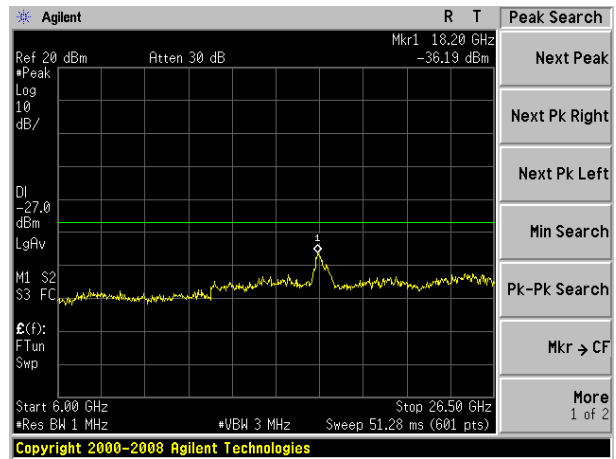

Test Plot

802.11a on channel 165

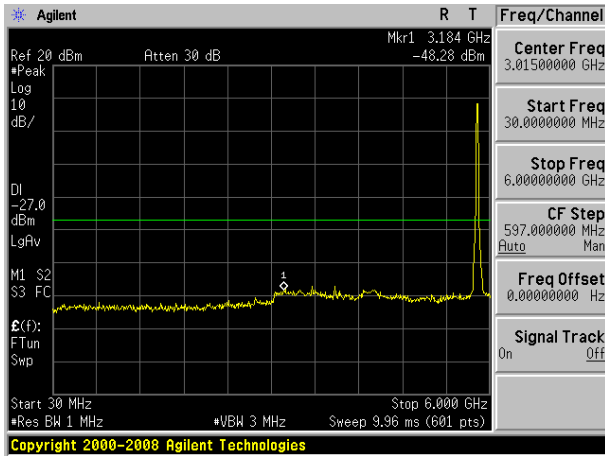

802.11n20 on channel 149

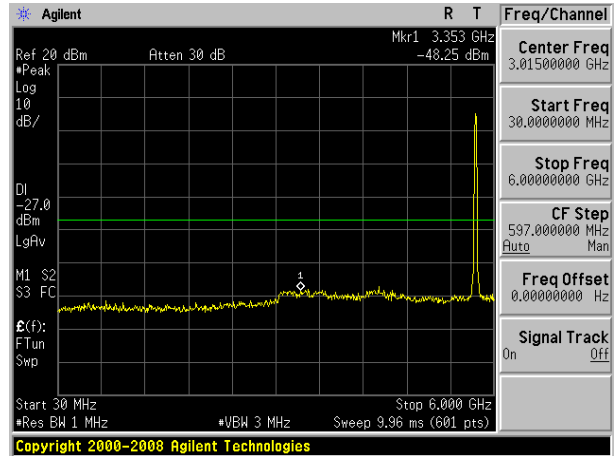

802.11a on channel 165

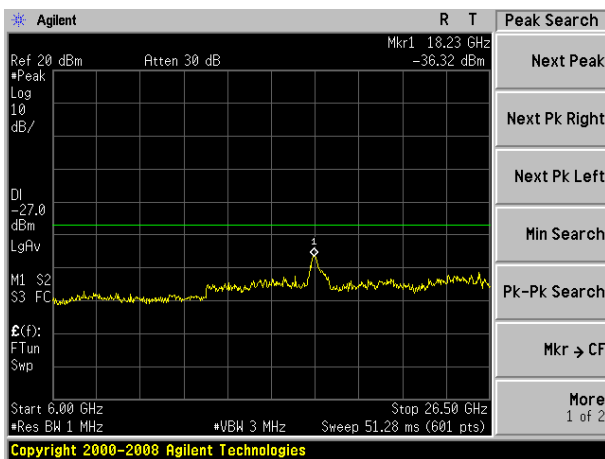

802.11n20 on channel 149

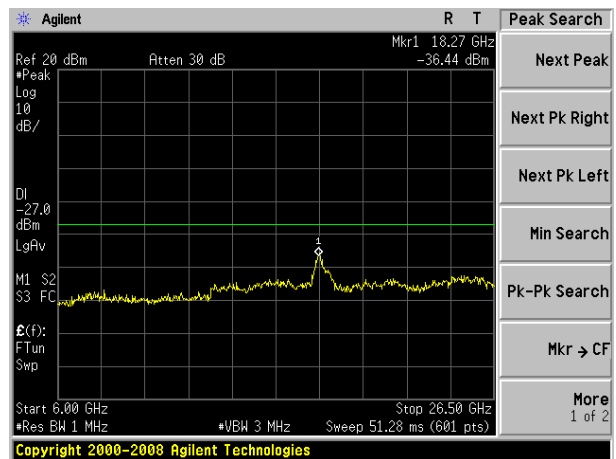

Test Plot

802.11n20 on channel 157

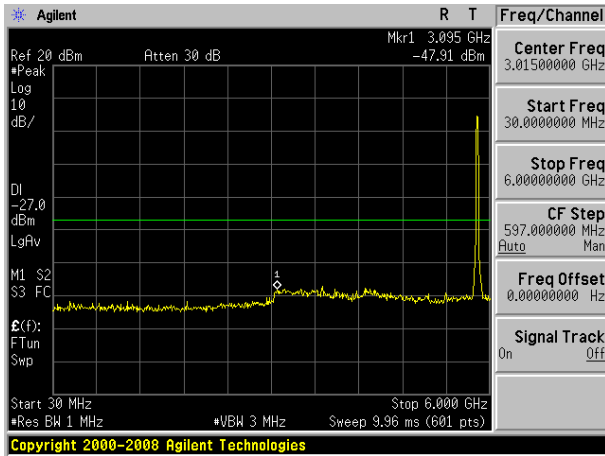

802.11n20 on channel 165

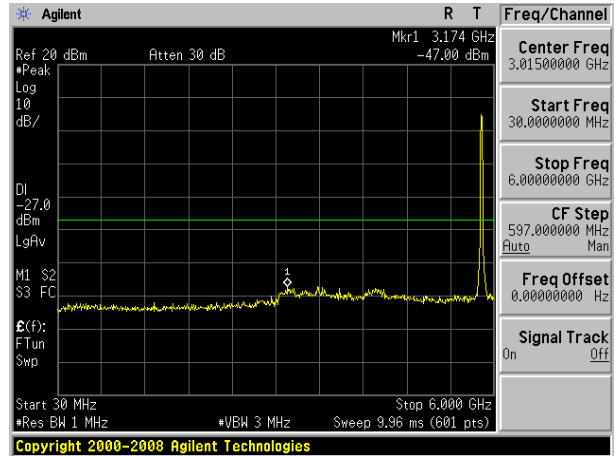

802.11n20 on channel 157

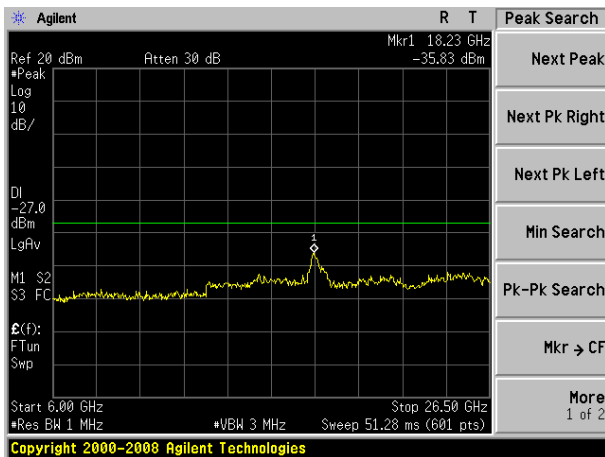

802.11n20 on channel 165

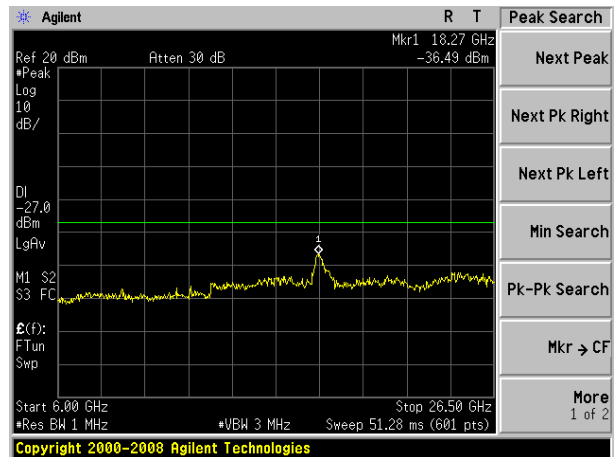

Test Plot

802.11n40 on channel 151

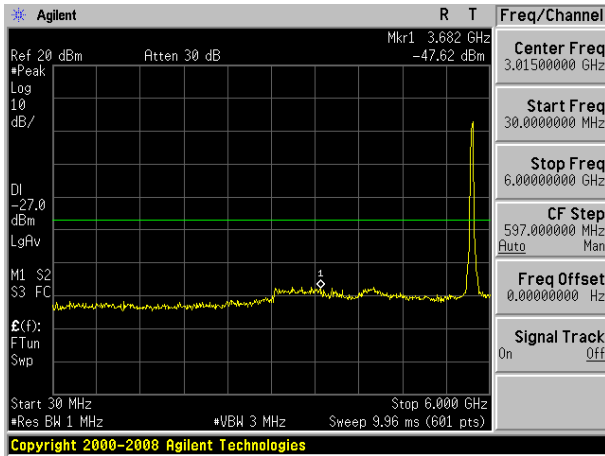

802.11n40 on channel 159

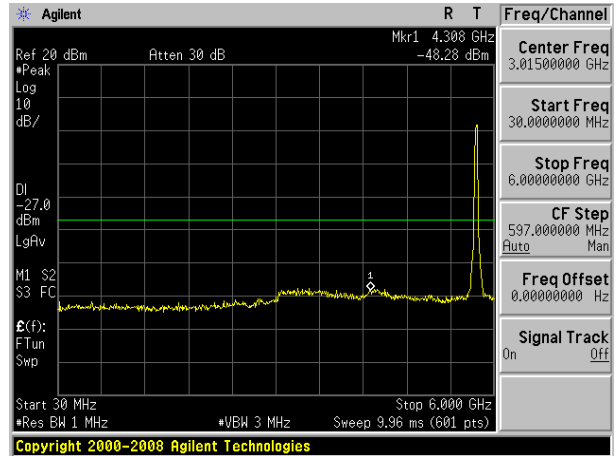

802.11n40 on channel 151

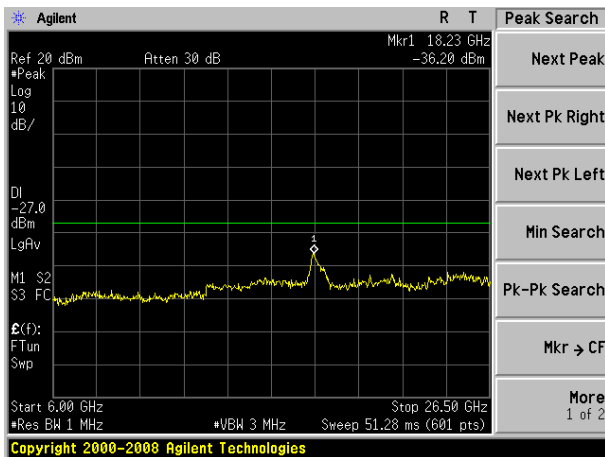

802.11n40 on channel 159

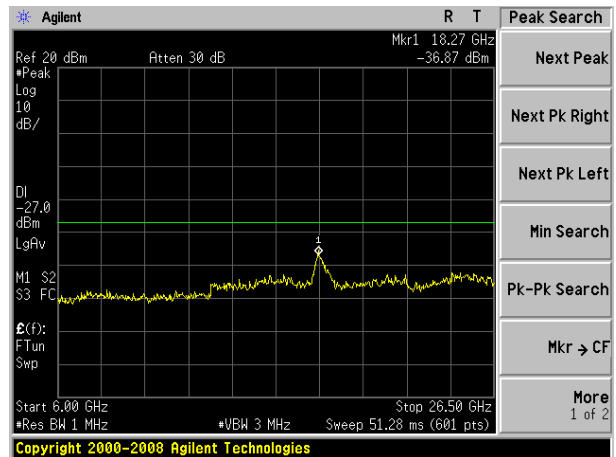

Test Plot

802.11ac20 on channel 149

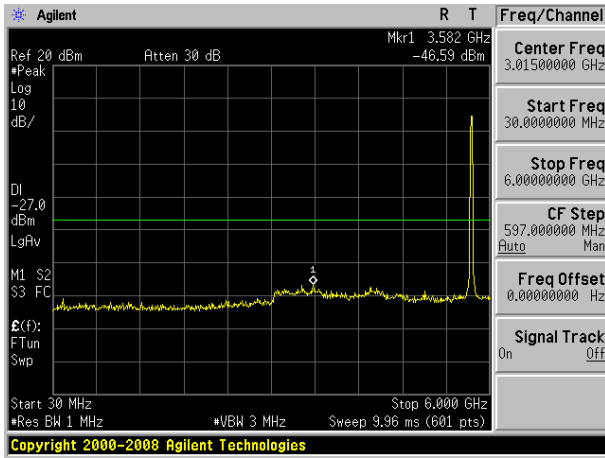

802.11ac20 on channel 157

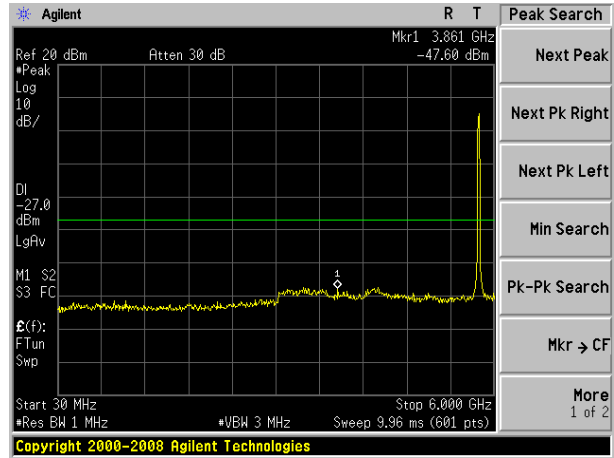

802.11ac20 on channel 149

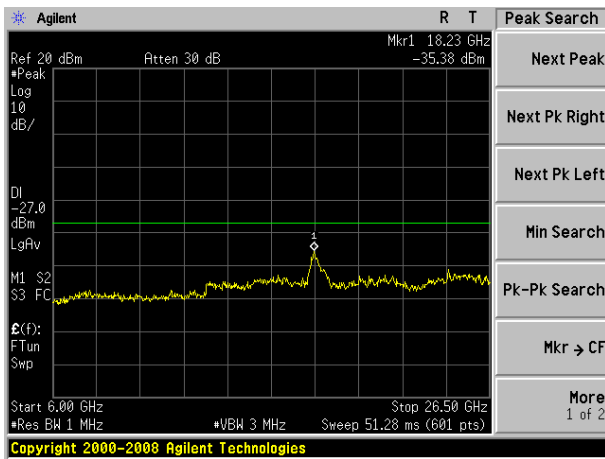

802.11ac20 on channel 157

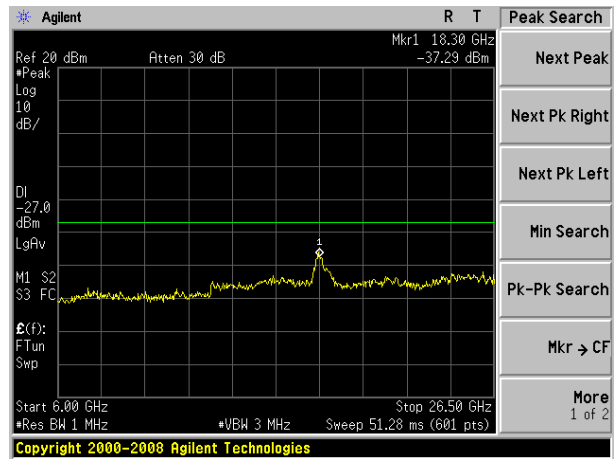

Test Plot

802.11ac20 on channel 165

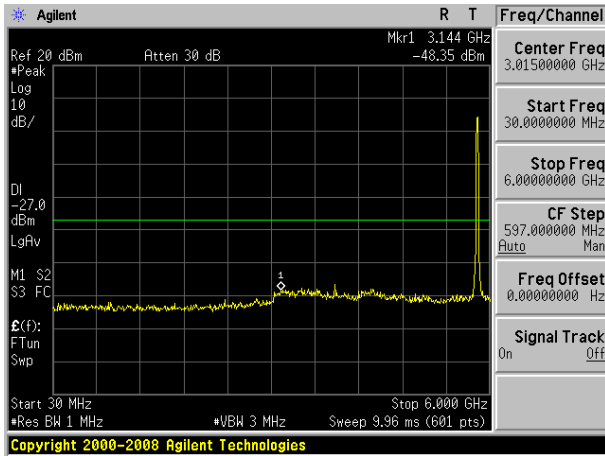

802.11ac40 on channel 151

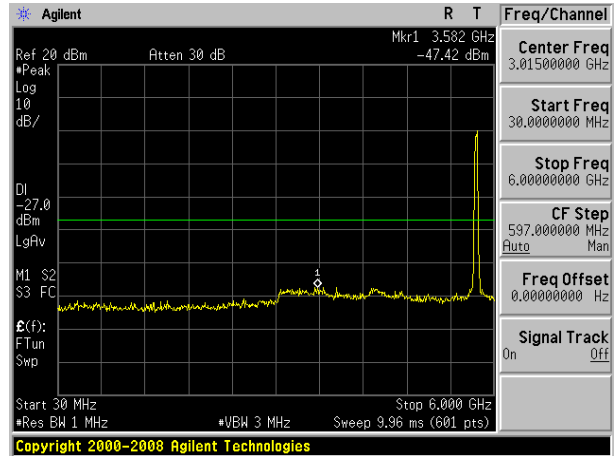

802.11ac20 on channel 165

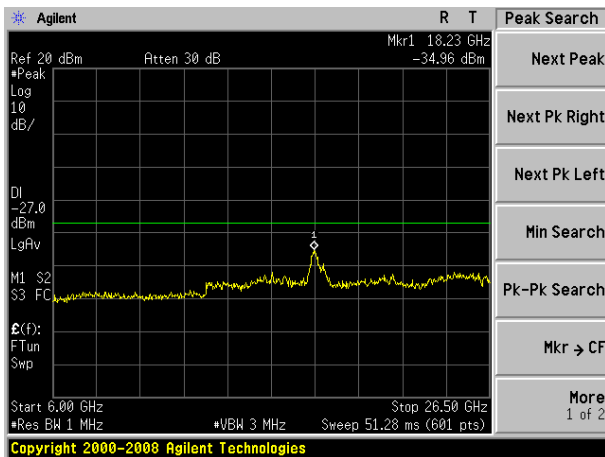

802.11ac40 on channel 151

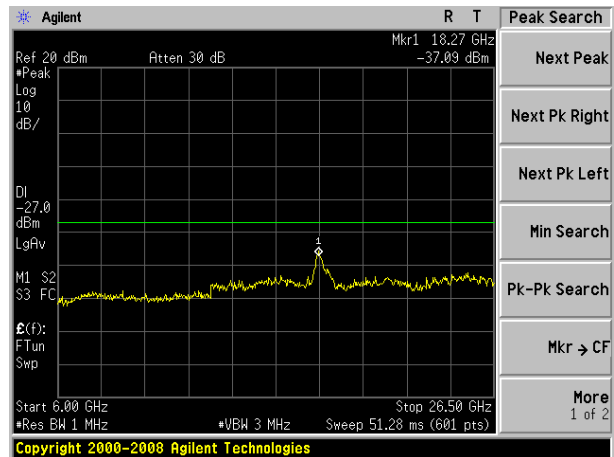

Test Plot

802.11ac40 on channel 159

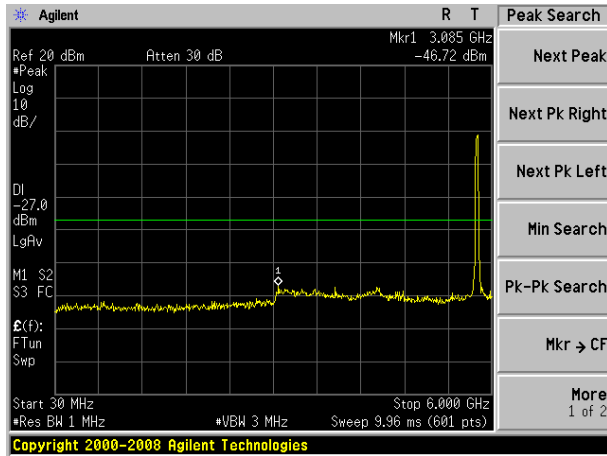

802.11ac80 on channel 155

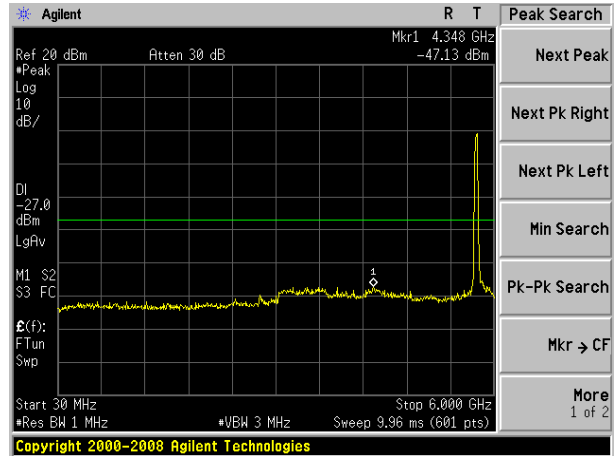

802.11 ac40 on channel 159

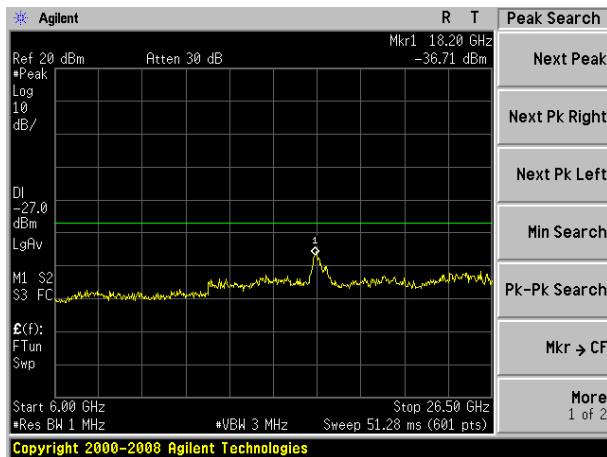

802.11 ac80 on channel 155

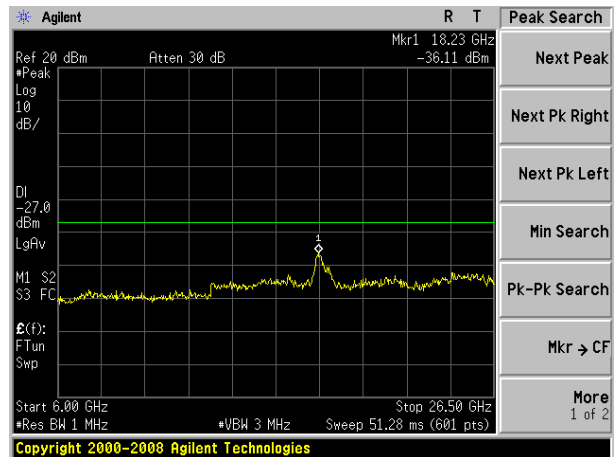

10. Frequency Stability Measurement

10.1 LIMIT

Manufacturers of U-NII devices are responsible for ensuring frequency stability such that an emission is maintained within the band of operation under all conditions of normal operation as specified in the user's manual.

The transmitter center frequency tolerance shall be ± 20 ppm maximum for the 5 GHz band (IEEE 802.11n specification).

10.2 TEST PROCEDURES

1. The transmitter output (antenna port) was connected to the spectrum analyzer.
2. EUT have transmitted absence of modulation signal and fixed channelize.
3. Set the spectrum analyzer span to view the entire absence of modulation emissions bandwidth.
4. Set RBW = 10 kHz, VBW = 10 kHz with peak detector and maxhold settings.
5. f_c is declaring of channel frequency. Then the frequency error formula is $(f_c - f) / f_c \times 10^6$ ppm and the limit is less than ± 20 ppm (IEEE 802.11n specification).
6. The test extreme voltage is to change the primary supply voltage from 85 to 115 percent of the nominal value
7. Extreme temperature is $-20^\circ\text{C} \sim 70^\circ\text{C}$.

10.3 TEST SETUP LAYOUT

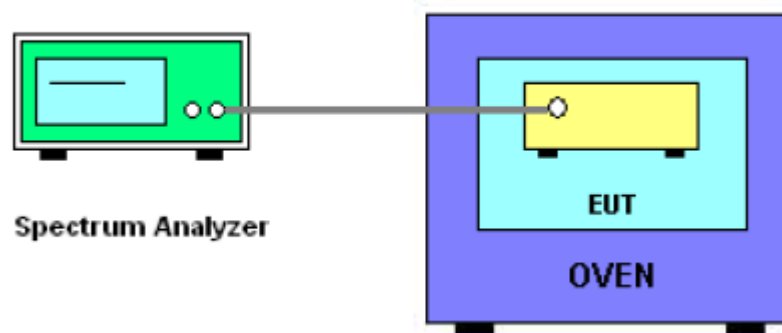

10.4 EUT OPERATION DURING TEST

The EUT was programmed to be in continuously un-modulation transmitting mode.

10.5 TEST RESULTS

EUT :	8-Inch Fully Ruggedized Tablet	Model Name :	SV-86
Temperature :	25 °C	Relative Humidity :	60%
Pressure :	1015 hPa	Test Voltage :	DC 3.7V
Test Mode :	TX Frequency(5150-5250MHz)		

Voltage vs. Frequency Stability

TEST CONDITIONS				Reference Frequency: 5180MHz			
				f	fc	Max. Deviation (MHz)	Max. Deviation (ppm)
T nom (°C)	20	V nom (V)	3.70	5180.01172	5180	0.01172	-2.2625
		V max (V)	4.26	5180.01081	5180	0.01081	-2.0869
		V min (V)	3.15	5180.01169	5180	0.01169	-2.2568
Limits				± 20 ppm			
Result				Complies			

Temperature vs. Frequency Stability

TEST CONDITIONS				Reference Frequency: 5180MHz			
				f	fc	Max. Deviation (MHz)	Max. Deviation (ppm)
V nom (V)	3.7	T (°C)	-20	5180.01078	5180	0.01078	-2.0811
		T (°C)	-10	5180.01075	5180	0.01075	-2.0753
		T (°C)	0	5180.01154	5180	0.01154	-2.2278
		T (°C)	10	5180.01175	5180	0.01175	-2.2683
		T (°C)	20	5180.01172	5180	0.01172	-2.2625
		T (°C)	30	5180.01171	5180	0.01171	-2.2606
		T (°C)	40	5180.01116	5180	0.01116	-2.1544
		T (°C)	50	5180.01187	5180	0.01187	-2.2915
		T (°C)	60	5180.01119	5180	0.01119	-2.1602
		T (°C)	70	5180.01175	5180	0.01175	-2.2683
Limits				± 20 ppm			
Result				Complies			

Voltage vs. Frequency Stability

TEST CONDITIONS				Reference Frequency: 5200MHz			
				f	fc	Max. Deviation (MHz)	Max. Deviation (ppm)
T nom (°C)	20	V nom (V)	3.70	5200.01245	5200	0.01245	-2.3942
		V max (V)	4.26	5200.01175	5200	0.01175	-2.2596
		V min (V)	3.15	5200.01212	5200	0.01212	-2.3308
Limits				± 20 ppm			
Result				Complies			

Temperature vs. Frequency Stability

TEST CONDITIONS				Reference Frequency: 5200MHz			
				f	fc	Max. Deviation (MHz)	Max. Deviation (ppm)
V nom (V)	3.7	T (°C)	-20	5200.01018	5200	0.01018	-1.9577
		T (°C)	-10	5200.01119	5200	0.01119	-2.1519
		T (°C)	0	5200.01188	5200	0.01188	-2.2846
		T (°C)	10	5200.01195	5200	0.01195	-2.2981
		T (°C)	20	5200.01245	5200	0.01245	-2.3942
		T (°C)	30	5200.01186	5200	0.01186	-2.2808
		T (°C)	40	5200.01158	5200	0.01158	-2.2269
		T (°C)	50	5200.01168	5200	0.01168	-2.2462
		T (°C)	60	5200.01203	5200	0.01203	-2.3135
		T (°C)	70	5200.01209	5200	0.01209	-2.3250
Limits				± 20 ppm			

Voltage vs. Frequency Stability

TEST CONDITIONS				Reference Frequency: 5240MHz			
				f	fc	Max. Deviation (MHz)	Max. Deviation (ppm)
T nom (°C)	20	V nom (V)	3.70	5240.01085	5240	0.01085	-2.0706
		V max (V)	4.26	5240.01198	5240	0.01198	-2.2863
		V min (V)	3.15	5240.01281	5240	0.01281	-2.4447
Limits				± 20 ppm			
Result				Complies			

Temperature vs. Frequency Stability

TEST CONDITIONS				Reference Frequency: 5240MHz			
				f	fc	Max. Deviation (MHz)	Max. Deviation (ppm)
V nom (V)	3.7	T (°C)	-20	5240.01082	5240	0.01082	-2.0649
		T (°C)	-10	5240.00967	5240	0.00967	-1.8454
		T (°C)	0	5240.01082	5240	0.01082	-2.0649
		T (°C)	10	5240.01019	5240	0.01019	-1.9447
		T (°C)	20	5240.01085	5240	0.01085	-2.0706
		T (°C)	30	5240.01102	5240	0.01102	-2.1031
		T (°C)	40	5240.01229	5240	0.01229	-2.3454
		T (°C)	50	5240.01202	5240	0.01202	-2.2939
		T (°C)	60	5240.00936	5240	0.00936	-1.7863
		T (°C)	70	5240.01016	5240	0.01016	-1.9389
Limits				± 20 ppm			

EUT :	8-Inch Fully Ruggedized Tablet	Model Name :	SV-86
Temperature :	25 °C	Relative Humidity :	60%
Pressure :	1015 hPa	Test Voltage :	DC 3.7V
Test Mode :	TX Frequency(5745-5850MHz)		

Voltage vs. Frequency Stability

TEST CONDITIONS				Reference Frequency: 5745MHz			
				f	fc	Max. Deviation (MHz)	Max. Deviation (ppm)
T nom (°C)	20	V nom (V)	3.70	5745.01321	5745	0.01321	-2.2994
		V max (V)	4.26	5745.01350	5745	0.01350	-2.3499
		V min (V)	3.15	5745.01452	5745	0.01452	-2.5274
Limits				± 20 ppm			
Result				Complies			

Temperature vs. Frequency Stability

TEST CONDITIONS				Reference Frequency: 5745MHz			
				f	fc	Max. Deviation (MHz)	Max. Deviation (ppm)
V nom (V)	3.7	T (°C)	-20	5745.01228	5745	0.01228	-2.1375
		T (°C)	-10	5745.01243	5745	0.01243	-2.1636
		T (°C)	0	5745.01252	5745	0.01252	-2.1793
		T (°C)	10	5745.01263	5745	0.01263	-2.1984
		T (°C)	20	5745.01321	5745	0.01321	-2.2994
		T (°C)	30	5745.01452	5745	0.01452	-2.5274
		T (°C)	40	5745.01215	5745	0.01215	-2.1149
		T (°C)	50	5745.01227	5745	0.01227	-2.1358
		T (°C)	60	5745.01323	5745	0.01323	-2.3029
		T (°C)	70	5745.01240	5745	0.01240	-2.1584
Limits				± 20 ppm			
Result				Complies			

Voltage vs. Frequency Stability

TEST CONDITIONS				Reference Frequency: 5785MHz			
				f	fc	Max. Deviation (MHz)	Max. Deviation (ppm)
T nom (°C)	20	V nom (V)	3.70	5785.01517	5785	0.01517	-2.6223
		V max (V)	4.26	5785.01352	5785	0.01352	-2.3371
		V min (V)	3.15	5785.01345	5785	0.01345	-2.3250
Limits				± 20 ppm			
Result				Complies			

Temperature vs. Frequency Stability

TEST CONDITIONS				Reference Frequency: 5785MHz			
				f	fc	Max. Deviation (MHz)	Max. Deviation (ppm)
V nom (V)	3.7	T (°C)	-20	5785.01219	5785	0.01219	-2.1072
		T (°C)	-10	5785.01519	5785	0.01519	-2.6258
		T (°C)	0	5785.01525	5785	0.01525	-2.6361
		T (°C)	10	5785.01392	5785	0.01392	-2.4062
		T (°C)	20	5785.01517	5785	0.01517	-2.6223
		T (°C)	30	5785.01657	5785	0.01657	-2.8643
		T (°C)	40	5785.01651	5785	0.01651	-2.8539
		T (°C)	50	5785.01547	5785	0.01547	-2.6742
		T (°C)	60	5785.01659	5785	0.01659	-2.8678
		T (°C)	70	5785.01656	5785	0.01656	-2.8626
Limits				± 20 ppm			
Result				Complies			

Voltage vs. Frequency Stability

TEST CONDITIONS				Reference Frequency: 5825MHz			
				f	fc	Max. Deviation (MHz)	Max. Deviation (ppm)
T nom (°C)	20	V nom (V)	3.70	5825.01353	5825	0.01353	-2.3227
		V max (V)	4.26	5825.01275	5825	0.01275	-2.1888
		V min (V)	3.15	5825.01246	5825	0.01246	-2.1391
Limits				± 20 ppm			
Result				Complies			

Temperature vs. Frequency Stability

TEST CONDITIONS				Reference Frequency: 5825MHz			
				f	fc	Max. Deviation (MHz)	Max. Deviation (ppm)
V nom (V)	3.7	T (°C)	-20	5825.01455	5825	0.01455	-2.4979
		T (°C)	-10	5825.01452	5825	0.01452	-2.4927
		T (°C)	0	5825.01382	5825	0.01382	-2.3725
		T (°C)	10	5825.01283	5825	0.01283	-2.2026
		T (°C)	20	5825.01353	5825	0.01353	-2.3227
		T (°C)	30	5825.01322	5825	0.01322	-2.2695
		T (°C)	40	5825.01229	5825	0.01229	-2.1099
		T (°C)	50	5825.01263	5825	0.01263	-2.1682
		T (°C)	60	5825.01304	5825	0.01304	-2.2386
		T (°C)	70	5825.01226	5825	0.01226	-2.1047
Limits				± 20 ppm			
Result				Complies			

11. ANTENNA REQUIREMENT

11.1 STANDARD REQUIREMENT

15.203 requirement: For intentional device, according to 15.203: an intentional radiator shall be designed to ensure that no antenna other than that furnished by the responsible party shall be used with the device.

11.2 EUT ANTENNA

The EUT antenna is permanent attached FPCB antenna. It comply with the standard requirement.

END OF REPORT