

FCC REPORT

(LTE)

Applicant: Industria Fueguina de Relojeria Electronica S.A.
Address of Applicant: Sarmiento 2920, Rio Grande CP(9420). Tierra del Fuego

Equipment Under Test (EUT)

Product Name: Smartphone
Model No.: Smartway L1 Pro
Trade mark: KODAK

FCC ID: 2ALP3-L1PRO

Applicable standards: FCC CFR Title 47 Part 2
FCC CFR Title 47 Part 24 Subpart E
FCC CFR Title 47 Part 27 Subpart L
FCC CFR Title 47 Part 27 Subpart M

Date of sample receipt: 05 Aug., 2020

Date of Test: 05 Aug., to 03 Sep., 2020

Date of report issued: 04 Sep., 2020

Test Result: PASS*

*In the configuration tested, the EUT complied with the standards specified above.

Authorized Signature:



Bruce Zhang
Laboratory Manager

This report details the results of the testing carried out on one sample. The results contained in this test report do not relate to other samples of the same product and does not permit the use of the CCIS product certification mark. The manufacturer should ensure that all products in series production are in conformity with the product sample detailed in this report.

This report may only be reproduced and distributed in full. If the product in this report is used in any configuration other than that detailed in the report, the manufacturer must ensure the new system complies with all relevant standards.

This document cannot be reproduced except in full, without prior written approval of the Company. Any unauthorized alteration, forgery or falsification of the content or appearance of this document is unlawful, and offenders may be prosecuted to the fullest extent of the law. Unless otherwise stated the results shown in this test report refer only to the sample(s) tested and such sample(s) are retained for 90 days only.

2. Version

Version No.	Date	Description
00	04 Sep., 2020	Original

Tested by: Yoyo Wu **Date:** 04 Sep., 2020
Test Engineer

Reviewed by: Winner Zhang **Date:** 04 Sep., 2020
Project Engineer

3. Contents

	Page
1. COVER PAGE	1
2. VERSION	2
3. CONTENTS	3
4. TEST SUMMARY	4
5. GENERAL INFORMATION	5
5.1 CLIENT INFORMATION.....	5
5.2 GENERAL DESCRIPTION OF E.U.T.....	5
5.3 TEST ENVIRONMENT AND MODE, AND TEST SAMPLES PLANS	10
5.4 DESCRIPTION OF SUPPORT UNITS.....	10
5.5 MEASUREMENT UNCERTAINTY.....	10
5.6 RELATED SUBMITTAL(S) / GRANT (S)	10
5.7 ADDITIONS TO, DEVIATIONS, OR EXCLUSIONS FROM THE METHOD	10
5.8 LABORATORY FACILITY	10
5.9 LABORATORY LOCATION	10
5.10 TEST INSTRUMENTS LIST	11
6. TEST RESULTS	12
6.1 CONDUCTED OUTPUT POWER, ERP AND EIRP	12
6.2 PEAK-TO-AVERAGE RATIO.....	21
6.3 OCCUPY BANDWIDTH	24
6.4 OUT OF BAND EMISSION AT ANTENNA TERMINALS	60
6.5 FIELD STRENGTH OF SPURIOUS RADIATION MEASUREMENT.....	85
6.6 FREQUENCY STABILITY V.S. TEMPERATURE MEASUREMENT.....	93
6.7 FREQUENCY STABILITY V.S. VOLTAGE MEASUREMENT	97
7 TEST SETUP PHOTO	99
8 EUT CONSTRUCTIONAL DETAILS	100

4. Test Summary

Test Items	Section in CFR 47	Result
RF Exposure (SAR)	Part 1.1307 Part 2.1093	Passed (Please refer to SAR Report)
RF Output Power	Part 2.1046 Part 24.232 (c) Part 27.50 (d)(4) Part 27.50 (h)(2)	Pass
Peak-to-Average Ratio	Part 24.232 (d) Part 27.50(d)(5)	Pass
Modulation Characteristics	Part 2.1047	Pass
99% & -26 dB Occupied Bandwidth	Part 2.1049 Part 24.238(b) Part 27.53(h) Part 27.53(m)	Pass
Out of band emission at antenna terminals	Part 2.1053 Part 24.238 (a) Part 27.53 (h) Part 27.53(m)	Pass
Field strength of spurious radiation	Part 24.238 (a) Part 27.53 (h) Part 27.53(m)	Pass
Frequency stability vs. temperature	Part 22.355 Part 24.235 Part 27.54 Part 2.1055(a)(1)(b)	Pass
Frequency stability vs. voltage	Part 22.355 Part 24.235 Part 27.54 Part 2.1055(d)(2)	Pass
<p>Remark:</p> <ol style="list-style-type: none"> 1. Pass: The EUT complies with the essential requirements in the standard. 2. The cable insertion loss used by "RF Output Power" and other conduction measurement items is 0.5dB(Fundamental Frequency below 1GHz)/1.0dB(Fundamental Frequency above 1GHz) (provided by the customer). 		
Test Method:	ANSI/TIA-603-E-2016 ANSI C63.26-2015	

5. General Information

5.1 Client Information

Applicant:	Industria Fuegoína de Relojería Electronica S.A.
Address:	Sarmiento 2920, Rio Grande CP(9420). Tierra del Fuego
Manufacturer:	HK I-SWIM TECHNOLOGY CO., LIMITED
Address:	RM 1405, 14/F., LUCKY CENTRE, 165 WANCHAI ROAD, WANCHAI, HK

5.2 General Description of E.U.T.

Product Name:	Smartphone
Model No.:	Smartway L1 Pro
Operation Frequency range:	LTE Band 2: TX: 1850MHz-1910MHz, RX: 1930MHz-1990MHz LTE Band 4: TX: 1710MHz-1755MHz, RX: 2110MHz-2155MHz LTE Band 7: TX: 2500MHz-2570MHz, RX: 2620MHz-2690MHz
Modulation type:	QPSK, 16QAM
Antenna type:	Internal Antenna
Antenna gain:	LTE Band 2: 0.22dBi LTE Band 4: 0.17dBi LTE Band 7: 0.13dBi
Power supply:	Rechargeable Li-ion Battery DC3.8V-2700mAh
AC adapter:	Model: KA1508-0501000AR Input: AC100-240V, 50/60Hz, 0.2A Output: DC 5.0V, 1000mA
Test Sample Condition:	The applicant provided engineering samples for staying in continuously transmitting for testing.

Operation Frequency List:

LTE Band 2 (1.4MHz)		LTE Band 2 (3MHz)	
Channel	Frequency (MHz)	Channel	Frequency (MHz)
18607	1850.70	18615	1851.50
18608	1850.80	18616	1851.60
....
18899	1879.90	18899	1879.90
18900	1880.00	18900	1880.00
18901	1880.10	18901	1880.10
...
19193	1909.20	19185	1908.40
19194	1909.30	19186	1908.50
LTE Band 2 (5MHz)		LTE Band 2 (10MHz)	
Channel	Frequency (MHz)	Channel	Frequency (MHz)
18625	1852.50	18650	1855.00
18626	1852.60	18651	1855.10
....
18899	1879.90	18899	1879.90
18900	1880.00	18900	1880.00
18901	1880.10	18901	1880.10
...
19175	1907.40	19150	1904.90
19176	1907.50	19151	1905.00
LTE Band 2 (15MHz)		LTE Band 2 (20MHz)	
Channel	Frequency (MHz)	Channel	Frequency (MHz)
18675	1857.50	18700	1860.00
18676	1857.60	18701	1860.10
....
18899	1879.90	18899	1879.90
18900	1880.00	18900	1880.00
18901	1880.10	18901	1880.10
...
19125	1902.40	19100	1899.90
19126	1902.50	19101	1900.00

LTE Band 4 (1.4MHz)		LTE Band 4 (3MHz)	
Channel	Frequency (MHz)	Channel	Frequency (MHz)
19957	1710.70	19965	1711.50
19958	1710.80	19966	1711.60
....
20174	1732.40	20174	1732.40
20175	1732.50	20175	1732.50
20176	1732.60	20176	1732.60
...
20392	1754.20	20384	1753.40
20393	1754.30	20385	1753.50
LTE Band 4 (5MHz)		LTE Band 4 (10MHz)	
Channel	Frequency (MHz)	Channel	Frequency (MHz)
19975	1712.50	20000	1715.00
19976	1712.60	20001	1715.10
....
20174	1732.40	20174	1732.40
20175	1732.50	20175	1732.50
20176	1732.60	20176	1732.60
...
20374	1752.40	20349	1749.90
20375	1752.50	20350	1750.00
LTE Band 4 (15MHz)		LTE Band 4 (20MHz)	
Channel	Frequency (MHz)	Channel	Frequency (MHz)
20025	1717.50	20050	1720.00
20026	1717.60	20051	1720.10
....
20174	1732.40	20174	1732.40
20175	1732.50	20175	1732.50
20176	1732.60	20176	1732.60
...
20324	1747.40	20299	1744.90
20325	1747.50	20300	1745.00

LTE Band 7 (5MHz)		LTE Band 7 (10MHz)	
Channel	Frequency (MHz)	Channel	Frequency (MHz)
20775	2502.50	20800	2505.00
20776	2502.60	20801	2502.10
....
21099	2534.90	21099	2534.90
21100	2535.00	21100	2535.00
21101	2535.20	21101	2535.20
...
21424	2567.40	21399	2564.90
21425	2567.50	21400	2565.00
LTE Band 7 (15MHz)		LTE Band 7 (20MHz)	
Channel	Frequency (MHz)	Channel	Frequency (MHz)
20825	2507.50	20850	2510.00
20826	2507.60	20851	2510.10
....
21099	2534.90	21099	2534.90
21100	2535.00	21100	2535.00
21101	2535.20	21101	2535.20
...
21374	2562.40	21349	2559.90
21375	2562.50	21350	2560.00

Regards to the operating frequency range, the lowest frequency, the middle frequency, and the highest frequency of channel were selected to perform the test, and the selected channels as below:

LTE Band 2 (1.4MHz)			LTE Band 2 (3MHz)		
Channel	Frequency (MHz)		Channel	Frequency (MHz)	
Lowest channel	18607	1850.70	Lowest channel	18615	1851.50
Middle channel	18900	1880.00	Middle channel	18900	1880.00
Highest channel	19193	1909.30	Highest channel	19185	1908.50
LTE Band 2 (5MHz)			LTE Band 2 (10MHz)		
Channel	Frequency (MHz)		Channel	Frequency (MHz)	
Lowest channel	18625	1852.50	Lowest channel	18650	1855.00
Middle channel	18900	1880.00	Middle channel	18900	1880.00
Highest channel	19175	1907.50	Highest channel	19150	1905.00
LTE Band 2 (15MHz)			LTE Band 2 (20MHz)		
Channel	Frequency (MHz)		Channel	Frequency (MHz)	
Lowest channel	18675	1857.50	Lowest channel	18700	1860.00
Middle channel	18900	1880.00	Middle channel	18900	1880.00
Highest channel	19125	1902.50	Highest channel	19100	1900.00

LTE Band 4 (1.4MHz)			LTE Band 4 (3MHz)		
Channel:	Frequency (MHz)		Channel	Frequency (MHz)	
Lowest channel	19957	1710.70	Lowest channel	19965	1711.50
Middle channel	20175	1732.50	Middle channel	20175	1732.50
Highest channel	20393	1754.30	Highest channel	20385	1753.50
LTE Band 4 (5MHz)			LTE Band 4 (10MHz)		
Channel	Frequency (MHz)		Channel	Frequency (MHz)	
Lowest channel	19975	1712.50	Lowest channel	20000	1715.00
Middle channel	20175	1732.50	Middle channel	20175	1732.50
Highest channel	20375	1752.50	Highest channel	20350	1750.00
LTE Band 4 (15MHz)			LTE Band 4 (20MHz)		
Channel	Frequency (MHz)		Channel	Frequency (MHz)	
Lowest channel	20025	1717.50	Lowest channel	20050	1720.00
Middle channel	20175	1732.50	Middle channel	20175	1732.50
Highest channel	20325	1747.50	Highest channel	20300	1745.00

LTE Band 7 (5MHz)			LTE Band 7 (10MHz)		
Channel	Frequency (MHz)		Channel	Frequency (MHz)	
Lowest channel	20775	2502.50	Lowest channel	20800	2505.00
Middle channel	21100	2535.00	Middle channel	21100	2535.00
Highest channel	21425	2567.50	Highest channel	21400	2565.00
LTE Band 7 (15MHz)			LTE Band 7 (20MHz)		
Channel	Frequency (MHz)		Channel	Frequency (MHz)	
Lowest channel	20825	2507.50	Lowest channel	20850	2510.00
Middle channel	21100	2535.00	Middle channel	21100	2535.00
Highest channel	21375	2562.50	Highest channel	21350	2560.00

5.3 Test environment and mode, and test samples plans

Operating Environment:	
Temperature:	Normal: 15°C ~ 35°C, Extreme: -30°C ~ +50°C
Humidity:	20 % ~ 75 % RH
Atmospheric Pressure:	1008 mbar
Voltage:	Nominal: 3.8Vdc, Extreme: Low 3.5Vdc, High 4.35Vdc
Test mode:	
LTE QPSK mode	Keep the EUT communication with simulated station in QPSK mode
LTE 16-QAM mode	Keep the EUT communication with simulated station in 16-QAM mode
Remark: The EUT has been tested under continuous transmitting mode. Channel Low, Mid and High for each type band with rated data rate were chosen for full testing. The field strength of spurious radiation emission was measured as EUT stand-up position (H mode) and lie down position (E1, E2 mode) for these modes. Just the worst case position (H mode) shown in report.	

5.4 Description of Support Units

Test Equipment	Manufacturer	Model No.	Serial No.
Simulated Station	Anritsu	MT8820C	6201026545

5.5 Measurement Uncertainty

Parameters	Expanded Uncertainty
Radiated Emission (9kHz ~ 30MHz)	±3.12 dB (k=2)
Radiated Emission (30MHz ~ 1000MHz)	±4.32 dB (k=2)
Radiated Emission (1GHz ~ 18GHz)	±5.16 dB (k=2)
Radiated Emission (18GHz ~ 40GHz)	±3.20 dB (k=2)

5.6 Related Submittal(s) / Grant (s)

This is an original grant, no related submittals and grants.

5.7 Additions to, deviations, or exclusions from the method

No

5.8 Laboratory Facility

The test facility is recognized, certified, or accredited by the following organizations:

- **FCC - Designation No.: CN1211**
Shenzhen Zhongjian Nanfang Testing Co., Ltd. has been accredited as a testing laboratory by FCC (Federal Communications Commission). The test firm Registration No. is 727551.
- **ISED – CAB identifier.: CN0021**
The 3m Semi-anechoic chamber of Shenzhen Zhongjian Nanfang Testing Co., Ltd. has been Registered by Certification and Engineering Bureau of Industry Canada for radio equipment testing with Registration No.: 10106A-1.
- **A2LA - Registration No.: 4346.01**
This laboratory is accredited in accordance with the recognized International Standard ISO/IEC 17025:2005 General requirements for the competence of testing and calibration laboratories. The test scope can be found as below link: <https://portal.a2la.org/scopepdf/4346-01.pdf>

5.9 Laboratory Location

Shenzhen Zhongjian Nanfang Testing Co., Ltd.
Address: No.110~116, Building B, Jinyuan Business Building, Xixiang Road, Bao'an District, Shenzhen, Guangdong, China
Tel: +86-755-23118282, Fax: +86-755-23116366
Email: info@ccis-cb.com, Website: <http://www.ccis-cb.com>

5.10 Test Instruments list

Test Equipment	Manufacturer	Model No.	Serial No.	Cal. Date (mm-dd-yy)	Cal. Due date (mm-dd-yy)
3m SAC	SAEMC	9m*6m*6m	966	07-22-2020	07-21-2023
BiConiLog Antenna	SCHWARZBECK	VULB9163	497	03-18-2020	03-17-2021
Biconical Antenna	SCHWARZBECK	VUBA9117	359	06-22-2020	06-21-2021
Horn Antenna	SCHWARZBECK	BBHA9120D	916	03-07-2020	03-06-2021
Horn Antenna	SCHWARZBECK	BBHA9120D	1805	06-22-2020	06-21-2021
Horn Antenna	SCHWARZBECK	BBHA 9170	BBHA9170582	11-18-2019	11-17-2020
EMI Test Software	AUDIX	E3	Version: 6.110919b		
Pre-amplifier	HP	8447D	2944A09358	03-07-2020	03-06-2021
Pre-amplifier	CD	PAP-1G18	11804	03-07-2020	03-06-2021
Spectrum analyzer	Rohde & Schwarz	FSP30	101454	03-05-2020	03-04-2021
Spectrum analyzer	Rohde & Schwarz	FSP40	100363	11-18-2019	11-17-2020
EMI Test Receiver	Rohde & Schwarz	ESRP7	101070	03-05-2020	03-04-2021
Spectrum Analyzer	Agilent	N9020A	MY50510123	11-18-2019	11-17-2020
Signal Generator	Rohde & Schwarz	SMX	835454/016	03-05-2020	03-04-2021
Signal Generator	R&S	SMR20	1008100050	03-05-2020	03-04-2021
RF Switch Unit	MWRFTTEST	MW200	N/A	N/A	N/A
Test Software	MWRFTTEST	MTS8200	Version: 2.0.0.0		
Cable	ZDECL	Z108-NJ-NJ-81	1608458	03-07-2020	03-06-2021
Cable	MICRO-COAX	MFR64639	K10742-5	03-07-2020	03-06-2021
Cable	SUHNER	SUCOFLEX100	58193/4PE	03-07-2020	03-06-2021
DC Power Supply	XinNuoEr	WYK-10020K	1409050110020	09-25-2019	09-24-2020
Temperature Humidity Chamber	HengPu	HPGDS-500	20140828008	11-01-2019	11-31-2020
Simulated Station	Rohde & Schwarz	CMW500	140493	07-22-2020	07-21-2021

6. Test results

6.1 Conducted Output Power, ERP and EIRP

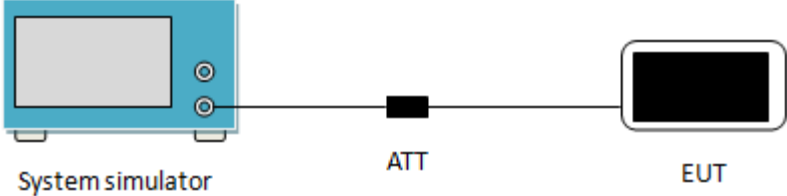
Test Requirement:	Part 24.232(c), Part 27.50(d)(4), Part 27.50 (h)(2)
Limit:	LTE Band 2: 2W, LTE Band 4: 1W, LTE Band 7: 2W
Test Setup:	 <p>The diagram illustrates the test setup. On the left is a blue 'System simulator' with a screen and two ports. A black line representing a cable connects it to a small black square labeled 'ATT' (attenuator). Another black line connects the 'ATT' to a black rectangular device labeled 'EUT' (Equipment Under Test).</p>
Test Procedure:	The transmitter output was connected to a calibrated attenuator, the other end of which was connected to the CMW500. Transmitter output power was read off in dBm.
Test Instruments:	Refer to section 5.10 for details
Test mode:	Refer to section 5.3 for details
Test results:	Passed

Measurement Data:

LTE Band	Bandwidth (MHz)	Modulation	RB Size	RB Offset	Average Power (dBm)				
					18607	18900	19193		
					1850.7MHz	1880.0MHz	1909.3MHz		
2	1.4	QPSK	1	0	22.96	23.73	22.74		
			1	2	22.99	23.78	22.77		
			1	5	22.96	23.80	22.77		
			3	0	22.87	23.18	22.89		
			3	1	22.85	23.19	22.94		
			3	2	22.46	23.05	22.45		
			6	0	22.35	22.86	22.14		
		Antenna Gain (dBi):					0.22		
		Max. EIRP (dBm):					24.02		
		EIRP Limit (dBm):					33.00		
		16QAM	1	0	21.84	23.55	23.09		
			1	2	21.80	23.53	23.11		
			1	5	21.80	23.52	23.05		
			3	0	22.26	23.10	22.41		
			3	1	22.27	23.14	22.38		
			3	2	21.53	22.33	21.43		
			6	0	21.49	22.05	21.23		
		Antenna Gain (dBi):					0.22		
		Max. EIRP (dBm):					23.77		
		EIRP Limit (dBm):					33.00		

LTE Band	Bandwidth (MHz)	Modulation	RB Size	RB Offset	Average Power (dBm)				
					18615	18900	19185		
					1851.5MHz	1880.0MHz	1908.5MHz		
2	3	QPSK	1	0	22.87	23.56	22.79		
			1	7	22.88	23.49	22.91		
			1	14	22.84	23.46	22.95		
			8	0	22.45	23.10	22.38		
			8	4	22.44	23.13	22.35		
			8	7	22.42	23.10	22.35		
			15	0	22.36	23.01	22.41		
		Antenna Gain (dBi):					0.22		
		Max. EIRP (dBm):					23.78		
		EIRP Limit (dBm):					33.00		
		16QAM	1	0	22.51	23.72	22.09		
			1	7	22.52	23.64	22.14		
			1	14	22.50	23.57	22.20		
			8	0	21.64	22.28	21.63		
			8	4	21.67	22.29	21.62		
			8	7	21.52	22.13	21.45		
			15	0	21.43	22.05	21.58		
		Antenna Gain (dBi):					0.22		
		Max. EIRP (dBm):					23.94		
		EIRP Limit (dBm):					33.00		

Note: EIRP (dBm) = Average power (dBm) + Antenna Gain (dBi).

LTE Band	Bandwidth (MHz)	Modulation	RB Size	RB Offset	Average Power (dBm)				
					18625	18900	19175		
					1852.5MHz	1880.0MHz	1907.5MHz		
2	5	QPSK	1	0	22.94	23.73	22.67		
			1	12	22.91	23.65	22.72		
			1	24	22.90	23.72	22.68		
			12	0	22.45	23.22	22.35		
			12	6	22.52	23.04	22.45		
			12	11	22.50	23.15	22.35		
			25	0	22.15	22.63	22.28		
		Antenna Gain (dBi):					0.22		
		Max. EIRP (dBm):					23.95		
		EIRP Limit (dBm):					33.00		
		16QAM	1	0	22.30	23.34	22.28		
			1	12	22.22	23.26	22.44		
			1	24	22.30	23.27	22.43		
			12	0	21.56	22.11	21.41		
			12	6	21.51	22.13	21.44		
			12	11	21.65	22.17	21.32		
			25	0	21.64	21.89	21.44		
		Antenna Gain (dBi):					0.22		
		Max. EIRP (dBm):					23.56		
		EIRP Limit (dBm):					33.00		
		LTE Band	Bandwidth (MHz)	Modulation	RB Size	RB Offset	Average Power (dBm)		
18650	18900						19150		
1855.0MHz	1880.0MHz						1905.0MHz		
2	10	QPSK	1	0	22.88	23.63	22.70		
			1	24	22.88	23.57	22.82		
			1	49	22.99	23.47	22.95		
			25	0	22.48	23.18	22.27		
			25	12	22.58	23.03	22.35		
			25	24	22.49	23.10	22.33		
			50	0	22.39	22.95	22.34		
		Antenna Gain (dBi):					0.22		
		Max. EIRP (dBm):					23.85		
		EIRP Limit (dBm):					33.00		
		16QAM	1	0	22.40	23.34	21.52		
			1	24	22.44	23.25	21.71		
			1	49	22.60	23.10	21.84		
			25	0	21.58	22.38	21.38		
			25	12	21.65	22.28	21.51		
			25	24	21.55	22.19	21.31		
			50	0	21.43	22.16	21.35		
		Antenna Gain (dBi):					0.22		
		Max. EIRP (dBm):					23.56		
		EIRP Limit (dBm):					33.00		
		Note: EIRP (dBm) = Average power (dBm) + Antenna Gain (dBi).							

LTE Band	Bandwidth (MHz)	Modulation	RB Size	RB Offset	Average Power (dBm)				
					18675	18900	19125		
					1857.5MHz	1880.0MHz	1902.5MHz		
2	15	QPSK	1	0	22.86	23.63	22.68		
			1	37	22.94	23.52	22.74		
			1	74	23.21	23.30	22.92		
			36	0	22.43	23.26	22.12		
			36	16	22.67	22.98	22.31		
			36	35	22.53	23.11	22.24		
			75	0	22.43	23.01	22.42		
		Antenna Gain (dBi):					0.22		
		Max. EIRP (dBm):					23.85		
		EIRP Limit (dBm):					33.00		
		16QAM	1	0	22.47	23.52	22.25		
			1	37	22.55	23.47	22.34		
			1	74	22.78	23.25	22.60		
			36	0	21.68	22.33	21.24		
			36	16	21.93	22.15	21.50		
			36	35	21.91	22.14	21.43		
			75	0	21.84	22.05	21.35		
		Antenna Gain (dBi):					0.22		
		Max. EIRP (dBm):					23.74		
		EIRP Limit (dBm):					33.00		
		LTE Band	Bandwidth (MHz)	Modulation	RB Size	RB Offset	Average Power (dBm)		
18700	18900						19100		
1860.0MHz	1880.0MHz						1900.0MHz		
2	20	QPSK	1	0	23.08	23.70	22.78		
			1	49	23.19	23.67	22.73		
			1	99	23.55	23.37	23.07		
			50	0	22.51	23.23	22.15		
			50	24	22.89	23.04	22.33		
			50	49	22.59	23.02	22.18		
			100	0	22.43	22.95	22.14		
		Antenna Gain (dBi):					0.22		
		Max. EIRP (dBm):					23.92		
		EIRP Limit (dBm):					33.00		
		16QAM	1	0	22.67	22.84	22.15		
			1	49	22.73	22.89	22.04		
			1	99	23.20	22.57	22.42		
			50	0	21.76	22.32	21.31		
			50	24	22.05	22.03	21.38		
			50	49	22.01	22.02	21.23		
			100	0	21.65	21.53	21.03		
		Antenna Gain (dBi):					0.22		
		Max. EIRP (dBm):					23.42		
		EIRP Limit (dBm):					33.00		
		Note: EIRP (dBm) = Average power (dBm) + Antenna Gain (dBi).							

LTE Band	Bandwidth (MHz)	Modulation	RB Size	RB Offset	Average Power (dBm)				
					19957	20175	20393		
					1710.7MHz	1732.5MHz	1754.3MHz		
4	1.4	QPSK	1	0	23.08	23.33	23.26		
			1	2	23.14	23.28	23.26		
			1	5	23.12	23.31	23.27		
			3	0	22.06	22.42	22.10		
			3	1	22.10	22.41	22.09		
			3	2	22.54	22.89	22.59		
			6	0	22.39	22.41	22.47		
		Antenna Gain (dBi):					0.17		
		Max. EIRP (dBm):					23.50		
		EIRP Limit (dBm):					30.00		
		16QAM	1	0	23.19	23.44	22.69		
			1	2	23.22	23.42	22.68		
			1	5	23.23	23.43	22.69		
			3	0	22.50	22.85	22.63		
			3	1	22.55	22.86	22.59		
			3	2	21.79	21.86	21.97		
			6	0	21.65	21.48	21.65		
		Antenna Gain (dBi):					0.17		
		Max. EIRP (dBm):					23.61		
		EIRP Limit (dBm):					30.00		
		LTE Band	Bandwidth (MHz)	Modulation	RB Size	RB Offset	Average Power (dBm)		
19965	20175						20385		
1711.5MHz	1732.5MHz						1753.5MHz		
4	3	QPSK	1	0	22.92	23.28	22.96		
			1	7	22.95	23.24	22.98		
			1	14	23.05	23.25	22.90		
			8	0	22.42	22.88	22.57		
			8	4	22.49	22.89	22.59		
			8	7	22.43	22.89	22.51		
			15	0	22.36	22.78	22.41		
		Antenna Gain (dBi):					0.17		
		Max. EIRP (dBm):					23.45		
		EIRP Limit (dBm):					30.00		
		16QAM	1	0	22.21	22.91	23.13		
			1	7	22.17	22.88	23.14		
			1	14	22.24	22.85	23.21		
			8	0	21.73	22.07	21.83		
			8	4	21.82	22.02	21.82		
			8	7	21.61	21.89	21.81		
			15	0	21.53	21.79	21.48		
		Antenna Gain (dBi):					0.17		
		Max. EIRP (dBm):					23.38		
		EIRP Limit (dBm):					30.00		
		<i>Note: EIRP (dBm) = Average power (dBm) + Antenna Gain (dBi).</i>							

LTE Band	Bandwidth (MHz)	Modulation	RB Size	RB Offset	Average Power (dBm)				
					19975	20175	20375		
					1712.5MHz	1732.5MHz	1752.5MHz		
4	5	QPSK	1	0	23.09	23.32	23.15		
			1	12	23.15	23.24	23.00		
			1	24	23.17	23.16	23.08		
			12	0	22.57	22.85	22.57		
			12	6	22.49	22.87	22.65		
			12	11	22.51	22.89	22.49		
			25	0	22.41	22.56	22.37		
		Antenna Gain (dBi):					0.17		
		Max. EIRP (dBm):					23.49		
		EIRP Limit (dBm):					30.00		
		16QAM	1	0	22.69	22.88	22.37		
			1	12	22.67	22.85	22.30		
			1	24	22.87	22.86	22.40		
			12	0	21.47	21.92	21.63		
			12	6	21.61	21.84	21.61		
			12	11	21.59	21.81	21.80		
			25	0	21.52	21.74	21.56		
		Antenna Gain (dBi):					0.17		
		Max. EIRP (dBm):					23.05		
		EIRP Limit (dBm):					30.00		
		LTE Band	Bandwidth (MHz)	Modulation	RB Size	RB Offset	Average Power (dBm)		
20000	20175						20350		
1715.0MHz	1732.5MHz						1750.0MHz		
4	10	QPSK	1	0	22.87	23.39	23.31		
			1	24	22.99	23.31	23.24		
			1	49	23.09	23.26	23.23		
			25	0	22.48	22.86	22.65		
			25	12	22.70	22.82	22.67		
			25	24	22.58	22.89	22.56		
			50	0	22.54	22.79	22.43		
		Antenna Gain (dBi):					0.17		
		Max. EIRP (dBm):					23.56		
		EIRP Limit (dBm):					30.00		
		16QAM	1	0	22.43	23.01	22.12		
			1	24	22.55	22.98	22.06		
			1	49	22.60	22.90	22.08		
			25	0	21.63	22.06	21.80		
			25	12	21.69	22.03	21.75		
			25	24	21.55	21.98	21.74		
			50	0	21.36	21.57	21.66		
		Antenna Gain (dBi):					0.17		
		Max. EIRP (dBm):					23.18		
		EIRP Limit (dBm):					30.00		
		Note: EIRP (dBm) = Average power (dBm) + Antenna Gain (dBi).							

LTE Band	Bandwidth (MHz)	Modulation	RB Size	RB Offset	Average Power (dBm)				
					20025	20175	20325		
					1717.5MHz	1732.5MHz	1747.5MHz		
4	15	QPSK	1	0	22.90	23.41	23.41		
			1	37	23.08	23.32	23.31		
			1	74	23.20	23.23	23.29		
			36	0	22.60	22.96	22.60		
			36	16	22.68	22.70	22.62		
			36	35	22.64	22.80	22.55		
			75	0	22.63	22.87	22.41		
		Antenna Gain (dBi):					0.17		
		Max. EIRP (dBm):					23.58		
		EIRP Limit (dBm):					30.00		
		16QAM	1	0	22.49	23.00	22.85		
			1	37	22.61	22.97	22.70		
			1	74	22.71	22.91	22.71		
			36	0	21.77	21.95	21.87		
			36	16	21.87	21.96	21.78		
			36	35	21.78	21.96	21.66		
			75	0	21.77	21.63	21.54		
		Antenna Gain (dBi):					0.17		
		Max. EIRP (dBm):					23.17		
		EIRP Limit (dBm):					30.00		
		LTE Band	Bandwidth (MHz)	Modulation	RB Size	RB Offset	Average Power (dBm)		
20050	20175						20300		
1720.0MHz	1732.5MHz						1745.0MHz		
4	20	QPSK	1	0	23.13	23.37	23.50		
			1	49	23.29	23.33	23.28		
			1	99	23.50	23.28	23.24		
			50	0	22.69	22.89	22.73		
			50	24	22.74	22.83	22.60		
			50	49	22.68	22.76	22.80		
			100	0	22.65	22.49	22.76		
		Antenna Gain (dBi):					0.17		
		Max. EIRP (dBm):					23.67		
		EIRP Limit (dBm):					30.00		
		16QAM	1	0	22.77	22.98	22.72		
			1	49	22.91	22.96	22.53		
			1	99	23.05	22.82	22.45		
			50	0	21.84	22.10	21.93		
			50	24	21.93	21.98	21.79		
			50	49	21.86	21.88	21.64		
			100	0	21.69	21.56	21.55		
		Antenna Gain (dBi):					0.17		
		Max. EIRP (dBm):					23.22		
		EIRP Limit (dBm):					30.00		
		Note: EIRP (dBm) = Average power (dBm) + Antenna Gain (dBi).							

LTE Band	Bandwidth (MHz)	Modulation	RB Size	RB Offset	Average Power (dBm)				
					20775	21100	21425		
					2502.5MHz	2535.0MHz	2567.5MHz		
7	5	QPSK	1	0	23.26	23.31	23.43		
			1	12	23.25	23.28	23.45		
			1	24	23.11	23.32	23.41		
			12	0	22.73	23.04	22.97		
			12	6	22.64	22.96	23.09		
			12	11	22.66	23.02	22.96		
			25	0	22.59	22.98	22.84		
		Antenna Gain (dBi):					0.13		
		Max. EIRP (dBm):					23.58		
		EIRP Limit (dBm):					33.00		
		16QAM	1	0	22.80	22.89	22.75		
			1	12	22.74	22.94	22.84		
			1	24	22.73	22.94	22.97		
			12	0	21.69	22.04	22.04		
			12	6	21.63	22.11	22.11		
			12	11	21.81	21.99	22.24		
			25	0	21.73	21.84	21.23		
		Antenna Gain (dBi):					0.13		
		Max. EIRP (dBm):					23.10		
		EIRP Limit (dBm):					33.00		
		LTE Band	Bandwidth (MHz)	Modulation	RB Size	RB Offset	Average Power (dBm)		
20800	21100						21400		
2505.0MHz	2535.0MHz						2565.0MHz		
7	10	QPSK	1	0	22.99	23.25	23.39		
			1	24	22.92	23.38	23.57		
			1	49	22.87	23.39	23.73		
			25	0	22.63	23.00	22.84		
			25	12	22.50	23.05	22.91		
			25	24	22.48	23.02	22.97		
			50	0	22.49	22.98	22.84		
		Antenna Gain (dBi):					0.13		
		Max. EIRP (dBm):					23.86		
		EIRP Limit (dBm):					33.00		
		16QAM	1	0	22.64	23.20	22.22		
			1	24	22.58	23.32	22.39		
			1	49	22.45	23.43	22.53		
			25	0	21.79	22.15	21.95		
			25	12	21.62	22.21	22.16		
			25	24	21.52	22.16	22.11		
			50	0	21.43	22.06	22.10		
		Antenna Gain (dBi):					0.13		
		Max. EIRP (dBm):					23.56		
		EIRP Limit (dBm):					33.00		
		<i>Note: EIRP (dBm) = Average power (dBm) + Antenna Gain (dBi).</i>							

LTE Band	Bandwidth (MHz)	Modulation	RB Size	RB Offset	Average Power (dBm)				
					20825	21100	21375		
					2507.5MHz	2535.0MHz	2562.5MHz		
7	15	QPSK	1	0	23.11	23.22	23.36		
			1	37	23.02	23.40	23.48		
			1	74	22.84	23.42	23.55		
			36	0	22.69	22.78	22.80		
			36	16	22.47	23.03	22.93		
			36	35	22.47	22.97	22.77		
			75	0	22.36	22.89	22.57		
		Antenna Gain (dBi):					0.13		
		Max. EIRP (dBm):					23.68		
		EIRP Limit (dBm):					33.00		
		16QAM	1	0	22.74	23.27	22.82		
			1	37	22.58	23.50	22.98		
			1	74	22.42	23.52	23.22		
			36	0	21.90	21.97	21.88		
			36	16	21.64	22.19	22.04		
			36	35	21.58	22.13	22.00		
			75	0	21.43	22.10	22.20		
		Antenna Gain (dBi):					0.13		
		Max. EIRP (dBm):					23.65		
		EIRP Limit (dBm):					33.00		
		LTE Band	Bandwidth (MHz)	Modulation	RB Size	RB Offset	Average Power (dBm)		
20850	21100						21350		
2510.0MHz	2535.0MHz						2560.0MHz		
7	20	QPSK	1	0	23.40	23.30	23.32		
			1	49	23.17	23.76	23.68		
			1	99	23.10	23.63	23.61		
			50	0	22.67	22.87	22.80		
			50	24	22.40	23.06	22.90		
			50	49	22.49	23.05	22.88		
			100	0	22.36	22.58	22.47		
		Antenna Gain (dBi):					0.13		
		Max. EIRP (dBm):					23.89		
		EIRP Limit (dBm):					33.00		
		16QAM	1	0	22.64	22.38	23.02		
			1	49	22.41	22.77	22.96		
			1	99	22.39	22.77	23.28		
			50	0	21.73	22.10	21.92		
			50	24	21.55	22.31	22.08		
			50	49	21.53	22.25	22.05		
			100	0	21.56	22.16	22.41		
		Antenna Gain (dBi):					0.13		
		Max. EIRP (dBm):					23.41		
		EIRP Limit (dBm):					33.00		
		<i>Note: EIRP (dBm) = Average power (dBm) + Antenna Gain (dBi).</i>							

6.2 Peak-to-Average Ratio

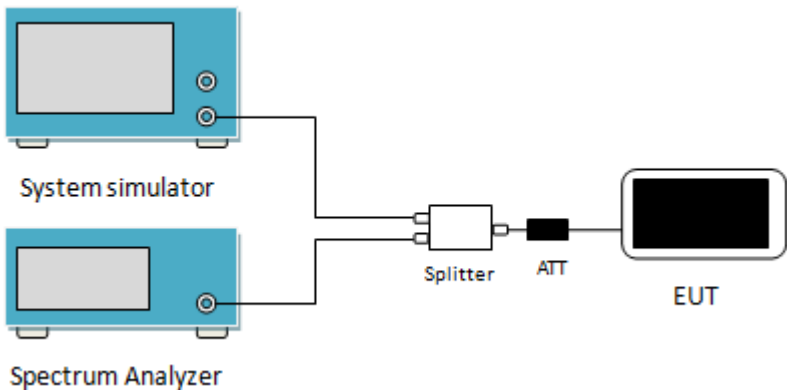
Test Requirement:	Part 24.232 (d), Part 27.50(d)(5)
Limit:	The peak-to-average ratio (PAR) of the transmission may not exceed 13 dB.
Test Setup:	
Test Procedure:	<ol style="list-style-type: none"> 1 The RF output of the transceiver was connected to a spectrum analyzer through appropriate attenuation. 2 Set the CCDF option in spectrum analyzer, $RBW \geq OBW$, 3 Set the EUT working in highest power level, measured and recorded the 0.1% as PAPR level. 4 Repeat step 1~3 at other frequency and modulations.
Test Instruments:	Refer to section 5.10 for details
Test mode:	Refer to section 5.3 for details
Test results:	Passed

Measurement Data (Worst case):

Bandwidth	Modulation	RB Size	RB Offset	PAPR
LTE Band 2 (Middle Channel)				
20MHz	QPSK	100	0	5.37
	16QAM	100	0	6.04
LTE Band 4 (Middle Channel)				
20MHz	QPSK	100	0	5.21
	16QAM	100	0	5.94
LTE Band 7 (Middle Channel)				
20MHz	QPSK	100	0	5.03
	16QAM	100	0	5.64

Test plots as below:

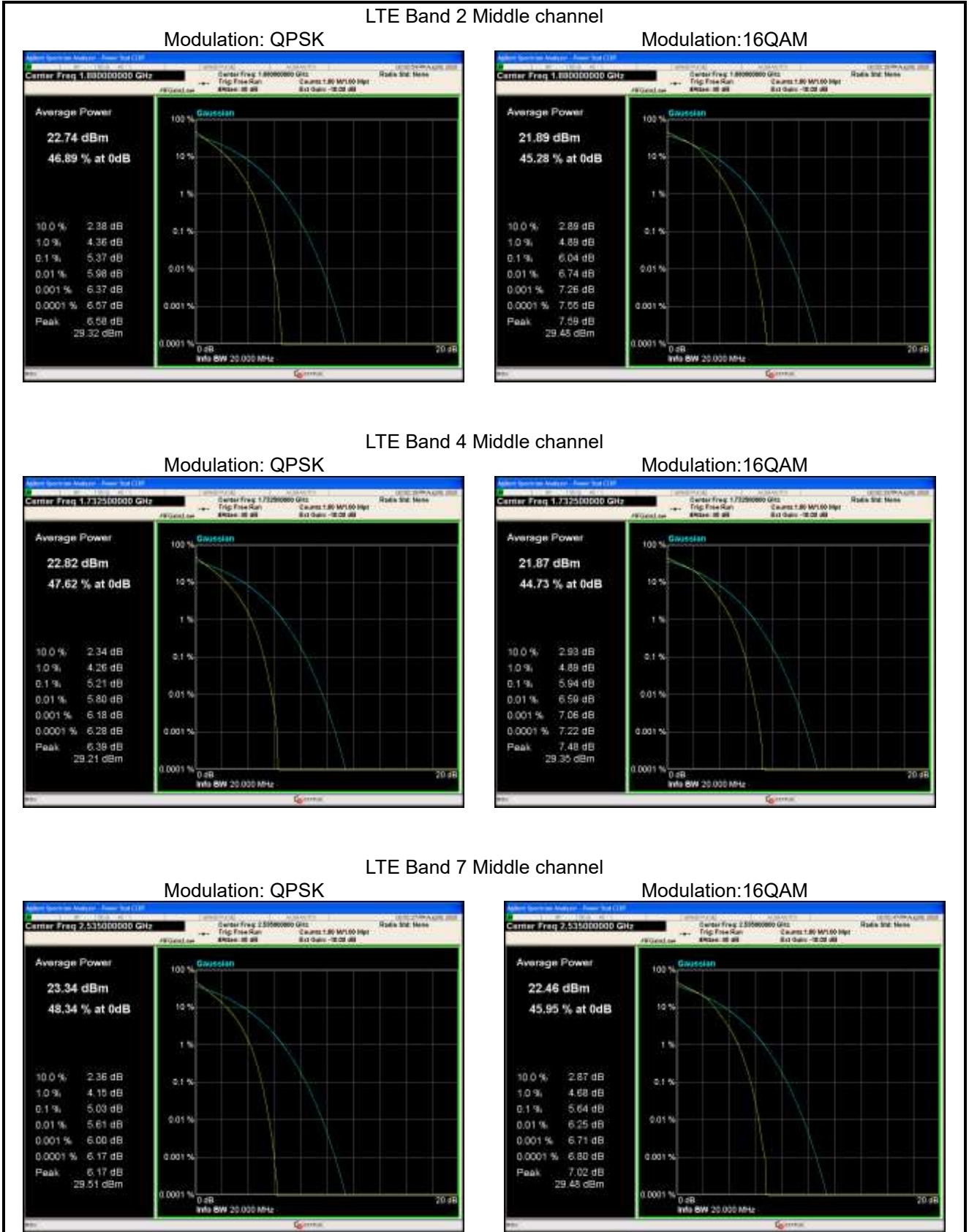

6.3 Occupy Bandwidth

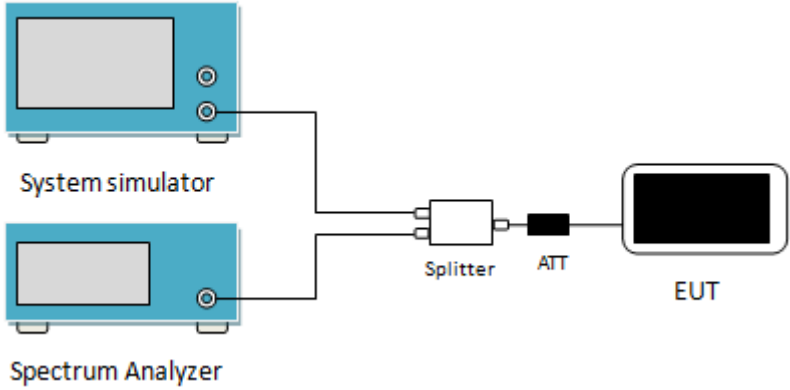
Test Requirement:	Part 24.238(b), , Part 27.53(h), Part 27.53(m)
Test Setup:	 <p>The diagram illustrates the test setup. On the left, there are two blue rectangular units: the top one is labeled 'System simulator' and the bottom one is labeled 'Spectrum Analyzer'. Both have a screen and two circular ports on the right side. A single line connects the top port of the System simulator to the top port of the Spectrum Analyzer. From the bottom port of the System simulator, a line goes to the left input of a white rectangular 'Splitter'. From the right output of the Splitter, a line goes to a black rectangular 'ATT' (attenuator). From the right output of the ATT, a line goes to the left side of a white rectangular 'EUT' (Equipment Under Test) which has a black screen.</p>
Test Procedure:	<ol style="list-style-type: none"> 1. The EUT's output RF connector was connected with a short cable to the spectrum analyzer 2. RBW was set to about 1% ~ 5% of emission BW, VBW= 3 times RBW. 3. -26dBc display line was placed on the screen (or 99% bandwidth), the occupied bandwidth is the delta frequency between the two points where the display line intersects the signal trace.
Test Instruments:	Refer to section 5.10 for details
Test mode:	Refer to section 5.3 for details
Test results:	Passed

Measurement Data:

LTE Band 2					
Bandwidth	Channel	Frequency (MHz)	Modulation	99% OBW (kHz)	-26dBcEBW (kHz)
1.4MHz	18607	1850.70	16QAM	1104	1254
			QPSK	1098	1260
	18900	1880.00	16QAM	1098	1254
			QPSK	1098	1236
	19193	1909.30	16QAM	1104	1272
			QPSK	1104	1266
3MHz	18615	1851.50	16QAM	2736	3048
			QPSK	2760	3120
	18900	1880.00	16QAM	2724	3072
			QPSK	2760	3096
	19185	1908.50	16QAM	2724	3072
			QPSK	2772	3132
5MHz	18625	1852.50	16QAM	4480	4900
			QPSK	4520	4940
	18900	1880.00	16QAM	4500	4920
			QPSK	4540	5040
	19175	1907.50	16QAM	4520	4940
			QPSK	4540	4960
10MHz	18650	1855.00	16QAM	9120	10160
			QPSK	9160	10400
	18900	1880.00	16QAM	9080	10080
			QPSK	9080	10200
	19150	1905.00	16QAM	9120	10080
			QPSK	9120	10280
15MHz	18675	1857.50	16QAM	13560	14460
			QPSK	13500	14940
	18900	1880.00	16QAM	13500	14760
			QPSK	13500	15120
	19125	1902.50	16QAM	13560	14640
			QPSK	13560	15000
20MHz	18700	1860.00	16QAM	17920	19120
			QPSK	18000	19760
	18900	1880.00	16QAM	18000	19360
			QPSK	18080	19760
	19100	1900.00	16QAM	18000	19280
			QPSK	18080	19520

LTE Band 4					
Bandwidth	Channel	Frequency (MHz)	Modulation	99% OBW (kHz)	-26dBcEBW (kHz)
1.4MHz	19957	1710.7	16QAM	1098	1272
			QPSK	1098	1278
	20175	1732.5	16QAM	1098	1248
			QPSK	1098	1260
	20393	1754.3	16QAM	1098	1254
			QPSK	1098	1260
3MHz	19965	1711.5	16QAM	2748	3060
			QPSK	2748	3108
	20175	1732.5	16QAM	2748	3072
			QPSK	2736	3132
	20385	1750.5	16QAM	2724	3060
			QPSK	2772	3132
5MHz	19975	1712.5	16QAM	4500	4900
			QPSK	4520	4960
	20175	1732.5	16QAM	4520	4900
			QPSK	4540	4980
	20375	1752.5	16QAM	4500	4920
			QPSK	4520	4980
10MHz	20000	1715.0	16QAM	9160	9960
			QPSK	9080	10240
	20175	1732.5	16QAM	9120	10280
			QPSK	9080	10240
	20350	1750.0	16QAM	9120	10080
			QPSK	9080	10240
15MHz	20025	1717.5	16QAM	13500	14580
			QPSK	13560	15000
	20175	1732.5	16QAM	13500	14760
			QPSK	13560	14940
	20325	1747.5	16QAM	13560	14820
			QPSK	13560	15000
20MHz	20050	1720.0	16QAM	18000	19440
			QPSK	18000	19600
	20175	1732.5	16QAM	18000	19440
			QPSK	18000	19600
	20300	1745.0	16QAM	18000	19280
			QPSK	18000	19520

LTE Band 7					
Bandwidth	Channel	Frequency (MHz)	Modulation	99% OBW (kHz)	-26dBcEBW (kHz)
5MHz	20775	2502.5	16QAM	4520	4900
			QPSK	4520	5000
	21100	2535.0	16QAM	4520	4880
			QPSK	4520	5040
	21425	2567.5	16QAM	4500	4920
			QPSK	4540	4980
10MHz	20800	2505.0	16QAM	9080	10040
			QPSK	9160	10160
	21100	2535.0	16QAM	9120	10120
			QPSK	9120	10080
	21400	2565.0	16QAM	9160	10040
			QPSK	9160	10200
15MHz	20825	2507.5	16QAM	13560	14820
			QPSK	13560	15240
	21100	2535.0	16QAM	13560	14760
			QPSK	13560	15120
	21375	2562.5	16QAM	13560	14580
			QPSK	13620	14880
20MHz	20850	2510.0	16QAM	18000	19440
			QPSK	18000	19840
	21100	2535.0	16QAM	18000	19520
			QPSK	18000	19680
	21350	2560.0	16QAM	18000	19440
			QPSK	18000	19680

Test plot as follows:
LTE Band 2 part:

LTE Band 2: 99% Occupancy bandwidth
BW: 1.4MHz

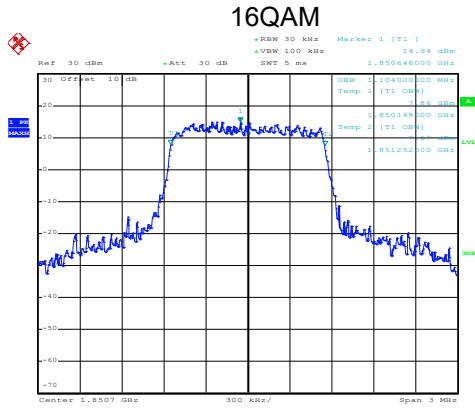

Date: 6.AUG.2020 14:09:48

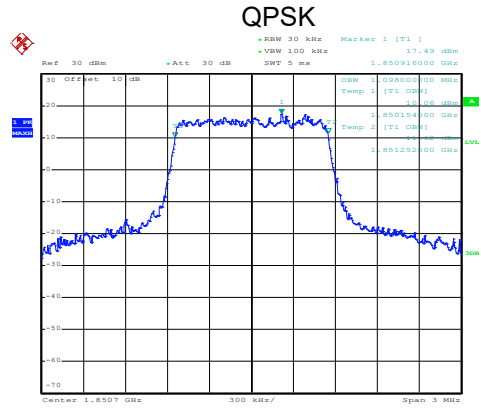

Date: 6.AUG.2020 14:09:44

Lowest channel

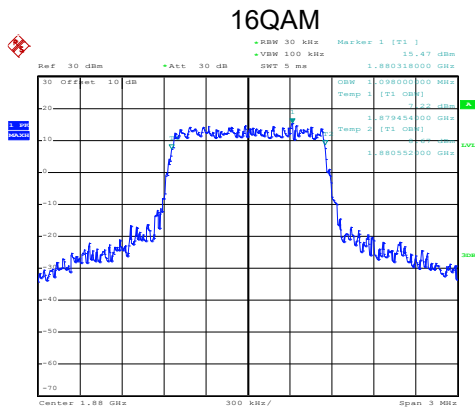

Date: 6.AUG.2020 14:10:20

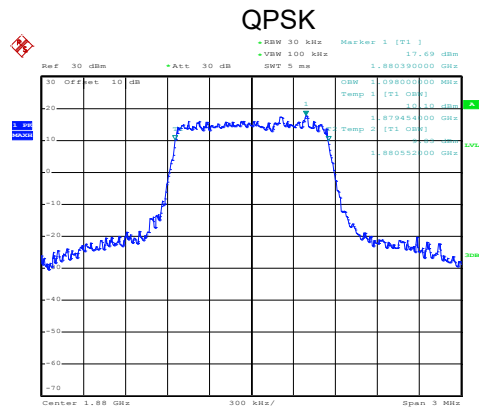

Date: 6.AUG.2020 14:10:16

Middle channel

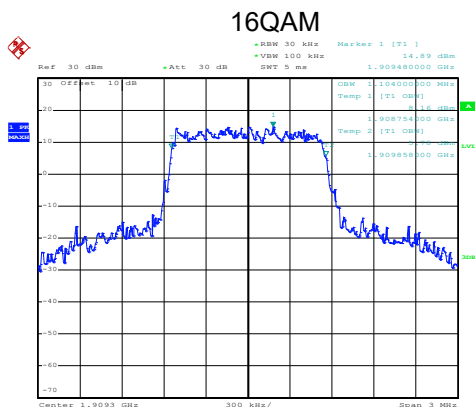

Date: 6.AUG.2020 14:10:33

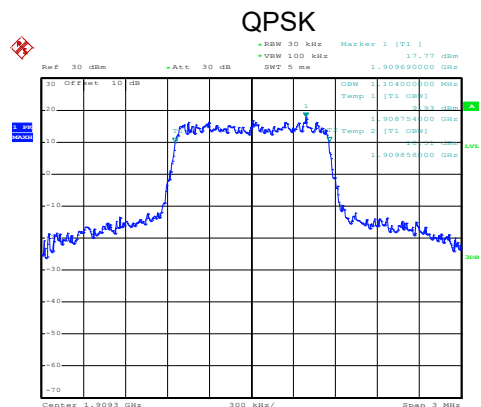

Date: 6.AUG.2020 14:10:30

Highest channel

LTE Band 2: 99% Occupancy bandwidth BW: 3MHz

16QAM

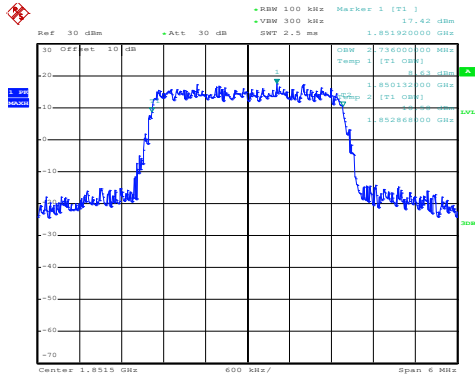

Date: 6.AUG.2020 14:11:21

QPSK

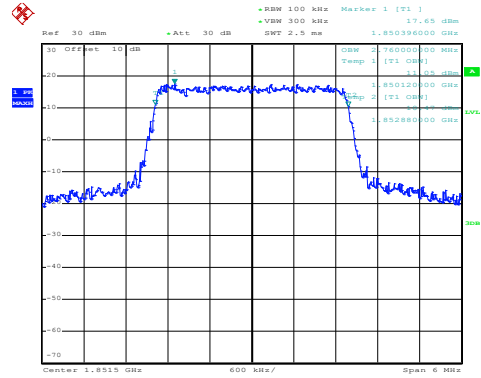

Date: 6.AUG.2020 14:11:17

Lowest channel

16QAM

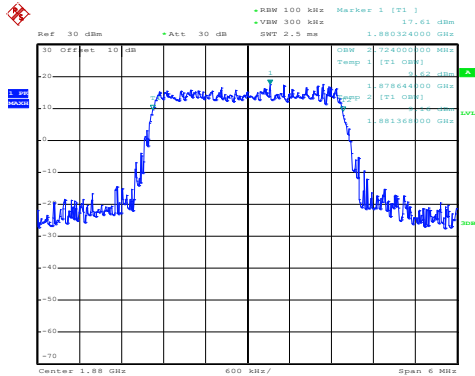

Date: 6.AUG.2020 14:11:33

QPSK

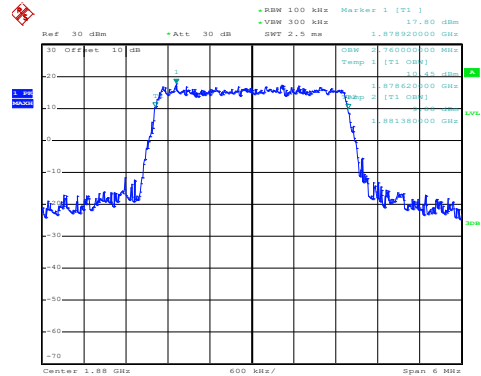

Date: 6.AUG.2020 14:11:29

Middle channel

16QAM

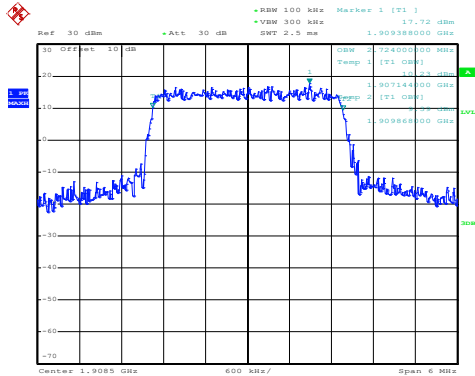

Date: 6.AUG.2020 14:12:07

QPSK

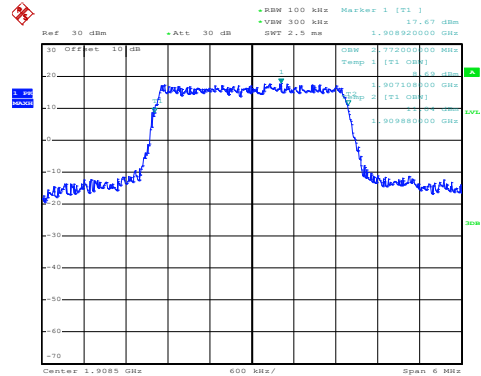

Date: 6.AUG.2020 14:12:04

Highest channel

LTE Band 2: 99% Occupancy bandwidth
BW: 5MHz

16QAM

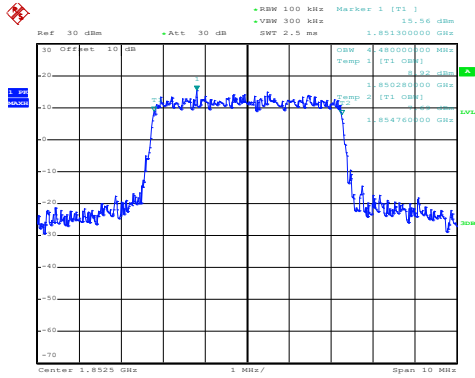

Date: 6.AUG.2020 14:12:29

QPSK

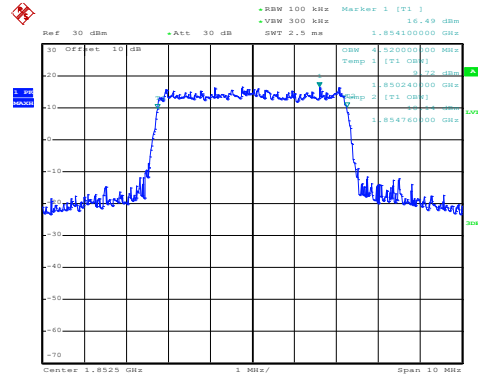

Date: 6.AUG.2020 14:12:26

Lowest channel

16QAM

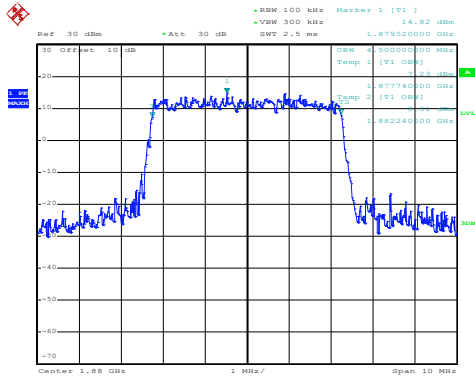

Date: 6.AUG.2020 14:13:05

QPSK

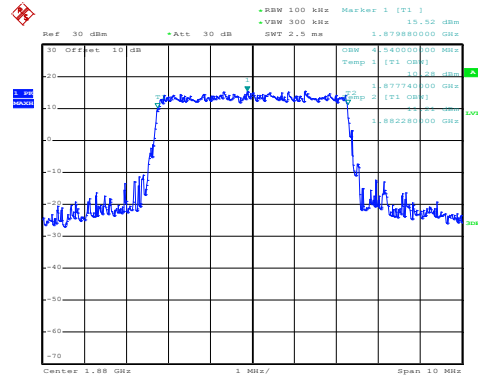

Date: 6.AUG.2020 14:13:01

Middle channel

16QAM

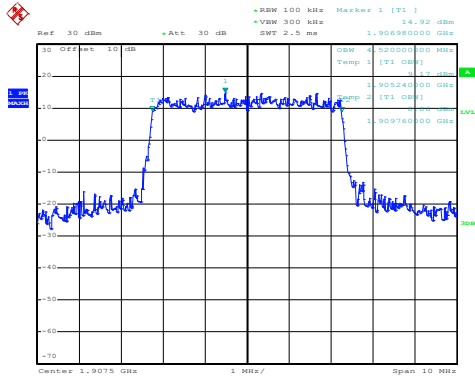

Date: 6.AUG.2020 14:13:18

QPSK

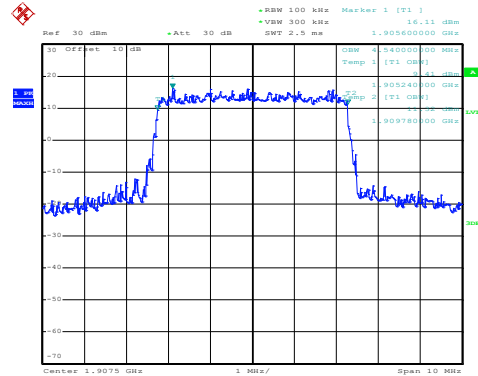

Date: 6.AUG.2020 14:13:14

Highest channel

LTE Band 2: 99% Occupancy bandwidth BW: 10MHz

16QAM

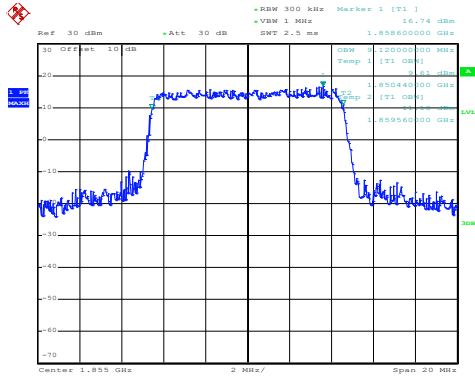

Date: 6.AUG.2020 14:14:17

QPSK

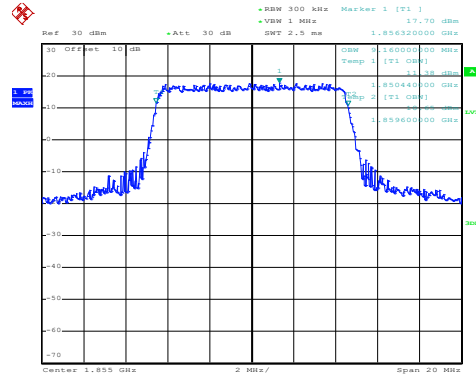

Date: 6.AUG.2020 14:14:13

Lowest channel

16QAM

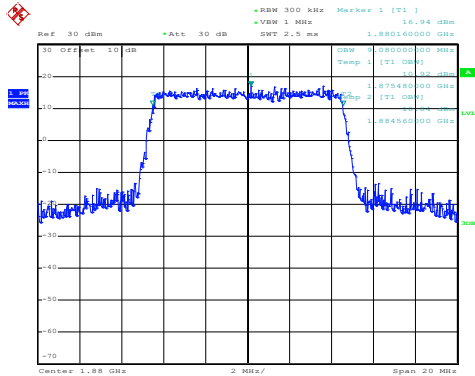

Date: 6.AUG.2020 14:14:29

QPSK

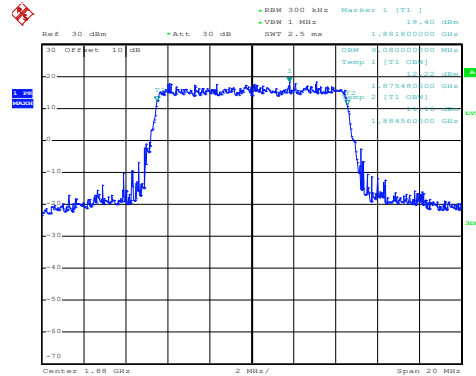

Date: 6.AUG.2020 14:14:25

Middle channel

16QAM

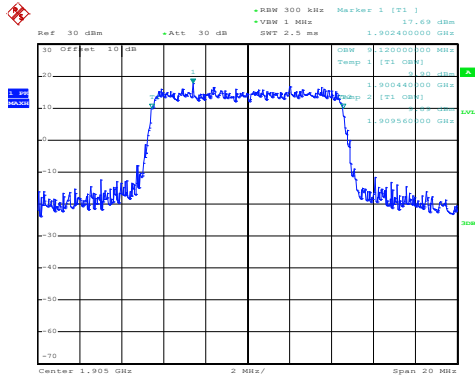

Date: 6.AUG.2020 14:15:09

QPSK

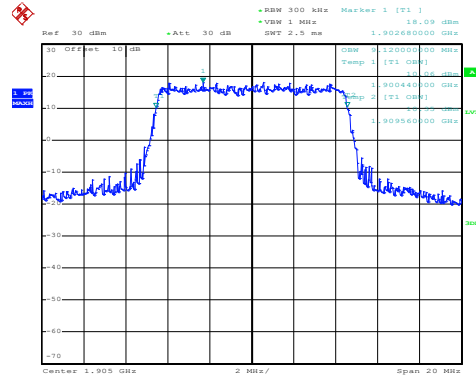

Date: 6.AUG.2020 14:15:06

Highest channel

LTE Band 2: 99% Occupancy bandwidth BW: 15MHz

16QAM

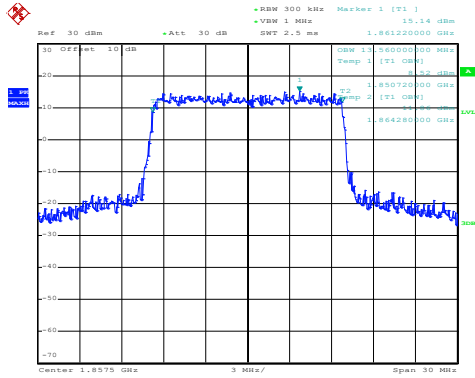

Date: 6.AUG.2020 14:15:29

QPSK

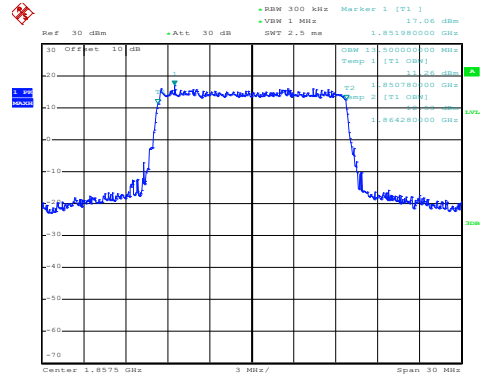

Date: 6.AUG.2020 14:15:25

Lowest channel

16QAM

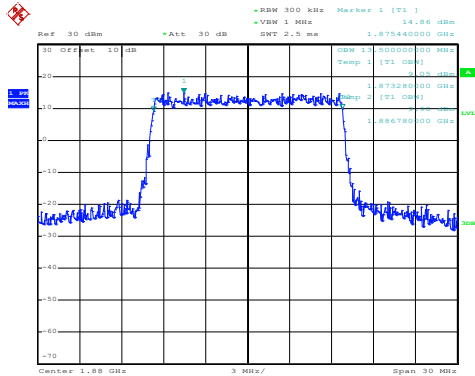

Date: 6.AUG.2020 14:16:13

QPSK

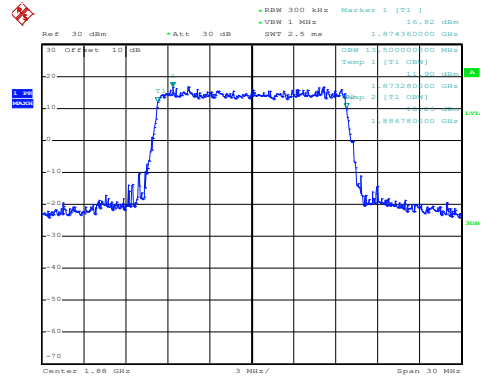

Date: 6.AUG.2020 14:16:10

Middle channel

16QAM

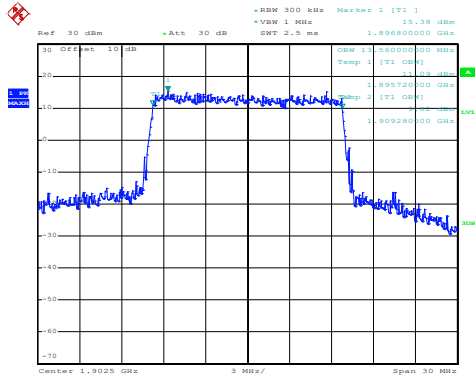

Date: 6.AUG.2020 14:16:33

QPSK

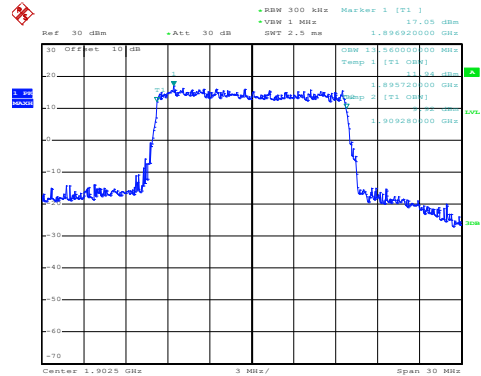

Date: 6.AUG.2020 14:16:29

Highest channel

LTE Band 2: 99% Occupancy bandwidth BW: 20MHz

16QAM

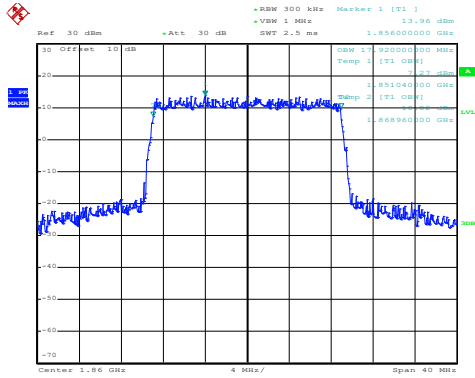

Date: 6.AUG.2020 14:17:13

QPSK

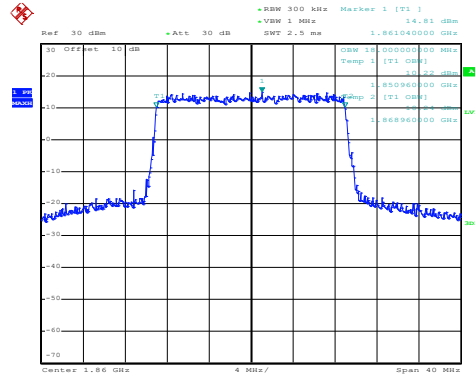

Date: 6.AUG.2020 14:17:10

Lowest channel

16QAM

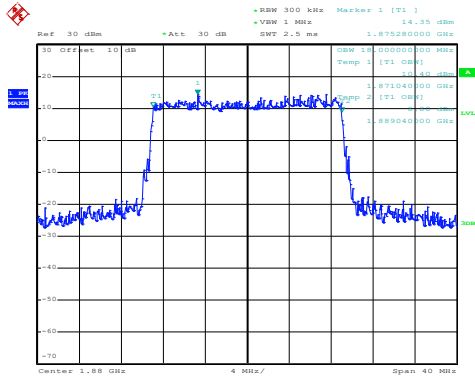

Date: 6.AUG.2020 14:17:25

QPSK

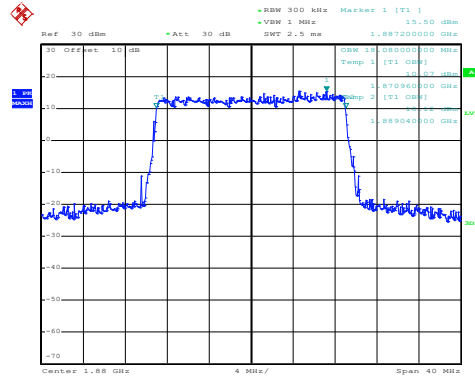

Date: 6.AUG.2020 14:17:21

Middle channel

16QAM

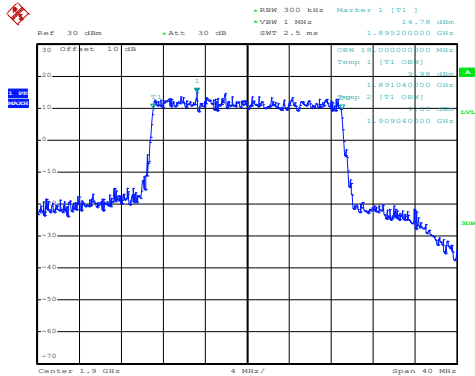

Date: 6.AUG.2020 14:18:01

QPSK

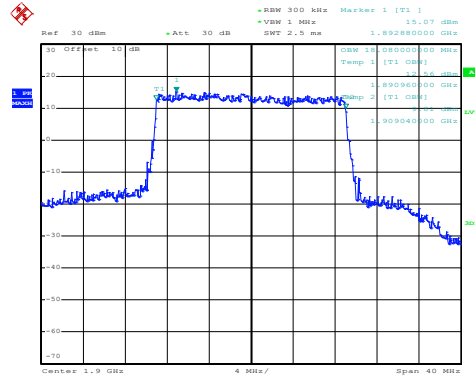

Date: 6.AUG.2020 14:17:57

Highest channel

LTE Band 2: -26dBc bandwidth
BW: 1.4MHz

16QAM

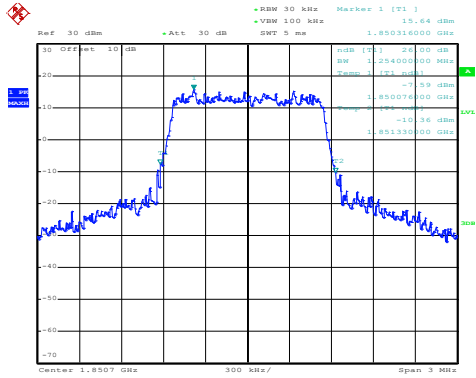

Date: 6.AUG.2020 14:09:57

QPSK

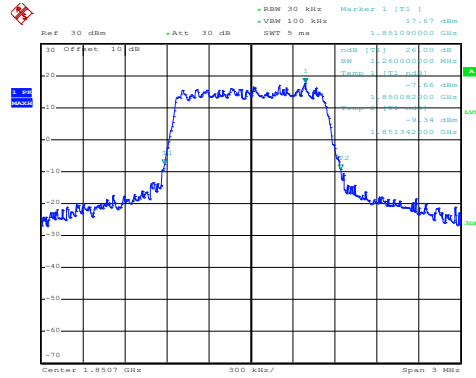

Date: 6.AUG.2020 14:09:54

Lowest channel

16QAM

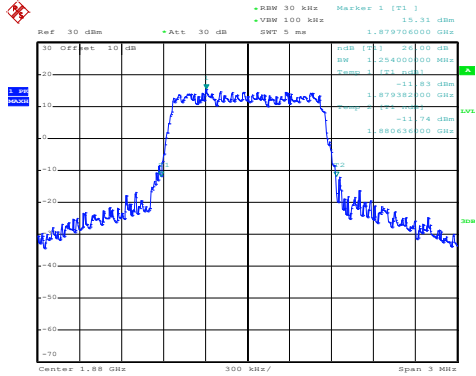

Date: 6.AUG.2020 14:10:09

QPSK

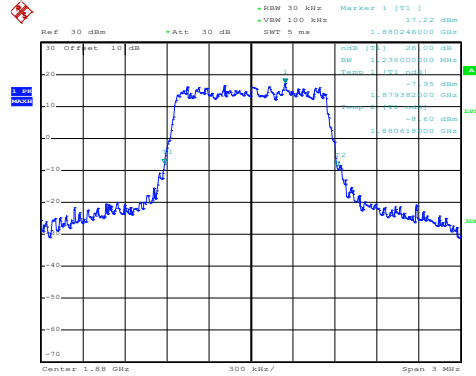

Date: 6.AUG.2020 14:10:06

Middle channel

16QAM

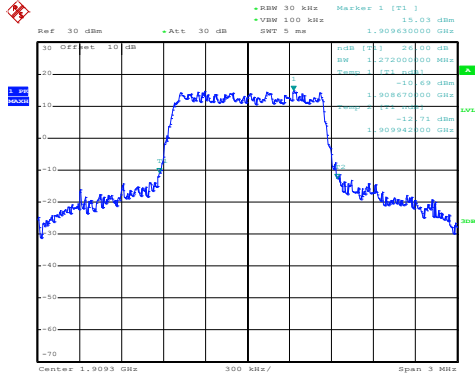

Date: 6.AUG.2020 14:10:43

QPSK

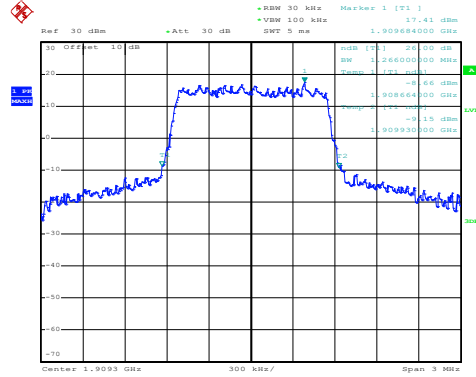

Date: 6.AUG.2020 14:10:39

Highest channel

LTE Band 2: -26dBc bandwidth
BW: 3MHz

16QAM

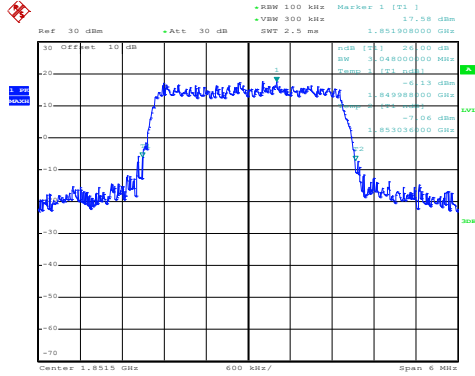

Date: 6.AUG.2020 14:11:11

QPSK

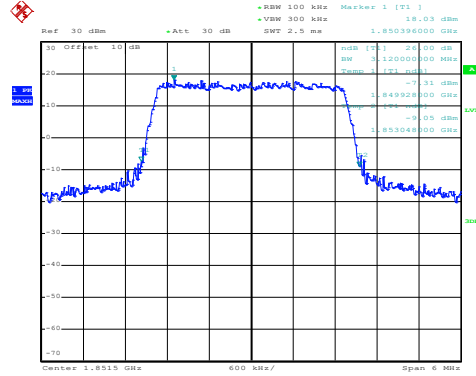

Date: 6.AUG.2020 14:11:07

Lowest channel

16QAM

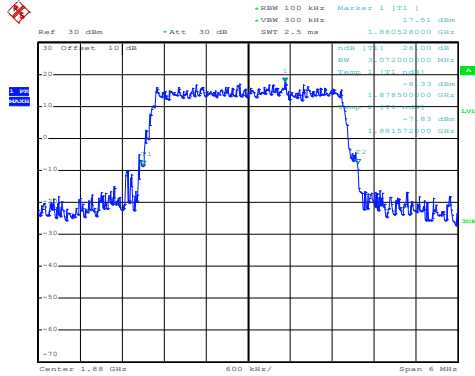

Date: 6.AUG.2020 14:11:43

QPSK

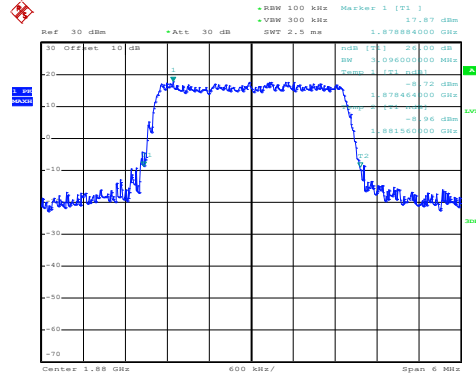

Date: 6.AUG.2020 14:11:39

Middle channel

16QAM

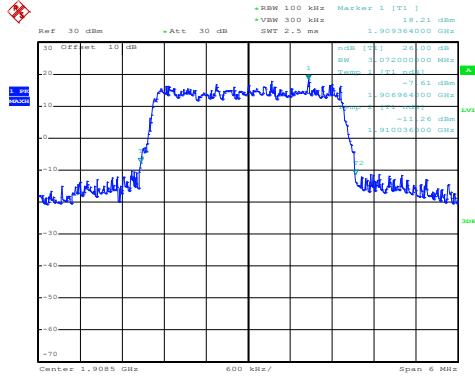

Date: 6.AUG.2020 14:11:58

QPSK

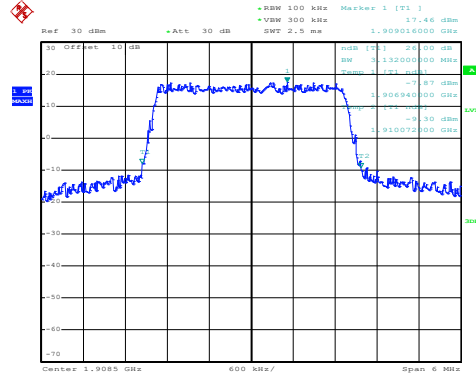

Date: 6.AUG.2020 14:11:54

Highest channel

LTE Band 2: -26dBc bandwidth
BW: 5MHz

16QAM

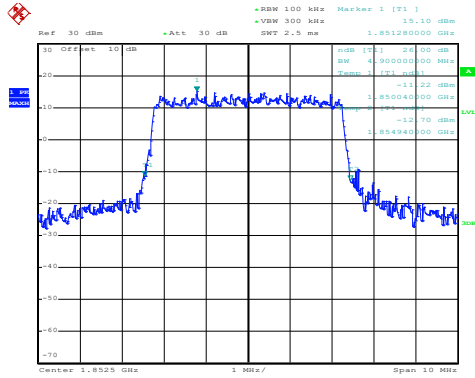

Date: 6.AUG.2020 14:12:40

QPSK

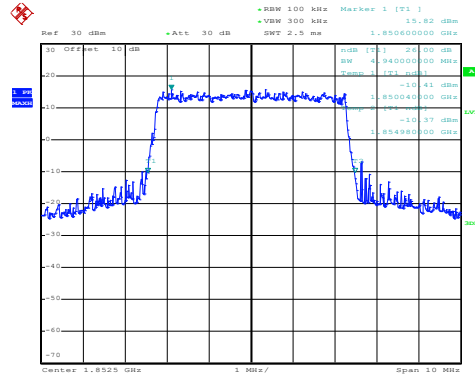

Date: 6.AUG.2020 14:12:36

Lowest channel

16QAM

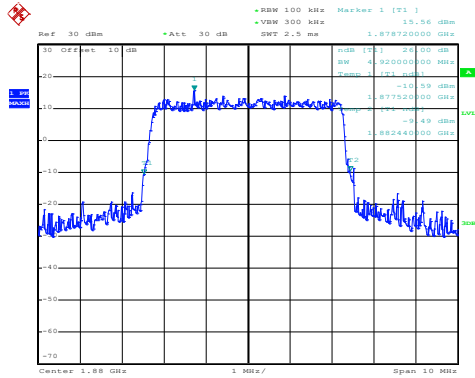

Date: 6.AUG.2020 14:12:55

QPSK

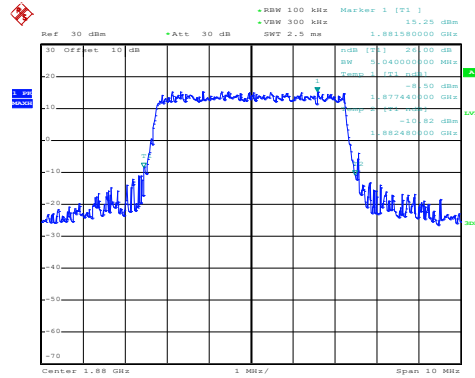

Date: 6.AUG.2020 14:12:50

Middle channel

16QAM

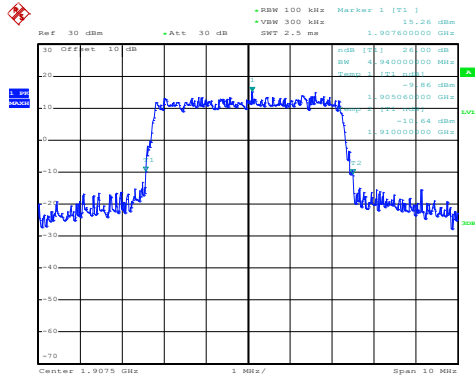

Date: 6.AUG.2020 14:13:28

QPSK

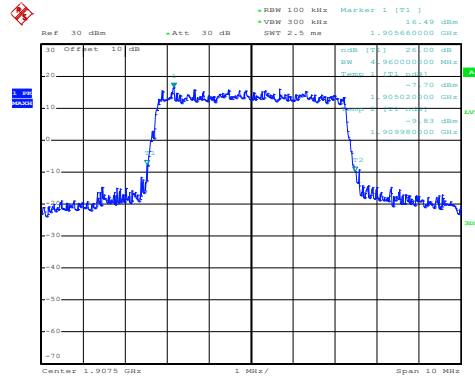

Date: 6.AUG.2020 14:13:24

Highest channel

LTE Band 2: -26dBc bandwidth
BW: 10MHz

16QAM

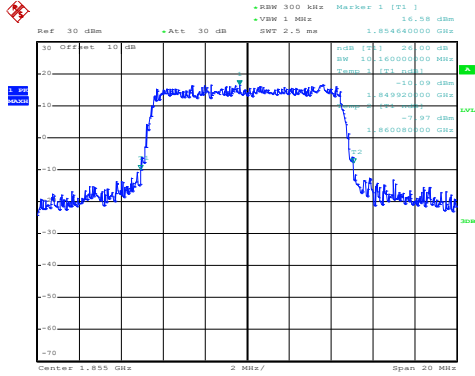

Date: 6.AUG.2020 14:14:04

QPSK

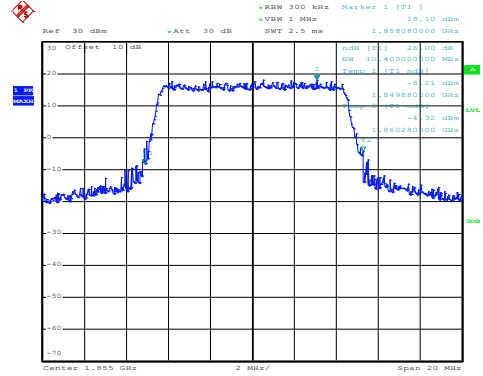

Date: 6.AUG.2020 14:14:01

Lowest channel

16QAM

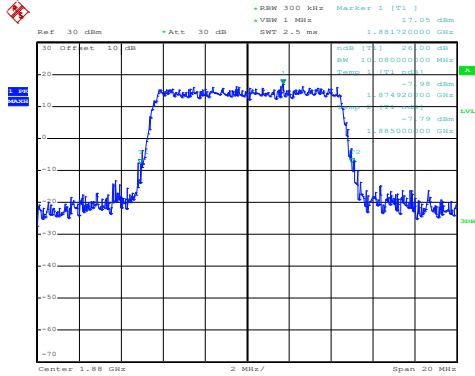

Date: 6.AUG.2020 14:14:39

QPSK

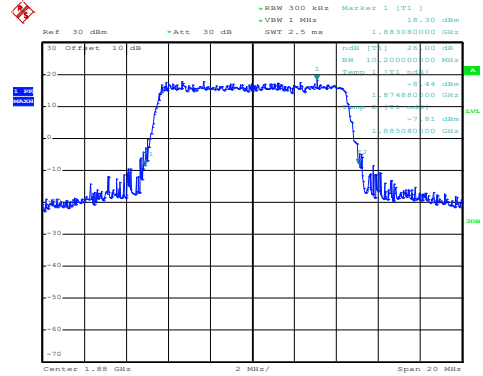

Date: 6.AUG.2020 14:14:35

Middle channel

16QAM

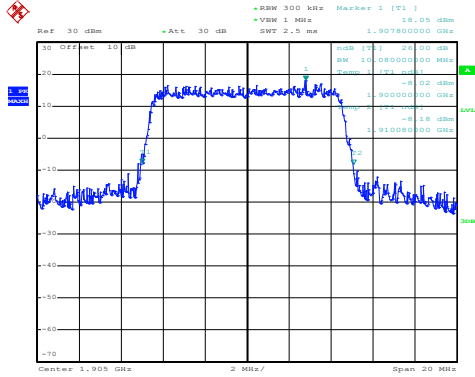

Date: 6.AUG.2020 14:15:00

QPSK

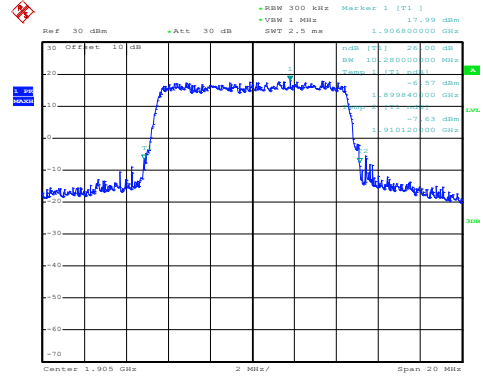

Date: 6.AUG.2020 14:14:56

Highest channel

LTE Band 2: -26dBc bandwidth
BW: 15MHz

16QAM

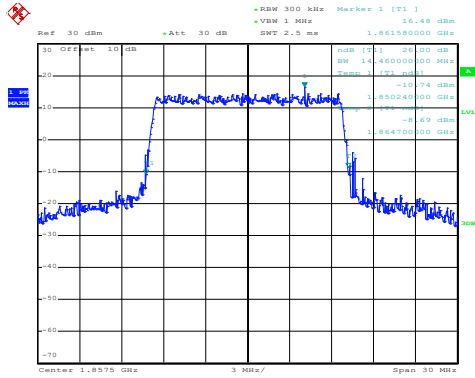

Date: 6.AUG.2020 14:15:39

QPSK

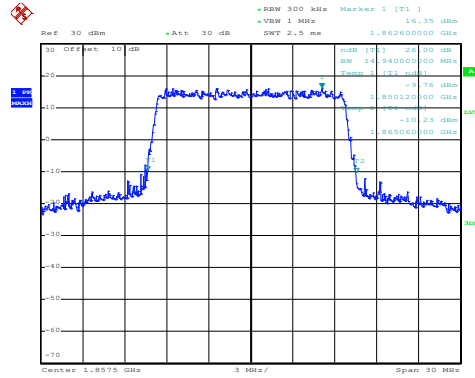

Date: 6.AUG.2020 14:15:35

Lowest channel

16QAM

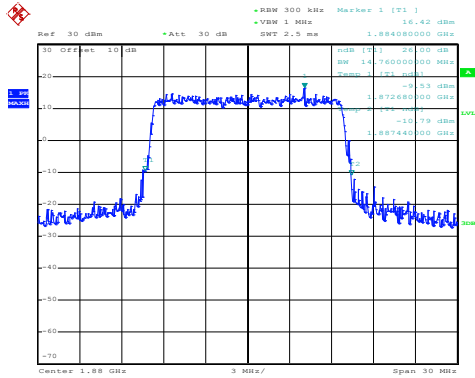

Date: 6.AUG.2020 14:16:03

QPSK

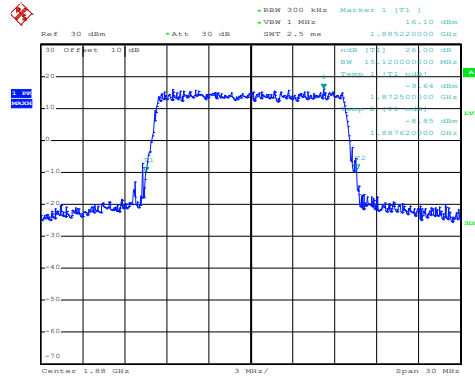

Date: 6.AUG.2020 14:15:59

Middle channel

16QAM

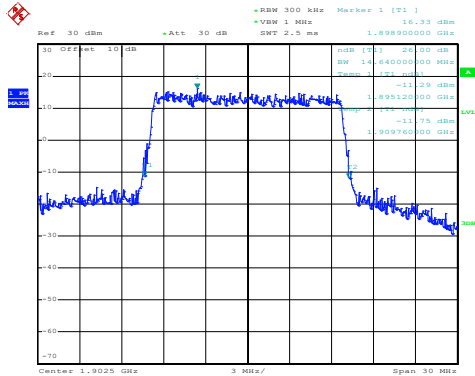

Date: 6.AUG.2020 14:16:43

QPSK

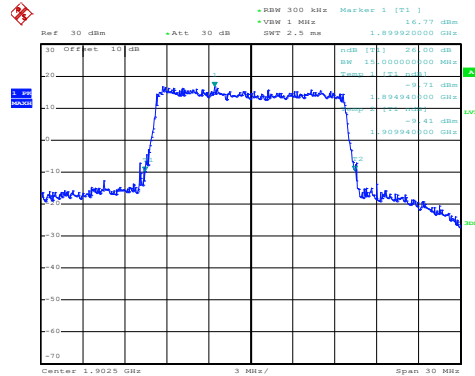

Date: 6.AUG.2020 14:16:39

Highest channel

LTE Band 2: -26dBc bandwidth BW: 20MHz

16QAM

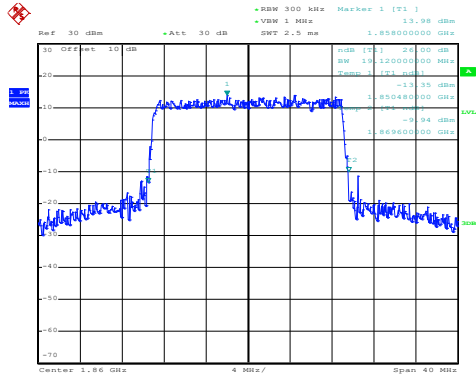

Date: 6.AUG.2020 14:17:04

QPSK

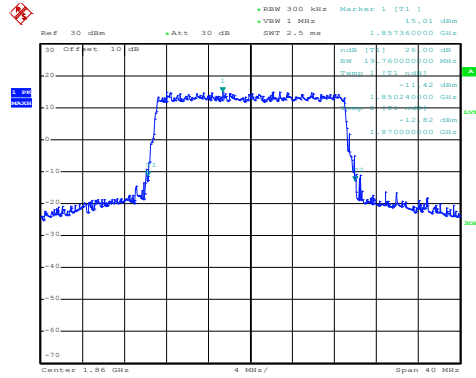

Date: 6.AUG.2020 14:17:00

Lowest channel

16QAM

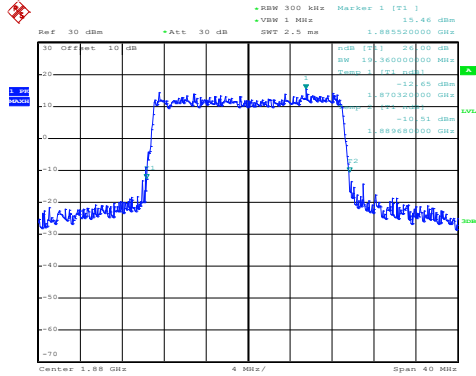

Date: 6.AUG.2020 14:17:37

QPSK

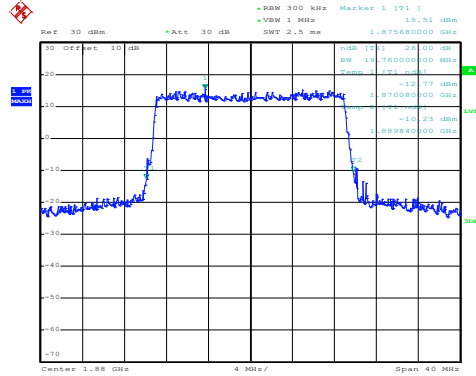

Date: 6.AUG.2020 14:17:32

Middle channel

16QAM

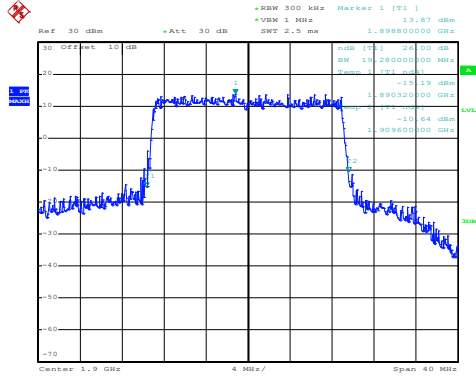

Date: 6.AUG.2020 14:17:51

QPSK

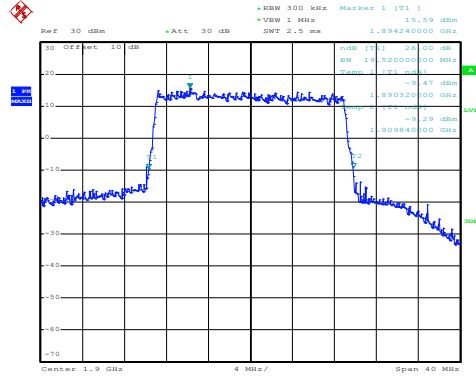

Date: 6.AUG.2020 14:17:47

Highest channel

LTE Band 4 part:

LTE Band 4: 99% Occupy bandwidth
BW: 1.4MHz

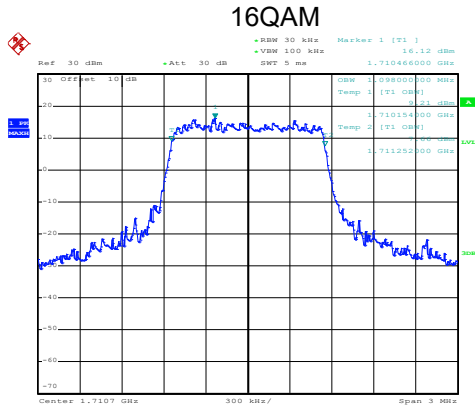

Date: 6.AUG.2020 14:02:19

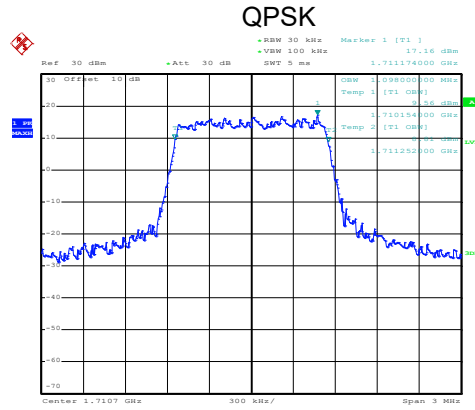

Date: 6.AUG.2020 14:02:10

Lowest channel

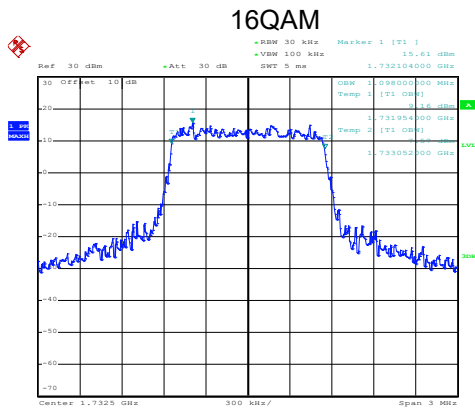

Date: 6.AUG.2020 14:01:58

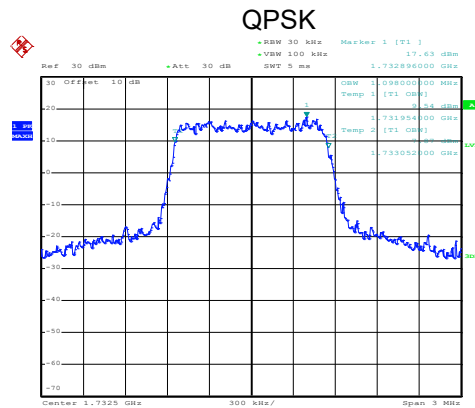

Date: 6.AUG.2020 14:01:55

Middle channel

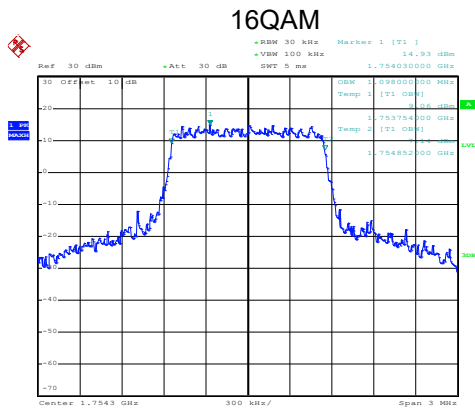

Date: 6.AUG.2020 14:01:26

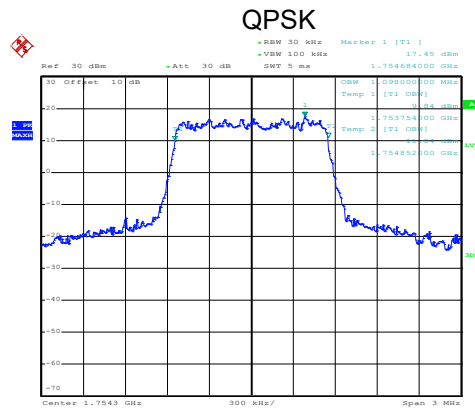

Date: 6.AUG.2020 14:01:22

Highest channel

LTE Band 4: 99% Occupancy bandwidth
BW: 3MHz

16QAM

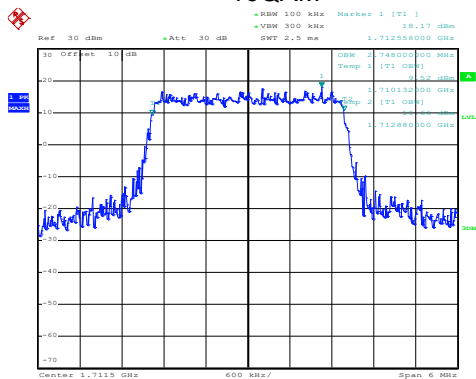

Date: 6.AUG.2020 14:03:09

QPSK

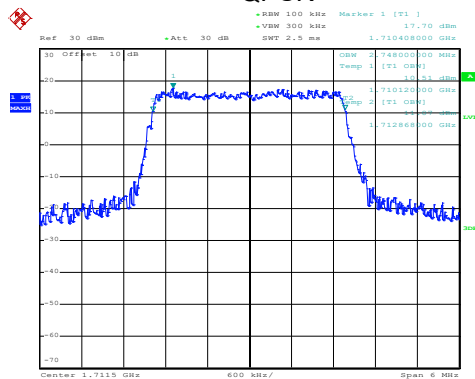

Date: 6.AUG.2020 14:03:05

Lowest channel

16QAM

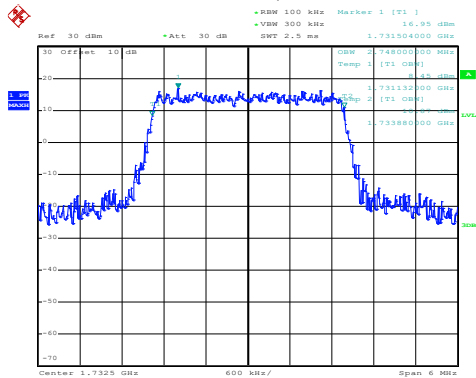

Date: 6.AUG.2020 14:03:21

QPSK

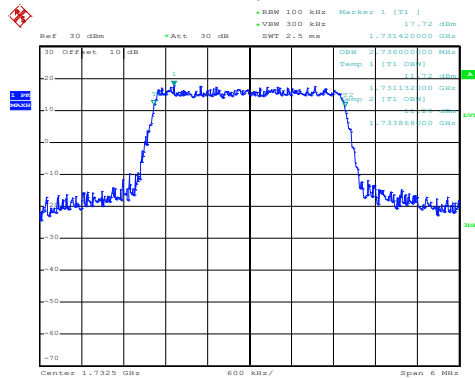

Date: 6.AUG.2020 14:03:18

Middle channel

16QAM

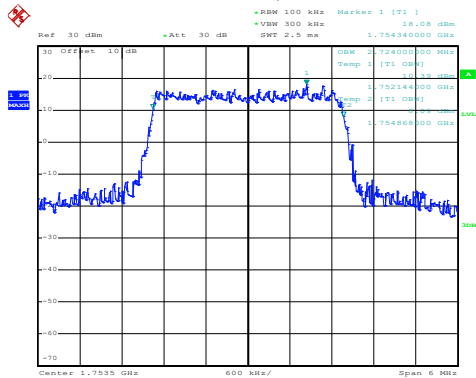

Date: 6.AUG.2020 14:03:58

QPSK

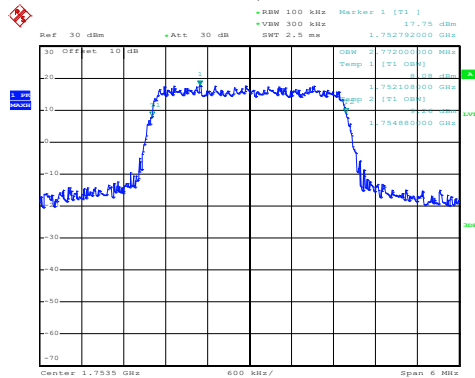

Date: 6.AUG.2020 14:03:55

Highest channel

LTE Band 4: 99% Occupancy bandwidth BW: 5MHz

16QAM

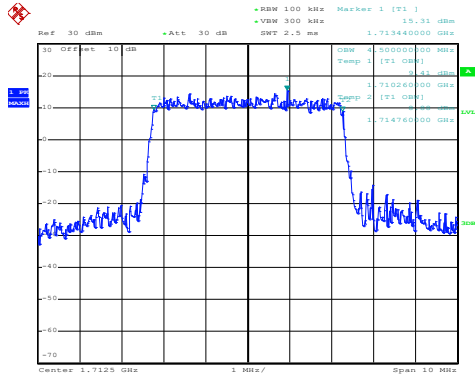

Date: 6.AUG.2020 14:04:18

QPSK

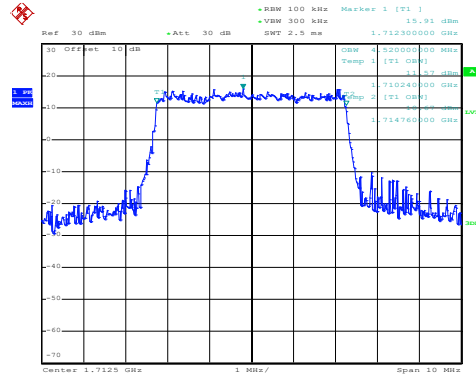

Date: 6.AUG.2020 14:04:14

Lowest channel

16QAM

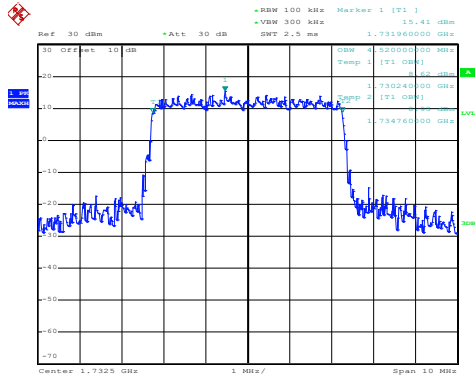

Date: 6.AUG.2020 14:04:51

QPSK

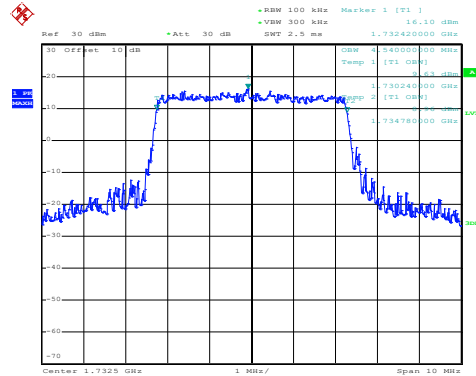

Date: 6.AUG.2020 14:04:47

Middle channel

16QAM

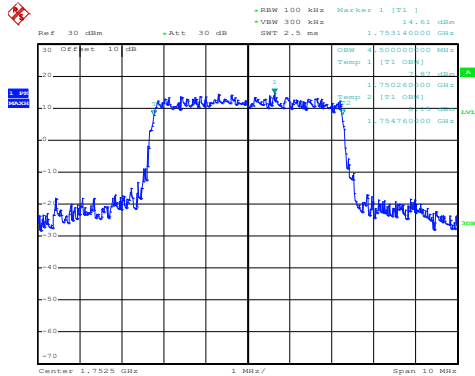

Date: 6.AUG.2020 14:05:05

QPSK

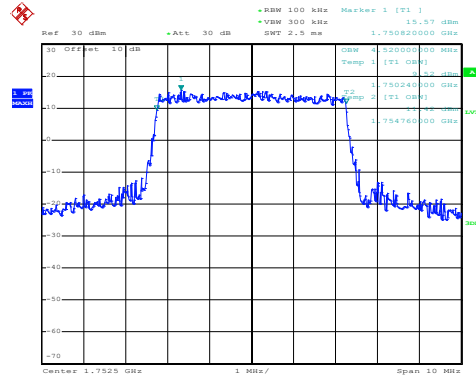

Date: 6.AUG.2020 14:05:02

Highest channel

LTE Band 4: 99% Occupancy bandwidth BW: 10MHz

16QAM

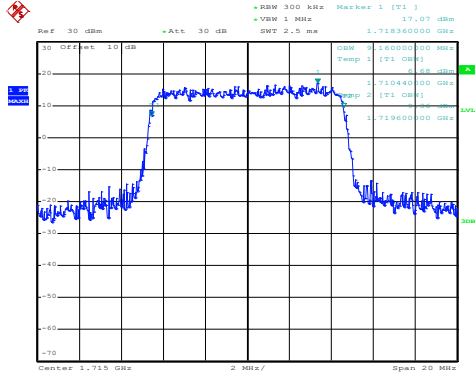

Date: 6.AUG.2020 14:05:52

QPSK

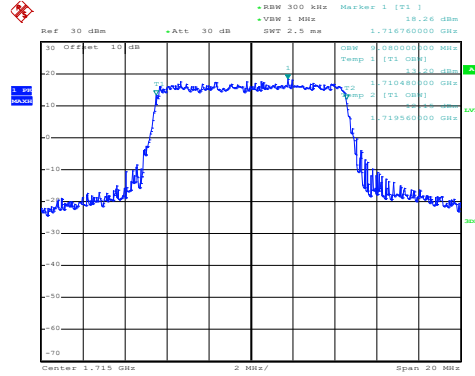

Date: 6.AUG.2020 14:05:48

Lowest channel

16QAM

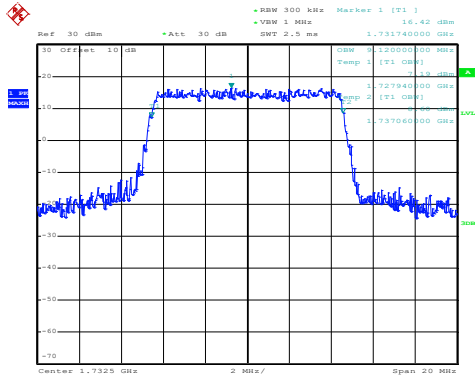

Date: 6.AUG.2020 14:06:04

QPSK

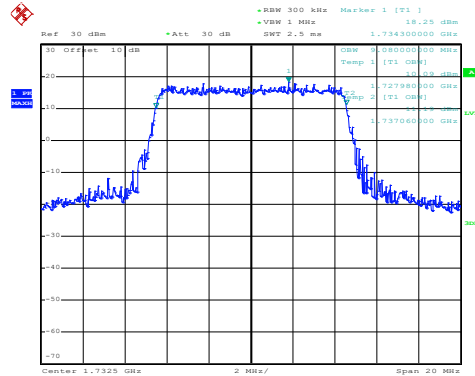

Date: 6.AUG.2020 14:06:00

Middle channel

16QAM

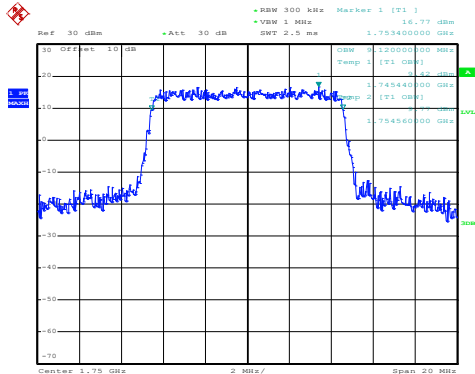

Date: 6.AUG.2020 14:06:44

QPSK

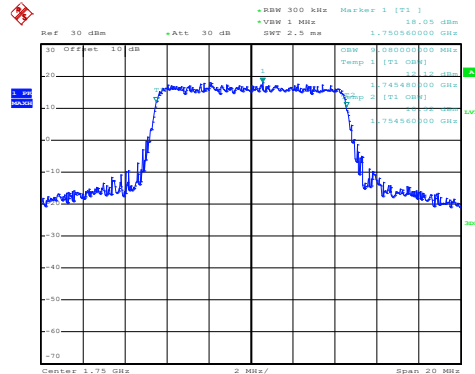

Date: 6.AUG.2020 14:06:41

Highest channel

LTE Band 4: 99% Occupancy bandwidth BW: 15MHz

16QAM

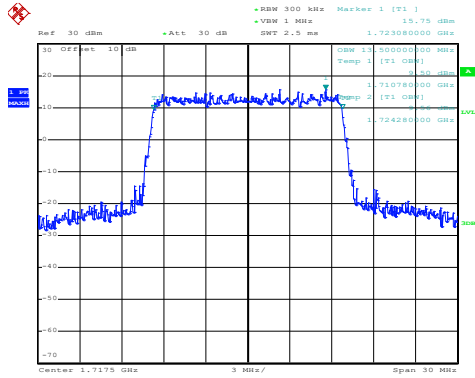

Date: 6.AUG.2020 14:07:05

QPSK

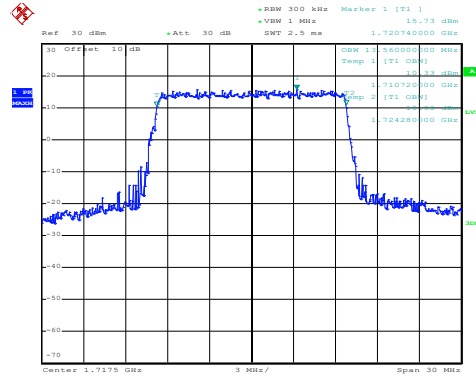

Date: 6.AUG.2020 14:07:02

Lowest channel

16QAM

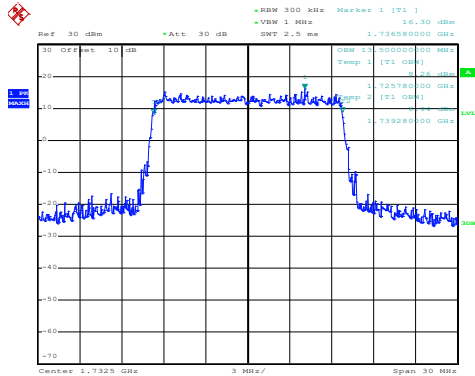

Date: 6.AUG.2020 14:07:37

QPSK

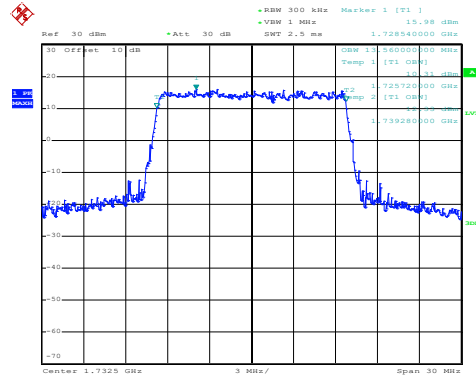

Date: 6.AUG.2020 14:07:34

Middle channel

16QAM

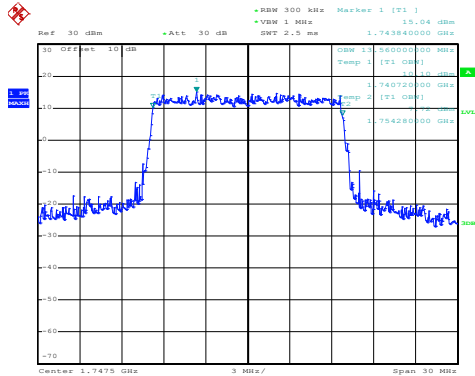

Date: 6.AUG.2020 14:07:54

QPSK

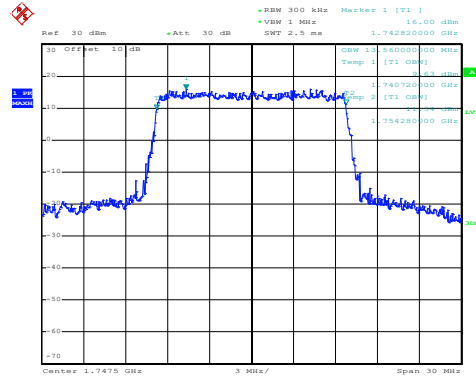

Date: 6.AUG.2020 14:07:51

Highest channel

LTE Band 4: 99% Occupancy bandwidth BW: 20MHz

16QAM

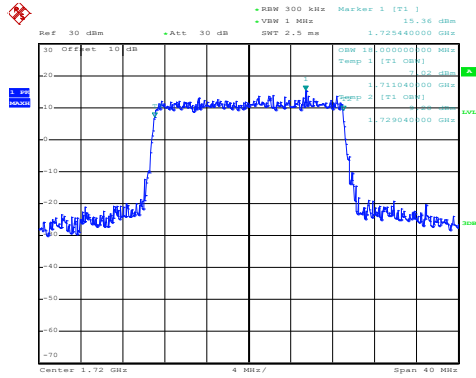

Date: 6.AUG.2020 14:08:32

QPSK

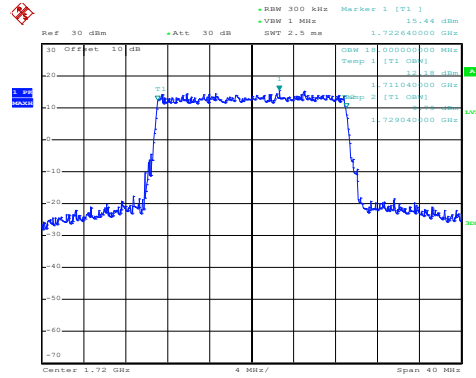

Date: 6.AUG.2020 14:08:29

Lowest channel

16QAM

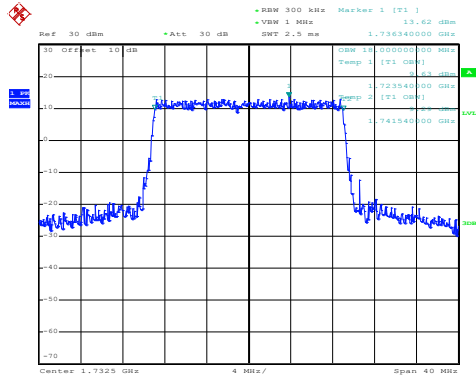

Date: 6.AUG.2020 14:08:46

QPSK

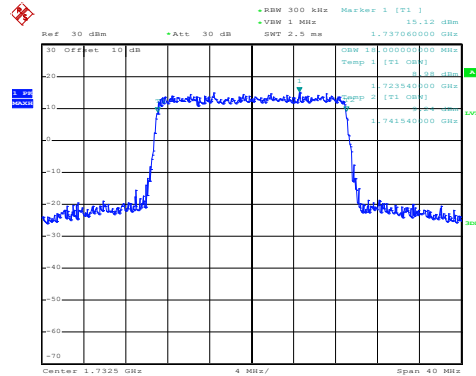

Date: 6.AUG.2020 14:08:43

Middle channel

16QAM

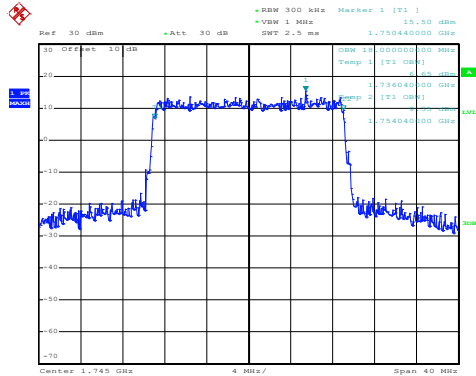

Date: 6.AUG.2020 14:09:18

QPSK

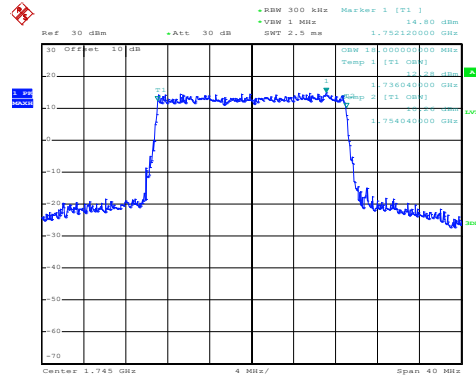

Date: 6.AUG.2020 14:09:14

Highest channel

LTE Band 4: -26dBc bandwidth
BW: 1.4MHz

16QAM

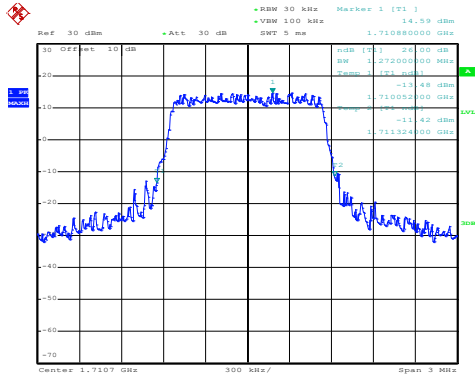

Date: 6.AUG.2020 14:02:35

QPSK

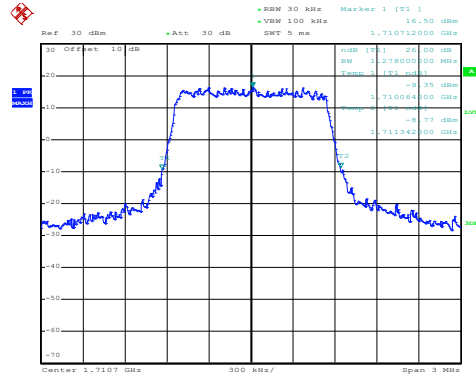

Date: 6.AUG.2020 14:02:31

Lowest channel

16QAM

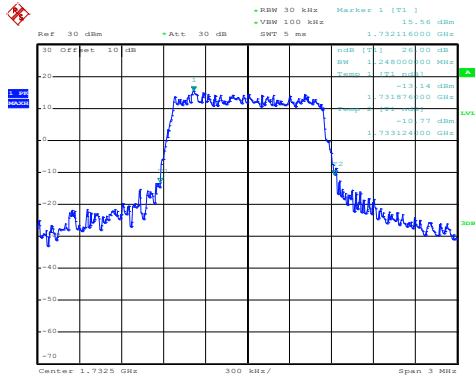

Date: 6.AUG.2020 14:01:49

QPSK

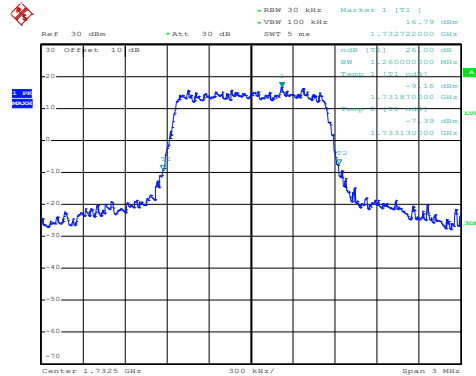

Date: 6.AUG.2020 14:01:46

Middle channel

16QAM

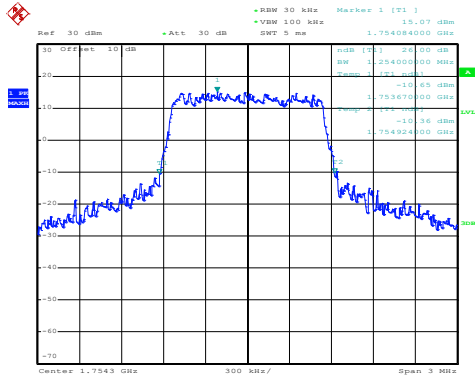

Date: 6.AUG.2020 14:01:36

QPSK

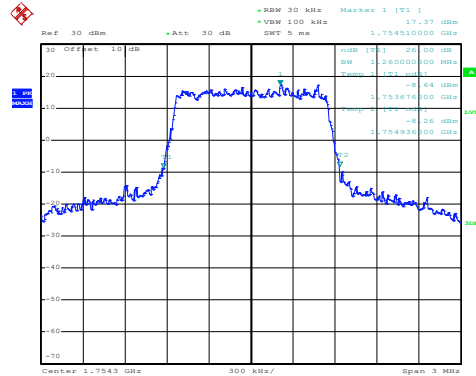

Date: 6.AUG.2020 14:01:33

Highest channel

LTE Band 4: -26dBc bandwidth
BW: 3MHz

16QAM

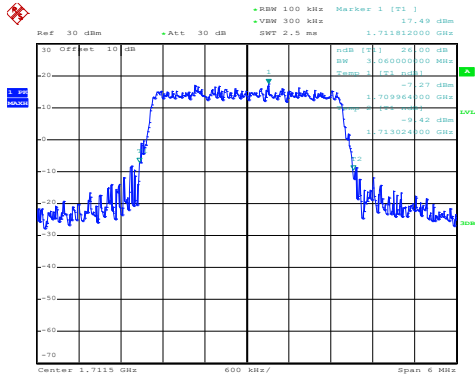

Date: 6.AUG.2020 14:02:59

QPSK

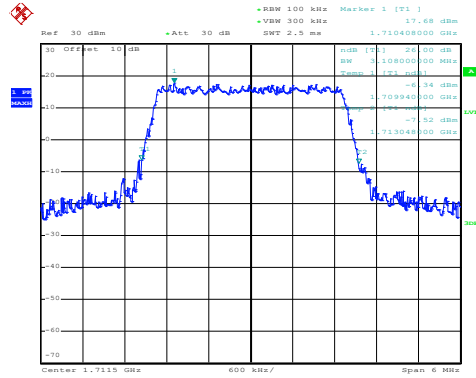

Date: 6.AUG.2020 14:02:56

Lowest channel

16QAM

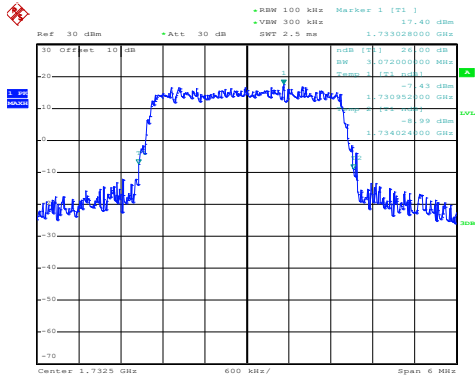

Date: 6.AUG.2020 14:03:32

QPSK

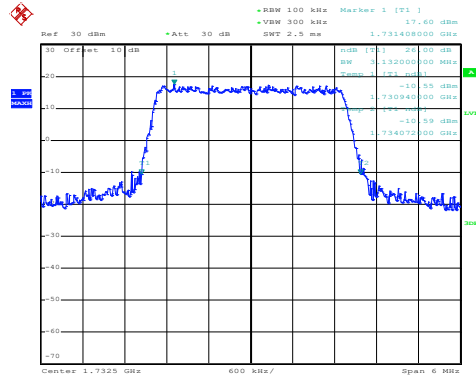

Date: 6.AUG.2020 14:03:28

Middle channel

16QAM

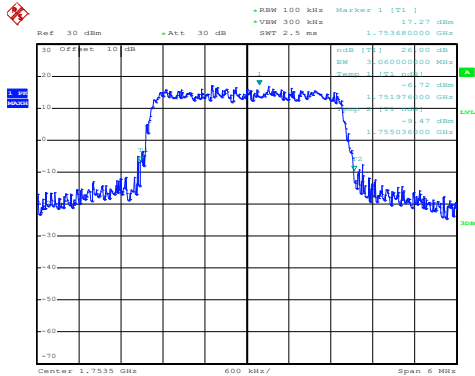

Date: 6.AUG.2020 14:03:49

QPSK

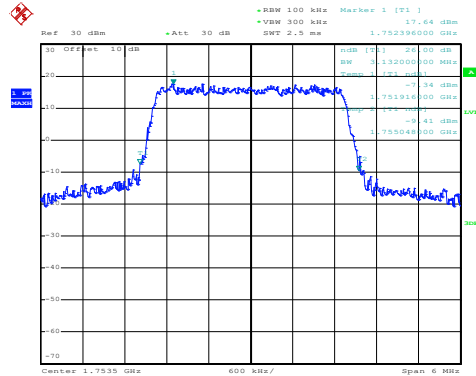

Date: 6.AUG.2020 14:03:46

Highest channel

LTE Band 4: -26dBc bandwidth BW: 5MHz

16QAM

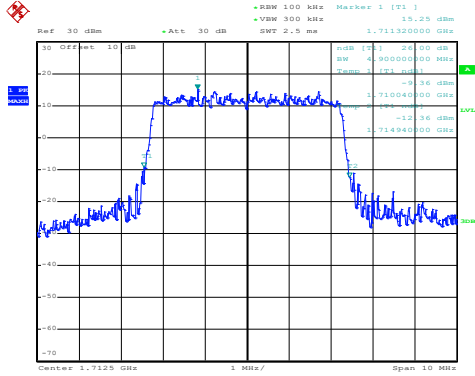

Date: 6.AUG.2020 14:04:28

QPSK

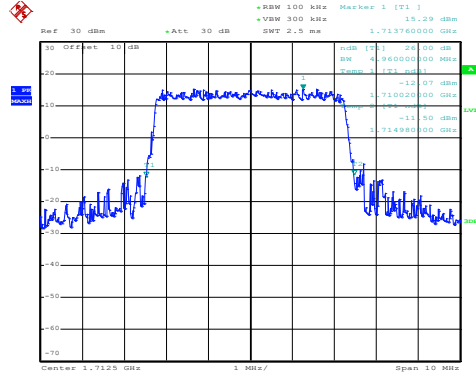

Date: 6.AUG.2020 14:04:24

Lowest channel

16QAM

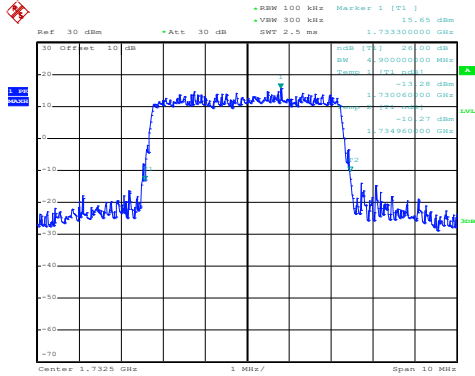

Date: 6.AUG.2020 14:04:42

QPSK

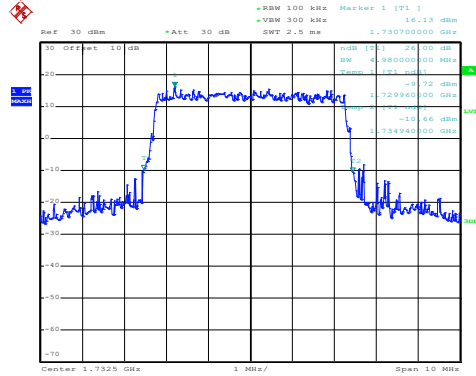

Date: 6.AUG.2020 14:04:38

Middle channel

16QAM

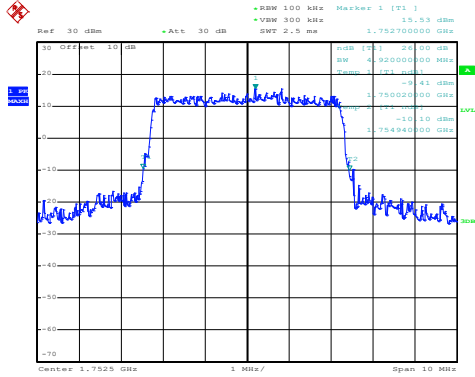

Date: 6.AUG.2020 14:05:16

QPSK

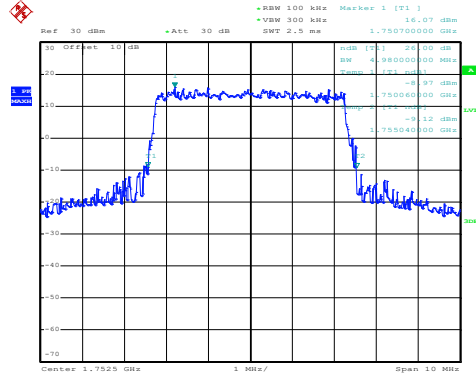

Date: 6.AUG.2020 14:05:12

Highest channel

LTE Band 4: -26dBc bandwidth
BW: 10MHz

16QAM

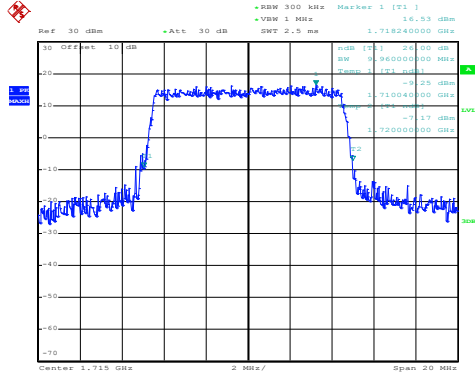

Date: 6.AUG.2020 14:05:42

QPSK

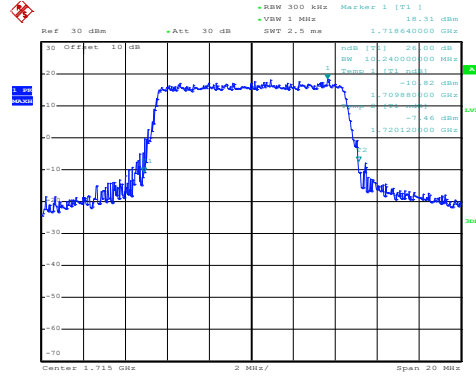

Date: 6.AUG.2020 14:05:39

Lowest channel

16QAM

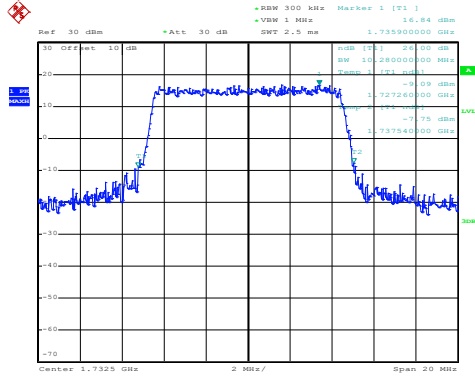

Date: 6.AUG.2020 14:06:15

QPSK

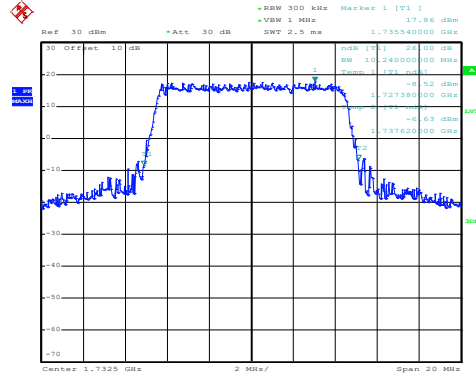

Date: 6.AUG.2020 14:06:10

Middle channel

16QAM

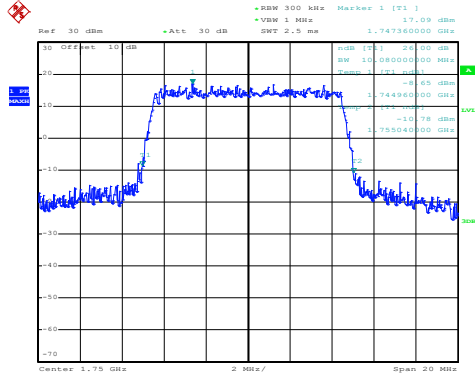

Date: 6.AUG.2020 14:06:33

QPSK

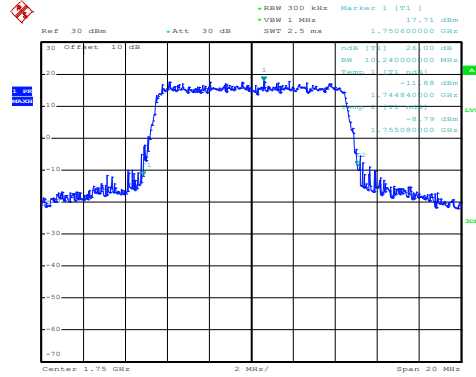

Date: 6.AUG.2020 14:06:30

Highest channel

LTE Band 4: -26dBc bandwidth
BW: 15MHz

16QAM

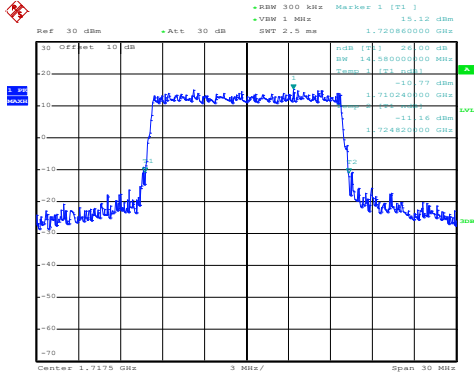

Date: 6.AUG.2020 14:07:15

QPSK

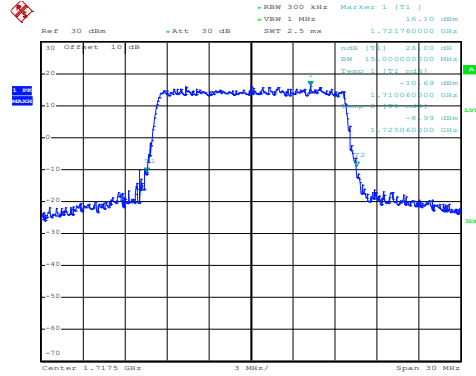

Date: 6.AUG.2020 14:07:12

Lowest channel

16QAM

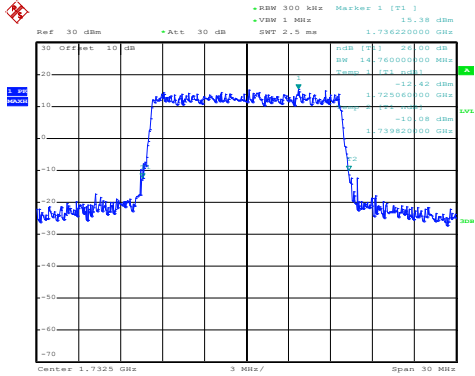

Date: 6.AUG.2020 14:07:28

QPSK

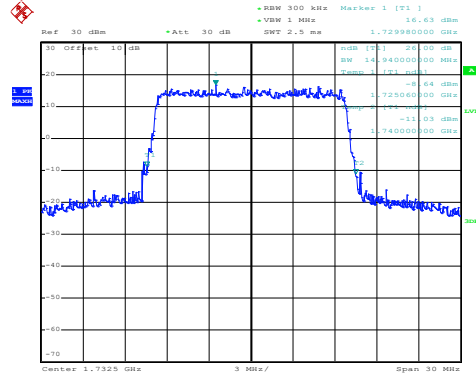

Date: 6.AUG.2020 14:07:25

Middle channel

16QAM

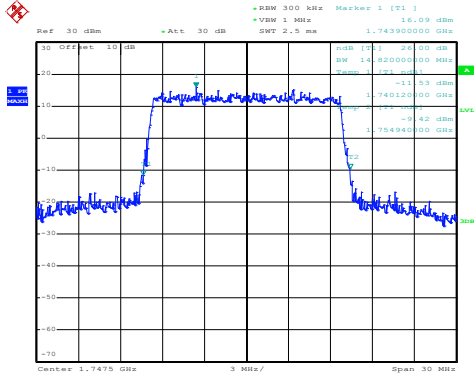

Date: 6.AUG.2020 14:08:04

QPSK

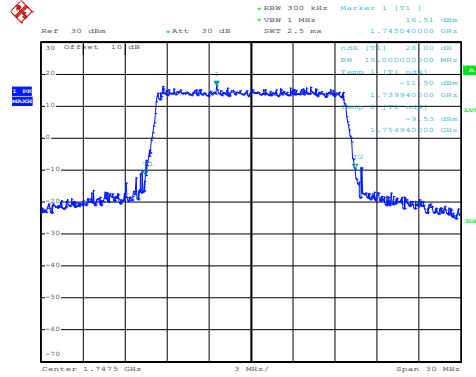

Date: 6.AUG.2020 14:08:00

Highest channel

LTE Band 4: -26dBc bandwidth BW: 20MHz

16QAM

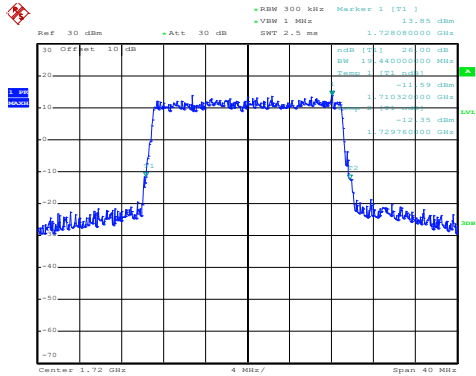

Date: 6.AUG.2020 14:08:23

QPSK

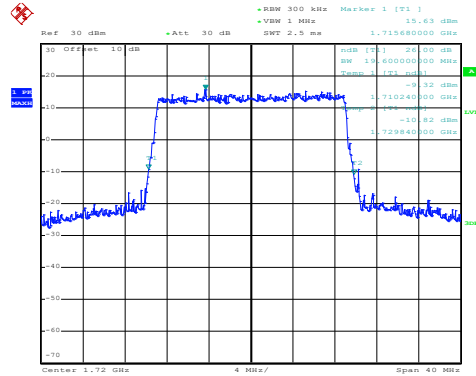

Date: 6.AUG.2020 14:08:20

Lowest channel

16QAM

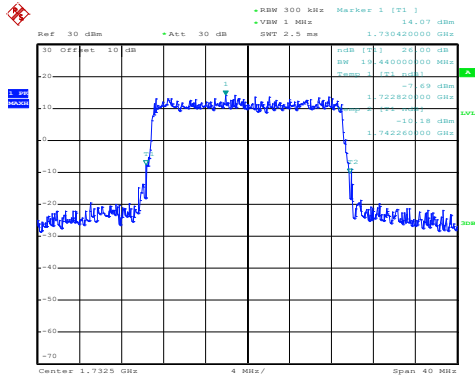

Date: 6.AUG.2020 14:08:56

QPSK

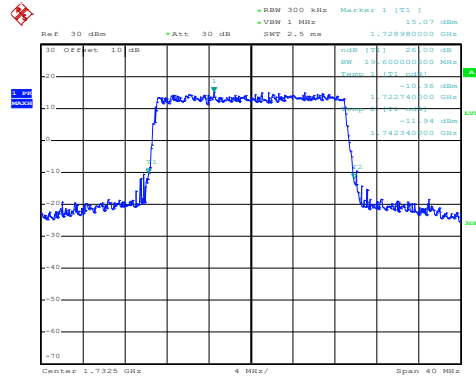

Date: 6.AUG.2020 14:08:53

Middle channel

16QAM

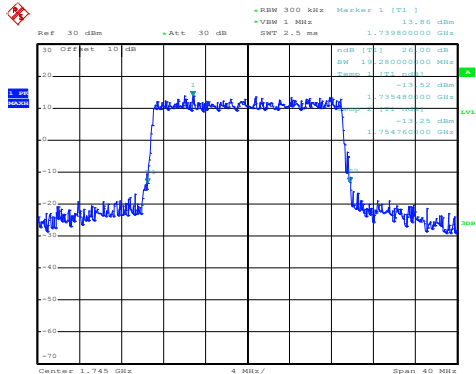

Date: 6.AUG.2020 14:09:08

QPSK

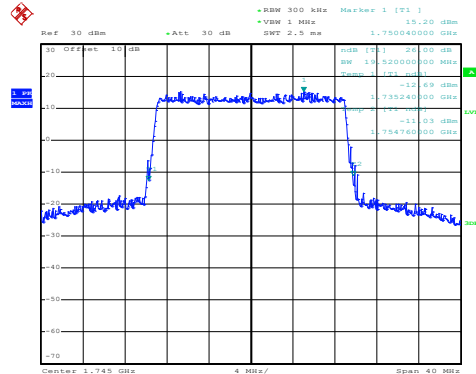

Date: 6.AUG.2020 14:09:05

Highest channel

LTE-Band 7 part:

LTE Band 7: 99% Occupy bandwidth BW: 5MHz

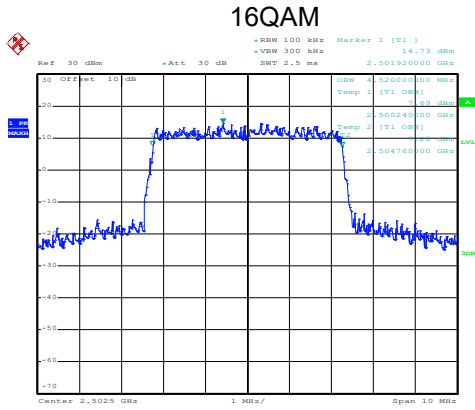

Date: 6.AUG.2020 14:22:48

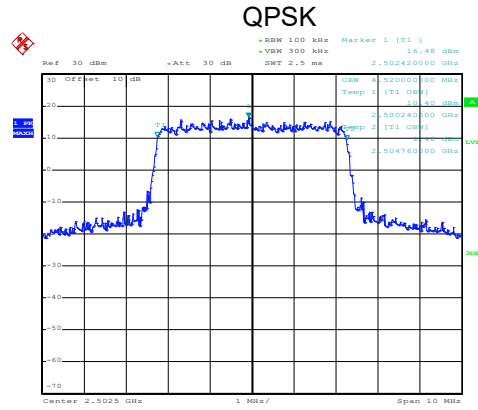

Date: 6.AUG.2020 14:22:44

Lowest channel

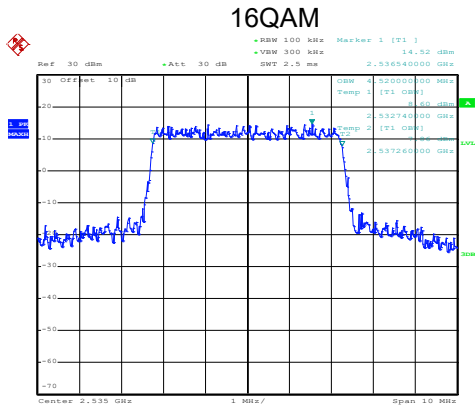

Date: 6.AUG.2020 14:23:01

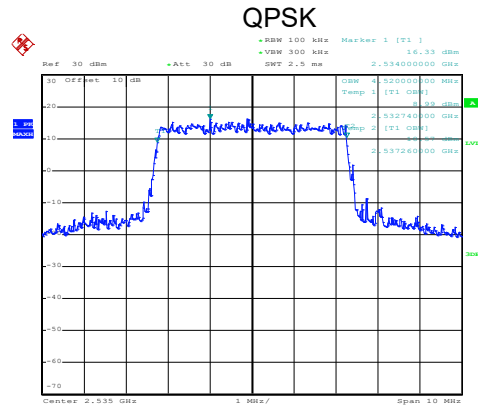

Date: 6.AUG.2020 14:22:57

Middle channel

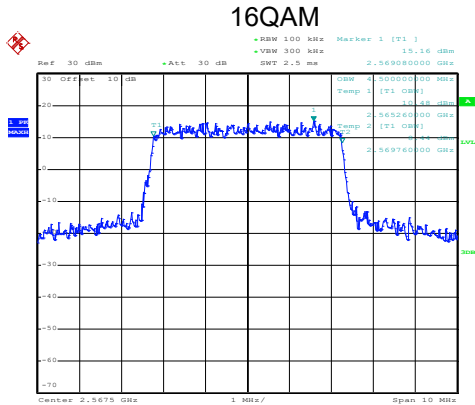

Date: 6.AUG.2020 14:23:35

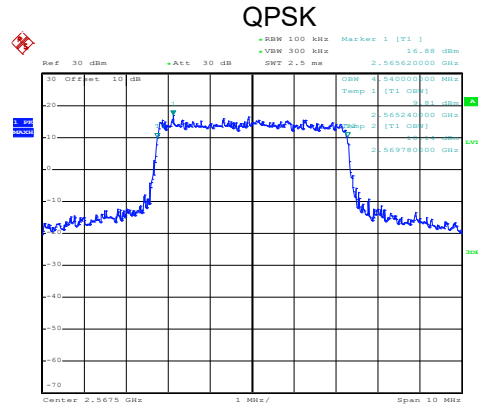

Date: 6.AUG.2020 14:23:32

Highest channel

LTE Band 7: 99% Occupancy bandwidth BW: 10MHz

16QAM

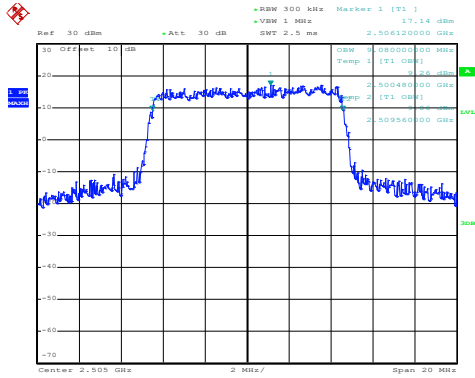

Date: 6.AUG.2020 14:21:12

QPSK

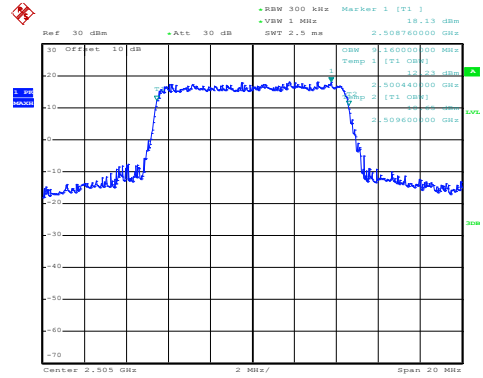

Date: 6.AUG.2020 14:21:08

Lowest channel

16QAM

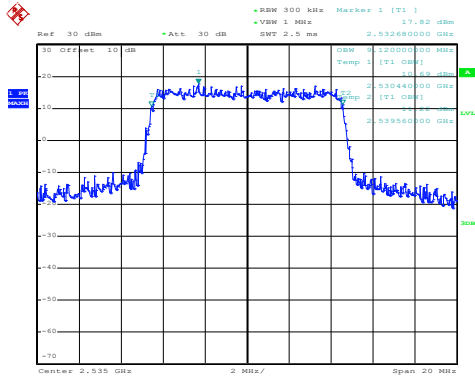

Date: 6.AUG.2020 14:21:44

QPSK

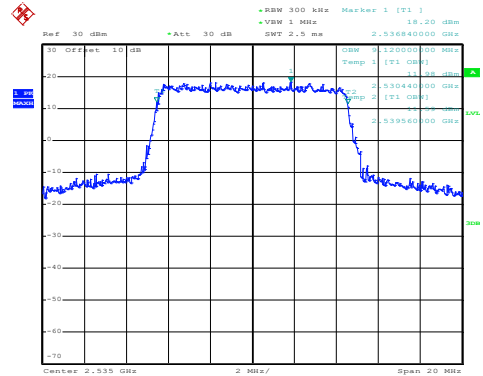

Date: 6.AUG.2020 14:21:40

Middle channel

16QAM

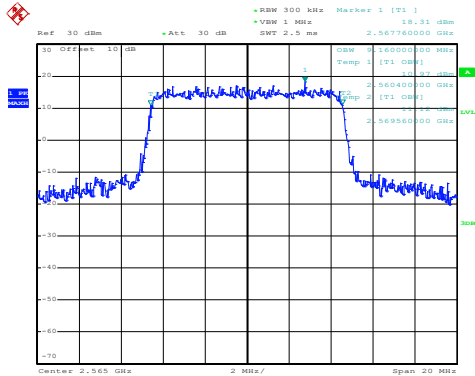

Date: 6.AUG.2020 14:22:00

QPSK

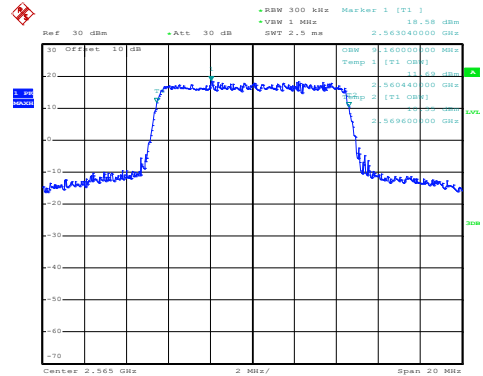

Date: 6.AUG.2020 14:21:56

Highest channel

LTE Band 7: 99% Occupancy bandwidth BW: 15MHz

16QAM

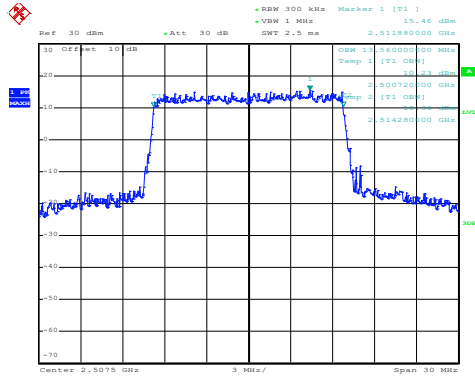

Date: 6.AUG.2020 14:19:57

QPSK

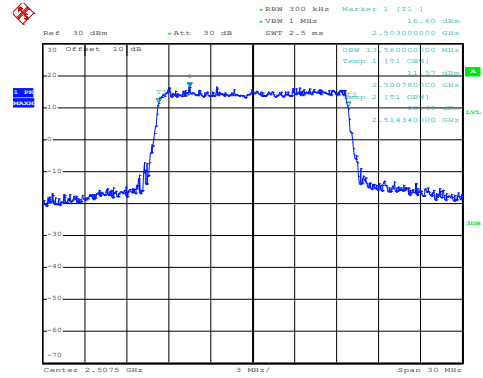

Date: 6.AUG.2020 14:19:53

Lowest channel

16QAM

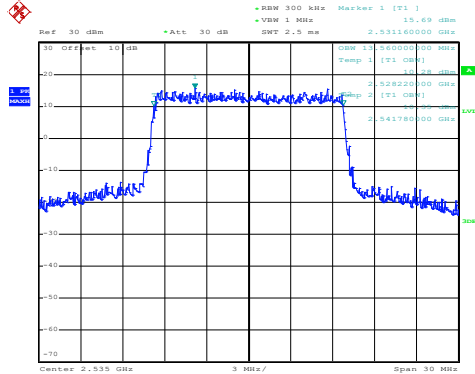

Date: 6.AUG.2020 14:20:13

QPSK

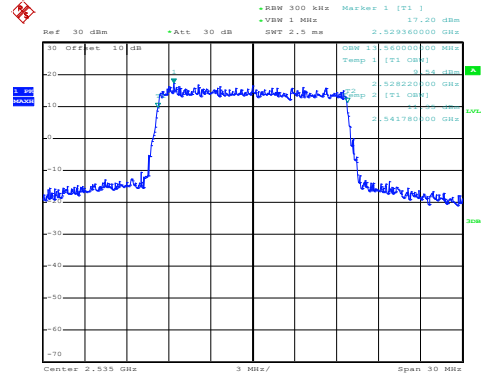

Date: 6.AUG.2020 14:20:10

Middle channel

16QAM

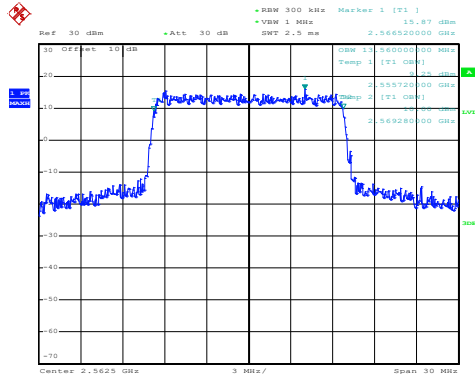

Date: 6.AUG.2020 14:20:49

QPSK

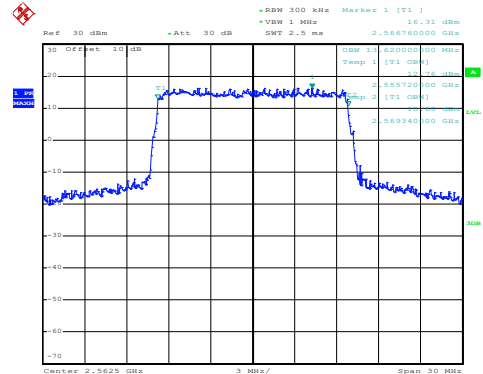

Date: 6.AUG.2020 14:20:45

Highest channel

LTE Band 7: 99% Occupancy bandwidth BW: 20MHz

16QAM

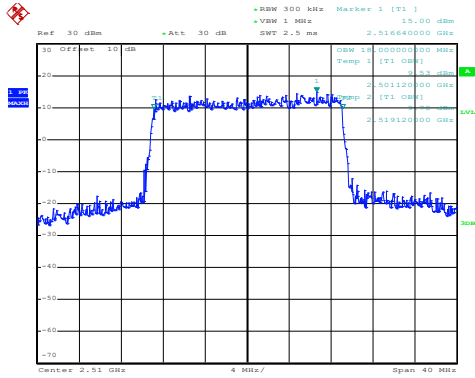

Date: 6.AUG.2020 14:19:04

QPSK

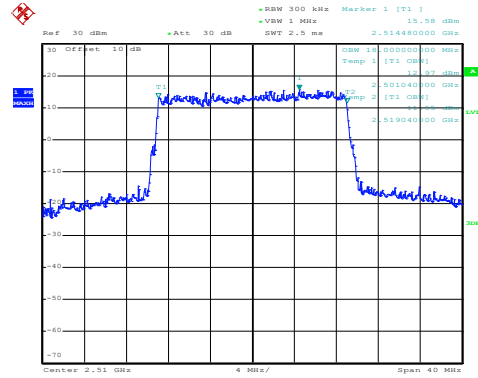

Date: 6.AUG.2020 14:19:00

Lowest channel

16QAM

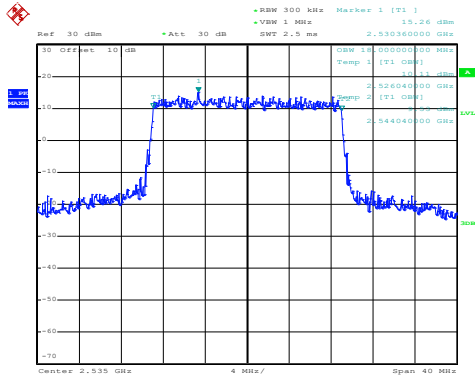

Date: 6.AUG.2020 14:18:49

QPSK

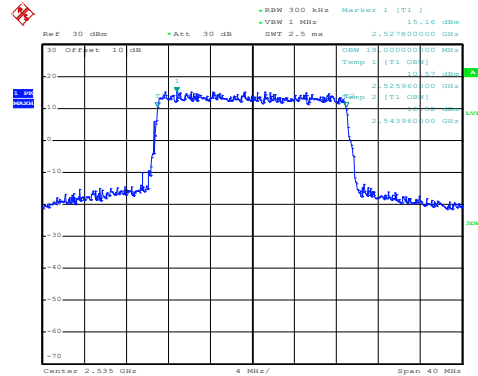

Date: 6.AUG.2020 14:18:45

Middle channel

16QAM

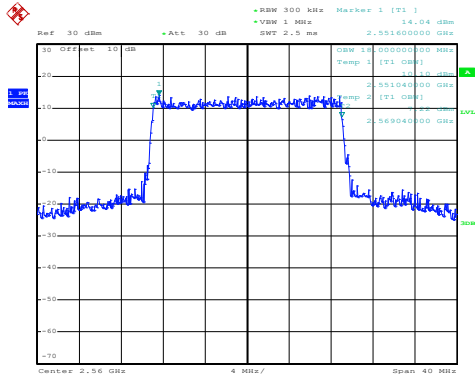

Date: 6.AUG.2020 14:18:17

QPSK

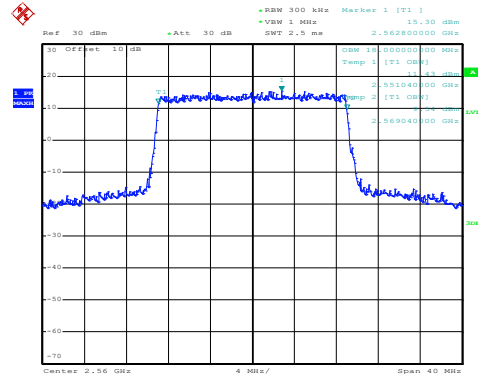

Date: 6.AUG.2020 14:18:13

Highest channel

LTE Band 7: -26dBc bandwidth
BW: 5MHz

16QAM

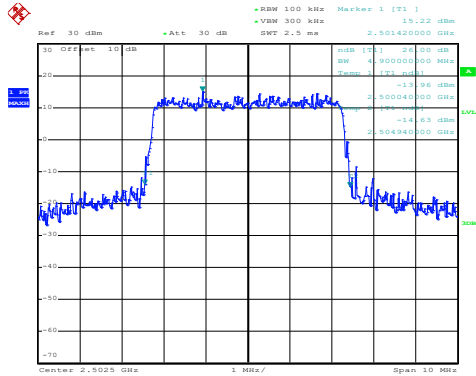

Date: 6.AUG.2020 14:22:38

QPSK

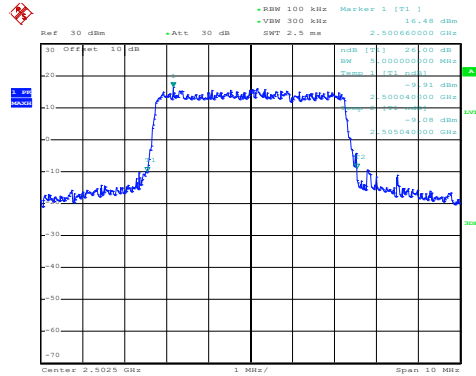

Date: 6.AUG.2020 14:22:34

Lowest channel

16QAM

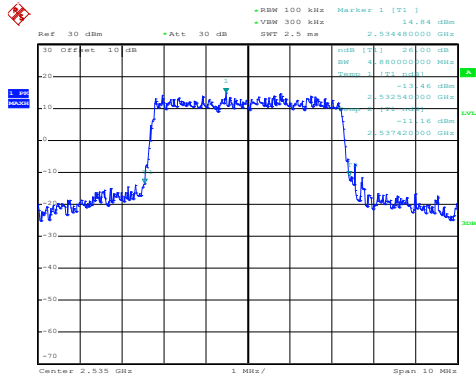

Date: 6.AUG.2020 14:23:12

QPSK

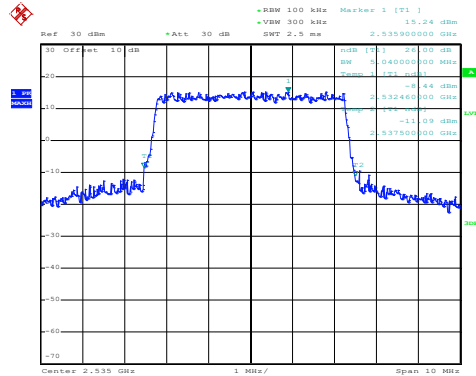

Date: 6.AUG.2020 14:23:08

Middle channel

16QAM

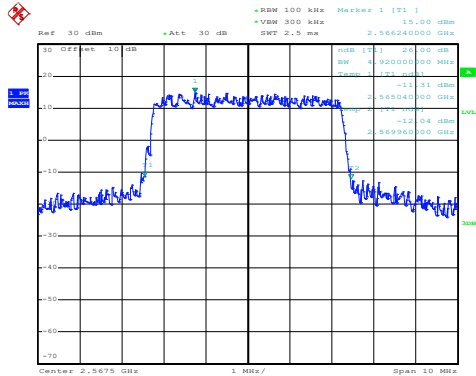

Date: 6.AUG.2020 14:23:25

QPSK

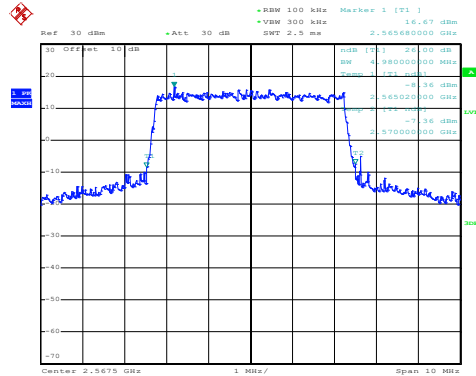

Date: 6.AUG.2020 14:23:22

Highest channel

LTE Band 7: -26dBc bandwidth
BW: 10MHz

16QAM

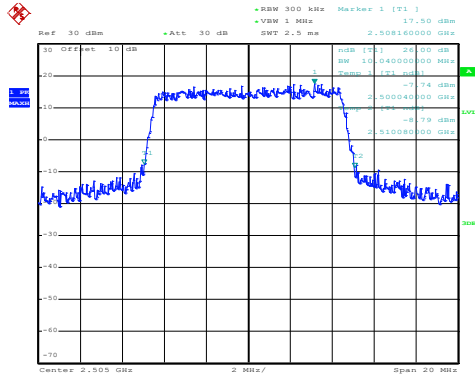

Date: 6.AUG.2020 14:21:22

QPSK

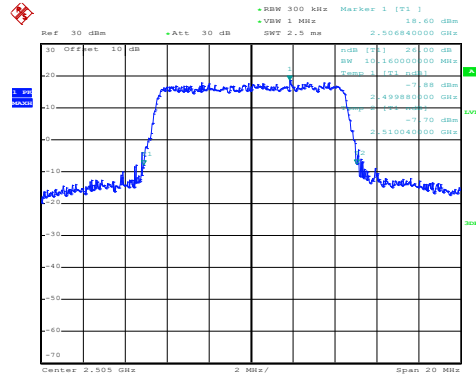

Date: 6.AUG.2020 14:21:18

Lowest channel

16QAM

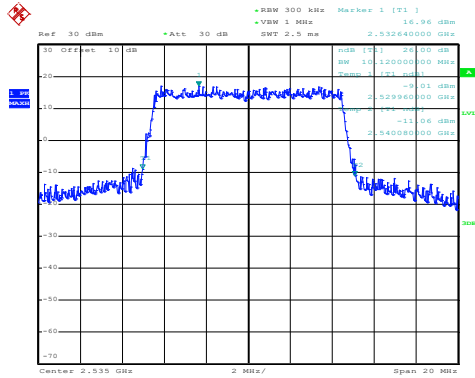

Date: 6.AUG.2020 14:21:33

QPSK

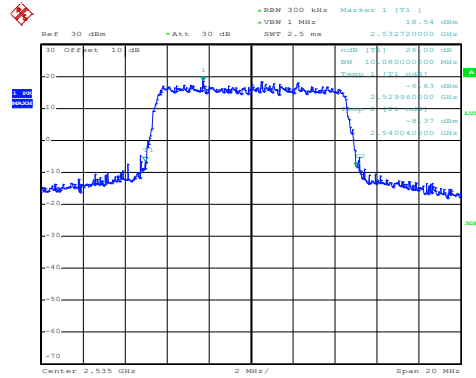

Date: 6.AUG.2020 14:21:30

Middle channel

16QAM

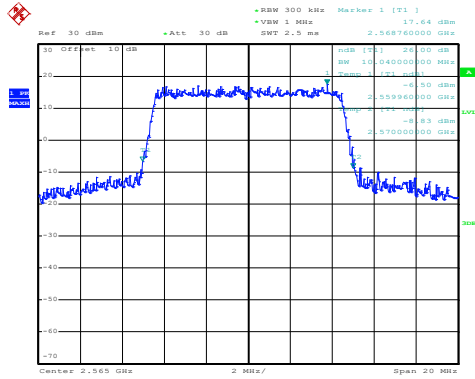

Date: 6.AUG.2020 14:22:11

QPSK

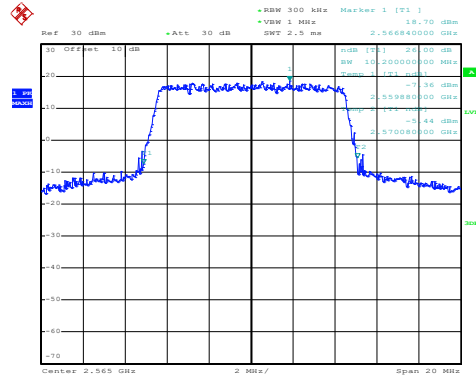

Date: 6.AUG.2020 14:22:07

Highest channel

LTE Band 7: -26dBc bandwidth BW: 15MHz

16QAM

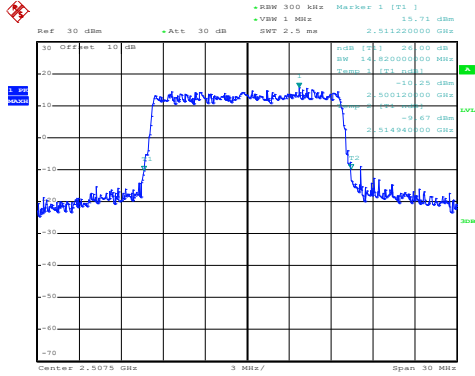

Date: 6.AUG.2020 14:19:47

QPSK

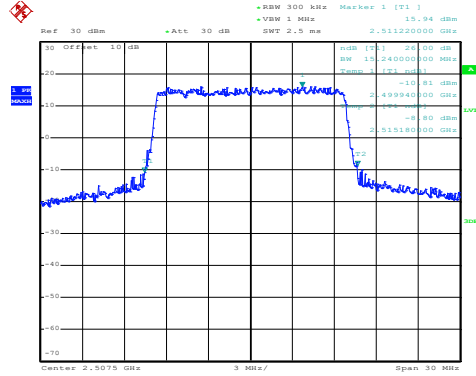

Date: 6.AUG.2020 14:19:44

Lowest channel

16QAM

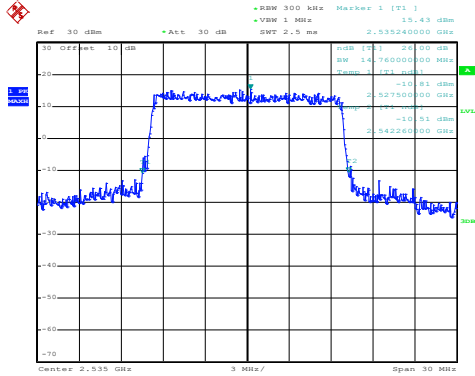

Date: 6.AUG.2020 14:20:23

QPSK

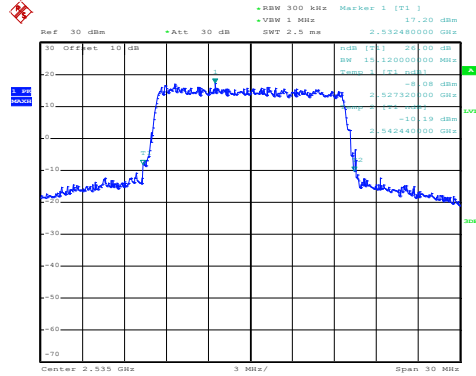

Date: 6.AUG.2020 14:20:19

Middle channel

16QAM

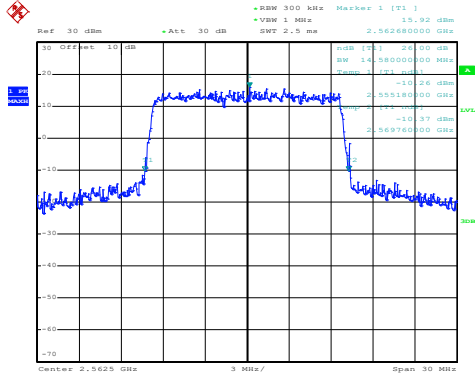

Date: 6.AUG.2020 14:20:39

QPSK

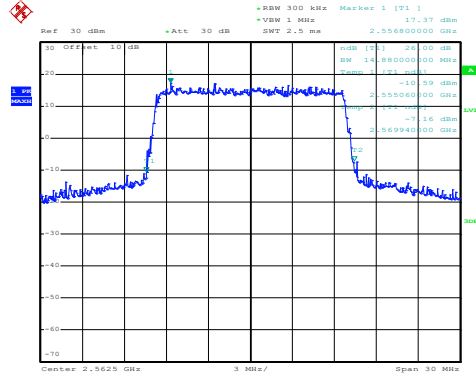

Date: 6.AUG.2020 14:20:35

Highest channel

LTE Band 7: -26dBc bandwidth BW: 20MHz

16QAM

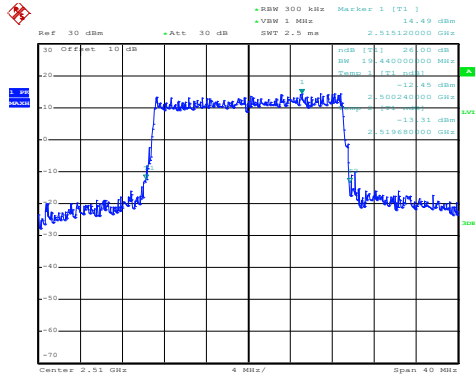

QPSK

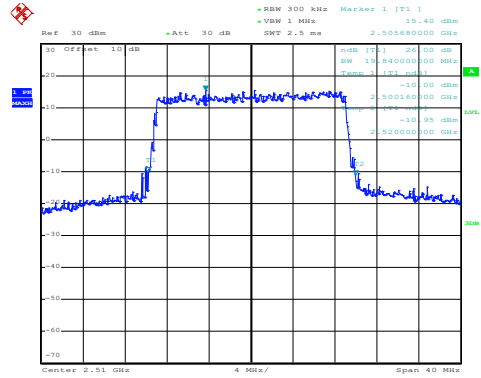

Lowest channel

16QAM

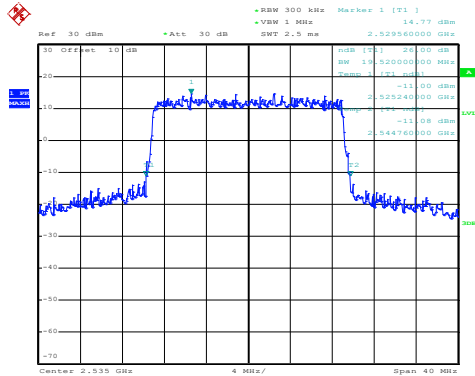

QPSK

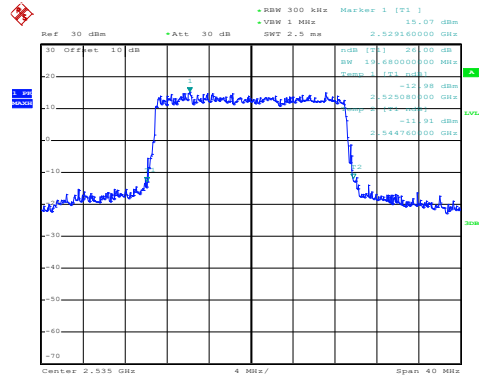

Middle channel

16QAM

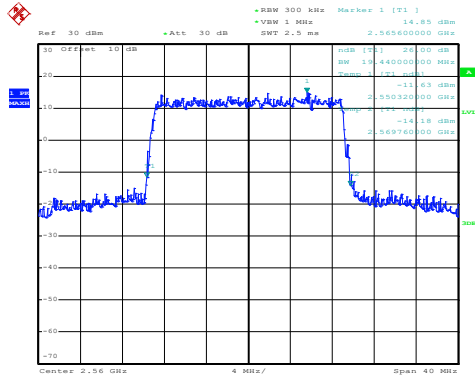

QPSK

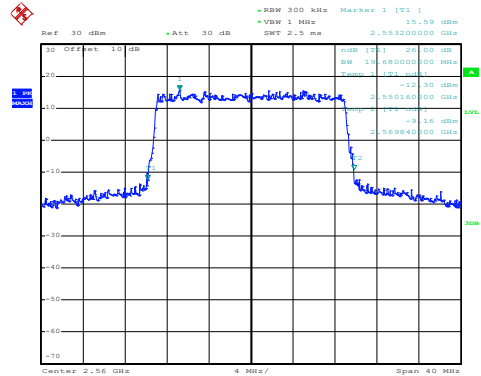

Highest channel

6.4 Out of band emission at antenna terminals

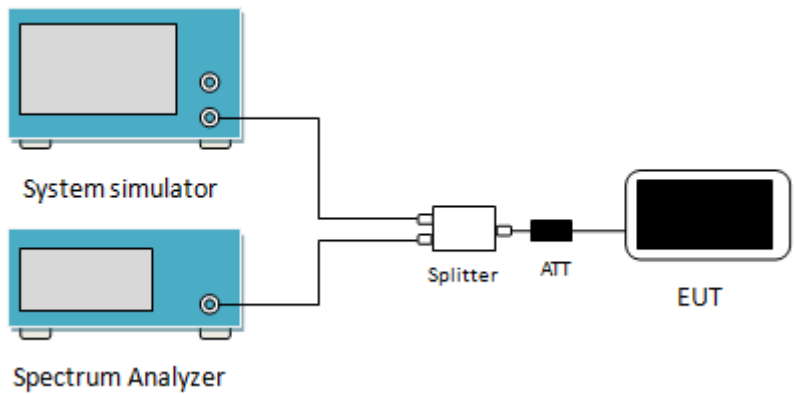
Test Requirement:	Part 24.238 (a), part 27.53(h), Part 27.53(m)
Limit:	<p>LTE Band 2 & 4: The power of any emission outside a licensee's frequency block shall be attenuated below the transmitter power (P) in watts by at least $43 + 10 \log_{10}(P)$ dB (-13 dBm).</p> <p>LTE Band 7: For mobile digital stations, the attenuation factor shall be not less than $40 + 10 \log(P)$ dB on all frequencies between the channel edge and 5 megahertz from the channel edge, $43 + 10 \log(P)$ dB on all frequencies between 5 megahertz and X megahertz from the channel edge, and $55 + 10 \log(P)$ dB on all frequencies more than X megahertz from the channel edge, where X is the greater of 6 megahertz or the actual emission bandwidth as defined in paragraph (m)(6) of this section. In addition, the attenuation factor shall not be less that $43 + 10 \log(P)$ dB on all frequencies between 2490.5 MHz and 2496 MHz and $55 + 10 \log(P)$ dB at or below 2490.5 MHz.</p>
Test Setup:	
Test Procedure:	<ol style="list-style-type: none"> 1 The RF output of the transceiver was connected to a spectrum analyzer through appropriate attenuation. 2 For the out of band: For Band 5 & 12 & 17 set the RBW=100 kHz, VBW=300 kHz and for Band 2 & 4 & 7 set the RBW=1 MHz, VBW=3 MHz when below 1 GHz, RBW =1 MHz, VBW=3 MHz when above 1 GHz, Start=30MHz, Stop= 10th harmonic. 3 Band Edge Requirements: In the 1 MHz bands immediately outside and adjacent to the frequency block, a resolution bandwidth of at least 1 percent of the emission bandwidth of the fundamental emission of the transmitter may be employed to measure the out of band Emissions.
Test Instruments:	Refer to section 5.10 for details
Test mode:	Refer to section 5.3 for details
Test results:	Passed
Remark:	Pre-scan all RB Size and offset, and found the RB Size and offset of worst case, so the report shows only the worst case test data.

Test plots as follows (Conducted spurious emission) (worst case):
 LTE Band 2 part:

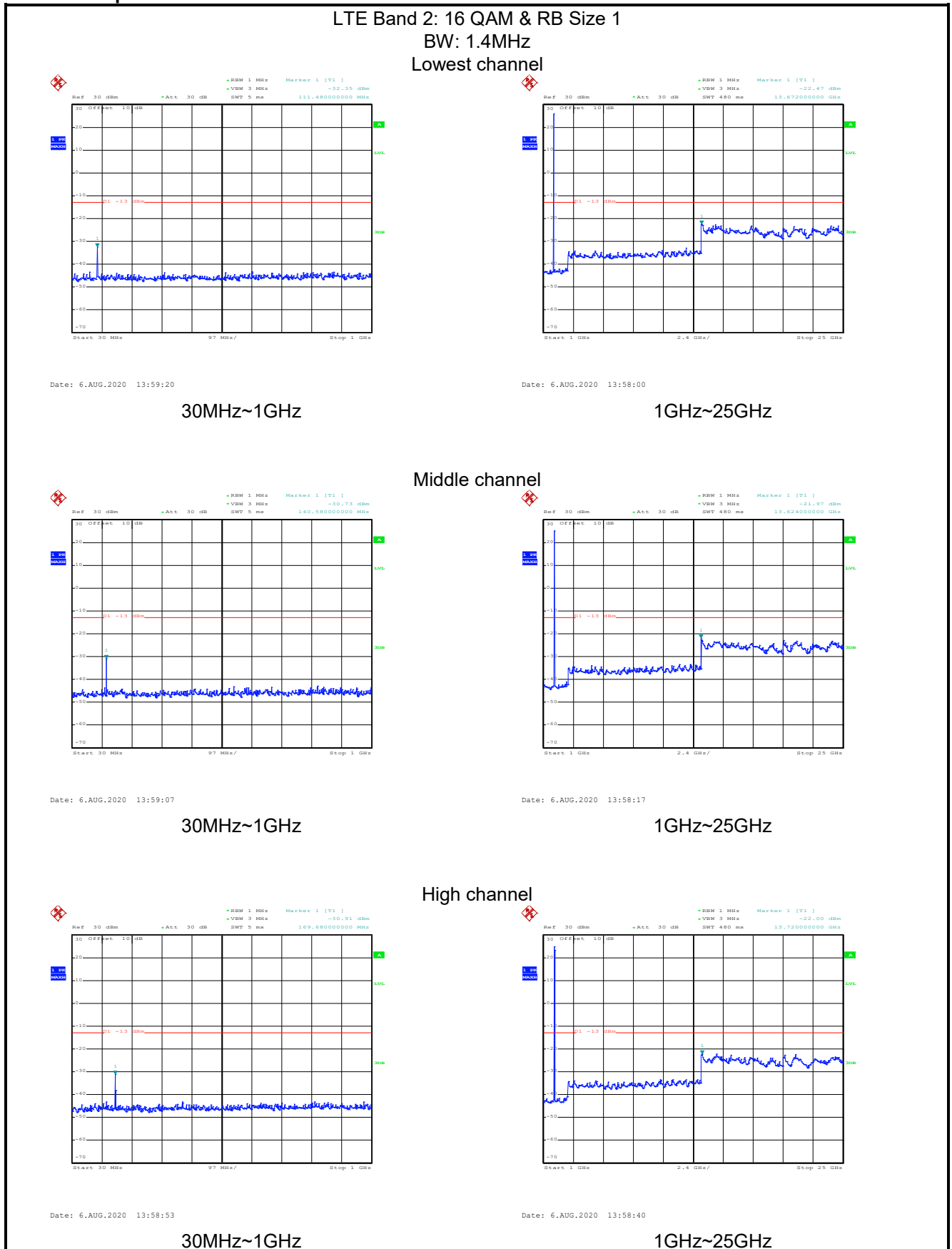

LTE Band 2: QPSK & RB Size 1 BW: 1.4MHz Lowest channel

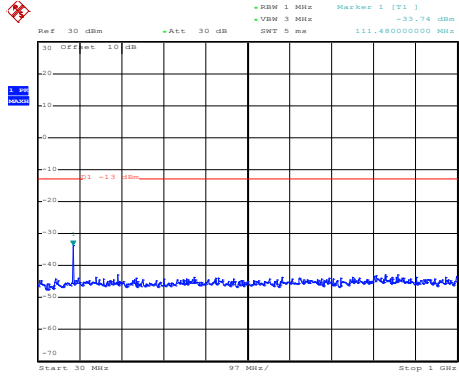

Date: 6.AUG.2020 13:59:16

30MHz~1GHz

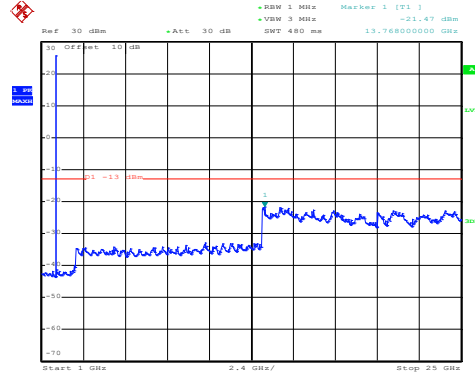

Date: 6.AUG.2020 13:57:52

1GHz~25GHz

Middle channel

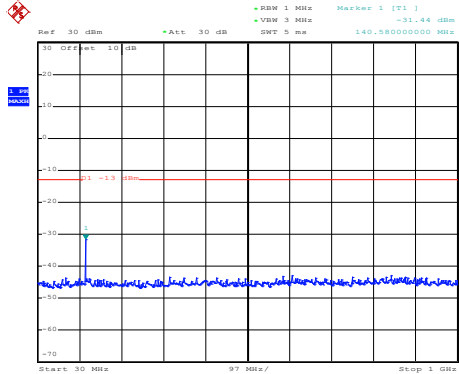

Date: 6.AUG.2020 13:59:03

30MHz~1GHz

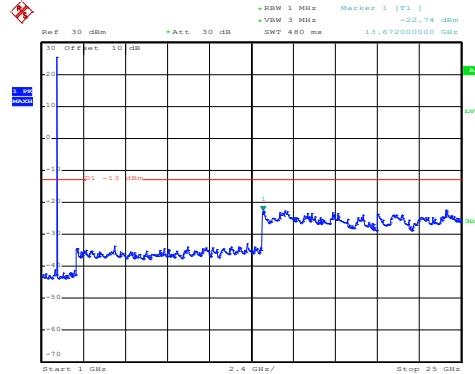

Date: 6.AUG.2020 13:58:09

1GHz~25GHz

High channel

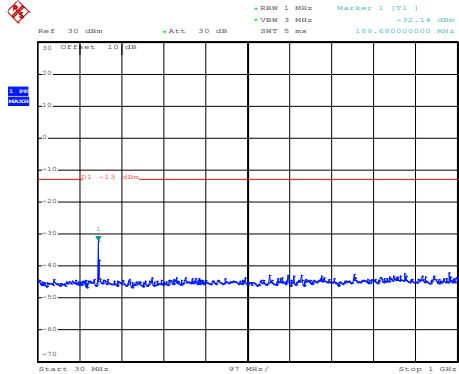

Date: 6.AUG.2020 13:58:49

30MHz~1GHz

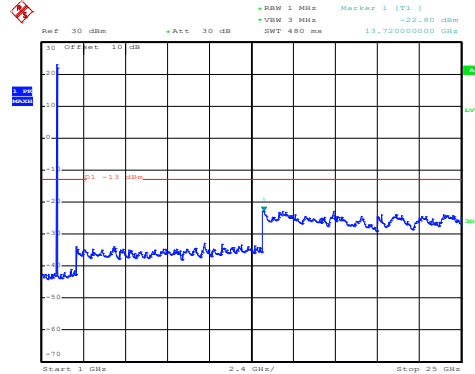

Date: 6.AUG.2020 13:58:27

1GHz~25GHz

LTE Band 2: 16 QAM & RB Size 1

BW: 20MHz Lowest channel

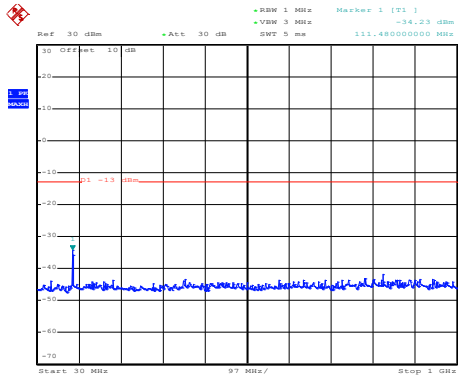

Date: 6.AUG.2020 13:55:57

30MHz~1GHz

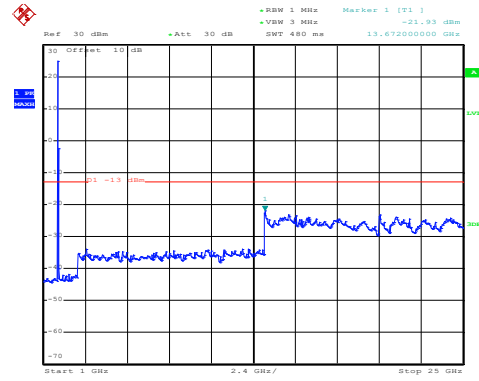

Date: 6.AUG.2020 13:57:21

1GHz~25GHz

Middle channel

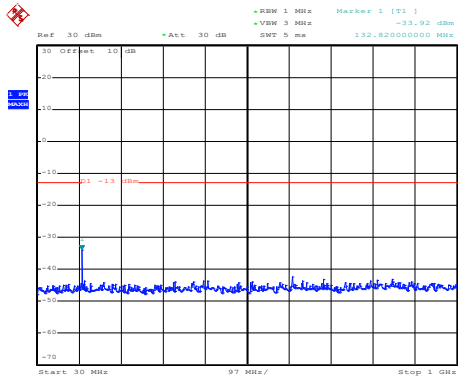

Date: 6.AUG.2020 13:56:08

30MHz~1GHz

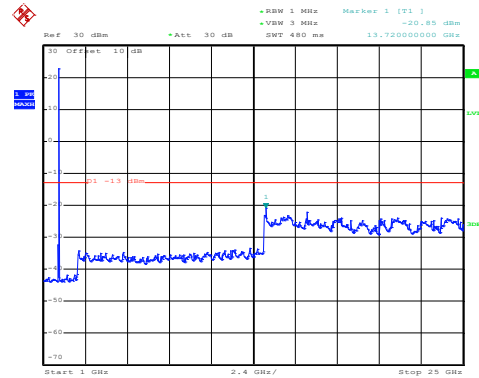

Date: 6.AUG.2020 13:57:06

1GHz~25GHz

High channel

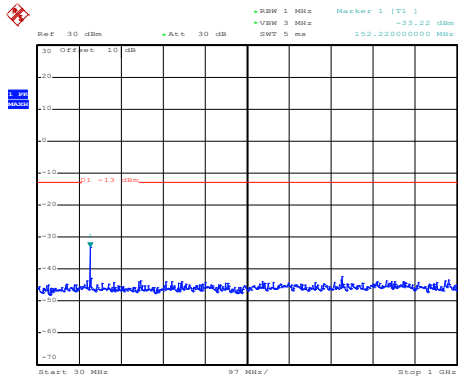

Date: 6.AUG.2020 13:56:21

30MHz~1GHz

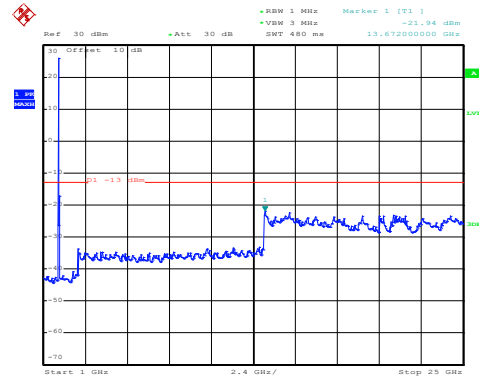

Date: 6.AUG.2020 13:56:51

1GHz~25GHz

LTE Band 2: QPSK & RB Size 1 BW: 20MHz Lowest channel

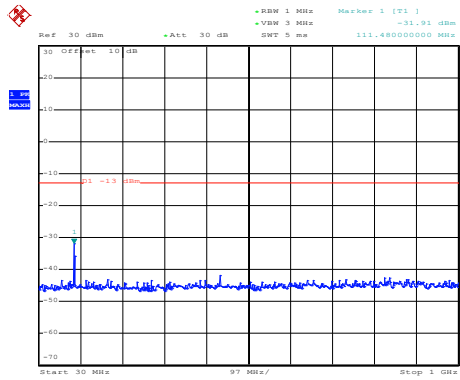

Date: 6.AUG.2020 13:55:52

30MHz~1GHz

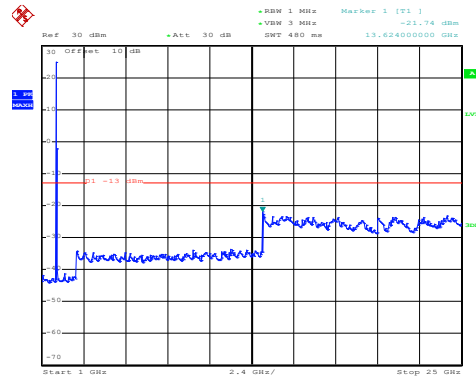

Date: 6.AUG.2020 13:57:15

1GHz~25GHz

Middle channel

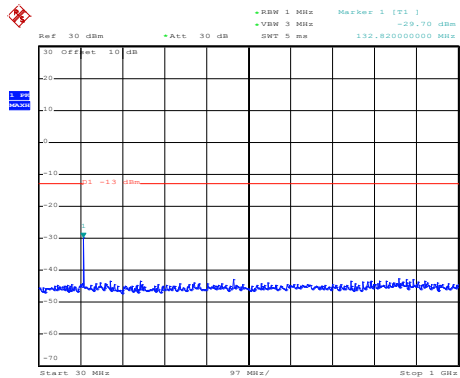

Date: 6.AUG.2020 13:56:04

30MHz~1GHz

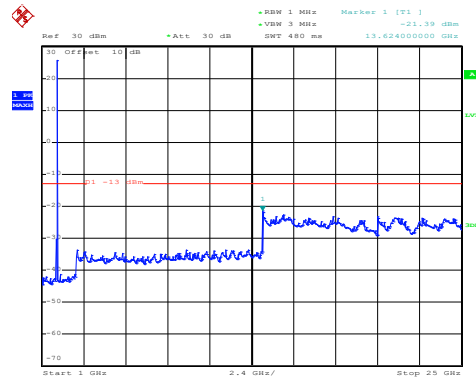

Date: 6.AUG.2020 13:57:00

1GHz~25GHz

High channel

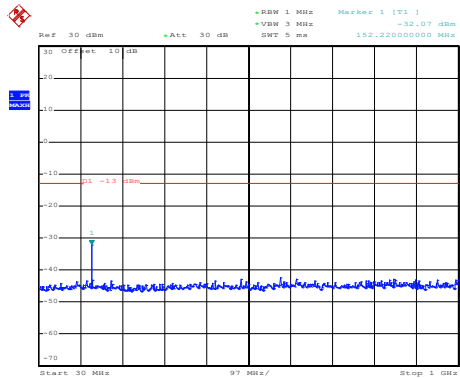

Date: 6.AUG.2020 13:56:17

30MHz~1GHz

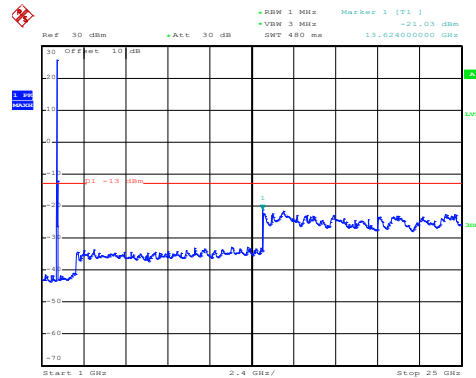

Date: 6.AUG.2020 13:56:43

1GHz~25GHz

LTE Band 4 part:

LTE Band 4: 16 QAM & RB Size 1
 BW: 1.4MHz
 Lowest channel

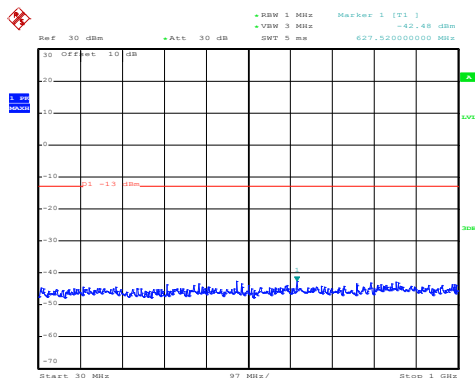

Date: 6.AUG.2020 13:59:33

30MHz~1GHz

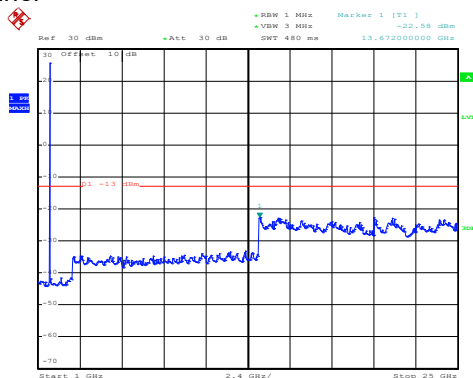

Date: 6.AUG.2020 14:00:14

1GHz~25GHz

Middle channel

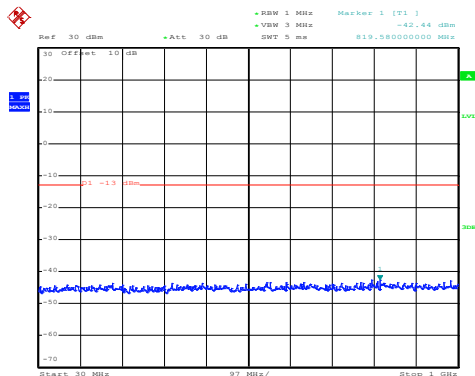

Date: 6.AUG.2020 13:59:45

30MHz~1GHz

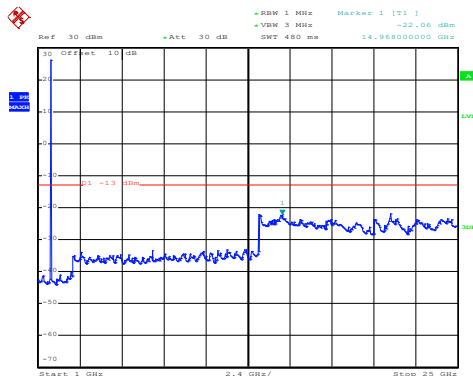

Date: 6.AUG.2020 14:00:38

1GHz~25GHz

High channel

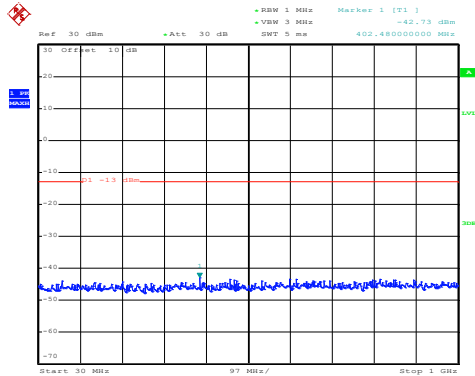

Date: 6.AUG.2020 13:59:53

30MHz~1GHz

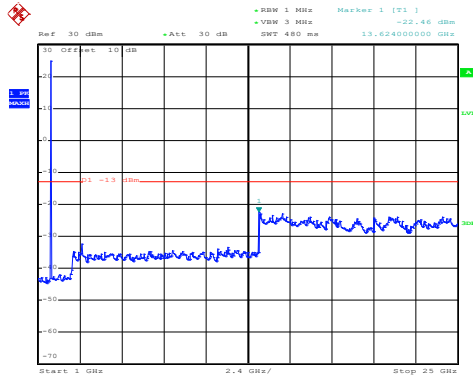

Date: 6.AUG.2020 14:00:54

1GHz~25GHz

LTE Band 4: QPSK & RB Size 1 BW: 1.4MHz Lowest channel

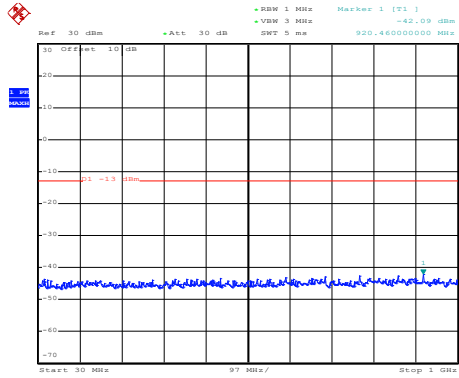

Date: 6.AUG.2020 13:59:29

30MHz~1GHz

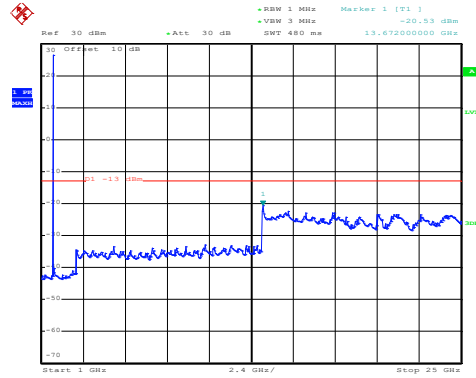

Date: 6.AUG.2020 14:00:07

1GHz~25GHz

Middle channel

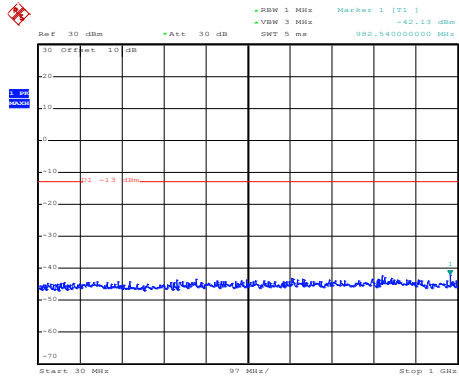

Date: 6.AUG.2020 13:59:38

30MHz~1GHz

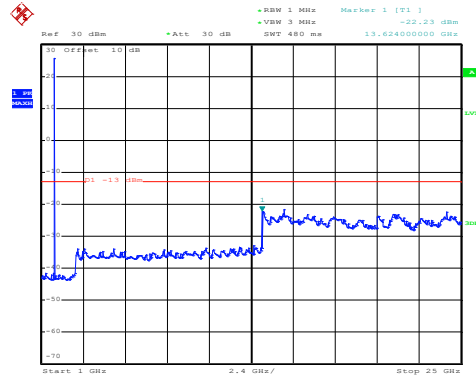

Date: 6.AUG.2020 14:00:26

1GHz~25GHz

High channel

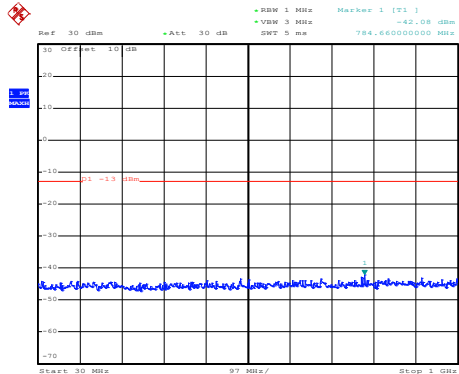

Date: 6.AUG.2020 13:59:50

30MHz~1GHz

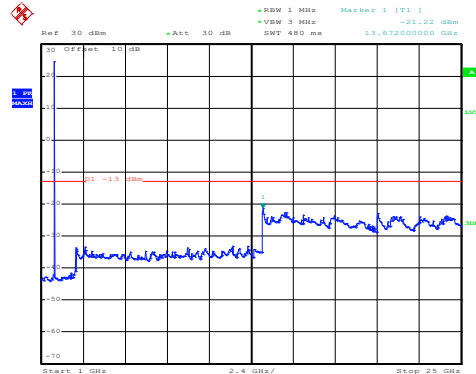

Date: 6.AUG.2020 14:00:48

1GHz~25GHz

LTE Band 4: 16 QAM & RB Size 1 BW: 20MHz Lowest channel

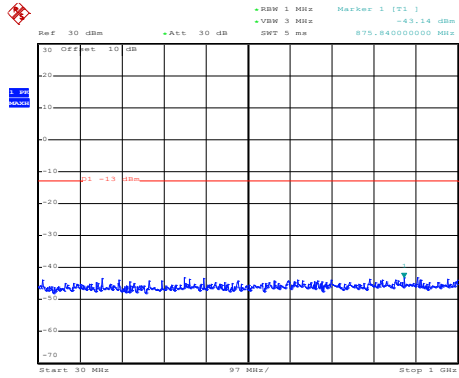

Date: 6.AUG.2020 13:55:40

30MHz~1GHz

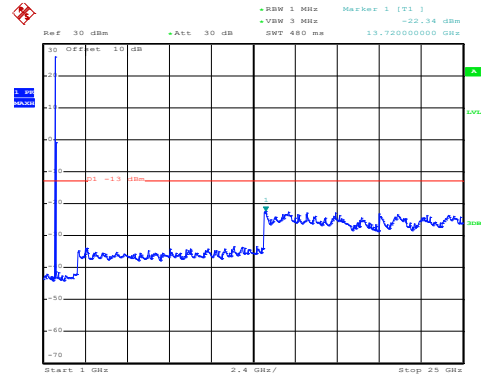

Date: 6.AUG.2020 13:54:25

1GHz~25GHz

Middle channel

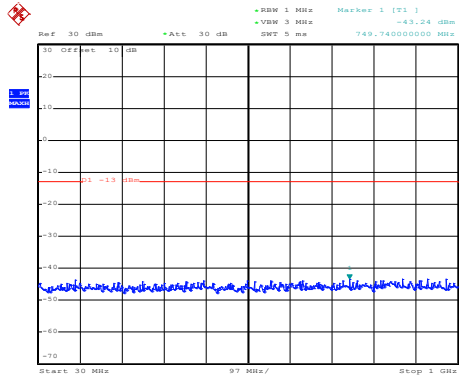

Date: 6.AUG.2020 13:55:28

30MHz~1GHz

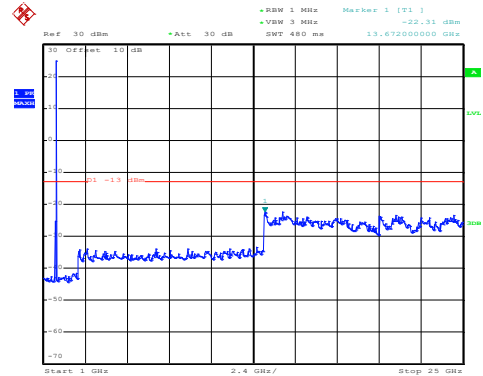

Date: 6.AUG.2020 13:54:43

1GHz~25GHz

High channel

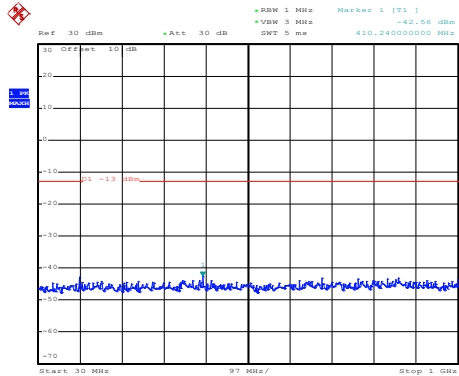

Date: 6.AUG.2020 13:55:16

30MHz~1GHz

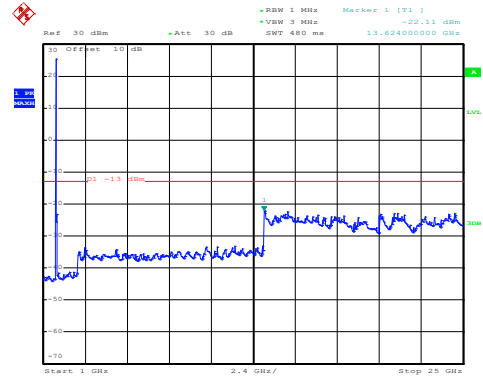

Date: 6.AUG.2020 13:54:59

1GHz~25GHz

LTE Band 4: QPSK & RB Size 1 BW: 20MHz Lowest channel

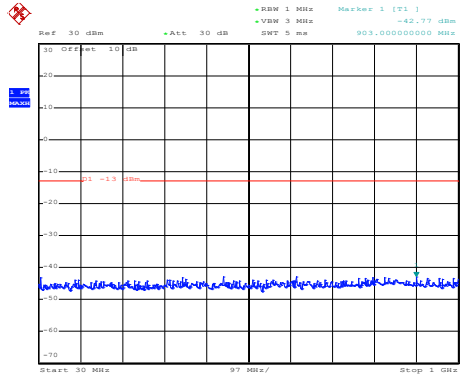

Date: 6.AUG.2020 13:55:37

30MHz~1GHz

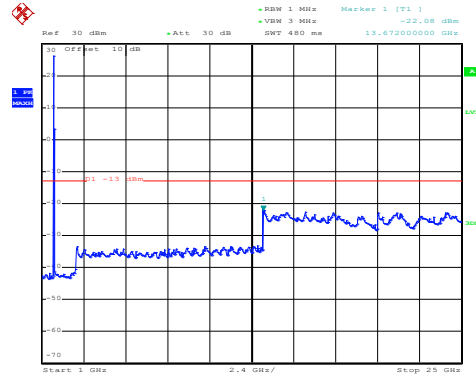

Date: 6.AUG.2020 13:54:14

1GHz~25GHz

Middle channel

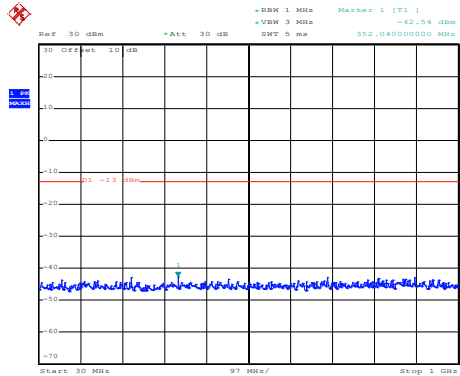

Date: 6.AUG.2020 13:55:25

30MHz~1GHz

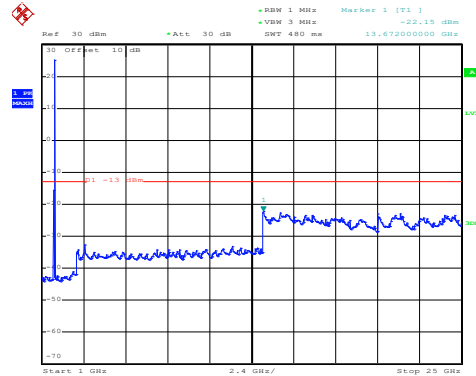

Date: 6.AUG.2020 13:54:38

1GHz~25GHz

High channel

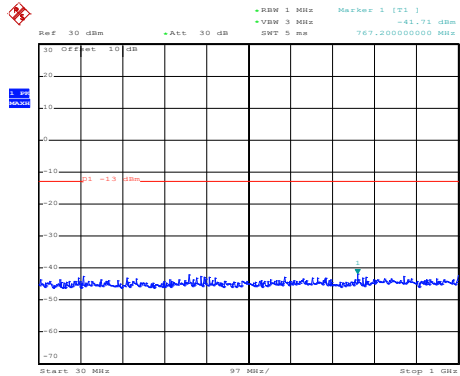

Date: 6.AUG.2020 13:55:11

30MHz~1GHz

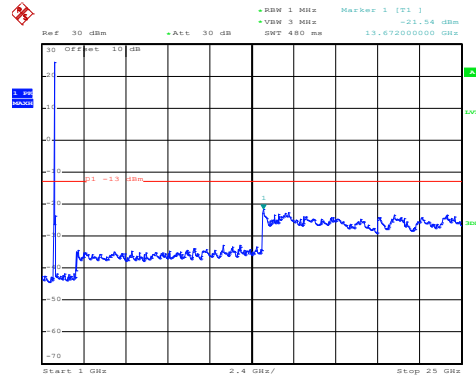

Date: 6.AUG.2020 13:54:52

1GHz~25GHz

LTE Band 7 part:

LTE Band 7: 16 QAM & RB Size 1 BW: 5MHz Lowest channel

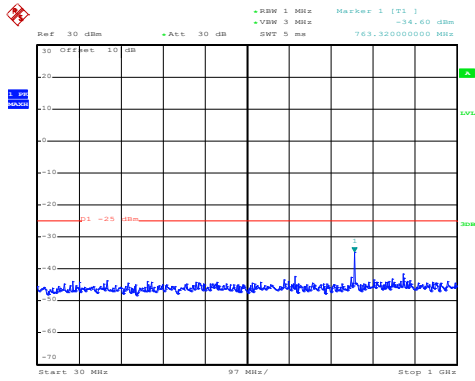

Date: 6.AUG.2020 13:50:18

30MHz~1GHz

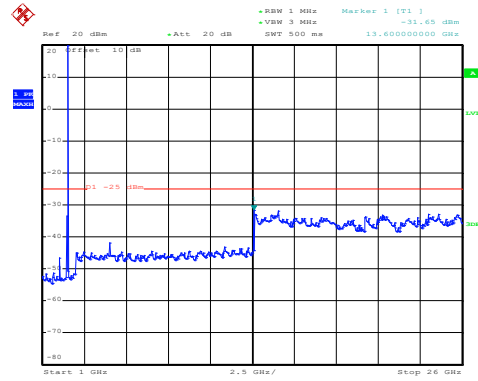

Date: 6.AUG.2020 13:50:50

1GHz~26GHz

Middle channel

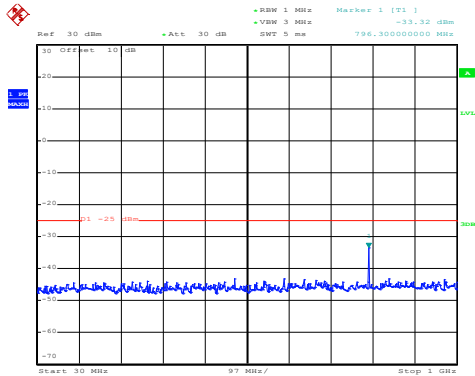

Date: 6.AUG.2020 13:50:07

30MHz~1GHz

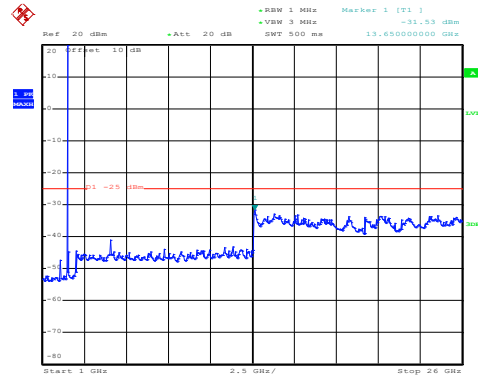

Date: 6.AUG.2020 13:51:10

1GHz~26GHz

High channel

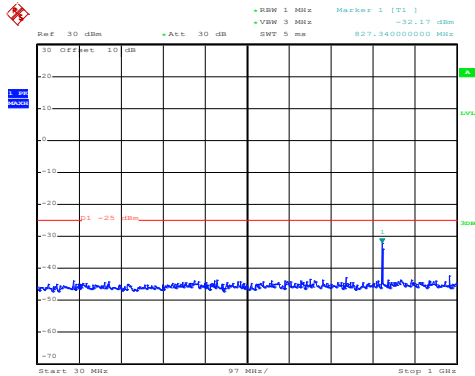

Date: 6.AUG.2020 13:49:55

30MHz~1GHz

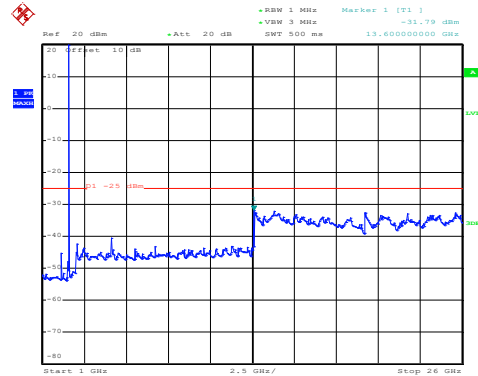

Date: 6.AUG.2020 13:51:28

1GHz~26GHz

LTE Band 7: QPSK & RB Size 1 BW: 5MHz Lowest channel

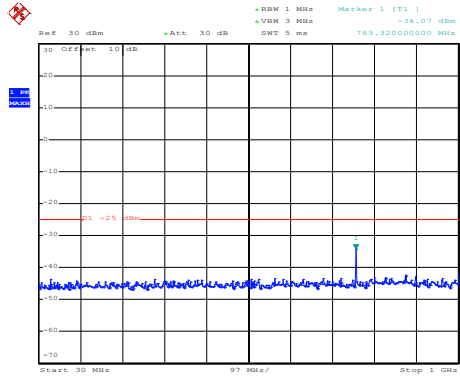

Date: 6.AUG.2020 13:50:14

30MHz~1GHz

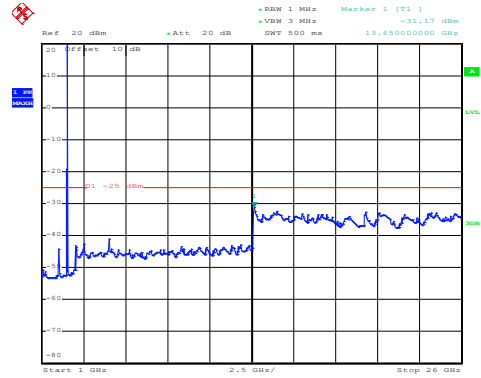

Date: 6.AUG.2020 13:50:42

1GHz~26GHz

Middle channel

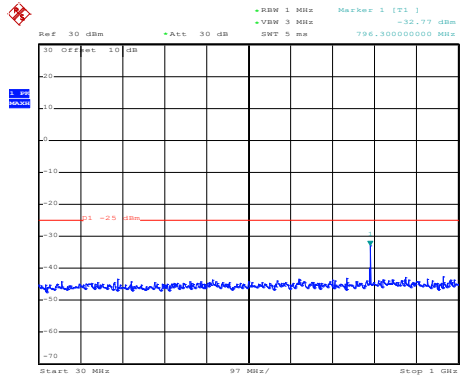

Date: 6.AUG.2020 13:50:03

30MHz~1GHz

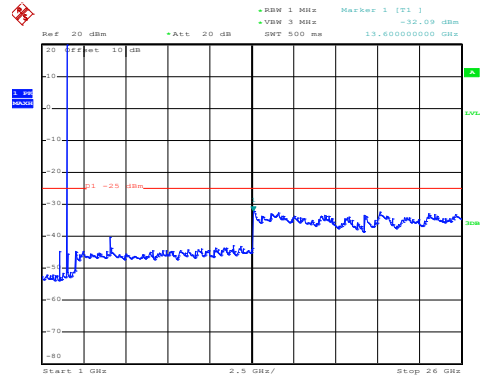

Date: 6.AUG.2020 13:51:04

1GHz~26GHz

High channel

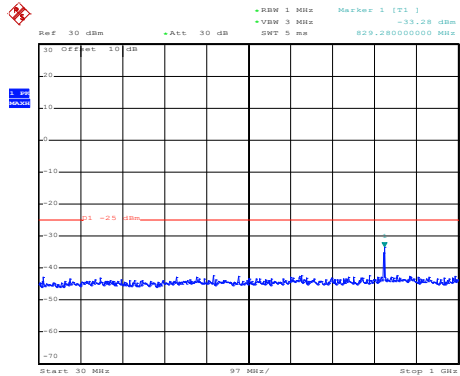

Date: 6.AUG.2020 13:49:45

30MHz~1GHz

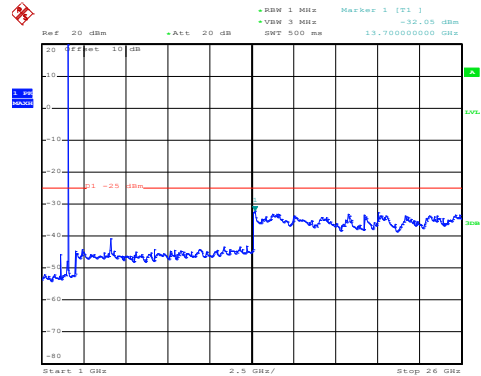

Date: 6.AUG.2020 13:51:19

1GHz~26GHz

LTE Band 7: 16 QAM & RB Size 1 BW: 20MHz Lowest channel

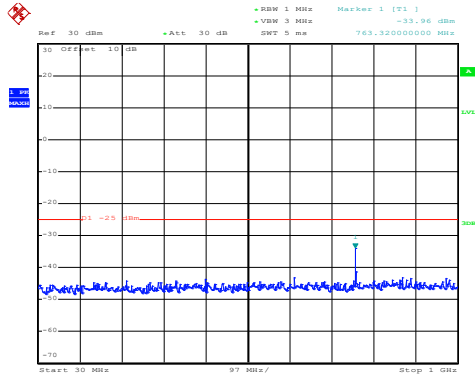

Date: 6.AUG.2020 15:34:27

30MHz~1GHz

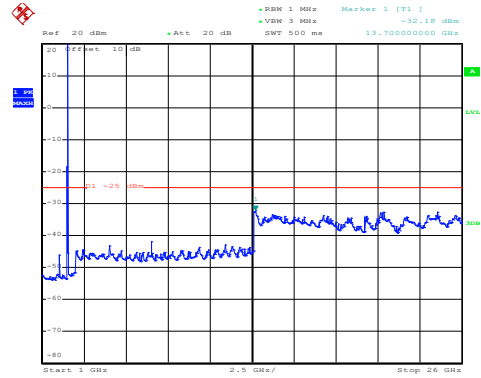

Date: 6.AUG.2020 13:52:41

1GHz~26GHz

Middle channel

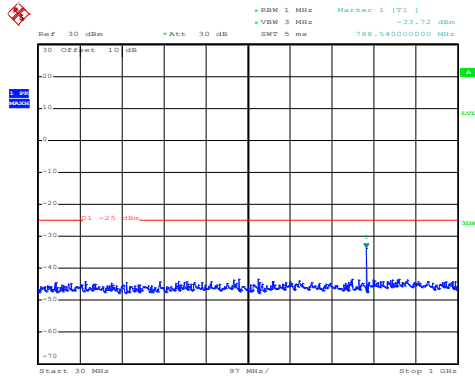

Date: 6.AUG.2020 15:34:40

30MHz~1GHz

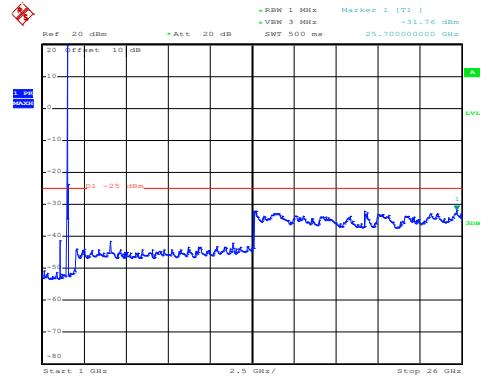

Date: 6.AUG.2020 13:53:20

1GHz~26GHz

High channel

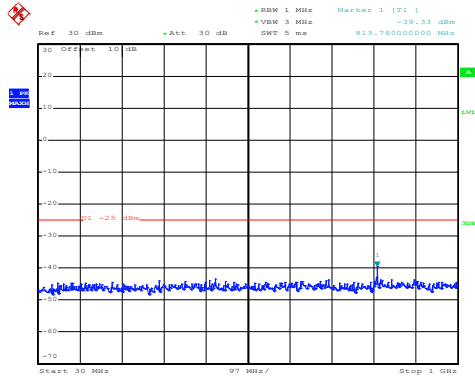

Date: 6.AUG.2020 15:34:52

30MHz~1GHz

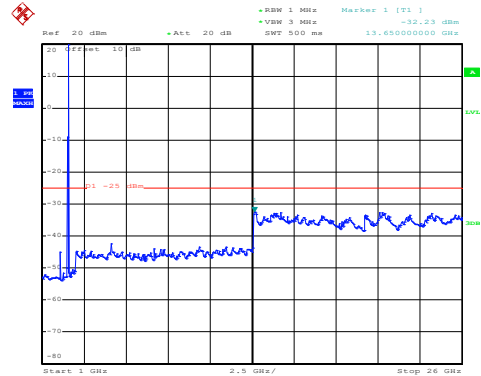

Date: 6.AUG.2020 13:53:43

1GHz~26GHz

LTE Band 7: QPSK & RB Size 1 BW: 20MHz Lowest channel

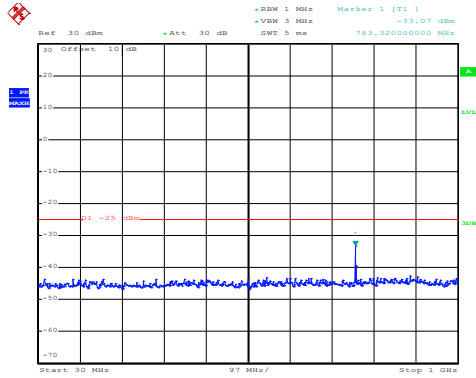

Date: 6.AUG.2020 15:34:23

30MHz~1GHz

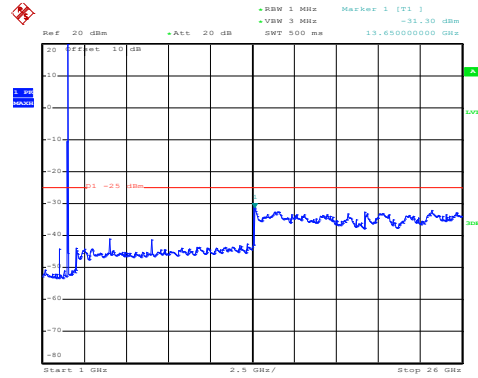

Date: 6.AUG.2020 13:52:35

1GHz~26GHz

Middle channel

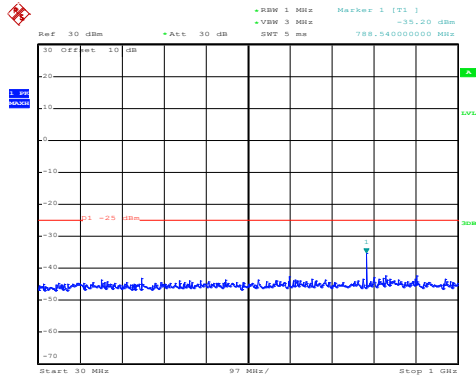

Date: 6.AUG.2020 15:34:35

30MHz~1GHz

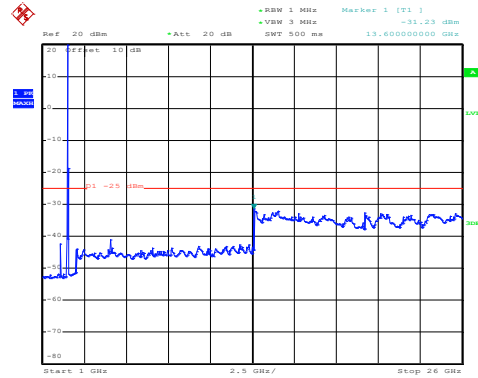

Date: 6.AUG.2020 13:53:00

1GHz~26GHz

High channel

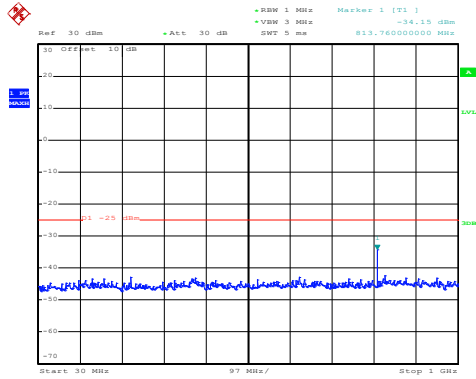

Date: 6.AUG.2020 15:34:48

30MHz~1GHz

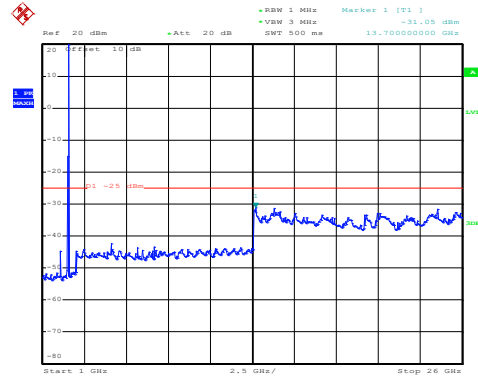

Date: 6.AUG.2020 13:53:34

1GHz~26GHz

Band edge emission:

LTE Band 2 part:

**LTE Band 2, BW: 1.4MHz
16QAM & RB Size 1**

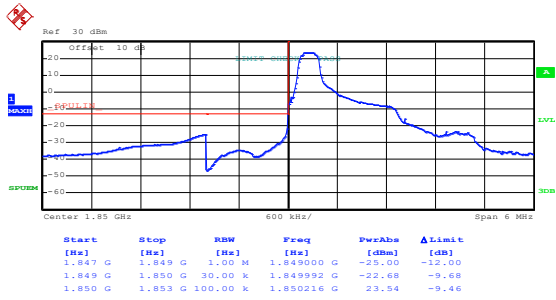

Date: 6.AUG.2020 09:23:40

Lowest channel

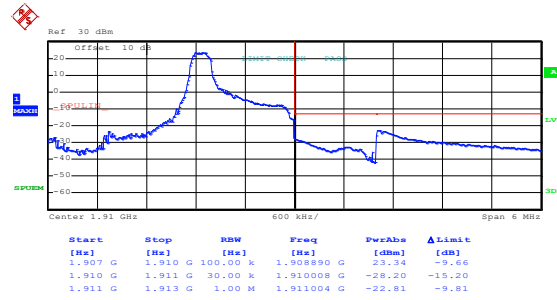

Date: 6.AUG.2020 09:25:22

Highest channel

16QAM & RB Size 6

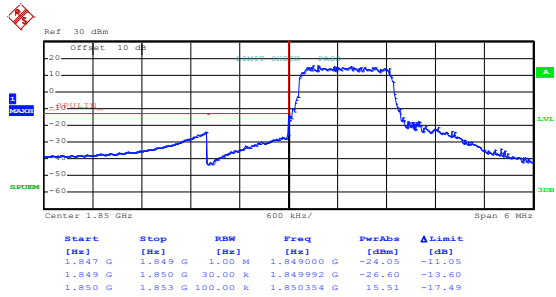

Date: 6.AUG.2020 09:24:09

Lowest channel

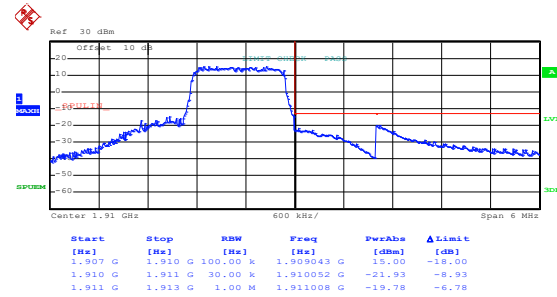

Date: 6.AUG.2020 09:24:25

Highest channel

LTE Band 2, BW: 1.4MHz QPSK & RB Size 1

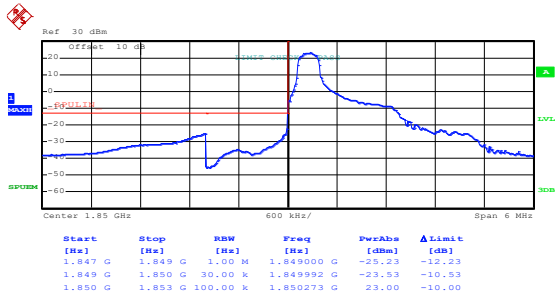

Date: 6.AUG.2020 09:22:27

Lowest channel

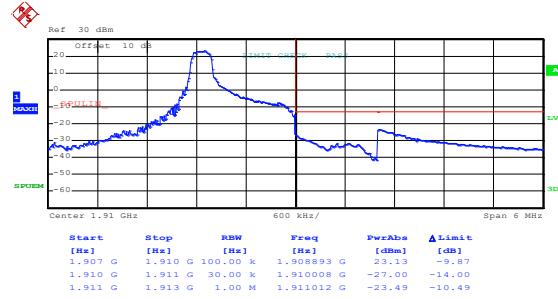

Date: 6.AUG.2020 09:24:57

Highest channel

QPSK & RB Size 6

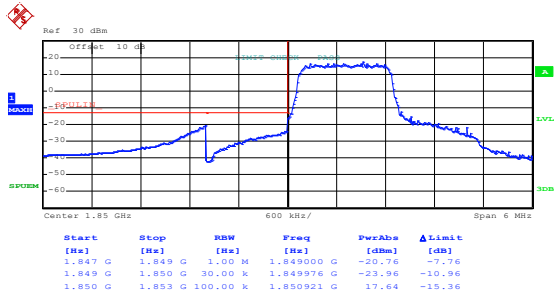

Date: 6.AUG.2020 09:24:05

Lowest channel

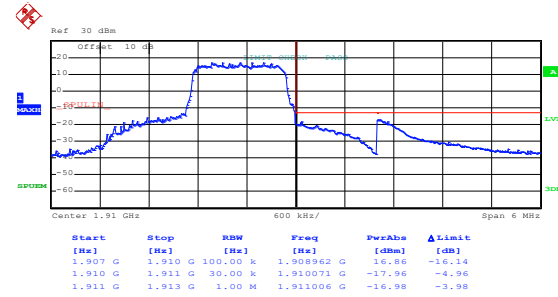

Date: 6.AUG.2020 09:24:20

Highest channel

LTE Band 2, BW: 20MHz 16QAM & RB Size 1

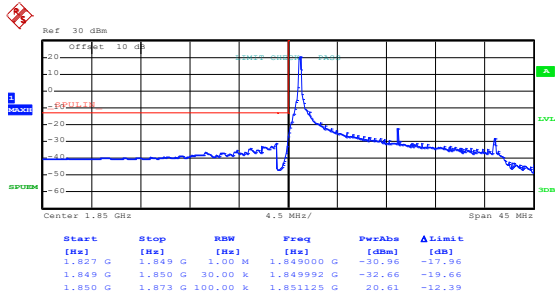

Date: 6.AUG.2020 09:26:59

Lowest channel

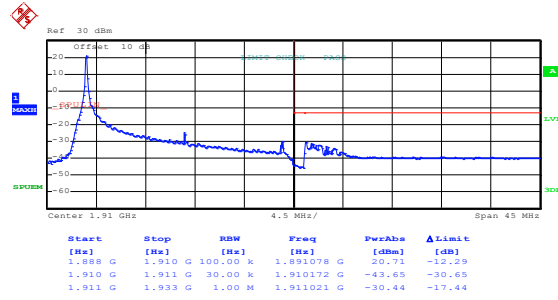

Date: 6.AUG.2020 09:26:04

Highest channel

16QAM & RB Size 100

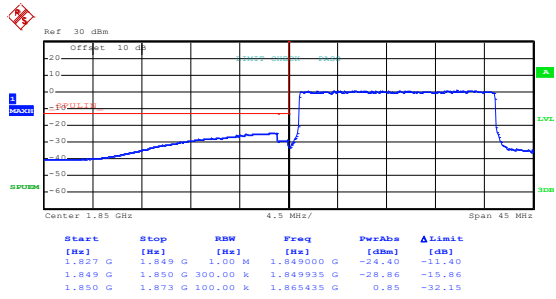

Date: 6.AUG.2020 09:27:35

Lowest channel

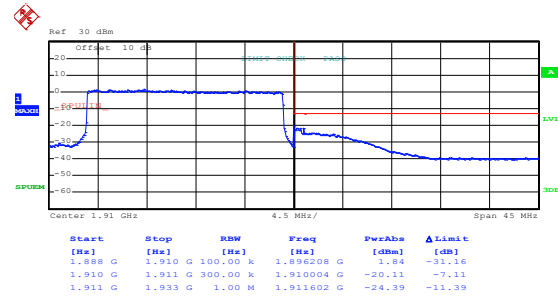

Date: 6.AUG.2020 09:26:34

Highest channel

LTE Band 2, BW: 20MHz QPSK & RB Size 1

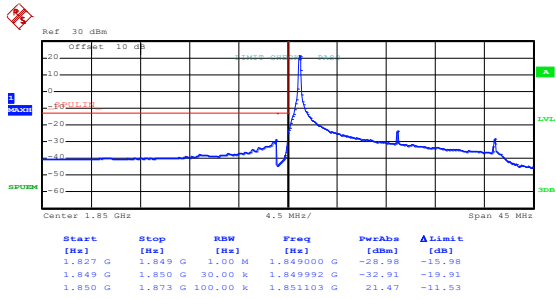

Date: 6.AUG.2020 09:26:53

Lowest channel

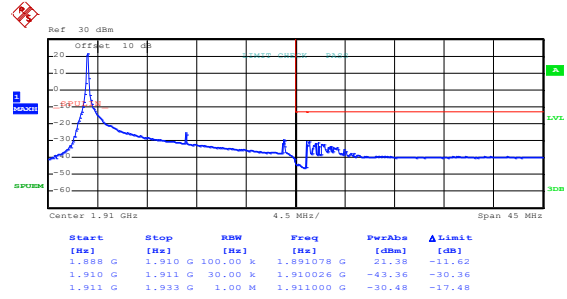

Date: 6.AUG.2020 09:25:54

Highest channel

QPSK & RB Size 100

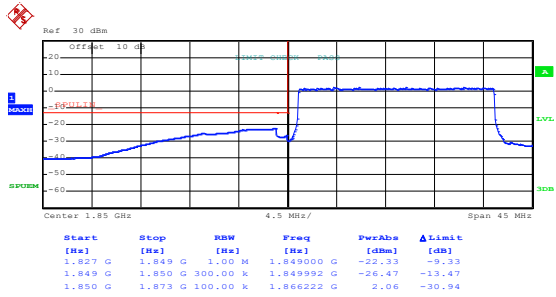

Date: 6.AUG.2020 09:27:31

Lowest channel

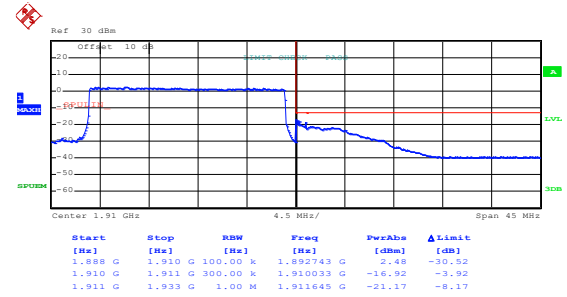

Date: 6.AUG.2020 09:26:29

Highest channel

LTE Band 4 part:

LTE Band 4, BW: 1.4MHz
16QAM & RB Size 1

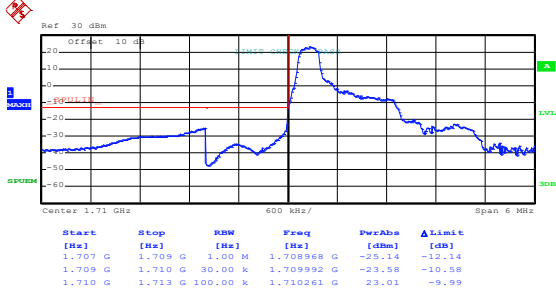

Date: 6.AUG.2020 13:40:01

Lowest channel

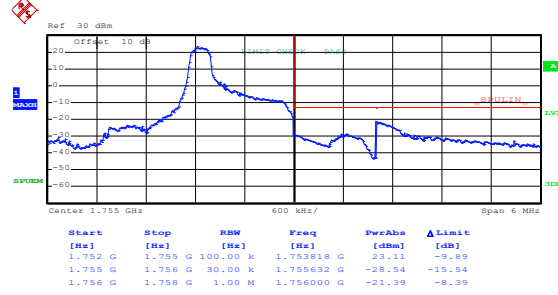

Date: 6.AUG.2020 13:41:42

Highest channel

16QAM & RB Size 6

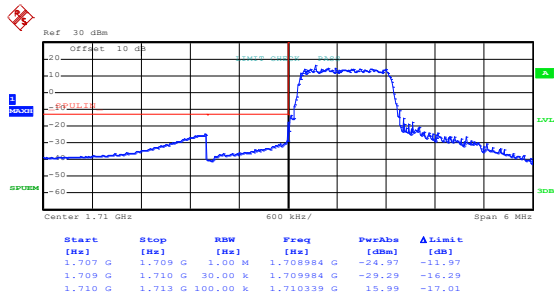

Date: 6.AUG.2020 13:40:13

Lowest channel

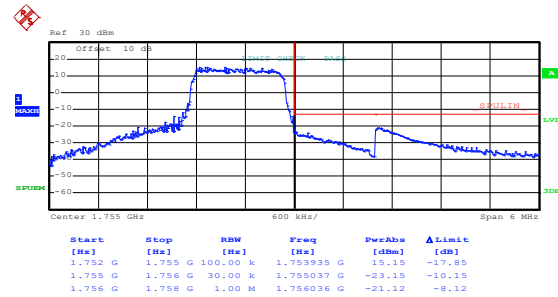

Date: 6.AUG.2020 13:40:41

Highest channel

LTE Band 4, BW: 1.4MHz QPSK & RB Size 1

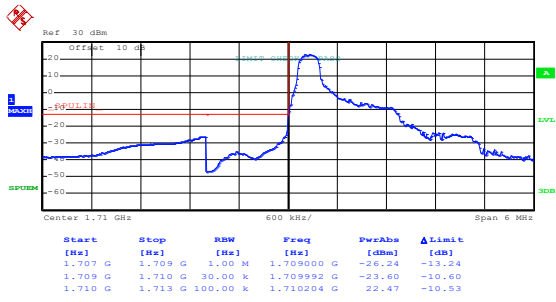

Date: 6.AUG.2020 13:39:12

Lowest channel

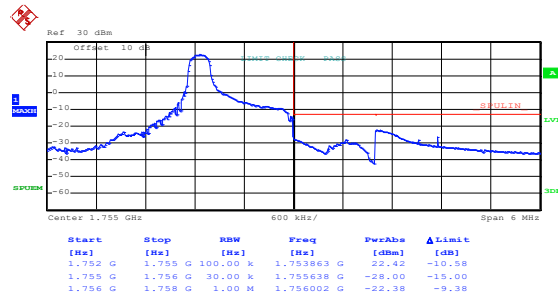

Date: 6.AUG.2020 13:41:25

Highest channel

QPSK & RB Size 6

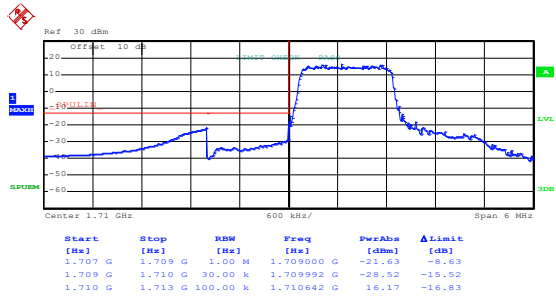

Date: 6.AUG.2020 13:40:08

Lowest channel

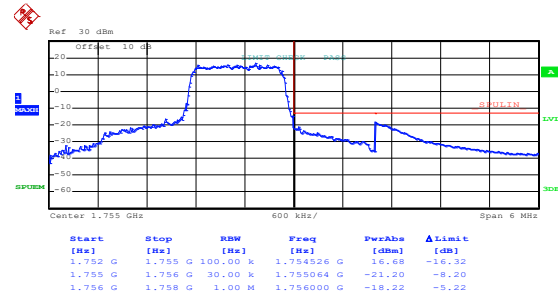

Date: 6.AUG.2020 13:40:37

Highest channel

LTE Band 4, BW: 20MHz 16QAM & RB Size 1

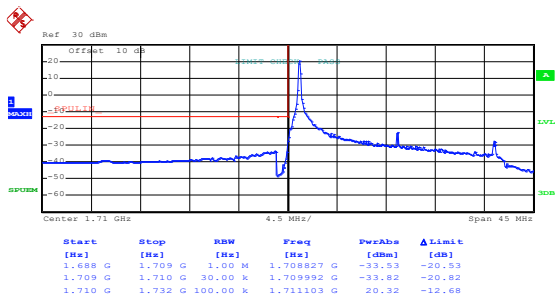

Date: 6.AUG.2020 13:43:13

Lowest channel

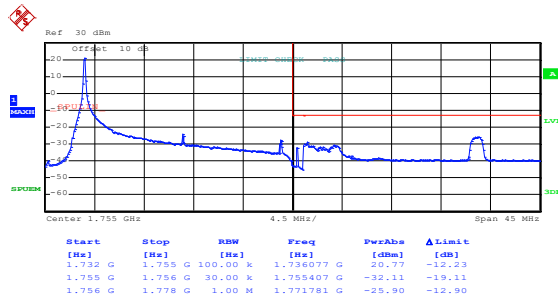

Date: 6.AUG.2020 13:42:32

Highest channel

16QAM & RB Size 100

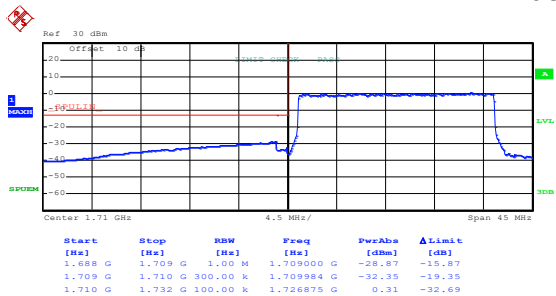

Date: 6.AUG.2020 13:43:29

Lowest channel

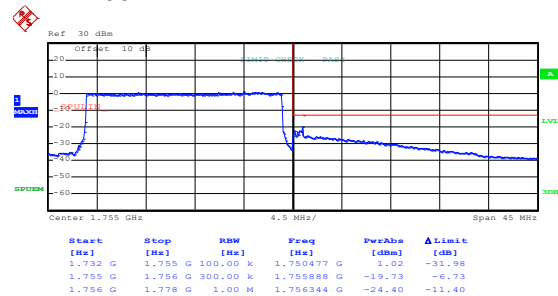

Date: 6.AUG.2020 13:42:51

Highest channel

LTE Band 4, BW: 20MHz QPSK & RB Size 1

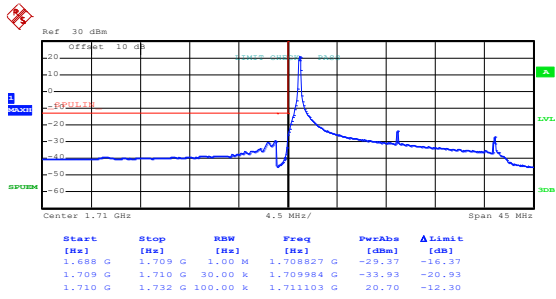

Date: 6.AUG.2020 13:43:05

Lowest channel

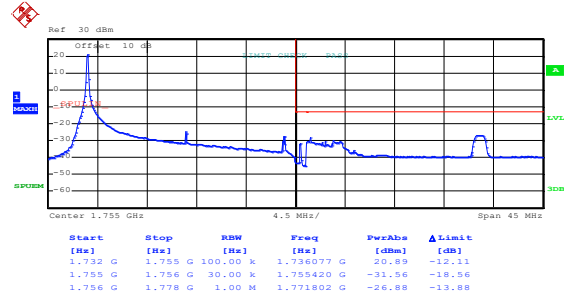

Date: 6.AUG.2020 13:42:15

Highest channel

QPSK & RB Size 100

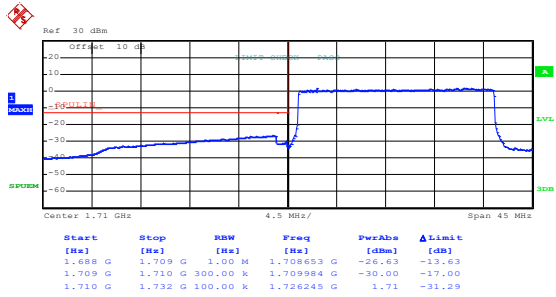

Date: 6.AUG.2020 13:43:24

Lowest channel

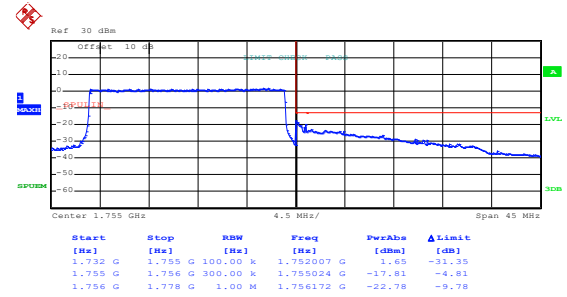

Date: 6.AUG.2020 13:42:47

Highest channel

LTE Band 7 part:

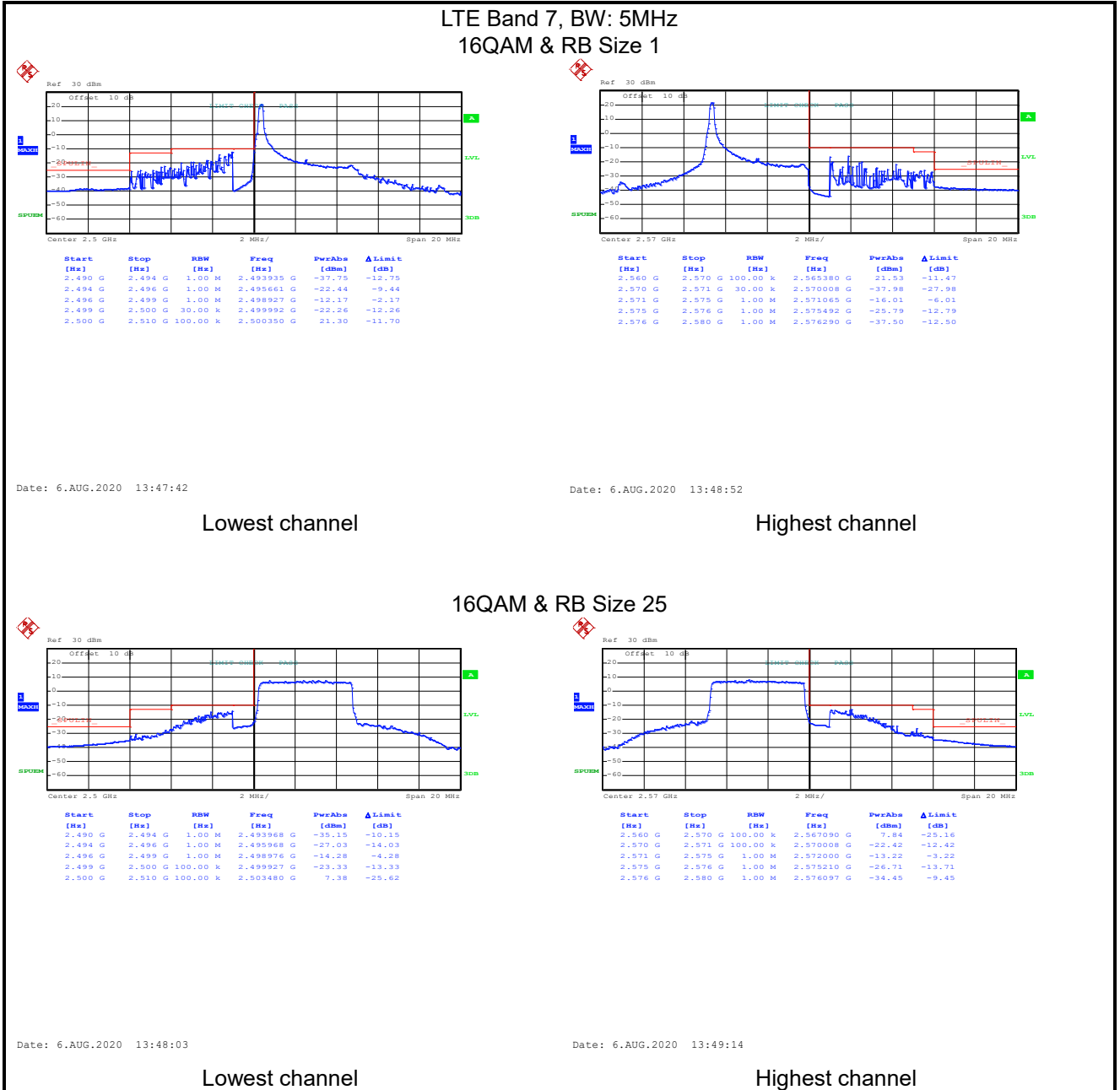

LTE Band 7, BW: 5MHz QPSK & RB Size 1

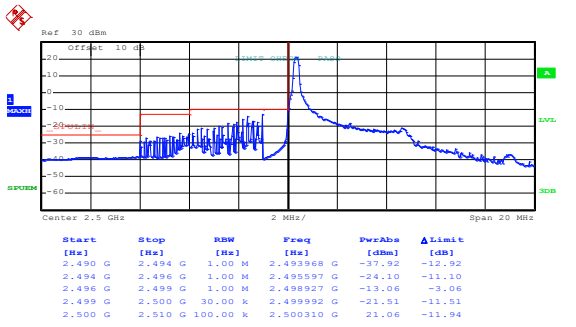

Date: 6.AUG.2020 13:47:21

Lowest channel

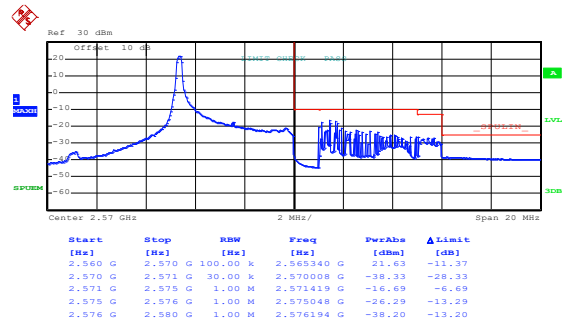

Date: 6.AUG.2020 13:48:40

Highest channel

QPSK & RB Size 25

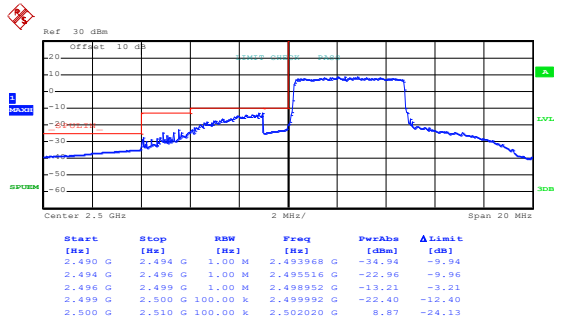

Date: 6.AUG.2020 13:47:56

Lowest channel

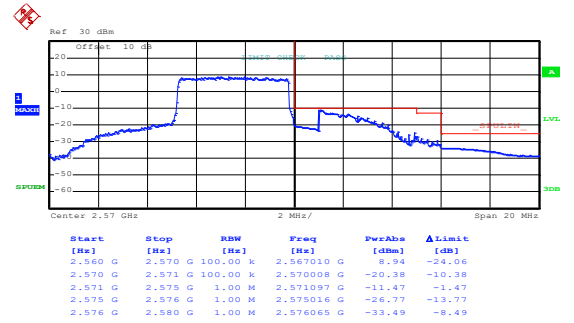

Date: 6.AUG.2020 13:49:06

Highest channel

LTE Band 7, BW: 20MHz 16QAM & RB Size 1

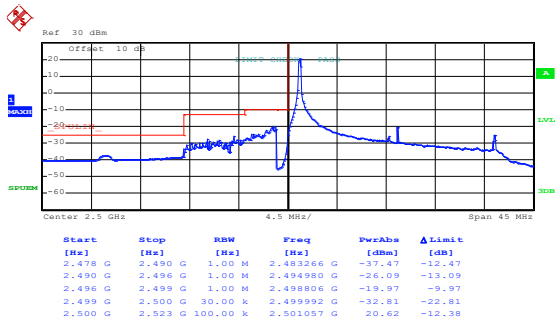

Date: 6.AUG.2020 13:44:54

Lowest channel

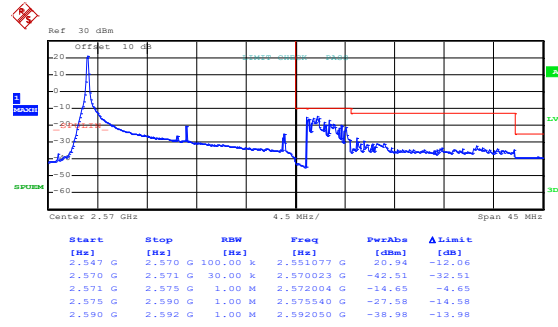

Date: 6.AUG.2020 13:46:02

Highest channel

16QAM & RB Size 100

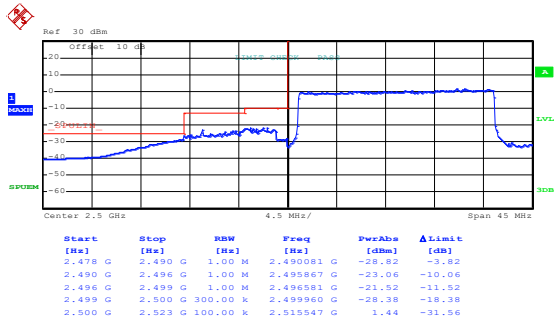

Date: 6.AUG.2020 13:45:14

Lowest channel

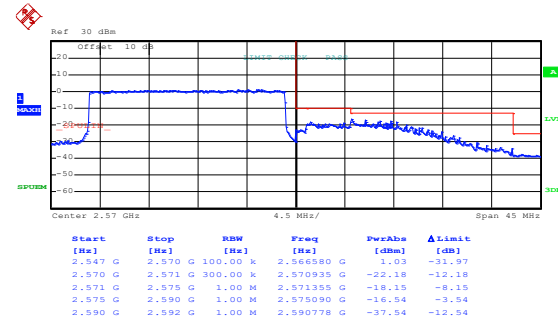

Date: 6.AUG.2020 13:46:25

Highest channel

LTE Band 7, BW: 20MHz QPSK & RB Size 1

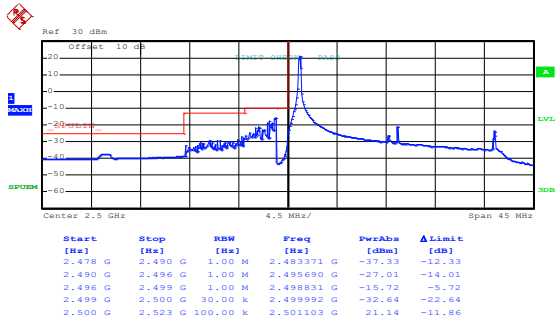

Date: 6.AUG.2020 13:44:20

Lowest channel

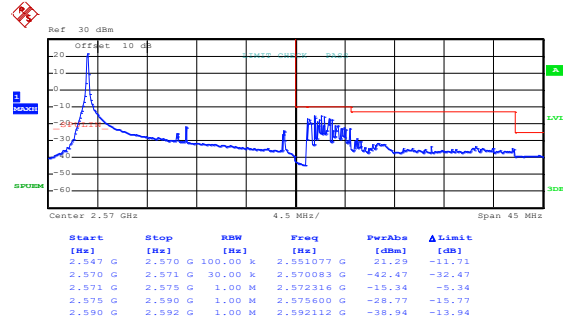

Date: 6.AUG.2020 13:45:33

Highest channel

QPSK & RB Size 100

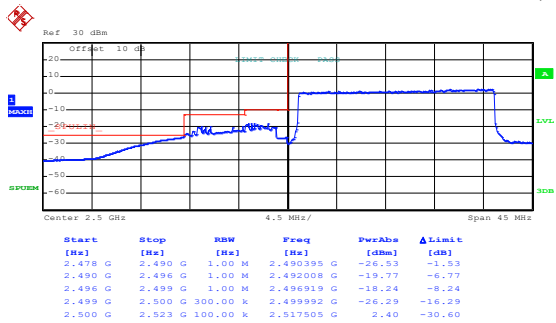

Date: 6.AUG.2020 13:45:08

Lowest channel

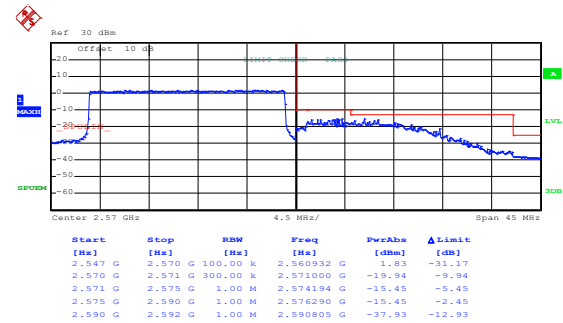

Date: 6.AUG.2020 13:46:18

Highest channel

6.5 Field strength of spurious radiation measurement

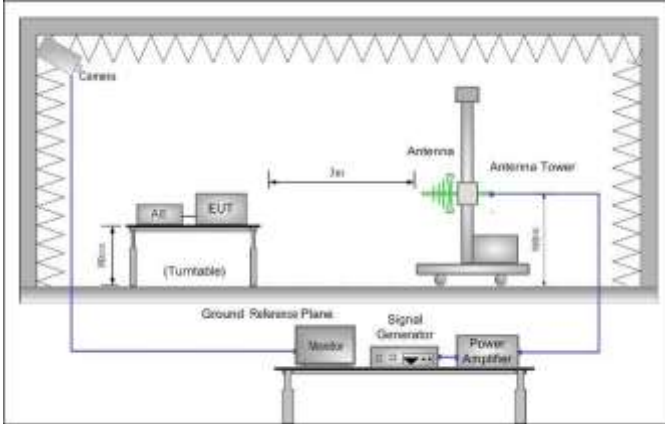
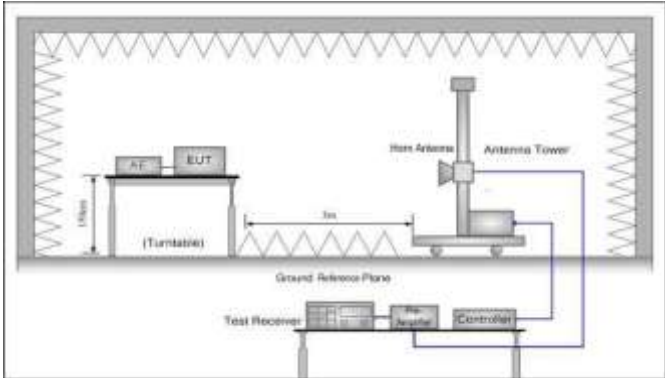
<p>Test Requirement:</p>	<p>Part 24.238 (a), Part 27.53(m), Part 27.53(h)</p>
<p>Limit:</p>	<p>LTE Band 2 & 4: The power of any emission outside a licensee's frequency block shall be attenuated below the transmitter power (P) in watts by at least $43 + 10 \log_{10}(P)$ dB (-13 dBm). LTE Band 7: For mobile digital stations, the attenuation factor shall be not less than $40 + 10 \log (P)$ dB on all frequencies between the channel edge and 5 megahertz from the channel edge, $43 + 10 \log (P)$ dB on all frequencies between 5 megahertz and X megahertz from the channel edge, and $55 + 10 \log (P)$ dB on all frequencies more than X megahertz from the channel edge, where X is the greater of 6 megahertz or the actual emission bandwidth as defined in paragraph (m)(6) of this section. In addition, the attenuation factor shall not be less that $43 + 10 \log (P)$ dB on all frequencies between 2490.5 MHz and 2496 MHz and $55 + 10 \log (P)$ dB at or below 2490.5 MHz.</p>
<p>Test setup:</p>	<p>Below 1GHz</p>  <p>Above 1GHz</p> 
<p>Test Procedure:</p>	<ol style="list-style-type: none"> 1. The EUT was placed on the top of a rotating table 0.8m(below 1GHz)/1.5m(above 1GHz) above the ground at a 3 meter camber. The radiated emission at the fundamental frequency was measured at 3 m with a test antenna and EMI spectrum analyzer. 2. During the tests, the antenna height and the EUT azimuth were varied in order to identify the maximum level of emissions from the EUT. This maximization process was repeated with the EUT positioned in each of its three orthogonal orientations. 3. The frequency range up to tenth harmonic was investigated for each of three fundamental frequency (low, middle and high channels). Once spurious emission was identified, the power of the emission

	<p>was determined using the substitution method.</p> <p>4. The spurious emissions attenuation was calculated as the difference between radiated power at the fundamental frequency and the spurious emissions frequency.</p> $\text{ERP / EIRP} = \text{S.G. output (dBm)} + \text{Antenna Gain(dB/dBi)} - \text{Cable Loss (dB)}$
Test Instruments:	Refer to section 5.10 for details
Test mode:	Refer to section 5.3 for details.
Test results:	Passed

Measurement Data:

LTE Band 2 part:

Band 2 (1.4MHz)							
Lowest channel							
Frequency (MHz)	Level at antenna terminals (dBm)	Substitute antenna gain (dBi)	Cable Loss (dBi)	Spurious Emission level (dBm)	Limit Line (dBm)	Over Limit (dBm)	Polarization
3701.40	-57.09	12.64	0.75	-45.20	-13.00	-32.20	Vertical
5552.10	-54.41	12.76	1.13	-42.78	-13.00	-29.78	Vertical
7402.00	-48.47	11.44	1.63	-38.66	-13.00	-25.66	Vertical
3701.40	-62.24	12.64	0.75	-50.35	-13.00	-37.35	Horizontal
5552.10	-55.05	12.76	1.13	-43.42	-13.00	-30.42	Horizontal
7402.00	-49.46	11.44	1.63	-39.65	-13.00	-26.65	Horizontal
Middle channel							
Frequency (MHz)	Level at antenna terminals (dBm)	Substitute antenna gain (dBi)	Cable Loss (dBi)	Spurious Emission level (dBm)	Limit Line (dBm)	Over Limit (dBm)	Polarization
3760.00	-56.07	12.71	0.79	-44.15	-13.00	-31.15	Vertical
5640.00	-53.37	12.87	1.15	-41.65	-13.00	-28.65	Vertical
7520.00	-49.77	11.48	1.66	-39.95	-13.00	-26.95	Vertical
3760.00	-61.77	12.71	0.79	-49.85	-13.00	-36.85	Horizontal
5640.00	-54.27	12.87	1.15	-42.55	-13.00	-29.55	Horizontal
7520.00	-49.23	11.48	1.66	-39.41	-13.00	-26.41	Horizontal
Highest channel							
Frequency (MHz)	Level at antenna terminals (dBm)	Substitute antenna gain (dBi)	Cable Loss (dBi)	Spurious Emission level (dBm)	Limit Line (dBm)	Over Limit (dBm)	Polarization
3816.60	-55.49	12.78	0.81	-43.52	-13.00	-30.52	Vertical
5724.90	-53.95	12.97	1.19	-42.17	-13.00	-29.17	Vertical
7633.20	-48.28	11.34	1.71	-38.65	-13.00	-25.65	Vertical
3816.60	-60.82	12.78	0.81	-48.85	-13.00	-35.85	Horizontal
5724.90	-52.92	12.97	1.19	-41.14	-13.00	-28.14	Horizontal
7633.20	-48.38	11.34	1.71	-38.75	-13.00	-25.75	Horizontal
<i>Remark:</i>							
<i>The emission levels of below 1 GHz are lower than the limit 20dB and not show in test report.</i>							

Band 2 (20MHz)							
Lowest channel							
Frequency (MHz)	Level at antenna terminals (dBm)	Substitute antenna gain (dBi)	Cable Loss (dBi)	Spurious Emission level (dBm)	Limit Line (dBm)	Over Limit (dBm)	Polarization
3720.00	-56.51	12.66	0.77	-44.62	-13.00	-31.62	Vertical
5580.00	-53.27	12.80	1.15	-41.62	-13.00	-28.62	Vertical
7440.00	-48.47	11.46	1.64	-38.65	-13.00	-25.65	Vertical
3720.00	-61.84	12.66	0.77	-49.95	-13.00	-36.95	Horizontal
5580.00	-53.79	12.80	1.15	-42.14	-13.00	-29.14	Horizontal
7440.00	-47.77	11.46	1.64	-37.95	-13.00	-24.95	Horizontal
Middle channel							
Frequency (MHz)	Level at antenna terminals (dBm)	Substitute antenna gain (dBi)	Cable Loss (dBi)	Spurious Emission level (dBm)	Limit Line (dBm)	Over Limit (dBm)	Polarization
3760.00	-55.54	12.71	0.79	-43.62	-13.00	-30.62	Vertical
5640.00	-54.23	12.87	1.15	-42.51	-13.00	-29.51	Vertical
7520.00	-48.77	11.48	1.66	-38.95	-13.00	-25.95	Vertical
3760.00	-59.77	12.71	0.79	-47.85	-13.00	-34.85	Horizontal
5640.00	-53.28	12.87	1.15	-41.56	-13.00	-28.56	Horizontal
7520.00	-49.68	11.48	1.66	-39.86	-13.00	-26.86	Horizontal
Highest channel							
Frequency (MHz)	Level at antenna terminals (dBm)	Substitute antenna gain (dBi)	Cable Loss (dBi)	Spurious Emission level (dBm)	Limit Line (dBm)	Over Limit (dBm)	Polarization
3800.00	-54.48	12.76	0.79	-42.51	-13.00	-29.51	Vertical
5700.00	-53.51	12.94	1.18	-41.75	-13.00	-28.75	Vertical
7600.00	-48.64	11.38	1.69	-38.95	-13.00	-25.95	Vertical
3800.00	-59.47	12.76	0.79	-47.50	-13.00	-34.50	Horizontal
5700.00	-54.31	12.94	1.18	-42.55	-13.00	-29.55	Horizontal
7600.00	-46.87	11.38	1.69	-37.18	-13.00	-24.18	Horizontal
<p><i>Remark:</i> The emission levels of below 1 GHz are lower than the limit 20dB and not show in test report.</p>							

LTE Band 4 part:

Band 4 (1.4MHz)							
Lowest channel							
Frequency (MHz)	Level at antenna terminals (dBm)	Substitute antenna gain (dBi)	Cable Loss (dBi)	Spurious Emission level (dBm)	Limit Line (dBm)	Over Limit (dBm)	Polarization
3421.40	-60.05	12.24	0.70	-48.51	-13.00	-35.51	Vertical
5132.10	-56.38	12.92	1.01	-44.47	-13.00	-31.47	Vertical
6842.80	-49.84	11.42	1.53	-39.95	-13.00	-26.95	Vertical
3421.40	-58.12	12.24	0.70	-46.58	-13.00	-33.58	Horizontal
5132.10	-58.29	12.92	1.01	-46.38	-13.00	-33.38	Horizontal
6842.80	-50.07	11.42	1.53	-40.18	-13.00	-27.18	Horizontal
Middle channel							
Frequency (MHz)	Level at antenna terminals (dBm)	Substitute antenna gain (dBi)	Cable Loss (dBi)	Spurious Emission level (dBm)	Limit Line (dBm)	Over Limit (dBm)	Polarization
3465.00	-59.23	12.33	0.72	-47.62	-13.00	-34.62	Vertical
5197.50	-57.01	12.88	1.04	-45.17	-13.00	-32.17	Vertical
6930.00	-48.73	11.30	1.56	-38.99	-13.00	-25.99	Vertical
3465.00	-56.13	12.33	0.72	-44.52	-13.00	-31.52	Horizontal
5197.50	-57.79	12.88	1.04	-45.95	-13.00	-32.95	Horizontal
6930.00	-49.45	11.30	1.56	-39.71	-13.00	-26.71	Horizontal
Highest channel							
Frequency (MHz)	Level at antenna terminals (dBm)	Substitute antenna gain (dBi)	Cable Loss (dBi)	Spurious Emission level (dBm)	Limit Line (dBm)	Over Limit (dBm)	Polarization
3508.60	-58.36	12.41	0.74	-46.69	-13.00	-33.69	Vertical
5262.90	-57.58	12.84	1.07	-45.81	-13.00	-32.81	Vertical
7017.20	-47.48	11.21	1.58	-37.85	-13.00	-24.85	Vertical
3508.60	-56.78	12.41	0.74	-45.11	-13.00	-32.11	Horizontal
5262.90	-56.56	12.84	1.07	-44.79	-13.00	-31.79	Horizontal
7017.20	-48.17	11.21	1.58	-38.54	-13.00	-25.54	Horizontal
<i>Remark:</i>							
<i>The emission levels of below 1 GHz are lower than the limit 20dB and not show in test report.</i>							

Band 4 (20MHz)							
Lowest channel							
Frequency (MHz)	Level at antenna terminals (dBm)	Substitute antenna gain (dBi)	Cable Loss (dBi)	Spurious Emission level (dBm)	Limit Line (dBm)	Over Limit (dBm)	Polarization
3440.00	-59.52	12.28	0.71	-47.95	-13.00	-34.95	Vertical
5160.00	-57.42	12.90	1.03	-45.55	-13.00	-32.55	Vertical
6880.00	-50.02	11.37	1.54	-40.19	-13.00	-27.19	Vertical
3440.00	-59.19	12.28	0.71	-47.62	-13.00	-34.62	Horizontal
5160.00	-57.86	12.90	1.03	-45.99	-13.00	-32.99	Horizontal
6880.00	-49.80	11.37	1.54	-39.97	-13.00	-26.97	Horizontal
Middle channel							
Frequency (MHz)	Level at antenna terminals (dBm)	Substitute antenna gain (dBi)	Cable Loss (dBi)	Spurious Emission level (dBm)	Limit Line (dBm)	Over Limit (dBm)	Polarization
3465.00	-57.76	12.33	0.72	-46.15	-13.00	-33.15	Vertical
5197.50	-56.69	12.88	1.04	-44.85	-13.00	-31.85	Vertical
6930.00	-47.69	11.30	1.56	-37.95	-13.00	-24.95	Vertical
3465.00	-56.78	12.33	0.72	-45.17	-13.00	-32.17	Horizontal
5197.50	-58.79	12.88	1.04	-46.95	-13.00	-33.95	Horizontal
6930.00	-49.91	11.30	1.56	-40.17	-13.00	-27.17	Horizontal
Highest channel							
Frequency (MHz)	Level at antenna terminals (dBm)	Substitute antenna gain (dBi)	Cable Loss (dBi)	Spurious Emission level (dBm)	Limit Line (dBm)	Over Limit (dBm)	Polarization
3490.00	-57.64	12.38	0.73	-45.99	-13.00	-32.99	Vertical
5235.00	-58.40	12.86	1.06	-46.60	-13.00	-33.60	Vertical
6980.00	-45.93	11.23	1.57	-36.27	-13.00	-23.27	Vertical
3490.00	-55.82	12.38	0.73	-44.17	-13.00	-31.17	Horizontal
5235.00	-57.78	12.86	1.06	-45.98	-13.00	-32.98	Horizontal
6980.00	-47.62	11.23	1.57	-37.96	-13.00	-24.96	Horizontal
<p><i>Remark:</i> The emission levels of below 1 GHz are lower than the limit 20dB and not show in test report.</p>							

LTE Band 7 part:

Band 7 (5MHz)							
Lowest channel							
Frequency (MHz)	Level at antenna terminals (dBm)	Substitute antenna gain (dBi)	Cable Loss (dBi)	Spurious Emission level (dBm)	Limit Line (dBm)	Over Limit (dBm)	Polarization
5005.00	-58.34	13.00	0.94	-46.28	-25.00	-21.28	Vertical
7507.50	-50.11	11.49	1.65	-40.27	-25.00	-15.27	Vertical
10010.00	-45.29	11.69	1.91	-35.51	-25.00	-10.51	Vertical
5005.00	-58.30	13.00	0.94	-46.24	-25.00	-21.24	Horizontal
7507.50	-49.74	11.49	1.65	-39.90	-25.00	-14.90	Horizontal
10010.00	-46.43	11.69	1.91	-36.65	-25.00	-11.65	Horizontal
Middle channel							
Frequency (MHz)	Level at antenna terminals (dBm)	Substitute antenna gain (dBi)	Cable Loss (dBi)	Spurious Emission level (dBm)	Limit Line (dBm)	Over Limit (dBm)	Polarization
5070.00	-59.60	12.96	0.98	-47.62	-25.00	-22.62	Vertical
7605.00	-49.33	11.37	1.69	-39.65	-25.00	-14.65	Vertical
10140.00	-45.93	11.62	1.94	-36.25	-25.00	-11.25	Vertical
5070.00	-59.48	12.96	0.98	-47.50	-25.00	-22.50	Horizontal
7605.00	-49.83	11.37	1.69	-40.15	-25.00	-15.15	Horizontal
10140.00	-45.63	11.62	1.94	-35.95	-25.00	-10.95	Horizontal
Highest channel							
Frequency (MHz)	Level at antenna terminals (dBm)	Substitute antenna gain (dBi)	Cable Loss (dBi)	Spurious Emission level (dBm)	Limit Line (dBm)	Over Limit (dBm)	Polarization
5135.00	-58.86	12.92	1.01	-46.95	-25.00	-21.95	Vertical
7702.50	-48.39	11.26	1.72	-38.85	-25.00	-13.85	Vertical
10270.00	-44.69	11.54	1.95	-35.10	-25.00	-10.10	Vertical
5135.00	-58.60	12.92	1.01	-46.69	-25.00	-21.69	Horizontal
7702.50	-49.19	11.26	1.72	-39.65	-25.00	-14.65	Horizontal
10270.00	-47.00	11.54	1.95	-37.41	-25.00	-12.41	Horizontal
<i>Remark:</i>							
<i>The emission levels of below 1 GHz are lower than the limit 20dB and not show in test report.</i>							

Band 7 (20MHz)							
Lowest channel							
Frequency (MHz)	Level at antenna terminals (dBm)	Substitute antenna gain (dBi)	Cable Loss (dBi)	Spurious Emission level (dBm)	Limit Line (dBm)	Over Limit (dBm)	Polarization
5020.00	-56.54	12.99	0.97	-44.52	-25.00	-19.52	Vertical
7530.00	-49.43	11.46	1.68	-39.65	-25.00	-14.65	Vertical
10040.00	-45.88	11.68	1.94	-36.14	-25.00	-11.14	Vertical
5020.00	-58.97	12.99	0.97	-46.95	-25.00	-21.95	Horizontal
7530.00	-48.35	11.46	1.68	-38.57	-25.00	-13.57	Horizontal
10040.00	-44.85	11.68	1.94	-35.11	-25.00	-10.11	Horizontal
Middle channel							
Frequency (MHz)	Level at antenna terminals (dBm)	Substitute antenna gain (dBi)	Cable Loss (dBi)	Spurious Emission level (dBm)	Limit Line (dBm)	Over Limit (dBm)	Polarization
5070.00	-58.23	12.96	0.98	-46.25	-25.00	-21.25	Vertical
7605.00	-49.33	11.37	1.69	-39.65	-25.00	-14.65	Vertical
10140.00	-44.82	11.62	1.94	-35.14	-25.00	-10.14	Vertical
5070.00	-58.93	12.96	0.98	-46.95	-25.00	-21.95	Horizontal
7605.00	-48.79	11.37	1.69	-39.11	-25.00	-14.11	Horizontal
10140.00	-46.26	11.62	1.94	-36.58	-25.00	-11.58	Horizontal
Highest channel							
Frequency (MHz)	Level at antenna terminals (dBm)	Substitute antenna gain (dBi)	Cable Loss (dBi)	Spurious Emission level (dBm)	Limit Line (dBm)	Over Limit (dBm)	Polarization
5120.00	-59.45	12.93	1.00	-47.52	-25.00	-22.52	Vertical
7680.00	-45.75	11.28	1.72	-36.19	-25.00	-11.19	Vertical
10240.00	-43.66	11.56	1.95	-34.05	-25.00	-9.05	Vertical
5120.00	-58.80	12.93	1.00	-46.87	-25.00	-21.87	Horizontal
7680.00	-48.51	11.28	1.72	-38.95	-25.00	-13.95	Horizontal
10240.00	-46.75	11.56	1.95	-37.14	-25.00	-12.14	Horizontal
<i>Remark:</i>							
<i>The emission levels of below 1 GHz are lower than the limit 20dB and not show in test report.</i>							

6.6 Frequency stability V.S. Temperature measurement

Test Requirement:	Part 22.355, Part 24.235, Part 27.54, Part 2.1055(a)(1)(b)
Limit:	±2.5 ppm for Band 5 Within authorized band for Band 2 & 4 & 7 & 12 & 13 & 17
Test setup:	
Test procedure:	<ol style="list-style-type: none"> 1. The equipment under test was connected to an external DC power supply and input rated voltage. 2. RF output was connected to a frequency counter or spectrum analyzer via feed through attenuators. 3. The EUT was placed inside the temperature chamber. 4. Set the spectrum analyzer RBW low enough to obtain the desired frequency resolution and measure EUT 25°C operating frequency as reference frequency. 5. Turn EUT off and set the chamber temperature to -30°C. After the temperature stabilized for approximately 30 minutes recorded the frequency. 6. Repeat step measure with 10°C increased per stage until the highest temperature of +50°C reached
Test Instruments:	Refer to section 5.10 for details
Test mode:	Refer to section 5.3 for details
Test results:	Passed

Measurement Data (worst case):

LTE Band 2 part:

Reference Frequency: LTE Band 2 (10MHz) Middle channel=18900 channel=1880.00MHz					
Power supplied (Vdc)	Temperature (°C)	Frequency error		Limit (ppm)	Result
		Hz	ppm		
QPSK					
3.80	-30	180	0.095745	Within authorized band for Band 2	Pass
	-20	173	0.092021		
	-10	165	0.087766		
	0	158	0.084043		
	10	150	0.079787		
	20	146	0.077660		
	30	138	0.073404		
	40	131	0.069681		
	50	120	0.063830		
16QAM					
3.80	-30	183	0.097340	Within authorized band for Band 2	Pass
	-20	176	0.093617		
	-10	169	0.089894		
	0	160	0.085106		
	10	154	0.081915		
	20	143	0.076064		
	30	136	0.072340		
	40	130	0.069149		
	50	123	0.065426		

Note: Only the worst case shown in the report.

LTE Band 4 part:

Reference Frequency: LTE Band 4 (10MHz) Middle channel=20175 channel=1732.50MHz					
Power supplied (Vdc)	Temperature (°C)	Frequency error		Limit (ppm)	Result
		Hz	ppm		
QPSK					
3.80	-30	170	0.098124	Within authorized band for Band 4	Pass
	-20	163	0.094084		
	-10	157	0.090620		
	0	149	0.086003		
	10	143	0.082540		
	20	139	0.080231		
	30	134	0.077345		
	40	124	0.071573		
	50	112	0.064646		
16QAM					
3.80	-30	176	0.101587	Within authorized band for Band 4	Pass
	-20	161	0.092929		
	-10	154	0.088889		
	0	148	0.085426		
	10	140	0.080808		
	20	133	0.076768		
	30	126	0.072727		
	40	120	0.069264		
	50	115	0.066378		

Note: Only the worst case shown in the report.

LTE Band 7 part:

Reference Frequency: LTE Band 7 (10MHz) Middle channel=21100 Frequency=2535.00MHz					
Power supplied (Vdc)	Temperature (°C)	Frequency error		Limit (ppm)	Result
		Hz	ppm		
QPSK					
3.80	-30	170	0.067061	Within authorized band for Band 7	Pass
	-20	159	0.062722		
	-10	164	0.064694		
	0	140	0.055227		
	10	153	0.060355		
	20	133	0.052465		
	30	127	0.050099		
	40	121	0.047732		
	50	110	0.043393		
16QAM					
3.80	-30	172	0.067850	Within authorized band for Band 7	Pass
	-20	164	0.064694		
	-10	156	0.061538		
	0	142	0.056016		
	10	120	0.047337		
	20	134	0.052860		
	30	126	0.049704		
	40	107	0.042209		
	50	113	0.044576		

Note: Only the worst case shown in the report.

6.7 Frequency stability V.S. Voltage measurement

Test Requirement:	Part 22.355, Part 24.235, Part 27.54, Part 2.1055(d)(2)
Limit:	±2.5 ppm for Band 5 Within authorized band for Band 2 & 4 & 7 & 12 & 13 & 17
Test setup:	<p>The diagram illustrates the test setup. A Power Source is connected to a Divider. The Divider is connected to two Spectrum Analyzers (SA) and an Equipment Under Test (EUT). The EUT is housed inside a Temperature & Humidity Chamber.</p>
Test procedure:	<ol style="list-style-type: none"> 1. Set chamber temperature to 25°C. Use a variable DC power source to power the EUT and set the voltage to rated voltage. 2. Set the spectrum analyzer RBW low enough to obtain the desired frequency resolution and recorded the frequency. 3. Reduce the input voltage to specify extreme voltage variation (+/- 15%) and endpoint, record the maximum frequency change.
Test Instruments:	Refer to section 5.10 for details
Test mode:	Refer to section 5.3 for details
Test results:	Passed

Measurement Data (worst case):

LTE Band 2 part:

Reference Frequency: LTE Band 2(10MHz) Middle channel=18900 channel=1880.00MHz					
Temperature (°C)	Power supplied (Vdc)	Frequency error		Limit (ppm)	Result
		Hz	ppm		
QPSK					
25	4.35	79	0.042021	Within authorized band for Band 2	Pass
	3.80	58	0.030851		
	3.50	64	0.034043		
16QAM					
25	4.35	80	0.042553	Within authorized band for Band 2	Pass
	3.80	70	0.037234		
	3.50	50	0.026596		

Note: Only the worst case shown in the report.

LTE Band 4 part:

Reference Frequency: LTE Band 4(10MHz) Middle channel=20175 channel=1732.50MHz					
Temperature (°C)	Power supplied (Vdc)	Frequency error		Limit (ppm)	Result
		Hz	ppm		
QPSK					
25	4.35	88	0.050794	Within authorized band for Band 4	Pass
	3.80	76	0.043867		
	3.50	63	0.036364		
16QAM					
25	4.35	90	0.051948	Within authorized band for Band 4	Pass
	3.80	82	0.047330		
	3.50	70	0.040404		

Note: Only the worst case shown in the report.

LTE Band 7 part:

Reference Frequency: LTE Band 7(10MHz) Middle channel=21100 Frequency=2535.00MHz					
Temperature (°C)	Power supplied (Vdc)	Frequency error		Limit (ppm)	Result
		Hz	ppm		
QPSK					
25	4.35	86	0.033925	Within authorized band for Band 7	Pass
	3.80	73	0.028797		
	3.50	65	0.025641		
16QAM					
25	4.35	90	0.035503	Within authorized band for Band 7	Pass
	3.80	80	0.031558		
	3.50	50	0.019724		

Note: Only the worst case shown in the report.

8 EUT Constructional Details

Reference to the test report No. CCISE200801601

-----End of report-----