



RADIO TEST REPORT

Test Report No. 14277396H-A

Customer	AIPHONE CO., LTD.
Description of EUT	Master monitor station
Model Number of EUT	JO-1MDW V2
FCC ID	2ALNEJO1MDWV2
Test Regulation	FCC Part 15 Subpart C
Test Result	Complied (Refer to SECTION 3)
Issue Date	June 28, 2022
Remarks	-

Representative Test Engineer

Kiyoshiro Okazaki
Engineer

Approved By

Takumi Shimada
Engineer



CERTIFICATE 5107.02

- The testing in which "Non-accreditation" is displayed is outside the accreditation scopes in UL Japan, Inc.
 There is no testing item of "Non-accreditation".

Report Cover Page - Form-ULID-003532 (DCS:13-EM-F0429) Issue# 20.0

ANNOUNCEMENT

- This test report shall not be reproduced in full or partial, without the written approval of UL Japan, Inc.
- The results in this report apply only to the sample tested.
- This sample tested is in compliance with the limits of the above regulation.
- The test results in this test report are traceable to the national or international standards.
- This test report must not be used by the customer to claim product certification, approval, or endorsement by the A2LA accreditation body.
- This test report covers Radio technical requirements.
It does not cover administrative issues such as Manual or non-Radio test related Requirements. (if applicable)
- The all test items in this test report are conducted by UL Japan, Inc Ise EMC Lab.
- The opinions and the interpretations to the result of the description in this report are outside scopes where UL Japan, Inc. has been accredited.
- The information provided from the applicant for this report is identified in Section 1.
- For test report(s) referred in this report, the latest version (including any revisions) is always referred.

REVISION HISTORY

Original Test Report No.: 14277396H-A

Revision	Test Report No.	Date	Page Revised Contents
- (Original)	14277396H-A	June 28, 2022	-

Reference: Abbreviations (Including words undescribed in this report)

A2LA	The American Association for Laboratory Accreditation	ICES	Interference-Causing Equipment Standard
AC	Alternating Current	IEC	International Electrotechnical Commission
AFH	Adaptive Frequency Hopping	IEEE	Institute of Electrical and Electronics Engineers
AM	Amplitude Modulation	IF	Intermediate Frequency
Amp, AMP	Amplifier	ILAC	International Laboratory Accreditation Conference
ANSI	American National Standards Institute	ISED	Innovation, Science and Economic Development Canada
Ant, ANT	Antenna	ISO	International Organization for Standardization
AP	Access Point	JAB	Japan Accreditation Board
ASK	Amplitude Shift Keying	LAN	Local Area Network
Atten., ATT	Attenuator	LIMS	Laboratory Information Management System
AV	Average	MCS	Modulation and Coding Scheme
BPSK	Binary Phase-Shift Keying	MRA	Mutual Recognition Arrangement
BR	Bluetooth Basic Rate	N/A	Not Applicable
BT	Bluetooth	NIST	National Institute of Standards and Technology
BT LE	Bluetooth Low Energy	NS	No signal detect.
BW	BandWidth	NSA	Normalized Site Attenuation
Cal Int	Calibration Interval	NVLAP	National Voluntary Laboratory Accreditation Program
CCK	Complementary Code Keying	OBW	Occupied Band Width
Ch., CH	Channel	OFDM	Orthogonal Frequency Division Multiplexing
CISPR	Comite International Special des Perturbations Radioelectriques	P/M	Power meter
CW	Continuous Wave	PCB	Printed Circuit Board
DBPSK	Differential BPSK	PER	Packet Error Rate
DC	Direct Current	PHY	Physical Layer
D-factor	Distance factor	PK	Peak
DFS	Dynamic Frequency Selection	PN	Pseudo random Noise
DQPSK	Differential QPSK	PRBS	Pseudo-Random Bit Sequence
DSSS	Direct Sequence Spread Spectrum	PSD	Power Spectral Density
EDR	Enhanced Data Rate	QAM	Quadrature Amplitude Modulation
EIRP, e.i.r.p.	Equivalent Isotropically Radiated Power	QP	Quasi-Peak
EMC	ElectroMagnetic Compatibility	QPSK	Quadri-Phase Shift Keying
EMI	ElectroMagnetic Interference	RBW	Resolution Band Width
EN	European Norm	RDS	Radio Data System
ERP, e.r.p.	Effective Radiated Power	RE	Radio Equipment
EU	European Union	RF	Radio Frequency
EUT	Equipment Under Test	RMS	Root Mean Square
Fac.	Factor	RSS	Radio Standards Specifications
FCC	Federal Communications Commission	Rx	Receiving
FHSS	Frequency Hopping Spread Spectrum	SA, S/A	Spectrum Analyzer
FM	Frequency Modulation	SG	Signal Generator
Freq.	Frequency	SVSWR	Site-Voltage Standing Wave Ratio
FSK	Frequency Shift Keying	TR	Test Receiver
GFSK	Gaussian Frequency-Shift Keying	Tx	Transmitting
GNSS	Global Navigation Satellite System	VBW	Video BandWidth
GPS	Global Positioning System	Vert.	Vertical
Hori.	Horizontal	WLAN	Wireless LAN

CONTENTS	PAGE
SECTION 1: Customer Information	5
SECTION 2: Equipment Under Test (EUT).....	5
SECTION 3: Test Specification, Procedures & Results.....	6
SECTION 4: Operation of EUT during testing	9
SECTION 5: Conducted Emission.....	12
SECTION 6: Radiated Spurious Emission	13
SECTION 7: Antenna Terminal Conducted Tests.....	16
APPENDIX 1: Test Data.....	17
Conducted Emission	17
99 % Occupied Bandwidth and 6 dB Bandwidth.....	18
Maximum Peak Output Power	25
Average Output Power	28
Radiated Spurious Emission	31
Conducted Spurious Emission	57
Power Density	58
APPENDIX 2: Test Instruments.....	65
APPENDIX 3: Photographs of Test Setup	67
Conducted Emission	67
Radiated Spurious Emission	68
Worst Case Position	69
Worst Case Confirmation.....	70
Antenna Terminal Conducted Tests.....	71

SECTION 1: Customer Information

Company Name	AIPHONE CO., LTD.
Address	2-18 Jinno-cho, Atsuta-ku, Nagoya, Aichi 456-8666, Japan
Telephone Number	+81-52-681-8721
Contact Person	Tomohito Abe

The information provided from the customer is as follows;

- Customer, Description of EUT, Model Number of EUT, FCC ID on the cover and other relevant pages
 - Operating/Test Mode(s) (Mode(s)) on all the relevant pages
 - SECTION 1: Customer Information
 - SECTION 2: Equipment Under Test (EUT) other than the Receipt Date and Test Date
 - SECTION 4: Operation of EUT during testing
- * The laboratory is exempted from liability of any test results affected from the above information in SECTION 2 and 4.

SECTION 2: Equipment Under Test (EUT)

2.1 Identification of EUT

Description	Master monitor station
Model Number	JO-1MDW V2
Serial Number	Refer to SECTION 4.2
Condition	Production prototype (Not for Sale: This sample is equivalent to mass-produced items.)
Modification	No Modification by the test lab
Receipt Date	May 9 and 15, 2022
Test Date	May 9 to 17, 2022

2.2 Product Description

General Specification

Rating	DC 18 V (Master monitor station) AC 100 V to 240 V, 50 / 60 Hz (AC Adapter)
Operating temperature	0 deg. C to 40 deg. C

Radio Specification

WLAN (IEEE802.11b/11g/11n-20)

Equipment Type	Transceiver
Frequency of Operation	2412 MHz to 2472 MHz
Type of Modulation	DSSS, OFDM
Antenna Type	Dipole antenna*
Antenna Gain	2.7 dBi (Antenna A) / 3.2 dBi (Antenna B)

*Dipole antenna has two types: Antenna A and Antenna B. Those antennas do not transmit simultaneously.

SECTION 3: Test Specification, Procedures & Results

3.1 Test Specification

Test Specification	FCC Part 15 Subpart C FCC Part 15 final revised on April 1, 2022 and effective May 2, 2022
Title	FCC 47 CFR Part 15 Radio Frequency Device Subpart C Intentional Radiators Section 15.207 Conducted limits Section 15.247 Operation within the bands 902-928 MHz, 2400-2483.5 MHz, and 5725-5850 MHz

*Also the EUT complies with FCC Part 15 Subpart B.

3.2 Procedures and Results

Item	Test Procedure	Specification	Worst Margin	Results	Remarks
Conducted Emission	FCC: ANSI C63.10-2013 6. Standard test methods ----- ISED: RSS-Gen 8.8	FCC: Section 15.207 ----- ISED: RSS-Gen 8.8	22.68 dB, 0.15425 MHz, Phase L, QP	Complied a)	-
6dB Bandwidth	FCC: KDB 558074 D01 15.247 Meas Guidance v05r02 ----- ISED: -	FCC: Section 15.247(a)(2) ----- ISED: RSS-247 5.2(a)	See data.	Complied b)	Conducted
Maximum Peak Output Power	FCC: KDB 558074 D01 15.247 Meas Guidance v05r02 ----- ISED: RSS-Gen 6.12	FCC: Section 15.247(b)(3) ----- ISED: RSS-247 5.4(d)		Complied c)	Conducted
Power Density	FCC: KDB 558074 D01 15.247 Meas Guidance v05r02 ----- ISED: -	FCC: Section 15.247(e) ----- ISED: RSS-247 5.2(b)		Complied d)	Conducted
Spurious Emission Restricted Band Edges	FCC: KDB 558074 D01 15.247 Meas Guidance v05r02 ----- ISED: RSS-Gen 6.13	FCC: Section 15.247(d) ----- ISED: RSS-247 5.5 RSS-Gen 8.9 RSS-Gen 8.10	0.5 dB 2390.0 MHz, AV, Horizontal	Complied# e), f)	Conducted (below 30 MHz)/ Radiated (above 30 MHz) *1)
Note: UL Japan, Inc.'s EMI Work Procedures: Work Instructions-ULID-003591 and Work Instructions-ULID-003593. * In case any questions arise about test procedure, ANSI C63.10: 2013 is also referred. *1) Radiated test was selected over 30 MHz based on section 15.247(d) and KDB 558074 D01 15.247 Meas Guidance v05r02 8.5 and 8.6. a) Refer to APPENDIX 1 (data of Conducted Emission) b) Refer to APPENDIX 1 (data of 6 dB Bandwidth and 99 % Occupied Bandwidth) c) Refer to APPENDIX 1 (data of Maximum Peak Output Power) d) Refer to APPENDIX 1 (data of Power Density) e) Refer to APPENDIX 1 (data of Conducted Spurious Emission) f) Refer to APPENDIX 1 (data of Radiated Spurious Emission)					
Symbols: Complied The data of this test item has enough margin, more than the measurement uncertainty. Complied# The data of this test item meets the limits unless the measurement uncertainty is taken into consideration					

FCC Part 15.31 (e)

This EUT provides stable voltage constantly to RF Module regardless of input voltage.
Therefore, this EUT complies with the requirement.

FCC Part 15.203 Antenna requirement

It is impossible for end users to replace the antenna, because the antenna is mounted inside of the EUT.
Therefore, the equipment complies with the antenna requirement of Section 15.203.

3.3 Addition to Standard

Item	Test Procedure	Specification	Worst Margin	Results	Remarks
99% Occupied Bandwidth	ISED: RSS-Gen 6.7	ISED: -	N/A	-	Conducted

Other than above, no addition, exclusion nor deviation has been made from the standard.

3.4 Uncertainty

There is no applicable rule of uncertainty in this applied standard. Therefore, the results are derived depending on whether or not laboratory uncertainty is applied.

The following uncertainties have been calculated to provide a confidence level of 95 % using a coverage factor $k=2$.

Conducted emission

Using Item	Frequency range	Uncertainty (+/-)
AMN (LISN)	0.009 MHz to 0.15 MHz	3.7 dB
	0.15 MHz to 30 MHz	3.3 dB

Radiated emission

Measurement distance	Frequency range		Uncertainty (+/-)
3 m	9 kHz to 30 MHz		3.2 dB
10 m			3.0 dB
3 m	30 MHz to 200 MHz	Horizontal	4.8 dB
		Vertical	5.0 dB
	200 MHz to 1000 MHz	Horizontal	5.1 dB
		Vertical	6.2 dB
10 m	30 MHz to 200 MHz	Horizontal	4.8 dB
		Vertical	4.8 dB
	200 MHz to 1000 MHz	Horizontal	5.0 dB
		Vertical	5.0 dB
3 m	1 GHz to 6 GHz		4.9 dB
	6 GHz to 18 GHz		5.2 dB
1 m	10 GHz to 26.5 GHz		5.4 dB
	26.5 GHz to 40 GHz		5.4 dB
10 m	1 GHz to 18 GHz		5.4 dB

Antenna Terminal test

Test Item	Uncertainty (+/-)
20 dB Bandwidth / 99 % Occupied Bandwidth	0.96 %
Maximum Peak Output Power / Average Output Power	1.5 dB
Carrier Frequency Separation	0.42 %
Dwell time / Burst rate	0.10 %
Conducted Spurious Emission	2.7 dB

3.5 Test Location

UL Japan, Inc. Ise EMC Lab.

*A2LA Certificate Number: 5107.02 / FCC Test Firm Registration Number: 884919

ISED Lab Company Number: 2973C / CAB identifier: JP0002

4383-326 Asama-cho, Ise-shi, Mie-ken 516-0021 Japan

Telephone: +81-596-24-8999

Test site	Width x Depth x Height (m)	Size of reference ground plane (m) / horizontal conducting plane	Other rooms	Maximum measurement distance
No.1 semi-anechoic chamber	19.2 x 11.2 x 7.7	7.0 x 6.0	No.1 Power source room	10 m
No.2 semi-anechoic chamber	7.5 x 5.8 x 5.2	4.0 x 4.0	-	3 m
No.3 semi-anechoic chamber	12.0 x 8.5 x 5.9	6.8 x 5.75	No.3 Preparation room	3 m
No.3 shielded room	4.0 x 6.0 x 2.7	N/A	-	-
No.4 semi-anechoic chamber	12.0 x 8.5 x 5.9	6.8 x 5.75	No.4 Preparation room	3 m
No.4 shielded room	4.0 x 6.0 x 2.7	N/A	-	-
No.5 semi-anechoic chamber	6.0 x 6.0 x 3.9	6.0 x 6.0	-	-
No.5 measurement room	6.4 x 6.4 x 3.0	6.4 x 6.4	-	-
No.6 shielded room	4.0 x 4.5 x 2.7	4.0 x 4.5	-	-
No.6 measurement room	4.75 x 5.4 x 3.0	4.75 x 4.15	-	-
No.7 shielded room	4.7 x 7.5 x 2.7	4.7 x 7.5	-	-
No.8 measurement room	3.1 x 5.0 x 2.7	3.1 x 5.0	-	-
No.9 measurement room	8.8 x 4.6 x 2.8	2.4 x 2.4	-	-
No.10 shielded room	3.8 x 2.8 x 2.8	3.8 x 2.8	-	-
No.11 measurement room	4.0 x 3.4 x 2.5	N/A	-	-
No.12 measurement room	2.6 x 3.4 x 2.5	N/A	-	-
Large Chamber	16.9 x 22.1 x 10.17	16.9 x 22.1	-	10 m
Small Chamber	5.3 x 6.69 x 3.59	5.3 x 6.69	-	-

* Size of vertical conducting plane (for Conducted Emission test) : 2.0 x 2.0 m for No.1, No.2, No.3, and No.4 semi-anechoic chambers and No.3 and No.4 shielded rooms.

3.6 Test Data, Test Instruments, and Test Set Up

Refer to APPENDIX.

SECTION 4: Operation of EUT during testing

4.1 Operating Mode(s)

Test operating mode was determined as follows according to “Section 1 of 6 802.11 a/b/g/n testing - Managing Complex Regulatory Approvals - ” of TCB Council Workshop October 2009.

Mode	Remarks*
IEEE 802.11b (11b)	11 Mbps, PN9
IEEE 802.11g (11g)	54 Mbps, PN9
IEEE 802.11n (11n-20)	MCS 6 (Long GI), PN9
*The worst condition was determined based on the test result of Maximum Peak Output Power (Mid Channel).	
*Power of the EUT was set by the software as follows; Power Setting: 11b : 18 dBm (1 ch to 11 ch) / 10 dBm (12ch, 13ch) 11g : 16 dBm (1 ch to 11 ch) / 10 dBm (12 ch) / -8 dBm (13 ch) 11n-20 : 15 dBm (1 ch to 11 ch) / 10 dBm (12 ch) / -8 dBm (13 ch) Software: Tera Term Version:4.106 (Date: 2021.05 31, Storage location: Driven by connected PC)	
*This setting of software is the worst case. Any conditions under the normal use do not exceed the condition of setting. In addition, end users cannot change the settings of the output power of the product.	

*The Details Of Operating Mode(s)

Test Item	Operating Mode	Tested Antenna	Tested Frequency
Conducted Emission, Radiated Spurious Emission (Below 1 GHz), Conducted Spurious Emission	Tx 11g *1)	Antenna B	2462 MHz
99% Occupied Bandwidth, 6dB Bandwidth, Maximum Peak Output Power, Radiated Spurious Emission (Above 1 GHz), Power Density	Tx 11b	Antenna B	2412 MHz
			2442 MHz
			2462 MHz
	Tx 11g	Antenna B	2472 MHz
			2412 MHz
			2442 MHz
			2462 MHz
	Tx 11n-20	Antenna B	2467 MHz
			2472 MHz
2412 MHz			
2442 MHz			
			2462 MHz
			2467 MHz
			2472 MHz

*1) The mode was tested as a representative, because it had the highest power at antenna terminal test.

4.2 Configuration and Peripherals

[Conducted Emission and Radiated Emission]

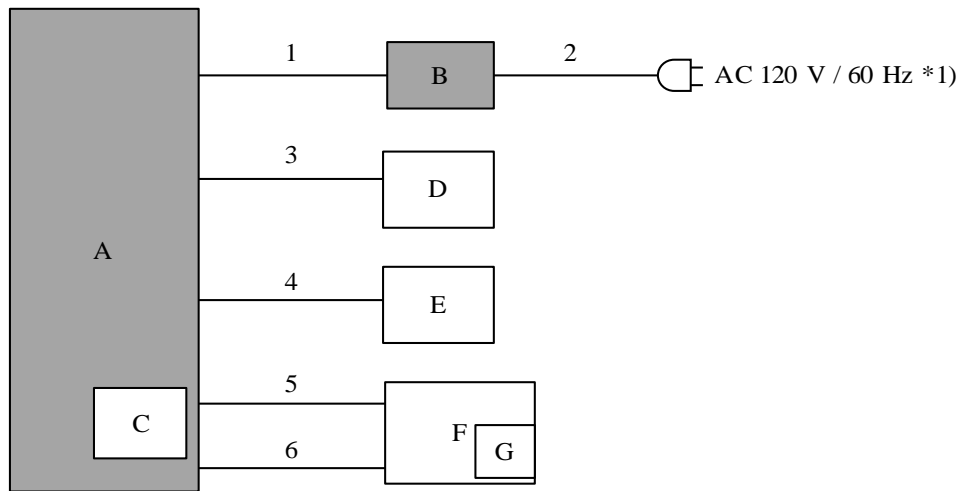

* Cabling and setup(s) were taken into consideration and test data was taken under worse case conditions.

*1) The test was performed on this port.

As a result of comparing AC 120 V and AC 240 V at pre-check, conducted emission test was performed with AC 120 V of the worst voltage as representative.

Description of EUT and Support Equipment

No.	Item	Model number	Serial Number	Manufacturer	Remarks
A	Master monitor station	JO-1MDW V2	J456-JOSI-024	AIPHONE CO., LTD.	EUT
B	AC Adaptor	PS-1820	J465-103	AIPHONE CO., LTD.	EUT
C	Micro SD	V10	J465-012	BUFFALO	-
D	Entrance cordless handset	JO-DV	J465-063	AIPHONE CO., LTD.	-
E	Circumscribed speaker	IER-2	J465-074	AIPHONE CO., LTD.	-
F	Jig	-	-	-	-
G	Battery	6LR61Y	-	Panasonic	-

List of Cables Used

No.	Name	Length (m)	Shield		Remarks
			Cable	Connector	
1	DC Cable	1.9	Unshielded	Unshielded	-
2	AC Cable	1.0 for CE* 1.8 for RE*	Unshielded	Unshielded	-
3	Signal Cable	1.0	Unshielded	Unshielded	-
4	Signal Cable	1.0	Unshielded	Unshielded	-
5	Signal Cable	1.0	Unshielded	Unshielded	-
6	Signal Cable	1.0	Unshielded	Unshielded	-

*CE: Conducted Emission, RE: Radiated Emission

[Antenna Terminal Conducted]

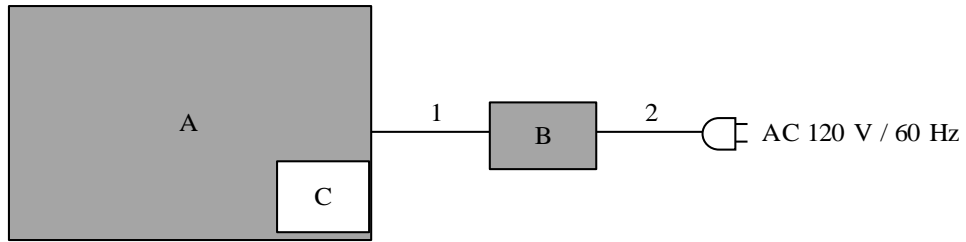

* Cabling and setup(s) were taken into consideration and test data was taken under worse case conditions.

Description of EUT and Support Equipment

No.	Item	Model number	Serial Number	Manufacturer	Remarks
A	Master monitor station	JO-1MDW V2	J456-JOSI-022	AIPHONE CO., LTD.	EUT
B	AC Adaptor	PS-1820	J465-103	AIPHONE CO., LTD.	EUT
C	Micro SD	V10	J465-014	BUFFALO	-

List of Cables Used

No.	Name	Length (m)	Shield		Remarks
			Cable	Connector	
1	DC Cable	1.9	Unshielded	Unshielded	-
2	AC Cable	1.8	Unshielded	Unshielded	-

SECTION 5: Conducted Emission

Test Procedure and Conditions

EUT was placed on a urethane platform of nominal size, 1.0 m by 1.5 m, raised 0.8 m above the conducting ground plane. The rear of tabletop was located 40 cm to the vertical conducting plane. The rear of EUT, including peripherals aligned and flushed with rear of tabletop. All other surfaces of tabletop were at least 80cm from any other grounded conducting surface. EUT was located 80 cm from a Line Impedance Stabilization Network (LISN) / Artificial mains Network (AMN) and excess AC cable was bundled in center.

For the tests on EUT with other peripherals (as a whole system)

I/O cables that were connected to the peripherals were bundled in center. They were folded back and forth forming a bundle 30 cm to 40 cm long and were hanged at a 40 cm height to the ground plane. All unused 50ohm connectors of the LISN (AMN) were resistivity terminated in 50 ohm when not connected to the measuring equipment.

The AC Mains Terminal Continuous disturbance Voltage has been measured with the EUT in a Semi Anechoic Chamber. The EUT was connected to a LISN (AMN).

An overview sweep with peak detection has been performed.

The test results and limit are rounded off to one decimal place, so some differences might be observed.

Detector	: QP and CISPR AV
Measurement Range	: 0.15 MHz to 30 MHz
Test Data	: APPENDIX
Test Result	: Pass

Figure 1: Test Setup

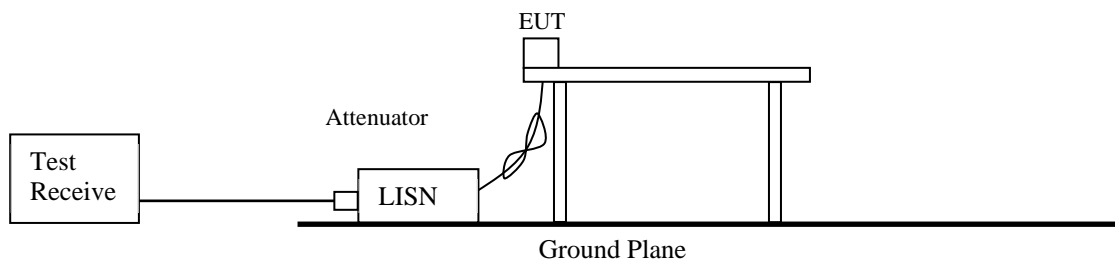

SECTION 6: Radiated Spurious Emission

Test Procedure

It was measured based on "8.5 and 8.6 of KDB 558074 D01 15.247 Meas Guidance v05r02".

[For below 1 GHz]

EUT was placed on a urethane platform of nominal size, 1.0 m by 1.5 m, raised 0.8 m above the conducting ground plane. The Radiated Electric Field Strength has been measured in a Semi Anechoic Chamber with a ground plane.

[For above 1 GHz]

EUT was placed on a urethane platform of nominal size, 0.5 m by 0.5 m, raised 1.5 m above the conducting ground plane. The Radiated Electric Field Strength has been measured in a Semi Anechoic Chamber with absorbent materials lined on a ground plane.

The height of the measuring antenna varied between 1 m and 4 m and EUT was rotated a full revolution in order to obtain the maximum value of the electric field strength.

Test antenna was aimed at the EUT for receiving the maximum signal and always kept within the illumination area of the 3 dB beamwidth of the antenna.

The measurements were performed for both vertical and horizontal antenna polarization with the Test Receiver, or the Spectrum Analyzer.

The measurements were made with the following detector function of the test receiver and the Spectrum analyzer (in linear mode).

The test was made with the detector (RBW/VBW) in the following table.

When using Spectrum analyzer, the test was made with adjusting span to zero by using peak hold.

Test Antennas are used as below;

Frequency	30 MHz to 200 MHz	200 MHz to 1 GHz	Above 1 GHz
Antenna Type	Biconical	Logperiodic	Horn

In any 100 kHz bandwidth outside the restricted band in which the spread spectrum intentional radiator is operating, the radio frequency power that is produced by the intentional radiator confirmed 20 dB below that in the 100 kHz bandwidth within the band that contains the highest level of the desired power, based on a radiated measurement.

20 dBc was applied to the frequency over the limit of FCC 15.209 / Table 4 of RSS-Gen 8.9(ISED) and outside the restricted band of FCC15.205 / Table 6 of RSS-Gen 8.10 (ISED).

Frequency	Below 1 GHz	Above 1 GHz		20 dBc
Instrument Used	Test Receiver	Spectrum Analyzer		Spectrum Analyzer
Detector	QP	PK	AV *1)	PK
IF Bandwidth	BW 120 kHz	RBW: 1 MHz VBW: 3 MHz	<u>11.12.2.5.1</u> RBW: 1 MHz VBW: 3 MHz Detector: Power Averaging (RMS) Trace: 100 traces <u>11.12.2.5.2</u> The duty cycle was less than 98% for detected noise, a duty factor was added to the 11.12.2.5.1 results. Integration Method: <u>11.13.3.4</u> RBW: 100 kHz VBW: 300 kHz Span: 2 MHz Band Power: 1 MHz Detector: Power Averaging (RMS) Trace: 100 traces Duty factor was added to the results.	RBW: 100 kHz VBW: 300 kHz

*1) Average Power Measurement was performed based on ANSI C63.10-2013.

Figure 2: Test Setup

Below 1 GHz

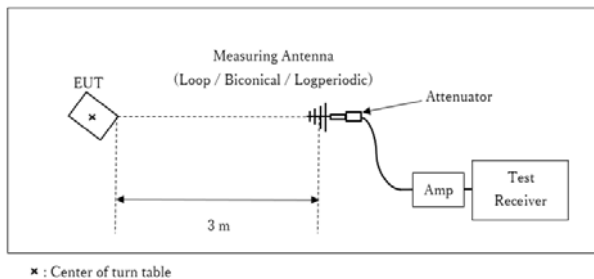

Test Distance: 3 m

1 GHz to 10 GHz

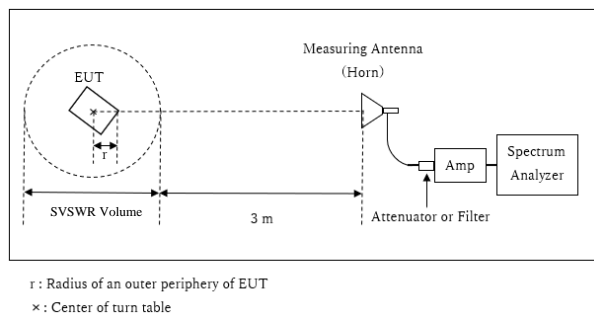

Distance Factor: $20 \times \log (3.65 \text{ m} / 3.0 \text{ m}) = 1.71 \text{ dB}$
* Test Distance: $(3 + \text{SVSWR Volume} / 2) - r = 3.65 \text{ m}$

SVSWR Volume : 1.5 m
(SVSWR Volume has been calibrated based on CISPR 16-1-4.)
 $r = 0.1 \text{ m}$

10 GHz to 26.5 GHz

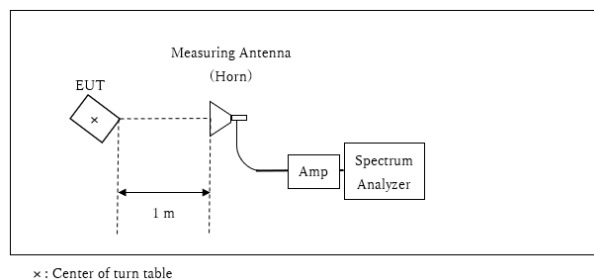

Distance Factor: $20 \times \log (1.0 \text{ m} / 3.0 \text{ m}) = -9.5 \text{ dB}$
*Test Distance: 1 m

- The carrier level and noise levels were confirmed at each position of X, Y and Z axes of EUT to see the position of maximum noise, and the test was made at the position that has the maximum noise.

- This EUT has two modes which Metal frame is attached or not. The worst case was confirmed with and without Metal frame attached, as a result, the test without Metal frame attached was the worst case. Therefore the test without Metal frame attached was performed only.

The test results and limit are rounded off to one decimal place, so some differences might be observed.

Measurement Range : 30 MHz to 26.5 GHz
Test Data : APPENDIX
Test Result : Pass

SECTION 7: Antenna Terminal Conducted Tests

Test Procedure

The tests were made with below setting connected to the antenna port.

Test	Span	RBW	VBW	Sweep time	Detector	Trace	Instrument Used
6dB Bandwidth	20 MHz	100 kHz	300 kHz	Auto	Peak	Max Hold	Spectrum Analyzer
99% Occupied Bandwidth *1)	Enough width to display emission skirts	1 to 5 % of OBW	Three times of RBW	Auto	Peak	Max Hold	Spectrum Analyzer
Maximum Peak Output Power	-	-	-	Auto	Peak/Average *2)	-	Power Meter (Sensor: 50 MHz BW)
Peak Power Density	1.5 times the 6dB Bandwidth	3 kHz	10 kHz	Auto	Peak	Max Hold	Spectrum Analyzer *3)
Conducted Spurious Emission *4) *5)	9kHz to 150kHz	200 Hz	620 Hz	Auto	Peak	Max Hold	Spectrum Analyzer
	150kHz to 30MHz	9.1 kHz	27 kHz				

*1) Peak hold was applied as Worst-case measurement.

*2) Reference data

*3) Section 11.10.2 Method PKPSD (peak PSD) of "ANSI C63.10-2013".

*4) In the frequency range below 30MHz, RBW was narrowed to separate the noise contents.

Then, wide-band noise near the limit was checked separately, however the noise was low enough as shown in the chart.

(9 kHz - 150 kHz: RBW = 200 Hz, 150 kHz - 30 MHz: RBW = 9.1 kHz).

*5) The limits in CFR 47, Part 15, Subpart C, paragraph 15.209(a), are identical to those in RSS-Gen section 8.9, Table 6, since the measurements are performed in terms of magnetic field strength and converted to electric field strength levels (as reported in the table) using the free space impedance of 377 Ohms. For example, the measurement at frequency 9 kHz resulted in a level of 45.5 dBuV/m, which is equivalent to $45.5 - 51.5 = -6.0$ dBuA/m, which has the same margin, 3 dB, to the corresponding RSS-Gen Table 6 limit as it has to 15.209(a) limit.

The test results and limit are rounded off to two decimals place, so some differences might be observed.
The equipment and cables were not used for factor 0 dB of the data sheets.

Test Data : **APPENDIX**

Test Result : **Pass**

APPENDIX 1: Test Data

Conducted Emission

Test place Ise EMC Lab. No.2 Semi Anechoic Chamber
 Date May 15, 2022
 Temperature / Humidity 23 deg. C / 53 % RH
 Engineer Kiyoshiro Okazaki
 Mode Tx 11g 2462 MHz

Limit : FCC_Part 15 Subpart C(15.207)

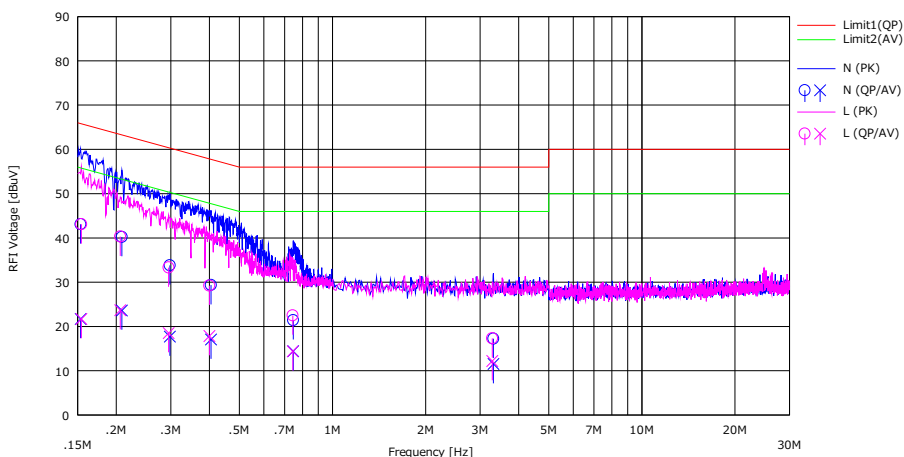

No.	Freq. [MHz]	Reading		USN [dB]	LOSS [dB]	Results		Limit		Margin		Phase	Comment
		(QP) [dBuV]	(AV) [dBuV]			(QP) [dBuV]	(AV) [dBuV]	(QP) [dB]	(AV) [dB]				
1	0.15340	29.90	8.50	0.05	13.14	43.09	21.69	65.81	55.81	22.72	34.12	N	
2	0.20865	27.00	10.40	0.05	13.16	40.21	23.61	63.26	53.26	23.05	29.65	N	
3	0.29790	20.60	4.50	0.04	13.18	33.82	17.72	60.30	50.30	26.48	32.58	N	
4	0.40500	16.10	3.80	0.05	13.20	29.35	17.05	57.75	47.75	28.40	30.70	N	
5	0.74670	8.10	1.10	0.05	13.26	21.41	14.41	56.00	46.00	34.59	31.59	N	
6	3.31300	3.60	-2.10	0.10	13.52	17.22	11.52	56.00	46.00	38.78	34.48	N	
7	0.15425	29.90	8.50	0.05	13.14	43.09	21.69	65.77	55.77	22.68	34.08	L	
8	0.20610	27.10	10.50	0.05	13.15	40.30	23.70	63.36	53.36	23.06	29.66	L	
9	0.29535	20.10	5.30	0.04	13.18	33.32	18.52	60.37	50.37	27.05	31.85	L	
10	0.39990	16.00	4.60	0.04	13.19	29.23	17.83	57.86	47.86	28.63	30.03	L	
11	0.74415	9.20	1.10	0.04	13.26	22.50	14.40	56.00	46.00	33.50	31.60	L	
12	3.28600	3.70	-1.40	0.09	13.52	17.31	12.21	56.00	46.00	38.69	33.79	L	

CHART: WITH FACTOR Peak hold data. CALCULATION : RESULT = READING + LISN + LOSS (CABLE + ATT)
 Except for the above table: adequate margin data below the limits.

99 % Occupied Bandwidth and 6 dB Bandwidth

Test place Ise EMC Lab. No.6 Measurement Room
Date May 17, 2022
Temperature / Humidity 23 deg. C / 51 % RH
Engineer Takumi Nishida
Mode Tx

Mode	Frequency [MHz]	99 % Occupied Bandwidth [kHz]	6 dB Bandwidth [MHz]	Limit for 6 dB Bandwidth [MHz]
11b	2412	13850.7	7.897	> 0.5000
	2442	13803.7	10.187	> 0.5000
	2462	13838.2	9.489	> 0.5000
	2472	13747.2	9.401	> 0.5000
11g	2412	16749.9	15.395	> 0.5000
	2442	16662.9	15.128	> 0.5000
	2462	16657.1	15.620	> 0.5000
	2467	16675.6	15.413	> 0.5000
	2472	16721.3	15.126	> 0.5000
11n-20	2412	17708.2	15.314	> 0.5000
	2442	17726.3	15.393	> 0.5000
	2462	17714.2	15.126	> 0.5000
	2467	17709.4	15.380	> 0.5000
	2472	17764.2	15.431	> 0.5000

99 % Occupied Bandwidth and 6 dB Bandwidth

11b

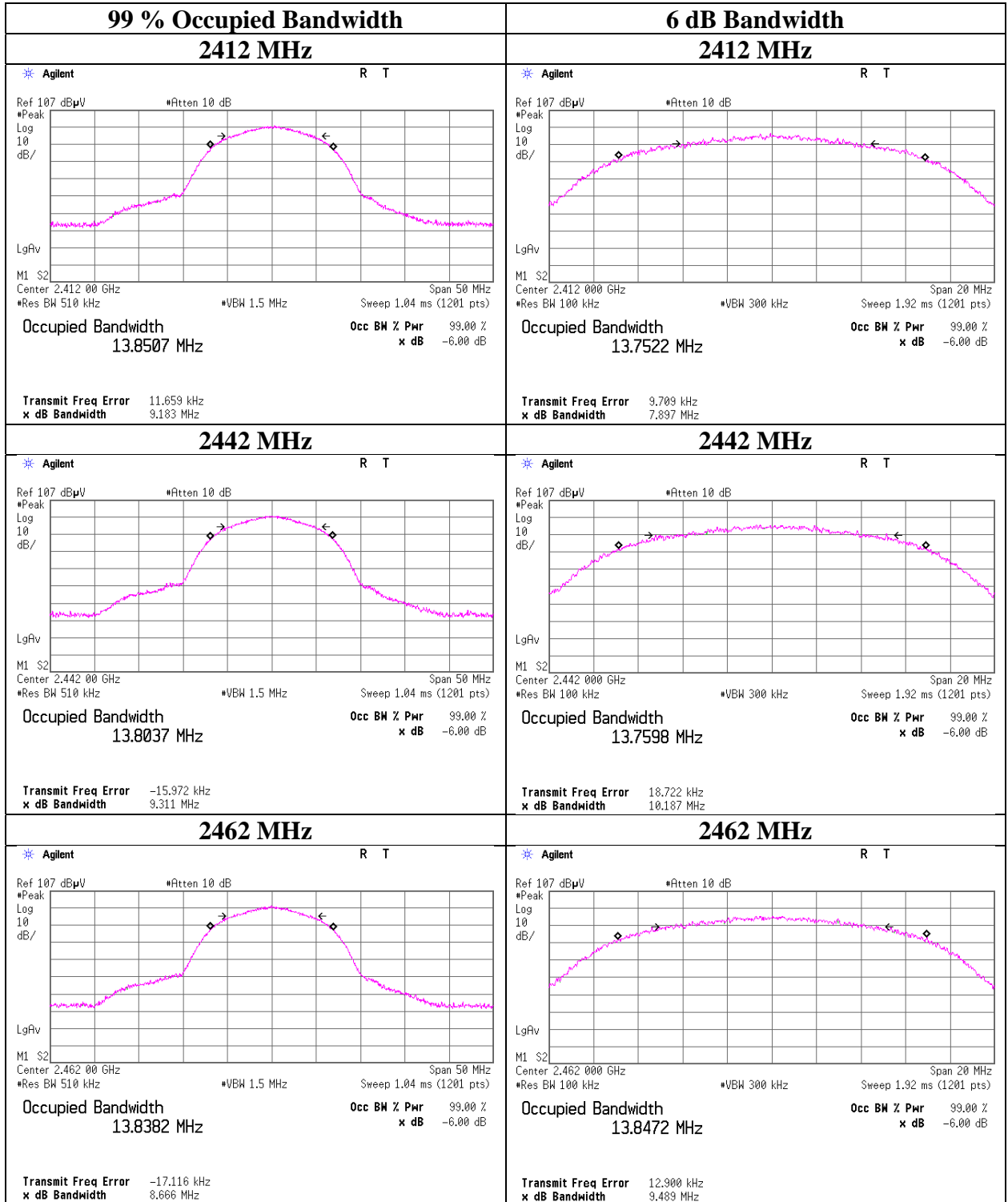

99 % Occupied Bandwidth and 6 dB Bandwidth

11b

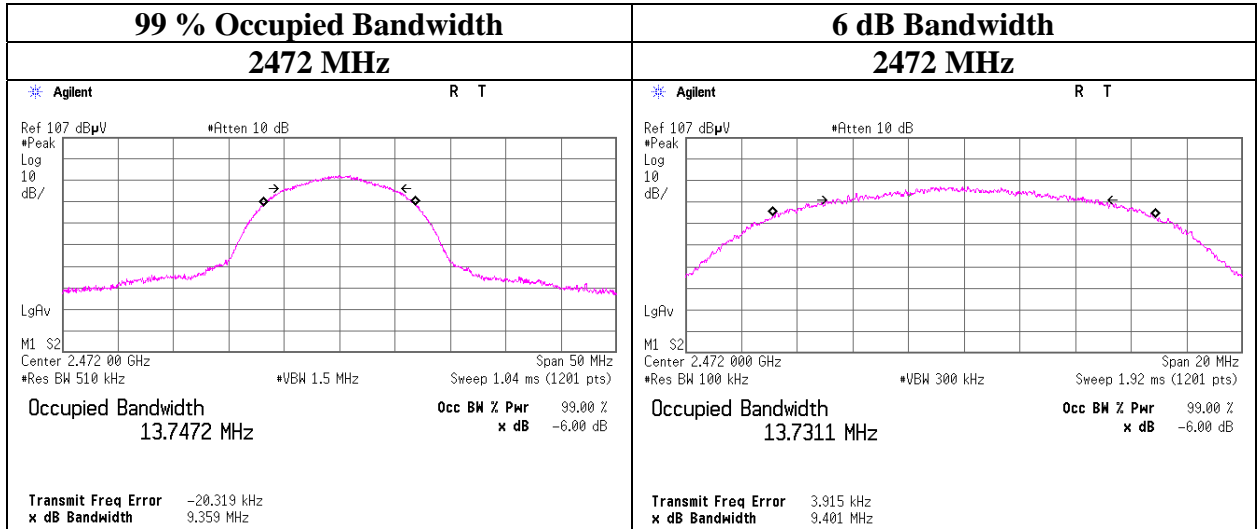

99 % Occupied Bandwidth and 6 dB Bandwidth

11g

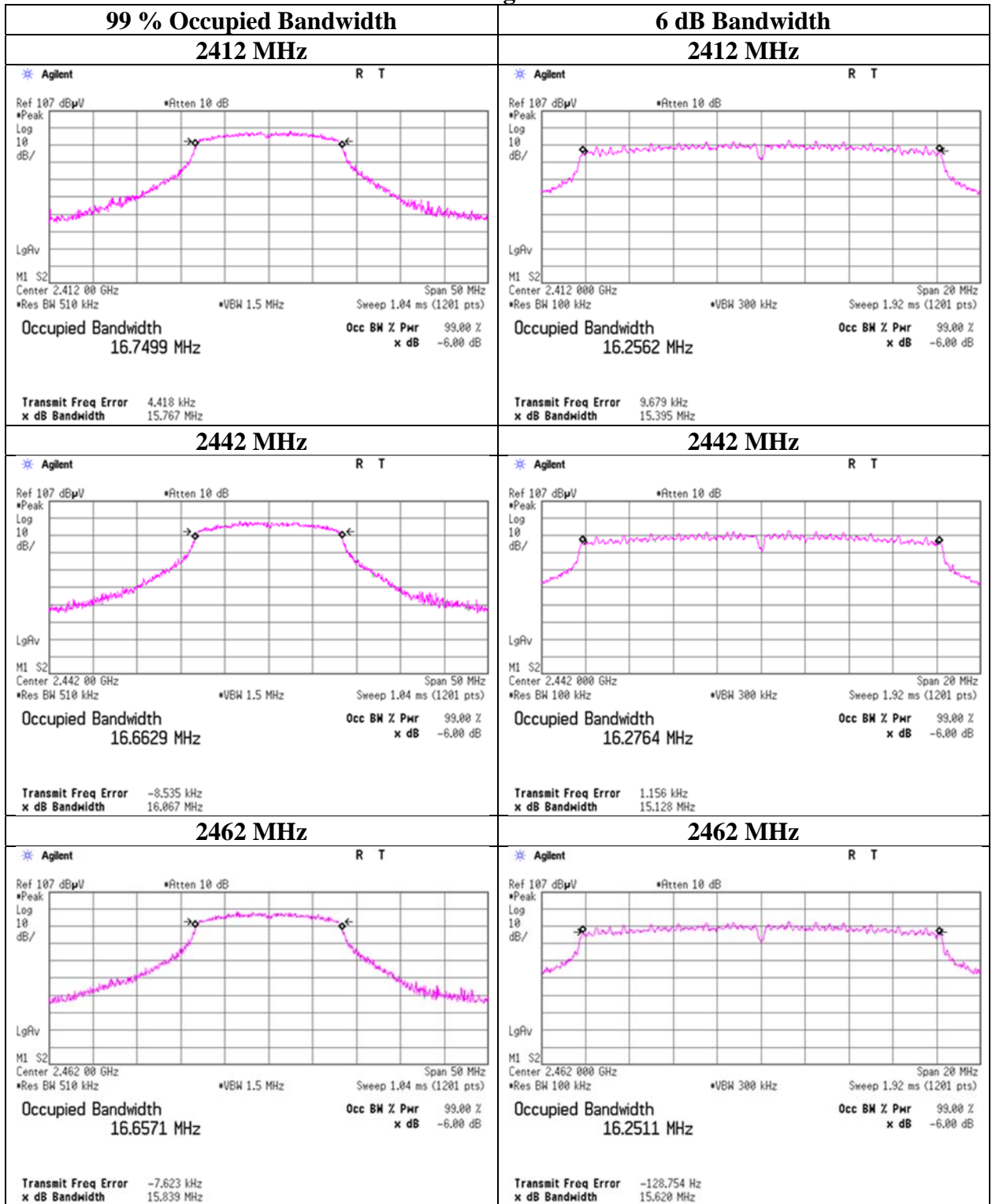

99 % Occupied Bandwidth and 6 dB Bandwidth

11g

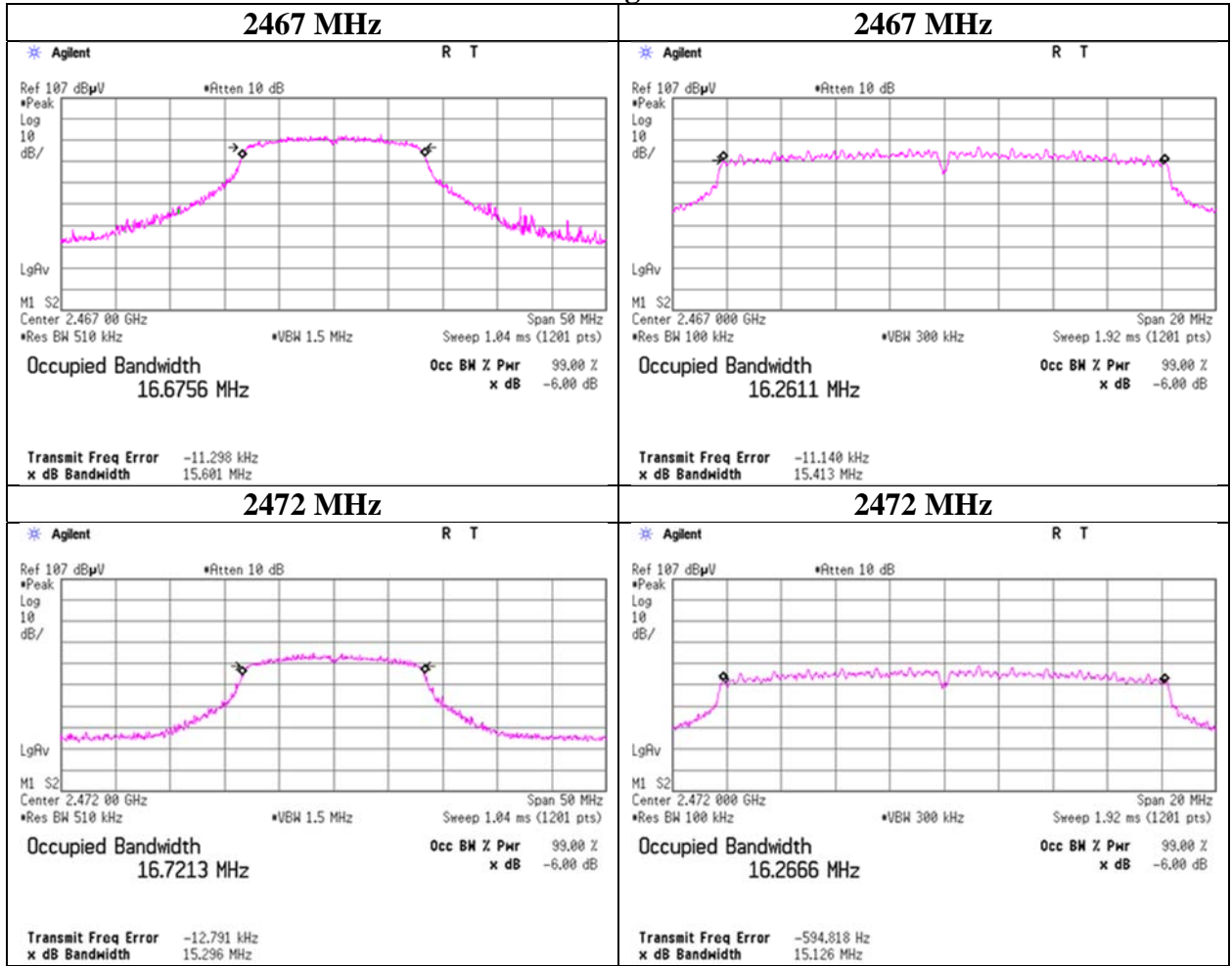

99 % Occupied Bandwidth and 6 dB Bandwidth

11n-20

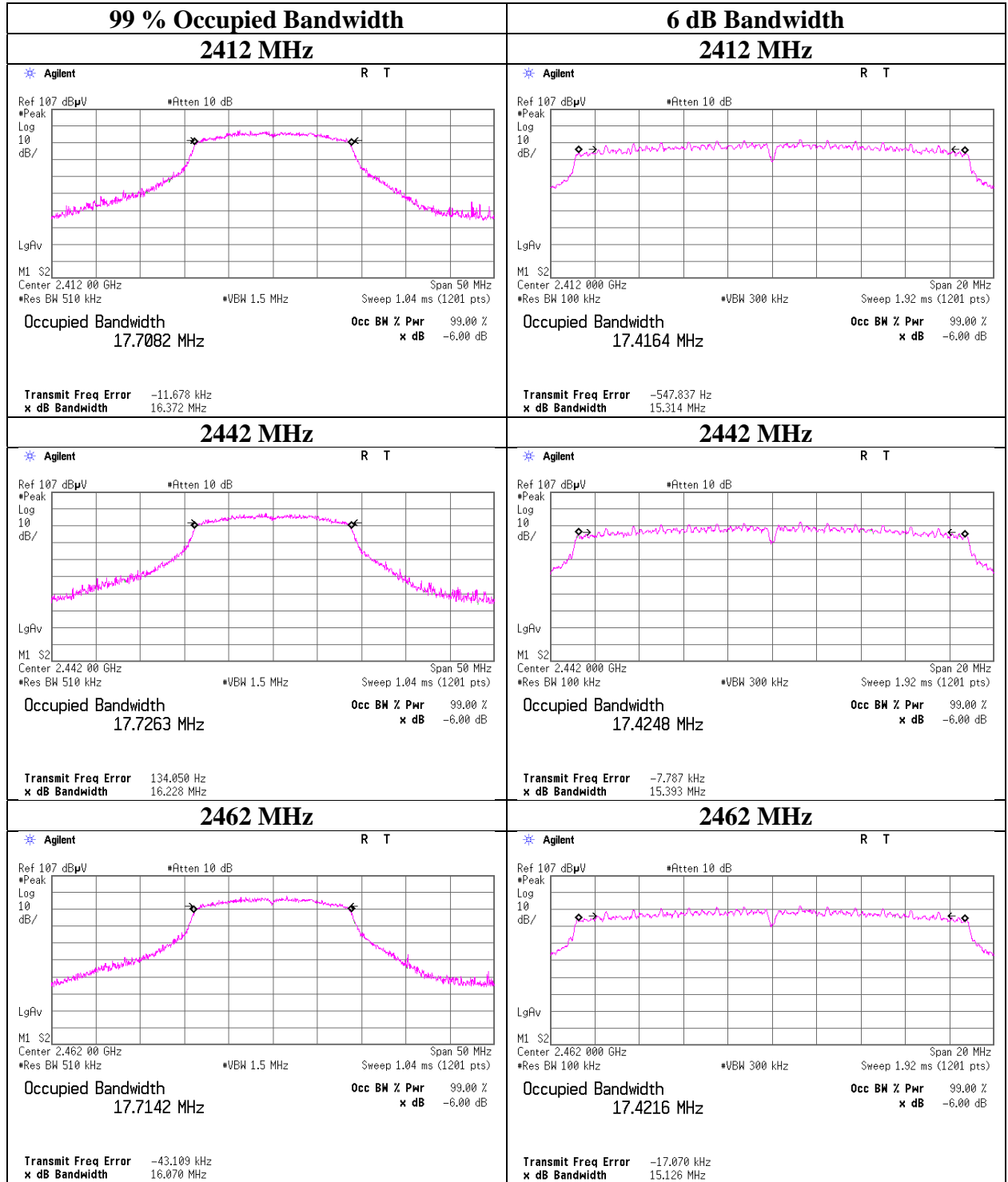

99 % Occupied Bandwidth and 6 dB Bandwidth

11n-20

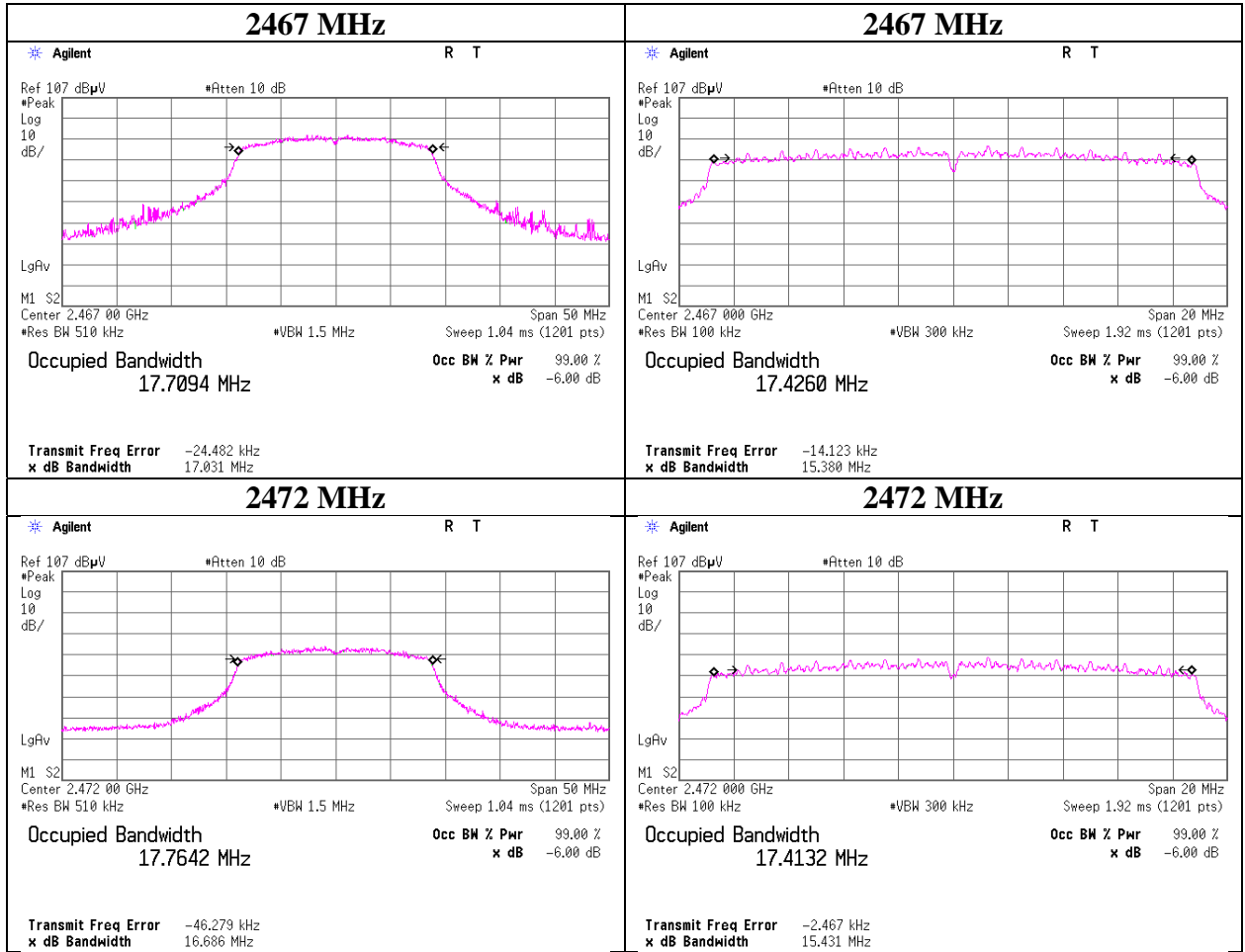

Maximum Peak Output Power

Test place	Ise EMC Lab. No.2 Shielded Room	
Date	May 9, 2022	May 12, 2022
Temperature / Humidity	25 deg. C / 55 % RH	23 deg. C / 64 % RH
Engineer	Kiyoshiro Okazaki	Kiyoshiro Okazaki
Mode	Tx 11b	

Antenna B				Conducted Power					e.i.r.p. for RSS-247					
Freq. [MHz]	Reading [dBm]	Cable Loss [dB]	Atten. Loss [dB]	Result		Limit		Margin [dB]	Antenna Gain [dBi]	Result		Limit		Margin [dB]
				[dBm]	[mW]	[dBm]	[mW]			[dBm]	[mW]	[dBm]	[mW]	
2412	-1.39	0.50	19.99	19.10	81.28	30.00	1000	10.90	3.20	22.30	169.82	36.02	4000	13.72
2442	-1.36	0.50	19.99	19.13	81.85	30.00	1000	10.87	3.20	22.33	171.00	36.02	4000	13.69
2462	-1.29	0.50	19.99	19.20	83.18	30.00	1000	10.80	3.20	22.40	173.78	36.02	4000	13.62
2472	-9.74	0.50	19.99	10.75	11.89	30.00	1000	19.25	3.20	13.95	24.83	36.02	4000	22.07

Sample Calculation:

Result = Reading + Cable Loss (including the cable(s) customer supplied) + Attenuator Loss

e.i.r.p. Result = Conducted Power Result + Antenna Gain

*The equipment and cables were not used for factor 0 dB of the data sheets.

2442MHz

Rate	Reading ANT-A	Reading ANT-B	Remark
[Mbps]	[dBm]	[dBm]	
1		-1.94	
2		-1.59	
5.5		-1.57	
11	-1.88	-1.36	*

*: Worst Rate

All comparison were carried out on same frequency and measurement factors.

Maximum Peak Output Power

Test place	Ise EMC Lab. No.2 Shielded Room	
Date	May 9, 2022	May 12, 2022
Temperature / Humidity	25 deg. C / 55 % RH	23 deg. C / 64 % RH
Engineer	Kiyoshiro Okazaki	Kiyoshiro Okazaki
Mode	Tx 11g	

Antenna B				Conducted Power					e.i.r.p. for RSS-247					
Freq. [MHz]	Reading [dBm]	Cable Loss [dB]	Atten. Loss [dB]	Result		Limit		Margin [dB]	Antenna Gain [dBi]	Result		Limit		Margin [dB]
				[dBm]	[mW]	[dBm]	[mW]			[dBm]	[mW]	[dBm]	[mW]	
2412	5.10	0.50	19.99	25.59	362.24	30.00	1000	4.41	3.20	28.79	756.83	36.02	4000	7.23
2442	5.16	0.50	19.99	25.65	367.28	30.00	1000	4.35	3.20	28.85	767.36	36.02	4000	7.17
2462	5.21	0.50	19.99	25.70	371.54	30.00	1000	4.30	3.20	28.90	776.25	36.02	4000	7.12
2467	0.62	0.50	19.99	21.11	129.12	30.00	1000	8.89	3.20	24.31	269.77	36.02	4000	11.71
2472	1.57	0.50	0.00	2.07	1.61	30.00	1000	27.93	3.20	5.27	3.37	36.02	4000	30.75

Sample Calculation:

Result = Reading + Cable Loss (including the cable(s) customer supplied) + Attenuator Loss

e.i.r.p. Result = Conducted Power Result + Antenna Gain

*The equipment and cables were not used for factor 0 dB of the data sheets.

2442 MHz

Rate [Mbps]	Reading ANT-A [dBm]	Reading ANT-B [dBm]	Remark
6		5.09	
9		5.10	
12		5.02	
18		4.86	
24		5.11	
36		5.13	
48		5.01	
54	4.49	5.16	*

*: Worst Rate

All comparison were carried out on same frequency and measurement factors.

Maximum Peak Output Power

Test place	Ise EMC Lab. No.2 Shielded Room	
Date	May 9, 2022	May 12, 2022
Temperature / Humidity	25 deg. C / 55 % RH	23 deg. C / 64 % RH
Engineer	Kiyoshiro Okazaki	Kiyoshiro Okazaki
Mode	Tx 11n-20	

Antenna B				Conducted Power					e.i.r.p. for RSS-247					
Freq. [MHz]	Reading [dBm]	Cable Loss [dB]	Atten. Loss [dB]	Result		Limit		Margin [dB]	Antenna Gain [dBi]	Result		Limit		Margin [dB]
				[dBm]	[mW]	[dBm]	[mW]			[dBm]	[mW]	[dBm]	[mW]	
2412	4.84	0.50	19.99	25.33	341.19	30.00	1000	4.67	3.20	28.53	712.85	36.02	4000	7.49
2442	4.71	0.50	19.99	25.20	331.13	30.00	1000	4.80	3.20	28.40	691.83	36.02	4000	7.62
2462	4.72	0.50	19.99	25.21	331.89	30.00	1000	4.79	3.20	28.41	693.43	36.02	4000	7.61
2467	0.50	0.50	19.99	20.99	125.60	30.00	1000	9.01	3.20	24.19	262.42	36.02	4000	11.83
2472	1.04	0.50	0.00	1.54	1.43	30.00	1000	28.46	3.20	4.74	2.98	36.02	4000	31.28

Sample Calculation:

Result = Reading + Cable Loss (including the cable(s) customer supplied) + Attenuator Loss

e.i.r.p. Result = Conducted Power Result + Antenna Gain

*The equipment and cables were not used for factor 0 dB of the data sheets.

2442 MHz, Long GI or Short GI

MCS Number	Reading ANT-A [dBm]	Reading ANT-B [dBm]	Remark
0		4.58	
1		4.32	
2		4.12	
3		4.47	
4		4.19	
5		4.64	
6		4.18	short
6	4.02	4.71	long *
7		4.44	

*: Worst MCS

All comparison were carried out on same frequency and measurement factors.

Average Output Power
(Reference data for RF Exposure)

Test place Ise EMC Lab. No.2 Shielded Room
Date May 12, 2022
Temperature / Humidity 23 deg. C / 64 % RH
Engineer Kiyoshiro Okazaki
Mode Tx

11b 1 Mbps

Freq. [MHz]	Reading [dBm]	Cable Loss [dB]	Atten. Loss [dB]	Result (Time average)		Duty factor [dB]	Result (Burst power average)	
				[dBm]	[mW]		[dBm]	[mW]
2412	-4.43	0.50	19.99	16.06	40.36	0.28	16.34	43.05
2442	-4.36	0.50	19.99	16.13	41.02	0.28	16.41	43.75
2462	-4.20	0.50	19.99	16.29	42.56	0.28	16.57	45.39
2472	6.96	0.50	0.00	7.46	5.57	0.28	7.74	5.94

11g 6 Mbps

Freq. [MHz]	Reading [dBm]	Cable Loss [dB]	Atten. Loss [dB]	Result (Time average)		Duty factor [dB]	Result (Burst power average)	
				[dBm]	[mW]		[dBm]	[mW]
2412	-5.94	0.50	19.99	14.55	28.51	0.44	14.99	31.55
2442	-5.84	0.50	19.99	14.65	29.17	0.44	15.09	32.28
2462	-5.79	0.50	19.99	14.70	29.51	0.44	15.14	32.66
2467	8.15	0.50	0.00	8.65	7.33	0.44	9.09	8.11
2472	-10.41	0.50	0.00	-9.91	0.10	0.44	-9.47	0.11

11n-20 MCS 0

Freq. [MHz]	Reading [dBm]	Cable Loss [dB]	Atten. Loss [dB]	Result (Time average)		Duty factor [dB]	Result (Burst power average)	
				[dBm]	[mW]		[dBm]	[mW]
2412	-6.85	0.50	19.99	13.64	23.12	0.32	13.96	24.89
2442	-6.79	0.50	19.99	13.70	23.44	0.32	14.02	25.23
2462	-6.76	0.50	19.99	13.73	23.60	0.32	14.05	25.41
2467	8.13	0.50	0.00	8.63	7.29	0.32	8.95	7.85
2472	-10.49	0.50	0.00	-9.99	0.10	0.32	-9.67	0.11

Sample Calculation:

Result (Time average) = Reading + Cable Loss (including the cable(s) customer supplied) + Attenuator Loss

Result (Burst power average) = Time average + Duty factor

*The equipment and cables were not used for factor 0 dB of the data sheets.

The average output power was measured with the lowest order modulation and lowest data rate configuration in each IEEE 802.11 mode based on KDB 248227 D01.

Burst rate confirmation

Test place Ise EMC Lab. No.2 Semi Anechoic Chamber
Date May 9, 2022
Temperature / Humidity 25 deg. C / 55 % RH
Engineer Kiyoshiro Okazaki
Mode Tx

11b 11 Mbps

11g 54 Mbps

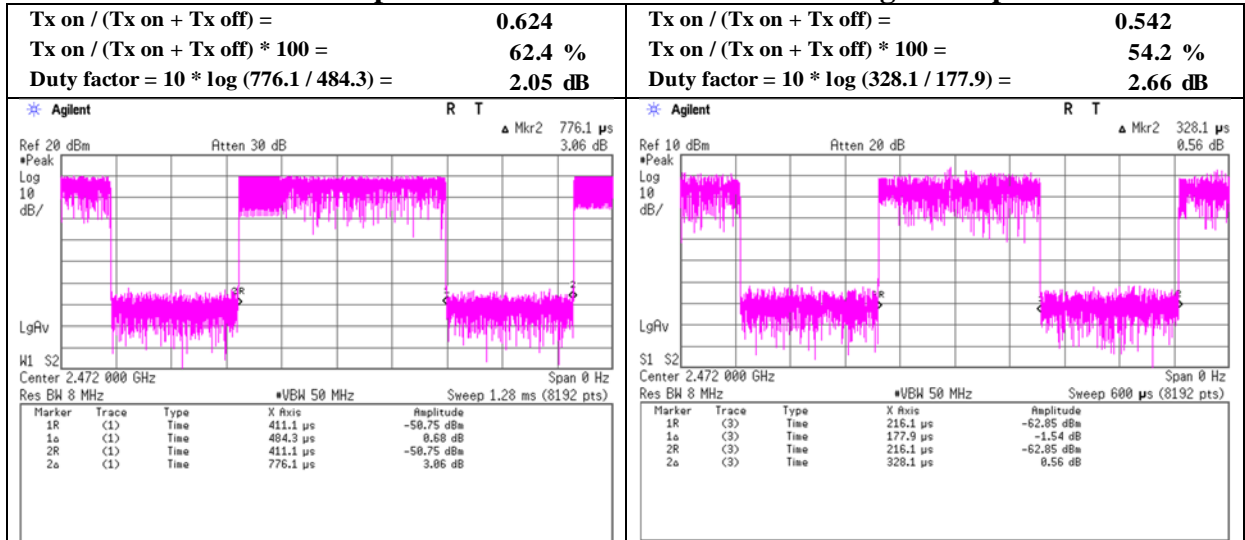

11n-20 MCS 6 long

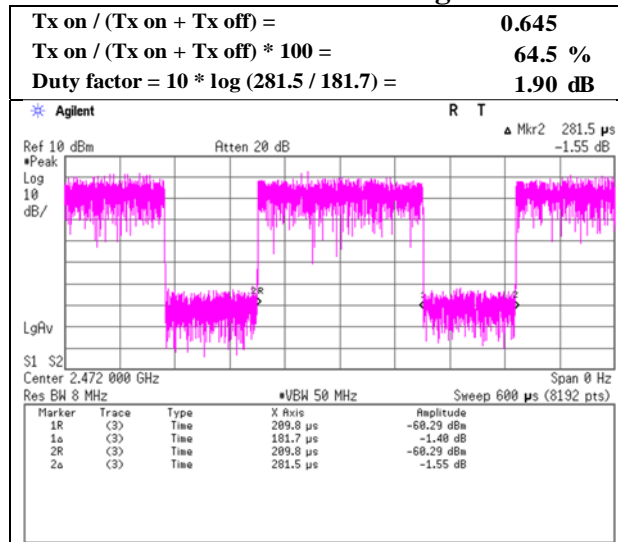

* Since the burst rate is not different between the channels, the data has been obtained on the representative channel.

Burst rate confirmation

Test place	Ise EMC Lab. No.2 Shielded Room
Date	May 12, 2022
Temperature / Humidity	23 deg. C / 64 % RH
Engineer	Kiyoshiro Okazaki
Mode	Tx

11b 1 Mbps

11g 6 Mbps

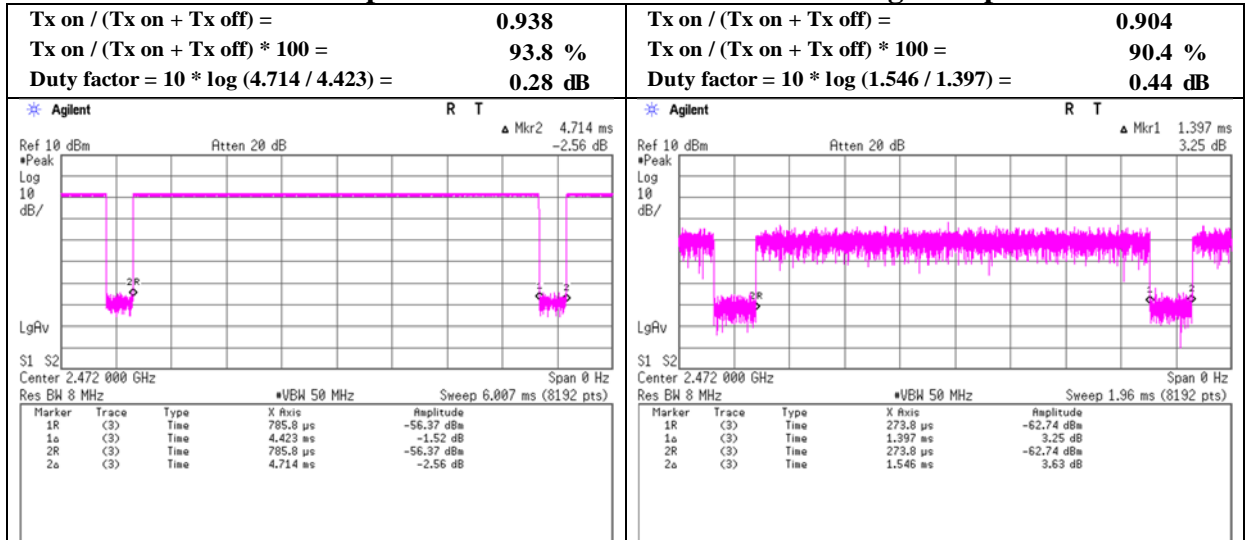

11n-20 MCS 0 long

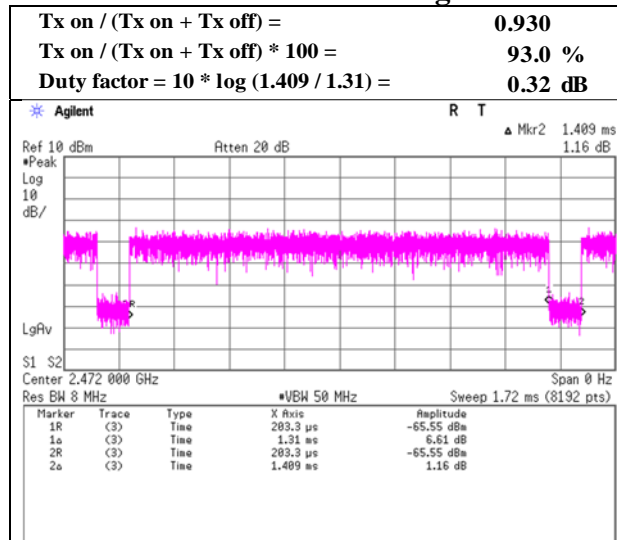

* Since the burst rate is not different between the channels, the data has been obtained on the representative channel.

Radiated Spurious Emission

Test place	Ise EMC Lab.	
Semi Anechoic Chamber	No.2	No.2
Date	May 9, 2022	May 11, 2022
Temperature / Humidity	25 deg. C / 40 % RH	24 deg. C / 52 % RH
Engineer	Sayaka Hara	Sayaka Hara
	(1 GHz - 10 GHz)	(10 GHz - 26.5 GHz)
Mode	Tx 11b 2412 MHz	

Polarity [Hori/Vert]	Frequency [MHz]	Reading (QP / PK) [dBuV]	Reading (AV) [dBuV]	Ant. Factor [dB/m]	Loss [dB]	Gain [dB]	Duty Factor [dB]	Result (QP / PK) [dBuV/m]	Result (AV) [dBuV/m]	Limit (QP / PK) [dBuV/m]	Limit (AV) [dBuV/m]	Margin (QP / PK) [dB]	Margin (AV) [dB]	Remark
Hori.	2390.0	62.5	51.5	27.6	4.7	34.9	2.1	60.0	51.0	73.9	53.9	13.9	2.9	*1)
Hori.	3618.0	47.4	39.1	29.2	6.9	34.2	2.1	49.4	43.1	73.9	53.9	24.6	10.8	
Hori.	4824.0	48.3	38.0	31.5	7.0	34.1	2.1	52.7	44.5	73.9	53.9	21.2	9.4	
Hori.	7236.0	44.3	33.5	35.9	8.4	34.1	-	54.6	43.7	73.9	53.9	19.3	10.2	Floor noise
Hori.	9648.0	44.5	33.5	38.8	8.9	34.7	-	57.6	46.6	73.9	53.9	16.3	7.3	Floor noise
Vert.	2390.0	61.1	49.6	27.6	4.7	34.9	2.1	58.6	49.1	73.9	53.9	15.3	4.8	*1)
Vert.	3618.0	49.1	43.3	29.2	6.9	34.2	2.1	51.0	47.3	73.9	53.9	22.9	6.6	
Vert.	4824.0	51.5	42.3	31.5	7.0	34.1	2.1	56.0	48.8	73.9	53.9	17.9	5.1	
Vert.	7236.0	44.4	33.4	35.9	8.4	34.1	-	54.7	43.7	73.9	53.9	19.3	10.2	Floor noise
Vert.	9648.0	45.3	35.7	38.8	8.9	34.7	2.1	58.4	50.8	73.9	53.9	15.6	3.1	

Result (QP / PK) = Reading + Ant Factor + Loss (Cable+Attenuator+Filter+Distance factor(above 1 GHz)) - Gain(Amplifier)

Result (AV)= Reading + Ant Factor + Loss (Cable+Attenuator+Filter+Distance factor(above 1 GHz)) - Gain(Amplifier) + Duty factor

*Other frequency noises omitted in this report were not seen or had enough margin (more than 20 dB).

*QP detector was used up to 1GHz.

*1) Not Out of Band emission(Leakage Power)

20dBc Data Sheet

Polarity [Hori/Vert]	Frequency [MHz]	Reading (PK) [dBuV]	Ant Factor [dB/m]	Loss [dB]	Gain [dB]	Result [dBuV/m]	Limit [dBuV/m]	Margin [dB]	Remark
Hori.	2412.0	110.1	27.5	4.8	34.9	107.6	-	-	Carrier
Hori.	2400.0	68.3	27.6	4.7	34.9	65.8	87.6	21.8	
Vert.	2412.0	109.1	27.5	4.8	34.9	106.5	-	-	Carrier
Vert.	2400.0	67.6	27.6	4.7	34.9	65.0	86.5	21.5	

Result = Reading + Ant Factor + Loss (Cable+Attenuator+Filter+Distance factor(above 1 GHz)) - Gain(Amplifier)

Distance factor: 1 GHz - 10 GHz 20log(3.65 m / 3.0 m) = 1.71 dB
 10 GHz - 26.5 GHz 20log(1.0 m / 3.0 m) = -9.5 dB

Radiated Spurious Emission (Reference Plot for band-edge)

Test place	Ise EMC Lab.
Semi Anechoic Chamber	No.2
Date	May 9, 2022
Temperature / Humidity	25 deg. C / 40 % RH
Engineer	Sayaka Hara
	(1 GHz - 10 GHz)
Mode	Tx 11b 2412 MHz

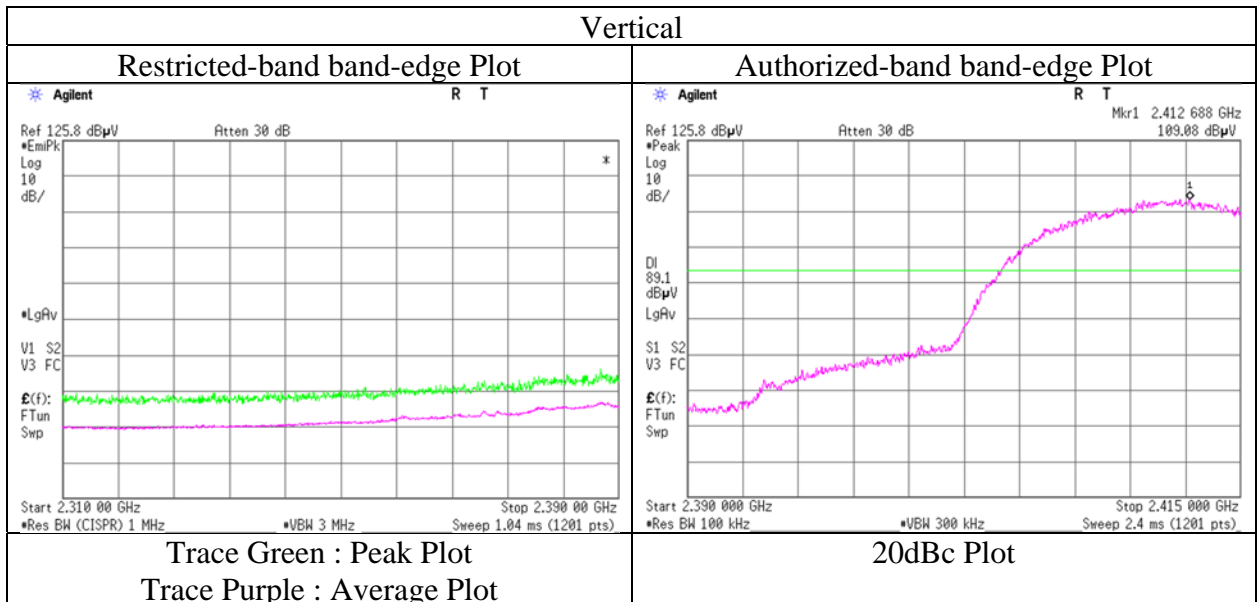
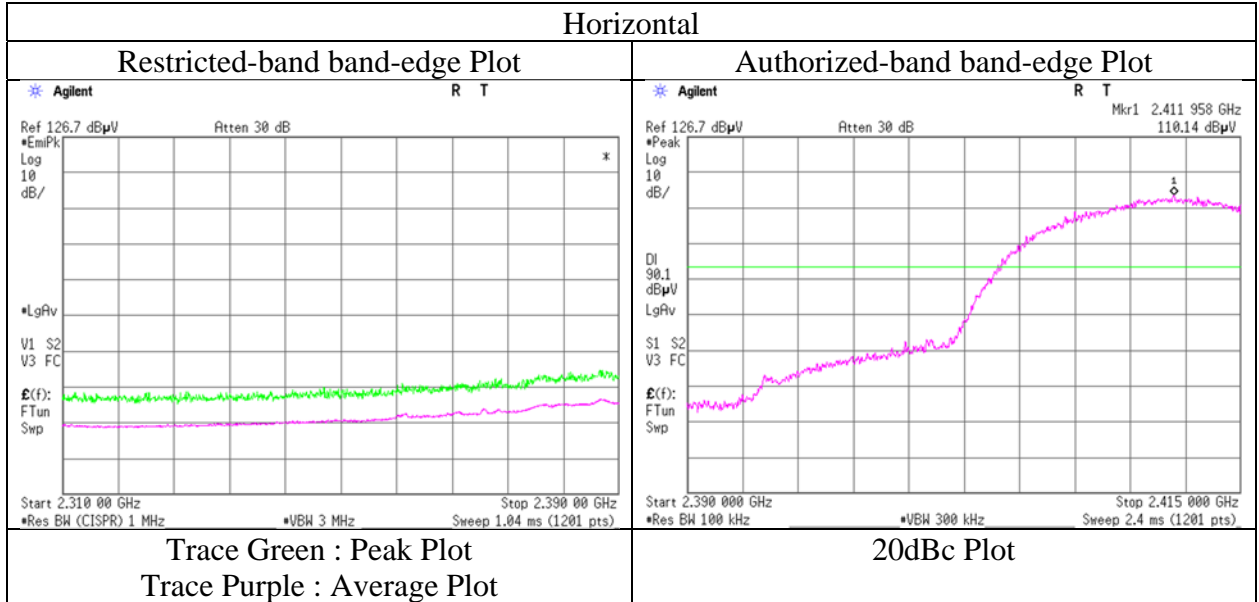

* The measurement was conducted for a sufficiently long enough time to detect any possible spurious emissions. Final result of restricted band edge was shown in tabular data.

Radiated Spurious Emission

Test place	Ise EMC Lab.	
Semi Anechoic Chamber	No.2	No.2
Date	May 9, 2022	May 11, 2022
Temperature / Humidity	25 deg. C / 40 % RH	24 deg. C / 52 % RH
Engineer	Sayaka Hara	Sayaka Hara
	(1 GHz - 10 GHz)	(10 GHz - 26.5 GHz)
Mode	Tx 11b 2442 MHz	

Polarity [Hori/Vert]	Frequency [MHz]	Reading (QP / PK) [dBuV]	Reading (AV) [dBuV]	Ant. Factor [dB/m]	Loss [dB]	Gain [dB]	Duty Factor [dB]	Result (QP / PK) [dBuV/m]	Result (AV) [dBuV/m]	Limit (QP / PK) [dBuV/m]	Limit (AV) [dBuV/m]	Margin (QP / PK) [dB]	Margin (AV) [dB]	Remark
Hori.	3663.0	48.1	41.0	29.3	6.9	34.2	2.1	50.1	45.0	73.9	53.9	23.8	8.9	
Hori.	4884.0	47.8	37.1	31.5	7.0	34.1	2.1	52.2	43.5	73.9	53.9	21.7	10.4	
Hori.	7326.0	44.0	33.3	36.0	8.4	34.1	-	54.4	43.7	73.9	53.9	19.5	10.2	Floor noise
Hori.	9768.0	44.6	33.7	39.1	9.0	34.7	-	58.0	47.1	73.9	53.9	15.9	6.8	Floor noise
Vert.	3663.0	50.3	45.5	29.3	6.9	34.2	2.1	52.3	49.5	73.9	53.9	21.7	4.4	
Vert.	4884.0	51.3	42.0	31.5	7.0	34.1	2.1	55.7	48.5	73.9	53.9	18.2	5.4	
Vert.	7326.0	44.6	33.3	36.0	8.4	34.1	-	55.0	43.7	73.9	53.9	18.9	10.2	Floor noise
Vert.	9768.0	44.5	34.5	39.1	9.0	34.7	-	57.8	47.8	73.9	53.9	16.1	6.1	Floor noise

Result (QP / PK) = Reading + Ant Factor + Loss (Cable+Attenuator+Filter+Distance factor(above 1 GHz)) - Gain(Amplifier)

Result (AV) = Reading + Ant Factor + Loss (Cable+Attenuator+Filter+Distance factor(above 1 GHz)) - Gain(Amplifier) + Duty factor

*Other frequency noises omitted in this report were not seen or had enough margin (more than 20 dB).

*QP detector was used up to 1GHz.

Distance factor: 1 GHz - 10 GHz $20\log(3.65\text{ m} / 3.0\text{ m}) = 1.71\text{ dB}$
 10 GHz - 26.5 GHz $20\log(1.0\text{ m} / 3.0\text{ m}) = -9.5\text{ dB}$

Radiated Spurious Emission

Test place	Ise EMC Lab.	
Semi Anechoic Chamber	No.2	No.2
Date	May 9, 2022	May 11, 2022
Temperature / Humidity	25 deg. C / 40 % RH	24 deg. C / 52 % RH
Engineer	Sayaka Hara	Sayaka Hara
	(1 GHz - 10 GHz)	(10 GHz - 26.5 GHz)
Mode	Tx 11b 2462 MHz	

Polarity [Hori/Vert]	Frequency [MHz]	Reading (QP / PK) [dBuV]	Reading (AV) [dBuV]	Ant. Factor [dB/m]	Loss [dB]	Gain [dB]	Duty Factor [dB]	Result (QP / PK) [dBuV/m]	Result (AV) [dBuV/m]	Limit (QP / PK) [dBuV/m]	Limit (AV) [dBuV/m]	Margin (QP / PK) [dB]	Margin (AV) [dB]	Remark
Hori.	2483.5	60.5	48.1	27.5	4.8	34.9	2.1	57.9	47.6	73.9	53.9	16.0	6.3	*1)
Hori.	3693.0	47.6	40.0	29.3	6.9	34.1	2.1	49.7	44.1	73.9	53.9	24.2	9.8	
Hori.	4924.0	48.5	37.8	31.5	7.0	34.1	2.1	52.9	44.3	73.9	53.9	21.0	9.6	
Hori.	7386.0	44.2	33.6	36.1	8.4	34.1	-	54.6	44.0	73.9	53.9	19.3	9.9	Floor noise
Hori.	9848.0	43.9	33.5	39.1	9.0	34.7	-	57.3	46.9	73.9	53.9	16.7	7.0	Floor noise
Vert.	2483.5	61.5	48.1	27.5	4.8	34.9	2.1	58.9	47.5	73.9	53.9	15.0	6.4	*1)
Vert.	3693.0	50.5	45.6	29.3	6.9	34.1	2.1	52.6	49.7	73.9	53.9	21.3	4.2	
Vert.	4924.0	50.6	41.2	31.5	7.0	34.1	2.1	55.0	47.6	73.9	53.9	18.9	6.3	
Vert.	7386.0	43.9	33.6	36.1	8.4	34.1	-	54.3	44.0	73.9	53.9	19.6	9.9	Floor noise
Vert.	9848.0	44.5	34.9	39.1	9.0	34.7	2.1	57.9	50.3	73.9	53.9	16.0	3.6	

Result (QP / PK) = Reading + Ant Factor + Loss (Cable+Attenuator+Filter+Distance factor(above 1 GHz)) - Gain(Amplifier)

Result (AV)= Reading + Ant Factor + Loss (Cable+Attenuator+Filter+Distance factor(above 1 GHz)) - Gain(Amplifier) + Duty factor

*Other frequency noises omitted in this report were not seen or had enough margin (more than 20 dB).

*QP detector was used up to 1GHz.

*1) Not Out of Band emission(Leakage Power)

Distance factor: 1 GHz - 10 GHz 20log(3.65 m / 3.0 m) = 1.71 dB
 10 GHz - 26.5 GHz 20log(1.0 m / 3.0 m) = -9.5 dB

Radiated Spurious Emission (Reference Plot for band-edge)

Test place Ise EMC Lab.
Semi Anechoic Chamber No.2
Date May 9, 2022
Temperature / Humidity 25 deg. C / 40 % RH
Engineer Sayaka Hara
 (1 GHz - 10 GHz)
Mode Tx 11b 2462 MHz

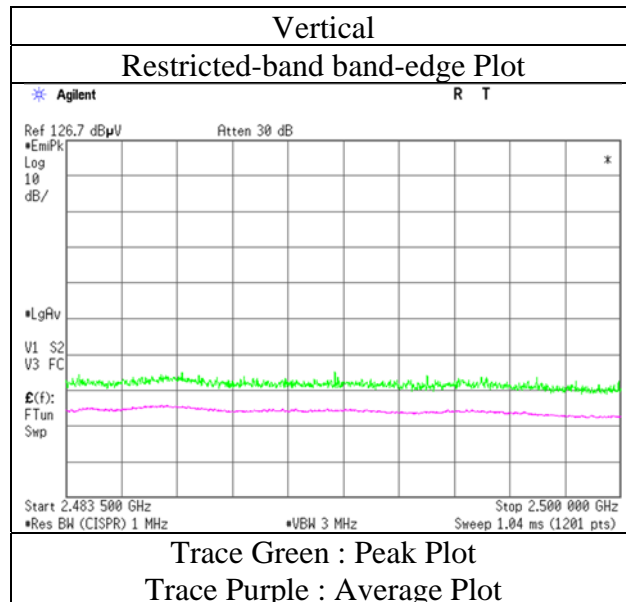
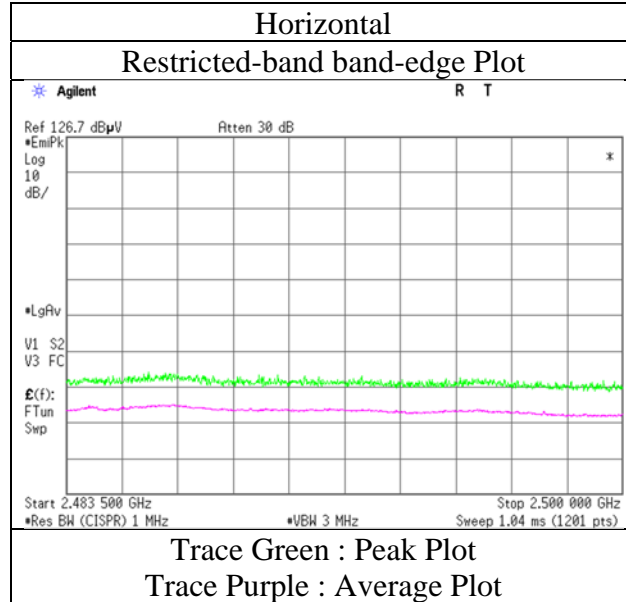

* The measurement was conducted for a sufficiently long enough time to detect any possible spurious emissions. Final result of restricted band edge was shown in tabular data.

Radiated Spurious Emission

Test place	Ise EMC Lab.	
Semi Anechoic Chamber	No.2	No.2
Date	May 9, 2022	May 11, 2022
Temperature / Humidity	25 deg. C / 40 % RH	24 deg. C / 52 % RH
Engineer	Sayaka Hara	Sayaka Hara
	(1 GHz - 10 GHz)	(10 GHz - 26.5 GHz)
Mode	Tx 11b 2472 MHz	

Polarity [Hori/Vert]	Frequency [MHz]	Reading (QP / PK) [dBuV]	Reading (AV) [dBuV]	Ant. Factor [dB/m]	Loss [dB]	Gain [dB]	Duty Factor [dB]	Result (QP / PK) [dBuV/m]	Result (AV) [dBuV/m]	Limit (QP / PK) [dBuV/m]	Limit (AV) [dBuV/m]	Margin (QP / PK) [dB]	Margin (AV) [dB]	Remark
Hori.	2483.5	65.0	53.3	27.5	4.8	34.9	2.1	62.4	52.8	73.9	53.9	11.5	1.1	*1),*2)
Hori.	3708.5	47.9	39.7	29.4	6.9	34.1	2.1	50.0	43.8	73.9	53.9	24.0	10.1	
Hori.	4944.0	43.4	32.8	31.5	7.1	34.1	-	47.9	37.2	73.9	53.9	26.0	16.7	Floor noise
Hori.	7416.0	44.6	33.6	36.1	8.4	34.2	-	55.0	44.0	73.9	53.9	19.0	9.9	Floor noise
Hori.	9888.0	44.1	33.7	39.1	9.0	34.7	-	57.5	47.0	73.9	53.9	16.4	6.9	Floor noise
Vert.	2483.5	65.4	53.4	27.5	4.8	34.9	2.1	62.8	52.9	73.9	53.9	11.1	1.1	*1),*2)
Vert.	3708.5	50.4	45.8	29.4	6.9	34.1	2.1	52.5	50.0	73.9	53.9	21.4	3.9	
Vert.	4944.0	43.7	33.6	31.5	7.1	34.1	2.1	48.1	40.1	73.9	53.9	25.8	13.8	
Vert.	7416.0	44.5	33.6	36.1	8.4	34.2	-	54.9	44.0	73.9	53.9	19.0	9.9	Floor noise
Vert.	9888.0	45.6	35.1	39.1	9.0	34.7	2.1	58.9	50.5	73.9	53.9	15.0	3.4	

Result (QP / PK) = Reading + Ant Factor + Loss (Cable+Attenuator+Filter+Distance factor(above 1 GHz)) - Gain(Amplifier)

Result (AV)= Reading + Ant Factor + Loss (Cable+Attenuator+Filter+Distance factor(above 1 GHz)) - Gain(Amplifier) + Duty factor

*Other frequency noises omitted in this report were not seen or had enough margin (more than 20 dB).

*QP detector was used up to 1GHz.

*1) Not Out of Band emission(Leakage Power)

*2) Integration method (AV only)

Distance factor: 1 GHz - 10 GHz $20\log(3.65\text{ m} / 3.0\text{ m}) = 1.71\text{ dB}$
 10 GHz - 26.5 GHz $20\log(1.0\text{ m} / 3.0\text{ m}) = -9.5\text{ dB}$

Radiated Spurious Emission (Reference Plot for band-edge)

Test place	Ise EMC Lab.
Semi Anechoic Chamber	No.2
Date	May 9, 2022
Temperature / Humidity	25 deg. C / 40 % RH
Engineer	Sayaka Hara (1 GHz - 10 GHz)
Mode	Tx 11b 2472 MHz

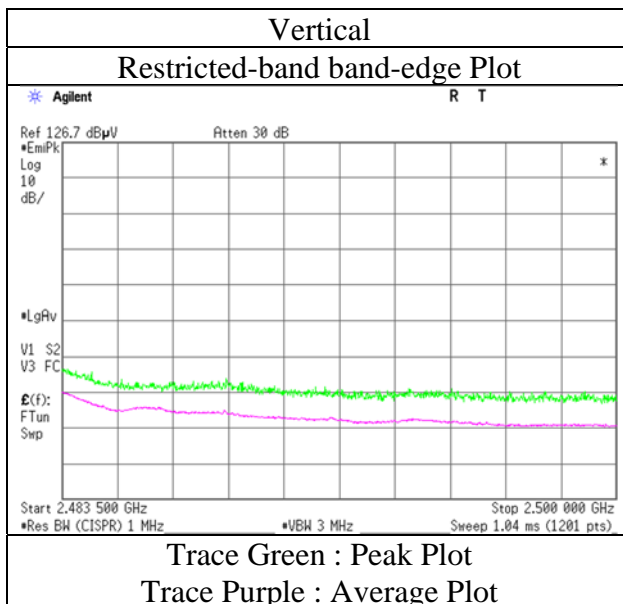
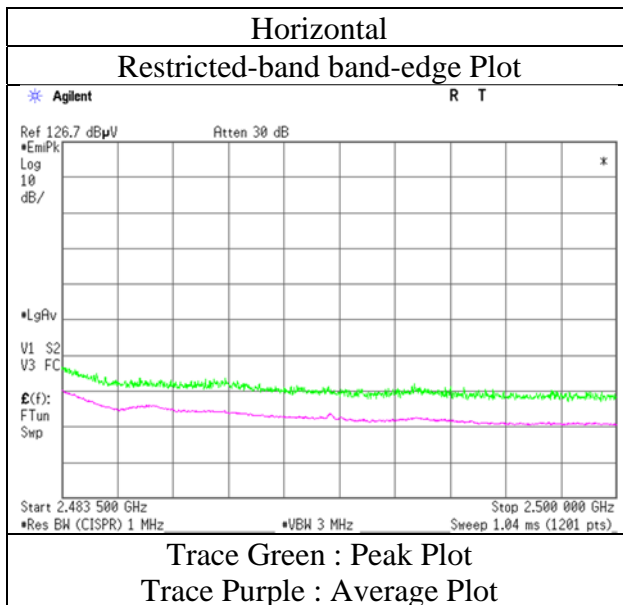

* The measurement was conducted for a sufficiently long enough time to detect any possible spurious emissions. Final result of restricted band edge was shown in tabular data.

Radiated Spurious Emission

Test place	Ise EMC Lab.	
Semi Anechoic Chamber	No.2	No.2
Date	May 9, 2022	May 11, 2022
Temperature / Humidity	25 deg. C / 40 % RH	24 deg. C / 52 % RH
Engineer	Sayaka Hara	Sayaka Hara
	(1 GHz - 10 GHz)	(10 GHz - 26.5 GHz)
Mode	Tx 11g 2412 MHz	

Polarity [Hori/Vert]	Frequency [MHz]	Reading (QP / PK) [dBuV]	Reading (AV) [dBuV]	Ant. Factor [dB/m]	Loss [dB]	Gain [dB]	Duty Factor [dB]	Result (QP / PK) [dBuV/m]	Result (AV) [dBuV/m]	Limit (QP / PK) [dBuV/m]	Limit (AV) [dBuV/m]	Margin (QP / PK) [dB]	Margin (AV) [dB]	Remark
Hori.	2390.0	73.6	53.3	27.6	4.7	34.9	2.7	71.0	53.4	73.9	53.9	2.9	0.5	*1)
Hori.	3618.1	47.5	40.5	29.2	6.9	34.2	2.7	49.4	45.1	73.9	53.9	24.5	8.8	
Hori.	4824.0	43.9	33.0	31.5	7.0	34.1	-	48.3	37.4	73.9	53.9	25.6	16.5	Floor noise
Hori.	7236.0	44.3	33.5	35.9	8.4	34.1	-	54.6	43.7	73.9	53.9	19.4	10.2	Floor noise
Hori.	9648.0	44.5	33.5	38.8	8.9	34.7	-	57.6	46.6	73.9	53.9	16.3	7.3	Floor noise
Vert.	2390.0	74.2	52.5	27.6	4.7	34.9	2.7	71.6	52.6	73.9	53.9	2.3	1.3	*1)
Vert.	3618.1	49.8	44.9	29.2	6.9	34.2	2.7	51.7	49.5	73.9	53.9	22.2	4.4	
Vert.	4824.0	48.1	36.9	31.5	7.0	34.1	2.7	52.5	44.0	73.9	53.9	21.4	10.0	
Vert.	7236.0	44.4	33.4	35.9	8.4	34.1	-	54.6	43.6	73.9	53.9	19.3	10.3	Floor noise
Vert.	9648.0	45.1	35.2	38.8	8.9	34.7	2.7	58.2	51.0	73.9	53.9	15.7	2.9	

Result (QP / PK) = Reading + Ant Factor + Loss (Cable+Attenuator+Filter+Distance factor(above 1 GHz)) - Gain(Amplifier)

Result (AV)= Reading + Ant Factor + Loss (Cable+Attenuator+Filter+Distance factor(above 1 GHz)) - Gain(Amplifier) + Duty factor

*Other frequency noises omitted in this report were not seen or had enough margin (more than 20 dB).

*QP detector was used up to 1GHz.

*1) Not Out of Band emission(Leakage Power)

20dBc Data Sheet

Polarity [Hori/Vert]	Frequency [MHz]	Reading (PK) [dBuV]	Ant Factor [dB/m]	Loss [dB]	Gain [dB]	Result [dBuV/m]	Limit [dBuV/m]	Margin [dB]	Remark
Hori.	2412.0	107.1	27.5	4.8	34.9	104.5	-	-	Carrier
Hori.	2400.0	72.8	27.6	4.7	34.9	70.2	84.5	14.2	
Vert.	2412.0	106.5	27.5	4.8	34.9	103.9	-	-	Carrier
Vert.	2400.0	72.5	27.6	4.7	34.9	70.0	83.9	14.0	

Result = Reading + Ant Factor + Loss (Cable+Attenuator+Filter+Distance factor(above 1 GHz)) - Gain(Amplifier)

Distance factor: 1 GHz - 10 GHz 20log(3.65 m / 3.0 m) = 1.71 dB
 10 GHz - 26.5 GHz 20log(1.0 m / 3.0 m) = -9.5 dB

Radiated Spurious Emission (Reference Plot for band-edge)

Test place	Ise EMC Lab.
Semi Anechoic Chamber	No.2
Date	May 9, 2022
Temperature / Humidity	25 deg. C / 40 % RH
Engineer	Sayaka Hara
	(1 GHz - 10 GHz)
Mode	Tx 11g 2412 MHz

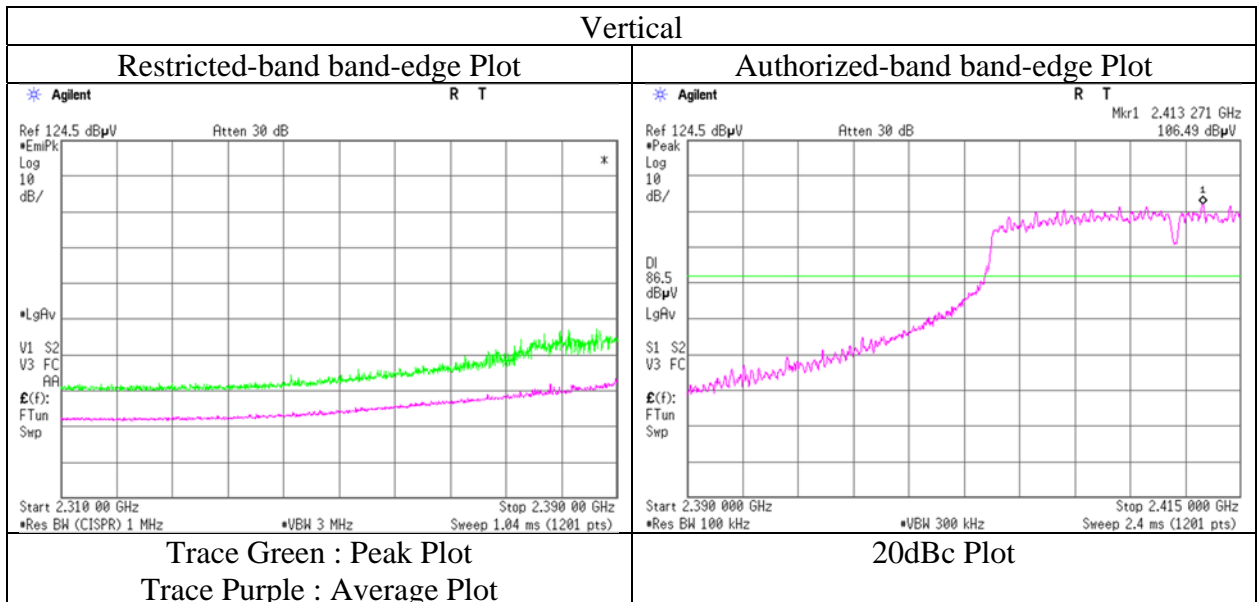
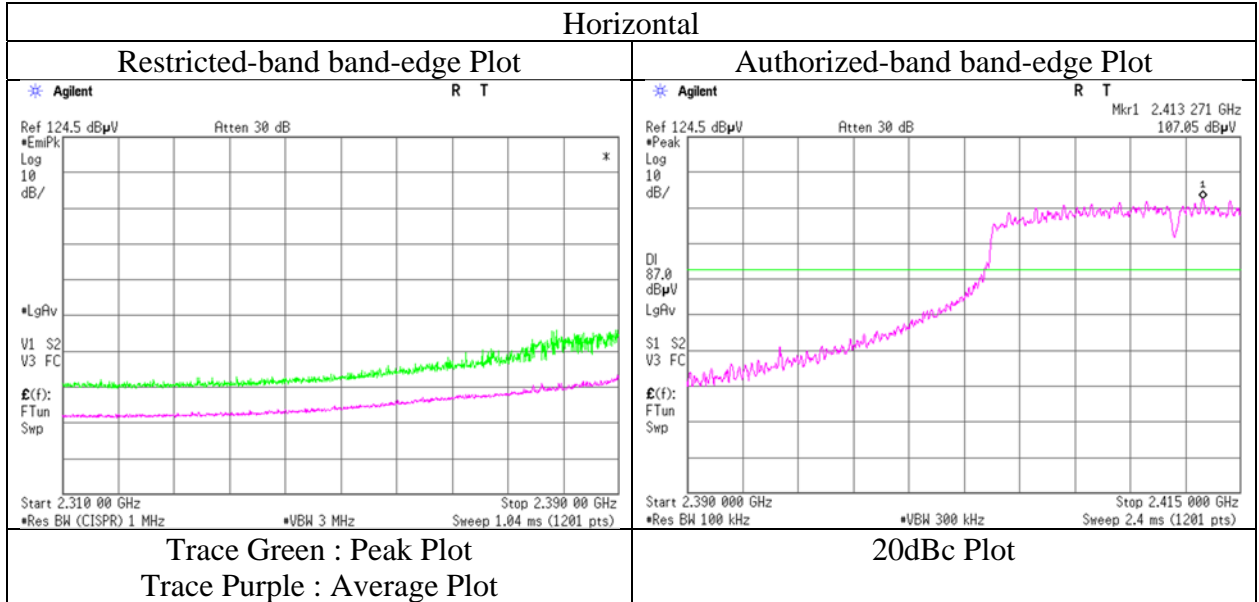

* The measurement was conducted for a sufficiently long enough time to detect any possible spurious emissions. Final result of restricted band edge was shown in tabular data.

Radiated Spurious Emission

Test place	Ise EMC Lab.	
Semi Anechoic Chamber	No.2	No.2
Date	May 9, 2022	May 11, 2022
Temperature / Humidity	25 deg. C / 40 % RH	24 deg. C / 52 % RH
Engineer	Sayaka Hara	Sayaka Hara
	(1 GHz - 10 GHz)	(10 GHz - 26.5 GHz)
Mode	Tx 11g 2442 MHz	

Polarity [Hori/Vert]	Frequency [MHz]	Reading (QP / PK) [dBuV]	Reading (AV) [dBuV]	Ant. Factor [dB/m]	Loss [dB]	Gain [dB]	Duty Factor [dB]	Result (QP / PK) [dBuV/m]	Result (AV) [dBuV/m]	Limit (QP / PK) [dBuV/m]	Limit (AV) [dBuV/m]	Margin (QP / PK) [dB]	Margin (AV) [dB]	Remark
Hori.	3663.0	48.2	41.0	29.3	6.9	34.2	2.7	50.2	45.7	73.9	53.9	23.7	8.2	
Hori.	4884.0	43.9	33.2	31.5	7.0	34.1	-	48.3	37.6	73.9	53.9	25.6	16.3	Floor noise
Hori.	7326.0	44.0	33.3	36.0	8.4	34.1	-	54.4	43.7	73.9	53.9	19.5	10.3	Floor noise
Hori.	9768.0	44.6	33.7	39.1	9.0	34.7	-	58.0	47.1	73.9	53.9	16.0	6.8	Floor noise
Vert.	3663.0	50.4	45.4	29.3	6.9	34.2	2.7	52.4	50.0	73.9	53.9	21.6	3.9	
Vert.	4884.0	47.2	36.1	31.5	7.0	34.1	2.7	51.6	43.1	73.9	53.9	22.3	10.8	
Vert.	7326.0	44.0	33.3	36.0	8.4	34.1	-	54.3	43.7	73.9	53.9	19.6	10.2	Floor noise
Vert.	9768.0	44.9	35.7	39.1	9.0	34.7	2.7	58.3	51.7	73.9	53.9	15.6	2.2	

Result (QP / PK) = Reading + Ant Factor + Loss (Cable+Attenuator+Filter+Distance factor(above 1 GHz)) - Gain(Amplifier)

Result (AV)= Reading + Ant Factor + Loss (Cable+Attenuator+Filter+Distance factor(above 1 GHz)) - Gain(Amplifier) + Duty factor

*Other frequency noises omitted in this report were not seen or had enough margin (more than 20 dB).

*QP detector was used up to 1GHz.

Distance factor: 1 GHz - 10 GHz 20log(3.65 m / 3.0 m) = 1.71 dB
 10 GHz - 26.5 GHz 20log(1.0 m / 3.0 m) = -9.5 dB

Radiated Spurious Emission

Test place	Ise EMC Lab.		
Semi Anechoic Chamber	No.2	No.2	No.2
Date	May 10, 2022	May 11, 2022	May 15, 2022
Temperature / Humidity	24 deg. C / 54 % RH	24 deg. C / 52 % RH	23 deg. C / 53 % RH
Engineer	Kiyoshiro Okazaki (1 GHz - 10 GHz)	Sayaka Hara (10 GHz - 26.5 GHz)	Kiyoshiro Okazaki (Below 1 GHz)
Mode	Tx 11g 2462 MHz		

Polarity [Hori/Vert]	Frequency [MHz]	Reading (QP / PK) [dBuV]	Reading (AV) [dBuV]	Ant. Factor [dB/m]	Loss [dB]	Gain [dB]	Duty Factor [dB]	Result (QP / PK) [dBuV/m]	Result (AV) [dBuV/m]	Limit (QP / PK) [dBuV/m]	Limit (AV) [dBuV/m]	Margin (QP / PK) [dB]	Margin (AV) [dB]	Remark
Hori.	43.3	24.0	-	13.9	6.9	28.5	-	16.2	-	40.0	-	23.8	-	
Hori.	94.9	25.0	-	9.4	7.4	28.4	-	13.4	-	43.5	-	30.1	-	
Hori.	110.2	23.0	-	11.8	7.5	28.4	-	13.9	-	43.5	-	29.6	-	
Hori.	384.0	29.2	-	15.6	9.5	28.4	-	25.9	-	46.0	-	20.1	-	
Hori.	406.4	26.6	-	16.5	9.6	28.5	-	24.1	-	46.0	-	21.9	-	
Hori.	995.4	22.7	-	22.5	11.5	28.5	-	28.2	-	53.9	-	25.7	-	
Hori.	2483.5	70.3	52.3	27.5	4.8	34.9	2.7	67.7	52.3	73.9	53.9	6.2	1.6	*1),*2)
Hori.	3692.9	47.6	41.8	29.3	6.9	34.1	2.7	49.7	46.5	73.9	53.9	24.3	7.4	
Hori.	4924.0	43.3	33.0	31.5	7.0	34.1	-	47.7	37.4	73.9	53.9	26.2	16.5	Floor noise
Hori.	7386.0	44.1	33.6	36.1	8.4	34.1	-	54.5	44.0	73.9	53.9	19.4	9.9	Floor noise
Hori.	9848.0	43.8	33.6	39.1	9.0	34.7	-	57.2	46.9	73.9	53.9	16.7	7.0	Floor noise
Vert.	43.3	26.7	-	13.9	6.9	28.5	-	18.9	-	40.0	-	21.1	-	
Vert.	94.9	35.0	-	9.4	7.4	28.4	-	23.4	-	43.5	-	20.1	-	
Vert.	110.2	30.5	-	11.8	7.5	28.4	-	21.4	-	43.5	-	22.1	-	
Vert.	384.0	29.5	-	15.6	9.5	28.4	-	26.2	-	46.0	-	19.8	-	
Vert.	406.2	33.6	-	16.5	9.6	28.5	-	31.1	-	46.0	-	14.9	-	
Vert.	995.2	22.7	-	22.5	11.5	28.5	-	28.2	-	53.9	-	25.7	-	
Vert.	2483.5	70.6	52.0	27.5	4.8	34.9	2.7	68.1	52.1	73.9	53.9	5.9	1.8	*1),*2)
Vert.	3692.9	50.1	45.7	29.3	6.9	34.1	2.7	52.2	50.4	73.9	53.9	21.7	3.5	
Vert.	4924.0	47.1	35.6	31.5	7.0	34.1	2.7	51.5	42.7	73.9	53.9	22.4	11.2	
Vert.	7386.0	44.1	33.6	36.1	8.4	34.1	-	54.5	44.0	73.9	53.9	19.4	9.9	Floor noise
Vert.	9848.0	45.5	35.2	39.1	9.0	34.7	2.7	58.9	51.2	73.9	53.9	15.0	2.7	

Result (QP / PK) = Reading + Ant Factor + Loss (Cable+Attenuator+Filter+Distance factor(above 1 GHz)) - Gain(Amplifier)

Result (AV) = Reading + Ant Factor + Loss (Cable+Attenuator+Filter+Distance factor(above 1 GHz)) - Gain(Amplifier) + Duty factor

*Other frequency noises omitted in this report were not seen or had enough margin (more than 20 dB).

*QP detector was used up to 1GHz.

*1) Not Out of Band emission(Leakage Power)

*2) Integration method (AV only)

Distance factor: 1 GHz - 10 GHz 20log(3.65 m / 3.0 m) = 1.71 dB
 10 GHz - 26.5 GHz 20log(1.0 m / 3.0 m) = -9.5 dB

Radiated Spurious Emission (Reference Plot for band-edge)

Test place Ise EMC Lab.
Semi Anechoic Chamber No.2
Date May 10, 2022
Temperature / Humidity 24 deg. C / 54 % RH
Engineer Kiyoshiro Okazaki
 (1 GHz - 10 GHz)
Mode Tx 11g 2462 MHz

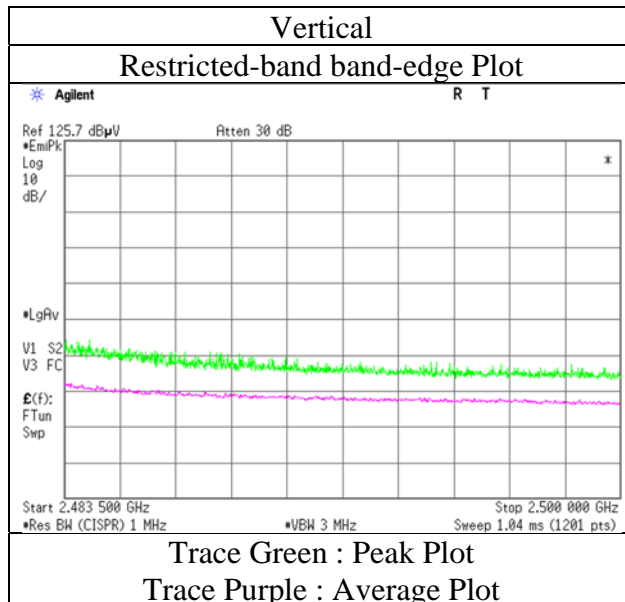
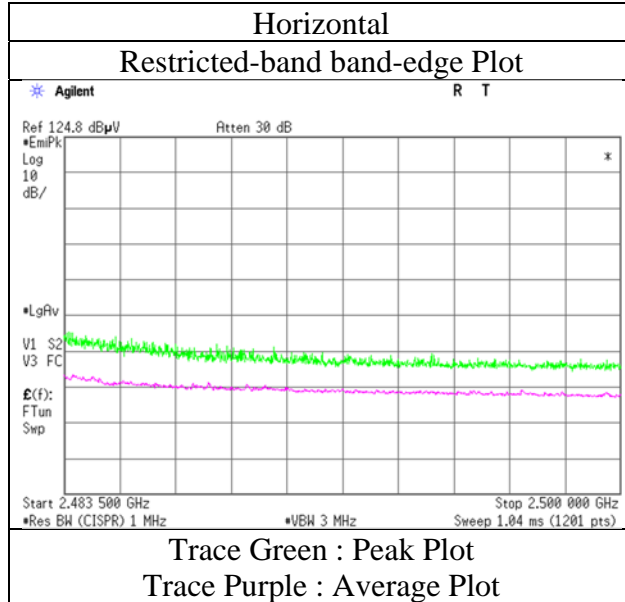

* The measurement was conducted for a sufficiently long enough time to detect any possible spurious emissions. Final result of restricted band edge was shown in tabular data.

Radiated Spurious Emission

Test place	Ise EMC Lab.	
Semi Anechoic Chamber	No.2	No.2
Date	May 10, 2022	May 11, 2022
Temperature / Humidity	24 deg. C / 54 % RH	24 deg. C / 52 % RH
Engineer	Kiyoshiro Okazaki (1 GHz - 10 GHz)	Sayaka Hara (10 GHz - 26.5 GHz)
Mode	Tx 11g 2467 MHz	

Polarity [Hori/Vert]	Frequency [MHz]	Reading (QP / PK) [dBuV]	Reading (AV) [dBuV]	Ant. Factor [dB/m]	Loss [dB]	Gain [dB]	Duty Factor [dB]	Result (QP / PK) [dBuV/m]	Result (AV) [dBuV/m]	Limit (QP / PK) [dBuV/m]	Limit (AV) [dBuV/m]	Margin (QP / PK) [dB]	Margin (AV) [dB]	Remark
Hori.	2483.5	70.2	51.5	27.5	4.8	34.9	2.7	67.6	51.6	73.9	53.9	6.3	2.3	*1),*2)
Hori.	3700.1	47.5	40.9	29.3	6.9	34.1	2.7	49.6	45.7	73.9	53.9	24.3	8.2	
Hori.	4934.0	42.8	33.2	31.5	7.0	34.1	-	47.2	37.7	73.9	53.9	26.7	16.2	Floor noise
Hori.	7401.0	43.4	34.1	36.1	8.4	34.1	-	53.8	44.5	73.9	53.9	20.1	9.4	Floor noise
Hori.	9868.0	43.6	34.1	39.1	9.0	34.7	-	57.0	47.5	73.9	53.9	16.9	6.4	Floor noise
Vert.	2483.5	70.0	49.6	27.5	4.8	34.9	2.7	67.4	49.7	73.9	53.9	6.5	4.2	*1),*2)
Vert.	3700.1	51.5	45.1	29.3	6.9	34.1	2.7	53.6	49.8	73.9	53.9	20.4	4.1	
Vert.	4934.0	42.8	33.2	31.5	7.0	34.1	-	47.3	37.6	73.9	53.9	26.6	16.3	Floor noise
Vert.	7401.0	43.5	34.2	36.1	8.4	34.1	-	53.9	44.6	73.9	53.9	20.0	9.4	Floor noise
Vert.	9868.0	44.2	35.5	39.1	9.0	34.7	2.7	57.6	51.5	73.9	53.9	16.3	2.4	

Result (QP / PK) = Reading + Ant Factor + Loss (Cable+Attenuator+Filter+Distance factor(above 1 GHz)) - Gain(Amplifier)

Result (AV)= Reading + Ant Factor + Loss (Cable+Attenuator+Filter+Distance factor(above 1 GHz)) - Gain(Amplifier) + Duty factor

*Other frequency noises omitted in this report were not seen or had enough margin (more than 20 dB).

*QP detector was used up to 1GHz.

*1) Not Out of Band emission(Leakage Power)

*2) Integration method (AV only)

Distance factor:	1 GHz - 10 GHz	20log(3.65 m / 3.0 m) = 1.71 dB
	10 GHz - 26.5 GHz	20log(1.0 m / 3.0 m) = -9.5 dB

Radiated Spurious Emission (Reference Plot for band-edge)

Test place Ise EMC Lab.
Semi Anechoic Chamber No.2
Date May 10, 2022
Temperature / Humidity 24 deg. C / 54 % RH
Engineer Kiyoshiro Okazaki
 (1 GHz - 10 GHz)
Mode Tx 11g 2467 MHz

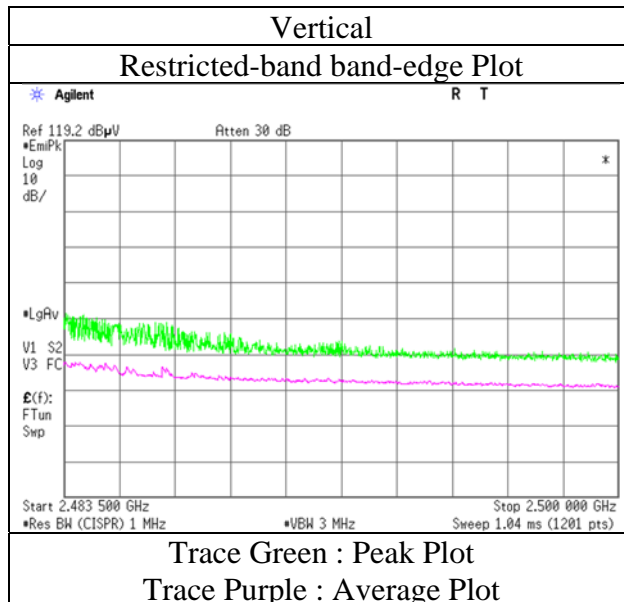
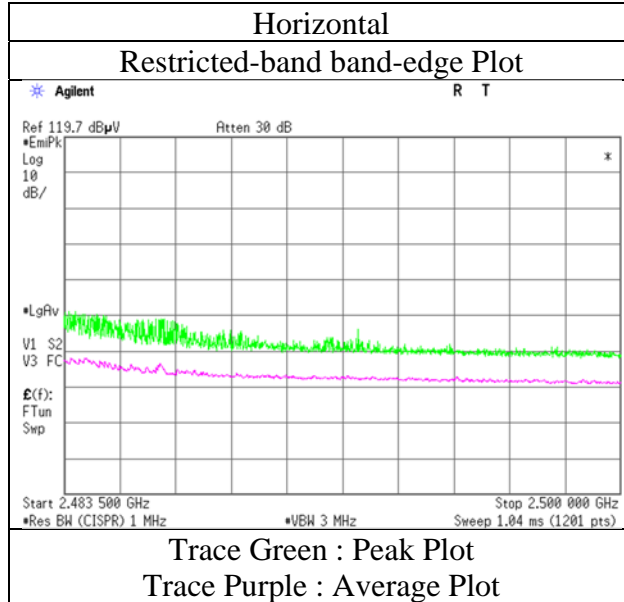

* The measurement was conducted for a sufficiently long enough time to detect any possible spurious emissions. Final result of restricted band edge was shown in tabular data.

Radiated Spurious Emission

Test place	Ise EMC Lab.	
Semi Anechoic Chamber	No.2	No.2
Date	May 10, 2022	May 11, 2022
Temperature / Humidity	24 deg. C / 54 % RH	24 deg. C / 52 % RH
Engineer	Kiyoshiro Okazaki (1 GHz - 10 GHz)	Sayaka Hara (10 GHz - 26.5 GHz)
Mode	Tx 11g 2472 MHz	

Polarity	Frequency	Reading (QP / PK)	Reading (AV)	Ant. Factor	Loss	Gain	Duty Factor	Result (QP / PK)	Result (AV)	Limit (QP / PK)	Limit (AV)	Margin (QP / PK)	Margin (AV)	Remark
[Hori/Vert]	[MHz]	[dBuV]	[dBuV]	[dB/m]	[dB]	[dB]	[dB]	[dBuV/m]	[dBuV/m]	[dBuV/m]	[dBuV/m]	[dB]	[dB]	
Hori.	2483.5	64.4	51.6	27.5	4.8	34.9	2.7	61.8	51.6	73.9	53.9	12.1	2.3	*1)
Hori.	3707.6	45.8	39.4	29.4	6.9	34.1	2.7	47.9	44.2	73.9	53.9	26.0	9.7	
Hori.	4944.0	43.1	33.2	31.5	7.1	34.1	-	47.6	37.7	73.9	53.9	26.3	16.2	Floor noise
Hori.	7416.0	43.3	33.5	36.1	8.4	34.2	-	53.7	43.9	73.9	53.9	20.2	10.0	Floor noise
Hori.	9888.0	43.5	34.3	39.1	9.0	34.7	-	56.9	47.7	73.9	53.9	17.0	6.2	Floor noise
Vert.	2483.5	65.0	51.7	27.5	4.8	34.9	2.7	62.4	51.8	73.9	53.9	11.5	2.1	*1)
Vert.	3707.6	50.2	46.2	29.4	6.9	34.1	2.7	52.3	50.9	73.9	53.9	21.6	3.0	
Vert.	4944.0	43.2	33.5	31.5	7.1	34.1	-	47.7	37.9	73.9	53.9	26.2	16.0	Floor noise
Vert.	7416.0	43.4	34.3	36.1	8.4	34.2	-	53.8	44.7	73.9	53.9	20.1	9.2	Floor noise
Vert.	9888.0	44.6	36.0	39.1	9.0	34.7	2.7	58.0	52.0	73.9	53.9	15.9	1.9	

Result (QP / PK) = Reading + Ant Factor + Loss (Cable+Attenuator+Filter+Distance factor(above 1 GHz)) - Gain(Amplifier)

Result (AV)= Reading + Ant Factor + Loss (Cable+Attenuator+Filter+Distance factor(above 1 GHz)) - Gain(Amplifier) + Duty factor

*Other frequency noises omitted in this report were not seen or had enough margin (more than 20 dB).

*QP detector was used up to 1GHz.

*1) Not Out of Band emission(Leakage Power)

Distance factor:	1 GHz - 10 GHz	20log(3.65 m / 3.0 m) = 1.71 dB
	10 GHz - 26.5 GHz	20log(1.0 m / 3.0 m) = -9.5 dB

Radiated Spurious Emission (Reference Plot for band-edge)

Test place Ise EMC Lab.
Semi Anechoic Chamber No.2
Date May 10, 2022
Temperature / Humidity 24 deg. C / 54 % RH
Engineer Kiyoshiro Okazaki
 (1 GHz - 10 GHz)
Mode Tx 11g 2472 MHz

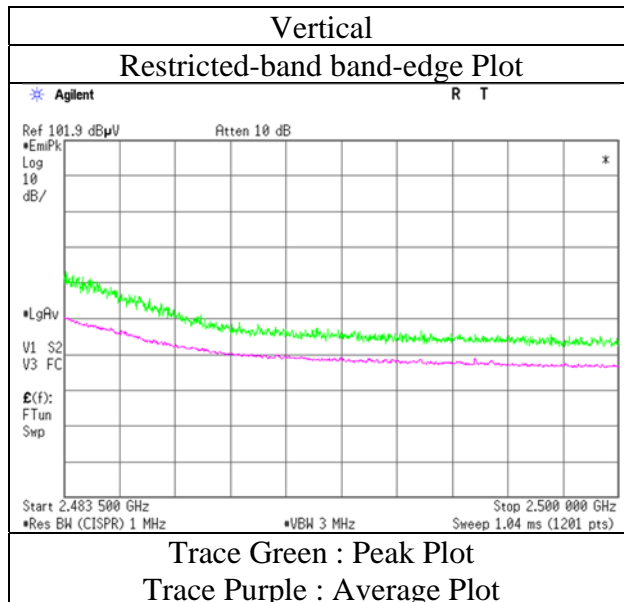
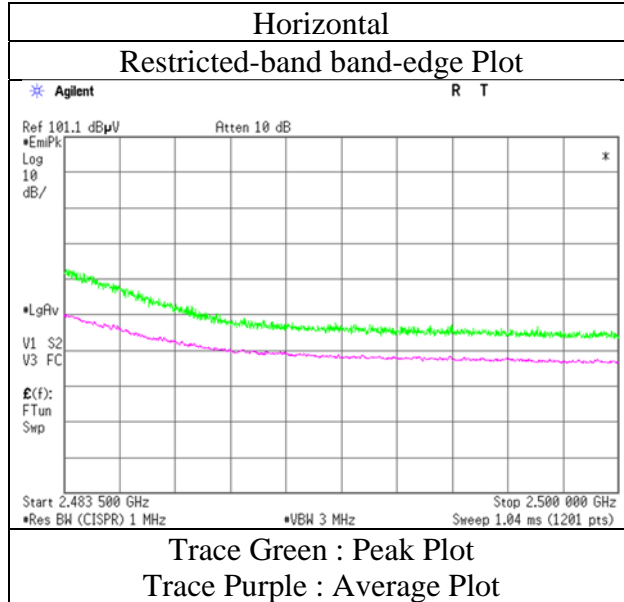

* The measurement was conducted for a sufficiently long enough time to detect any possible spurious emissions. Final result of restricted band edge was shown in tabular data.

Radiated Spurious Emission

Test place	Ise EMC Lab.	
Semi Anechoic Chamber	No.2	No.2
Date	May 10, 2022	May 11, 2022
Temperature / Humidity	24 deg. C / 54 % RH	24 deg. C / 52 % RH
Engineer	Kiyoshiro Okazaki	Sayaka Hara
	(1 GHz - 10 GHz)	(10 GHz - 26.5 GHz)
Mode	Tx 11n-20 2412 MHz	

Polarity [Hori/Vert]	Frequency [MHz]	Reading (QP / PK) [dBuV]	Reading (AV) [dBuV]	Ant. Factor [dB/m]	Loss [dB]	Gain [dB]	Duty Factor [dB]	Result (QP / PK) [dBuV/m]	Result (AV) [dBuV/m]	Limit (QP / PK) [dBuV/m]	Limit (AV) [dBuV/m]	Margin (QP / PK) [dB]	Margin (AV) [dB]	Remark
Hori.	2390.0	68.5	53.2	27.6	4.7	34.9	1.9	66.0	52.5	73.9	53.9	8.0	1.4	*1),*2)
Hori.	3617.5	49.3	39.6	29.2	6.9	34.2	1.9	51.2	43.4	73.9	53.9	22.7	10.5	
Hori.	4824.0	42.3	33.5	31.5	7.0	34.1	-	46.8	37.9	73.9	53.9	27.2	16.0	Floor noise
Hori.	7236.0	43.2	33.7	35.9	8.4	34.1	-	53.5	43.9	73.9	53.9	20.4	10.0	Floor noise
Hori.	9648.0	43.8	34.1	38.8	8.9	34.7	-	56.9	47.2	73.9	53.9	17.0	6.7	Floor noise
Vert.	2390.0	67.0	51.8	27.6	4.7	34.9	1.9	64.5	51.2	73.9	53.9	9.4	2.7	*1),*2)
Vert.	3617.5	49.8	45.4	29.2	6.9	34.2	1.9	51.7	49.2	73.9	53.9	22.2	4.7	
Vert.	4824.0	42.1	33.7	31.5	7.0	34.1	-	46.6	38.2	73.9	53.9	27.4	15.7	Floor noise
Vert.	7236.0	42.3	34.2	35.9	8.4	34.1	-	52.5	44.4	73.9	53.9	21.4	9.5	Floor noise
Vert.	9648.0	43.3	34.2	38.8	8.9	34.7	-	56.3	47.3	73.9	53.9	17.6	6.6	Floor noise

Result (QP / PK) = Reading + Ant Factor + Loss (Cable+Attenuator+Filter+Distance factor(above 1 GHz)) - Gain(Amplifier)

Result (AV)= Reading + Ant Factor + Loss (Cable+Attenuator+Filter+Distance factor(above 1 GHz)) - Gain(Amplifier) + Duty factor

*Other frequency noises omitted in this report were not seen or had enough margin (more than 20 dB).

*QP detector was used up to 1GHz.

*1) Not Out of Band emission(Leakage Power)

*2) Integration method (AV only)

20dBc Data Sheet

Polarity [Hori/Vert]	Frequency [MHz]	Reading (PK) [dBuV]	Ant Factor [dB/m]	Loss [dB]	Gain [dB]	Result [dBuV/m]	Limit [dBuV/m]	Margin [dB]	Remark
Hori.	2412.0	106.3	27.5	4.8	34.9	103.7	-	-	Carrier
Hori.	2400.0	71.4	27.6	4.7	34.9	68.8	83.7	14.9	
Vert.	2412.0	105.3	27.5	4.8	34.9	102.8	-	-	Carrier
Vert.	2400.0	70.6	27.6	4.7	34.9	68.0	82.8	14.8	

Result = Reading + Ant Factor + Loss (Cable+Attenuator+Filter+Distance factor(above 1 GHz)) - Gain(Amplifier)

Distance factor: 1 GHz - 10 GHz 20log(3.65 m / 3.0 m) = 1.71 dB
 10 GHz - 26.5 GHz 20log(1.0 m / 3.0 m) = -9.5 dB

Radiated Spurious Emission (Reference Plot for band-edge)

Test place	Ise EMC Lab.
Semi Anechoic Chamber	No.2
Date	May 10, 2022
Temperature / Humidity	24 deg. C / 54 % RH
Engineer	Kiyoshiro Okazaki (1 GHz - 10 GHz)
Mode	Tx 11n-20 2412 MHz

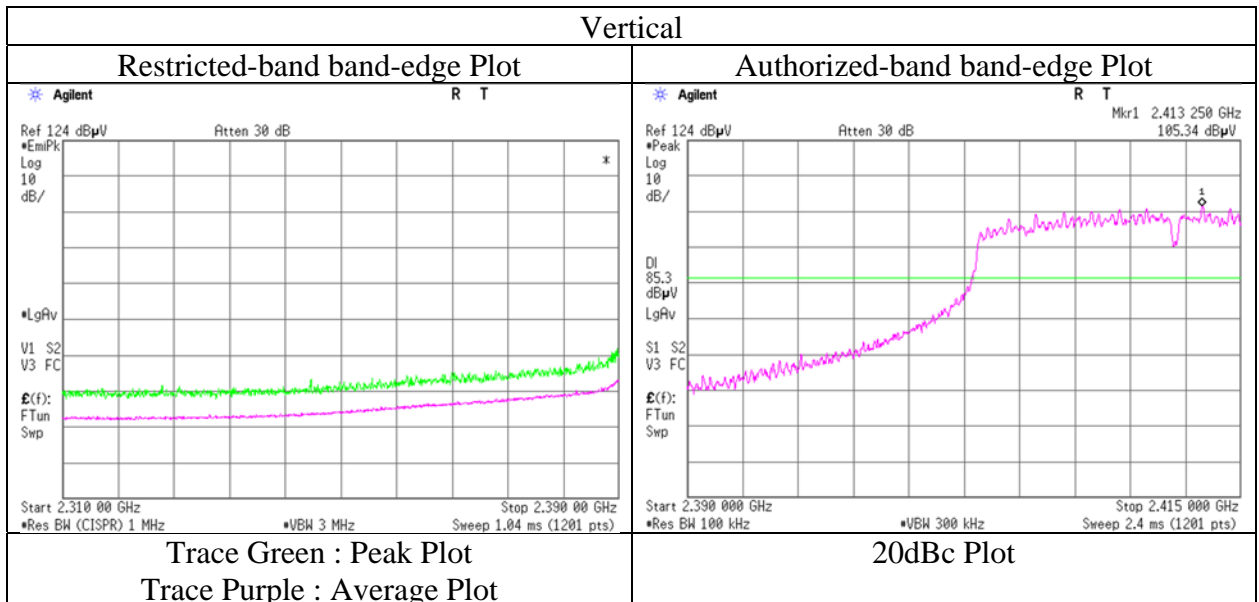
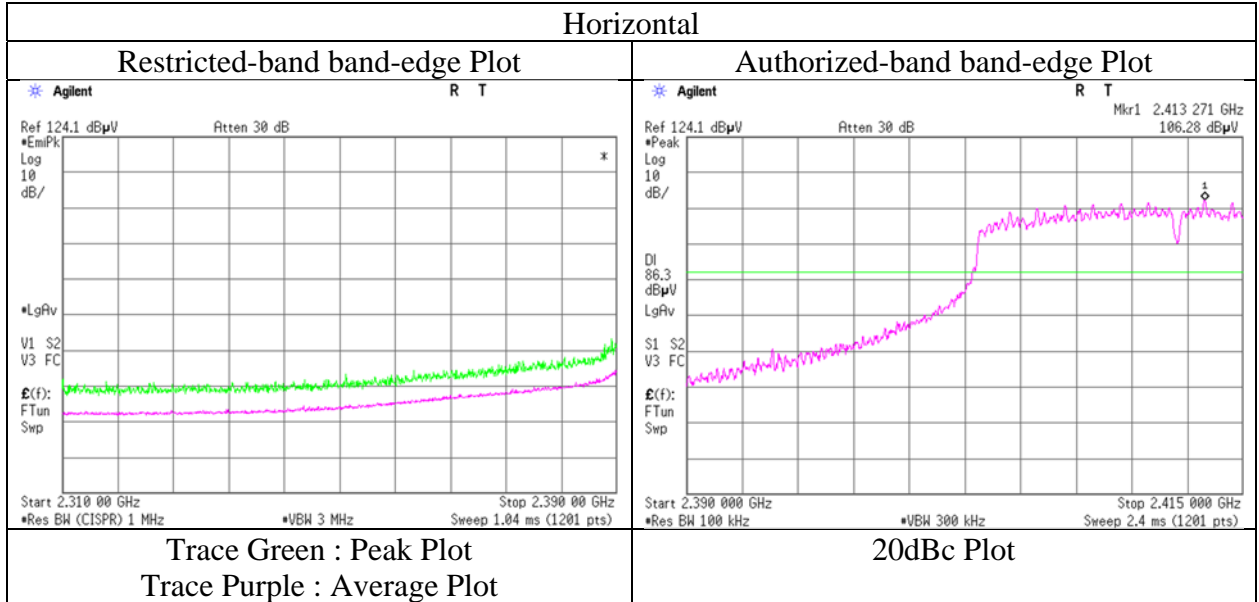

* The measurement was conducted for a sufficiently long enough time to detect any possible spurious emissions. Final result of restricted band edge was shown in tabular data.

Radiated Spurious Emission

Test place	Ise EMC Lab.	
Semi Anechoic Chamber	No.2	No.2
Date	May 11, 2022	May 11, 2022
Temperature / Humidity	25 deg. C / 42 % RH	24 deg. C / 52 % RH
Engineer	Sayaka Hara	Sayaka Hara
	(1 GHz - 10 GHz)	(10 GHz - 26.5 GHz)
Mode	Tx 11n-20 2442 MHz	

Polarity [Hori/Vert]	Frequency [MHz]	Reading (QP / PK) [dBuV]	Reading (AV) [dBuV]	Ant. Factor [dB/m]	Loss [dB]	Gain [dB]	Duty Factor [dB]	Result (QP / PK) [dBuV/m]	Result (AV) [dBuV/m]	Limit (QP / PK) [dBuV/m]	Limit (AV) [dBuV/m]	Margin (QP / PK) [dB]	Margin (AV) [dB]	Remark
Hori.	3662.9	48.3	40.6	29.3	6.9	34.2	1.9	50.3	44.5	73.9	53.9	23.6	9.4	
Hori.	4884.0	44.0	33.2	31.5	7.0	34.1	-	48.4	37.6	73.9	53.9	25.5	16.3	Floor noise
Hori.	7326.0	44.0	33.3	36.0	8.4	34.1	-	54.3	43.6	73.9	53.9	19.6	10.3	Floor noise
Hori.	9768.0	44.5	33.5	39.1	9.0	34.7	-	57.9	46.9	73.9	53.9	16.0	7.0	Floor noise
Vert.	3662.9	49.2	44.8	29.3	6.9	34.2	1.9	51.2	48.7	73.9	53.9	22.7	5.2	
Vert.	4884.0	46.9	35.9	31.5	7.0	34.1	1.9	51.3	42.2	73.9	53.9	22.7	11.7	
Vert.	7326.0	44.0	33.3	36.0	8.4	34.1	-	54.4	43.6	73.9	53.9	19.5	10.3	Floor noise
Vert.	9768.0	46.0	34.8	39.1	9.0	34.7	1.9	59.4	50.0	73.9	53.9	14.5	3.9	

Result (QP / PK) = Reading + Ant Factor + Loss (Cable+Attenuator+Filter+Distance factor(above 1 GHz)) - Gain(Amplifier)

Result (AV) = Reading + Ant Factor + Loss (Cable+Attenuator+Filter+Distance factor(above 1 GHz)) - Gain(Amplifier) + Duty factor

*Other frequency noises omitted in this report were not seen or had enough margin (more than 20 dB).

*QP detector was used up to 1GHz.

Distance factor: 1 GHz - 10 GHz $20\log(3.65\text{ m} / 3.0\text{ m}) = 1.71\text{ dB}$
 10 GHz - 26.5 GHz $20\log(1.0\text{ m} / 3.0\text{ m}) = -9.5\text{ dB}$

Radiated Spurious Emission

Test place	Ise EMC Lab.	
Semi Anechoic Chamber	No.2	No.2
Date	May 10, 2022	May 11, 2022
Temperature / Humidity	24 deg. C / 54 % RH	24 deg. C / 52 % RH
Engineer	Kiyoshiro Okazaki	Sayaka Hara
	(1 GHz - 10 GHz)	(10 GHz - 26.5 GHz)
Mode	Tx 11n-20 2462 MHz	

Polarity [Hori/Vert]	Frequency [MHz]	Reading (QP / PK) [dBuV]	Reading (AV) [dBuV]	Ant. Factor [dB/m]	Loss [dB]	Gain [dB]	Duty Factor [dB]	Result (QP / PK) [dBuV/m]	Result (AV) [dBuV/m]	Limit (QP / PK) [dBuV/m]	Limit (AV) [dBuV/m]	Margin (QP / PK) [dB]	Margin (AV) [dB]	Remark
Hori.	2483.5	71.2	51.8	27.5	4.8	34.9	1.9	68.6	51.2	73.9	53.9	5.3	2.8	*1),*2)
Hori.	3692.9	47.9	40.4	29.3	6.9	34.1	1.9	50.0	44.4	73.9	53.9	24.0	9.6	
Hori.	4924.0	43.3	33.0	31.5	7.0	34.1	-	47.7	37.4	73.9	53.9	26.2	16.5	Floor noise
Hori.	7386.0	44.1	33.6	36.1	8.4	34.1	-	54.4	44.0	73.9	53.9	19.5	9.9	Floor noise
Hori.	9848.0	43.8	33.6	39.1	9.0	34.7	-	57.2	47.0	73.9	53.9	16.7	6.9	Floor noise
Vert.	2483.5	71.2	51.5	27.5	4.8	34.9	1.9	68.6	50.8	73.9	53.9	5.3	3.1	*1),*2)
Vert.	3692.9	50.3	45.5	29.3	6.9	34.1	1.9	52.4	49.4	73.9	53.9	21.5	4.5	
Vert.	4924.0	45.9	35.5	31.5	7.0	34.1	1.9	50.3	41.8	73.9	53.9	23.6	12.1	
Vert.	7386.0	44.1	33.6	36.1	8.4	34.1	-	54.5	44.0	73.9	53.9	19.4	9.9	Floor noise
Vert.	9848.0	44.3	34.2	39.1	9.0	34.7	-	57.7	47.6	73.9	53.9	16.2	6.3	Floor noise

Result (QP / PK) = Reading + Ant Factor + Loss (Cable+Attenuator+Filter+Distance factor(above 1 GHz)) - Gain(Amplifier)

Result (AV)= Reading + Ant Factor + Loss (Cable+Attenuator+Filter+Distance factor(above 1 GHz)) - Gain(Amplifier) + Duty factor

*Other frequency noises omitted in this report were not seen or had enough margin (more than 20 dB).

*QP detector was used up to 1GHz.

*1) Not Out of Band emission(Leakage Power)

*2) Integration method (AV only)

Distance factor: 1 GHz - 10 GHz 20log(3.65 m / 3.0 m) = 1.71 dB
 10 GHz - 26.5 GHz 20log(1.0 m / 3.0 m) = -9.5 dB

Radiated Spurious Emission (Reference Plot for band-edge)

Test place Ise EMC Lab.
Semi Anechoic Chamber No.2
Date May 10, 2022
Temperature / Humidity 24 deg. C / 54 % RH
Engineer Kiyoshiro Okazaki
 (1 GHz - 10 GHz)
Mode Tx 11n-20 2462 MHz

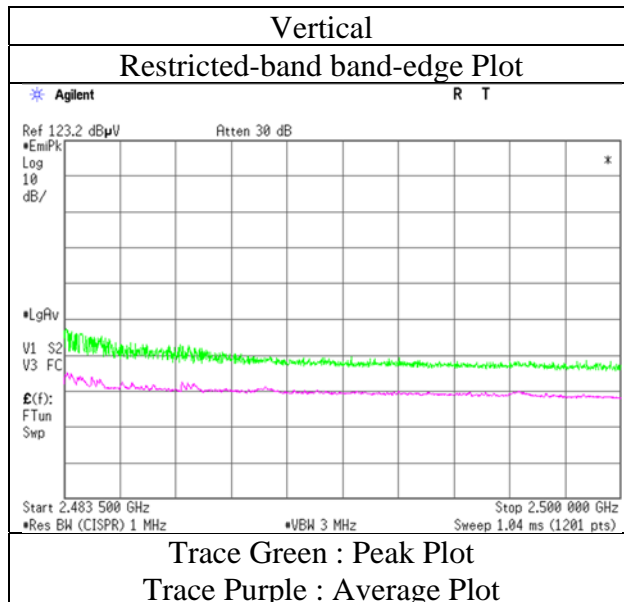
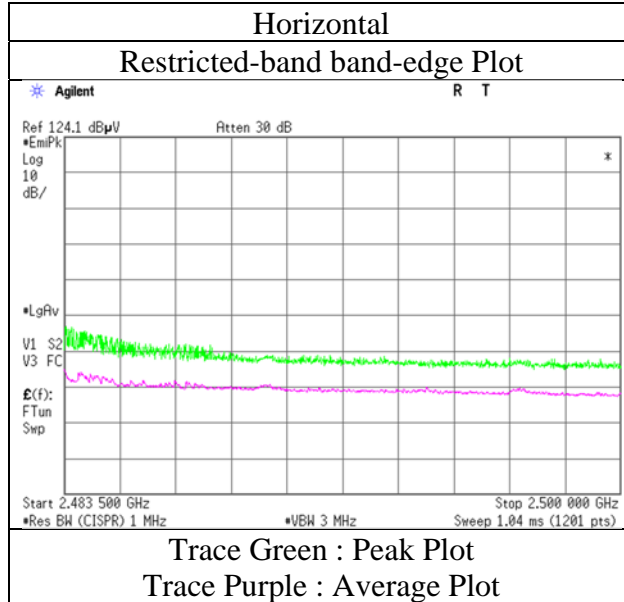

* The measurement was conducted for a sufficiently long enough time to detect any possible spurious emissions. Final result of restricted band edge was shown in tabular data.

Radiated Spurious Emission

Test place	Ise EMC Lab.	
Semi Anechoic Chamber	No.2	No.2
Date	May 10, 2022	May 11, 2022
Temperature / Humidity	24 deg. C / 54 % RH	24 deg. C / 52 % RH
Engineer	Kiyoshiro Okazaki	Sayaka Hara
	(1 GHz - 10 GHz)	(10 GHz - 26.5 GHz)
Mode	Tx 11n-20 2467 MHz	

Polarity [Hori/Vert]	Frequency [MHz]	Reading (QP / PK) [dBuV]	Reading (AV) [dBuV]	Ant. Factor [dB/m]	Loss [dB]	Gain [dB]	Duty Factor [dB]	Result (QP / PK) [dBuV/m]	Result (AV) [dBuV/m]	Limit (QP / PK) [dBuV/m]	Limit (AV) [dBuV/m]	Margin (QP / PK) [dB]	Margin (AV) [dB]	Remark
Hori.	2483.5	68.7	51.8	27.5	4.8	34.9	1.9	66.1	51.1	73.9	53.9	7.8	2.8	*1),*2)
Hori.	3700.0	47.0	39.9	29.3	6.9	34.1	1.9	49.1	43.9	73.9	53.9	24.8	10.0	
Hori.	4934.0	43.7	33.6	31.5	7.0	34.1	-	48.1	38.0	73.9	53.9	25.8	15.9	Floor noise
Hori.	7401.0	42.8	34.2	36.1	8.4	34.1	-	53.2	44.6	73.9	53.9	20.7	9.3	Floor noise
Hori.	9868.0	43.1	34.3	39.1	9.0	34.7	-	56.4	47.7	73.9	53.9	17.5	6.2	Floor noise
Vert.	2483.5	68.6	50.9	27.5	4.8	34.9	1.9	66.0	50.2	73.9	53.9	7.9	3.7	*1),*2)
Vert.	3700.0	49.3	44.8	29.3	6.9	34.1	1.9	51.3	48.8	73.9	53.9	22.6	5.2	
Vert.	4934.0	42.9	33.8	31.5	7.0	34.1	-	47.3	38.3	73.9	53.9	26.6	15.6	Floor noise
Vert.	7401.0	43.0	34.1	36.1	8.4	34.1	-	53.4	44.5	73.9	53.9	20.6	9.4	Floor noise
Vert.	9868.0	43.7	35.3	39.1	9.0	34.7	1.9	57.1	50.6	73.9	53.9	16.8	3.3	

Result (QP / PK) = Reading + Ant Factor + Loss (Cable+Attenuator+Filter+Distance factor(above 1 GHz)) - Gain(Amplifier)

Result (AV)= Reading + Ant Factor + Loss (Cable+Attenuator+Filter+Distance factor(above 1 GHz)) - Gain(Amplifier) + Duty factor

*Other frequency noises omitted in this report were not seen or had enough margin (more than 20 dB).

*QP detector was used up to 1GHz.

*1) Not Out of Band emission(Leakage Power)

*2) Integration method (AV only)

Distance factor:	1 GHz - 10 GHz	20log(3.65 m / 3.0 m) = 1.71 dB
	10 GHz - 26.5 GHz	20log(1.0 m / 3.0 m) = -9.5 dB

Radiated Spurious Emission (Reference Plot for band-edge)

Test place Ise EMC Lab.
Semi Anechoic Chamber No.2
Date May 10, 2022
Temperature / Humidity 24 deg. C / 54 % RH
Engineer Kiyoshiro Okazaki
 (1 GHz - 10 GHz)
Mode Tx 11n-20 2467 MHz

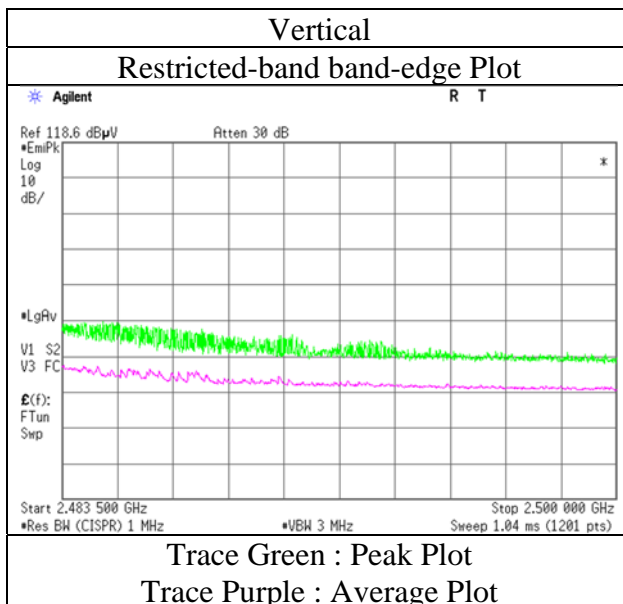
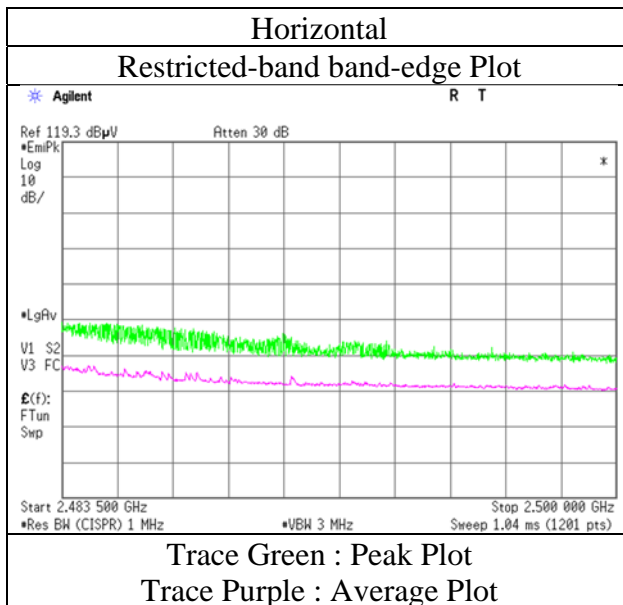

* The measurement was conducted for a sufficiently long enough time to detect any possible spurious emissions. Final result of restricted band edge was shown in tabular data.

Radiated Spurious Emission

Test place	Ise EMC Lab.	
Semi Anechoic Chamber	No.2	No.2
Date	May 10, 2022	May 11, 2022
Temperature / Humidity	24 deg. C / 54 % RH	24 deg. C / 52 % RH
Engineer	Kiyoshiro Okazaki	Sayaka Hara
	(1 GHz - 10 GHz)	(10 GHz - 26.5 GHz)
Mode	Tx 11n-20 2472 MHz	

Polarity [Hori/Vert]	Frequency [MHz]	Reading (QP / PK) [dBuV]	Reading (AV) [dBuV]	Ant. Factor [dB/m]	Loss [dB]	Gain [dB]	Duty Factor [dB]	Result (QP / PK) [dBuV/m]	Result (AV) [dBuV/m]	Limit (QP / PK) [dBuV/m]	Limit (AV) [dBuV/m]	Margin (QP / PK) [dB]	Margin (AV) [dB]	Remark
Hori.	2483.5	65.2	52.1	27.5	4.8	34.9	1.9	62.6	51.4	73.9	53.9	11.3	2.5	*1)
Hori.	3707.5	47.1	39.5	29.4	6.9	34.1	1.9	49.2	43.5	73.9	53.9	24.7	10.4	
Hori.	4944.0	42.2	33.3	31.5	7.1	34.1	-	46.7	37.7	73.9	53.9	27.2	16.2	Floor noise
Hori.	7416.0	42.9	34.3	36.1	8.4	34.2	-	53.3	44.7	73.9	53.9	20.6	9.2	Floor noise
Hori.	9888.0	43.2	34.3	39.1	9.0	34.7	-	56.6	47.6	73.9	53.9	17.3	6.3	Floor noise
Vert.	2483.5	64.8	52.4	27.5	4.8	34.9	1.9	62.2	51.7	73.9	53.9	11.7	2.2	*1)
Vert.	3707.5	49.9	44.7	29.4	6.9	34.1	1.9	52.0	48.7	73.9	53.9	21.9	5.2	
Vert.	4944.0	42.3	33.2	31.5	7.1	34.1	-	46.8	37.7	73.9	53.9	27.1	16.2	Floor noise
Vert.	7416.0	43.1	34.1	36.1	8.4	34.2	-	53.5	44.5	73.9	53.9	20.4	9.4	Floor noise
Vert.	9888.0	44.4	35.8	39.1	9.0	34.7	1.9	57.8	51.1	73.9	53.9	16.1	2.8	

Result (QP / PK) = Reading + Ant Factor + Loss (Cable+Attenuator+Filter+Distance factor(above 1 GHz)) - Gain(Amplifier)

Result (AV)= Reading + Ant Factor + Loss (Cable+Attenuator+Filter+Distance factor(above 1 GHz)) - Gain(Amplifier) + Duty factor

*Other frequency noises omitted in this report were not seen or had enough margin (more than 20 dB).

*QP detector was used up to 1GHz.

*1) Not Out of Band emission(Leakage Power)

Distance factor:	1 GHz - 10 GHz	20log(3.65 m / 3.0 m) = 1.71 dB
	10 GHz - 26.5 GHz	20log(1.0 m / 3.0 m) = -9.5 dB

Radiated Spurious Emission (Reference Plot for band-edge)

Test place	Ise EMC Lab.
Semi Anechoic Chamber	No.2
Date	May 10, 2022
Temperature / Humidity	24 deg. C / 54 % RH
Engineer	Kiyoshiro Okazaki (1 GHz - 10 GHz)
Mode	Tx 11n-20 2472 MHz

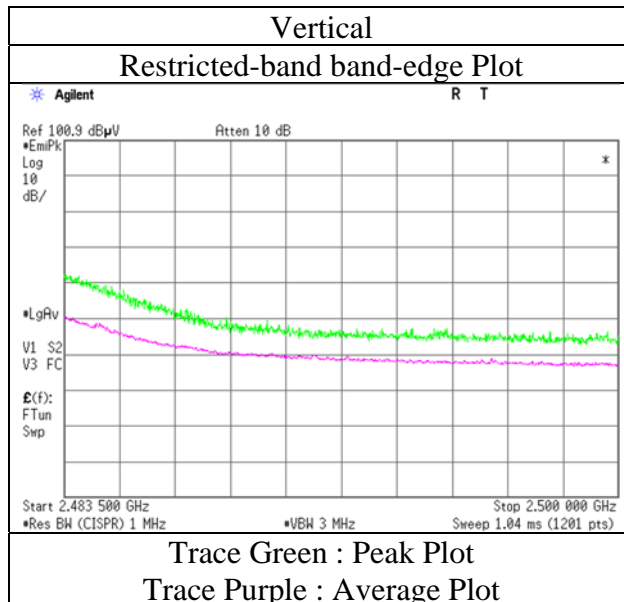
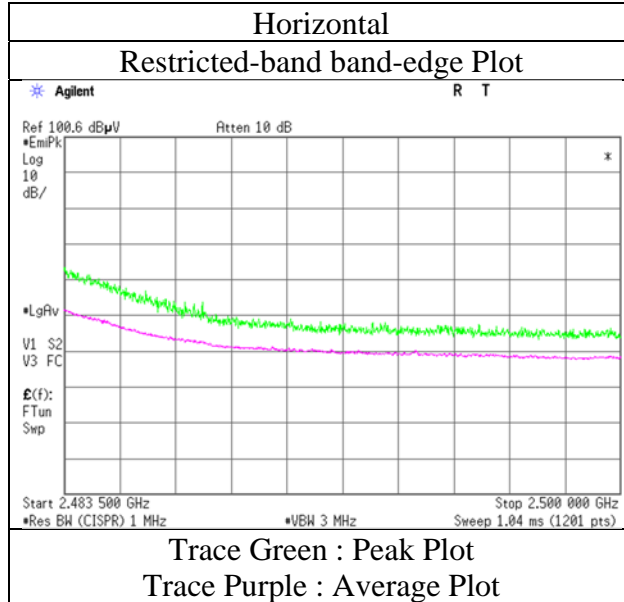

* The measurement was conducted for a sufficiently long enough time to detect any possible spurious emissions. Final result of restricted band edge was shown in tabular data.

Radiated Spurious Emission
(Plot data, Worst case mode for Maximum Peak Output Power)

Test place	Ise EMC Lab.	No.2	No.2
Semi Anechoic Chamber	No.2	May 11, 2022	May 15, 2022
Date	May 10, 2022	24 deg. C / 52 % RH	23 deg. C / 53 % RH
Temperature / Humidity	24 deg. C / 54 % RH	Sayaka Hara	Kiyoshiro Okazaki
Engineer	Kiyoshiro Okazaki (1 GHz - 10 GHz)	(10 GHz - 26.5 GHz)	(Below 1 GHz)
Mode	Tx 11g 2462 MHz		

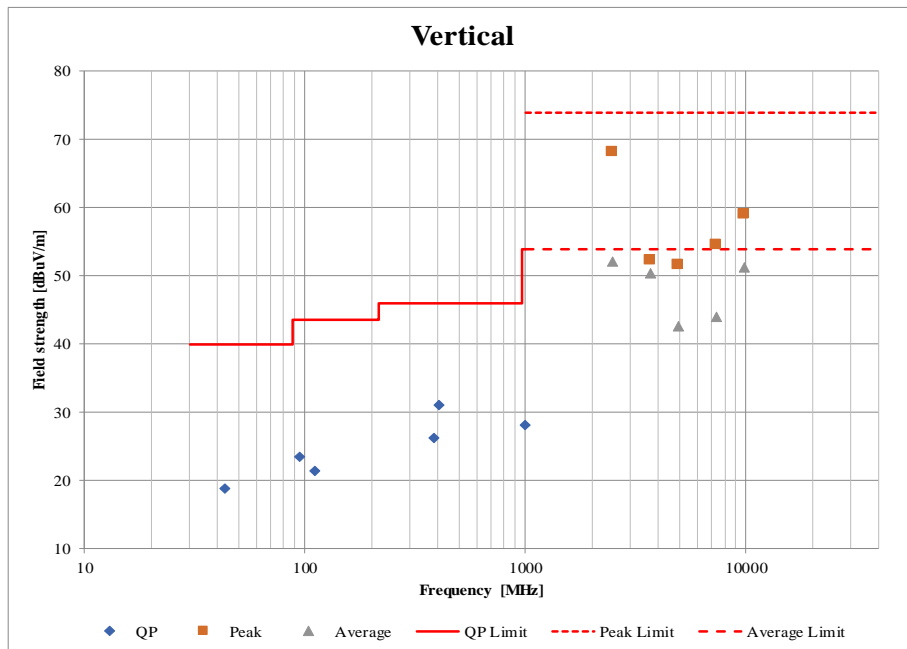
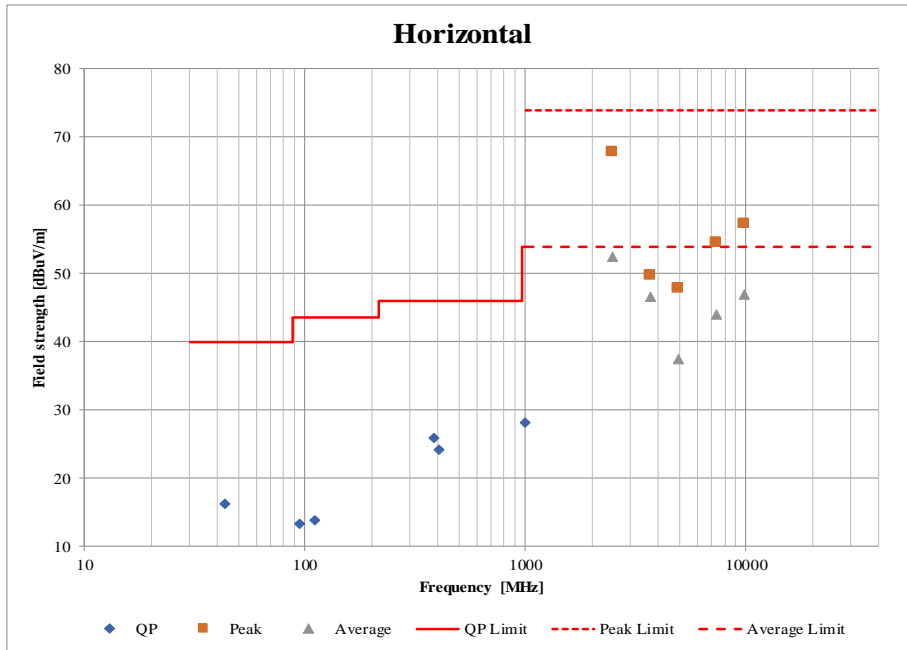

*These plots data contains sufficient number to show the trend of characteristic features for EUT.

Conducted Spurious Emission

Test place	Ise EMC Lab. No.6 Measurement Room
Date	May 17, 2022
Temperature / Humidity	23 deg. C / 51 % RH
Engineer	Takumi Nishida
Mode	Tx 11g 2462 MHz

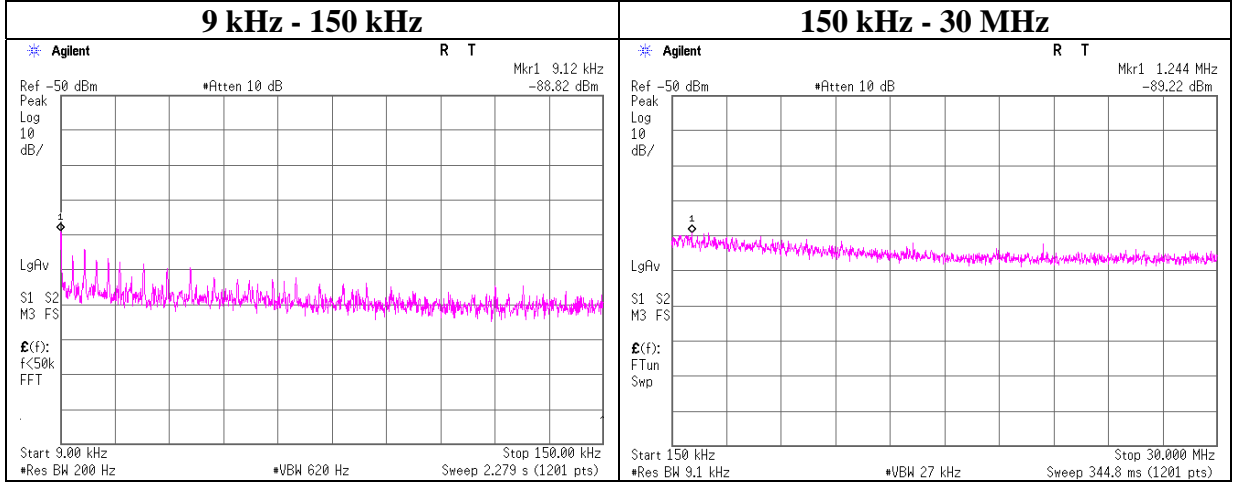

Frequency [kHz]	Reading [dBm]	Cable Loss [dB]	Attenuator Loss [dB]	Antenna Gain [dBi]	N (Number of Output)	EIRP [dBm]	Distance [m]	Ground bounce [dB]	E (field strength) [dBuV/m]	Limit [dBuV/m]	Margin [dB]	Remark
9.12	-88.8	0.00	9.8	3.2	1	-75.8	300	6.0	-14.5	48.4	62.9	
1244.00	-89.2	0.01	9.8	3.2	1	-76.2	30	6.0	5.1	25.7	20.6	

$E \text{ [dBuV/m]} = \text{EIRP [dBm]} - 20 \log (\text{Distance [m]}) + \text{Ground bounce [dB]} + 104.8 \text{ [dBuV/m]}$

$\text{EIRP [dBm]} = \text{Reading [dBm]} + \text{Cable loss [dB]} + \text{Attenuator Loss [dB]} + \text{Antenna gain [dBi]} + 10 * \log (N)$

N: Number of output

Power Density

Test place	Ise EMC Lab. No.6 Measurement Room
Date	May 17, 2022
Temperature / Humidity	23 deg. C / 51 % RH
Engineer	Takumi Nishida
Mode	Tx

11b

Freq.	Reading	Cable Loss	Atten. Loss	Result	Limit	Margin
[MHz]	[dBm / 3 kHz]	[dB]	[dB]	[dBm / 3 kHz]	[dBm / 3 kHz]	[dB]
2412	-28.38	1.86	20.06	-6.46	8.00	14.46
2442	-28.24	1.87	20.06	-6.31	8.00	14.31
2462	-28.88	1.88	20.06	-6.94	8.00	14.94
2472	-37.44	1.88	20.06	-15.50	8.00	23.50

11g

Freq.	Reading	Cable Loss	Atten. Loss	Result	Limit	Margin
[MHz]	[dBm / 3 kHz]	[dB]	[dB]	[dBm / 3 kHz]	[dBm / 3 kHz]	[dB]
2412	-31.68	1.86	20.06	-9.76	8.00	17.76
2442	-33.00	1.87	20.06	-11.07	8.00	19.07
2462	-32.26	1.88	20.06	-10.32	8.00	18.32
2467	-38.97	1.88	20.06	-17.03	8.00	25.03
2472	-56.60	1.88	20.06	-34.66	8.00	42.66

11n-20

Freq.	Reading	Cable Loss	Atten. Loss	Result	Limit	Margin
[MHz]	[dBm / 3 kHz]	[dB]	[dB]	[dBm / 3 kHz]	[dBm / 3 kHz]	[dB]
2412	-34.43	1.86	20.06	-12.51	8.00	20.51
2442	-33.83	1.87	20.06	-11.90	8.00	19.90
2462	-33.42	1.88	20.06	-11.48	8.00	19.48
2467	-38.75	1.88	20.06	-16.81	8.00	24.81
2472	-57.16	1.88	20.06	-35.22	8.00	43.22

Sample Calculation:

Result = Reading + Cable Loss (including the cable(s) customer supplied) + Attenuator Loss

*The equipment and cables were not used for factor 0 dB of the data sheets.

Power Density

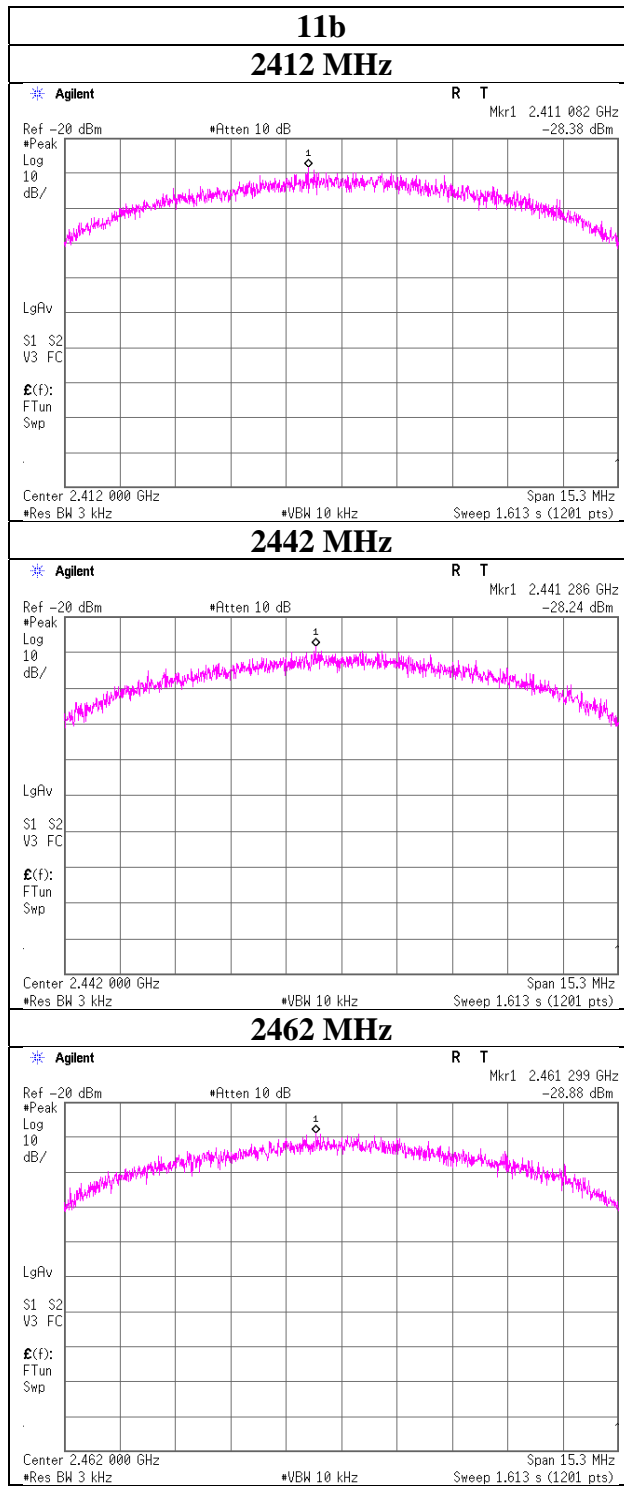

Power Density

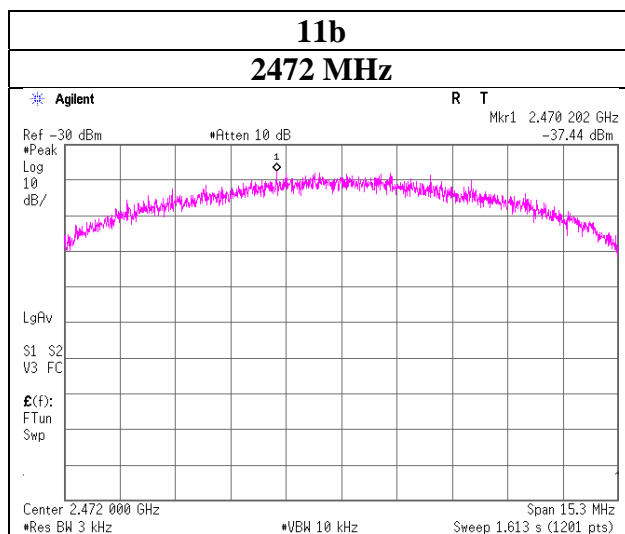

Power Density

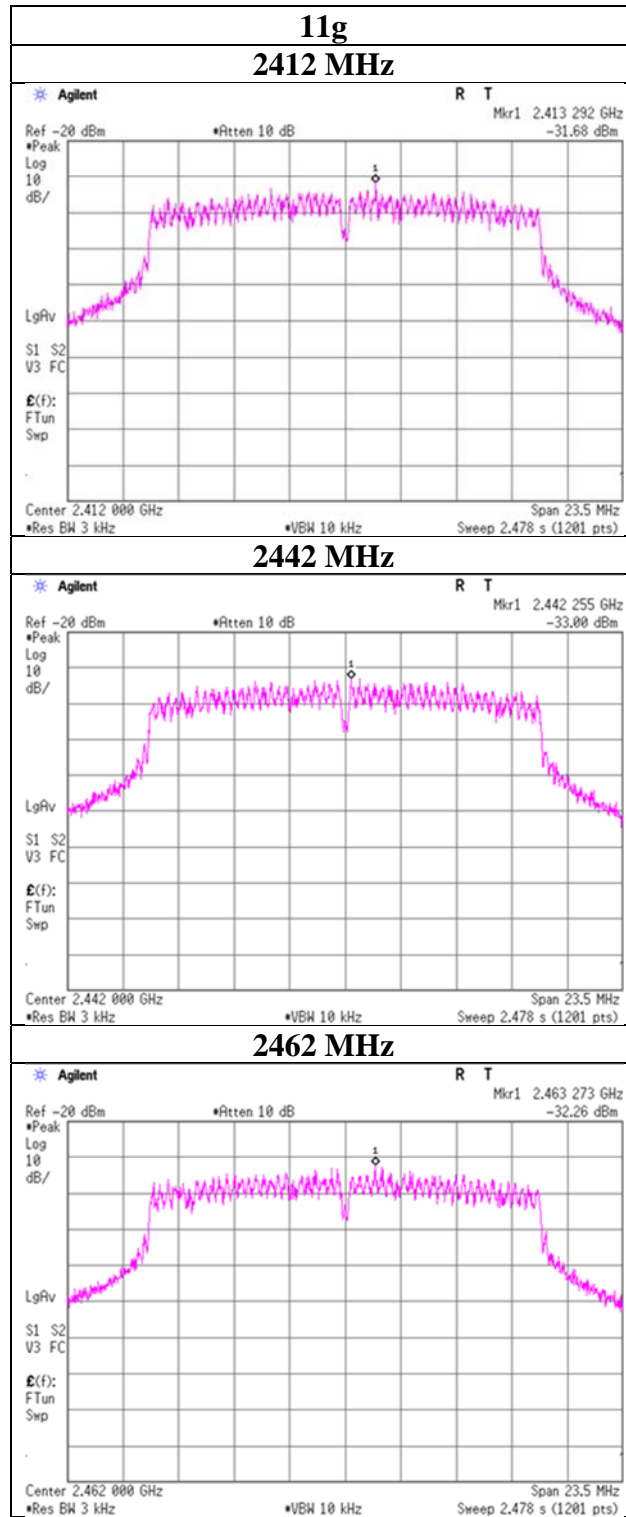

Power Density

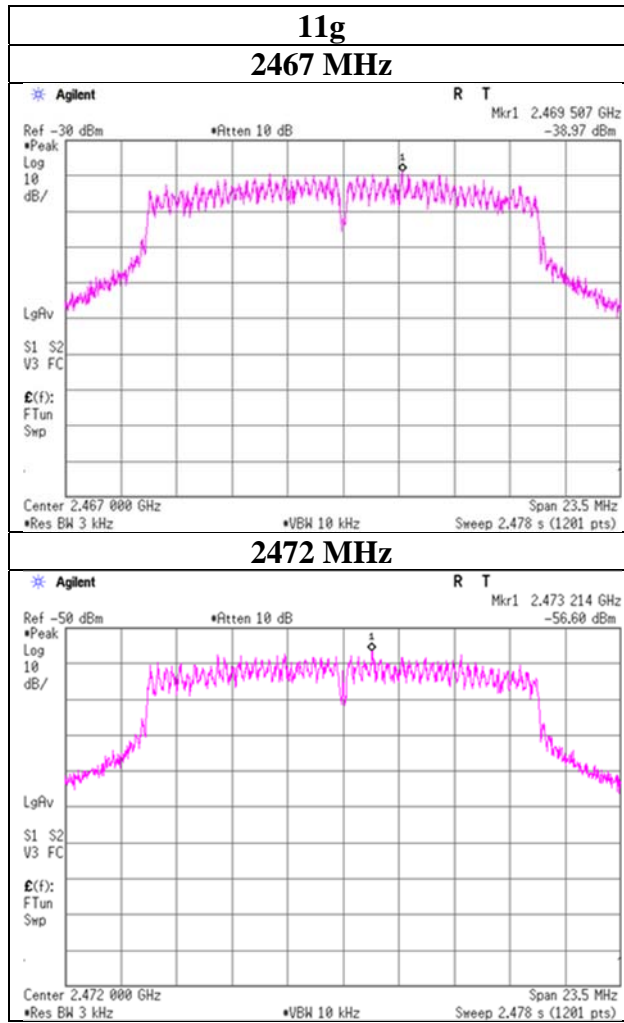

Power Density

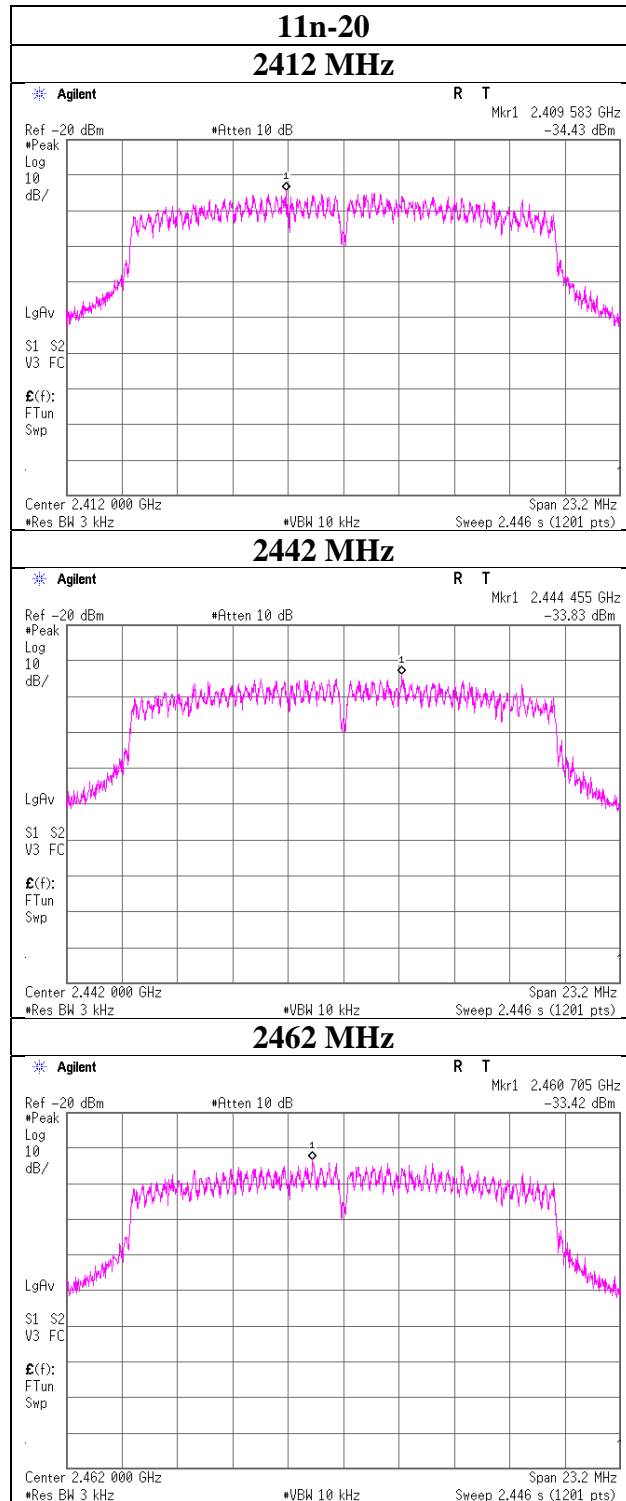

Power Density

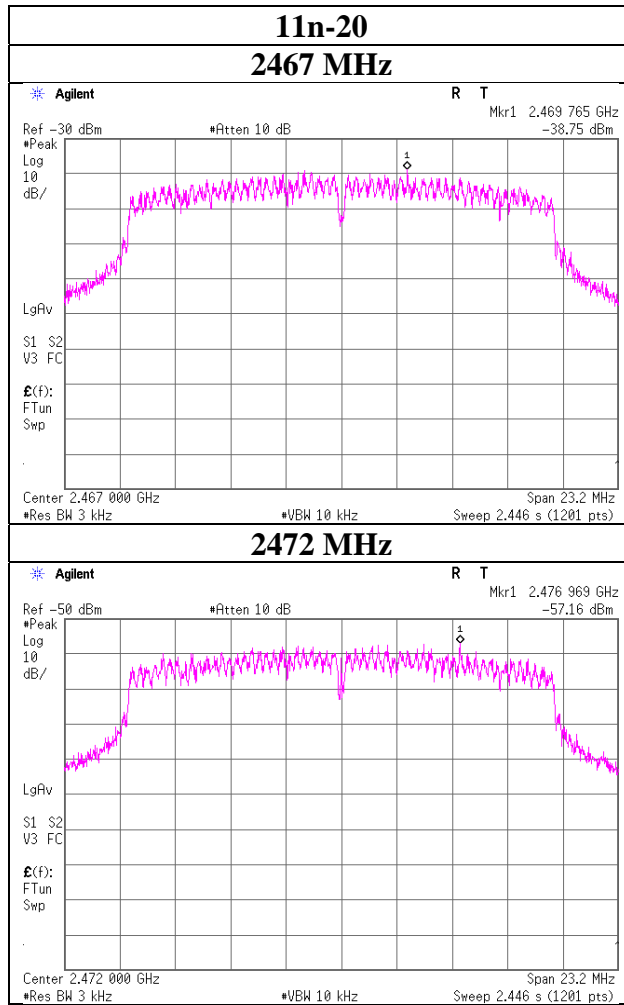

APPENDIX 2: Test Instruments

Test Equipment (1/2)

Test Item	Local ID	LIMS ID	Description	Manufacturer	Model	Serial	Last Calibration Date	Cal Int
CE	COTS-MEMI-02	178648	EMI measurement program	TSJ (Techno Science Japan)	TEPTO-DV	-	-	-
CE	MAEC-02	142004	AC2_Semi Anechoic Chamber(NSA)	TDK	Semi Anechoic Chamber 3m	DA-06902	05/26/2020	24
CE	MAT-64	141290	Attenuator(13dB)	JFW Industries, Inc.	50FP-013H2 N	-	12/17/2021	12
CE	MCC-13	141222	Coaxial Cable	Fujikura,HP,Mini-Circuits,Fujikura	3D-2W(12m)/ 5D-2W(5m)/ 5D-2W(0.8m)/ 5D-2W(1m)	-	02/20/2022	12
CE	MJM-27	142228	Measure	KOMELON	KMC-36	-	-	-
CE	MLS-23	141357	LISN(AMN)	Schwarzbeck Mess-Elektronik OHG	NSLK8127	8127-729	07/18/2021	12
CE	MMM-01	141542	Digital Tester	Fluke Corporation	FLUKE 26-3	78030611	08/10/2021	12
CE	MOS-41	192300	Thermo-Hygrometer	CUSTOM. Inc	CTH-201	0013	12/19/2021	12
CE	MTR-09	141950	EMI Test Receiver	Rohde & Schwarz	ESU26	100412	10/14/2021	12
RE	COTS-MEMI-02	178648	EMI measurement program	TSJ (Techno Science Japan)	TEPTO-DV	-	-	-
RE	MAEC-02	142004	AC2_Semi Anechoic Chamber(NSA)	TDK	Semi Anechoic Chamber 3m	DA-06902	05/26/2020	24
RE	MAEC-02-SVSWR	142006	AC2_Semi Anechoic Chamber(SVSWR)	TDK	Semi Anechoic Chamber 3m	DA-06902	04/09/2021	24
RE	MAT-07	141203	Attenuator(6dB)	Weinschel Corp	2	BK7970	11/09/2021	12
RE	MBA-08	141427	Biconical Antenna	Schwarzbeck Mess-Elektronik OHG	VHA9103B+ BBA9106	08031	07/10/2021	12
RE	MCC-12	141317	Coaxial Cable	UL Japan	-	-	09/06/2021	12
RE	MCC-218	141394	Microwave Cable	Junkosha	MWX221	1607S141(1 m) / 1608S264(5 m)	09/30/2021	12
RE	MHA-06	141512	Horn Antenna 1-18GHz	Schwarzbeck Mess-Elektronik OHG	BBHA9120D	254	10/21/2021	12
RE	MHA-16	141513	Horn Antenna 15-40GHz	Schwarzbeck Mess-Elektronik OHG	BBHA9170	BBHA9170306	06/07/2021	12
RE	MHF-25	141232	High Pass Filter 3.5-18.0GHz	UL Japan	HPF SELECTOR	001	09/30/2021	12
RE	MJM-27	142228	Measure	KOMELON	KMC-36	-	-	-
RE	MLA-21	141265	Logperiodic Antenna (200-1000MHz)	Schwarzbeck Mess-Elektronik OHG	VUSLP9111B	9111B-190	07/10/2021	12
RE	MMM-01	141542	Digital Tester	Fluke Corporation	FLUKE 26-3	78030611	08/10/2021	12
RE	MOS-41	192300	Thermo-Hygrometer	CUSTOM. Inc	CTH-201	0013	12/19/2021	12
RE	MPA-10	141579	Pre Amplifier	Keysight Technologies Inc	8449B	3008A02142	02/22/2022	12
RE	MPA-24	141594	Pre Amplifier	Keysight Technologies Inc	8447D	2944A10150	02/25/2022	12
RE	MSA-10	141899	Spectrum Analyzer	Keysight Technologies Inc	E4448A	MY46180655	02/18/2022	12
RE	MTR-09	141950	EMI Test Receiver	Rohde & Schwarz	ESU26	100412	10/14/2021	12

Test Equipment (2/2)

Test Item	Local ID	LIMS ID	Description	Manufacturer	Model	Serial	Last Calibration Date	Cal Int
AT	MAT-10	141156	Attenuator(10dB)	Weinschel Corp	2	BL1173	11/09/2021	12
AT	MAT-21	141174	Attenuator(20dB) (above1GHz)	HIROSE ELECTRIC CO.,LTD.	AT-120	901247	01/23/2022	12
AT	MAT-57	141333	Attenuator(10dB)	Suhner	6810.19.A	-	12/17/2021	12
AT	MAT-58	141334	Attenuator(10dB)	Suhner	6810.19.A	-	12/08/2021	12
AT	MCC-128	141221	Coaxial Cable	Suhner	NRG180	-	08/11/2021	12
AT	MCC-67	141329	Microwave Cable 1G-40GHz	Suhner	SUCOFLEX102	28635/2	04/01/2022	12
AT	MJM-24	142225	Measure	ASKUL	-	-	-	-
AT	MJM-27	142228	Measure	KOMELON	KMC-36	-	-	-
AT	MMM-01	141542	Digital Tester	Fluke Corporation	FLUKE 26-3	78030611	08/10/2021	12
AT	MMM-12	141547	DIGITAL HiTESTER	HIOKI E.E. CORPORATION	3805	60500120	02/01/2022	12
AT	MOS-24	90289	Thermo-Hygrometer	CUSTOM. Inc	CTH-201	0005	01/10/2022	12
AT	MOS-41	192300	Thermo-Hygrometer	CUSTOM. Inc	CTH-201	0013	12/19/2021	12
AT	MPM-12	141809	Power Meter	Anritsu Corporation	ML2495A	825002	05/18/2022	12
AT	MPM-13	141810	Power Meter	Anritsu Corporation	ML2495A	824014	12/22/2021	12
AT	MPM-16	141812	Power Meter	Keysight Technologies Inc	8990B	MY51000271	08/11/2021	12
AT	MPSE-17	141830	Power sensor	Anritsu Corporation	MA2411B	738285	05/18/2022	12
AT	MPSE-18	141832	Power sensor	Anritsu Corporation	MA2411B	738174	12/22/2021	12
AT	MPSE-22	141842	Power sensor	Keysight Technologies Inc	N1923A	MY54070003	08/11/2021	12
AT	MSA-10	141899	Spectrum Analyzer	Keysight Technologies Inc	E4448A	MY46180655	02/18/2022	12
AT	MSA-22	141978	Spectrum Analyzer	Keysight Technologies Inc	E4448A	MY46180899	03/24/2022	12

*Hyphens for Last Calibration Date and Cal Int (month) are instruments that Calibration is not required (e.g. software), or instruments checked in advance before use.

The expiration date of the calibration is the end of the expired month.

As for some calibrations performed after the tested dates, those test equipment have been controlled by means of an unbroken chains of calibrations.

All equipment is calibrated with valid calibrations. Each measurement data is traceable to the national or international standards.

Test item: **CE: Conducted Emission**
 RE: Radiated Emission
 AT: Antenna Terminal Conducted