

HUMIDIFIER

SH8820W USER MANUAL



Go green. Stay healthy. Count on Elechomes.

THANK YOU FOR PURCHASING THE HUMIDIFIER BY ELECHOMES

Should you have any questions or concerns about your new product, feel free to contact us via support@elechomes.com. We hope you enjoy your new product!

GET LATEST INFO & INSPIRATION

Find @Elechomes on social media for wellness + recipes + parenting inspiration. Share your life with us.

@Elechomes

#Elechomeslifestyle • #Elechomeslifelover

TABLE OF CONTENTS

Diagram	1
Specifications	2
Electrical Schematic Diagram	2
Safety Precautions	2
Essential Function.....	3
Humidifier Operation	4
Important Notes.....	7
Maintenance	8
Replacing the Remote Control Battery.....	10
Troubleshooting.....	10
WiFi Instructions.....	13
Warranty Information	17
Customer Support	18

Smart
CONTROL

Thank you for choosing Elechomes! Please read this manual carefully to ensure safe use and keep it on hand for future reference.

Diagram

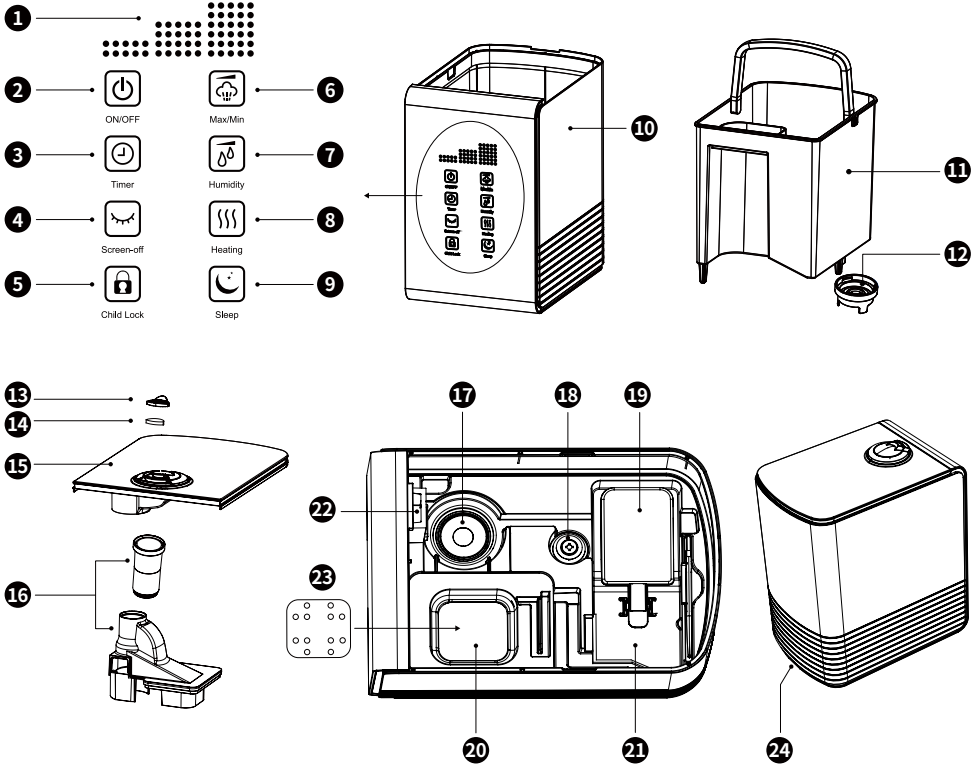

- | | | |
|----------------------|------------------------|------------------------|
| 1. LED Display | 9. Sleep Button | 17. Atomizing Plate |
| 2. ON/OFF Button | 10. Unit | 18. Water Level Sensor |
| 3. Timer Button | 11. Water Tank | 19. Float Ball |
| 4. Screen-off Button | 12. Aromatherapy Cover | 20. PTC Heater |
| 5. Child Lock Button | 13. Aromatherapy Plate | 21. Water Box |
| 6. Max/Min Button | 14. Head Cover | 22. Air Outlet |
| 7. Humidity Button | 15. Water Tank Cover | 23. Anti-scale plate |
| 8. Heating Button | 16. Air Channel | 24. Humidity Sensor |

Note:

To guarantee its accurate humidity detection, keep the humidifier (especially the humidity sensor) dry before use.

Specifications

Model	SH8820W
Capacity	5.5L
Voltage	AC 120V / 60Hz
Power	Min16W(cool mist)~ Max 280W(warm mist)
Frequency Band	2.400~2.4835GHz
Maximum Transmission Power	17.5 dBm
Space Application	430-755ft ² (40-70m ²)
Max Cool Mist Capacity	300mL/H
Max Warm Mist Capacity	600mL/H

Electrical Schematic Diagram

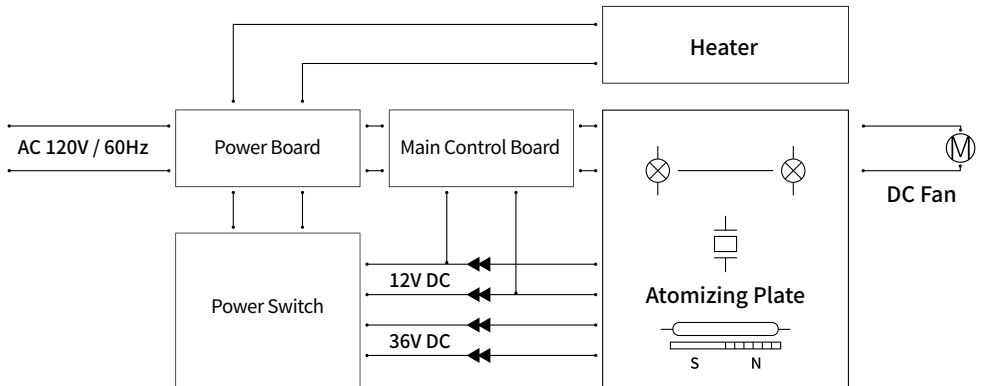

Safety Precautions

Failure to follow the instructions exactly as shown may result in fire, electric shock, and/or serious injuries.

- Only operate the device on a smooth, stable surface.
- Keep the device away from heat sources like radiators, ovens, and vents.
- Aim the mist away from furniture, appliances, and people.
- Do not scratch the atomizing plate.
- Do not touch the water or internal elements while the device is operating.

- Do not move the device while it is operating.
- Do not cover the mist nozzles.
- Do not touch the mist when in warm mist mode.
- Do not attempt to repair the device. All repairs must be performed by a qualified service professional.
- Do not let children operate the device without adult supervision.
- Do not dismantle the air channel if the tank is filled with hot water.
- Always unplug the device when not in use and store it in a cool, dry place.
- Turn off the device immediately if strange sounds or odors occur.
- Always unplug the humidifier when not in use. Drain the water tank and sink, clean, wipe, and dry all parts, and then store them in original packing box.
- This appliance can be used by children aged from 8 years and above and persons with reduced physical, sensory or mental capabilities or lack of experience and knowledge if they have been given supervision or instruction concerning use of the appliance in a safe way and understand the hazards involved. Children shall not play with the appliance. Cleaning and user maintenance shall not be made by children without supervision.
- Care should be taken when using the appliance due to the emission of hot water vapour.
- Unplug the appliance during filling and cleaning.
- If the supply cord is damaged, it must be replaced by the manufacturer, its service agent or similarly qualified persons in order to avoid a hazard.

Note: It is suggested to place on a hard level desktop rather than on carpets or towels. Otherwise, the fan at the bottom of the base will intake the cotton fiber, causing damage to the machine and resulting in breakdown.

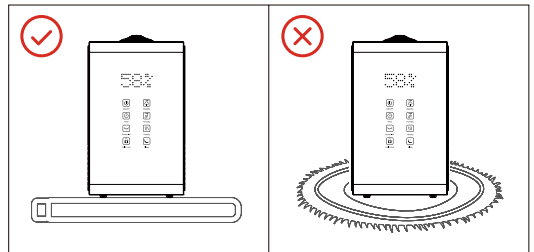

Essential Function

- This device can humidify a large area quickly and evenly.
- This humidifier can emit both warm and cool mist to cater to diverse needs.
- Thanks to the intelligent humidification, the room will remain at a fixed humidity percentage automatically.
- The steam level can be adjusted among low, medium, and high.
- The sleep function ensures ultra-quiet operation.
- The LED display can be turned off at any time.

- While in child lock mode, the control panel is deactivated to prevent children from mishandling the product.
- The dual mist nozzles can be rotated 360° independently.
- The humidifier is equipped with 12 preset timing settings.
- Add a few drops of essential oil into the aromatherapy box for a soothing aromatherapy experience.
- Water shortage protection prevents dry operation and maximizes product lifespan.
- An included remote can be used to control all functions of the humidifier.
- The Elechomes Warm and Cool Mist Humidifier is compliant with hazardous substances management ordinances.

Humidifier Operation

Operating Environment

- Only operate the humidifier in indoor environments between 41-113° F and lower than 80% relative humidity.
- Do not fill the tank with water hotter than 105° F.
- Filling the tank with purified water is recommended.

Getting Familiar with the Control Panel



ON/OFF



Max/Min



Timer



Humidity



Screen-off



Heating



Child Lock



Sleep



ON/OFF Button

Once the power cable has been successfully plugged into an outlet, a beep will sound and the humidifier will be in standby. The LED screen will display the current ambient humidity.

Press the ON/OFF button to begin operation. The LED screen will display the current humidity and the humidifying grade.

Press the ON/OFF button again to cease operation. The humidifier will go into standby and will display the current ambient humidity.

Note:

1. If the humidifier has been turned off but has not been unplugged, the previous settings will be restored automatically.
2. After the humidifier has been turned off, the internal fan will run for 3 minutes to dry the air channel and prevent bacteria generating.



Timer Button

Press the timer button to set your desired humidifying time ranging from 1 to 12 hours. Each button press adjusts the time by 1 hour. (Press and hold the button for 2s to turn off the timing setting.)

The first time the Timer button is pressed, the LED screen will display  (default mode). In default mode, the device will humidify continuously until the water runs out.

The second time the button is pressed, the LED screen will display .

The humidifier will automatically turn off after one hour. Each subsequent press of the button will increase the time by 1 hour.

LED screen displays remaining time in Hour after you complete settings. The humidifier will automatically stop work and enter standby state after time completes. The LED screen will display and flash the current ambient humidity.

You need to press ON/OFF button again to restore humidifying (it doesn't work if the device is in water shortage protection state). Once the time setting has been selected, the LED screen will display the remaining time.



Screen-off Button

1. Press screen-off button in any working state to manually turn off the LED display. It won't affect the previous operating effects.
2. Press any button to restore LED display.



Note:

The humidifier beeps 6 times and the LED display restores when the water tank is short of water under any working state except sleep mode.



Child Lock Button

Press and hold the child lock button for 3s. You will hear a beep sound and the LED screen will display

 and the control panel cannot be operated. Press and hold the child lock button for 3s to deactivate the child lock mode and the LED screen will display .

Note:

When using the remote control, just press the button to enter the child lock mode.





Max/Min Button

Press the Min/Max button to adjust mist strength. Press Max/Min once for low, twice for medium, and three times for high.

After once button press, the LED screen will display  (default high).

After the second button press, the LED screen will display  (low).

After the third button press, the LED screen will display  (medium).

After the fourth button press, the LED screen will display  (back to high).



Humidity Button

Press the Humidity button to set your desired humidity value (from 30% to 90%, each press increases level 5%). Once the room has reached your specified humidity level, the device will shut off automatically (The LED screen will display the current humidity continually). The humidifier will automatically spray mist for 1 minute after being turned on, even if the room has reached the set humidity level.

When the ambient humidity drops to 5%RH (Relative Humidity) below the set humidity, the humidifier will reactivate. The cycle will continue until the tank runs out of water or until the device is turned off.

After one button press, the LED screen will display  (default). Mist will spray no matter the ambient humidity level.

After the second button press, the LED screen will display "30%". Each subsequent press increases the humidity level by 5 %, until the maximum 90% is reached. (Press and hold the button for 2s to turn off the humidity setting.)



Heating Button

Press this button for a warm mist. Press the button again to increase mist temperature.

After one button press, the LED screen will display  (cool).

After the second button press, the LED screen will display  (low heat).

After the third button press, the LED screen will display  (medium heat).

After the fourth button press, the LED screen will display  (high heat).

It cycles when you continue to press the button.

Note:

When using the Heating Button for warm mist, always make sure it is placed in a secure location out of child's reach to avoid scalding.



Sleep Button

Once the Sleep button is pressed, the humidifier will enter sleep mode and the LED screen will display  3 times and then will turn off. While in sleep mode, button tones will be silenced. All functions can be activated in sleep mode, The heating function will turn off by default (to avoid boiling noise).

Note:

If you want to activate this function (in sleep mode), just press the Heating button again. The humidifier will continue to work as sleep mode after setup completes.

Important Notes

Note 1:

Water Shortage Alert:



The device beeps 6 times and the "ERR" icon (see above) will appear on the LED screen display if the water is insufficient. The humidifier will shut off automatically and will resume once the water is sufficient.

Note 2:

High Temperature Alert:



When the detected surface temperature of PTC is ≥ 140 °C / 284 °F or the atomized plate is detected to run dry during operation, the humidifier will automatically enter high temperature alert program. The device displays "HOT" and beeps once every second for continuous 8 times. The atomizing plate and PTC stop work, while the fan stops work after continuing 3 minutes. All buttons are invalid except ON/OFF button (the device will alert again if you press the ON/OFF button). You can only restart the humidifier after all malfunctions have been settled.

How to Use the Humidifier

1. Open the head cover (Figure 1).
2. Take the water tank out of the unit (Figure 2), fill the water tank with water and put it back to the unit; or you can pour water into the water tank, then close the cover (Figure 3);

Note:

- a. The water level must lower the tank handle.
- b. Please do not pour water into the air channel. If so, the machine will not work normally. Please pour out all the water in the machine and refill the water tank before starting the machine.
- c. Make sure to use the product with the water tank. Do not remove the water tank and pour water directly into the machine.

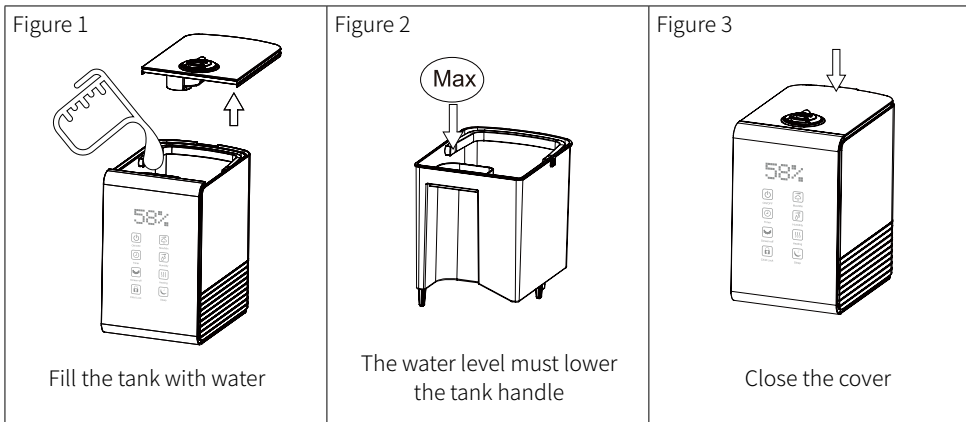

3. Plug the power cord into an outlet and press the ON/OFF button to activate the device. For information on setting adjustment, see the "Getting Familiar with the Control Panel" section.

4. For aromatherapy, follow the steps below.

- Remove the aromatherapy cover (Figure 1).
- Pour several drops of fragrance or essential oil into the box until the cotton is wet (Figure 1).
- Reinsert the aromatherapy cover and turn on the humidifier.

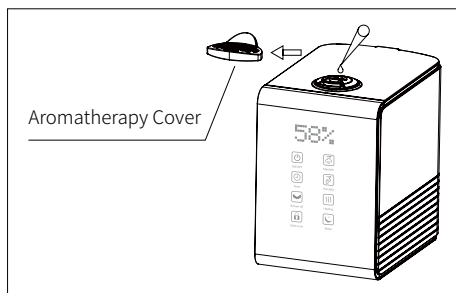

Note:

- If you no longer wish to use the aromatherapy function, simply remove the cotton, wash it in warm water, and reinsert it once it is dry.
- You can take the aromatherapy plate and insert your desired fragrance at any time.
- Do not pour fragrances, essential oils, or abrasive liquids directly into the water tank.**

Maintenance

1. Cleaning the Humidifier

The atomizing plate and heater are particularly prone to lime-scale accumulation. Clean the anti-scale cotton with clean water each time you fill the water tank, and clean the atomizing plate with dish detergent regularly (once two weeks).

Follow the cleaning method specified below:

- Before cleaning, remove the head cover, water tank, air channel and other movable parts (figure 1). These parts can be washed directly under the water faucet.

- b. Use water and brush to clean the water box and other parts in the machine. Then pour the water from the rear of the machine according to the direction shown in (figure 2). Please do not pour water from the front of the machine (figure 3) to avoid water entering the machine from the air outlet
- c. When cleaning the water tank cover and seal ring, do not distort them and the water tank, air channel, head cover should be installed back in place after finish cleaning.

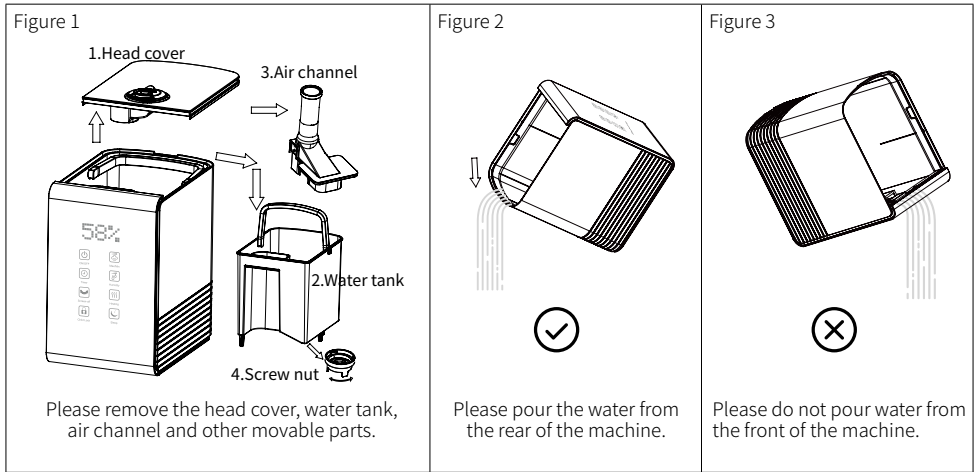

- d. Due to the higher water hardness in some areas, the surface of atomizing plate and heating plate are prone to accumulate scale. Users should wash them regularly with detergent, and clean the inside of the water tank and the water box every week under the following instruction: Place 5 drops of dish soap on the surface of the atomizing plate and 5 drops of dish soap on the heater. Pour in approximately 30mL of water. Use a dish brush or sponge to clean the atomizing plate, heater, and sink until all lime-scale is removed. Drain the dirty water and rinse the device twice.

Note: Make sure that the fan remains dry at all times.

- 2. After entering heating function, the water temperature in the water box is very high. Therefore, do not clean the machine immediately after shutting down the machine to avoid scalding. The machine should be shut down for 1 hour before cleaning.
- 3. Do not soak the water box, water tank with hot water while cleaning.
- 4. There is an air inlet at the bottom of the machine. When cleaning, do not immerse the bottom of the machine in water to avoid water entering into the machine from the air inlet and damaging the machine.

Replacing the Remote Control Battery

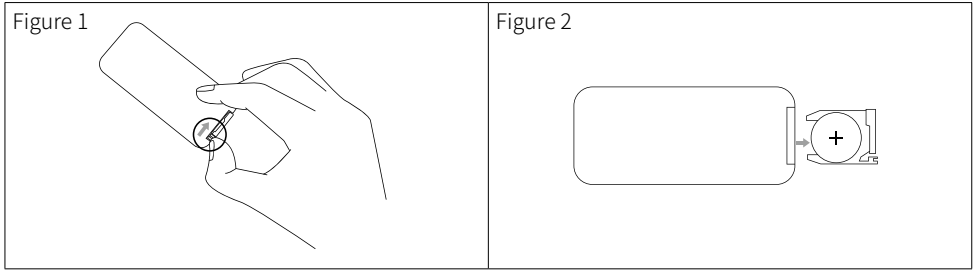

1. Press the locking tab toward the pulling slot to remove the battery compartment (figure 1).
2. Properly dispose of the old battery.
3. Place a new 3V CR2025 battery into the battery compartment with positive side facing up (figure 2).
4. Replace the battery compartment into the remote.

Note: The remote-controlled distance is 5 m (16 ft.).



Battery Safety Warning

1. WARNING: Chemical Burn Hazard. Keep batteries away from children.
2. This product contains a lithium button/coin cell battery. If a new or used lithium button/coin cell battery is swallowed or enters the body, it can cause severe internal burns and can lead to death in as little as 2 hours. Always completely secure the battery compartment. If the battery compartment does not close securely, stop using the product, remove the batteries, and keep it away from children if you think batteries might have been swallowed or placed inside any part of the body, seek immediately medical attention.
3. The cells shall be disposed of properly, including keeping them away from children;
4. Even used cells may cause injury.

Troubleshooting

Problem	Possible Reasons	Solution
The device doesn't work or shuts down abnormally.	The device is not plugged.	Plug and start the device.
The device stops working and "001" is displayed on the LED screen.	Abnormal working temperature of the PTC heater.	Unplug the device and clean the water box and PTC heater after the water temperature gets down.

The device stops working and "002" is displayed on the LED screen.	Abnormal working temperature of the atomizing plate.	Unplug the device and clean the water box and atomizing plate after the water temperature gets down.
There is no wind and mist or "003" is displayed on the LED screen.	The device has not been plugged in.	Plug the cord into an outlet.
	The device has not been turned on.	Press the ON/OFF button to start the device.
	There is foreign matter on the atomizing plate.	Clear away the foreign matter.
	There is foreign matter on mist nozzle.	Clear away the foreign matter.
	The water level in the water box is too high.	1. Unplug the device and make sure the water tank cover is covered in right place and the water level in the water box is not too high. 2. Pour out the water and refill the water tank under the guide of the user manual.
	There is not enough water in the tank.	Pour more water into the tank.
The mist has a strange smell.	The machine is brand new.	Remove the humidifier from the packaging and let it sit in a well-ventilated area for 12 hours.
	The water in tank is dirty.	Empty the tank and pour in clean water.
The humidifier is making an odd noise.	There is not enough water in the tank.	Pour more water into the tank.
	The device has been placed on an uneven surface.	Operate the device on a level surface
Mist is emitted from the sides of the nozzle.	The mist nozzle is too dry.	Soak the mist nozzle in water for a few minutes or the phenomenon will automatically disappear 30 minutes after being powered on.
"Err" is displayed on the LED screen.	Water shortage.	Fill more water into the water tank.
	Water level sensor gets stuck by foreign matter (see the "diagram section" No.18).	Check whether there is foreign matter in the water box.
	The float ball gets stuck by foreign matter (see the "diagram section" No.19)	
	The water tank is not installed correctly.	Reinstall the water tank.
The water tank is leaking.	The water tank may leak.	Do not add essential oil into the water tank.

The mist leaves white marks on the furniture.	The hardness of the water is too high.	Fill distilled water or purified water into the water tank.
		Please use the dedicated filter of Elechomes SH8820 humidifier. (This filter is available on amazon. Just search ELECHOMES and buy it)
The mist wets the floor.	The humidifier is placed directly on the ground or on a low position, therefore the vapor does not have enough time to volatilize.	It's recommended to place the humidifier on a table or chair in a higher position to allow more time to volatilize in the air.
The warm mist doesn't work.	Sleep mode is set. The humidifier won't emit warm mist in sleep mode.	Reset to other working modes.
There is no warm mist after pressing the heating button.	The activation time of the heating function is not long enough.	Make sure the heating function is on, then check the mist 1.5 hours later.
The humidifier stops working after cleaning.	The water may come into the air channel.	Follow the cleaning instructions in the user manual to prevent water from entering the air channel.
The remote control doesn't work.	The plastic insulation sheet isn't removed from the remote battery compartment.	Remove the plastic insulation sheet from the battery compartment.
There is a fan spinning sound after turning off the device.	The fan will continue to work 3 minutes to blow-dry the air channel so as to eliminate germs after powering off the humidifier.	The fan will automatically stop spinning 3 minutes later.

If your device does not work for unknown reason, please unplug the power cable and restart the machine. If this still doesn't work, please contact our Elechomes customer service for support.

FCC Statement

Changes or modifications not expressly approved by the party responsible for compliance could void the user's authority to operate the equipment.

This equipment has been tested and found to comply with the limits for a Class B digital device, pursuant to Part 15 of the FCC Rules. These limits are designed to provide reasonable protection against harmful interference in a residential installation. This equipment generates uses and can radiate radio frequency energy and, if not installed and used in accordance with the instructions, may cause harmful interference to radio communications. However, there is no guarantee that interference will not occur in a particular installation. If this equipment does cause harmful interference to radio or television reception, which can be determined by turning the equipment off and on, the user is encouraged to try to correct the interference by one or more of the following measures:

- Reorient or relocate the receiving antenna.
- Increase the separation between the equipment and receiver.
- Connect the equipment into an outlet on a circuit different from that to which the receiver is connected.
- Consult the dealer or an experienced radio/TV technician for help

This device complies with part 15 of the FCC rules. Operation is subject to the following two conditions (1) this device may not cause harmful interference, and (2) this device must accept any interference received, including interference that may cause undesired operation.

This equipment complies with FCC radiation exposure limits set forth for an uncontrolled environment. This equipment should be installed and operated with minimum distance 20cm between the radiator & your body.

WiFi Instructions

Scan and Download

- 1) Download " Elechomes " APP
- 2) Log in the APP after registration (suitable for Android or ios system)



Note:

- The first-time configuration, please keep the device and your phone consistent WiFi, which is not required later.
- Make sure your phone is connected to a secure 2.4GHz WiFi network. The Humidifier can only be set up on a secure 2.4GHz network.
- Your phone may not be able to access the internet while connecting. This is normal and temporary.

Bluetooth Mode Connection

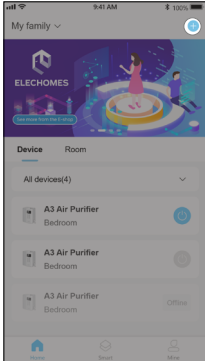

Step 1

Click the icon  on the top right corner on the home page.

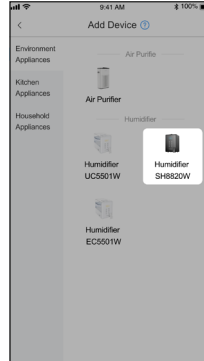

Step 2

Click Humidifier on the device list.

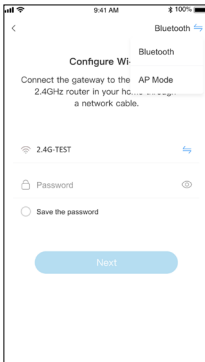

Step 3

Click the icon on the top right corner on the page to change to Bluetooth Mode. Select WiFi name (it must be 2.4GHz WiFi), and enter the password. Click [Next].





Step 4

Plug in your humidifier and do not turn on the humidifier. Click [Next].



Step 5

Press and hold the device's Max / Min button  for 3s to make sure its WiFi indicator  **blinks quickly**. Click [Next].

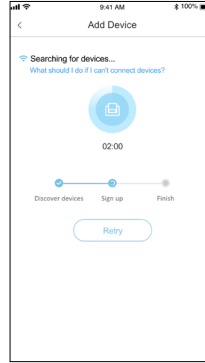

Step 6

It will automatically search for devices on this page. You can check the WiFi name and password through the pop-up window. If either is wrong, click [Retry] enter the "Configure Wi-Fi " to modify WiFi or password.

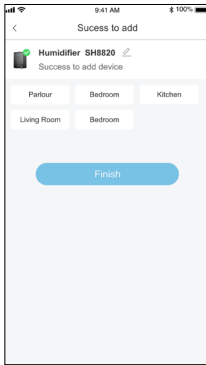

Step 7

If this page appears, your humidifer has been successfully added. You can modify the device name or set the room it locates. Click [Finish].



If the Bluetooth mode connection fails, please refer to the AP mode connection guide on the back to connect.

AP Mode Connection

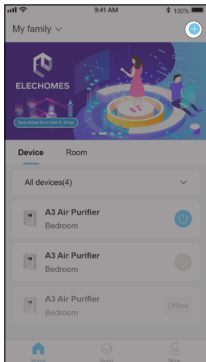

Step 1

Click the icon  on the top right corner on the home page.

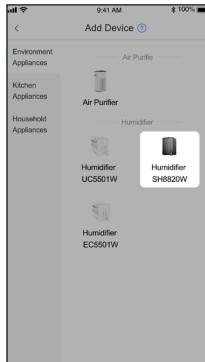

Step 2

Click Humidifier on the device list.

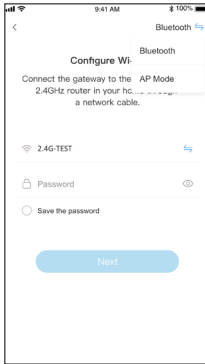

Step 3

Click the icon on the top right corner on the page to change to AP Mode. Select WiFi name (it must be 2.4GHz WiFi), and enter the password. Click [Next].



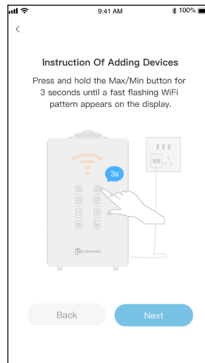

Step 4

Plug in your humidifier and do not turn on the humidifier. Click [Next].



Step 5

Press and hold the device's Max / Min button  for 3s to make sure its WiFi indicator  **blinks quickly**. Click [Next].



Step 6

Then Press and hold the device's Max / Min button  for 3s again to make sure its WiFi indicator  **blinks slowly**. Click [Next].

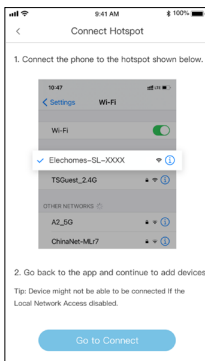

Step 7

Click [Go to Connect].

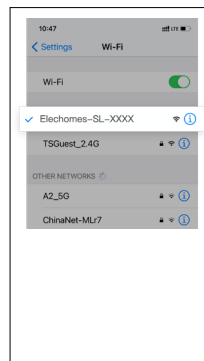

Step 8

Go to Wi-Fi setting interface of your phone, Connect to the hotspot named "Elechomes-SL-xxx".

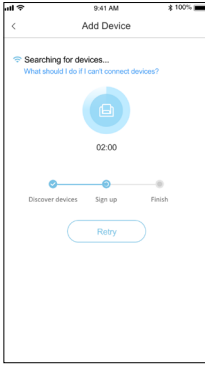

Step 9

Back to Elechomes app, it will automatically search for devices on this page. You can check the WiFi name and password through the pop-up window. If either is wrong, click [Retry] enter the "Configure Wi-Fi" to modify WiFi or password.

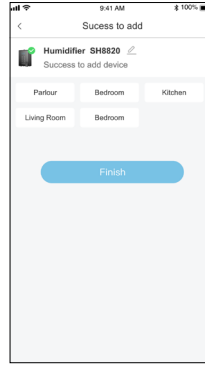

Step 10

If this page appears, your humidifer has been successfully added. You can modify the device name or set the room it locates. Click [Finish].



SMART CONTROL

Warranty Information

Product Name	Cool & Warm Mist Ultrasonic Humidifier
Model Name	SH8820
Default Warranty Period	18 Months
For your own reference, we strongly recommend that you record your order number and date of purchase.	
Date of Purchase	
Order Number	

Terms & Policy

The Elechomes products are premium in material, craftsmanship and service. They are effective from the date of purchase.

Elechomes will replace defective products based on eligibility. Refunds are available to the original purchasers of our products within the first 30 days of purchase. This warranty extends only to personal use instead of commercial, rental, or any other uses in which the product is not intended for. Each product has no other warranties other than the already provided warranties.

This warranty is non-transferable. Elechomes is not responsible for any damages, losses or inconveniences caused by equipment' s failure, user' s negligence, user' s abuse, or improper operation that does not follow the included user manual.

This warranty does not apply to the following situations:

- Damage due to abuse, accident, alteration or vandalism.
- Improper or inadequate maintenance.
- Damage in return transit.
- Unsupervised use by children under 18 years old.

Elechomes and its subsidiaries are only responsible for damages caused by the intended use or as instructed in the user manual. Some states do not allow this exclusion or limitation of incidental or consequential losses so the above disclaimer may not apply to you. This warranty gives you specific legal rights and you may also have other rights which may vary from state to state.

All expressed and implied warranties, including the warranty of merchantability, are limited to the period of the limited warranty.

Defective Products & Returns:

Should your product prove defective within the specified warranty period, please contact the Customer Support via support@elechomes.com with your invoice and order number. Once our Customer Support team has approved your request, please return the product with a copy of your invoice and order number.

Customer Support

Your satisfaction is our goal! Should you encounter any issues or have any questions about your new product, feel free to contact our Customer Support Team via support@elechomes.com.

* Please have your order invoice and order number ready before contacting Customer Support.



Note:

Filling the tank with hard water may cause limescale buildup overtime. Only use genuine Elechomes Filter to minimize limescale. To purchase more filters for your humidifier, scan the QR code or go to elechomes.com for more information.



US Importer:

Thousandshores Inc., 37707 Cherry St, Newark, CA 94560, USA

Customer Service: support@elechomes.com