

A

Tribit®

StormBox Pro Portable Wireless Speaker BTS31

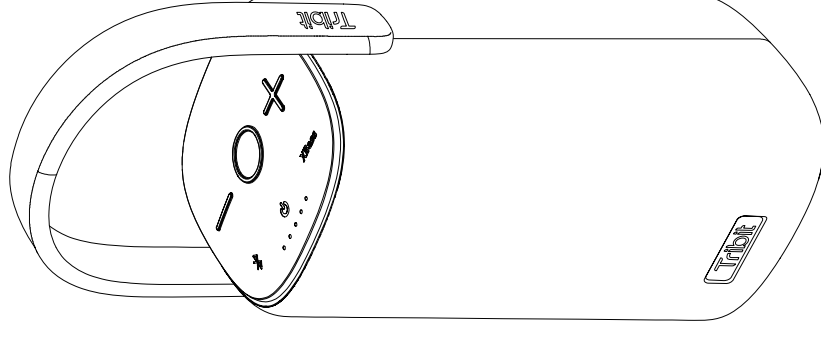

Hereby, Thousandshores Deutschland GmbH declares that the radio equipment type Portable Wireless Speaker BTS31 is in compliance with Directive 2014/53/EU.
The full text of the EU declaration conformity is available at the following internet address:
<http://files.tribit.com/bts31-de-doc.pdf>

Hiermit erklärt Thousandshores Deutschland GmbH, dass der Funkanlagentyp Portable Wireless Speaker BTS31 der Richtlinie 2014/53/EU entspricht.
Der vollständige Text der EU-Konformitätserklärung ist unter der folgenden Internetadresse verfügbar: <http://files.tribit.com/bts31-de-doc.pdf>

Learn more about the UK Declaration of Conformity, Please click below link to download.
<http://files.tribit.com/bts31-uk-doc.pdf>

English User Manual
Benutzerhandbuch
Guide Utilisateur
Manual de Usuario
取扱説明書

English User Manual	01
Benutzerhandbuch	14
Guide Utilisateur	26
Manual de Usuario	38
Manuale Utente	50
取扱説明書	62
用戶手冊	74

Packing List

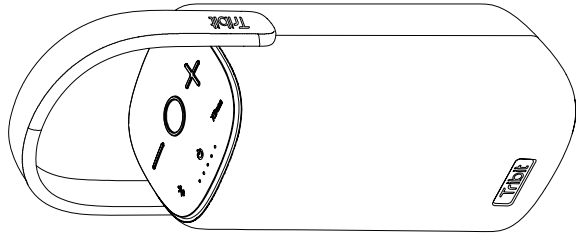

StormBox Pro



User Manual

User Manual



USB-C charging cable

1

Product Illustration

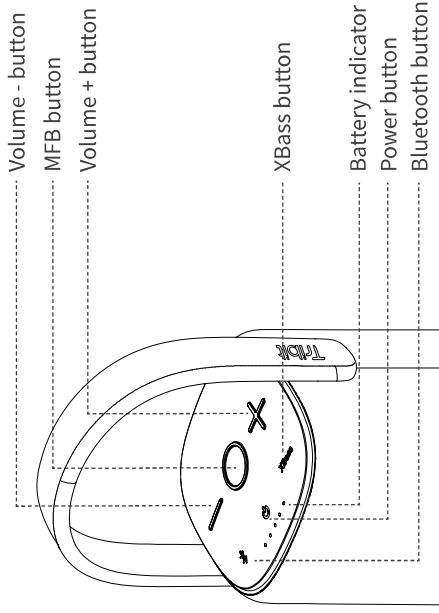

Volume - button

MFB button

Volume + button

XBass button

Battery indicator

Power button

Bluetooth button

Charging out

Charging in

2

Charging

1. To Charge the Speaker

Connect this speaker to a 5V power outlet via the provided USB-C charging cable.

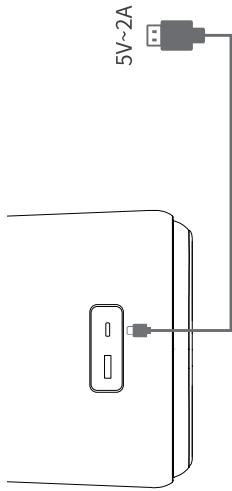

2.To Charge Other Devices

Connect the speaker with your USB-enabled device via a USB-A charging cable(not included).

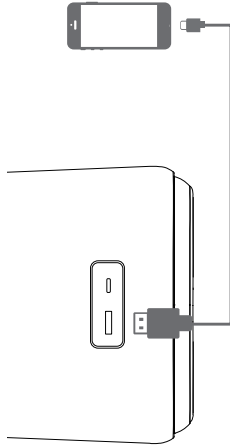

3.Charging Indicator

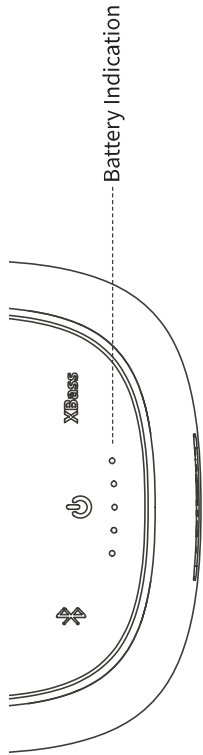

	Red indicator is flashing	Low battery
	White indicator is flashing	Charging
	All indicators turn off	Fully charged

4. Battery Indication

	10-30%		30-50%		50-70%		70-80%		80-100%		Fully charged
--	--------	--	--------	--	--------	--	--------	--	---------	--	---------------

Button Controls

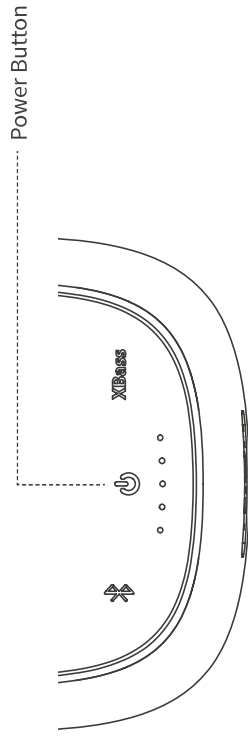

1. Power on/off

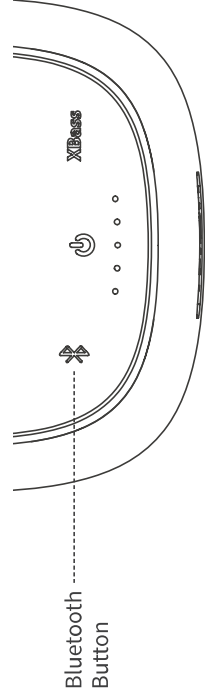

	Short press	Power on		White indicator is on
	Short press	Power off		All indicators turn off

2. Bluetooth Connection



	Press and hold it for 1s	Enters pairing mode		Blue indicator is flashing	Pairing status
--	--------------------------	---------------------	---	----------------------------	----------------

- The StormBox Pro Speaker will automatically connect to the last 1 paired devices again if available. If it fails, the speaker will enter to pairing mode.
- You can connect this speaker with multiple devices and control the connection via  Bluetooth button.
- The speaker can remember up to 8 paired Bluetooth devices.
- Better still, it can connect to 2 devices simultaneously at a time.

3. Conversion between 2 Connected Devices

- 1)Pause the playback of the current device
- 2)Play the audio file of the other device

4.Volume Adjustment

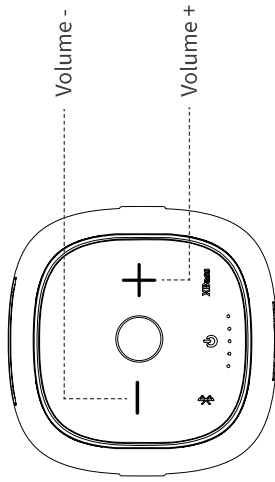

-	Short press	Decrease volume
	Keep it pressed for seconds	Continuously decrease volume
+	Short press	Increase volume
	Keep it pressed for seconds	Continuously increase volume

5. Multifunctional Button (MFB)

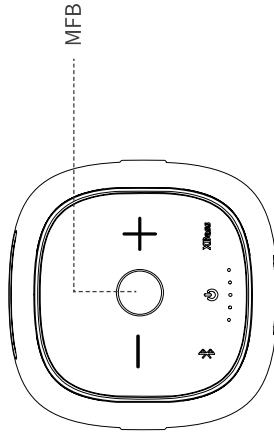

Music Mode	Short press	Play/Pause
	Double press	Next Track
	Press it for 3 times	Previous Track
Conversation Mode	Press and hold it for 1s	Activate Siri
	Short press	Answer / End phone call
	Press and hold it for 1s	Reject phone call
	Press and hold it for 1s (during a call)	Pause the current call and answer the incoming call
	Short press (during a three-way calling)	Switch between two phone calls
	Press and hold it for 1s (during a three-way calling)	End the call with the caller in the line.

6. XBass Function

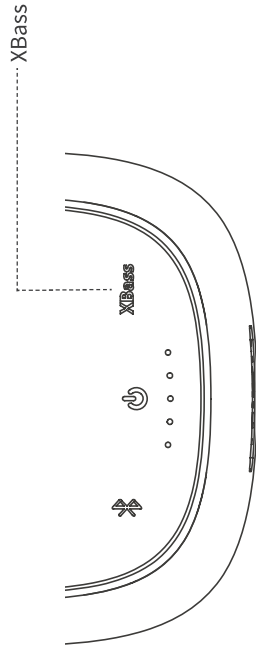

Short press the **XBass** button to activate the XBass function, then the XBass indicator will glow white.

Short press this button again to turn off the XBass function, and the XBass indicator will light off.

7. Stereo mode

1) Make sure both of two speakers are turned on.

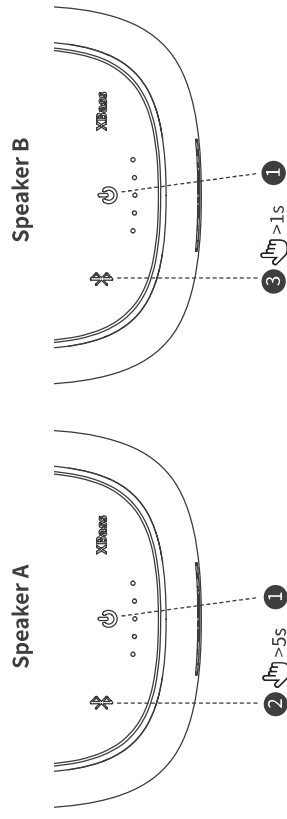

2) Long press the Bluetooth button of the speaker A for 5s to enter the Stereo Mode pairing (Note: this speaker will be regarded as the main speaker);

3) Short press the Bluetooth button of the speaker B to enter the pairing mode (Note: this speaker will be regarded as a secondary speaker);

4) When you hear the prompt sound "stereo mode", the pairing is successful and the speaker A & speaker B enter the Stereo Mode. At this time, the main speaker will broadcast "left channel" and the secondary speaker will broadcast "right channel".

Note: The function of Stereo mode can be realized only when you have 2 Tribit StormBox Pro speakers.

8. Party mode

- 1) Make sure both two speakers have entered Stereo mode.

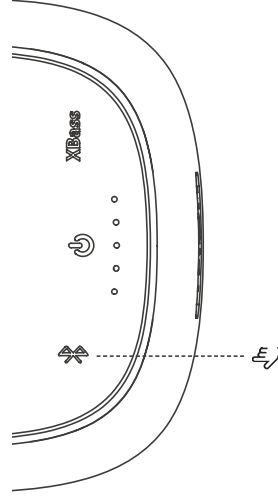

- 2) Short press the Party mode button on any of the two speakers.
- 3) When you hear the voice of "Party mode", the party mode is activated.

Note: The function of party mode can be realized only when you have 2 Tribit StormBox Pro speakers.

9. Conversion between Party Mode and Stereo Mode

Short press the Party mode button on any of the two speakers.

10. Disable the Party Mode or Stereo Mode

Press and hold the Party mode button for 5s on any of the two speakers, then both will re-enter Bluetooth pairing mode.

11. Factory Reset

Press and hold the Volume \downarrow and \uparrow button for 5s simultaneously to clear the pairing list and all settings, and the speaker will restore factory state.

Specifications

Bluetooth Version	5.3
Output Power	40W
Frequency	60Hz-20KHz
Frequency band	2.402GHz~2.480GHz
Maximum transmission power	\leq 6 dBm
Battery Type	(3.6V 5000mAh*2)/ 36Wh
Charging Time	6 hours @5V/2A
Dimensions	96 x 96 x 180 mm
Waterproof Grade	IP67

FCC Statement

Changes or modifications not expressly approved by the party responsible for compliance could void the user's authority to operate the equipment.

This equipment has been tested and found to comply with the limits for a Class B digital device, pursuant to Part 15 of the FCC Rules. These limits are designed to provide reasonable protection against harmful interference in a residential installation. This equipment generates uses and can radiate radio frequency energy and, if not installed and used in accordance with the instructions, may cause harmful interference to radio communications. However, there is no guarantee that interference will not occur in a particular installation. If this equipment does cause harmful interference to radio or television reception, which can be determined by turning the equipment off and on, the user is encouraged to try to correct the interference by one or more of the following measures:

- Reorient or relocate the receiving antenna.
- Increase the separation between the equipment and receiver.
- Connect the equipment into an outlet on a circuit different from that to which the receiver is connected.
- Consult the dealer or an experienced radio/TV technician for help

This device complies with part 15 of the FCC rules. Operation is subject to the following two conditions (1) this device may not cause harmful interference, and (2) this device must accept any interference received, including interference that may cause undesired operation. This equipment complies with FCC radiation exposure limits set forth for an uncontrolled environment. This equipment should be installed and operated with minimum distance 10mm between the radiator & your body.

IC Caution

This device complies with Industry Canada licence-exempt RSS standard(s).

Operation is subject to the following two conditions: (1) This device may not cause interference, and (2) This device must accept any interference, including interference that may cause undesired operation of the device.

Le présent appareil est conforme aux CNR d'Industrie Canada applicables aux appareils radio exempts de licence.

L'exploitation est autorisée aux deux conditions suivantes: (1) l'appareil ne doit pas produire de brouillage, et (2) l'utilisateur de l'appareil doit accepter tout brouillage radioélectrique subi, même si le brouillage est susceptible d'entraîner une compromission du fonctionnement.

This equipment complies with ICSED radiation exposure limits set forth for an uncontrolled environment. This equipment should be installed and operated with minimum distance 10mm between the radiator & your body
Cet équipement est conforme aux limites d'exposition aux rayonnements ICSE établies pour un environnement non contrôlé. Cet équipement doit être installé et utilisé avec une distance minimale de 10 mm entre le radiateur et votre corps

Packliste

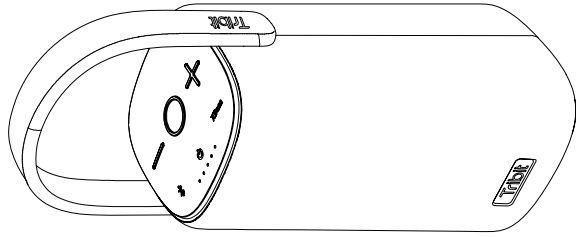

StromBox Pro



User Manual

Bedienungsanleitung



USB-C Ladekabel

Produkt-Abbildung

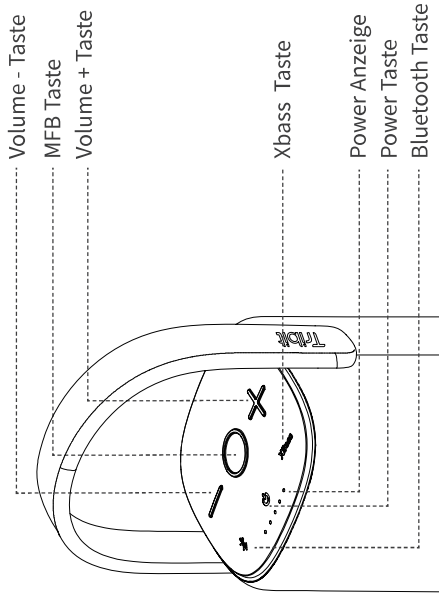

Volume - Taste

MFB Taste

Volume + Taste

Xbass Taste

Power Anzeige

Power Taste

Bluetooth Taste

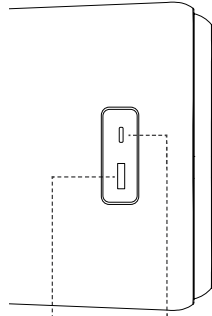

Ladeausgang

Ladeingang

Laden

1. Um den Lautsprecher aufzuladen

Schließen Sie diesen Lautsprecher über das mitgelieferte USB-C-Ladekabel an eine 5-V-Steckdose an.

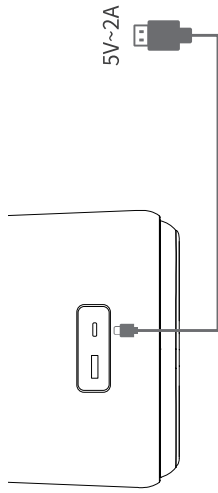

2. Um andere Geräte aufzuladen

Verbinden Sie den Lautsprecher mit Ihrem USB-fähigen Gerät über ein USB-A-Ladekabel (nicht im Lieferumfang enthalten).

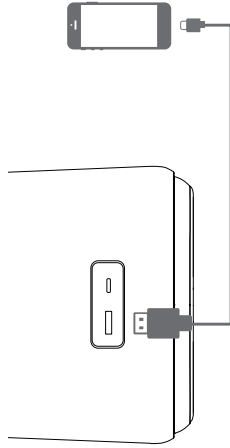

17

3. Ladeanzeige

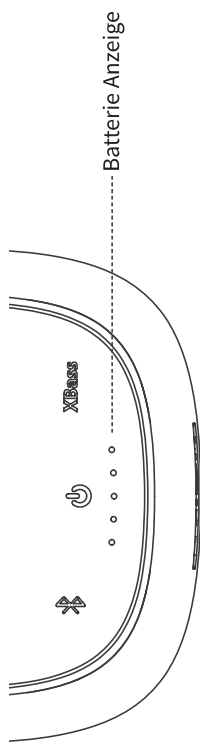

	Rote Anzeige blinkt	Batterie schwach
	Weißer Anzeige blinkt	Aufladen
	Alle Anzeigen schalten sich aus	Vollständig geladen

4. Battery Indication

							Vollständig geladen
							80-100%
							70-80%
							50-70%
							30-50%
							10-30%

18

Schaltflächen-Steuerelemente

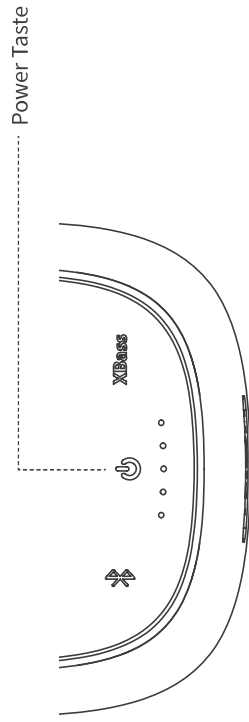

1. Power on/off

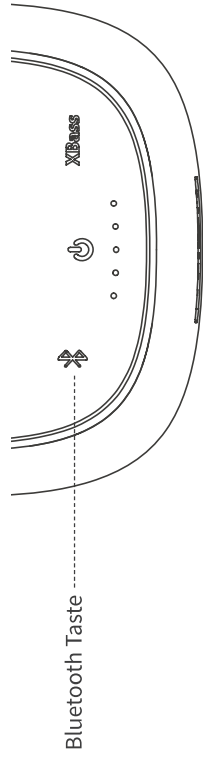

	Kurzes Drücken	Einschalten		Weißleuchte leuchtet
	Kurzes Drücken	Ausschalten		Alle Anzeigen schalten sich aus

2. Bluetooth Connection



	Drücken Sie die Taste und halten Sie sie 1 Sekunde lang gedrückt.		Eintritt in den Kopplungsmodus		Blaue Anzeige blinkt	Status der Kopplung
--	---	---	--------------------------------	---	----------------------	---------------------

- Der StormBox Revolution Lautsprecher stellt automatisch wieder eine Verbindung zu den letzten 1 gekoppelten Geräten her, falls verfügbar. Wenn dies fehlschlägt, wechselt der Lautsprecher in den Verbindungsmodus.
- Sie können diesen Lautsprecher mit mehreren Geräten verbinden und die Verbindung über die  Bluetooth-Taste steuern.
- Der Lautsprecher kann sich bis zu 8 gepaarte Bluetooth-Geräte merken.
- Besser noch, er kann mit 2 Geräten gleichzeitig eine Verbindung herstellen.

3. Konvertierung zwischen 2 angeschlossenen Geräten

- 1) Pausieren der Wiedergabe des aktuellen Geräts.
- 2) Spielen Sie die Audiodatei des anderen Geräts.

4. Volumen-Anpassung

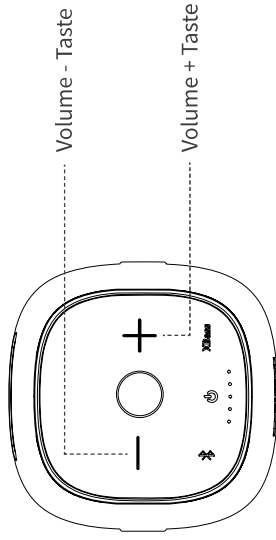

-	Kurzes Drücken	Lautstärke verringern
	Sekundenlang gedrückt halten	Kontinuierliche Verringerung des Volumens
+	Kurzes Drücken	Volumen erhöhen
	Sekundenlang gedrückt halten	Kontinuierliche Erhöhung des Volumens

5. Multifunctional Taste (MFB)

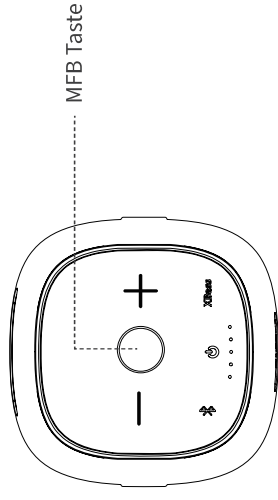

Musik-Modus	Kurzes Drücken	Abspielen/Pause beenden
	Doppelte Presse	Nächster Track
	3 Mal drücken	Vorheriger Track
Konversationsmodus	Drücken und 1s lang halten	Siri aktivieren
	Kurzes Drücken	Telefongespräch beantworten / beenden
	Drücken und 1s lang halten	Telefonanruf ablehnen
	Drücken und 1s lang halten (während eines Gesprächs)	Halten Sie den aktuellen Anruf an und beantworten Sie den eingehenden Anruf
	Kurzes Drücken (während eines Dreiergesprächs)	Zwischen zwei Telefongesprächen umschalten
	Drücken und 1s lang halten (während eines Dreiergesprächs)	Aktuellen Anruf beenden

6. XBass Funktion

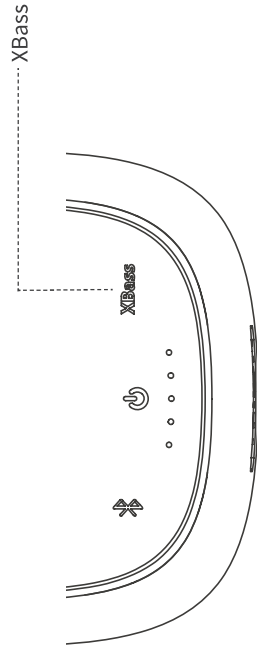

Drücken Sie kurz auf die XBass-Taste, um die XBass-Funktion zu aktivieren, dann leuchtet die XBass-Anzeige weiß.

Drücken Sie diese Taste erneut kurz, um die XBass-Funktion auszuschalten, dann leuchtet die XBass-Anzeige nicht mehr.

7. Stereo Modus

1) Stellen Sie sicher, dass beide von zwei Lautsprechern eingeschaltet sind.

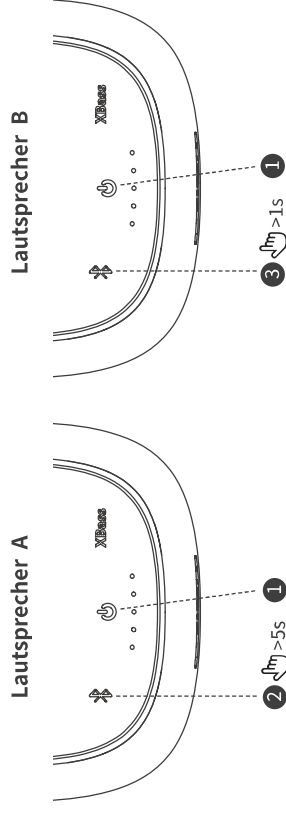

2) Drücken Sie die Bluetooth-Taste  des Lautsprechers A 5 Sekunden lang, um die Kopplung im Stereo-Modus zu aktivieren (Hinweis: Dieser Lautsprecher wird als Hauptlautsprecher betrachtet);

3) Drücken Sie die Bluetooth-Taste  des Lautsprechers B kurz, um den Kopplungsmodus aufzurufen (Hinweis: Dieser Lautsprecher wird als Zweitlautsprecher betrachtet);

4) Wenn Sie die Aufforderung "stereo mode" hören, ist das Koppeln erfolgreich und die Lautsprecher A und B wechseln in den Stereo-Modus. Zu diesem Zeitpunkt sendet der Hauptlautsprecher "left channel" und der Zweitlautsprecher "right channel".

Hinweis: Die Funktion des Stereo-Modus kann nur realisiert werden, wenn Sie 2 Tribit Stormbox Pro-Lautsprecher haben.

8. Party Modus

1) Vergewissern Sie sich, dass beide zwei Lautsprecher in den Party-Modus gegangen sind.

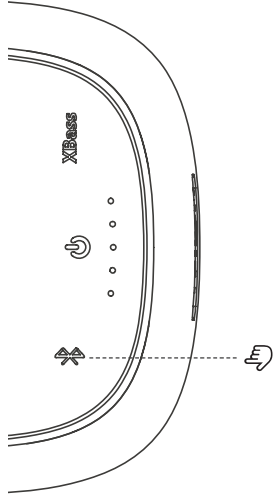

2) Drücken Sie kurz die Bluetooth-Taste an einem der beiden Lautsprecher.

3) Zu diesem Zeitpunkt hören Sie einen "Party-Modus" und die Lautsprecher wechseln in den Party-Modus.

Hinweis: Die Funktion des Party modus kann nur realisiert werden, wenn Sie 2 Tribit StormBox Pro-Lautsprecher haben.

9. Konvertierung zwischen Party-Modus und Stereo-Modus

Drücken Sie kurz die Bluetooth-Taste an einem der beiden Lautsprecher.

10. Deaktivieren des Party- oder Stereo-Modus

Halten Sie die Lautstärketaste + und - 5 Sekunden lang gleichzeitig gedrückt, um die Paarungsliste und alle Einstellungen zu löschen, und der Lautsprecher stellt den Werkzustand wieder her.

11. Werkrückstellung

Halten Sie die Lautstärketaste + und - 5 Sekunden lang gleichzeitig gedrückt, um die Paarungsliste und alle Einstellungen zu löschen, und der Lautsprecher stellt den Werkzustand wieder her..

Spezifikationen

Bluetooth-Version	5.3
Ausgangsleistung	40W
Häufigkeit	60Hz-20KHz
Begrenzung des Bandes	2.402GHz~2.480GHz
Maximale Übertragungsleistung	≤ 6dBm
Batterie-Typ	(3.6V 5000mAh*2)/ 36Wh
Aufladezeit	6 stunden @5V/2A
Abmessungen	96 x 96 x 180 mm
Wasserdichte Sorte	IP67

Contenu du colis

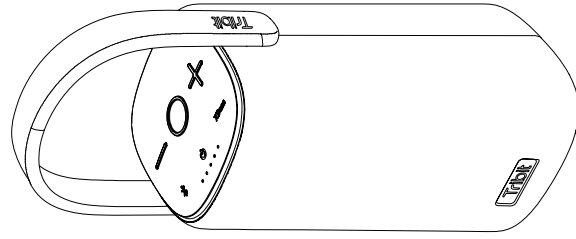

StromBox Pro



User Manual

Manuel d'utilisation



Câble de chargement USB-C

27

Présentation du produit

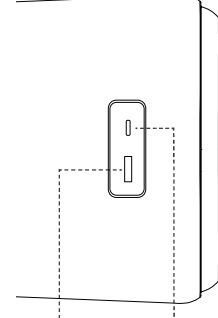
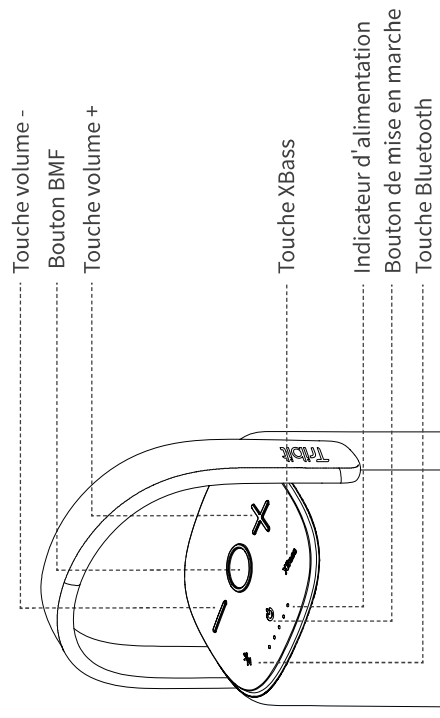

Recharger la batterie

Mise en charge

28

Chargement

1. Charger le haut-parleur

Connectez ce haut-parleur à une prise de courant de 5V par le câble de chargement USB-C fourni.

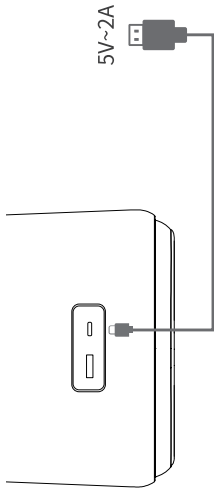

2. Charger d'autres appareils

Connectez le haut-parleur à votre dispositif USB par un câble de chargement USB-A (non inclus).

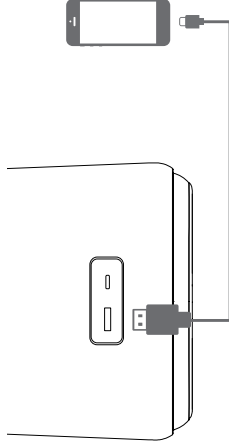

29

3. Indicateur de charge

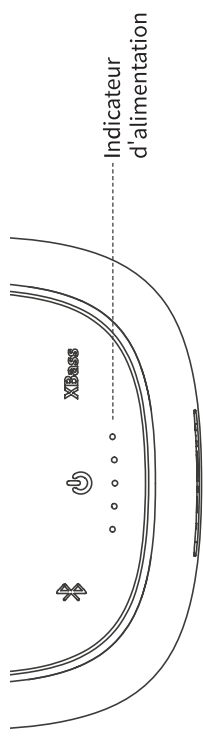

	Le voyant rouge clignote	Batterie faible
	Le voyant blanc clignote	En charge
	Tous les voyants s'éteignent	Entièrement chargé

4. Battery Indication



					Entièrement chargé
					80-100%
					70-80%
					50-70%
					30-50%
					10-30%

30

Boutons de commande

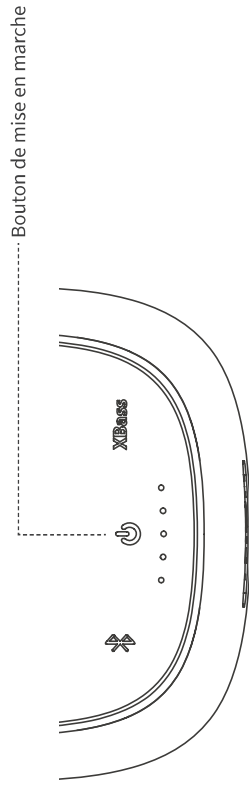

1. Mise en marche/arrêt



	Appuyer brièvement	Mise en marche		Le voyant blanc est allumé
	Appuyer brièvement	Arrêt		Tous les voyants s'éteignent

2. Connection Bluetooth



	Appuyer et maintenir pendant 1s	Entre en mode d'appariement		Le voyant bleu clignote	État d'appariement
--	---------------------------------	-----------------------------	---	-------------------------	--------------------

- Le haut-parleur StormBox Pro se connectera automatiquement aux 1 derniers appareils appariés, s'ils sont disponibles. En cas d'échec, il passera en mode d'appariage.
- Vous pouvez connecter ce haut-parleur à plusieurs appareils et contrôler la connexion par le bouton Bluetooth .
- Le haut-parleur peut mémoriser jusqu'à 8 appareils Bluetooth appariés.
- Mieux encore, il peut se connecter à 2 appareils simultanément.

3. Passage entre 2 appareils connectés

- 1) Mettez en pause la reproduction de l'appareil en cours.
- 2) Faites jouer le fichier audio de l'autre appareil.

4. Ajustement du volume

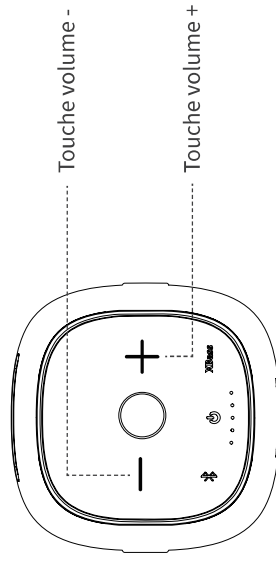

-	Appuyer brièvement	Diminuer le volume
	Maintenir la pression pendant quelques secondes	Diminuer continuellement le volume
+	Appuyer brièvement	Augmenter le volume
	Maintenir la pression pendant quelques secondes	Augmenter continuellement le volume

5. Bouton multifonctionnel (BMF)

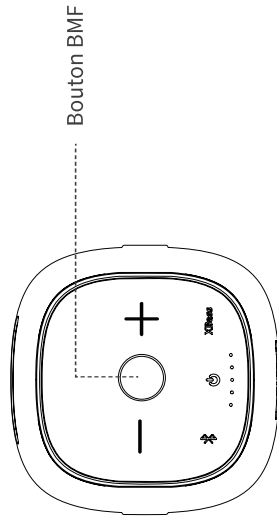

Mode Musique	Brève pression	Jeu/Pause
	Double pression	Prochaine morceau
	Appuyer 3 fois sur le bouton	Morceau précédent
Mode conversation	Appuyer et maintenir pendant 1s	Activer Siri
	Brève pression	Répondre / Mettre fin à l'appel
	Appuyer et maintenir pendant 1s	Rejeter l'appel
	Appuyer et maintenir pendant 1s (pendant un appel)	Pause de l'appel en cours et réponse à l'appel entrant
	Brève pression (pendant un appel à trois)	Passer d'un appel téléphonique à l'autre
	Appuyer et maintenir pendant 1s (pendant un appel à trois)	Raccrocher l'appel en cours

6. Fonction XBass

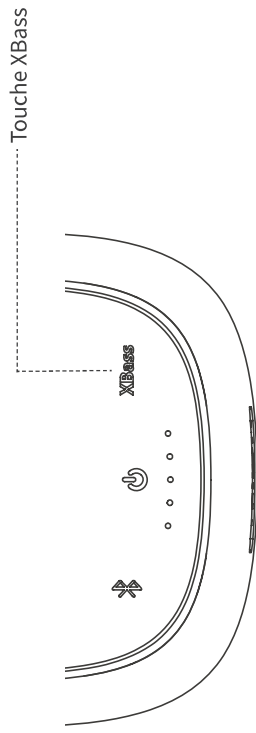

Appuyez brièvement sur le bouton XBass pour activer la fonction XBass, puis son voyant s'allumera en blanc.

Appuyez brièvement sur ce bouton pour désactiver la fonction XBass, et le voyant s'éteindra.

7. Mode stéréo

1) Assurez-vous que les deux haut-parleurs sont allumés.

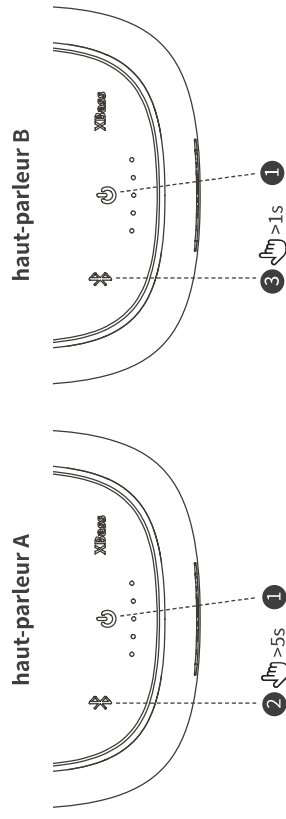

2) Maintenez brièvement le bouton Bluetooth du haut-parleur A pendant 5 secondes pour entrer en mode d'emparement stéréo (Note: ce haut-parleur sera considéré comme le haut-parleur principal);

3) Pressez brièvement le bouton Bluetooth du haut-parleur B pour entrer en mode d'emparement stéréo (Note: ce haut-parleur sera considéré comme le haut-parleur secondaire);

4) Lorsque vous écoutez le son en "mode stéréo", l'emparement sera réussi et les haut-parleurs A et B entreront en mode stéréo. En ce moment, le haut-parleur principal transmettra le "canal gauche" et le secondaire transmettra le "canal droit".

Note: La fonction du mode stéréo ne peut être réalisée que lorsque vous disposez de 2 haut-parleurs Tribit StormBox Pro.

8. Mode fête

1) Assurez-vous que les deux haut-parleurs sont en mode "party".

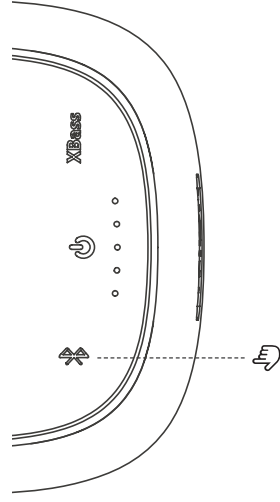

2) Appuyez brièvement sur le bouton Bluetooth de l'un des deux haut-parleurs.

3) À ce moment, vous entendrez le son "Party mode" et les haut-parleurs passeront en mode fête.

Note: La fonction du mode fête ne peut être réalisée que lorsque vous disposez de 2 haut-parleurs Tribit StormBox Pro.

9. Conversion entre le mode fête et le mode stéréo

Appuyez brièvement sur le bouton Bluetooth de l'un des deux haut-parleurs.

10. Désactiver le mode fête ou le mode stéréo

Appuyez sur le bouton Bluetooth et maintenez-le enfoncé pendant 5s sur l'un des deux haut-parleurs, puis les deux reviendront en mode de couplage Bluetooth.

11. Réinitialisation

Appuyez simultanément sur les boutons Volume + et — pendant 5s pour effacer la liste d'appariement et tous les réglages, et le haut-parleur retrouvera son état d'origine.

Caractéristiques

Version Bluetooth	5.3
Puissance de sortie	40W
Fréquence	60Hz-20KHz
Gamme de fréquences	2.402GHz-2.480GHz
Puissance de transmission maximale	≤ 6dBm
Type de batterie	(3.6V 5000mAh*2) / 36Wh
Temps de chargement	6 heures à 5V/2A
Dimensions	96 x 96 x 180 mm
Degré d'étanchéité	IP67

Contenido del paquete

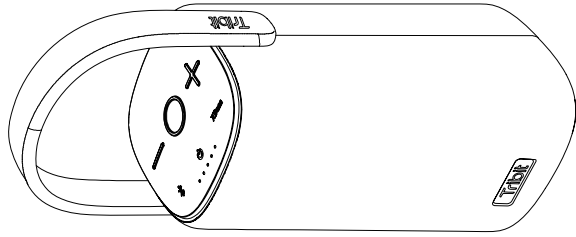

StromBox Pro



User Manual

Manual de Usuario



Cable de carga USB-C

Ilustración del producto

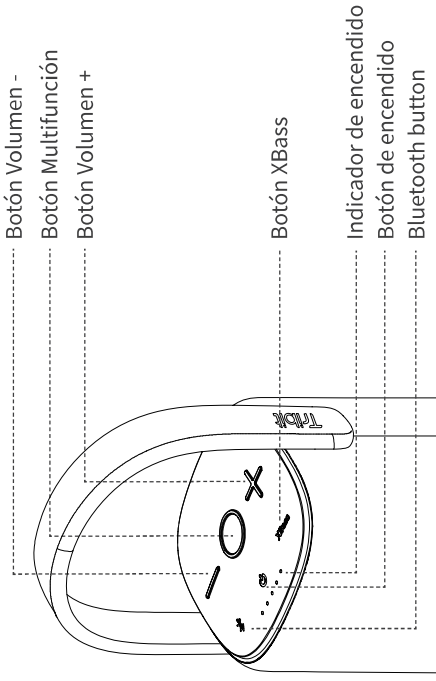

Botón Volumen -

Botón Multifunción

Botón Volumen +

Botón XBass

Indicador de encendido

Botón de encendido

Bluetooth button

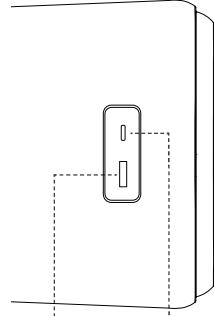

Carga finalizada

Carga en curso

Carga

1. Para cargar el altavoz

Conecte el altavoz a una toma de corriente de 5V a través del cable de carga USB-C.

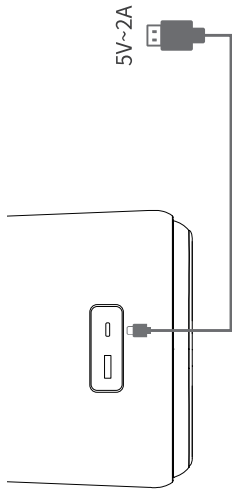

2. Para cargar otros dispositivos

Conecte el altavoz con su dispositivo con USB a través de un cable de carga USB-A (no incluido).

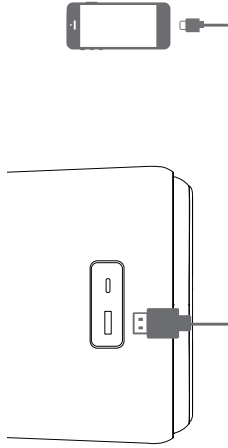

3. Indicador de carga

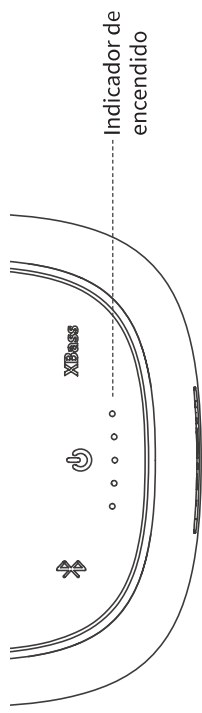

	El indicador rojo parpadea.	Batería baja
	El indicador blanco parpadea.	Cargando
	Todos los indicadores se apagan	Carga completa



4. Indicador de batería

10-30%	30-50%	50-70%	70-80%	80-100%
				Carga completa

Controles de botones

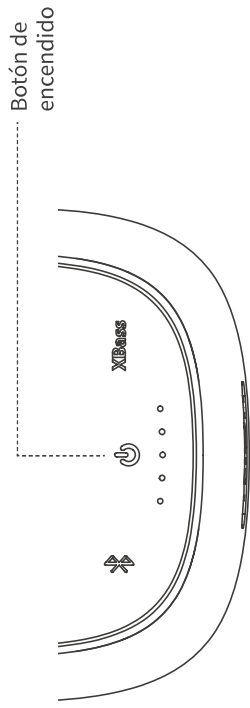

1. Encendido / apagado

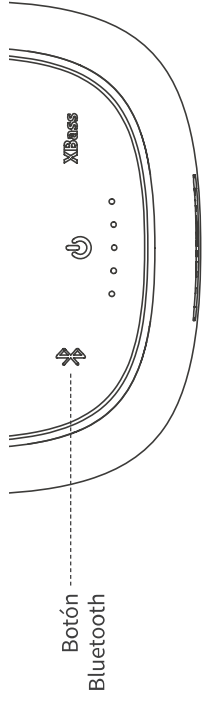

	Pulsación corta	Encendido		El indicador blanco está encendido Todos los indicadores se apagan
	Pulsación corta	Apagado		

2. Conexión Bluetooth



	Mantenga presionado durante 1 segundos		Entra en modo de emparejamiento		El indicador azul parpadea	Estado de emparejamiento
---	--	---	---------------------------------	---	----------------------------	--------------------------

- El altavoz StormBox Pro se conectará automáticamente a los últimos 1 dispositivos emparejados nuevamente si están disponibles. Si falla, el altavoz se pondrá en modo emparejamiento.
- Puede conectar este altavoz con múltiples dispositivos y controlar la conexión a través del botón Bluetooth .
- El altavoz puede recordar hasta 8 dispositivos Bluetooth emparejados.
- Además, se puede conectar a 2 dispositivos simultáneamente.

3. Cambio entre 2 dispositivos conectados

- 1) Pausa la reproducción del dispositivo actual.
- 2) Reproduzca el archivo de audio del otro dispositivo.

4. Ajuste del volumen

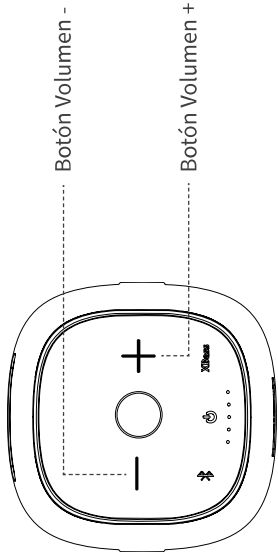

-	Pulsación corta	Disminuir el volumen
	Mantenlo presionado por segundos	Disminuir continuamente el volumen
+	Pulsación corta	Aumentar el volumen
	Mantenlo presionado por segundos	Aumentar continuamente el volumen

5. Botón Multifunción

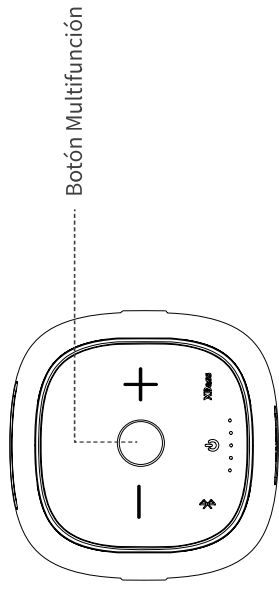

Modo música	Pulsación corta	Play/Pausa
	Doble pulsación	Siguiente pista
	Mantenga presionado 3 segundos	Pista anterior
Modo conversación	Mantenga presionado 1 segundo	Activar Siri
	Pulsación corta	Contestar / finalizar llamada
	Mantenga presionado 1 segundo	Rechazar la llamada
	Mantenga presionado 1 segundo (durante una llamada)	Pausa la llamada actual y contesta la llamada entrante
	Pulsación corta (durante una llamada a tres)	Cambiar entre dos llamadas telefónicas
	Mantenga presionado 1 segundo (durante una llamada a tres)	Colgar la llamada actual

6. Función XBass

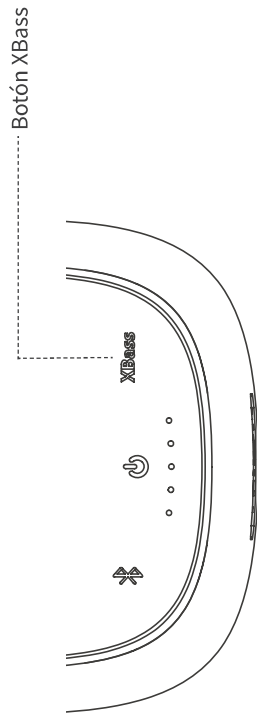

Presione brevemente el botón XBass para activar la función XBass, el indicador se iluminará en blanco.

Presione brevemente este botón nuevamente para apagar la función XBass, y el indicador XBass se apagará.

7. Modo Stereo

1) Asegúrese de que ambos altavoces estén encendidos.

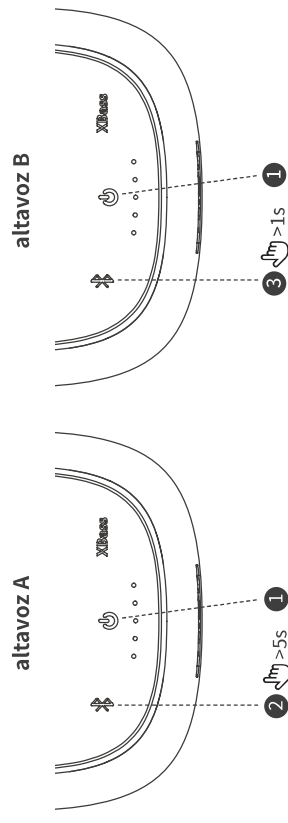

- 2) Premere il pulsante Bluetooth dell'altoparlante A per 5 secondi: per entrare nella modalità di accoppiamento Stereo (Nota: questo altoparlante sarà considerato come l'altoparlante principale);
- 3) Premere brevemente il pulsante Bluetooth dell'altoparlante B per entrare nella modalità di accoppiamento (Nota: questo altoparlante sarà considerato come un altoparlante secondario);
- 4) Quando si sente il segnale acustico "stereo mode", il collegamento è riuscito e l'altoparlante A e l'altoparlante B entrano in modalità stereo. A questo punto, l'altoparlante principale emetterà "left channel" e l'altoparlante secondario emetterà "right channel".

Nota: La función estéreo solo se puede realizar entre 2 altavoces Tribit StormBox Pro.

8. Modo Fiesta

1) Asegúrese de que los dos altavoces estén en modo fiesta.

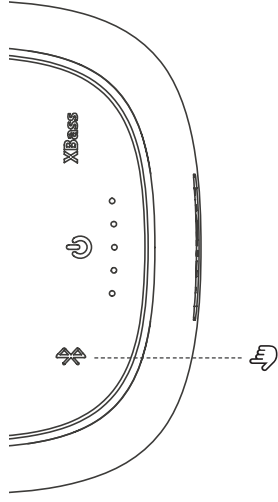

- 2) Presione brevemente el botón Bluetooth en cualquiera de los dos altavoces.
- 3) En este momento, escuchará el sonido "Party Mode" y los altavoces entrarán en modo fiesta.

Nota: Esta función solo se puede realizar entre 2 altavoces Tribit Stormbox Pro.

9. Cambio entre modo fiesta y modo estéreo

Presione brevemente el botón Bluetooth en cualquiera de los dos altavoces.

10. Desactivar el modo fiesta o el modo estéreo

Mantenga presionado el botón Bluetooth durante 5 segundos en cualquiera de los dos altavoces, luego ambos volverán al modo de emparejamiento Bluetooth.

11. Restablecimiento de fábrica

Mantenga presionado el botón Volumen + y - durante 5 segundos a la vez para borrar la lista de emparejamiento y todas las configuraciones, y el altavoz restaurará el estado de fábrica.

Especificaciones

Versión Bluetooth	5.3
Potencia de salida	40W
Frecuencia	60Hz-20KHz
Rango de frecuencia	2.402GHz-2.480GHz
Potencia máxima de transmisión	≤ 6dBm
Tipo de batería	(3.6V 5000mAh*2)/ 36Wh
Tiempo de carga	6 horas a 5V / 2A
Dimensiones	96 x 96 x 180 mm
Grado de impermeabilidad	IP67

Contenuto della Confezione

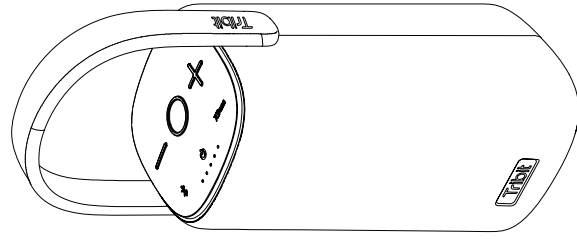

StormBox Pro



User Manual

Manuale Utente



cavo di ricarica USB-C

Illustrazione Prodotto

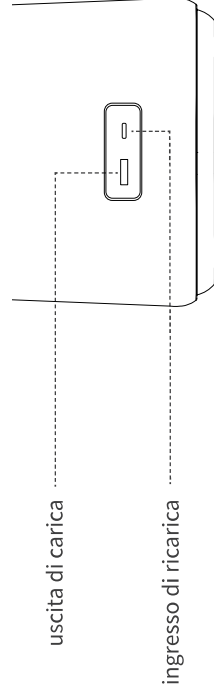
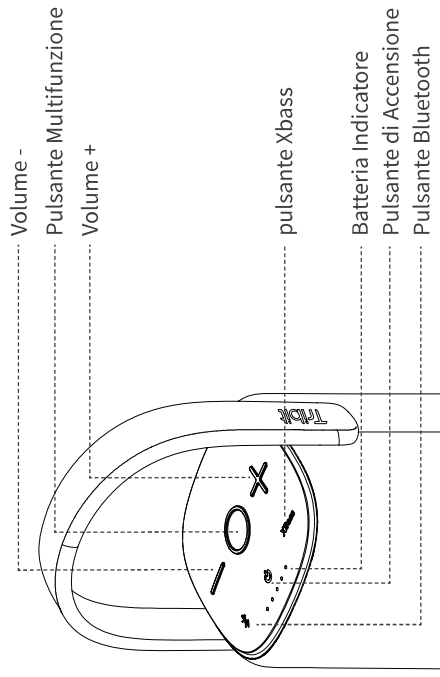

Ricaricare

1. Ricaricare l'Altoparlante

Connetti questo altoparlante con una presa alimentatore da 5V tramite il cavo di ricarica USB-C fornito.

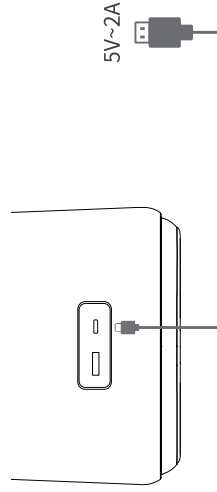

2.2. Caricare gli Altri Dispositivi

Connettere l'altoparlante con il dispositivo abilitato USB via cavo di ricarica USB-A (non incluso).

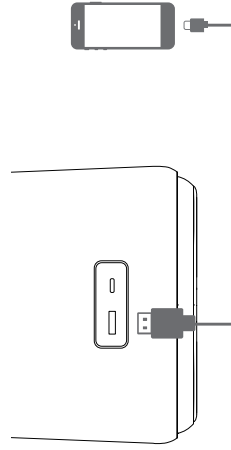

3. Indicatore di Ricarica

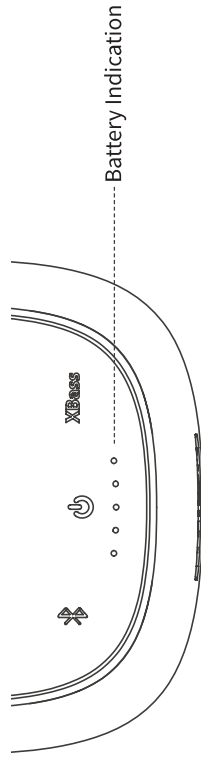

	L'indicatore rosso lampeggia	Batteria bassa
	L'indicatore bianco lampeggia	Ricarica
	Tutti gli indicatori sono spenti	Ricarica completa



4. Battery Indication

10-30%	30-50%	50-70%	70-80%	80-100%	Ricarica completa

Pulsanti di Controllo

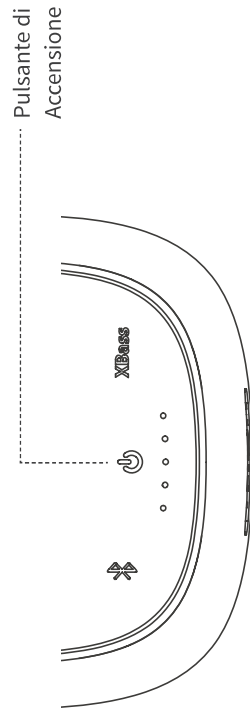

1. Accensione/Spengimento

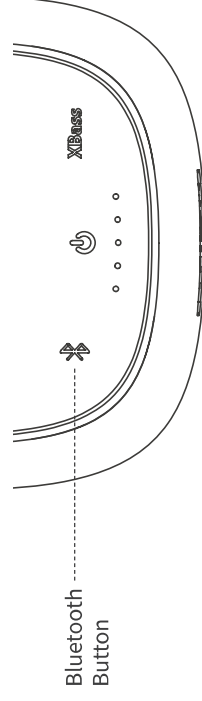

	Pressione breve		L'indicatore bianco è acceso
	Pressione breve		Tutti gli indicatori sono spenti

2. Connessione Bluetooth



	Premere e tenere premuto per 1 secondi		Entra nella modalità associazione		L'indicatore blu lampeggia	Stato di associazione
--	--	---	-----------------------------------	---	----------------------------	-----------------------

- L'altoparlante StormBox Pro si connetterà automaticamente agli ultimi 1 dispositivi associati ancora se sono disponibili. Se fallisce, l'altoparlante entrerà nella modalità di associazione.
- Puoi collegare questo altoparlante con più dispositivi e controllare la connessione tramite il pulsante Bluetooth.
- L'altoparlante può memorizzare fino a 8 dispositivi Bluetooth associati.
- Meglio ancora, può connettersi a 2 dispositivi contemporaneamente alla volta.

3. Conversione tra 2 dispositivi collegati

- 1) Mette in pausa la riproduzione del dispositivo corrente.
- 2) Riproduci il file audio dell'altro dispositivo.

4. Regolazione del Volume

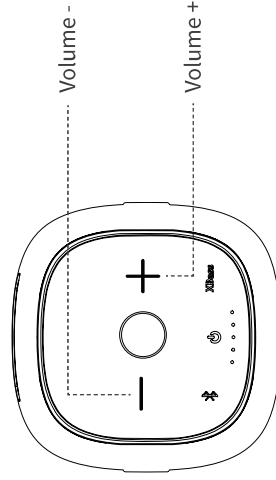

-	Premere brevemente	Diminuire il volume
	Mantenere premuto per alcuni secondi	Diminuire il volume continuamente
+	Premere brevemente	Aumentare il volume
	Mantenere premuto per alcuni secondi	Aumentare continuamente il volume

5. Pulsante Multifunzione (MFB)

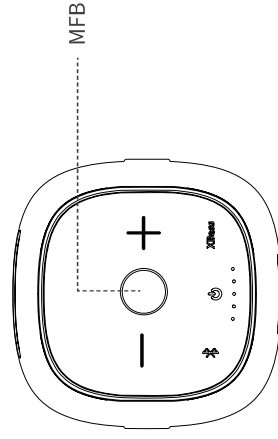

Modalità Musica	Pressione breve	Avvio/pausa
	Doppia pressione	Prossima Traccia
	Premere per 3 volte	Traccia Precedente
Modalità Conversazione	Premere e tenere premuto per 1 secondo	Attivare Siri
	Premere brevemente	Rispondere/Chiudere la chiamata
	Premere e tenere premuto per 1 secondo	Rifiutare le chiamate telefoniche
	Premere e tenere premuto per 1 secondo (durante una chiamata)	Metti in pausa la chiamata corrente e rispondi alla chiamata in arrivo
	Premere brevemente (durante una chiamata fra tre persone)	Premere insieme due chiamate telefoniche
	Premere e tenere premuto per 1 secondo (durante una chiamata fra tre persone)	Riagganciare la chiamata in corso

6. Funzione XBass

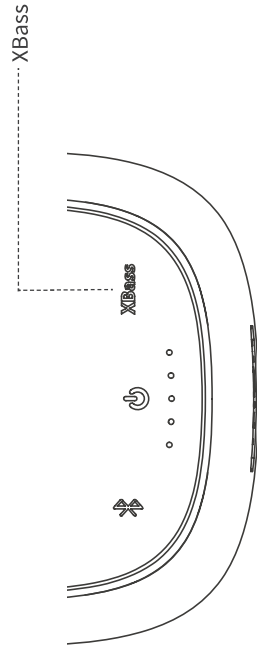

Premere brevemente il pulsante XBass per attivare la funzione XBass, l'indicatore XBass si illuminerà di bianco.

Premere di nuovo brevemente questo pulsante per disattivare la funzione XBass, l'indicatore XBass si spegnerà.

7. Modalità Stereo

1) Assicurati che entrambi gli altoparlanti siano accesi.

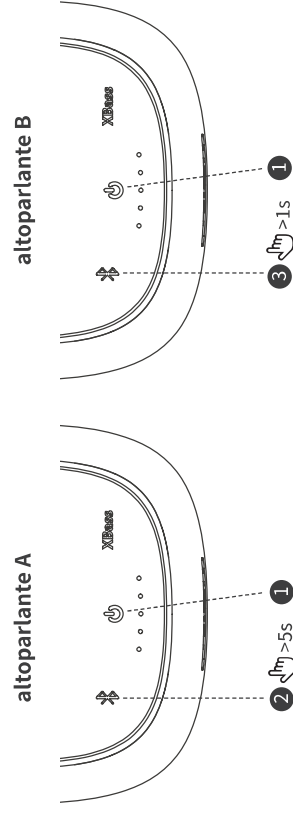

2) Premere il pulsante Bluetooth dell'altoparlante A per 5 secondi: per entrare nella modalità di accoppiamento Stereo (Nota: questo altoparlante sarà considerato come l'altoparlante principale);

3) Premere brevemente il pulsante Bluetooth dell'altoparlante B per entrare nella modalità di accoppiamento (Nota: questo altoparlante sarà considerato come un altoparlante secondario);

4) Quando si sente il segnale acustico "stereo mode", il collegamento è riuscito e l'altoparlante A e l'altoparlante B entrano in modalità stereo. A questo punto, l'altoparlante principale emetterà "left channel" e l'altoparlante secondario emetterà "right channel".

Annotazioni: la funzione della modalità stereo può essere realizzata solo quando si dispone di 2 altoparlanti Tribit Stormbox Pro.

8. Modalità Festa

1) Assicurati che I due altoparlanti siano entrambi nella modalità party.

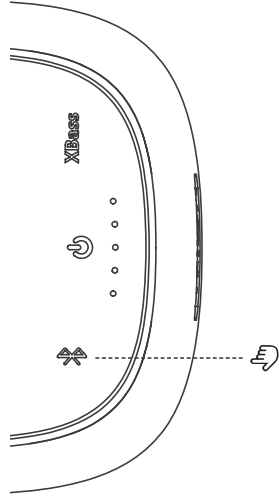

- 2) Premere brevemente il pulsante Bluetooth su uno dei due altoparlanti.
- 3) In questo momento, sentirai un suono "Modalità party" e gli altoparlanti entreranno in modalità party.

Annotazioni: la funzione della modalità festa può essere realizzata solo quando si dispone di 2 altoparlanti Tribit StormBox Pro.

9. Conversione di entrambe le Modalità Party e Stereo

Premere brevemente il pulsante Bluetooth di qualunque dei due altoparlanti.

10. Disabilitare la Modalità Party e oppure la Modalità Stereo.

Premere e tenere premuto il pulsante per 5 secondi su una qualsiasi delle due casse, quindi entrambi riattiveranno la modalità di associazione Bluetooth.

11. Ripristino alle Impostazioni di Fabbrica

Mantenere premuti contemporaneamente i pulsanti Volume + e - per 5 secondi per cancellare l'elenco di accoppiamenti e tutte le impostazioni e l'altoparlante ripristinerà lo stato di fabbrica.

Specifications

Versione Bluetooth	5.3
Potenza in Uscita	40W
Frequenza limite di banda	60Hz-20KHz
Potenza massima di trasmissione	2.402GHz-2.480GHz
Tipo Batteria	≤ 6dBm (3.6V 5000mAh*2)/ 36Wh
Tempo di Ricarica	6 hours ore @5V/2A
Dimensioni	96 x 96 x 180 mm
Grado di Impermeabilità	IP67

パッケージ内容

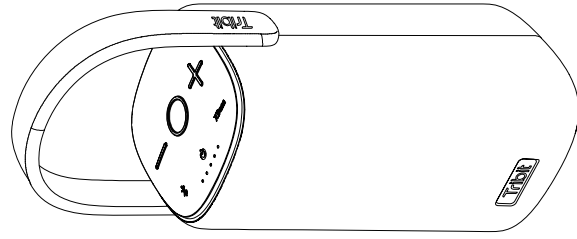

StormBox Pro



User Manual

取扱説明書



USB-C ケーブル

スピーカー各部の説明

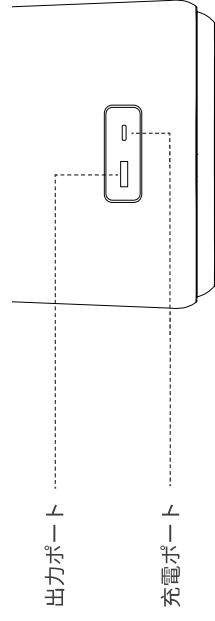
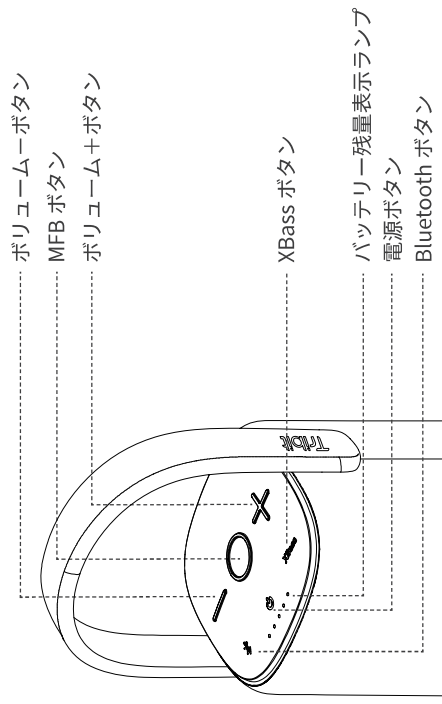

充電方法

1. スピーカーに充電する

付属した USB-C ケーブルでスピーカーの充電ポートを 5 v の電源コンセントに接続します。

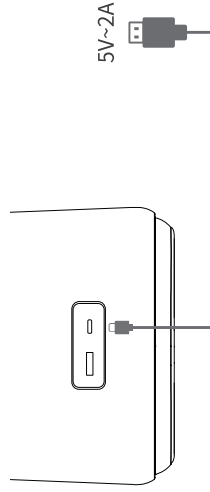

2. 他のデバイスを充電する

USB-A 充電ケーブル（別売り）を使用し、スピーカーの出力ポートを USB 充電可能なデバイスに接続します。

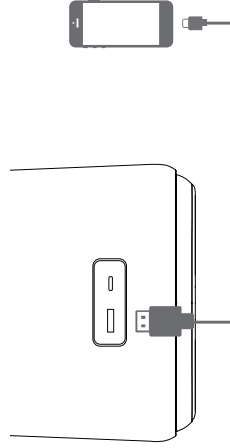

65

3. バッテリー残量ランプ

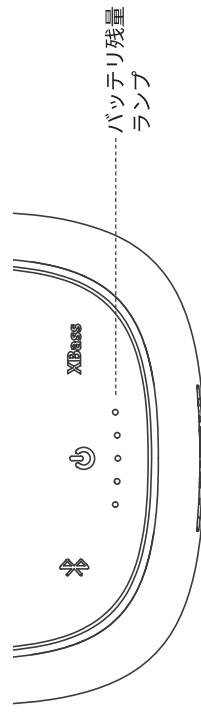

	赤いランプが点滅	電池残量不足
	白いランプが点滅	充電中
	消灯	充電完了

4. バッテリー残量の表示

	10-30%		30-50%		50-70%		70-80%		80-100%		満充電
--	--------	--	--------	--	--------	--	--------	--	---------	--	-----

66

ボタン操作

1. オン・オフ

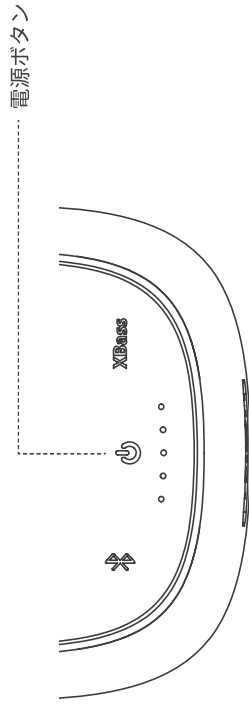

電源オン	短押し	白いランプが点灯
	短押し	消灯

2. ペアリング

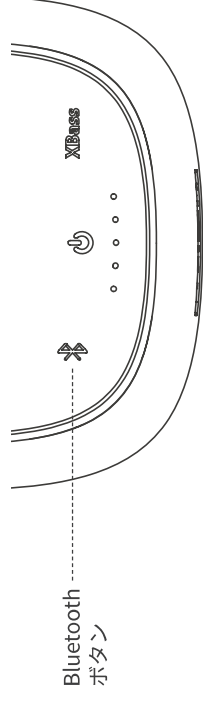

Bluetooth ボタン	1Sで長く押し	ペアリングモードに入ります	青色のランプが点滅している	ペアリングしている状態です
---------------	---------	---------------	---------------	---------------

- StormBox Pro の電源に入れると、前ペアリングした最後の1つデバイスを自動的に接続します。ペアリング済みの端末がない場合、自動的にペアリングモードに入ります。
- Bluetooth ボタンで複数台のデバイスのペアリングとデバイス間の切り替えが可能です。
- ペアリングしたデバイスを8つまで登録可能
- 2つのデバイスを同時に接続可能。

3. ペアリングされた2つのデバイス間の切り替え

- 1) 1つのデバイスを一時停止します。
- 2) もう1つのデバイスを再生します。

4. 音量調整

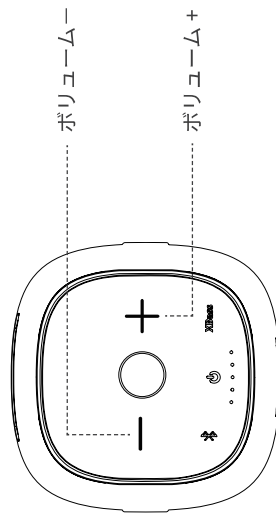

-	短押し	音量を下げます
	長押し	音量を最小まで下げます
+	短押し	音量を上げます
	長押し	音量を最大まで上げます

5. MFB ボタン

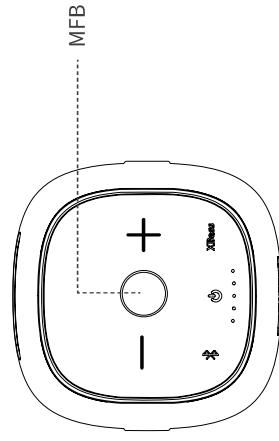

音楽モード	短押し	再生 / 一時停止
	2回押し	次の曲
	3回押し	前の曲
通話モード	1s押し	Siri を呼び出します
	短押し	電話を outます / 電話を切ります
	1s押し	着信拒否
	1s押し (通話中)	通話中で他の電話が来た場合、通話を保留すると同時に、他の電話を outます
	短押し (三者通話中)	電話を切り替えます
	1s押し (三者通話中)	現在の通話を切る

6. XBass

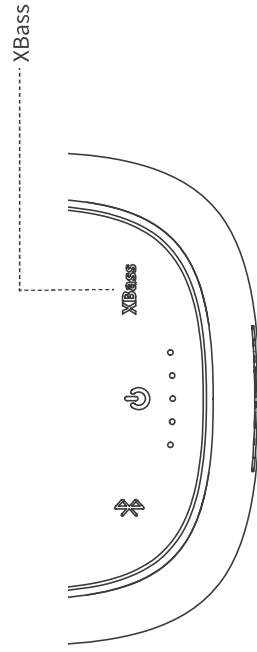

XBass ボタンを短く押し、XBass 機能がオンになります。XBass の標識が光ります。もう一度短く押し、XBass 機能がオフになり、XBass の標識の光が消えます。

7. ステレオモード

1) 2台のスピーカーがオンになっていることを確認してください。

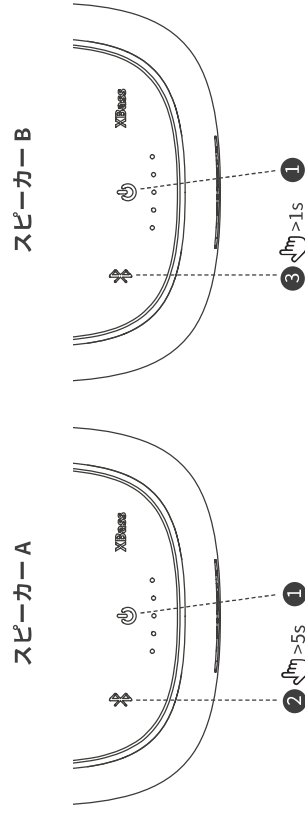

- 2) スピーカー A の Bluetooth ボタンを 5 秒で長押し、ステレオのペアリングモードに入ります。
- 3) スピーカー B の Bluetooth ボタンを 1 秒で押し、ペアリングモードに入ります。
- 4) 「Stereo Mode」を音が聞こえたら、ボタンから手を離します。左スピーカーで「left channel」、右スピーカーで「right channel」という音が聞こえたら、ステレオモードに入ります。

※ この機能は 2 台の Tribit Stormbox Pro スピーカーが必要です。

8. パーティーモード

1) 2台のスピーカーはパーティーモードになっていることを確認してください。

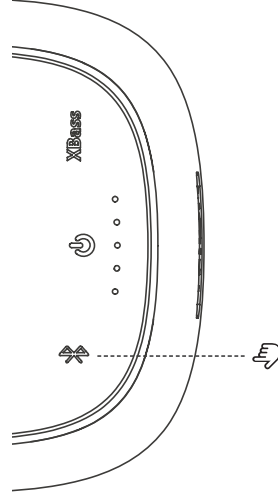

2) 任意の1台のBluetoothボタンを短く押してください。

3) 「Party mode」を聞こえたら、パーティーモードに入ります。

※ この機能は2台の Tribit Stormbox Pro スピーカーが必要です。

9. パーティーモードとステレオモードの切り替え

任意の1台のBluetooth  ボタンを短く押します。

10. パーティーモードとステレオモードをオフにする

任意の1台のBluetooth  ボタンを5sで長押しし、再びペアリングモードに入り、パーティーモードとステレオモードをオフにします。

11. リセット機能

スピーカーが動作しない等の不具合が発生した場合、下記の方法でリセットしてください。「ポリューム+」と「ポリューム-」ボタンを同時に5秒ほど長押しし、初期化にします。

製品仕様

Bluetoothバージョン	5.3
出力パワー	40W
周波数	60Hz-20KHz
周波数帯の範囲	2.402GHz~2.480GHz
最大送信電力	≤ 6dBm
バッテリーのタイプ	(3.6V 5000mAh*2)/ 36Wh
充電時間	6.0H @ 5V2A
寸法	96 x 96 x 180 mm
防水・防塵規格	IP67

包装清单

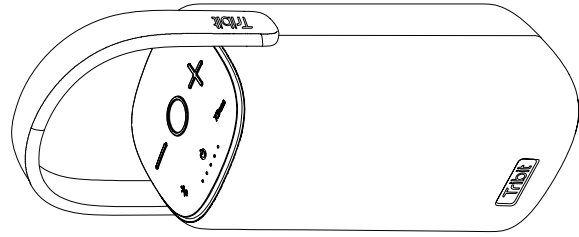

StormBox Pro



用户手册



USB-C 充电线

产品概述

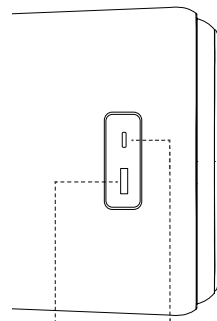
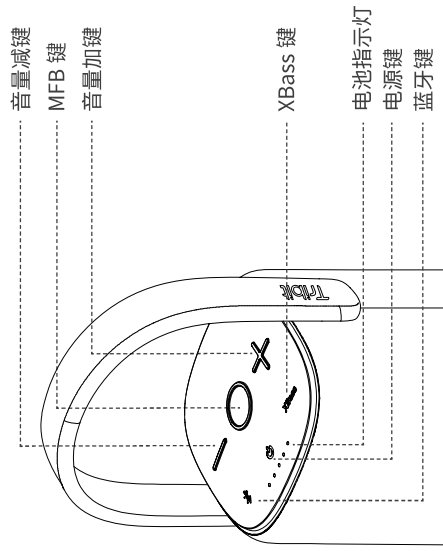

对外部设备充电

对音箱充电

充电方法

1. 对音箱充电

用 USB-C 充电线连接音箱与 5V 充电适配器。

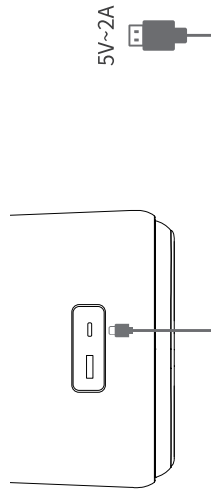

2. 音箱对外部设备充电

用音箱 USB-A 口连接对外部设备进行充电。

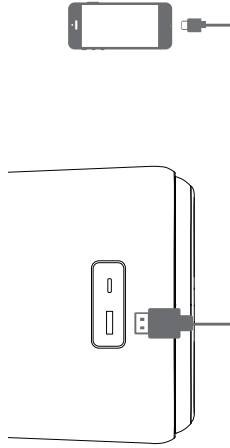

3. 充电指示灯

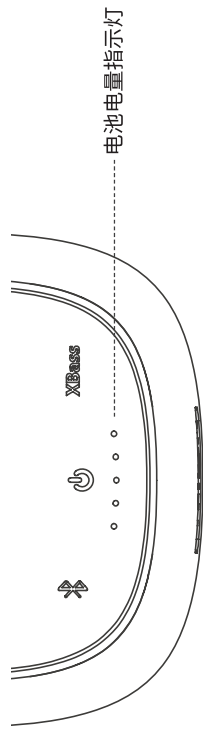

	红灯闪	电量低
	白灯闪	充电中
	所有灯灭	充满电

4. 电量表示

	10-30%		30-50%		50-70%		70-80%		80-100%		充满电
--	--------	--	--------	--	--------	--	--------	--	---------	--	-----

按键控制

1. 开关机

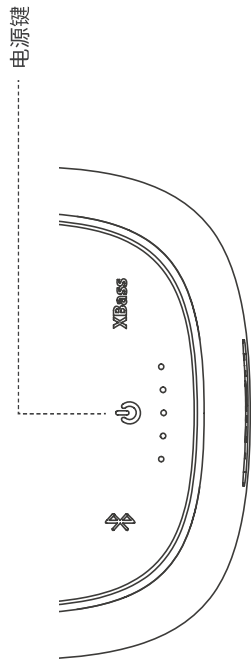

	短按	开机	白灯常亮
	短按	关机	所有灯灭

2. 蓝牙连接

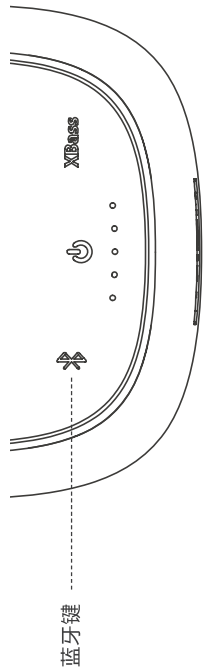

	长按 1s	进入蓝牙配对		蓝灯快闪	配对状态
--	-------	--------	---	------	------

- 开机后 StormBox Pro 会自动回连最后配对的一台设备。如果回连失败，音箱进入配对模式。
- 音箱可以存储记忆 8 台蓝牙连接的设备信息。
- 音箱可以同时连接两台设备，在两台设备间切换使用。

3. 在两台连接的设备间切换

- 1) 暂停当前播放中的设备;
- 2) 在另一台设备上播放。

4. 音量调节

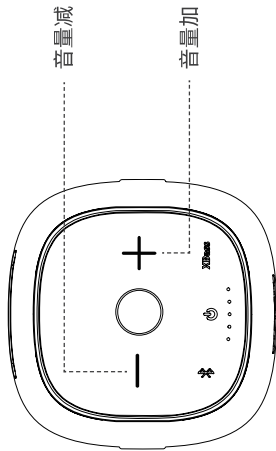

-	短按	音量减小
	长按	音量持续减小
+	短按	音量增大
	长按	音量持续增大

5. 多功能按键 (MFB)

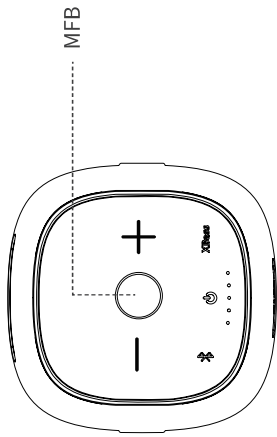

音乐模式	短按	播放 / 暂停
	双击	下一曲
	三击	上一曲
通话模式	长按 1s	唤醒 Siri
	短按	接听 / 挂断电话
	长按 1s	拒接来电
	长按 1s (双方通话时)	暂停当前通话并接听新进来电
	短按 (三方通话时)	在两个通话间切换
	长按 1s (三方通话时)	挂断当前电话

6. XBass 功能

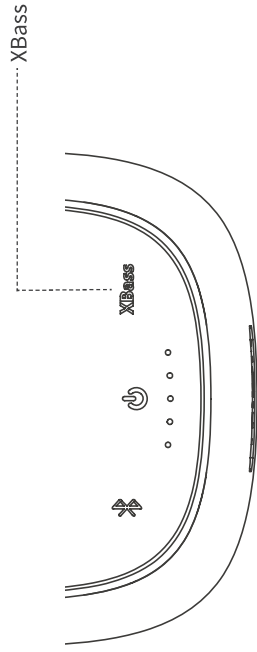

短按 XBass 键激活 XBass 功能，XBass 指示灯亮白灯。
再短按 XBass 键关闭 XBass 功能，XBass 指示灯灭。

7. 立体声模式

1) 将两台 Stormbox Pro 音箱都开机；

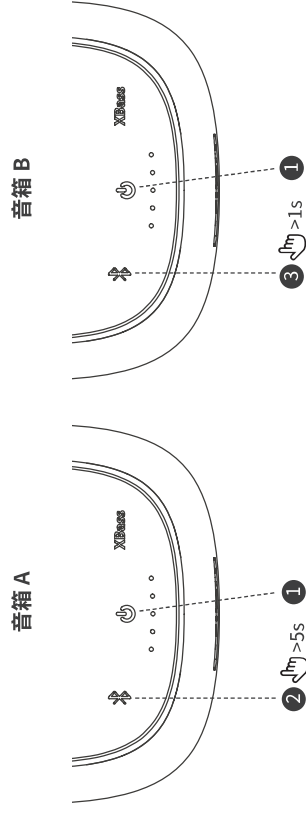

- 2) 长按音箱 A 蓝牙键 5s 进入 stereo mode 组队模式（此音箱将被视为主音箱）；
- 3) 长按音箱 B 蓝牙键 1s 进入配对模式（此音箱将被视为副音箱）；
- 4) 听到提示音“Stereo mode”即组队成功，进入 Stereo 模式。此时主音箱将播报“left channel”，副音箱播报“Right channel”。

注意：只有两台 Stormbox Pro 才可组队成立体声模式。

8. Party 模式

- 1) 两台音箱已处于立体声模式。

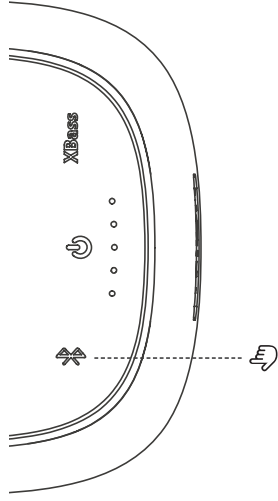

- 2) 短按任一音箱蓝牙键。
- 3) 听到“party mode”后，派对模式激活。

注意：只有两台 Stormbox Pro 才可组队实现派对模式。

9. Party 模式与立体声模式间切换

短按蓝牙键  即可实现在 Party 模式与立体声模式之间的切换。

10. 退出 Party 模式或立体声模式

长按任一音箱蓝牙键  5s，解除已组队的两台 Stormbox Pro 音箱。

11. 复位

同时长按音量加减键 5s，对音箱复位，复位后历史配对信息会被清除，需要重新与设备配对后使用。

规格

蓝牙版本	5.3
输出功率	40W
频响范围	60Hz-20KHz
频段范围	2.402GHz~2.480GHz
最大传输功率	≤ 6dBm
电池	(3.6V 5000mAh*2) / 36Wh
充电时间	6 小时 @5V/2A
尺寸	96 x 96 x 180 mm
防水等级	IP67

注意事项

- 请在常温环境中存放以及使用本产品；
- 请勿将本产品暴露在雨中或潮湿环境中；
- 请勿丢弃，避免因跌落造成产品损坏；
- 请勿自行拆解、修理和改造本产品；
- 产品内置锂电池，请勿随意丢弃或置于火中，以免引起危险！
- 电池（电池包或组合电池）不得暴露在诸如日照、火烤或类似过热环境中；
- 消费者使用电源适配器充电，需购买配套使用获得 CCC 认证并满足标准要求电源适配器。