

A

Tribit[®]
Unleash the true sound

Portable Wireless Speaker
TRIBIT AQUAEASE
BTS11

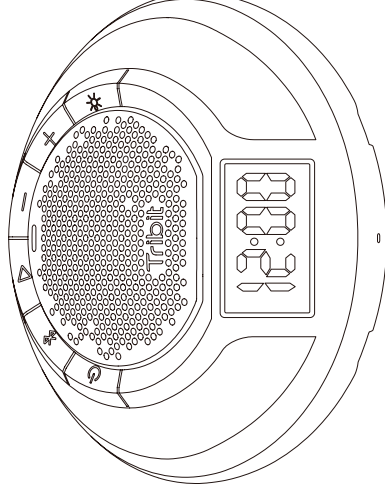

Hereby, Thousandshores Deutschland GmbH declares that the radio equipment type Portable Wireless Speaker BTS11 is in compliance with Directive 2014/53/EU. The full text of the EU declaration conformity is available at the following internet address: <http://files.tribit.com/bts11-de-doc.pdf>

Hiermit erklärt Thousandshores Deutschland GmbH, dass der Funkanlagentyp Portable Wireless Speaker BTS11 der Richtlinie 2014/53/EU entspricht. Der vollständige Text der EU-Konformitätserklärung ist unter der folgenden Internetadresse verfügbar: <http://files.tribit.com/bts11-de-doc.pdf>

Learn more about the UK Declaration of Conformity, Please click below link to download. <http://files.tribit.com/bts11-uk-doc.pdf>

English User Manual | Benutzerhandbuch | Manuel d'utilisation
Manuale d'uso | Manual de usuario | 取扱説明書 | 说明书

English User Manual	01
Benutzerhandbuch	16
Guide Utilisateur	29
Manual de Usuario	42
Manuale Utente	55
取扱説明書	68
用戶手冊	81

Package Contents

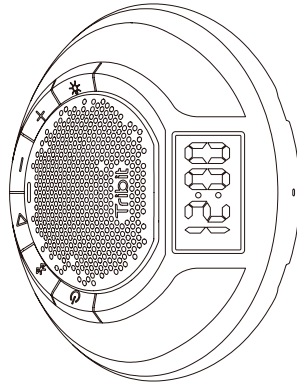

Tribit AquaEase



USB-C Cable



User Manual

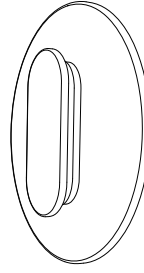

Wall Mount

Product Illustration

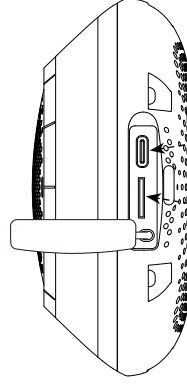
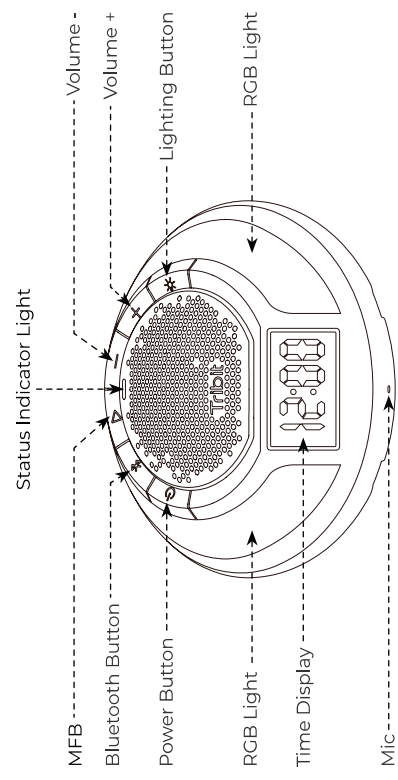

SD Card Slot

USB-C Charging Port

How to Charge the Speaker

Connect the other end of charging cable to a charging adapter and connect the charging cable to the USB-C charging port on the Bluetooth speaker.

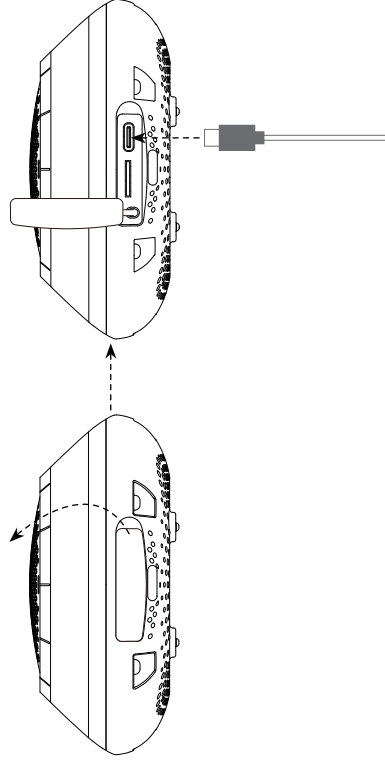

Note: During charging, the indicator light is always on in red. When the speaker is fully charged, the red indicator light goes off.

Button Control

1. On/Off

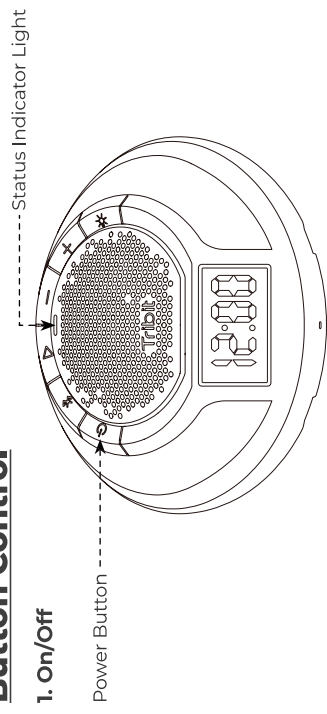

	Press	Turn on	<ul style="list-style-type: none"> The status indicator light is always on in blue. When the battery is low, the status indicator will flash in red. During charging, the indicator is always on in red. When the speaker is fully charged, the red indicator light goes off.
	Press	Turn off	All lights are off and the display goes off.
	Press and hold for 8s	Forced shutdown	All lights are off and the display goes off.

Note: If the Tribit AquaEase Speaker is unable to be powered off due to unknown reasons, you can forcibly turn it off by pressing and holding the power button for 8 seconds and then the speaker will re-start automatically.

2. Bluetooth Connection

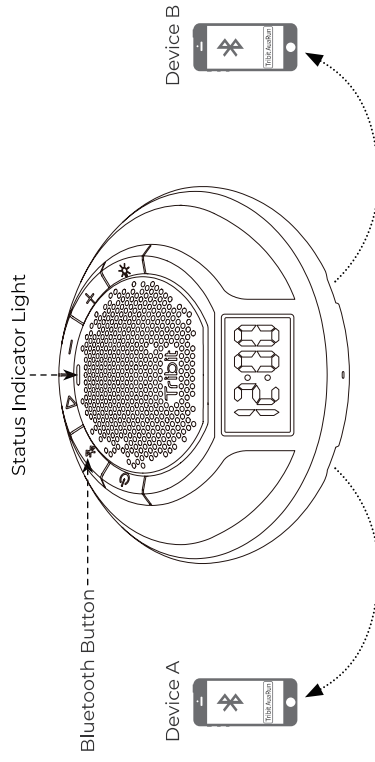

	Press and hold the Bluetooth button for 1s	The speaker will automatically enter into Bluetooth pairing mode.	The blue indicator light will flash rapidly.
--	--	---	--

Tribit AquaEase:

- Automatically re-connects to the last paired device.
- Connects 2 bluetooth devices at the same time.
- Memories 8 bluetooth devices.

Note: When 2 devices are connected to the Tribit AquaEase speaker, device A and device B cannot play simultaneously---only one speaker at a time.

3. Multifunctional Button (MFB)

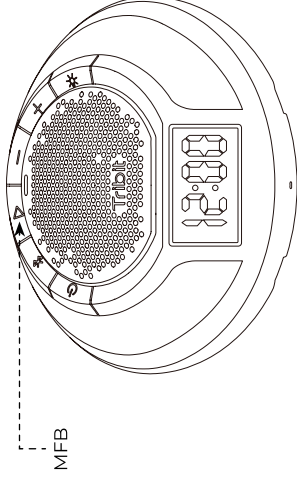

	Press once	Play / Pause
	Press twice	Next track
	Press three times	Previous track
	Press and hold for 1 second	Activate voice assistant
	Press	Answer / end a call
	Press and hold for 1 second	Reject a call
	Press and hold for 1 second (during a call)	Pause the current call and answer an incoming call
	Press (during a three-way calling)	Switch between the 2 calls.
	Press and hold for 1 second (during a three-way calling)	End the call with the caller not in the line.

4. Volume

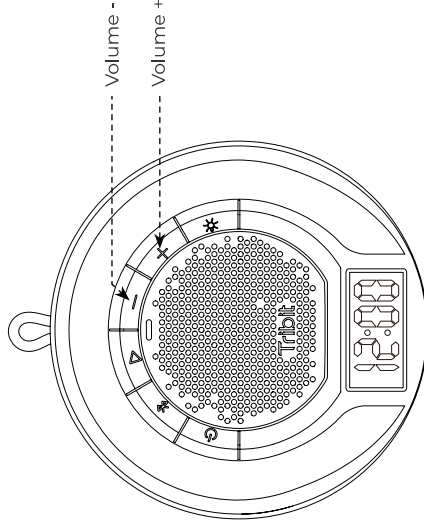

+	Press	Increase the volume
	Press and hold	Continuously increase the volume
-	Press	Decrease the volume
	Press and hold	Continuously decrease the volume

5. Ambient Light

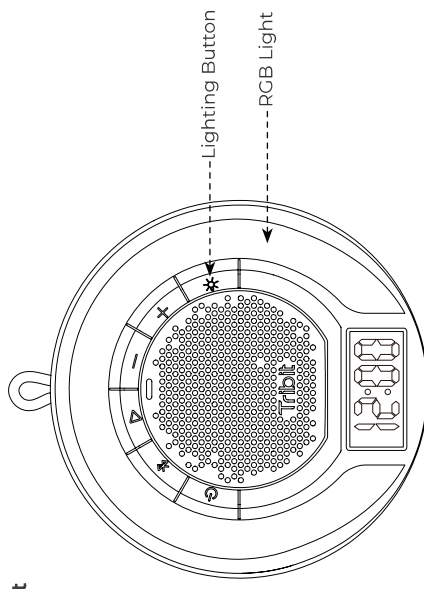

☀️	Press	Switch / Turn off the light effect.
----	-------	-------------------------------------

6. Stereo Mode

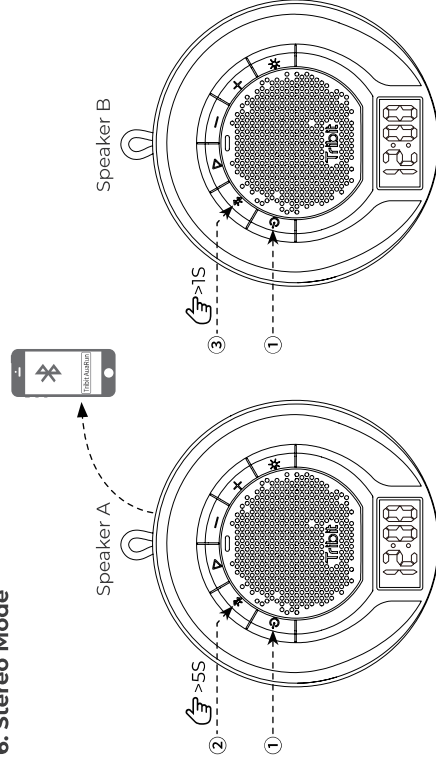

- ① Make sure speaker A and speaker B are both are turned on.
- ② Press and hold the Bluetooth button on speaker A for 5 seconds to enter the stereo pairing mode. (Speaker A is the primary speaker.)
- ③ Press and hold the Bluetooth button on speaker B for 1 seconds to enter the stereo pairing mode. (Speaker B is the secondary speaker.)
- ④ When you hear the prompt, "Stereo Mode", the stereo pairing is successful. When entering the Stereo Mode, the primary speaker reads, "left Channel" and the secondary speaker reads, "Right Channel".

Note: Stereo mode is only available when there are 2 Tribit AquaEase speakers.

7. Reset

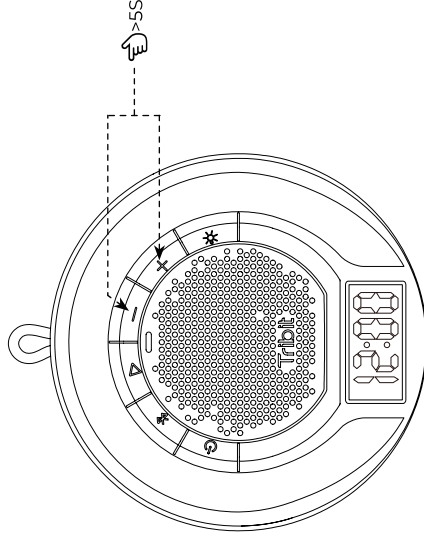

If malfunction occurs, you can try to reset the speaker (press and hold the volume + button and volume - button at the same time for 5 seconds) to remedy issues. Once reset, all the old data has been wiped, and you need to pair the speaker to your Bluetooth device anew.

How to Install the Wall Mount

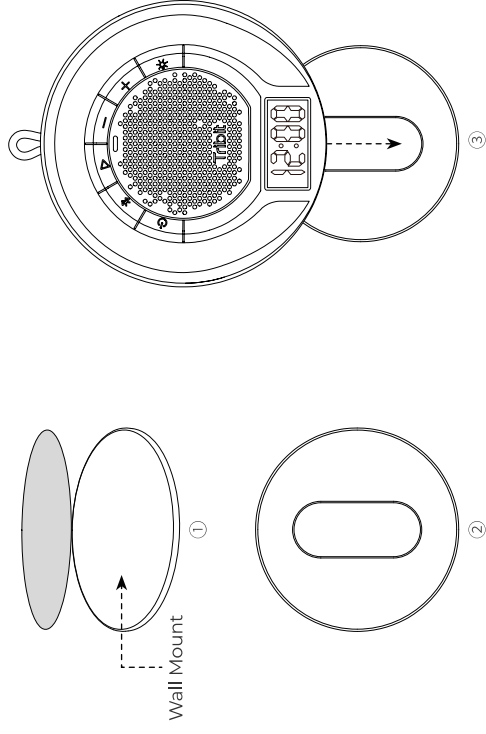

- ① Remove the release paper on the wall mount.
- ② Select a flat and smooth wall (ceramic tile or glass wall is recommended), stick the wall mount on the wall and gently press it. Make sure the hanger on the wall mount is in vertical direction.
- ③ Gently buckle the speaker on the wall mount with the time display facing downwards.

Note: Once the wall mount is stuck on the wall, it's hard and inconvenient to take it off. Please carefully choose the place where you desire to install the wall mount.

Specifications

Bluetooth Version	V5.3
Bluetooth Protocol	A2DP, AVRCP, HFP, HSP
Output Power	7W
Frequency Response	100~16KHz
Frequency Band	2402-2480MHz
Maximum Transmission Power	≤6dBm
Battery	(3.7v 2200mAh)/8.14Wh
Charging Time	3 hours @ 5V/1A
Waterproof Rating	IPX7
Size	109.6 * 109.6 * 48.2mm
Weight	260g

Customer Service

- An 18-month Warranty
- For more services and information, please Email to support@tribit.com.

Safety Precautions

- Do not place the speaker in a place where it is easy to fall.
- Do not disassemble, repair or modify this product by yourself.
- Keep the speaker away from extreme temperatures.
- Do not use the speaker in an outdoor thunderstorm environment.
- Do not use any corrosive cleaners or other chemical solutions to clean the speaker.

FCC Statement

Changes or modifications not expressly approved by the party responsible for compliance could void the user's authority to operate the equipment.

This equipment has been tested and found to comply with the limits for a Class B digital device, pursuant to Part 15 of the FCC Rules. These limits are designed to provide reasonable protection against harmful interference in a residential installation. This equipment generates uses and can radiate radio frequency energy and, if not installed and used in accordance with the instructions, may cause harmful interference to radio communications. However, there is no guarantee that interference will not occur in a particular installation. If this equipment does cause harmful interference to radio or television reception, which can be determined by turning the equipment off and on, the user is encouraged to try to correct the interference by one or more of the following measures:

- Reorient or relocate the receiving antenna.
- Increase the separation between the equipment and receiver.
- Connect the equipment into an outlet on a circuit different from that to which the receiver is connected.
- Consult the dealer or an experienced radio/TV technician for help.

This device complies with part 15 of the FCC rules. Operation is subject to the following two conditions (1) this device may not cause harmful interference, and (2) this device must accept any interference received, including interference that may cause undesired operation.

IC Caution

This device complies with Industry Canada licence-exempt RSS standard(s).

Operation is subject to the following two conditions: (1) This device may not cause interference, and (2) This device must accept any interference, including interference that may cause undesired operation of the device.

Le présent appareil est conforme aux CNR d'Industrie Canada applicables aux appareils radio exempts de licence.

L'exploitation est autorisée aux deux conditions suivantes: (1) l'appareil ne doit pas produire de brouillage, et (2) l'utilisateur de l'appareil doit accepter tout brouillage radioélectrique subi, même si le brouillage est susceptible d'en compromettre le fonctionnement.

Lieferumfang

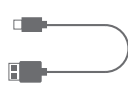

USB-C-Kabel

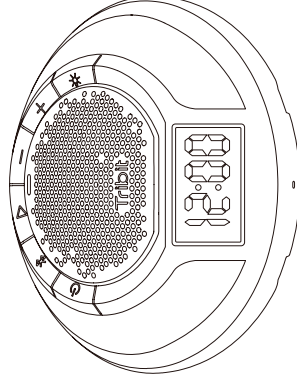

Tribit Aquaease



Benutzerhandbuch

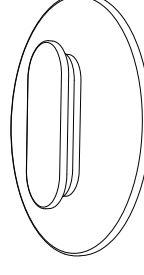

Wandhalterung

Produkt-Illustration

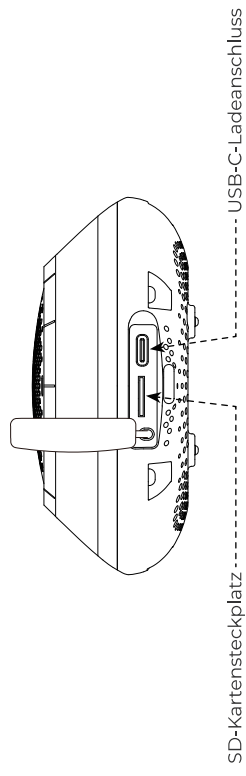
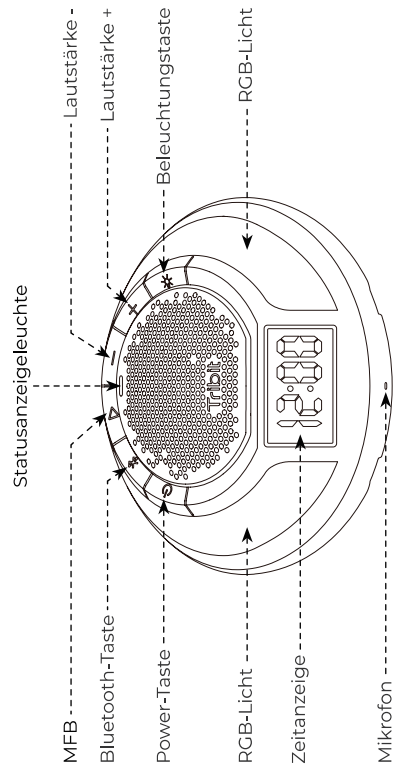

Aufladen des Lautsprechers

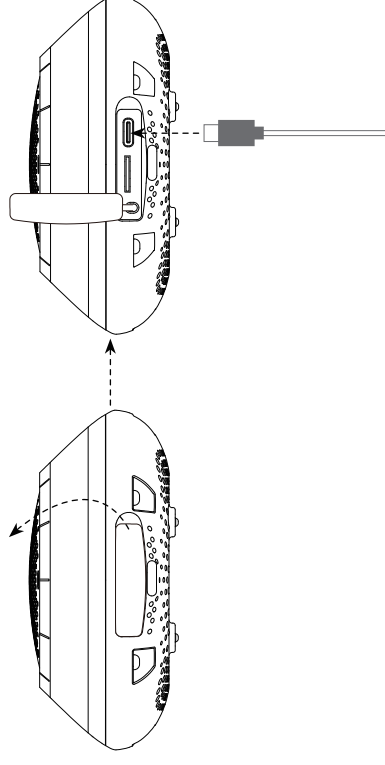

1. Verbinden Sie das Ladekabel mit dem USB-C-Ladeanschluss des Bluetooth-Lautsprechers und schließen Sie das andere Ende des Ladekabels an einen Ladeadapter an.
2. Während des Ladevorgangs leuchtet die Anzeigeleuchte immer rot.
3. Wenn der Lautsprecher vollständig aufgeladen ist, leuchtet die rote Anzeige nicht mehr.

Bedienungshinweise für Tasten

1. Ein- und ausschalten

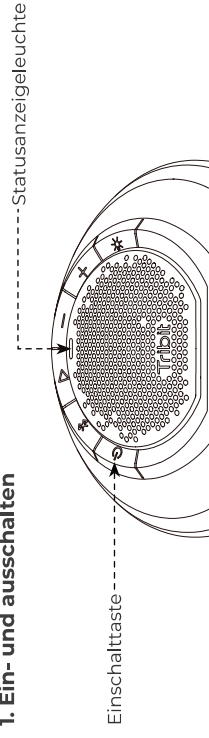

	Drücken	<ol style="list-style-type: none"> 1. Die Statusanzeige leuchtet immer blau. 2. Wenn der Akku schwach ist, blinkt die Statusanzeige rot. 3. Während des Ladevorgangs leuchtet die Anzeige immer rot. 4. Wenn der Lautsprecher vollständig aufgeladen ist, leuchtet die rote Anzeige nicht mehr.
	Drücken	Alle Lichter sind aus und das Display erlischt.
	Sekundenlang drücken und halten	Alle Lichter sind aus und das Display erlischt.

Hinweis: Wenn sich der Tribit AquaEase-Lautsprecher aus unbekanntem Gründen nicht ausschalten lässt, können Sie ihn zwangsweise ausschalten, indem Sie die Einschalttaste 8 Sekunden lang gedrückt halten, danach wird der Lautsprecher automatisch erneut gestartet.

2. Bluetooth Verbindung

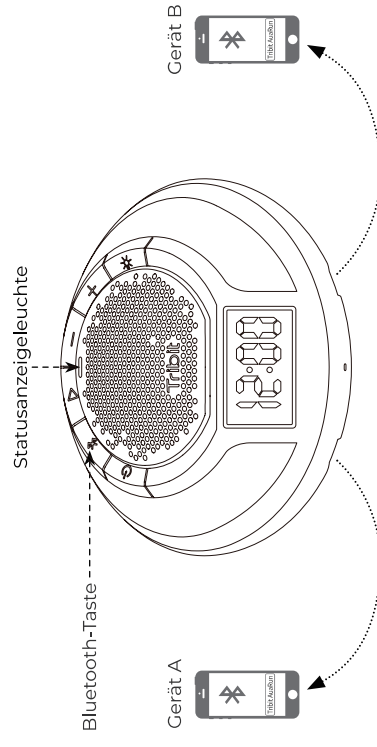

	Drücken und halten Sie die Bluetooth-Taste 1 Sekunde lang	Der Lautsprecher wechselt automatisch in den Bluetooth-Kopplungsmodus.	Die blaue Anzeigeleuchte blinkt schnell.
--	---	--	--

Tribit AquaEase:

- verbindet sich automatisch wieder mit dem zuletzt gekoppelten Gerät.
- Verbindet 2 Bluetooth-Geräte zur gleichen Zeit.
- speichert 8 Bluetooth-Geräte.

Hinweis: Wenn 2 Geräte mit dem Tribit AquaEase-Lautsprecher verbunden sind, können Gerät A und Gerät B nicht gleichzeitig spielen - unterbrechen Sie Lautsprecher A, damit Lautsprecher B spielen kann oder umgekehrt.

3. die Multifunktionsstaste (MFB)

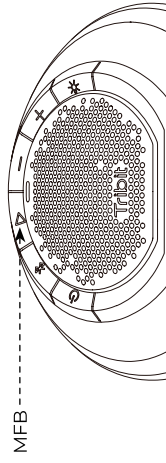

	Einmal drücken	Wiedergabe/Pause
	Zweimal drücken	Nächster Titel
	Dreimal drücken	Vorheriger Titel
Musik-Modus	1 Sekunde lang gedrückt halten	Aktivieren des Sprachassistenten
	Drücken	Anruf annehmen/beenden
	1 Sekunde lang gedrückt halten	Ablehnen eines Anrufs
	1 Sekunde lang gedrückt halten (während eines Gesprächs)	Pausieren des aktuellen Anrufs und Annehmen eines eingehenden Anrufs
	Drücken (während eines Dreiergesprächs)	Wechseln zwischen den 2 Anrufen.
	1 Sekunde lang gedrückt halten (während eines Dreiergesprächs)	Beenden Sie den Anruf mit dem Anrufer, der nicht anwesend ist.

4. Lautstärke

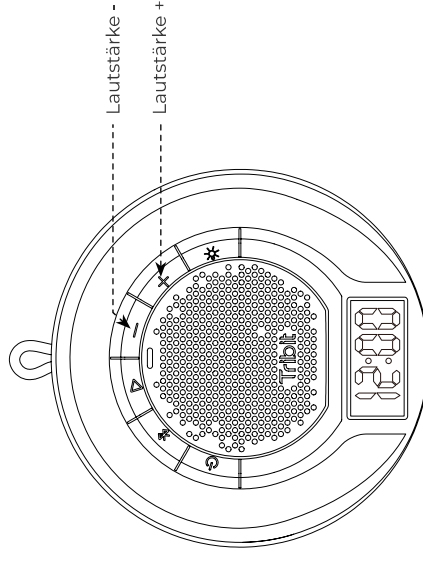

+	Drücken	Die Lautstärke erhöhen
	Drücken und halten	Die Lautstärke weiter erhöhen
-	Drücken	Die Lautstärke verringern
	Drücken und halten	Die Lautstärke weiter verringern

5. Mehrfarbiges Umgebungslicht

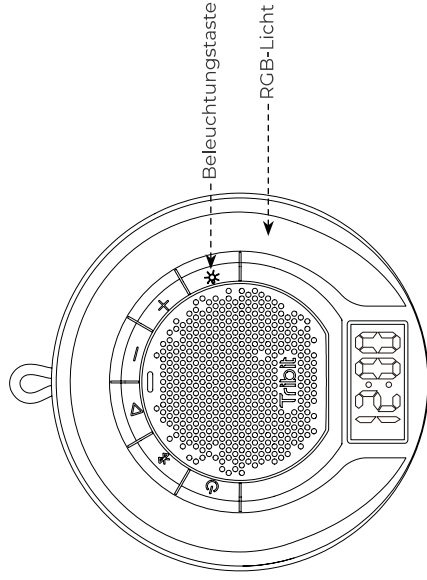

	Drücken	Einschalten/Ausschalten des Lichteffekts.
--	---------	---

6. Stereo-Modus

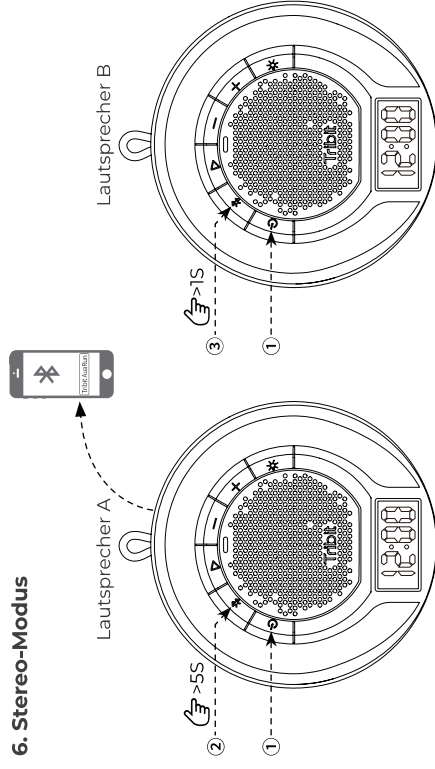

- ① Stellen Sie sicher, dass sowohl Lautsprecher A als auch Lautsprecher B eingeschaltet sind.
- ② Halten Sie die Bluetooth-Taste am Lautsprecher A 5 Sekunden lang gedrückt, um den Stereo-Pairing-Modus zu aktivieren. (Lautsprecher A ist der Primärlautsprecher.)
- ③ Halten Sie die Bluetooth-Taste am Lautsprecher B 1 Sekunden lang gedrückt, um den Stereo-Pairing-Modus zu aktivieren. (Lautsprecher B ist der Sekundärlautsprecher.)
- ④ Wenn Sie die Aufforderung "Stereo-Mode" hören, ist das Stereo-Pairing erfolgreich. Beim Aufrufen des Stereo-Modus zeigt der Primärlautsprecher "left Channel" und der Sekundärlautsprecher "Right Channel" an.

Hinweis: Der Stereo-Modus ist nur verfügbar, wenn 2 Tribit AquaEase-Lautsprecher angeschlossen sind.

7. Zurücksetzen

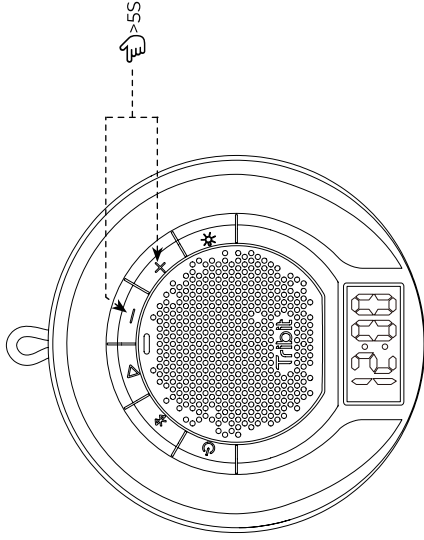

Wenn eine Störung auftritt, können Sie versuchen, den Lautsprecher zurückzusetzen (halten Sie die Tasten Lautstärke + und Lautstärke - gleichzeitig 5 Sekunden lang gedrückt), um die Probleme zu beheben. Nach dem Zurücksetzen werden alle alten Daten gelöscht, und Sie müssen den Lautsprecher erneut mit Ihrem Bluetooth-Gerät koppeln.

Installation der Wandhalterung

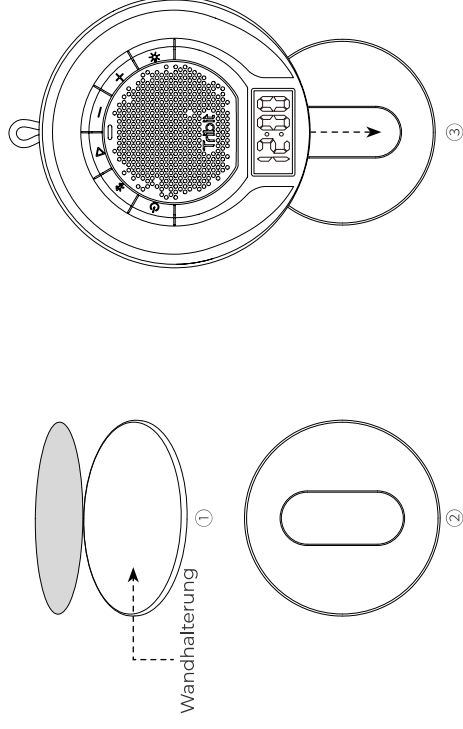

- ① Entfernen Sie das Schutzpapier von der Wandhalterung.
- ② Legen Sie die Wandhalterung an eine flache und glatte Wand an (Keramikfliesen oder Glaswände werden empfohlen) und drücken Sie sie vorsichtig an die Wand. Achten Sie darauf, dass die Aufhängung der Wandhalterung vertikal ausgerichtet ist.
- ③ Befestigen Sie den Lautsprecher vorsichtig an der Wandhalterung, so dass die Zeitanzeige nach unten weist.

Hinweis: Wenn die Wandhalterung erst einmal an der Wand befestigt ist, lässt sie sich schwer und mühsam wieder abnehmen. Bitte wählen Sie sorgfältig den Ort, an dem Sie die Wandhalterung anbringen möchten.

Spezifikationen

Bluetooth Version	V5.3
Bluetooth Protocol	A2DP, AVRCP, HFP, HSP
Output Power	7W
Frequency Response	100~16KHz
Frequency Band	2402-2480MHz
Maximum Transmission Power	≤6dBm
Battery	(3.7v 2200mAh)/8.14Wh
Aufladezeit	3 Stunden @ 5V/1A
Wasserdichtigkeit	IPX7
Größe	109.6*109.6*48.2mm
Gewicht	260g

Kundenservice

- Eine 18-monatige Garantie
- Für weitere Dienstleistungen und Informationen senden Sie bitte eine E-Mail an support@tribit.com.

Vorsichtsmaßnahmen

- Stellen Sie den Lautsprecher nicht an einem Ort auf, an dem er leicht herunterfallen kann.
- Demontieren, reparieren oder modifizieren Sie dieses Produkt nicht selbst.
- Halten Sie den Lautsprecher von hohen Temperaturen fern.
- Verwenden Sie den Lautsprecher nicht bei Gewitter draußen.
- Verwenden Sie zum Reinigen des Lautsprechers keine korrosiven Reinigungsmittel oder andere chemische Lösungen.

Contenu de l'emballage

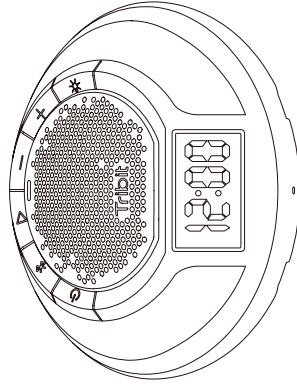

Tribit AquaEase



Câble USB-C



Manuel de l'utilisateur

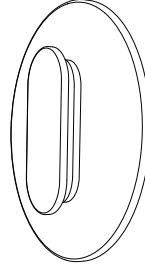

Support mural

Illustration du produit

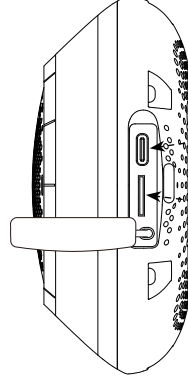
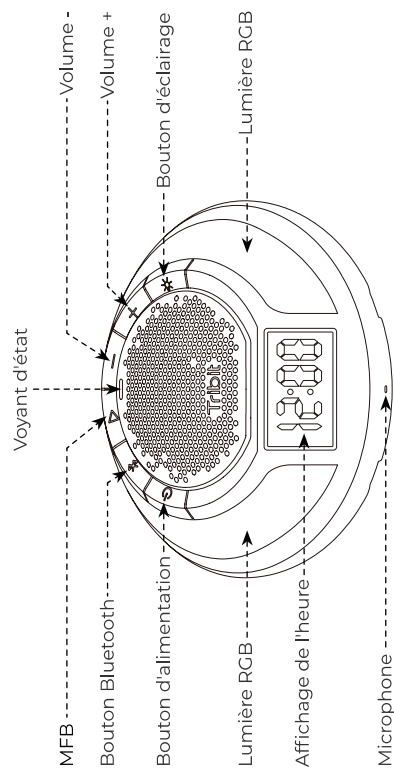
Fente pour carte SD
Port de charge USB-C

Comment charger le haut-parleur

Connectez l'autre extrémité du câble de charge à un adaptateur de charge et connectez le câble de charge au port de charge USB-C de l'enceinte Bluetooth.

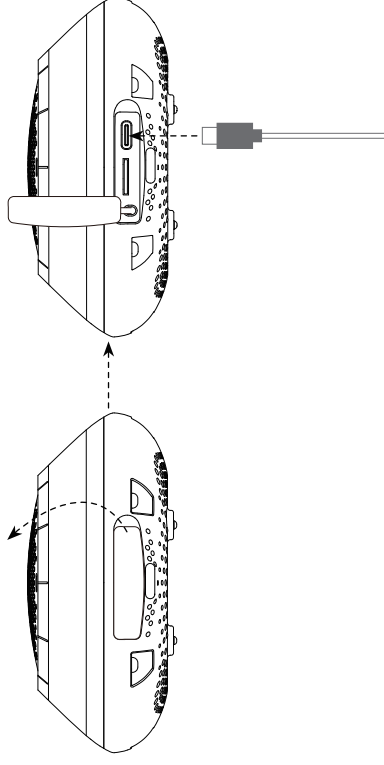

Remarque: Pendant la charge, le témoin lumineux est toujours allumé en rouge. Lorsque le haut-parleur est entièrement chargé, le voyant lumineux rouge s'éteint.

Commande des Touches

1. Marche/Arrêt

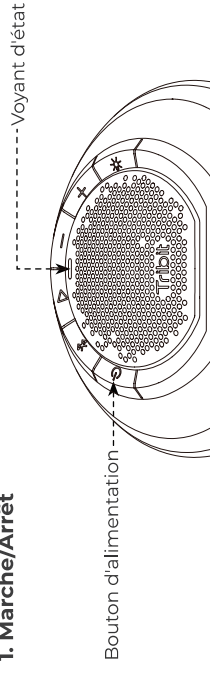

	Appuyez	Allumer	<ol style="list-style-type: none"> 1. Le voyant d'état est toujours allumé en bleu. 2. Lorsque la batterie est faible, le voyant d'état clignote en rouge. 3. Pendant la charge, le voyant est toujours allumé en rouge. 4. Lorsque l'enceinte est entièrement chargée, le voyant rouge s'éteint.
	Appuyez	Eteindre	Tous les voyants sont éteints et l'écran s'éteint.
	Appuyez et maintenez pendant 8s	Arrêt forcé	Tous les voyants sont éteints et l'écran s'éteint.

Remarque: si l'enceinte Tribit AquaEase ne peut pas être mise hors tension pour des raisons inconnues, vous pouvez l'éteindre de force en appuyant sur le bouton d'alimentation et en le maintenant enfoncé pendant 8 secondes, puis l'enceinte redémarrera automatiquement.

2. Bluetooth Verbindung

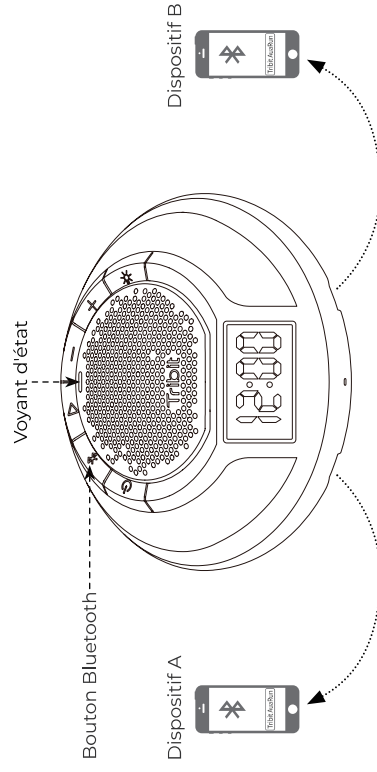

	Appuyez sur le bouton Bluetooth et maintenez-le enfoncé pendant 1s	L'enceinte passe automatiquement en mode de couplage Bluetooth.	Le témoin lumineux bleu clignote rapidement.
--	--	---	--

Tribit AquaEase:

- se reconnecte automatiquement au dernier appareil jumelé.
- connecte 2 appareils Bluetooth en même temps.
- mémorise 8 appareils Bluetooth.

Remarque: Lorsque 2 appareils sont connectés à l'enceinte Tribit AquaEase, l'appareil A et l'appareil B ne peuvent pas jouer simultanément - mettez l'enceinte A en pause pour que l'enceinte B puisse jouer ou vice versa.

3. Bouton multifonctionnel (MFB)

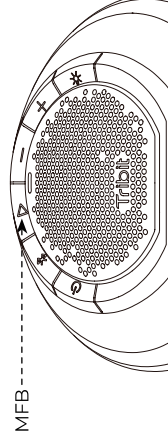

	Appuyez une fois	Lecture / Pause
	Appuyer deux fois	Piste suivante
	Appuyer trois fois	Piste précédente
Mode Musique	Appuyez et maintenez pendant 1 seconde	Activer l'assistant vocal
	Appuyez sur	Répondre / terminer un appel
	Appuyez et maintenez la pression pendant 1 seconde	Rejeter un appel
	Appuyez et maintenez enfoncé pendant 1 seconde (pendant un appel)	Mettre en pause l'appel en cours et répondre à un appel entrant
Conversation téléphonique	Appuyez sur (pendant un appel à trois)	Basculer entre les 2 appels
	Appuyez sur la touche et maintenez-la enfoncée pendant 1 seconde (pendant un appel à trois).	Terminer l'appel alors que l'appelant n'est pas en ligne

4. Volume

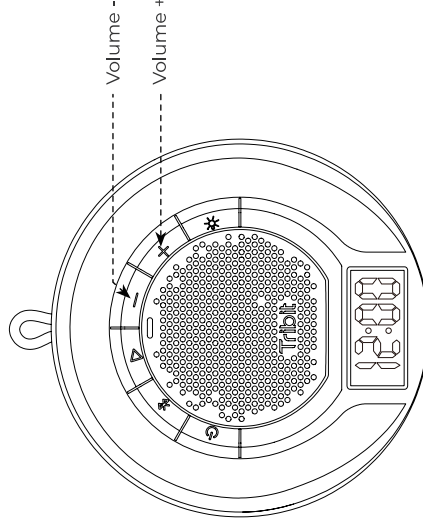

+	Appuyez	Augmenter le volume
	Appuyez et maintenez	Augmenter continuellement le volume
-	Appuyez	Diminuer le volume
	Appuyez et maintenez	Diminuer continuellement le volume

5. Lumière d'ambiance multicolore

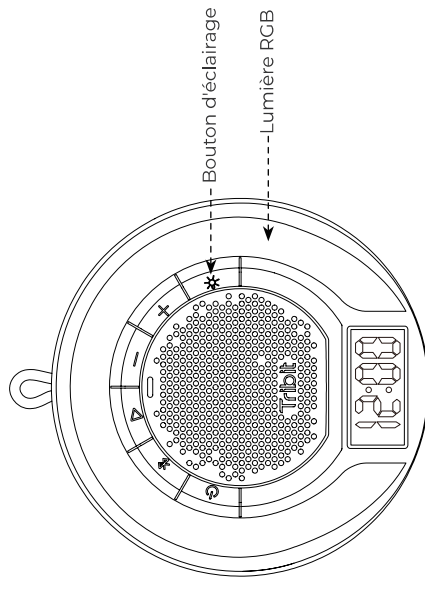

	Appuyez sur	Allumer / Eteindre l'effet de lumière
--	-------------	---------------------------------------

6. Mode stéréo

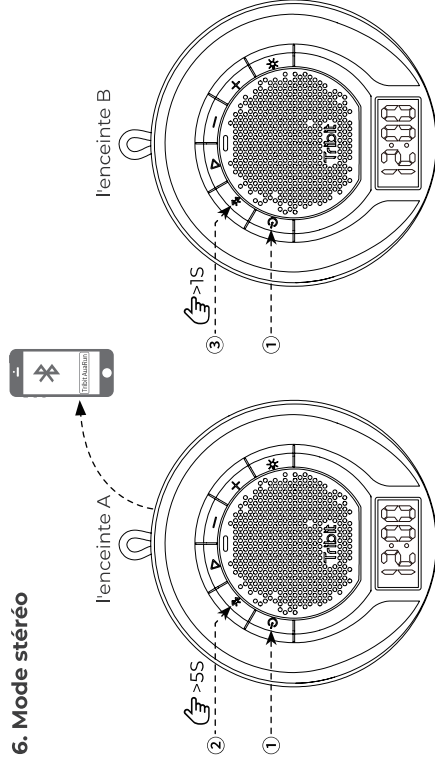

- ① Assurez-vous que l'enceinte A et l'enceinte B sont toutes deux allumées.
- ② Appuyez sur le bouton Bluetooth de l'enceinte A et maintenez-le enfoncé pendant 5 secondes pour passer en mode de couplage stéréo. (L'enceinte A est l'enceinte principale).
- ③ Appuyez sur le bouton Bluetooth de l'enceinte B et maintenez-le enfoncé pendant 1 seconde pour passer en mode de couplage stéréo. (L'enceinte B est l'enceinte secondaire.)
- ④ Lorsque vous entendez le message " Mode stéréo ", le couplage stéréo est réussi. Lorsque vous entrez dans le mode stéréo, l'enceinte principale affiche "Canal gauche" et l'enceinte secondaire affiche "Canal droit".

Remarque: le mode stéréo n'est disponible que lorsque 2 enceintes Tribit Aquatic sont présentes.

7. Réinitialiser

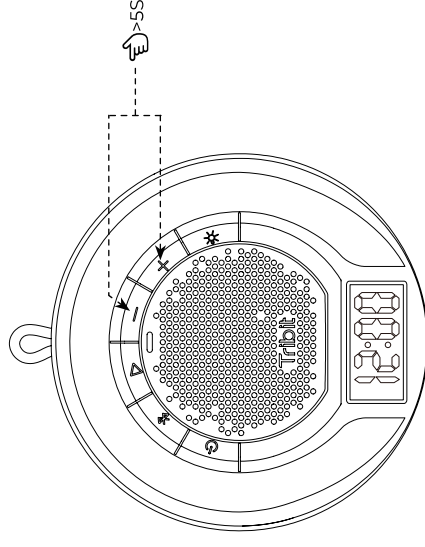

En cas de dysfonctionnement, vous pouvez essayer de réinitialiser l'enceinte (appuyez simultanément sur les boutons Volume + et Volume - pendant 5 secondes) pour remédier aux problèmes. Une fois la réinitialisation effectuée, toutes les anciennes données ont été effacées et vous devez à nouveau associer l'enceinte à votre périphérique Bluetooth.

Comment installer le support mural

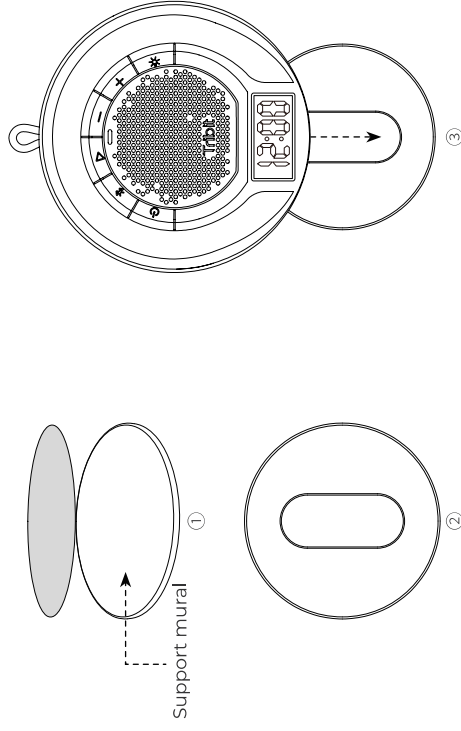

Remarque: Une fois le support mural collé au mur, il est difficile et peu pratique de le lever. Veuillez choisir soigneusement l'endroit où vous souhaitez installer le support mural.

Fiche technique du produit

Version de Bluetooth	V5.3
Protocole Bluetooth	A2DP, AVRCP, HFP, HSP
Puissance de sortie	7W
Réponse en fréquence	100~16KHZ
Bande de fréquence	2402-2480MHz
Puissance de transmission maximale	≤6dBm
Batterie	(3.7v 2200mAh)/8.14Wh
Temps de charge	3 heures @ 5V/1A
Niveau d'étanchéité	IPX7
Taille	109.6*109.6*48.2mm
Poids	260g

Service clientèle

- Une garantie de 18 mois
- Pour plus de services et d'informations, veuillez envoyer un courriel à support@tribit.com.

Précautions de sécurité

- Ne placez pas l'enceinte dans un endroit où il serait facile de tomber.
- Ne pas démonter, réparer ou modifier ce produit par vous-même.
- Conservez l'enceinte à l'abri des températures extrêmes.
- N'utilisez pas l'enceinte dans un environnement extérieur orageux.
- N'utilisez pas de nettoyants corrosifs ou d'autres solutions chimiques pour nettoyer l'enceinte.

Contenido del paquete



Cable USB-C



Manual de usuario

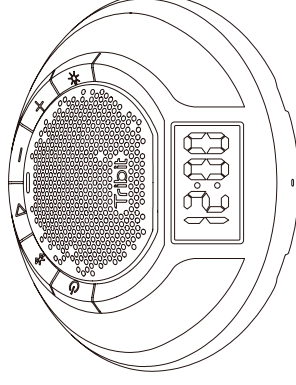

Tribit AquaEase

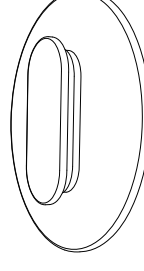

Soporte de pared

Ilustración del producto

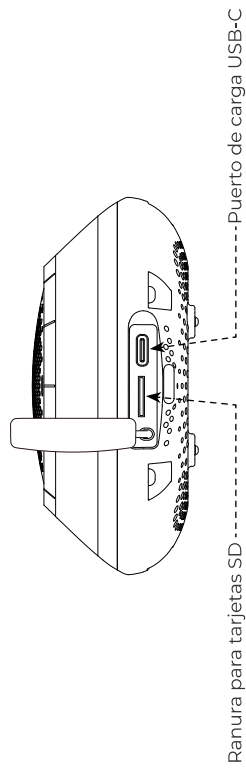
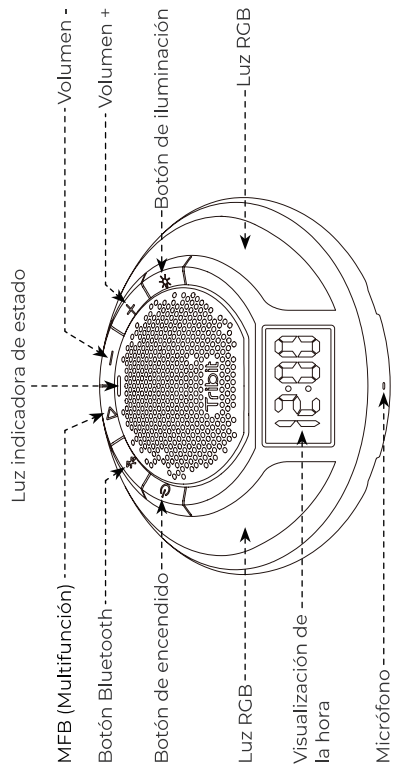

Cómo cargar el altavoz

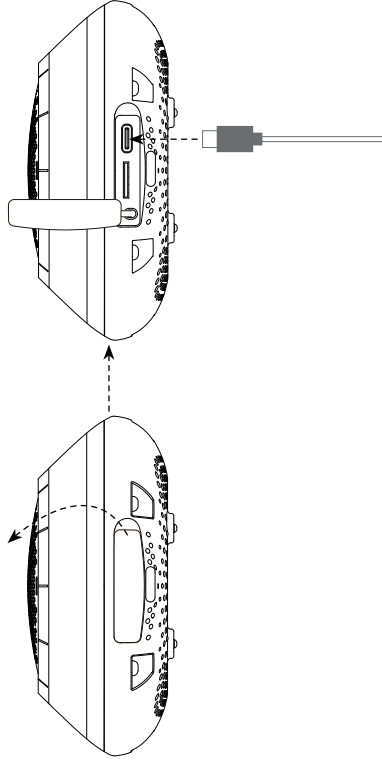

1. Conecte un extremo del cable de carga a un adaptador de corriente y el otro al puerto de carga USB-C en el altavoz Bluetooth.
2. Durante la carga, la luz indicadora siempre está encendida en rojo.
3. Cuando el altavoz está completamente cargado, la luz indicadora roja se apagará.

Instrucciones de uso de los botones

1. Encendido/apagado

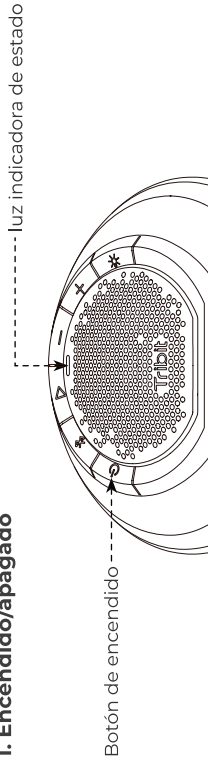

	Presionar	<ol style="list-style-type: none"> 1. La luz indicadora de estado siempre estará encendida en azul. 2. Cuando la batería esté baja, el indicador parpadeará en rojo. 3. Durante la carga, el indicador siempre está encendido en rojo. 4. Cuando el altavoz está completamente cargado, la luz indicadora roja se apagará.
	Presionar	Todas las luces y la pantalla se apagan.
	Mantener presionado durante 8 segundos	Todas las luces y la pantalla se apagan.

Nota: Si el altavoz no puede apagarse por razones desconocidas, puede apagarlo a la fuerza manteniendo presionado el botón de encendido durante 8 segundos, y luego se reiniciará automáticamente.

2. Conexión Bluetooth

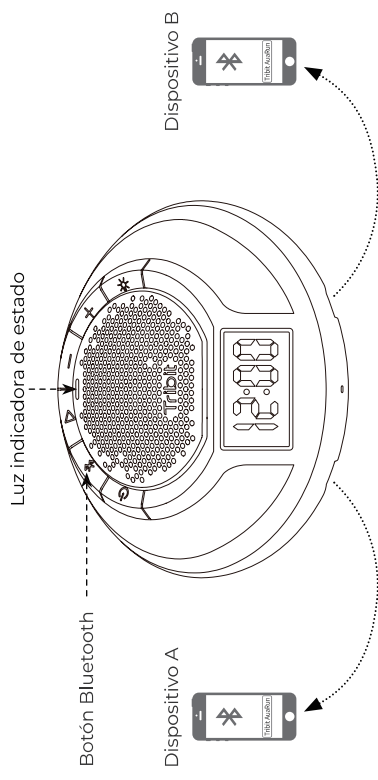

	Mantenga presionado el botón Bluetooth durante 1 segundo.	El altavoz entrará automáticamente en el modo de emparejamiento Bluetooth	La luz indicadora azul parpadeará rápidamente.
--	---	---	--

Tribit AquaEase:

- Se vuelve a conectar automáticamente al último dispositivo emparejado.
- Conecta 2 dispositivos Bluetooth al mismo tiempo.
- Memoriza hasta 8 dispositivos Bluetooth.

Nota: Cuando se conectan 2 dispositivos al altavoz, el dispositivo A y el dispositivo B no pueden reproducir simultáneamente. Pausa el altavoz A para que el altavoz B pueda reproducir o viceversa.

3. Bouton multifonctionnel (MFB)

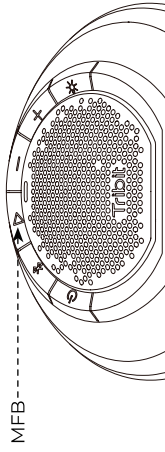

	Pulse una vez	Reproducir/Pausar
	Pulse dos veces	Pista siguiente
	Pulse tres veces	Pista anterior
Modo Música	Mantenga presionado durante 1 segundo	Activar asistente de voz
	Pulsar	Responder / finalizar una llamada
	Mantenga pulsado durante 1 segundo	Rechazar una llamada
	Mantenga pulsado durante 1 segundo (durante una llamada)	Pause la llamada actual y responde una llamada entrante
	Pulsar (durante una llamada a tres)	Cambie entre las 2 llamadas.
	Mantenga pulsado durante 1 segundo (durante una llamada a tres)	Finalice la llamada con la persona que llama fuera de línea.

4. Volumen

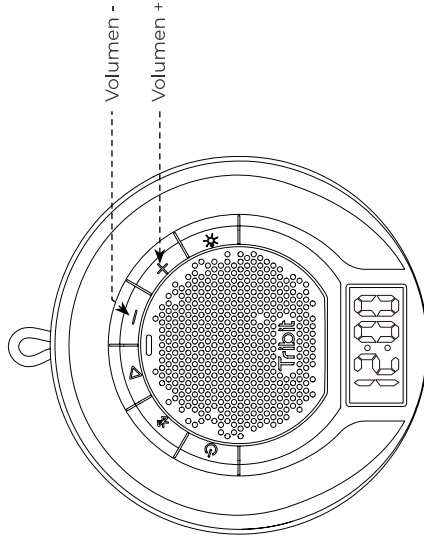

	Pulsar	Subir el volumen
	Mantener pulsado	Aumentar continuamente el volumen
	Pulsar	Bajar el volumen
	Mantener pulsado	Disminuir continuamente el volumen