

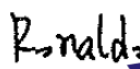

# TEST REPORT

FCC ID..... :	2ALNA-BTH21	
Test Report No..... :	TCT230828E015	
Date of issue..... :	Sep. 04, 2023	
Testing laboratory .....	SHENZHEN TONGCE TESTING LAB	
Testing location/ address:	2101 & 2201, Zhenchang Factory Renshan Industrial Zone, Fuhai Subdistrict, Bao'an District, Shenzhen, Guangdong, 518103, People's Republic of China	
Applicant's name..... :	Shenzhen Thousandshores Technology Co., Ltd.	
Address..... :	Room 1101, Building B, Lotus Plaza, No. 3186, Nanshan Avenue, Majialong Community, Nantou Street, Nanshan District, Shenzhen, China	
Manufacturer's name ... :	Shenzhen Thousandshores Technology Co., Ltd.	
Address..... :	Room 1101, Building B, Lotus Plaza, No. 3186, Nanshan Avenue, Majialong Community, Nantou Street, Nanshan District, Shenzhen, China	
Standard(s) .....	FCC CFR Title 47 Part 15 Subpart C Section 15.247 FCC KDB 558074 D01 15.247 Meas Guidance v05r02 ANSI C63.10:2013	
Product Name..... :	Wireless Headphones	
Trade Mark .....	iClever	
Model/Type reference..... :	BTH21	
Rating(s)..... :	Input: DC 5V, 1A Rechargeable Li-ion Battery DC 3.7V	
Date of receipt of test item .....	Aug. 28, 2023	
Date (s) of performance of test..... :	Aug. 16, 2023 - Sep. 04, 2023	
Tested by (+signature) ... :	Ronaldo LUO	
Check by (+signature).... :	Beryl ZHAO	
Approved by (+signature):	Tomsin	



**General disclaimer:**

This report shall not be reproduced except in full, without the written approval of SHENZHEN TONGCE TESTING LAB. This document may be altered or revised by SHENZHEN TONGCE TESTING LAB personnel only, and shall be noted in the revision section of the document. The test results in the report only apply to the tested sample.

## Table of Contents

<b>1. General Product Information .....</b>	<b>3</b>
1.1. EUT description .....	3
1.2. Model(s) list.....	3
1.3. Operation Frequency .....	4
<b>2. Test Result Summary .....</b>	<b>5</b>
<b>3. General Information.....</b>	<b>6</b>
3.1. Test environment and mode.....	6
3.2. Description of Support Units.....	6
<b>4. Facilities and Accreditations .....</b>	<b>7</b>
4.1. Facilities .....	7
4.2. Location .....	7
4.3. Measurement Uncertainty.....	7
<b>5. Test Results and Measurement Data .....</b>	<b>8</b>
5.1. Antenna requirement .....	8
5.2. Conducted Emission.....	9
5.3. Conducted Output Power .....	13
5.4. 20dB Occupy Bandwidth .....	14
5.5. Carrier Frequencies Separation .....	15
5.6. Hopping Channel Number .....	16
5.7. Dwell Time.....	17
5.8. Pseudorandom Frequency Hopping Sequence.....	18
5.9. Conducted Band Edge Measurement.....	19
5.10. Conducted Spurious Emission Measurement.....	20
5.11. Radiated Spurious Emission Measurement.....	21
<b>Appendix A: Test Result of Conducted Test</b>	
<b>Appendix B: Photographs of Test Setup</b>	
<b>Appendix C: Photographs of EUT</b>	

## 1. General Product Information

### 1.1. EUT description

Product Name.....:	Wireless Headphones
Model/Type reference.....:	BTH21
Sample Number.....:	TCT230828E015-0101
Bluetooth Version .....	V5.3 (This report is for BDR+EDR)
Operation Frequency .....	2402MHz~2480MHz
Transfer Rate .....	1/2/3 Mbits/s
Number of Channel .....	79
Modulation Type .....	GFSK, $\pi/4$ -DQPSK, 8DPSK
Modulation Technology .....	FHSS
Antenna Type.....:	PCB Antenna
Antenna Gain.....:	0dBi
Rating(s).....:	Input: DC 5V, 1A Rechargeable Li-ion Battery DC 3.7V

Note: The antenna gain listed in this report is provided by applicant, and the test laboratory is not responsible for this parameter.

### 1.2. Model(s) list

None.

### 1.3. Operation Frequency

Channel	Frequency	Channel	Frequency	Channel	Frequency	Channel	Frequency
0	2402MHz	20	2422MHz	40	2442MHz	60	2462MHz
1	2403MHz	21	2423MHz	41	2443MHz	61	2463MHz
...	...	...	...	...	...	...	...
10	2412MHz	30	2432MHz	50	2452MHz	70	2472MHz
11	2413MHz	31	2433MHz	51	2453MHz	71	2473MHz
...	...	...	...	...	...	...	...
18	2420MHz	38	2440MHz	58	2460MHz	78	2480MHz
19	2421MHz	39	2441MHz	59	2461MHz		-

Remark: Channel 0, 39 & 78 have been tested for GFSK,  $\pi/4$ -DQPSK, 8DPSK modulation mode.

## 2. Test Result Summary

Requirement	CFR 47 Section	Result
Antenna Requirement	§15.203/§15.247 (c)	PASS
AC Power Line Conducted Emission	§15.207	PASS
Conducted Peak Output Power	§15.247 (b)(1)	PASS
20dB Occupied Bandwidth	§15.247 (a)(1)	PASS
Carrier Frequencies Separation	§15.247 (a)(1)	PASS
Hopping Channel Number	§15.247 (a)(1)	PASS
Dwell Time	§15.247 (a)(1)	PASS
Radiated Emission	§15.205/§15.209	PASS
Band Edge	§15.247(d)	PASS

**Note:**

1. PASS: Test item meets the requirement.
2. Fail: Test item does not meet the requirement.
3. N/A: Test case does not apply to the test object.
4. The test result judgment is decided by the limit of test standard.

### 3. General Information

#### 3.1. Test environment and mode

Operating Environment:		
Condition	Conducted Emission	Radiated Emission
Temperature:	24.8 °C	24.3 °C
Humidity:	52 % RH	50 % RH
Atmospheric Pressure:	1010 mbar	1010 mbar
Test Software:		
Software Information:	FCC Assist 1.0.2.2	
Power Level:	10	
Test Mode:		
Engineer mode:	Keep the EUT in continuous transmitting by select channel and modulations with Fully-charged battery	
The sample was placed 0.8m & 1.5m for the measurement below & above 1GHz above the ground plane of 3m chamber. Measurements in both horizontal and vertical polarities were performed. During the test, each emission was maximized by: having the EUT continuously working, investigated all operating modes, rotated about all 3 axis (X, Y & Z) and considered typical configuration to obtain worst position, manipulating interconnecting cables, rotating the turntable, varying antenna height from 1m to 4m in both horizontal and vertical polarizations. The emissions worst-case( Z axis) are shown in Test Results of the following pages. DH1 DH3 DH5 all have been tested, only worse case DH1 is reported.		

#### 3.2. Description of Support Units

The EUT has been tested as an independent unit together with other necessary accessories or support units. The following support units or accessories were used to form a representative test configuration during the tests.

Equipment	Model No.	Serial No.	FCC ID	Trade Name
Adapter	EP-TA200	R37M4PR7QD4SE3	/	SAMSUNG

**Note:**

1. All the equipment/cables were placed in the worst-case configuration to maximize the emission during the test.
2. Grounding was established in accordance with the manufacturer's requirements and conditions for the intended use.
3. For conducted measurements (Output Power, 20dB Occupied Bandwidth, Carrier Frequencies Separation, Hopping Channel Number, Dwell Time, Spurious Emissions), the antenna of EUT is connected to the test equipment via temporary antenna connector, the antenna connector is soldered on the antenna port of EUT, and the temporary antenna connector is listed in the Test Instruments.

## 4. Facilities and Accreditations

### 4.1. Facilities

The test facility is recognized, certified, or accredited by the following organizations:

- FCC - Registration No.: 645098  
SHENZHEN TONGCE TESTING LAB  
Designation Number: CN1205

The testing lab has been registered and fully described in a report with the (FCC) Federal Communications Commission. The acceptance letter from the FCC is maintained in our files.

- IC - Registration No.: 10668A-1  
SHENZHEN TONGCE TESTING LAB  
CAB identifier: CN0031

The testing lab has been registered by Certification and Engineering Bureau of Industry Canada for radio equipment testing.

### 4.2. Location

SHENZHEN TONGCE TESTING LAB

Address: 2101 & 2201, Zhenchang Factory Renshan Industrial Zone, Fuhai Subdistrict, Bao'an District, Shenzhen, Guangdong, 518103, People's Republic of China  
TEL: +86-755-27673339

### 4.3. Measurement Uncertainty

The reported uncertainty of measurement  $y \pm U$ , where expanded uncertainty  $U$  is based on a standard uncertainty multiplied by a coverage factor of  $k=2$ , providing a level of confidence of approximately 95 %.

No.	Item	MU
1	Conducted Emission	$\pm 3.10$ dB
2	RF power, conducted	$\pm 0.12$ dB
3	Spurious emissions, conducted	$\pm 0.11$ dB
4	All emissions, radiated(<1 GHz)	$\pm 4.56$ dB
5	All emissions, radiated(1 GHz - 18 GHz)	$\pm 4.22$ dB
6	All emissions, radiated(18 GHz- 40 GHz)	$\pm 4.36$ dB

## 5. Test Results and Measurement Data

### 5.1. Antenna requirement

**Standard requirement:**

FCC Part15 C Section 15.203 /247(c)

15.203 requirement:

An intentional radiator shall be designed to ensure that no antenna other than that furnished by the responsible party shall be used with the device. The use of a permanently attached antenna or of an antenna that uses a unique coupling to the intentional radiator, the manufacturer may design the unit so that a broken antenna can be replaced by the user, but the use of a standard antenna jack or electrical connector is prohibited.

15.247(c) (1)(i) requirement:

(i) Systems operating in the 2400-2483.5 MHz band that is used exclusively for fixed. Point-to-point operations may employ transmitting antennas with directional gain greater than 6dBi provided the maximum conducted output power of the intentional radiator is reduced by 1 dB for every 3 dB that the directional gain of the antenna exceeds 6dBi.

**E.U.T Antenna:**

The Bluetooth antenna is PCB antenna which permanently attached, and the best case gain of the antenna is 0dBi.

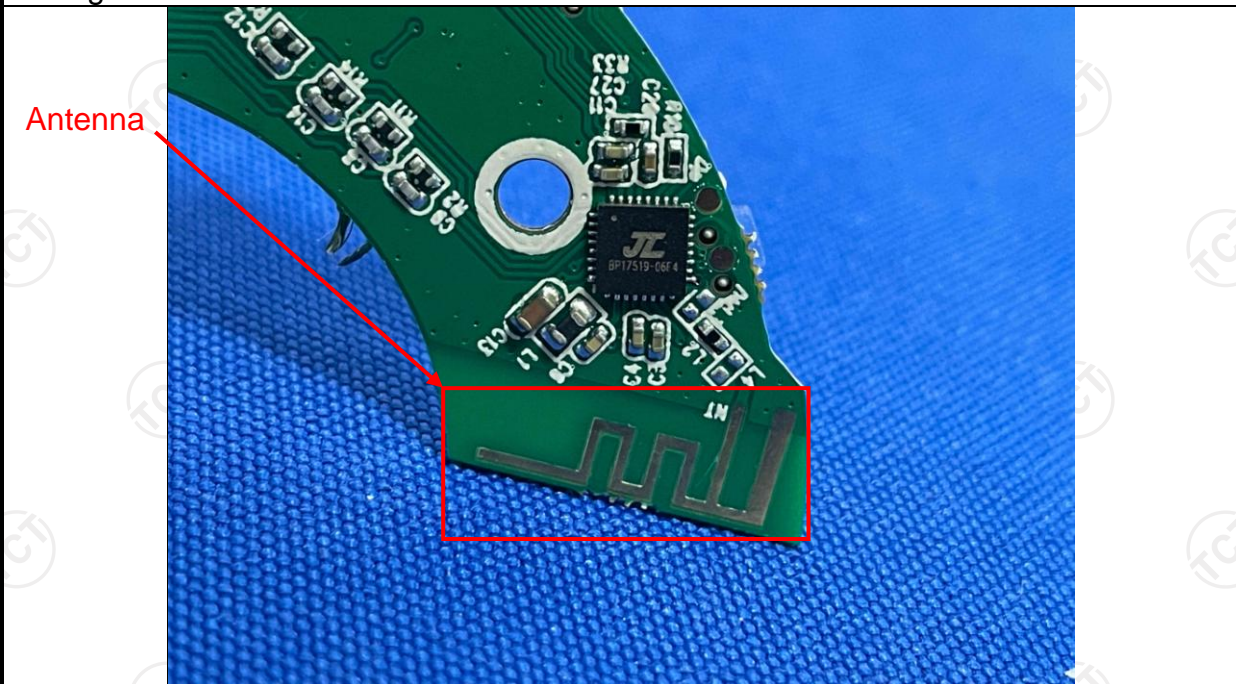



## 5.2. Conducted Emission

### 5.2.1. Test Specification

<b>Test Requirement:</b>	FCC Part15 C Section 15.207														
<b>Test Method:</b>	ANSI C63.10:2013														
<b>Frequency Range:</b>	150 kHz to 30 MHz														
<b>Receiver setup:</b>	RBW=9 kHz, VBW=30 kHz, Sweep time=auto														
<b>Limits:</b>	<table border="1"> <thead> <tr> <th rowspan="2">Frequency range (MHz)</th> <th colspan="2">Limit (dBuV)</th> </tr> <tr> <th>Quasi-peak</th> <th>Average</th> </tr> </thead> <tbody> <tr> <td>0.15-0.5</td> <td>66 to 56*</td> <td>56 to 46*</td> </tr> <tr> <td>0.5-5</td> <td>56</td> <td>46</td> </tr> <tr> <td>5-30</td> <td>60</td> <td>50</td> </tr> </tbody> </table>	Frequency range (MHz)	Limit (dBuV)		Quasi-peak	Average	0.15-0.5	66 to 56*	56 to 46*	0.5-5	56	46	5-30	60	50
Frequency range (MHz)	Limit (dBuV)														
	Quasi-peak	Average													
0.15-0.5	66 to 56*	56 to 46*													
0.5-5	56	46													
5-30	60	50													
<b>Test Setup:</b>	<p><i>Remark</i> E.U.T: Equipment Under Test LISN: Line Impedance Stabilization Network Test table height=0.8m</p>														
<b>Test Mode:</b>	Charging + Transmitting Mode														
<b>Test Procedure:</b>	<ol style="list-style-type: none"> <li>1. The E.U.T is connected to an adapter through a line impedance stabilization network (L.I.S.N.). This provides a 50ohm/50uH coupling impedance for the measuring equipment.</li> <li>2. The peripheral devices are also connected to the main power through a LISN that provides a 50ohm/50uH coupling impedance with 50ohm termination. (Please refer to the block diagram of the test setup and photographs).</li> <li>3. Both sides of A.C. line are checked for maximum conducted interference. In order to find the maximum emission, the relative positions of equipment and all of the interface cables must be changed according to ANSI C63.10:2013 on conducted measurement.</li> </ol>														
<b>Test Result:</b>	PASS														

**5.2.2. Test Instruments**

Conducted Emission Shielding Room Test Site (843)				
Equipment	Manufacturer	Model	Serial Number	Calibration Due
EMI Test Receiver	R&S	ESCI3	100898	Jun. 29, 2024
Line Impedance Stabilisation Newtork(LISN)	Schwarzbeck	NSLK 8126	8126453	Feb. 20, 2024
Line-5	TCT	CE-05	/	Jul. 03, 2024
EMI Test Software	Shurple Technology	EZ-EMC	/	/

5.2.3. Test data

Please refer to following diagram for individual

Conducted Emission on Line Terminal of the power line (150 kHz to 30MHz)

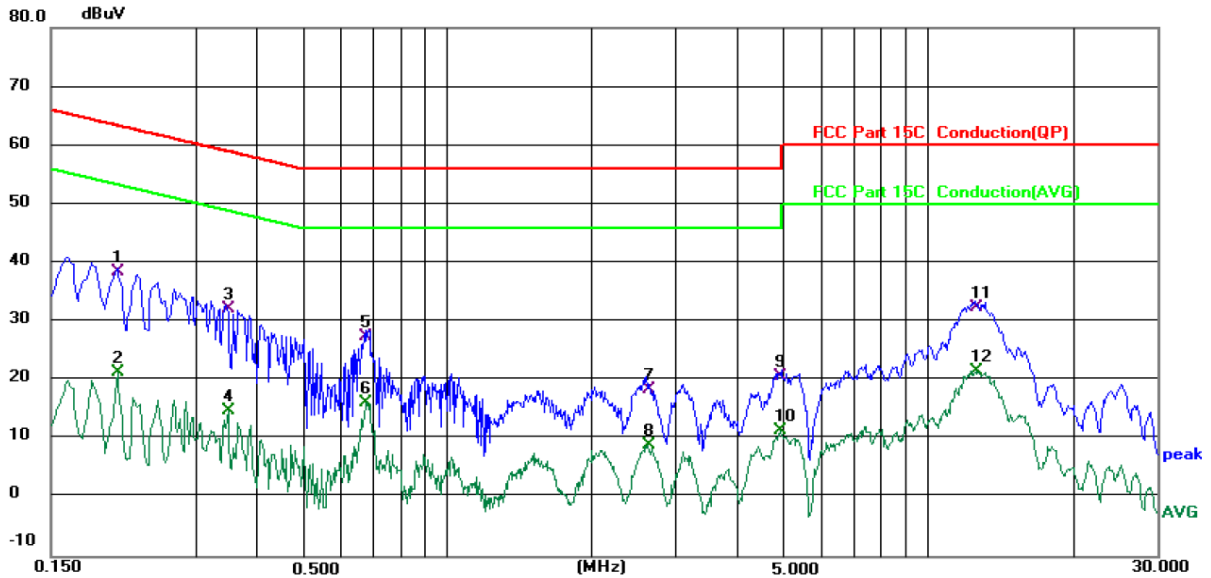

Site 844 Shielding Room

Phase: **L1**

Temperature: 24.6 (°C)

Humidity: 54 %

Limit: FCC Part 15C Conduction(QP)

Power: DC 5 V(Adapter Input AC 120 V/60 Hz)

No.	Mk.	Freq. MHz	Reading Level dBuV	Correct Factor dB	Measure- ment dBuV	Limit dBuV	Over dB	Detector	Comment
1	*	0.2060	28.29	10.16	38.45	63.37	-24.92	QP	
2		0.2060	11.24	10.16	21.40	53.37	-31.97	AVG	
3		0.3500	22.62	9.59	32.21	58.96	-26.75	QP	
4		0.3500	5.22	9.59	14.81	48.96	-34.15	AVG	
5		0.6820	18.10	9.28	27.38	56.00	-28.62	QP	
6		0.6820	7.00	9.28	16.28	46.00	-29.72	AVG	
7		2.6140	8.52	10.02	18.54	56.00	-37.46	QP	
8		2.6140	-1.05	10.02	8.97	46.00	-37.03	AVG	
9		4.9300	10.55	10.10	20.65	56.00	-35.35	QP	
10		4.9300	1.45	10.10	11.55	46.00	-34.45	AVG	
11		12.5860	22.35	10.16	32.51	60.00	-27.49	QP	
12		12.5860	11.52	10.16	21.68	50.00	-28.32	AVG	

**Note:**

Freq. = Emission frequency in MHz

Reading level (dBuV) = Receiver reading

Corr. Factor (dB) = LISN factor + Cable loss

Measurement (dBuV) = Reading level (dBuV) + Corr. Factor (dB)

Limit (dBuV) = Limit stated in standard

Margin (dB) = Measurement (dBuV) – Limits (dBuV)

Q.P. =Quasi-Peak

AVG =average

\* is meaning the worst frequency has been tested in the frequency range 150 kHz to 30MHz.

## Conducted Emission on Neutral Terminal of the power line (150 kHz to 30MHz)

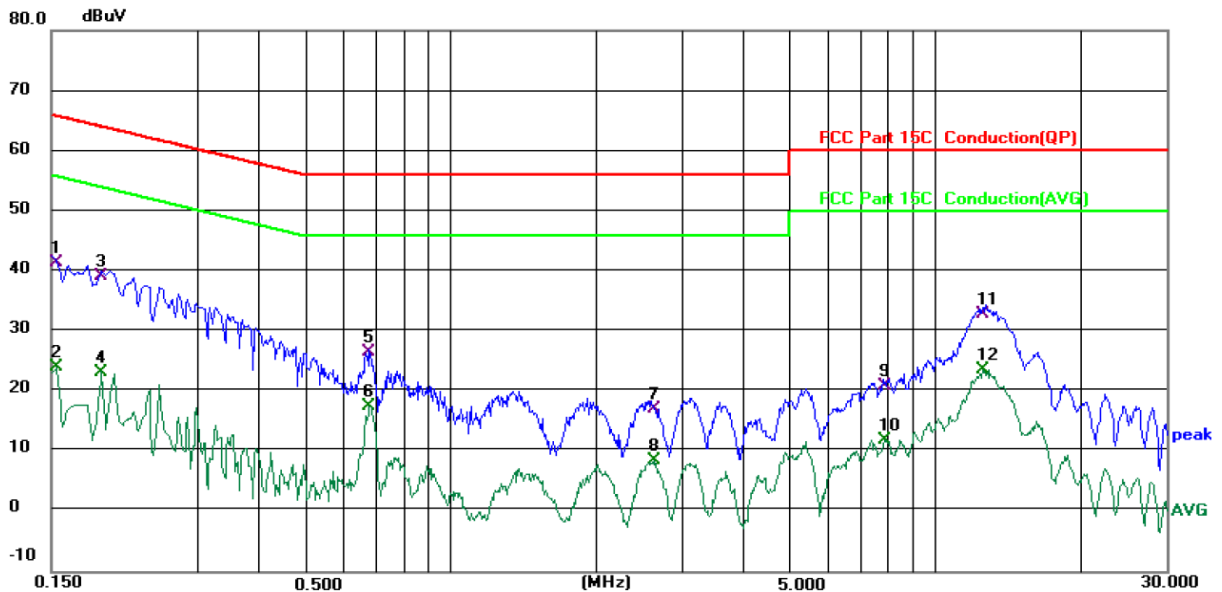

Site 844 Shielding Room

Phase: *N*

Temperature: 24.6 (°C)

Humidity: 54 %

Limit: FCC Part 15C Conduction(QP)

Power: DC 5 V(Adapter Input AC 120 V/60 Hz)

No.	Mk.	Freq. MHz	Reading Level dBuV	Correct Factor dB	Measure- ment dBuV	Limit dBuV	Over dB	Detector	Comment
1	*	0.1539	31.24	10.09	41.33	65.79	-24.46	QP	
2		0.1539	13.94	10.09	24.03	55.79	-31.76	AVG	
3		0.1900	28.94	10.14	39.08	64.04	-24.96	QP	
4		0.1900	13.16	10.14	23.30	54.04	-30.74	AVG	
5		0.6820	17.29	9.29	26.58	56.00	-29.42	QP	
6		0.6820	8.31	9.29	17.60	46.00	-28.40	AVG	
7		2.6300	6.99	10.03	17.02	56.00	-38.98	QP	
8		2.6300	-1.53	10.03	8.50	46.00	-37.50	AVG	
9		7.8700	10.80	10.16	20.96	60.00	-39.04	QP	
10		7.8700	1.82	10.16	11.98	50.00	-38.02	AVG	
11		12.5259	22.64	10.23	32.87	60.00	-27.13	QP	
12		12.5259	13.43	10.23	23.66	50.00	-26.34	AVG	

### Note1:

Freq. = Emission frequency in MHz

Reading level (dBuV) = Receiver reading

Corr. Factor (dB) = LISN factor + Cable loss

Measurement (dBuV) = Reading level (dBuV) + Corr. Factor (dB)

Limit (dBuV) = Limit stated in standard

Margin (dB) = Measurement (dBuV) – Limits (dBuV)

Q.P. =Quasi-Peak AVG =average

\* is meaning the worst frequency has been tested in the frequency range 150 kHz to 30MHz.

### Note2:

Measurements were conducted in all three channels (high, middle, low) and three modulation (GFSK, Pi/4 DQPSK, 8DPSK), and the worst case Mode (Lowest channel and 8DPSK) was submitted only.

### 5.3. Conducted Output Power

#### 5.3.1. Test Specification

<b>Test Requirement:</b>	FCC Part15 C Section 15.247 (b)(1)
<b>Test Method:</b>	KDB 558074 D01 v05r02
<b>Limit:</b>	Section 15.247 (b) The maximum peak conducted output power of the intentional radiator shall not exceed the following: (1) For frequency hopping systems operating in the 2400-2483.5 MHz band employing at least 75 non-overlapping hopping channels, and all frequency hopping systems in the 5725-5850 MHz band: 1 watt. For all other frequency hopping systems in the 2400-2483.5 MHz band 0.125 watts.
<b>Test Setup:</b>	 <p style="text-align: center;">Spectrum Analyzer                      EUT</p>
<b>Test Mode:</b>	Transmitting mode with modulation
<b>Test Procedure:</b>	Use the following spectrum analyzer settings: Span = approximately 5 times the 20 dB bandwidth, centered on a hopping channel RBW > the 20 dB bandwidth of the emission being measured VBW ≥ RBW Sweep = auto Detector function = peak Trace = max hold Allow the trace to stabilize. Use the marker-to-peak function to set the marker to the peak of the emission.
<b>Test Result:</b>	PASS

#### 5.3.2. Test Instruments

Name	Manufacturer	Model No.	Serial Number	Calibration Due
Spectrum Analyzer	Agilent	N9020A	MY49100619	Jun. 28, 2024
Combiner Box	Ascentest	AT890-RFB	/	/

## 5.4.20dB Occupy Bandwidth

### 5.4.1. Test Specification

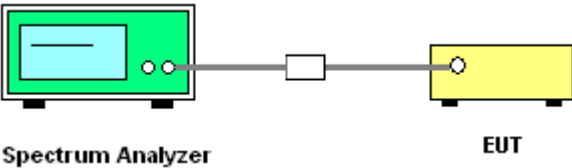
<b>Test Requirement:</b>	FCC Part15 C Section 15.247 (a)(1)
<b>Test Method:</b>	KDB 558074 D01 v05r02
<b>Limit:</b>	N/A
<b>Test Setup:</b>	 <p style="text-align: center;">Spectrum Analyzer                      EUT</p>
<b>Test Mode:</b>	Transmitting mode with modulation
<b>Test Procedure:</b>	<ol style="list-style-type: none"> <li>1. The RF output of EUT was connected to the spectrum analyzer by RF cable and attenuator. The path loss was compensated to the results for each measurement.</li> <li>2. Set to the maximum power setting and enable the EUT transmit continuously.</li> <li>3. Use the following spectrum analyzer settings for 20dB Bandwidth measurement. Span = approximately 2 to 5 times the 20 dB bandwidth, centered on a hopping channel; <math>1\% \leq RBW \leq 5\%</math> of the 20 dB bandwidth; <math>VBW \geq 3RBW</math>; Sweep = auto; Detector function = peak; Trace = max hold.</li> <li>4. Measure and record the results in the test report.</li> </ol>
<b>Test Result:</b>	PASS

### 5.4.2. Test Instruments

Name	Manufacturer	Model No.	Serial Number	Calibration Due
Spectrum Analyzer	Agilent	N9020A	MY49100619	Jun. 28, 2024
Combiner Box	Ascentest	AT890-RFB	/	/

### 5.5. Carrier Frequencies Separation

#### 5.5.1. Test Specification

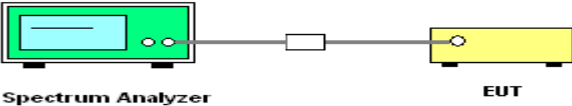
<b>Test Requirement:</b>	FCC Part15 C Section 15.247 (a)(1)
<b>Test Method:</b>	KDB 558074 D01 v05r02
<b>Limit:</b>	Frequency hopping systems shall have hopping channel carrier frequencies separated by a minimum of 25 kHz or the 20 dB bandwidth of the hopping channel, whichever is greater. Alternatively, frequency hopping systems operating in the 2400-2483.5 MHz band may have hopping channel carrier frequencies that are separated by 25 kHz or two-thirds of the 20 dB bandwidth of the hopping channel, whichever is greater, provided the systems operate with an output power no greater than 125 mW.
<b>Test Setup:</b>	 <p style="text-align: center;">Spectrum Analyzer                      EUT</p>
<b>Test Mode:</b>	Hopping mode
<b>Test Procedure:</b>	<ol style="list-style-type: none"> <li>1. The RF output of EUT was connected to the spectrum analyzer by RF cable and attenuator. The path loss was compensated to the results for each measurement.</li> <li>2. Set to the maximum power setting and enable the EUT transmit continuously.</li> <li>3. Enable the EUT hopping function.</li> <li>4. Use the following spectrum analyzer settings: Span = wide enough to capture the peaks of two adjacent channels; RBW is set to approximately 30% of the channel spacing, adjust as necessary to best identify the center of each individual channel; VBW≥RBW; Sweep = auto; Detector function = peak; Trace = max hold.</li> <li>5. Use the marker-delta function to determine the separation between the peaks of the adjacent channels. Record the value in report.</li> </ol>
<b>Test Result:</b>	PASS

#### 5.5.2. Test Instruments

Name	Manufacturer	Model No.	Serial Number	Calibration Due
Spectrum Analyzer	Agilent	N9020A	MY49100619	Jun. 28, 2024
Combiner Box	Ascentest	AT890-RFB	/	/

## 5.6. Hopping Channel Number

### 5.6.1. Test Specification

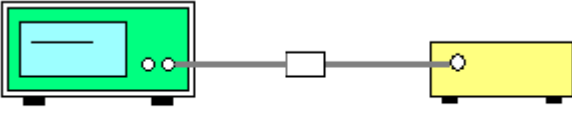
<b>Test Requirement:</b>	FCC Part15 C Section 15.247 (a)(1)
<b>Test Method:</b>	KDB 558074 D01 v05r02
<b>Limit:</b>	Frequency hopping systems in the 2400-2483.5 MHz band shall use at least 15 channels.
<b>Test Setup:</b>	 <p style="text-align: center;">Spectrum Analyzer                      EUT</p>
<b>Test Mode:</b>	Hopping mode
<b>Test Procedure:</b>	<ol style="list-style-type: none"> <li>1. The RF output of EUT was connected to the spectrum analyzer by RF cable and attenuator. The path loss was compensated to the results for each measurement.</li> <li>2. Set to the maximum power setting and enable the EUT transmit continuously.</li> <li>3. Enable the EUT hopping function.</li> <li>4. Use the following spectrum analyzer settings: Span = the frequency band of operation; set the RBW to less than 30% of the channel spacing or the 20 dB bandwidth, whichever is smaller; VBW ≥ RBW; Sweep = auto; Detector function = peak; Trace = max hold.</li> <li>5. The number of hopping frequency used is defined as the number of total channel.</li> <li>6. Record the measurement data in report.</li> </ol>
<b>Test Result:</b>	PASS

### 5.6.2. Test Instruments

Name	Manufacturer	Model No.	Serial Number	Calibration Due
Spectrum Analyzer	Agilent	N9020A	MY49100619	Jun. 28, 2024
Combiner Box	Ascentest	AT890-RFB	/	/



## 5.7.Dwell Time

### 5.7.1. Test Specification

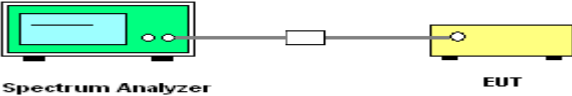
<b>Test Requirement:</b>	FCC Part15 C Section 15.247 (a)(1)
<b>Test Method:</b>	KDB 558074 D01 v05r02
<b>Limit:</b>	The average time of occupancy on any channel shall not be greater than 0.4 seconds within a period of 0.4 seconds multiplied by the number of hopping channels employed.
<b>Test Setup:</b>	 <p style="text-align: center;">Spectrum Analyzer                                  EUT</p>
<b>Test Mode:</b>	Hopping mode
<b>Test Procedure:</b>	<ol style="list-style-type: none"> <li>The RF output of EUT was connected to the spectrum analyzer by RF cable and attenuator. The path loss was compensated to the results for each measurement.</li> <li>Set to the maximum power setting and enable the EUT transmit continuously.</li> <li>Enable the EUT hopping function.</li> <li>Use the following spectrum analyzer settings: Span = zero span, centered on a hopping channel; RBW shall be <math>\leq</math> channel spacing and where possible RBW should be set <math>\gg 1/T</math>, where T is the expected dwell time per channel; VBW <math>\geq</math> RBW; Sweep = as necessary to capture the entire dwell time per hopping channel; Detector function = peak; Trace = max hold.</li> <li>Measure and record the results in the test report.</li> </ol>
<b>Test Result:</b>	PASS

### 5.7.2. Test Instruments

Name	Manufacturer	Model No.	Serial Number	Calibration Due
Spectrum Analyzer	Agilent	N9020A	MY49100619	Jun. 28, 2024
Combiner Box	Ascentest	AT890-RFB	/	/

### 5.8.Pseudorandom Frequency Hopping Sequence

**Test Requirement:** FCC Part15 C Section 15.247 (a)(1) requirement:

Frequency hopping systems shall have hopping channel carrier frequencies separated by a minimum of 25 kHz or the 20 dB bandwidth of the hopping channel, whichever is greater.

Alternatively. Frequency hopping systems operating in the 2400-2483.5 MHz band may have hopping channel carrier frequencies that are separated by 25 kHz or two-thirds of the 20 dB bandwidth of the hopping channel, whichever is greater, provided the systems operate with an output power no greater than 125 mW. The system shall hop to channel frequencies that are selected at the system hopping rate from a Pseudorandom ordered list of hopping frequencies. Each frequency must be used equally on the average by each transmitter. The system receivers shall have input bandwidths that match the hopping channel bandwidths of their corresponding transmitters and shall shift frequencies in synchronization with the transmitted signals.

**EUT Pseudorandom Frequency Hopping Sequence**

The pseudorandom sequence may be generated in a nine-stage shift register whose 5th and 9th stage outputs are added in a modulo-two addition stage. And the result is fed back to the input of the first stage. The sequence begins with the first one of 9 consecutive ones; i.e. the shift register is initialized with nine ones.

- Number of shift register stages: 9
- Length of pseudo-random sequence:  $2^9 - 1 = 511$  bits
- Longest sequence of zeros: 8 (non-inverted signal)

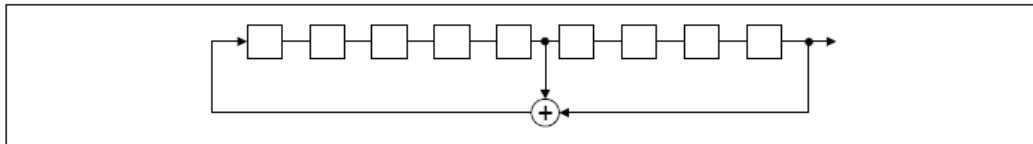

Linear Feedback Shift Register for Generation of the PRBS sequence

An example of Pseudorandom Frequency Hopping Sequence as follow:

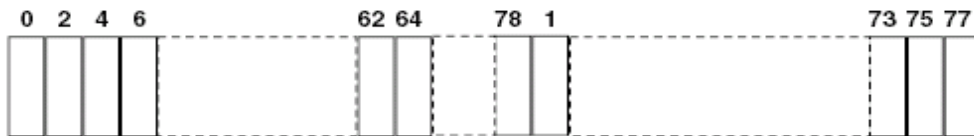

Each frequency used equally on the average by each transmitter. The system receivers have input bandwidths that match the hopping channel bandwidths of their corresponding transmitters and shift frequencies in synchronization with the transmitted signals.

## 5.9. Conducted Band Edge Measurement

### 5.9.1. Test Specification

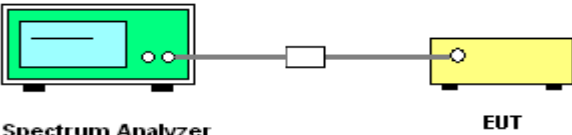
<b>Test Requirement:</b>	FCC Part15 C Section 15.247 (d)
<b>Test Method:</b>	KDB 558074 D01 v05r02
<b>Limit:</b>	In any 100 kHz bandwidth outside the intentional radiation frequency band, the radio frequency power shall be at least 20 dB below the highest level of the radiated power. In addition, radiated emissions which fall in the restricted bands must also comply with the radiated emission limits.
<b>Test Setup:</b>	 <p style="text-align: center;">Spectrum Analyzer                      EUT</p>
<b>Test Mode:</b>	Transmitting mode with modulation
<b>Test Procedure:</b>	<ol style="list-style-type: none"> <li>1. Set to the maximum power setting and enable the EUT transmit continuously.</li> <li>2. Set RBW = 100 kHz (<math>\geq 1\%</math> span=10MHz), VBW = 300 kHz (<math>\geq</math>RBW). Band edge emissions must be at least 20 dB down from the highest emission level within the authorized band as measured with a 100kHz RBW. The attenuation shall be 30 dB instead of 20 dB when RMS conducted output power procedure is used.</li> <li>3. Enable hopping function of the EUT and then repeat step 2 and 3.</li> <li>4. Measure and record the results in the test report.</li> </ol>
<b>Test Result:</b>	PASS

### 5.9.2. Test Instruments

Name	Manufacturer	Model No.	Serial Number	Calibration Due
Spectrum Analyzer	Agilent	N9020A	MY49100619	Jun. 28, 2024
Combiner Box	Ascentest	AT890-RFB	/	/

## 5.10. Conducted Spurious Emission Measurement

### 5.10.1. Test Specification

<b>Test Requirement:</b>	FCC Part15 C Section 15.247 (d)
<b>Test Method:</b>	KDB 558074 D01 v05r02
<b>Limit:</b>	In any 100 kHz bandwidth outside the intentional radiation frequency band, the radio frequency power shall be at least 20 dB below the highest level of the radiated power. In addition, radiated emissions which fall in the restricted bands must also comply with the radiated emission limits.
<b>Test Setup:</b>	 <p style="text-align: center;">Spectrum Analyzer                      EUT</p>
<b>Test Mode:</b>	Transmitting mode with modulation
<b>Test Procedure:</b>	<ol style="list-style-type: none"> <li>1. The RF output of EUT was connected to the spectrum analyzer by RF cable and attenuator. The path loss was compensated to the results for each measurement.</li> <li>2. Set to the maximum power setting and enable the EUT transmit continuously.</li> <li>3. Set RBW = 100 kHz, VBW = 300kHz, scan up through 10th harmonic. All harmonics / spurs must be at least 20 dB down from the highest emission level within the authorized band as measured with a 100 kHz RBW.</li> <li>4. Measure and record the results in the test report.</li> <li>5. The RF fundamental frequency should be excluded against the limit line in the operating frequency band.</li> </ol>
<b>Test Result:</b>	PASS

### 5.10.2. Test Instruments

Name	Manufacturer	Model No.	Serial Number	Calibration Due
Spectrum Analyzer	Agilent	N9020A	MY49100619	Jun. 28, 2024
Combiner Box	Ascentest	AT890-RFB	/	/

## 5.11. Radiated Spurious Emission Measurement

### 5.11.1. Test Specification

<b>Test Requirement:</b>	FCC Part15 C Section 15.209					
<b>Test Method:</b>	ANSI C63.10:2013					
<b>Frequency Range:</b>	9 kHz to 25 GHz					
<b>Measurement Distance:</b>	3 m					
<b>Antenna Polarization:</b>	Horizontal & Vertical					
<b>Receiver Setup:</b>	Frequency	Detector	RBW	VBW	Remark	
	9kHz- 150kHz	Quasi-peak	200Hz	1kHz	Quasi-peak Value	
	150kHz- 30MHz	Quasi-peak	9kHz	30kHz	Quasi-peak Value	
	30MHz-1GHz	Quasi-peak	120KHz	300KHz	Quasi-peak Value	
	Above 1GHz	Peak	1MHz	3MHz	Peak Value	
		Peak	1MHz	10Hz	Average Value	
<b>Limit:</b>	Frequency	Field Strength (microvolts/meter)	Measurement Distance (meters)			
	0.009-0.490	2400/F(KHz)	300			
	0.490-1.705	24000/F(KHz)	30			
	1.705-30	30	30			
	30-88	100	3			
	88-216	150	3			
	216-960	200	3			
	Above 960	500	3			
	Frequency	Field Strength (microvolts/meter)	Measurement Distance (meters)	Detector		
	Above 1GHz	500	3	Average		
	5000	3	Peak			
<b>Test setup:</b>	For radiated emissions below 30MHz					
	<p>Distance = 3m</p> <p>0.8m</p> <p>Turn table</p> <p>1m</p> <p>Ground Plane</p> <p>Computer</p> <p>Pre-Amplifier</p> <p>Receiver</p>					
	30MHz to 1GHz					

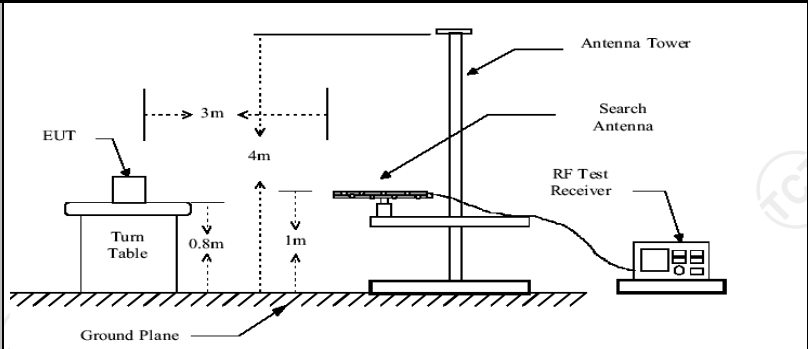

Above 1GHz

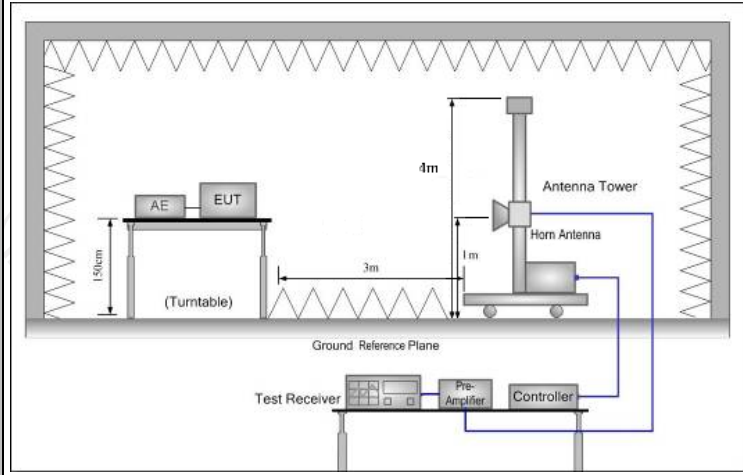

**Test Mode:**

Transmitting mode with modulation

**Test Procedure:**

1. The testing follows the guidelines in Spurious Radiated Emissions of ANSI C63.10:2013 Measurement Guidelines.
2. For the radiated emission test below 1GHz:  
The EUT was placed on a turntable with 0.8 meter above ground. The EUT was set 3 meters from the interference receiving antenna, which was mounted on the top of a variable height antenna tower. The EUT was arranged to its worst case and then tune the antenna tower (from 1 m to 4 m) and turntable (from 0 degree to 360 degrees) to find the maximum reading. A pre-amp and a high PASS filter are used for the test in order to get better signal level.
- For the radiated emission test above 1GHz:  
Place the measurement antenna on a turntable with 1.5 meter above ground, which is away from each area of the EUT determined to be a source of emissions at the specified measurement distance, while keeping the measurement antenna aimed at the source of emissions at each frequency of significant emissions, with polarization oriented for maximum response. The measurement antenna may have to be higher or lower than the EUT, depending on the radiation pattern of the emission

	<p>and staying aimed at the emission source for receiving the maximum signal. The final measurement antenna elevation shall be that which maximizes the emissions. The measurement antenna elevation for maximum emissions shall be restricted to a range of heights of from 1 m to 4 m above the ground or reference ground plane.</p> <p>3. Set to the maximum power setting and enable the EUT transmit continuously.</p> <p>4. Use the following spectrum analyzer settings:</p> <p>(1) Span shall wide enough to fully capture the emission being measured;</p> <p>(2) Set RBW=120 kHz for <math>f &lt; 1</math> GHz, RBW=1MHz for <math>f &gt; 1</math>GHz ; VBW<math>\geq</math>RBW; Sweep = auto; Detector function = peak; Trace = max hold for peak</p> <p>(3) For average measurement: use duty cycle correction factor method per 15.35(c). Duty cycle = On time/100 milliseconds On time = <math>N_1 * L_1 + N_2 * L_2 + \dots + N_{n-1} * L_{n-1} + N_n * L_n</math> Where <math>N_1</math> is number of type 1 pulses, <math>L_1</math> is length of type 1 pulses, etc. Average Emission Level = Peak Emission Level + <math>20 * \log(\text{Duty cycle})</math> Corrected Reading: Antenna Factor + Cable Loss + Read Level - Preamp Factor = Level</p>
<b>Test results:</b>	PASS

**5.11.2. Test Instruments**

Radiated Emission Test Site (966)				
Name of Equipment	Manufacturer	Model	Serial Number	Calibration Due
EMI Test Receiver	R&S	ESIB7	100197	Jun. 29, 2024
Spectrum Analyzer	R&S	FSQ40	200061	Jun. 29, 2024
Pre-amplifier	SKET	LNPA_0118G-45	SK2021012102	Feb. 20, 2024
Pre-amplifier	SKET	LNPA_1840G-50	SK202109203500	Feb. 20, 2024
Pre-amplifier	HP	8447D	2727A05017	Jun. 27, 2024
Loop antenna	Schwarzbeck	FMZB1519B	00191	Jul. 02, 2024
Broadband Antenna	Schwarzbeck	VULB9163	340	Jul. 01, 2024
Horn Antenna	Schwarzbeck	BBHA 9120D	631	Jul. 01, 2024
Horn Antenna	Schwarzbeck	BBHA 9170	00956	Feb. 24, 2024
Antenna Mast	Keleto	RE-AM	/	/
Coaxial cable	SKET	RC-18G-N-M	/	Feb. 24, 2024
Coaxial cable	SKET	RC_40G-K-M	/	Feb. 24, 2024
EMI Test Software	Shurple Technology	EZ-EMC	/	/



**5.11.3. Test Data**

Please refer to following diagram for individual

**Below 1GHz**

Horizontal:

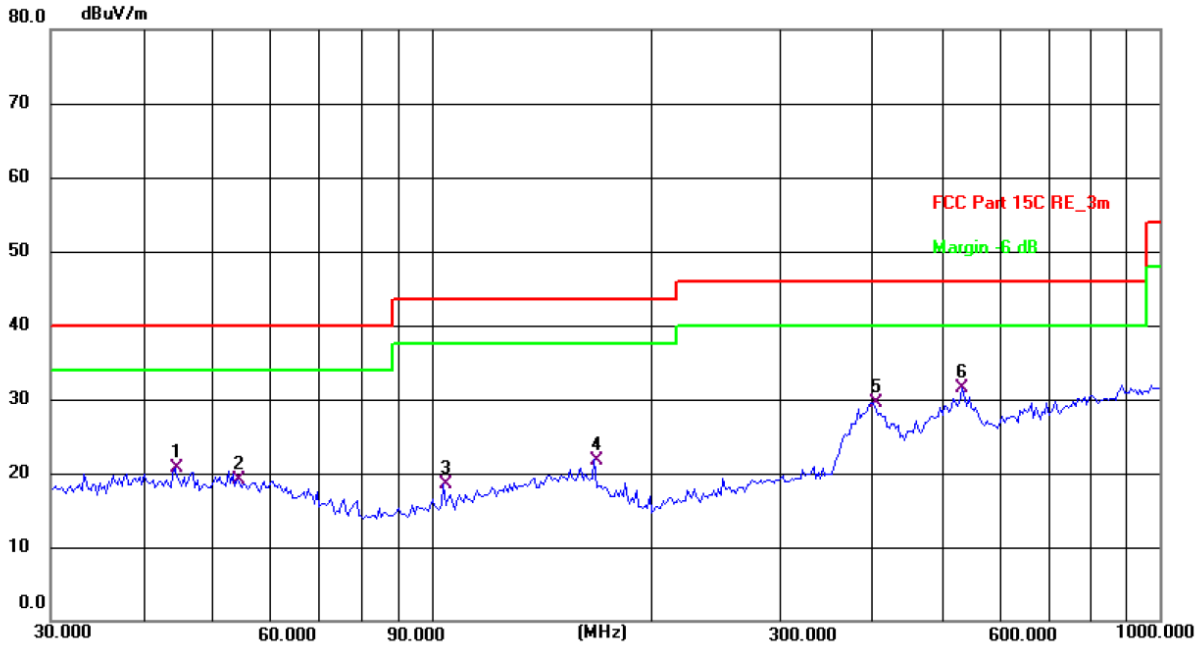

Site: #1 3m Anechoic Chamber      Polarization: **Horizontal**      Temperature: 24.9(C)      Humidity: 51 %

Limit: FCC Part 15C RE\_3m      Power: DC 3.7 V

No.	Frequency (MHz)	Reading (dBuV)	Factor (dB/m)	Level (dBuV/m)	Limit (dBuV/m)	Margin (dB)	Detector	P/F	Remark
1	44.4308	6.82	13.80	20.62	40.00	-19.38	QP	P	
2	54.0711	5.82	13.27	19.09	40.00	-20.91	QP	P	
3	103.8055	7.59	10.84	18.43	43.50	-25.07	QP	P	
4	167.2368	7.85	13.95	21.80	43.50	-21.70	QP	P	
5	404.6665	13.09	16.45	29.54	46.00	-16.46	QP	P	
6 *	535.7073	12.54	19.05	31.59	46.00	-14.41	QP	P	

Vertical:

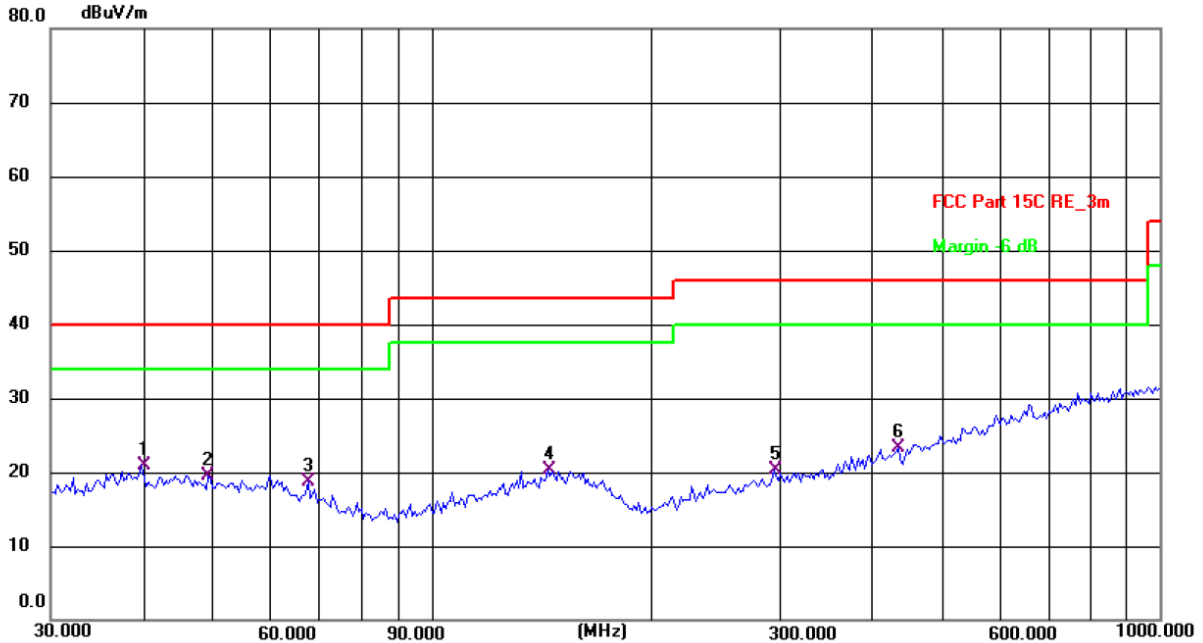

Site: #1 3m Anechoic Chamber      Polarization: **Vertical**      Temperature: 24.9(C)      Humidity: 51 %

Limit: FCC Part 15C RE\_3m      Power: DC 3.7 V

No.	Frequency (MHz)	Reading (dBuV)	Factor (dB/m)	Level (dBuV/m)	Limit (dBuV/m)	Margin (dB)	Detector	P/F	Remark
1 *	39.9942	6.66	14.23	20.89	40.00	-19.11	QP	P	
2	49.3594	5.89	13.66	19.55	40.00	-20.45	QP	P	
3	67.6751	7.45	11.33	18.78	40.00	-21.22	QP	P	
4	144.3348	6.15	14.08	20.23	43.50	-23.27	QP	P	
5	295.1469	6.56	13.81	20.37	46.00	-25.63	QP	P	
6	437.1199	6.37	16.97	23.34	46.00	-22.66	QP	P	

**Note:** 1. The low frequency, which started from 9KHz~30MHz, was pre-scanned and the result which was 20dB lower than the limit line per 15.31(o) was not reported.

2. Measurements were conducted in all three channels (high, middle, low) and three modulation (GFSK, Pi/4 DQPSK, 8DPSK) and the worst case Mode (Lowest channel and 8DPSK) was submitted only.

3. Freq. = Emission frequency in MHz

Measurement (dBuV/m) = Reading level (dBuV) + Corr. Factor (dB)

Correction Factor = Antenna Factor + Cable loss - Pre-amplifier

Limit (dBuV/m) = Limit stated in standard

Over (dB) = Measurement (dBuV/m) - Limits (dBuV/m)

\* is meaning the worst frequency has been tested in the test frequency range.

**Test Result of Radiated Spurious at Band edges**

Lowest channel 2402:

Horizontal:

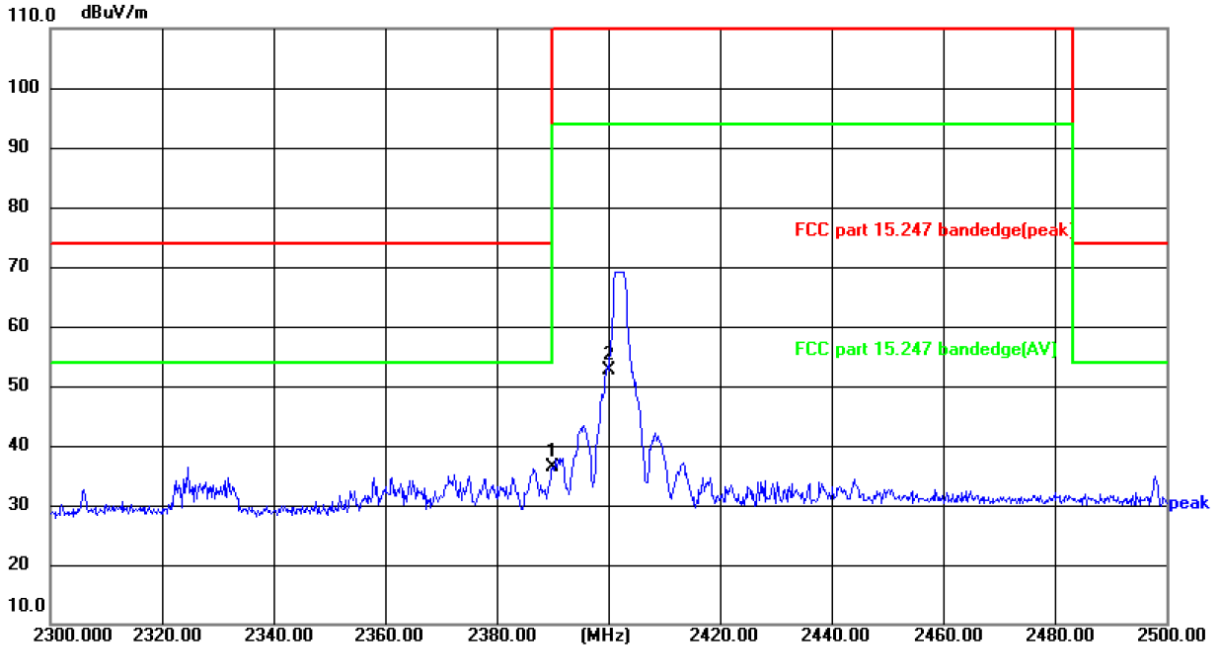

Site: #3 3m Anechoic Chamber      Polarization: **Horizontal**      Temperature: 25.2(°C)      Humidity: 43 %

Limit: FCC part 15.247 bandedge(peak)      Power:DC 3.7 V

No.	Frequency (MHz)	Reading (dBuV)	Factor (dB/m)	Level (dBuV/m)	Limit (dBuV/m)	Margin (dB)	Detector	P/F	Remark
1 *	2390.000	53.39	-17.10	36.29	74.00	-37.71	peak	P	
2	2400.000	69.79	-17.08	52.71	114.00	-61.29	peak	P	

Vertical:

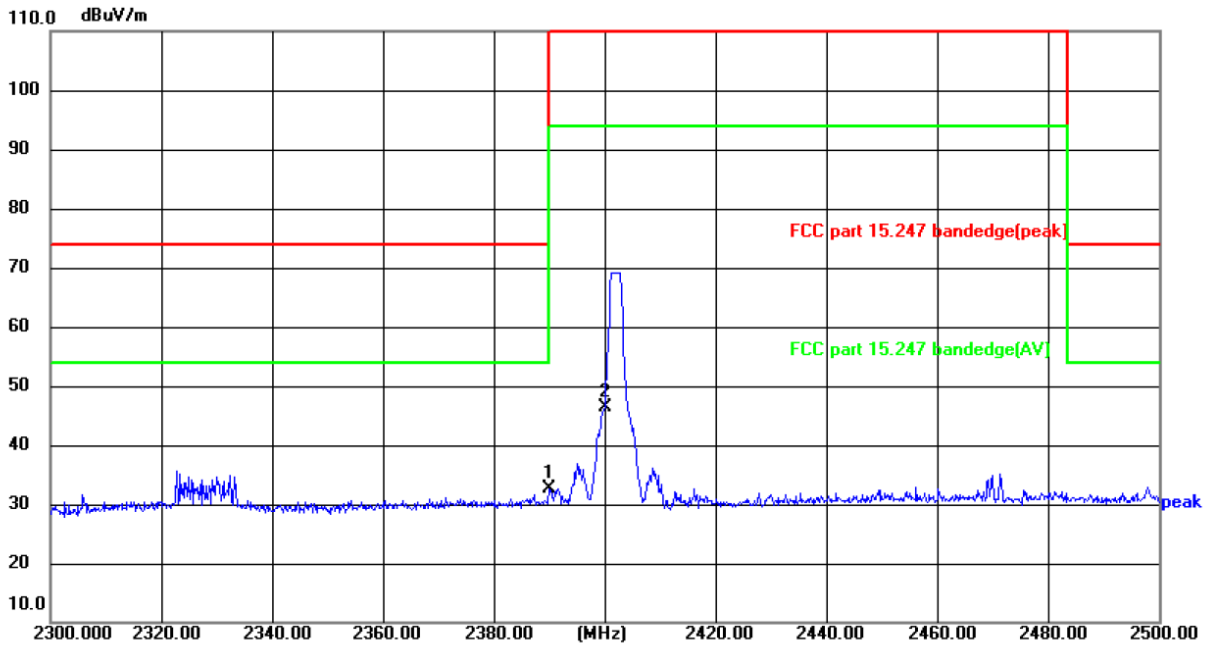

Site: #3 3m Anechoic Chamber      Polarization: **Vertical**      Temperature: 25.2(°C)      Humidity: 43 %

Limit: FCC part 15.247 bandedge(peak)      Power:DC 3.7 V

No.	Frequency (MHz)	Reading (dBuV)	Factor (dB/m)	Level (dBuV/m)	Limit (dBuV/m)	Margin (dB)	Detector	P/F	Remark
1 *	2390.000	49.69	-17.10	32.59	74.00	-41.41	peak	P	
2	2400.000	63.43	-17.08	46.35	114.00	-67.65	peak	P	



Highest channel 2480:

Horizontal:

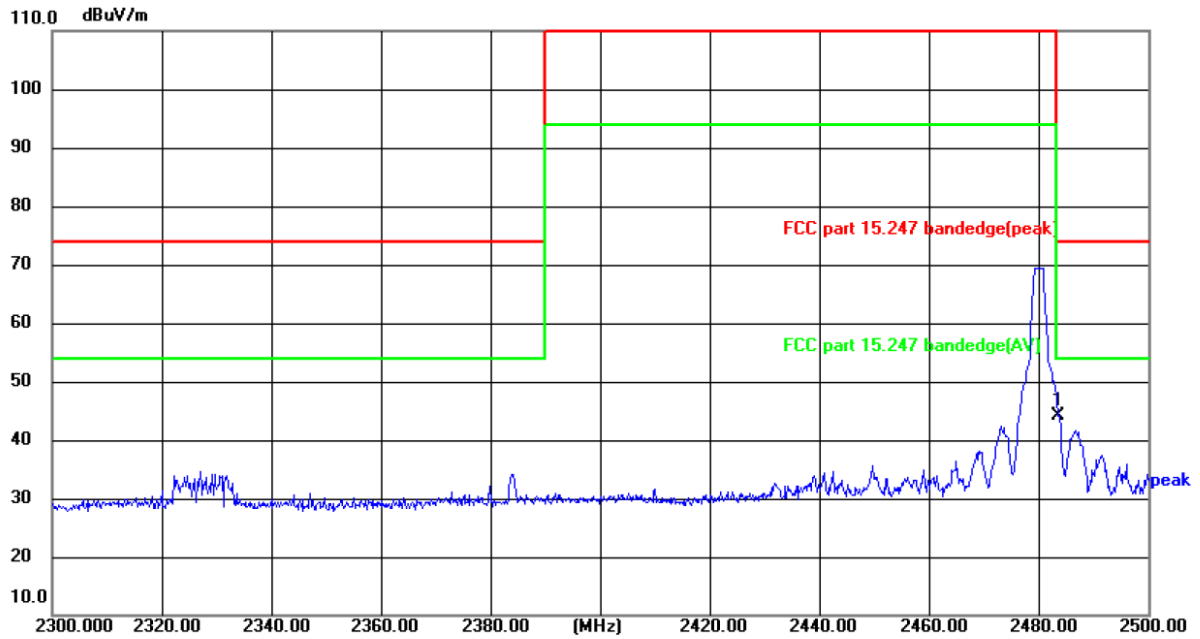

Site: #3 3m Anechoic Chamber      Polarization: **Horizontal**      Temperature: 25.2(°C)      Humidity: 43 %

Limit: FCC part 15.247 bandedge(peak)      Power:DC 3.7 V

No.	Frequency (MHz)	Reading (dBuV)	Factor (dB/m)	Level (dBuV/m)	Limit (dBuV/m)	Margin (dB)	Detector	P/F	Remark
1 *	2483.500	61.10	-16.88	44.22	74.00	-29.78	peak	P	



Vertical:

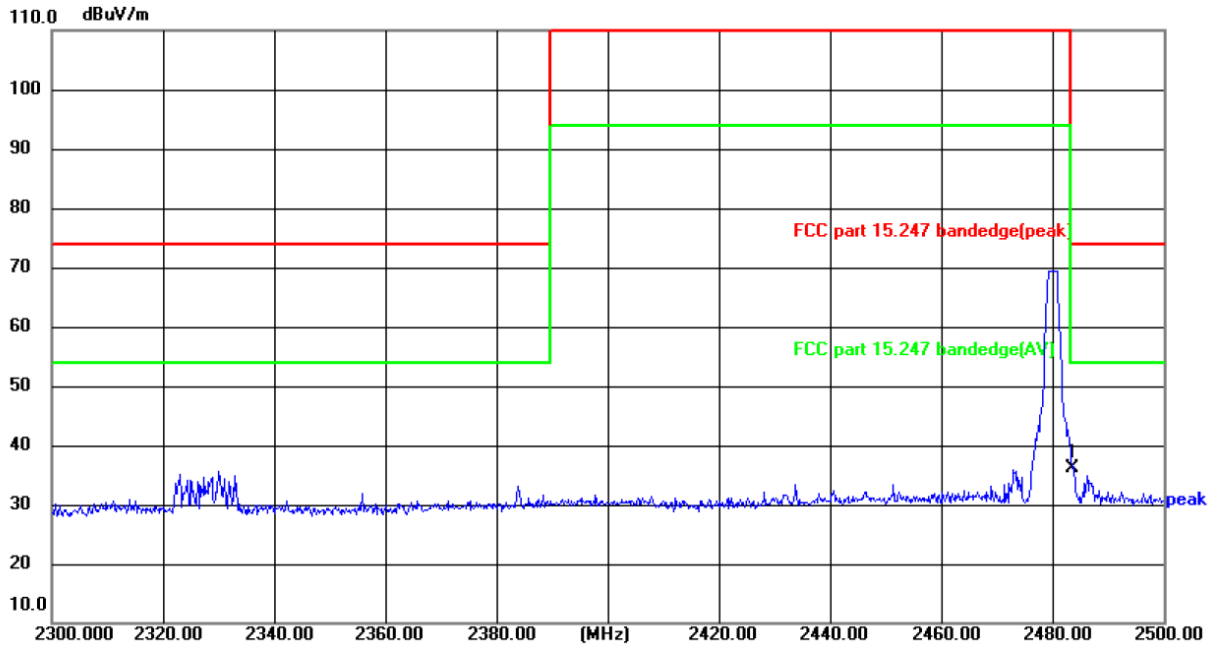

Site: #3 3m Anechoic Chamber      Polarization: **Vertical**      Temperature: 25.2(°C)      Humidity: 43 %

Limit: FCC part 15.247 bandedge(peak)      Power:DC 3.7 V

No.	Frequency (MHz)	Reading (dBuV)	Factor (dB/m)	Level (dBuV/m)	Limit (dBuV/m)	Margin (dB)	Detector	P/F	Remark
1 *	2483.500	53.06	-16.88	36.18	74.00	-37.82	peak	P	

**Note:** Measurements were conducted in all three modulation (GFSK, Pi/4 DQPSK, 8DPSK), and the worst case Mode (8DPSK) was submitted only.



**Above 1GHz**

Modulation Type: 8DPSK									
Low channel: 2402 MHz									
Frequency (MHz)	Ant. Pol. H/V	Peak reading (dB $\mu$ V)	AV reading (dB $\mu$ V)	Correction Factor (dB/m)	Emission Level		Peak limit (dB $\mu$ V/m)	AV limit (dB $\mu$ V/m)	Margin (dB)
					Peak (dB $\mu$ V/m)	AV (dB $\mu$ V/m)			
4804	H	46.35	---	0.66	47.01	---	74	54	-6.99
7206	H	35.70	---	9.50	45.20	---	74	54	-8.80
---	H	---	---	---	---	---	---	---	---
4804	V	45.94	---	0.66	46.60	---	74	54	-7.40
7206	V	35.18	---	9.50	44.68	---	74	54	-9.32
---	V	---	---	---	---	---	---	---	---

Middle channel: 2441 MHz									
Frequency (MHz)	Ant. Pol. H/V	Peak reading (dB $\mu$ V)	AV reading (dB $\mu$ V)	Correction Factor (dB/m)	Emission Level		Peak limit (dB $\mu$ V/m)	AV limit (dB $\mu$ V/m)	Margin (dB)
					Peak (dB $\mu$ V/m)	AV (dB $\mu$ V/m)			
4882	H	44.53	---	0.99	45.52	---	74	54	-8.48
7323	H	34.86	---	9.87	44.73	---	74	54	-9.27
---	H	---	---	---	---	---	---	---	---
4882	V	45.61	---	0.99	46.60	---	74	54	-7.40
7323	V	36.29	---	9.87	46.16	---	74	54	-7.84
---	V	---	---	---	---	---	---	---	---

High channel: 2480 MHz									
Frequency (MHz)	Ant. Pol. H/V	Peak reading (dB $\mu$ V)	AV reading (dB $\mu$ V)	Correction Factor (dB/m)	Emission Level		Peak limit (dB $\mu$ V/m)	AV limit (dB $\mu$ V/m)	Margin (dB)
					Peak (dB $\mu$ V/m)	AV (dB $\mu$ V/m)			
4960	H	44.02	---	1.33	45.35	---	74	54	-8.65
7440	H	35.47	---	10.22	45.69	---	74	54	-8.31
---	H	---	---	---	---	---	---	---	---
4960	V	45.15	---	1.33	46.48	---	74	54	-7.52
7440	V	36.78	---	10.22	47.00	---	74	54	-7.00
---	V	---	---	---	---	---	---	---	---

**Note:**

1. Emission Level=Peak Reading + Correction Factor; Correction Factor= Antenna Factor + Cable loss – Pre-amplifier
2. Margin (dB) = Emission Level (Peak) (dB $\mu$ V/m)-Average limit (dB $\mu$ V/m)
3. The emission levels of other frequencies are very lower than the limit and not show in test report.
4. Measurements were conducted from 1 GHz to the 10th harmonic of highest fundamental frequency.
5. Data of measurement shown "—" in the above table mean that the reading of emissions is attenuated more than 20 dB below the limits or the field strength is too small to be measured.
6. Measurements were conducted in all three modulation (GFSK, Pi/4 DQPSK, 8DPSK), and the worst case Mode (8DPSK) was submitted only.
7. All the restriction bands are compliance with the limit of 15.209.

**Appendix A: Test Result of Conducted Test****Maximum Conducted Output Power**

Condition	Mode	Frequency (MHz)	Conducted Power (dBm)	Limit (dBm)	Verdict
NVNT	1-DH1	2402	1.03	30	Pass
NVNT	1-DH1	2441	0.93	30	Pass
NVNT	1-DH1	2480	0.91	30	Pass
NVNT	2-DH1	2402	1.78	21	Pass
NVNT	2-DH1	2441	1.70	21	Pass
NVNT	2-DH1	2480	1.71	21	Pass
NVNT	3-DH1	2402	2.30	21	Pass
NVNT	3-DH1	2441	2.25	21	Pass
NVNT	3-DH1	2480	2.24	21	Pass



