

Find more about Declaration of Conformity, please click the below link to download: [Http://files.iclever.com/BTH13-DOC-EN.pdf](http://files.iclever.com/BTH13-DOC-EN.pdf)

Um mehr über die Konformitätserklärung zu erfahren, klicken Sie bitte auf den folgenden Link: [Http://files.iclever.com/BTH13-DOC-DE.pdf](http://files.iclever.com/BTH13-DOC-DE.pdf)



Wireless Headphones

Model: BTH13



User Manual

Contents

English User Manual	01
Benutzerhandbuch	10
Guide Utilisateur	17
Manual de Usuario	24
Manuale Utente	31
取扱説明書	38

Package Contents



1 x iClever BTH13
Wireless Headphones



1 x 3.5mm Audio Cable



1 x User Manual



1 x USB Type-C Cable

Product Diagram

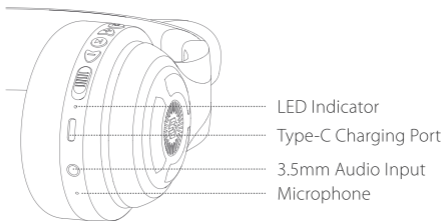
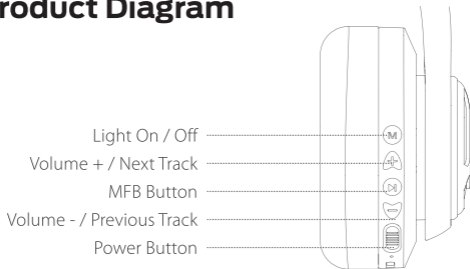

On / Off

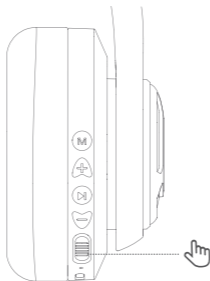

1. Power on: Switch the button to the "ON" direction. Then the LED indicator flashes blue for 1 second, and the colorful lights are on.
2. Shutdown: Switch the button to "OFF" direction, and the head-
phone is turned off. The LED indicator flashes blue for 1 second
and then goes off.

Bluetooth Pairing

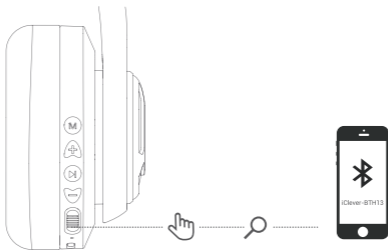

1. In the power-on state, switch the button to the "ON" direction; the colorful lights are on; Bluetooth enters the pairing state, and the red and blue lights flash alternately.
2. Turn on the Bluetooth of the mobile phone. Then find and select the "iClever-BTH13" Bluetooth pairing name in the device list for Bluetooth pairing connection.

Light On / Off

Short press the "Light On / Off" button to turn on / off the light.

Volume Limit Gear Switching

1. Press and hold the "+" & "-" buttons at the same time to switch the volume limit to 74dB, and the voice broadcast to "74dB".
2. Press and hold the "+" & "-" buttons at the same time to switch the volume limit to 85dB, and the voice broadcast to "85dB".
3. Press and hold the "+" & "-" buttons at the same time to switch the volume limit to 94dB, and the voice broadcast to "94dB".

Operation of Buttons

Volume Up	Short press the "+" button.
Volume Down	Short press the "-" button.

Next Track	Press and hold the "+" button for 2 seconds.
Previous Track	Press and hold the "-" button for 2 seconds.
Play / Pause	Press the MFB button once.
Answer / End A Call	Press the MFB button once.
Reject A Call	Keep pressing the MFB button for seconds.
Activate Siri	Press the MFB button twice.
Clear The Pairing List	Press and hold the "+" button and "-" button simultaneously for 4 seconds in the power-on state to clear the pairing list. Then the headphone will automatically enter pairing state.

Voice Prompt

Power On	Power on
Power Off	Power off
Pairing	Pairing
Successful Pairing	Connected
Disconnection	Disconnected
Low Power	Battery Low

How to Charge the Headphone

Connect the Type-C cable to the Type-C port on the headphone, and a 5V power outlet (power adapter is not included). The indicator light will glow red to indicate charging. When the headphone is fully charged, the indicator light will change from red to blue.

FCC Statement

Changes or modifications not expressly approved by the party responsible for compliance could void the user's authority to operate the equipment.

This equipment has been tested and found to comply with the limits for a Class B digital device, pursuant to Part 15 of the FCC Rules. These limits are designed to provide reasonable protection against harmful interference in a residential installation. This equipment generates uses and can radiate radio frequency energy and, if not installed and used in accordance with the instructions, may cause harmful interference to radio communications. However, there is no guarantee that interference will not occur in a particular installation. If this equipment does cause harmful interference to radio or television reception, which can be determined by turning the equipment off and on, the user is encouraged to try to correct the interference by one or more of the following measures:

- Reorient or relocate the receiving antenna.
- Increase the separation between the equipment and receiver.
- Connect the equipment into an outlet on a circuit different from that to which the receiver is connected.
- Consult the dealer or an experienced radio/TV technician for help.

This device complies with part 15 of the FCC rules. Operation is subject to the following two conditions

- (1) This device may not cause harmful interference.
- (2) This device must accept any interference received, including interference that may cause undesired operation.

Lieferumfang



1 x drahtloser Kopfhörer
iClever BTH13

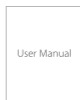

1 x Benutzerhandbuch



1 x 3,5-mm-Audiokabel



1 x USB-Kabel Typ C

Produkt Diagram

- Licht ein / aus
- Band + / Nächster Titel
- MFB-Taste
- Volume - / Vorheriger Track
- Ein / Aus-Taste

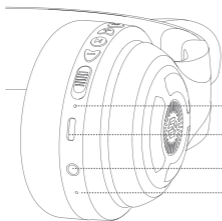

- LED-Anzeige
- Typ-C-Ladeanschluss
- 3,5-mm-Audioeingang
- Mikrofon

Ein / Aus



1. Einschalten: Schalten Sie die Taste in die Richtung "EIN". Dann blinkt die LED-Anzeige 1 Sekunde lang blau, und die bunten Lichter sind eingeschaltet.
2. Ausschalten: Schalten Sie die Taste in die Richtung "AUS", und der Kopfhörer ist ausgeschaltet. Die LED-Anzeige blinkt 1 Sekunde lang blau und erlischt dann.

Bluetooth Kopplung

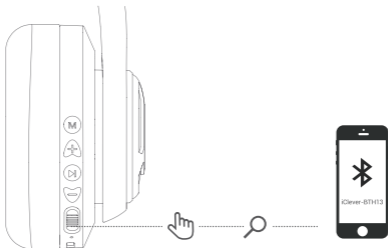

1. Schalten Sie die Taste im eingeschalteten Zustand in Richtung "ON"; die bunten Lichter sind eingeschaltet; Bluetooth geht in den Kopplungszustand über, und die roten und blauen Lichter blinken abwechselnd.
2. Schalten Sie das Bluetooth des Mobiltelefons ein. Suchen Sie dann den Bluetooth-Kopplungsnamen "iClever-BTH13" in der Geräteliste für die Bluetooth-Kopplungsverbindung und wählen Sie ihn aus.

Licht On / Off

Drücken Sie kurz auf die Taste "Light On/Off", um das Licht ein-/auszuschalten.

Volume Limit Gear Switching

1. Halten Sie die Tasten "+" & "-" gleichzeitig gedrückt, um die Lautstärkebegrenzung auf 74dB und die Sprachübertragung auf "74dB" umzuschalten.
2. Halten Sie die Tasten "+" und "-" gleichzeitig gedrückt, um die Lautstärkebegrenzung auf 85 dB und die Sprachübertragung auf "85 dB" umzuschalten.
3. Halten Sie die Tasten "+" und "-" gleichzeitig gedrückt, um die Lautstärkebegrenzung auf 94dB und die Sprachübertragung auf "94dB" umzuschalten.

Bedienung der Schaltflächen

Volumen nach oben	Drücken Sie kurz auf die Taste "+".
Weniger Volumen	Drücken Sie kurz auf die Taste "-".

Nächster Track	Drücken und halten Sie die "+"-Taste 2 Sekunden lang.
Vorheriger Track	Drücken und halten Sie die Taste "-" 2 Sekunden lang gedrückt.
Abspielen / Pause	Drücken Sie die MFB-Taste einmal.
Einen Anruf annehmen / beenden	Drücken Sie die MFB-Taste einmal.
Einen Anruf ablehnen	Halten Sie die MFB-Taste 2 Sekunden lang gedrückt.
Siri aktivieren	Drücken Sie die MFB-Taste zweimal.
Die Kopplungsliste löschen	Halten Sie im eingeschalteten Zustand die "+"-Taste und die "-"-Taste gleichzeitig 4 Sekunden lang gedrückt, um die Paarungsliste zu löschen. Danach geht der Kopfhörer automatisch in den Kopplungszustand über.

Sprachaufforderung

Einschalten	Einschalten
Ausschalten	Ausschalten
Paarung	Paarung
Erfolgreiches Pairing	Verbunden
Trennung der Verbindung	Getrennt
Niedrige Leistung	Batterie schwach

Wie man den Kopfhörer auflädt

Schließen Sie das Typ-C-Kabel an den Typ-C-Anschluss des Kopfhörers und eine 5-V-Steckdose an (Netzadapter ist nicht im Lieferumfang enthalten). Die Anzeigeleuchte leuchtet rot, um den Ladevorgang anzuzeigen. Wenn der Kopfhörer vollständig aufgeladen ist, wechselt die Anzeigeleuchte von rot zu blau.

Contenu du paquet



1 x Écouteurs sans fil
iClever BTH13



1 x Manuel d'utilisation



1 x Câble audio de 3,5 mm



1 x Câble USB de type C

Diagramme du produit

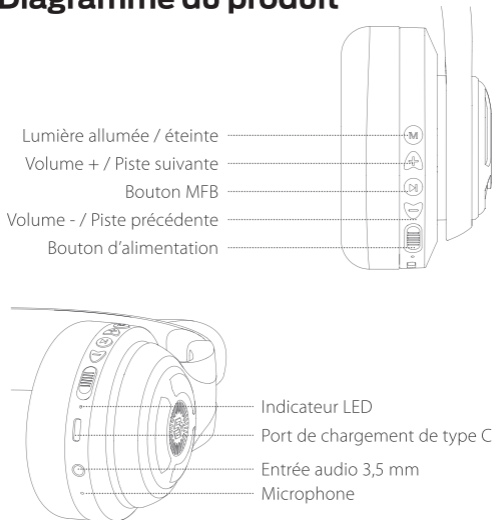

On / Off

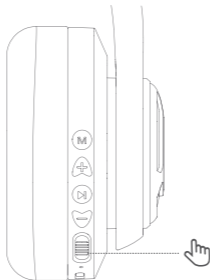

1. Mise en marche : Mettez le bouton dans le sens "ON". Ensuite, le voyant LED clignote en bleu pendant 1 seconde, et les lumières colorées s'allument.
2. Arrêt : Mettez le bouton dans le sens "OFF", et les écouteurs sont éteints. L'indicateur LED clignote en bleu pendant 1 seconde puis s'éteint.

Couplage Bluetooth

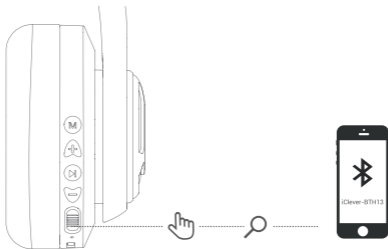

1. En état de marche, mettez le bouton dans le sens "ON"; les lumières colorées sont allumées; le Bluetooth entre en état de couplage, et les lumières rouge et bleue clignotent alternativement.
2. Allumez le Bluetooth du téléphone portable. Ensuite, trouvez et sélectionnez le nom de couplage Bluetooth "iClever-BTH13" dans la liste des appareils pour la connexion Bluetooth.

Lumière Allumée / Eteinte

Appuyez brièvement sur le bouton "Light On/Off" pour allumer/éteindre la lumière.

Changement de limite du volume

1. Appuyez brièvement et maintenez les boutons "+" et "-" enfoncés en même temps pour passer la limite de volume à 74dB et la diffusion vocale à "74dB".
2. Appuyez brièvement et maintenez les boutons "+" et "-" enfoncés en même temps pour faire passer la limite de volume à 85dB, et la diffusion vocale à "85dB".
3. Appuyez brièvement et maintenez les boutons "+" et "-" enfoncés en même temps pour passer la limite de volume à 94dB, et la diffusion vocale à "94dB".

Fonctionnement des touches

Augmenter le volume	Appuyez brièvement sur le bouton "+".
Réduction du volume	Appuyez brièvement sur le bouton "-".

Prochain morceau	Appuyez sur la touche "+" et maintenez-la enfoncée pendant 2 secondes
Piste précédente	Appuyez sur le bouton "-" et maintenez-le enfoncé pendant 2 secondes
Reproduction / Pause	Appuyez une fois sur le bouton MFB
Répondre / Terminer l'appel	Appuyez une fois sur le bouton MFB
Rejeter l'appel	Maintenez le bouton MFB enfoncé pendant quelques secondes
Activer Siri	Appuyez deux fois sur le bouton MFB
Effacer la liste d'appariement	Appuyez simultanément sur le bouton "+" et le bouton "-" pendant 4 secondes lors de la mise sous tension pour effacer la liste d'appariement. Puis les écouteurs passeront automatiquement en mode appariement.

Commande vocale

Power On	Mise en marche
Power Off	Arrêt
Pairing	Couplage
Successful Pairing	Connection réussie
Disconnection	Déconnection
Low Power	Batterie faible

Comment charger les écouteurs

Connectez le câble de type C au port de type C du casque, et à une prise de courant de 5V (l'adaptateur électrique n'est pas inclus). Le voyant lumineux s'allumera en rouge pour indiquer la charge. Lorsque les écouteurs sont complètement chargés, le voyant lumineux passe du rouge au bleu.

Contenido del paquete



1 x Auriculares inalámbricos
iClever BTH13

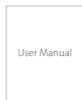

1 x Manual de usuario



1 x Cable de audio de 3,5 mm



1 x Cable USB tipo C

Diagrama del producto

- Encender / Apagar luces
- Volumen + / Pista siguiente
- Botón MFB (Multifunción)
- Volumen - / Pista anterior
- Botón de encendido

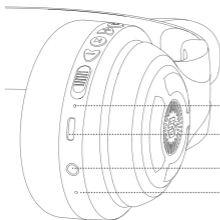

- Indicador LED
- Puerto de carga tipo C
- Entrada de audio de 3,5 mm
- Micrófono

Encendido / apagado

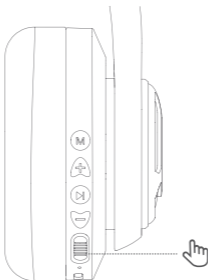

1. Encendido: Ponga el botón en posición "ON". Luego, el indicador LED parpadeará en azul durante 1 segundo y las luces de colores se encenderán.
2. Apagado: Cambie el botón a la posición "OFF" y los auriculares se apagarán. El indicador LED parpadeará en azul durante 1 segundo y luego se apagará.

Emparejamiento Bluetooth

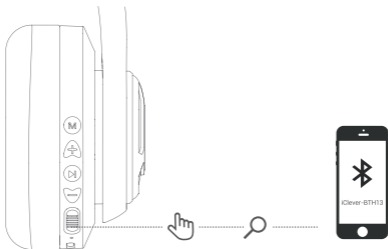

1. Con el auricular encendido, cambie el botón a la posición "ON". Las luces de colores se encenderán. El Bluetooth entra en el estado de emparejamiento y las luces roja y azul parpadean alternativamente.
2. Encienda el Bluetooth del teléfono móvil. Luego, busque y seleccione el nombre de emparejamiento de Bluetooth "iClever-BTH13" en la lista de dispositivos para la conexión Bluetooth.

Encender / Apagar luces

Presione brevemente el botón "Encender / apagar luces" para encender / apagar las luces.

Cambiar la limitación de volumen

1. Mantenga presionados los botones "+" y "-" al mismo tiempo para cambiar el límite de volumen a 74dB y la transmisión de voz a "74dB".
2. Mantenga presionados los botones "+" y "-" al mismo tiempo para cambiar el límite de volumen a 85dB y la transmisión de voz a "85dB".
3. Mantenga presionados los botones "+" y "-" al mismo tiempo para cambiar el límite de volumen a 94dB y la transmisión de voz a "94dB".

Uso de los botones

Subir volumen	Presione brevemente el botón "+".
Bajar volumen	Presione brevemente el botón "-".

Siguiente pista	Mantenga presionado el botón "+" durante 2 segundos.
Pista anterior	Mantenga presionado el botón "-" durante 2 segundos.
Play / Pausa	Presione el botón MFB una vez.
Responder / finalizar una llamada	Presione el botón MFB una vez.
Rechazar una llamada	Mantenga pulsado el botón MFB durante unos segundos
Activar Siri	Presione el botón MFB dos veces.
Borrar la lista de emparejamiento	Mantenga presionado el botón "+" y el botón "-" simultáneamente durante 4 segundos en el estado de encendido para borrar la lista de emparejamiento. Luego, los auriculares entrarán automáticamente en estado de emparejamiento.

Avisos de voz

Encendido	Encendido
Apagado	Apagado
Emparejar	Emparejar
Emparejamiento exitoso	Conectado
Desconexión	Desconectado
Baja potencia	Batería baja

Cómo cargar los auriculares

Conecte el cable tipo C al puerto de los auriculares y a una toma de corriente de 5 V (el adaptador de corriente no está incluido). La luz indicadora se iluminará en rojo para indicar que se está cargando. Cuando los auriculares estén completamente cargados, la luz indicadora cambiará de rojo a azul.

Contenuto della Confezione



1 x Cuffie Senza Fili
iClever BTH13

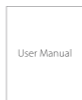

1 x Manuale Utente



1 x Cavo Audio da 3,5 mm



1 x Cavo USB di Tipo C

Diagramma del Prodotto

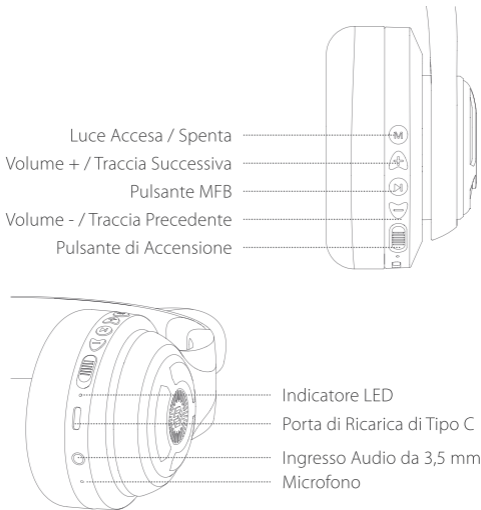

Acceso / Spento

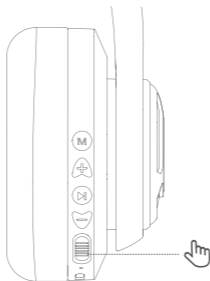

1. Accensione: Premere il pulsante su "ON". Quindi l'indicatore LED lampeggia in blu per 1 secondo e le luci colorate si illuminano.
2. Spegnimento: Premere il pulsante su "OFF" e le cuffie si spengono. L'indicatore LED lampeggia in blu per 1 secondo e poi si spegne.

Associazione Bluetooth

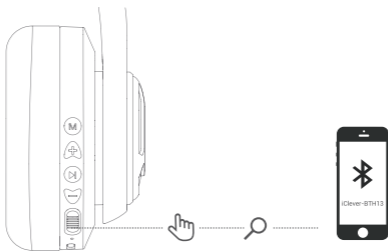

1. Quando è acceso, premere su "ON"; le luci colorate si accendono; Il Bluetooth entra nello stato di associazione e le luci rossa e blu lampeggiano in maniera alternata.
2. Attivare il Bluetooth del telefono cellulare. Quindi trova e seleziona il nome di associazione Bluetooth "iClever-BTH13" nell'elenco dei dispositivi per la connessione di associazione Bluetooth.

Luce accesa / spenta

Premere in maniera breve il pulsante "Luce On / Off" per accendere / spegnere la luce.

Cambio della Marcia con Limite di Volume

1. Tenere premuti in contemporanea i pulsanti "+" e "-" per impostare il limite del volume a 74dB e la trasmissione vocale a "74dB".
2. Tenere premuti in contemporanea i pulsanti "+" e "-" per impostare il limite del volume a 85 dB e la trasmissione vocale a "85 dB".
3. Tenere premuti in contemporanea i pulsanti "+" e "-" per impostare il limite del volume a 94dB e la trasmissione vocale a "94dB".

Operatività del Pulsante

Aumento del Volume	Premere brevemente il pulsante "+".
Abbassare il Volume	Premere brevemente il pulsante "-".

Prossima Traccia	Premere e tenere premuto il pulsante "+" per 2 secondi.
Traccia Precedente	Premere e tenere premuto il pulsante "-" per 2 secondi.
Avvio / Pausa	Premere una volta il pulsante MFB.
Rispondere/Chiudere la Chiamata	Premere una volta il pulsante MFB.
Rifiutare una Chiamata	Mantenere premuto il pulsante MFB per alcuni secondi.
Attivare Siri	Premere due volte il pulsante MFB.
Pulire la Lista di Associazione	Premere e tenere premuto il pulsante "+" e "-" in simultanea per 4 secondi nello stato di accensione per cancellare l'elenco di accoppiamento. Quindi le cuffie entreranno automaticamente nello stato di associazione.

Comandi Vocali

Accensione	Accensione
Spegnimento	Spegnimento
Associazione	Associazione
Associazione avvenuta con Successo	Connessione
Disconnessione	Disconnessione
Bassa Potenza	Bassa Potenza

Come Ricaricare le Cuffie

Collegare il cavo di tipo C alla porta di tipo C sulle cuffie e una presa di corrente da 5 V (l'alimentatore non è incluso). L'indicatore luminoso si illuminerà di rosso per indicare la carica. Quando le cuffie sono completamente cariche, l'indicatore luminoso cambierà da rosso a blu.

パッケージの内容



1 x iClever BTH13 ワイヤレスヘッドフォン

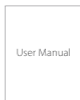

1 x ユーザーマニュアル



1 x 3.5 mm オーディオケーブル



1 x USB Type-C ケーブル

製品図

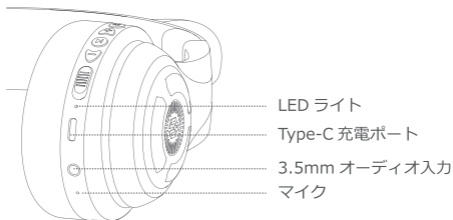
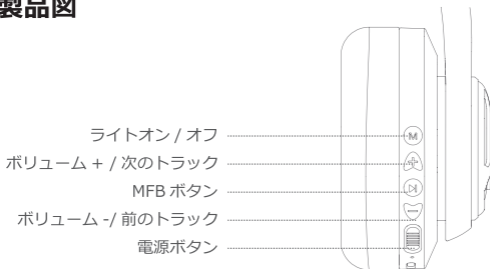

オンオフ

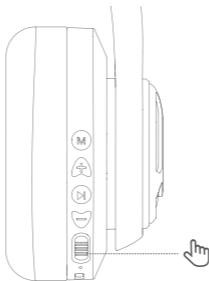

1. 電源オン：ボタンを「オン」に切り替えると、LED インジケータが 1 秒間青色に点滅し、カラフルなライトが点灯します。
2. シャットダウン：ボタンを「OFF」に切り替えると、LED インジケータが 1 秒間青色に点滅した後、消灯してヘッドホンの電源がオフになります。

Bluetooth ペアリング

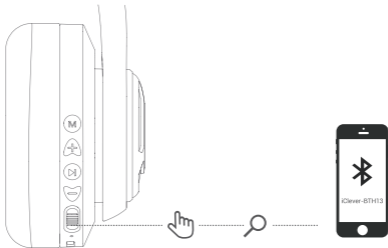

1. ボタンを「ON」に切り替えると、電源が入り、カラフルなライトが点灯します。そのまま Bluetooth がペアリングモードになると、赤と青のライトが交互に点滅します。
2. 接続先デバイスの Bluetooth をオンにします。Bluetooth 接続デバイスリストに表示される「iClever-BTH13」という商品名を選択します。

ライトのオン / オフ

「ライトオン / オフ」ボタンを短く押すと、ライトのオン / オフができます。

音量制限の切り替え

1. 「+」ボタンと「-」ボタンを同時に1~2秒程度押すと、「74dB」という音声流れ、音量制限が74dBに切り替わります。
2. 1の後に「+」ボタンと「-」ボタンを同時に1~2秒程度押すと、「85dB」という音声流れ、音量制限が85dBに切り替わります。
3. 2の後に「+」ボタンと「-」ボタンを同時に1~2秒程度押すと、「94dB」という音声流れ、音量制限が94dBに切り替わります。

ボタンの操作

音量を上げる	「+」ボタンを短く押します。
音量を下げる	「-」ボタンを短く押します。

次のトラック	「+」 ボタンを 2 秒間押し続けます。
前のトラック	「-」 ボタンを 2 秒間押し続けます。
再生 / 一時停止	MFB ボタンを 1 回押します。
通話に応答する / 通話を終了する	MFB ボタンを 1 回押します。
通話を拒否する	MFB ボタンを数秒間押し続けます。
Siri をアクティブにする	MFB ボタンを 2 回押します。
ペアリングリストのクリア	電源がオンの状態で「+」 ボタンと「-」 ボタンを同時に 4 秒間押し続けると、ペアリングリストがクリアされます。その後、ヘッドホンは自動的にペアリングモードになります。

音声プロンプト

パワーオン	Power on
パワーオフ	Power off
ペアリング	Pairing
サクセスフルペアリング	Connected
ディスコネクション	Disconnected
ロウパワー	Battery Low

ヘッドホンの充電方法

Type-C ケーブルをヘッドホンの Type-C ポートと 5V 電源コンセントに接続します（電源アダプターは含まれていません）。充電中インジケータライトが赤く点灯します。ヘッドホンが完全に充電されると、インジケータライトが赤から青に変わります。