



# FCC Part 15C Test Report

## FCC ID: 2ALKIMP45

Product Name:	MPOS
Trademark:	N/A
Model Name :	MP45
Prepared For :	<b>Wuhan Tianyu Information Industry Co., Ltd.</b>
Address :	HUST Industry Park, East-Lake Development Zone, Wuhan 430223, Hubei, China
Prepared By :	Shenzhen BCTC Technology Co., Ltd.
Address :	No.101, Yousong Road, Longhua New District, Shenzhen, China
Test Date:	Mar. 21 -Mar. 28, 2017
Date of Report :	Mar. 28, 2017
Report No.:	<b>BCTC-FY170301299-2E</b>



### TEST RESULT CERTIFICATION

**Applicant's name** ..... : **Wuhan Tianyu Information Industry Co., Ltd.**  
**Address** ..... : HUST Industry Park, East-Lake Development Zone, Wuhan  
430223, Hubei, China

**Manufacture's Name**..... : **Wuhan Tianyu Information Industry Co., Ltd.**  
**Address** ..... : HUST Industry Park, East-Lake Development Zone, Wuhan  
430223, Hubei, China

**Product description**

**Product name** ..... : MPOS

**Trademark** ..... : N/A

**Model and/or type reference** : MP45  
N/A

**Standards** ..... : FCC Part15.225  
ANSI C63.10-2013

This device described above has been tested by BCTC, and the test results show that the equipment under test (EUT) is in compliance with the FCC requirements. And it is applicable only to the tested sample identified in the report.

This report shall not be reproduced except in full, without the written approval of BCTC, this document may be altered or revised by BCTC, personal only, and shall be noted in the revision of the document.

Testing Engineer : Eric Yang  
Eric Yang

Reviewer Supervisor : Jade Yang  
Jade Yang

Approved & Authorized Manager: : Carson Zhang  
Carson Zhang

**Table of Contents**

	<b>Page</b>
<b>1 . SUMMARY OF TEST RESULTS</b>	<b>5</b>
1.1 TEST FACILITY	5
1.2 MEASUREMENT UNCERTAINTY	5
<b>2 . GENERAL INFORMATION</b>	<b>6</b>
2.1 GENERAL DESCRIPTION OF EUT	6
2.2 DESCRIPTION OF TEST MODES	7
2.3 BLOCK DIGRAM SHOWING THE CONFIGURATION OF SYSTEM TESTED	8
2.4 DESCRIPTION OF SUPPORT UNITS(CONDUCTED MODE)	8
2.5 EQUIPMENTS LIST FOR ALL TEST ITEMS	9
<b>3 . EMC EMISSION TEST</b>	<b>10</b>
3.1 CONDUCTED EMISSION MEASUREMENT	10
3.1.1 POWER LINE CONDUCTED EMISSION LIMITS	10
3.1.2 TEST PROCEDURE	10
3.1.3 DEVIATION FROM TEST STANDARD	10
3.1.4 TEST SETUP	11
3.1.5 EUT OPERATING CONDITIONS	11
3.1.6 TEST RESULTS	11
3.2 RADIATED EMISSION MEASUREMENT	14
3.2.1 RADIATED EMISSION LIMITS	14
3.2.2 TEST PROCEDURE	14
3.2.3 DEVIATION FROM TEST STANDARD	15
3.2.4 TEST SETUP	15
3.2.5 EUT OPERATING CONDITIONS	16
3.2.6 TEST RESULTS (BETWEEN 9KHZ – 30 MHZ)	17
3.2.7 TEST RESULTS (BETWEEN 30MHZ – 1GHZ)	18
3.3 RADIATED BAND EMISSION MEASUREMENT	20
3.3.1 TEST REQUIREMENT:	20
3.3.2 TEST PROCEDURE	20
3.3.3 DEVIATION FROM TEST STANDARD	20
3.3.4 TEST SETUP	21
3.3.5 EUT OPERATING CONDITIONS	21
<b>4 . BANDWIDTH TEST</b>	<b>23</b>
4.1 APPLIED PROCEDURES	23
4.1.1 TEST PROCEDURE	23



<b>Table of Contents</b>		<b>Page</b>
4.1.2 DEVIATION FROM STANDARD		23
4.1.3 TEST SETUP		23
4.1.4 EUT OPERATION CONDITIONS		23
4.1.5 TEST RESULTS		24
<b>5 . TRANSMITTER FREQUENCY STABILITY</b>		<b>25</b>
5.1 LIMITS		25
5.1.1 TEST PROCEDURE		25
5.1.2 DEVIATION FROM STANDARD		25
5.1.3 TEST SETUP		25
5.1.4 EUT OPERATION CONDITIONS		25
5.1.5 TEST RESULTS		26
<b>6 . ANTENNA REQUIREMENT</b>		<b>27</b>
6.1 STANDARD REQUIREMENT		27
6.2 EUT ANTENNA		27
<b>7 . TEST SEUUP PHOTO</b>		<b>28</b>
<b>8 . EUT PHOTO</b>		<b>30</b>



## 1. SUMMARY OF TEST RESULTS

Test procedures according to the technical standards:

FCC Part15 (15.225)			
Standard Section	Test Item	Judgment	Remark
15.207	Conducted Emission	PASS	
Part 15.209(a), 15.225(d)	Radiated Spurious Emission	PASS	
15.225	Bandwidth	PASS	
Part 15.209(a), 15.225(c)(d)	Band Edge Emission	PASS	
Part 15.225(e)	Transmitter Frequency Stability (Temperature & Voltage Variation)	PASS	
15.203	Antenna Requirement	PASS	

NOTE:

(1) "N/A" denotes test is not applicable in this Test Report

### 1.1 TEST FACILITY

Shenzhen BCTC Technology Co., Ltd.

Add. : No.101,Yousong Road,Longhua New District, Shenzhen,China

FCC Registered No.: 187086

### 1.2 MEASUREMENT UNCERTAINTY

The reported uncertainty of measurement  $y \pm U$ , where expanded uncertainty  $U$  is based on a standard uncertainty multiplied by a coverage factor of  $k=2$ , providing a level of confidence of approximately **95 %**.

No.	Item	Uncertainty
1	Conducted Emission Test	$\pm 1.38\text{dB}$
2	RF power,conducted	$\pm 0.16\text{dB}$
3	Spurious emissions,conducted	$\pm 0.21\text{dB}$
4	All emissions,radiated(<1G)	$\pm 4.68\text{dB}$
5	All emissions,radiated(>1G)	$\pm 4.89\text{dB}$
6	Temperature	$\pm 0.5^\circ\text{C}$
7	Humidity	$\pm 2\%$



## 2. GENERAL INFORMATION

### 2.1 GENERAL DESCRIPTION OF EUT

Equipment	MPOS										
Trade Name	N/A										
Model Name	MP45										
Model Difference	N/A										
Product Description	<p>The EUT is a MPOS</p> <table border="1"><tr><td>Operation Frequency:</td><td>13.56MHz</td></tr><tr><td>Modulation Type:</td><td>ASK</td></tr><tr><td>Number Of Channel</td><td>1 CH</td></tr><tr><td>Antenna type:</td><td>Loop antenna</td></tr><tr><td>Antenna Gain (dBi)</td><td>0dBi</td></tr></table> <p>Based on the application, features, or specification exhibited in User's Manual, the EUT is considered as an ITE/Computing Device. More details of EUT technical specification, please refer to the User's Manual.</p>	Operation Frequency:	13.56MHz	Modulation Type:	ASK	Number Of Channel	1 CH	Antenna type:	Loop antenna	Antenna Gain (dBi)	0dBi
Operation Frequency:	13.56MHz										
Modulation Type:	ASK										
Number Of Channel	1 CH										
Antenna type:	Loop antenna										
Antenna Gain (dBi)	0dBi										
Channel List	Please refer to the Note 2.										
Power	DC 3.7V										
Adapter	Model: A8A-501000 AC Power Input: 100-240V~ 50/60Hz 0.2A Output: 5V $\overline{\text{---}}$ 1000mA										
hardware version	--										
Software version	--										
Serial number	--										
Connecting I/O Port(s)	Please refer to the User's Manual										

Note:

1. For a more detailed features description, please refer to the manufacturer's specifications or the User's Manual.



## 2.2 DESCRIPTION OF TEST MODES

To investigate the maximum EMI emission characteristics generated from EUT, the test system was pre-scanning tested based on the consideration of following EUT operation mode or test configuration mode which possibly have effect on EMI emission level. Each of these EUT operation mode(s) or test configuration mode(s) mentioned above was evaluated respectively.

Pretest Mode	Description
Mode 1	TX Mode
<b>For Conducted &amp; Radiated Emission</b>	
Final Test Mode	Description
Mode 1	TX Mode

Note:

(1) The measurements are performed at the highest, middle, lowest available channels.



### 2.3 BLOCK DIGRAM SHOWING THE CONFIGURATION OF SYSTEM TESTED

Conducted Spurious Emission Test

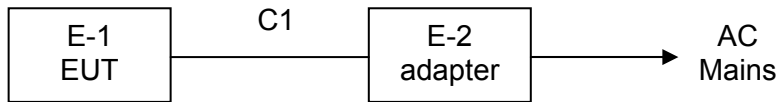

Radiated Spurious Emission Test

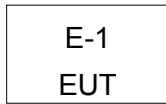

### 2.4 DESCRIPTION OF SUPPORT UNITS(CONDUCTED MODE)

The EUT has been tested as an independent unit together with other necessary accessories or support units. The following support units or accessories were used to form a representative test configuration during the tests.

Item	Equipment	Mfr/Brand	Model/Type No.	Series No.	Note
E-1	MPOS	N/A	MP45	N/A	EUT
E-2	Adapter	N/A	A8A-501000	N/A	

Item	Shielded Type	Ferrite Core	Length	Note
C1	No	No	0.8m	

Note:

- (1) For detachable type I/O cable should be specified the length in cm in 『Length』 column.





## 2.5 EQUIPMENTS LIST FOR ALL TEST ITEMS

### Radiation Test equipment

Item	Kind of Equipment	Manufacturer	Type No.	Serial No.	Last calibration	Calibrated until
1	Spectrum Analyzer	Agilent	E4407B	MY45109572	2016.08.27	2017.08.26
2	Test Receiver	R&S	ESPI	101396	2016.08.27	2017.08.26
3	Bilog Antenna	SCHWARZBECK	VULB9160	VULB9160-3369	2016.08.27	2017.08.26
4	50Ω Coaxial Switch	Anritsu	MP59B	6200264416	2016.08.27	2017.08.26
5	Spectrum Analyzer	Agilent	N9020A	MY5051041	2016.08.27	2017.08.26
6	Horn Antenna	SCHWARZBECK	9120D	9120D-1275	2016.08.29	2017.08.28
7	Horn Ant	Schwarzbeck	BBHA 9170	9170-181	2016.08.29	2017.08.28
8	Amplifier	SCHWARZBECK	BBV9718	9718-270	2016.08.29	2017.08.28
9	Amplifier	SCHWARZBECK	BBV9743	9743-119	2016.08.29	2017.08.28
10	Loop Antenna	ARA	PLMP45 MI-BTH0730/B	1029	2016.07.06	2017.07.05
11	Power Meter	R&S	NRVS	100696	2016.08.27	2017.08.26
12	Power Sensor	R&S	URV5-Z4	0395.1619.05	2016.08.27	2017.08.26
13	RF cables	R&S	N/A	N/A	2016.08.27	2017.08.26
14	966 chamber	ChengYu	966 Room	966	2016.08.27	2017.08.26

### Conduction Test equipment

Item	Kind of Equipment	Manufacturer	Type No.	Serial No.	Last calibration	Calibrated until
1	Test Receiver	R&S	ESCI	1166.5950K03-101165-ha	2016.08.27	2017.08.26
2	LISN	R&S	NSLK8126	8126466	2016.08.27	2017.08.26
3	LISN	R&S	NSLK8126	8126487	2016.08.27	2017.08.26
4	50Ω Coaxial Switch	Anritsu	MP59B	6200264417	2016.08.27	2017.08.26
5	RF cables	R&S	R204	R20X	2016.08.27	2017.08.26



### 3. EMC EMISSION TEST

#### 3.1 CONDUCTED EMISSION MEASUREMENT

##### 3.1.1 POWER LINE CONDUCTED EMISSION Limits (Frequency Range 150KHz-30MHz)

FREQUENCY (MHz)	Class A (dBuV)		Class B (dBuV)		Standard
	Quasi-peak	Average	Quasi-peak	Average	
0.15 -0.5	79.00	66.00	66 - 56 *	56 - 46 *	FCC
0.50 -5.0	73.00	60.00	56.00	46.00	FCC
5.0 -30.0	73.00	60.00	60.00	50.00	FCC

Note:

- (1) The tighter limit applies at the band edges.
- (2) The limit of " \* " marked band means the limitation decreases linearly with the logarithm of the frequency in the range.

The following table is the setting of the receiver

Receiver Parameters	Setting
Attenuation	10 dB
Start Frequency	0.15 MHz
Stop Frequency	30 MHz
IF Bandwidth	9 kHz

##### 3.1.2 TEST PROCEDURE

- a. The EUT was placed 0.8 meters from the horizontal ground plane with EUT being connected to the power mains through a line impedance stabilization network (LISN). All other support equipments powered from additional LISN(s). The LISN provide 50 Ohm/ 50uH of coupling impedance for the measuring instrument.
- b. Interconnecting cables that hang closer than 40 cm to the ground plane shall be folded back and forth in the center forming a bundle 30 to 40 cm long.
- c. I/O cables that are not connected to a peripheral shall be bundled in the center. The end of the cable may be terminated, if required, using the correct terminating impedance. The overall length shall not exceed 1 m.
- d. LISN at least 80 cm from nearest part of EUT chassis.
- e. For the actual test configuration, please refer to the related Item –EUT Test Photos.

##### 3.1.3 DEVIATION FROM TEST STANDARD

No deviation

### 3.1.4 TEST SETUP

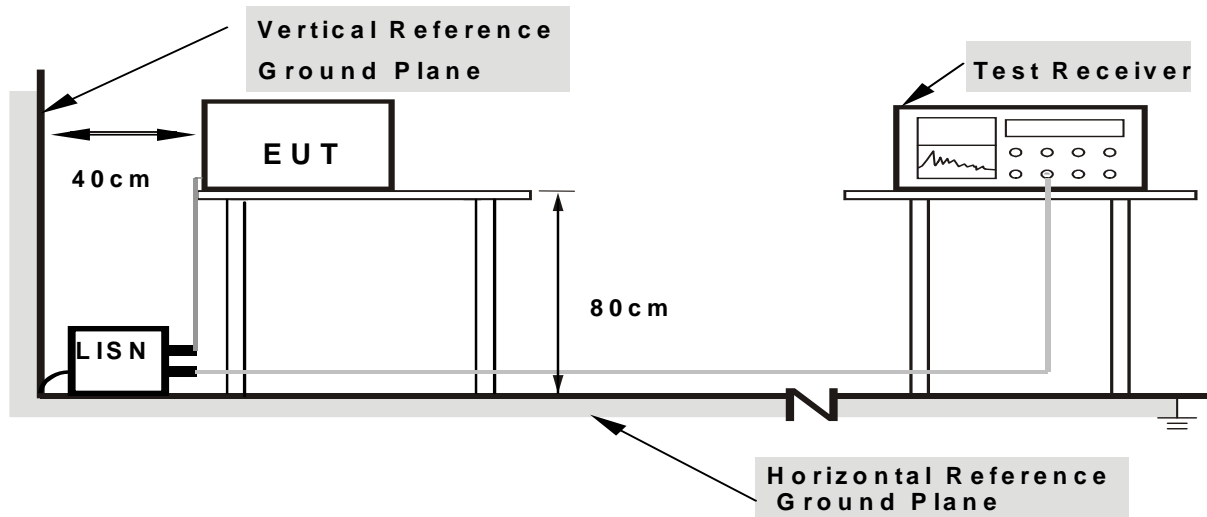

Note: 1.Support units were connected to second LISN.

2.Both of LISNs (AMN) are 80 cm from EUT and at least 80 cm from other units and other metal planes

### 3.1.5 EUT OPERATING CONDITIONS

The EUT was configured for testing in a typical fashion (as a customer would normally use it). The EUT has been programmed to continuously transmit during test. This operating condition was tested and used to collect the included data.

### 3.1.6 TEST RESULTS



Temperature :	25 °C	Relative Humidity :	54%
Pressure :	1010hPa	Phase :	L
Test Voltage :	Input: AC120V/60Hz Output: DC 3.7V	Test Mode :	Mode 1

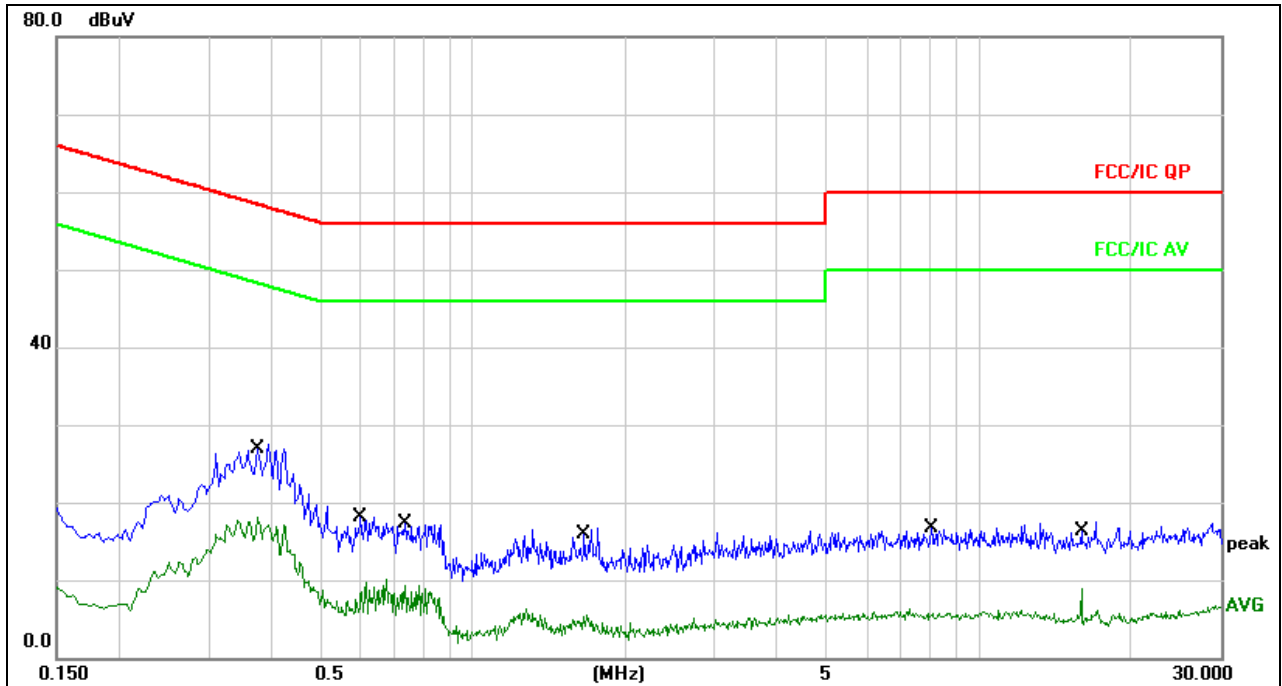

Remark:

1. All readings are Quasi-Peak and Average values.
2. Factor = Insertion Loss + Cable Loss.

No.	Mk.	Freq.	Reading Level	Correct Factor	Measurement	Limit	Over	Detector	Comment
		MHz	dBuV	dB	dBuV	dBuV	dB		
1		0.3740	17.74	9.67	27.41	58.41	-31.00	QP	
2	*	0.3740	8.47	9.67	18.14	48.41	-30.27	AVG	
3		0.5980	8.50	9.68	18.18	56.00	-37.82	QP	
4		0.5980	-0.05	9.68	9.63	46.00	-36.37	AVG	
5		0.7340	7.49	9.68	17.17	56.00	-38.83	QP	
6		0.7340	-0.46	9.68	9.22	46.00	-36.78	AVG	
7		1.6740	7.03	9.70	16.73	56.00	-39.27	QP	
8		1.6740	-4.27	9.70	5.43	46.00	-40.57	AVG	
9		8.0580	6.91	9.81	16.72	60.00	-43.28	QP	
10		8.0580	-4.02	9.81	5.79	50.00	-44.21	AVG	
11		15.9420	7.63	9.87	17.50	60.00	-42.50	QP	
12		15.9420	-1.05	9.87	8.82	50.00	-41.18	AVG	



Temperature :	25 °C	Relative Humidity :	54%
Pressure :	1010hPa	Phase :	N
Test Voltage :	Input: AC120V/60Hz Output: DC 3.7V	Test Mode :	Mode 1

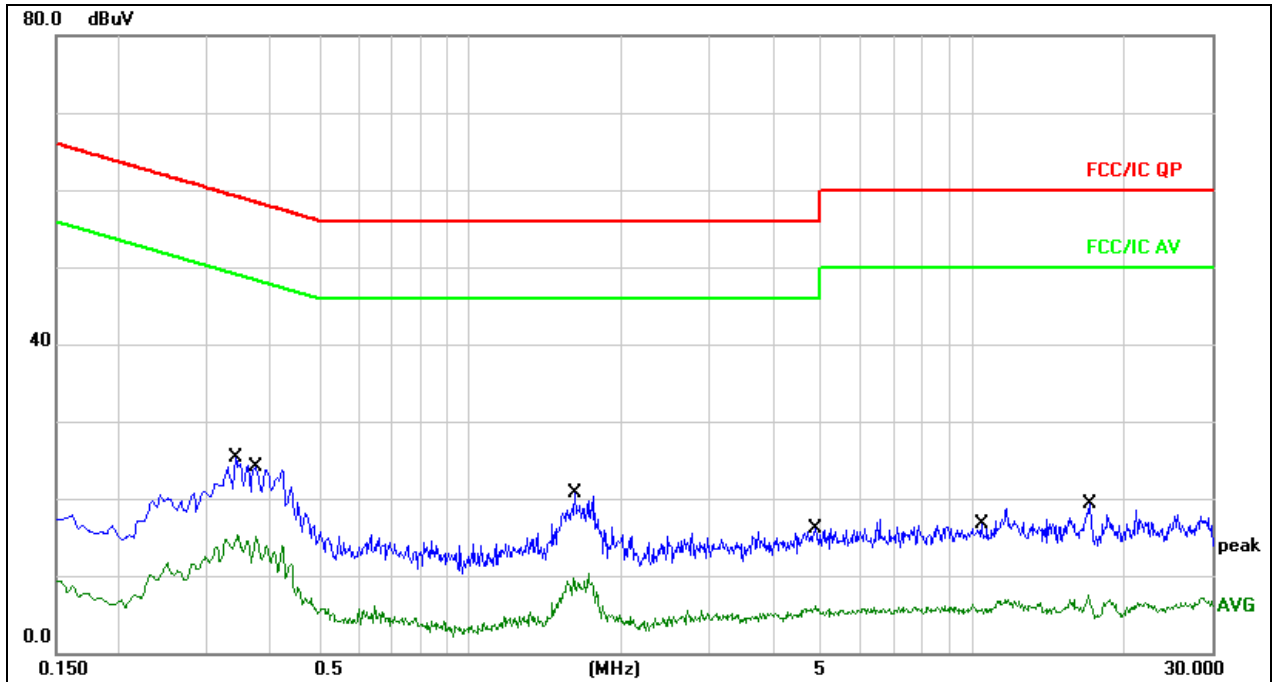

Remark:

1. All readings are Quasi-Peak and Average values.
2. Factor = Insertion Loss + Cable Loss.

No.	Mk.	Freq. MHz	Reading Level dBuV	Correct Factor dB	Measure- ment dBuV	Limit dBuV	Over dB	Detector	Comment
1		0.3420	15.57	9.66	25.23	59.15	-33.92	QP	
2		0.3420	5.61	9.66	15.27	49.15	-33.88	AVG	
3		0.3740	14.01	9.67	23.68	58.41	-34.73	QP	
4	*	0.3740	5.53	9.67	15.20	48.41	-33.21	AVG	
5		1.6019	10.95	9.70	20.65	56.00	-35.35	QP	
6		1.6019	0.01	9.70	9.71	46.00	-36.29	AVG	
7		4.8780	6.31	9.74	16.05	56.00	-39.95	QP	
8		4.8780	-3.61	9.74	6.13	46.00	-39.87	AVG	
9		10.4500	6.88	9.83	16.71	60.00	-43.29	QP	
10		10.4500	-4.10	9.83	5.73	50.00	-44.27	AVG	
11		17.1060	9.45	9.89	19.34	60.00	-40.66	QP	
12		17.1060	-2.34	9.89	7.55	50.00	-42.45	AVG	



### 3.2 RADIATED EMISSION MEASUREMENT

#### 3.2.1 RADIATED EMISSION LIMITS (Frequency Range 9kHz-1000MHz)

1. The field strength of any emissions within the band 13.553–13.567 MHz shall not exceed 15,848 microvolts/ meter at 30 meters
2. In case the emission fall within the restricted band specified on 15.205(a), then the 15.209(a) limit in the table below has to be followed.

Frequencies (MHz)	Field Strength (micorvolts/meter)	Measurement Distance (meters)
0.009~0.490	2400/F(KHz)	300
0.490~1.705	24000/F(KHz)	30
1.705~30.0	30	30
30~88	100	3
88~216	150	3
216~960	200	3
Above 960	500	3

Receiver Parameter	Setting
Attenuation	Auto
Start ~ Stop Frequency	9kHz~150kHz / RB 200Hz for QP
Start ~ Stop Frequency	150kHz~30MHz / RB 9kHz for QP
Start ~ Stop Frequency	30MHz~1000MHz / RB 120kHz for QP

#### 3.2.2 TEST PROCEDURE

Below 1GHz test procedure as below:

- a. The EUT was placed on the top of a rotating table 0.8 meters above the ground at a 3 meter semi-anechoic chamber. The table was rotated 360 degrees to determine the position of the highest radiation.
- b. The EUT was set 3 meters away from the interference-receiving antenna, which was mounted on the top of a variable-height antenna tower.
- c. The antenna height is varied from one meter to four meters above the ground to determine the maximum value of the field strength. Both horizontal and vertical polarizations of the antenna are set to make the measurement.
- d. For each suspected emission, the EUT was arranged to its worst case and then the antenna was tuned to heights from 1 meter to 4 meters (for the test frequency of below 30MHz, the antenna was tuned to heights 1 meter) and the rotatable table was turned from 0 degrees to 360 degrees to find the maximum reading.
- e. The test-receiver system was set to Peak Detect Function and Specified Bandwidth with Maximum Hold Mode.
- f. If the emission level of the EUT in peak mode was 10dB lower than the limit specified, then testing could be stopped and the peak values of the EUT would be reported. Otherwise the emissions that did not have 10dB margin would be re-tested one by one using peak, quasi-peak or average method as specified and then reported in a data sheet.

### 3.2.3 DEVIATION FROM TEST STANDARD

No deviation

### 3.2.4 TEST SETUP

(A) Radiated Emission Test-Up Frequency Below 30MHz

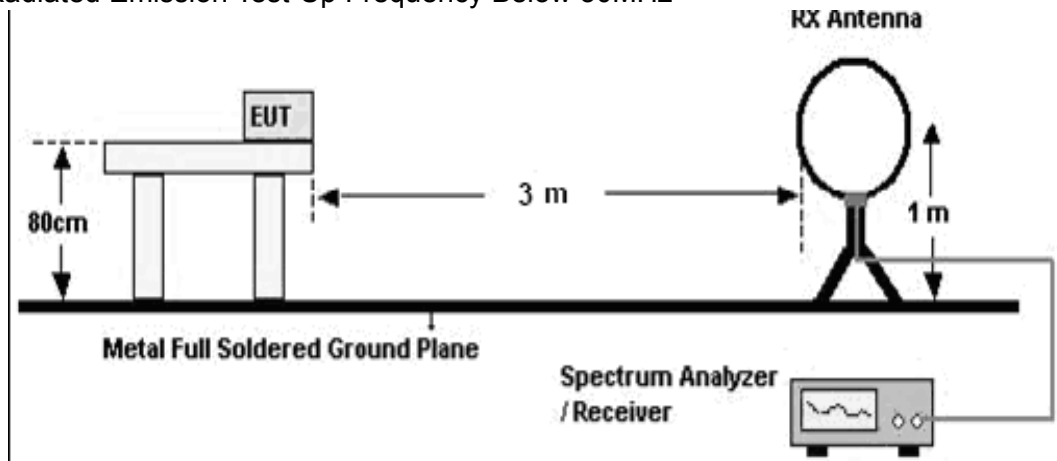

(B) Radiated Emission Test-Up Frequency 30MHz~1GHz

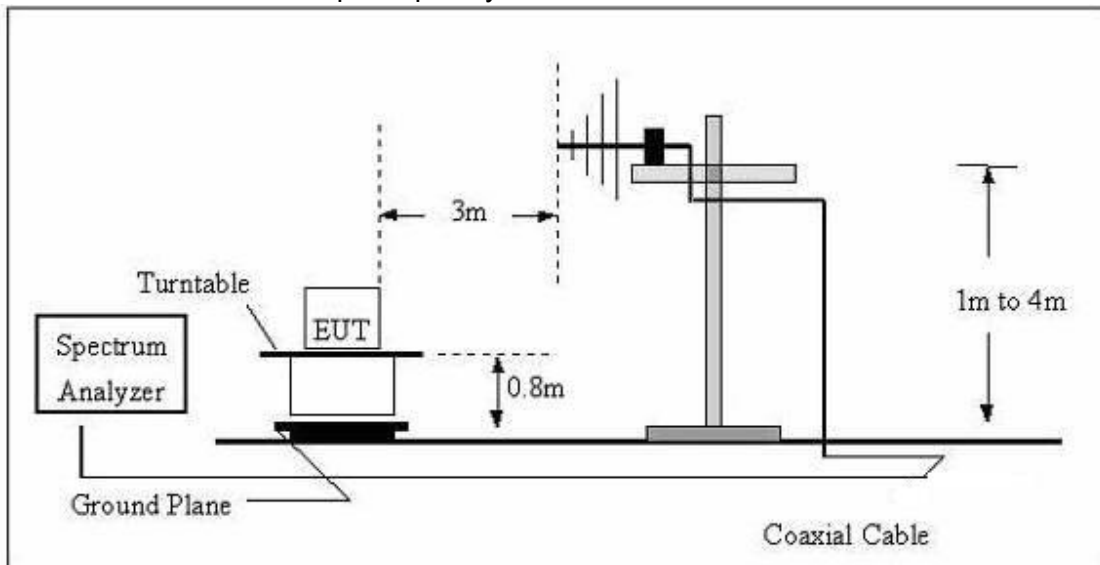

(C) Radiated Emission Test-Up Frequency Above 1GHz

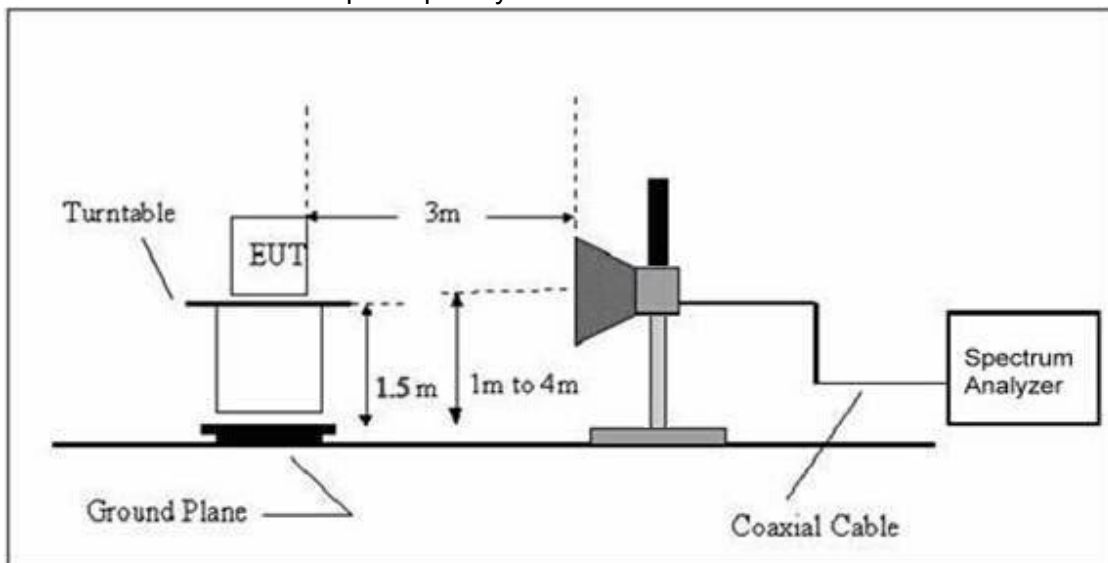

**3.2.5 EUT OPERATING CONDITIONS**

The EUT tested system was configured as the statements of 2.3 Unless otherwise a special operating condition is specified in the follows during the testing.





**3.2.6 TEST RESULTS (BETWEEN 9KHZ – 30 MHZ)**

Temperature:	20°C	Relative Humidity:	48%
Pressure:	1010 hPa	Test Voltage :	DC 3.7V
Test Mode :	Mode 1	Polarization :	--

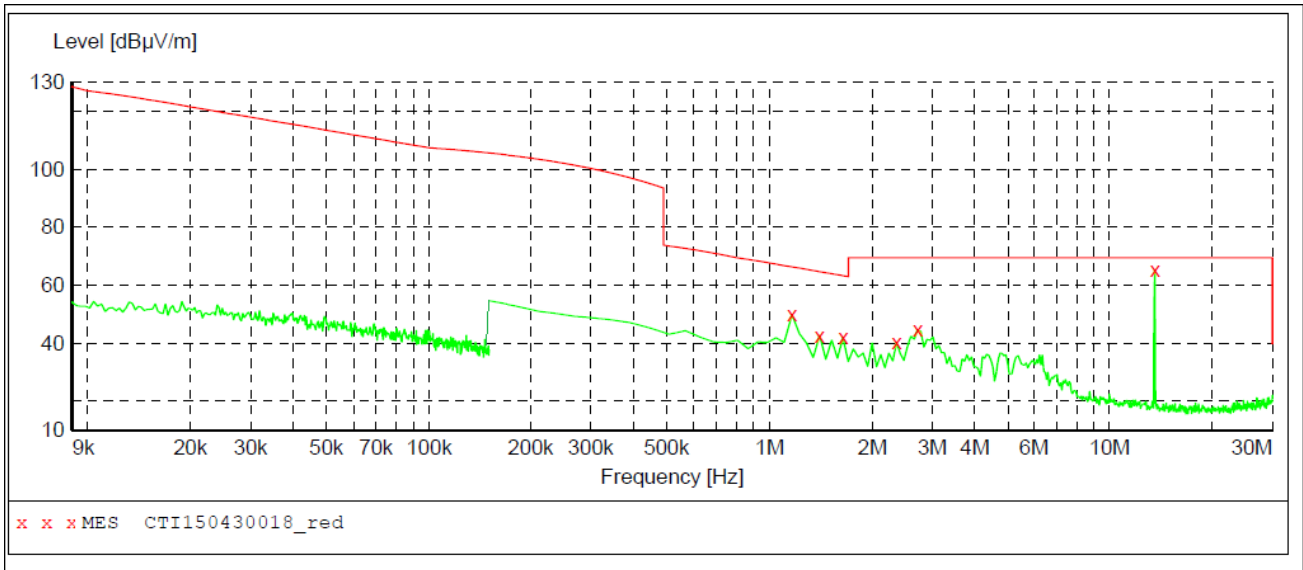

The worst data are below:

Frequency (MHz)	Antenna Polarity	PK Level (dB µ V/m)	QP Level (dB µ V/m)	Test limit_QP (dB µ V/m)	Result
13.56	90°	66.9	65.3	124.0	Pass

**NOTE:**

Measurements were performed at 3 metres and results extrapolated to 30 metres.

The limit is specified at a test distance of 30 metres. However, as specified by FCC Section 15.31 (f)(2), measurements may be performed at a closer distance and the measured level corrected to the specified measurement distance by making the measurements at a minimum of two distances on at least one radial to determine the proper extrapolation factor.

The amplitude of spurious emissions which are attenuated by more than 20dB below the permissible value has no need to be reported.

Distance extrapolation factor = 40 log (specific distance/test distance)(dB);

Limit line = specific limits(dBuv) + distance extrapolation factor.



**3.2.7 TEST RESULTS (BETWEEN 30MHZ – 1GHZ)**

Temperature :	26°C	Relative Humidity :	54%
Pressure :	1010 hPa	Polarization :	Horizontal
Test Voltage :	DC 12V from adapter		
Test Mode :	Mode 1		

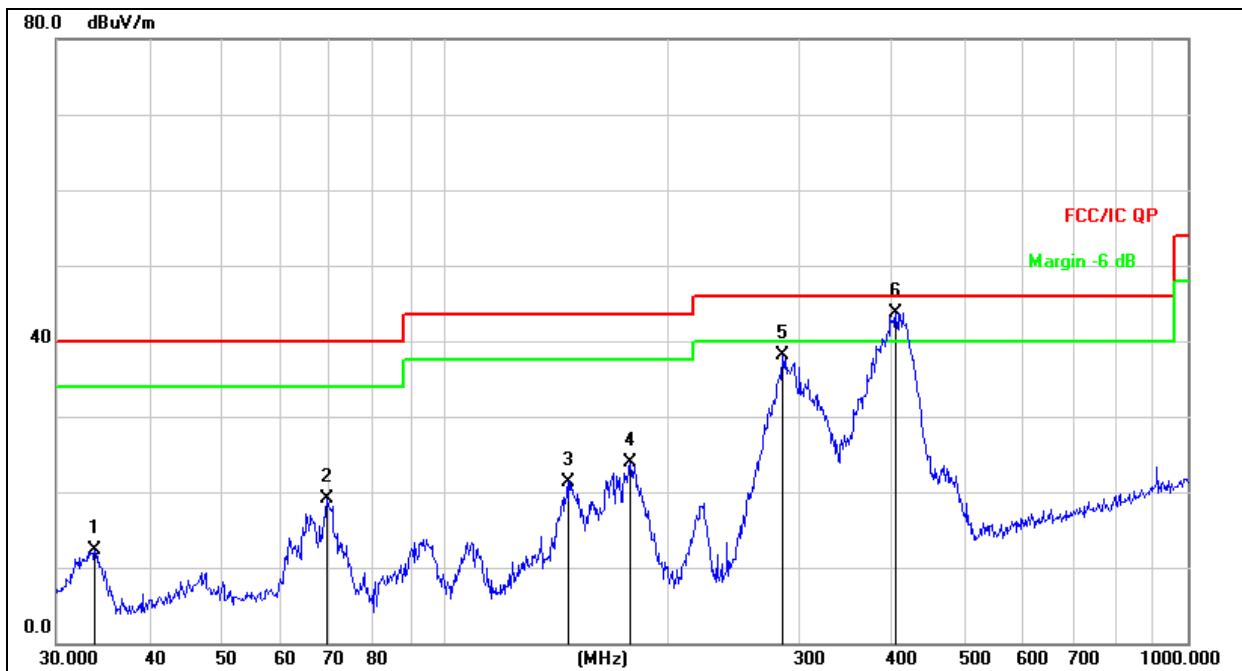

Remark:  
Factor = Antenna Factor + Cable Loss – Pre-amplifier.

No.	Mk.	Freq. MHz	Reading Level dBuV	Correct Factor dB	Measure- ment dBuV/m	Limit dB/m	Over dB	Detector
1		33.7986	30.11	-17.75	12.36	40.00	-27.64	QP
2		69.3568	37.62	-18.56	19.06	40.00	-20.94	QP
3		146.3735	41.22	-19.82	21.40	43.50	-22.10	QP
4		177.5091	41.81	-17.98	23.83	43.50	-19.67	QP
5		284.9766	50.60	-12.50	38.10	46.00	-7.90	QP
6	*	404.6664	52.91	-9.28	43.63	46.00	-2.37	QP



Temperature :	26°C	Relative Humidity :	54%
Pressure :	1010 hPa	Polarization :	Vertical
Test Voltage :	DC 12V from adapter		
Test Mode :	Mode 1		

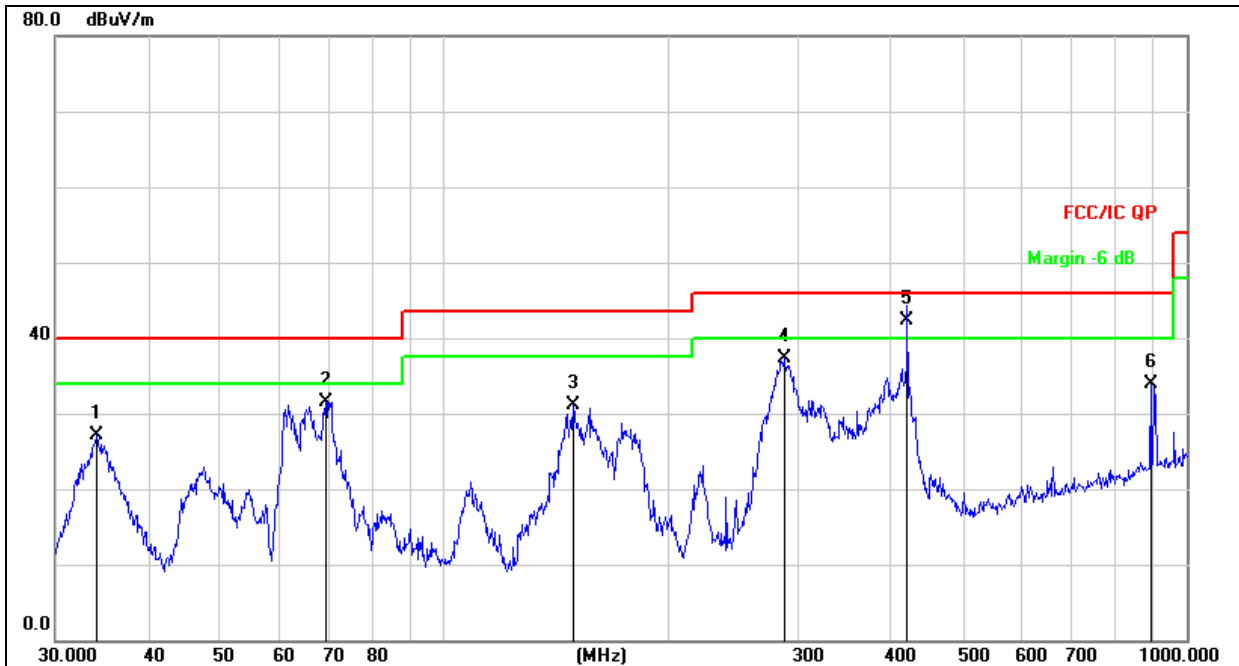

Remark:  
Factor = Antenna Factor + Cable Loss – Pre-amplifier.

No.	Mk.	Freq.	Reading Level	Correct Factor	Measurement	Limit	Over	
		MHz	dBuV	dB	dBuV/m	dB/m	dB	Detector
1		34.1561	44.84	-17.66	27.18	40.00	-12.82	QP
2		69.3568	50.15	-18.56	31.59	40.00	-8.41	QP
3		149.4857	50.72	-19.66	31.06	43.50	-12.44	QP
4		286.9823	49.68	-12.43	37.25	46.00	-8.75	QP
5	*	420.5803	51.04	-8.83	42.21	46.00	-3.79	QP
6		893.8567	33.22	0.61	33.83	46.00	-12.17	QP



### **3.3 RADIATED BAND EMISSION MEASUREMENT**

#### **3.3.1 TEST REQUIREMENT:**

FCC Part15 C Section 15.209 and 15.225

#### LIMITS OF RADIATED EMISSION MEASUREMENT

Within the bands 13.110–13.410 MHz and 13.710–14.010 MHz the field strength of any emissions shall not exceed 106 microvolts/meter at 30 meters.

The field strength of any emissions appearing outside of the 13.110–14.010 MHz band shall not exceed the general radiated emission limits in § 15.209.

#### Notes:

- (1) The limit for radiated test was performed according to FCC PART 15C.
- (2) The tighter limit applies at the band edges.
- (3) Emission level (dBuV/m)=20log Emission level (uV/m).

#### **3.3.2 TEST PROCEDURE**

- a. The Product is placed on a turntable 0.8 meters above the ground in the chamber, 3 meter away from the antenna (loop antenna). The maximum values of the field strength are recorded by adjusting the polarizations of the test antenna and rotating the turntable.
- b. For each suspected emission, the Product was arranged to its worst case and then turn table was turned from 0 degrees to 360 degrees to find the maximum reading.
- c. The test frequency analyzer system was set to Peak Detect (300Hz RBW in 9kHz to 150kHz and 10kHz RBW in 150kHz to 30MHz) Function and Specified Bandwidth with Maximum Hold Mode.

#### **3.3.3 DEVIATION FROM TEST STANDARD**

No deviation

### 3.3.4 TEST SETUP

Radiated Emission Test-Up

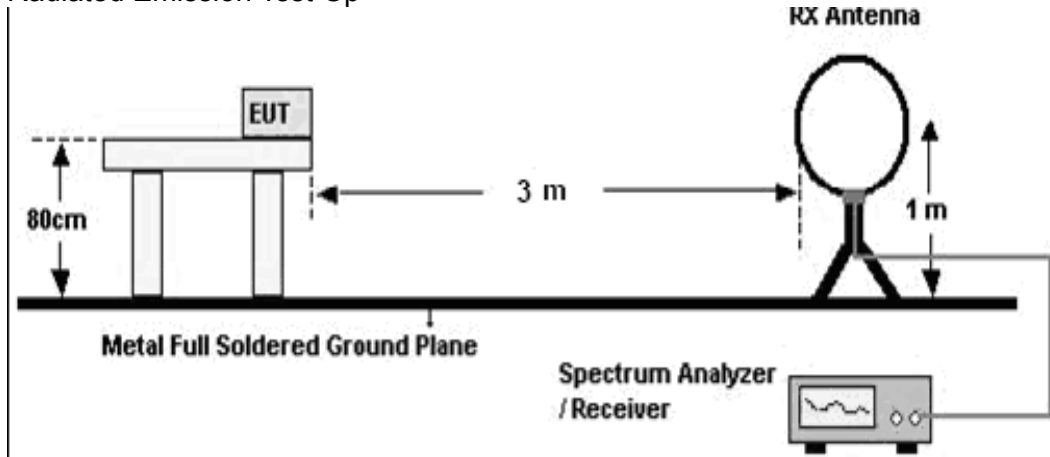

### 3.3.5 EUT OPERATING CONDITIONS

The EUT tested system was configured as the statements of 2.3 Unless otherwise a special operating condition is specified in the follows during the testing.



### 3.3.6 TEST RESULT

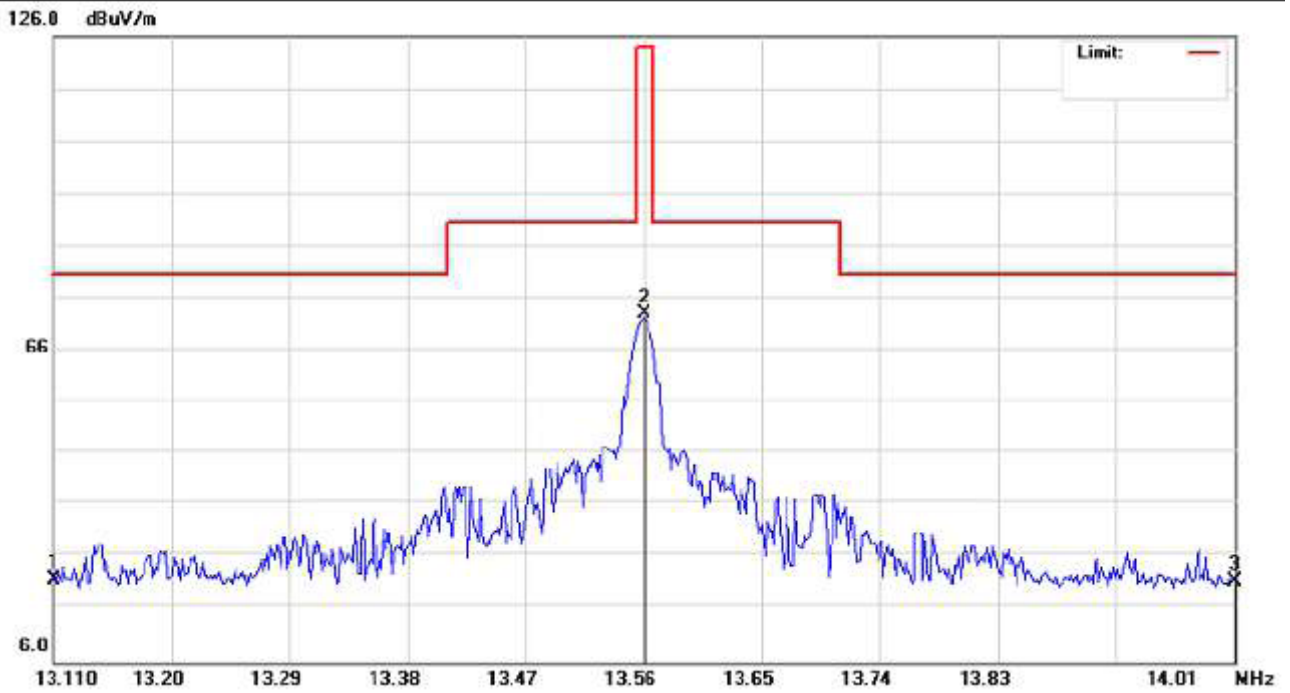

Frequency (MHz)	Meter Reading (dBuV)	Pre- amplifier (dB)	Cable Loss (dB)	Antenna Factor (dB/m)	Emission Level (dBuV/m)	Limits (dBuV/m)	Margin (dB)	Detector Type
13.11	38.92	38.06	7.42	10.15	17.57	69.50	-51.93	PK
14.01	36.74	38.06	7.42	10.15	16.25	69.50	-53.25	PK



## 4. BANDWIDTH TEST

### 4.1 APPLIED PROCEDURES

FCC Part15 (15.225)	
Section	Test Item
15.225	Bandwidth

#### 4.1.1 TEST PROCEDURE

1. Set RBW = 10 kHz.
2. Set the video bandwidth (VBW)  $\geq$ RBW.
3. Detector = Peak.
4. Trace mode = max hold.
5. Sweep = auto couple.
6. Allow the trace to stabilize.
7. Measure the maximum width of the emission that is constrained by the frequencies associated with the two outermost amplitude points (upper and lower frequencies) that are attenuated by 20 dB relative to the maximum level measured in the fundamental emission.

#### 4.1.2 DEVIATION FROM STANDARD

No deviation.

#### 4.1.3 TEST SETUP



#### 4.1.4 EUT OPERATION CONDITIONS

The EUT tested system was configured as the statements of 2.3 Unless otherwise a special operating condition is specified in the follows during the testing.





4.1.5 TEST RESULTS

Temperature :	25°C	Relative Humidity :	60%
Pressure :	1012 hPa	Test Voltage :	DC 3.7V
Test Mode :	TX Mode		

Frequency (MHz)	20dB bandwidth (KHz)
13.56	34.361

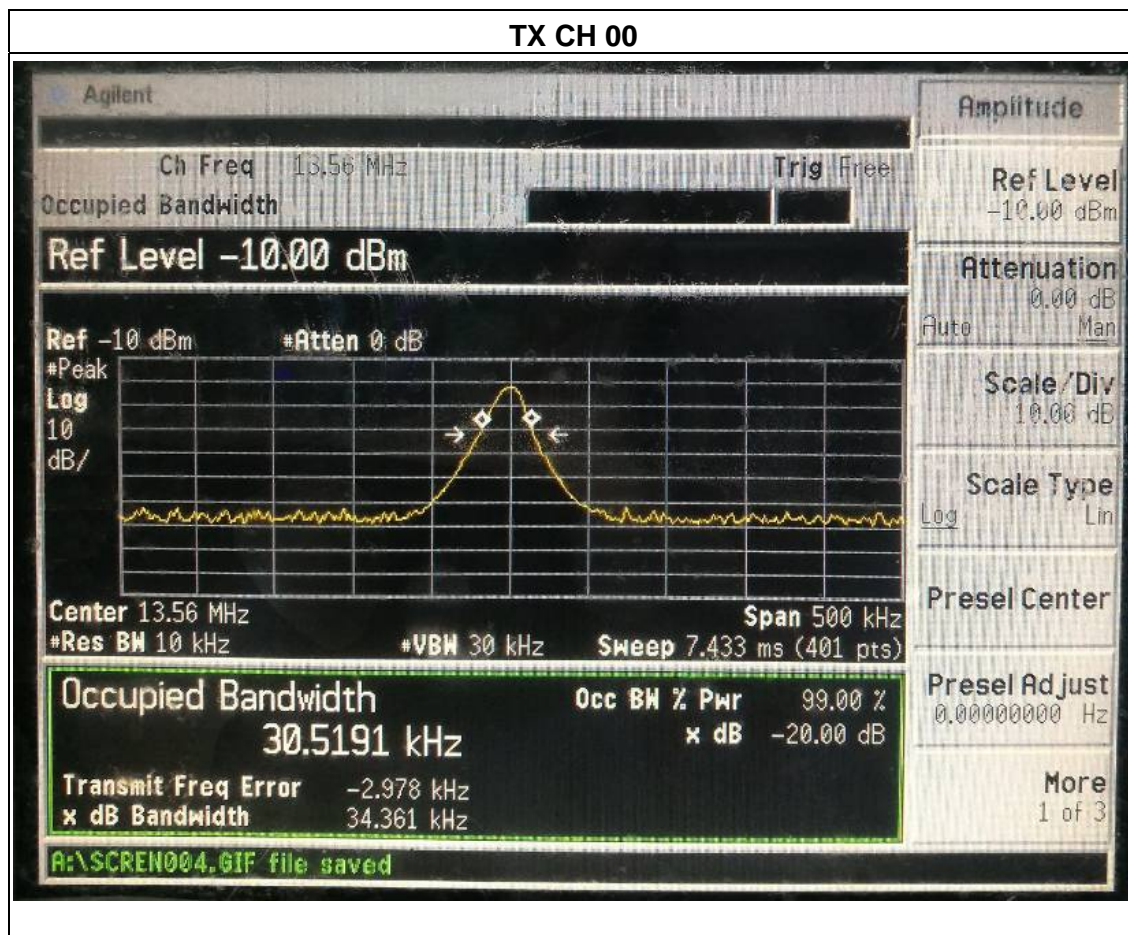





## 5. TRANSMITTER FREQUENCY STABILITY

### 5.1 LIMITS

The frequency tolerance of the carrier signal shall be maintained within  $\pm 0.01\%$  of the operating frequency over a temperature variation of  $-20$  degrees to  $+50$  degrees C at normal supply voltage, and for a variation in the primary supply voltage from  $85\%$  to  $115\%$  of the rated supply voltage at a temperature of  $20$  degrees C. For battery operated equipment, the equipment tests shall be performed using a new battery.

Limit:  $\pm 0.01\%$  of  $13.56\text{MHz} = 1356\text{Hz}$

#### 5.1.1 TEST PROCEDURE

1. Set RBW = 10 kHz.
2. Set the video bandwidth (VBW)  $\geq$  RBW.
3. Detector = Peak.
4. Trace mode = max hold.
5. Sweep = auto couple.
6. Allow the trace to stabilize.
7. The transmitter output (antenna port) was connected to the spectrum analyzer.

#### 5.1.2 DEVIATION FROM STANDARD

No deviation.

#### 5.1.3 TEST SETUP



#### 5.1.4 EUT OPERATION CONDITIONS

The EUT tested system was configured as the statements of 2.3 Unless otherwise a special operating condition is specified in the follows during the testing.



### 5.1.5 TEST RESULTS

Temperature :	25°C	Relative Humidity :	60%
Pressure :	1012 hPa	Test Voltage :	DC 3.7V
Test Mode :	TX Mode		

Test Conditions			Frequency Deviation		Result
Frequency MHz	Power(Vdc)	Temperature (°C)	Measured Freq. (MHz)	Frequency Error(Hz)	
13.56	7.4	-20	13.5601	100	PASS
	7.4	-10	13.5600	0	
	7.4	0	13.5600	0	
	7.4	10	13.5604	400	
	7.4	20	13.5606	600	
	7.4	30	13.5605	500	
	7.4	40	13.5603	300	
	7.4	50	13.5601	100	
	8.51	25	13.5606	600	
	7.4	25	13.5603	300	
6.29	25	13.5602	200		



## **6. ANTENNA REQUIREMENT**

### **6.1 STANDARD REQUIREMENT**

15.203 requirement: For intentional device, according to 15.203: an intentional radiator shall be designed to ensure that no antenna other than that furnished by the responsible party shall be used with the device.

### **6.2 EUT ANTENNA**

The EUT antenna is Loop antenna,. It comply with the standard requirement.

## 7. TEST SEUUP PHOTO

### Radiated Measurement Photos

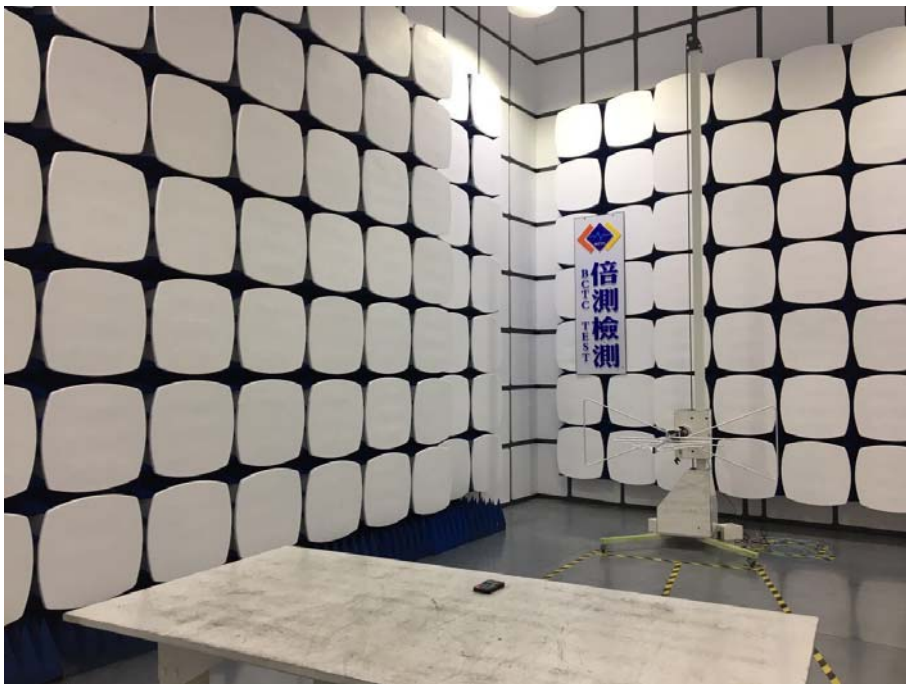
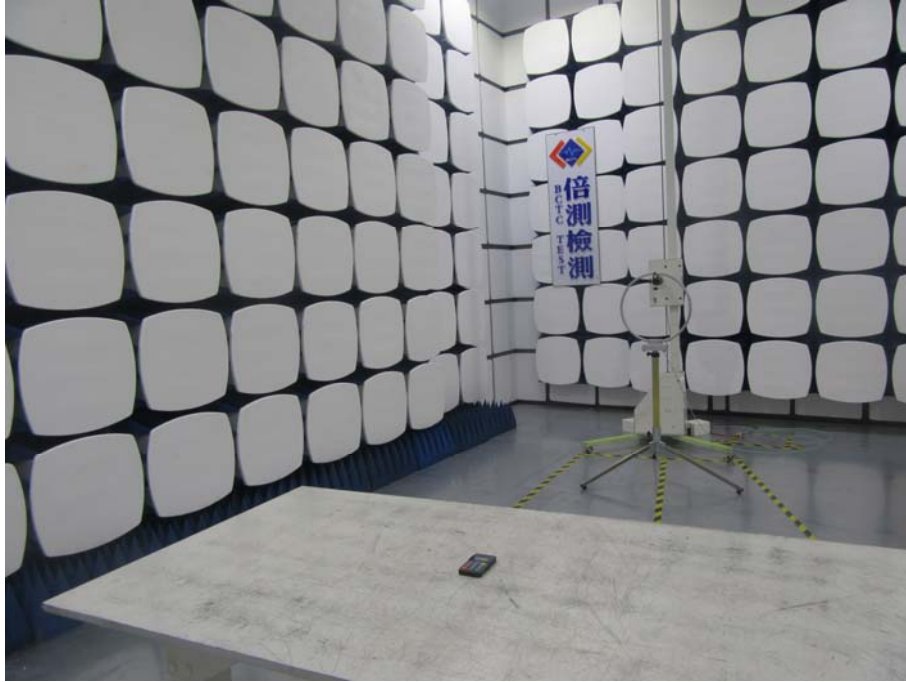



### Conducted Measurement Photos



## 8. EUT PHOTO



\*\*\*\*\* END OF REPORT \*\*\*\*\*