

4.5 Spurious Emission on Antenna Port

LIMIT

The power of any emission outside of the authorized operating frequency ranges must be attenuated below the transmitting power (P) by a factor of at least $40 + 10 \log P$ dB (-10 dBm, 100 nW) on all frequencies between the channel edge and 5 MHz from the channel edge, $43 + 10 \log P$ dB (-13 dBm, 50 nW) on all frequencies between 5 MHz and X MHz from the channel edge, and $55 + 10 \log P$ dB (-25 dBm, 3 nW) on all frequencies more than 20 MHz from the channel edge, where X MHz is the greater of 6 MHz or the actual emission bandwidth (26 dB).

TEST CONFIGURATION

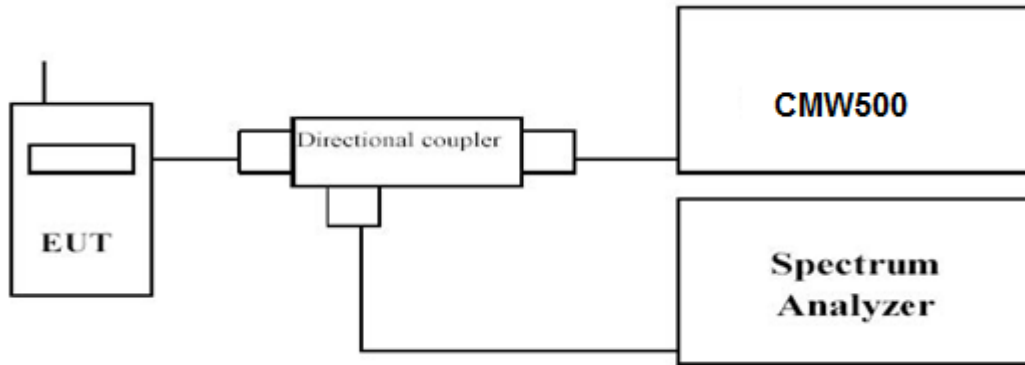

TEST PROCEDURE

The EUT was setup according to EIA/TIA 603D

- a. Place the EUT on a bench and set it in transmitting mode.
- b. Connect a low loss RF cable from the antenna port to a spectrum analyzer and CMW500 by a Directional Coupler.
- c. EUT Communicate with CMW500, then select a channel for testing.
- d. Add a correction factor to the display of spectrum, and then test.
- e. The resolution bandwidth of the spectrum analyzer was set sufficient scans were taken to show the out of band Emission if any up to 10th harmonic.
- f. Please refer to following tables for test antenna conducted emissions.

Working Frequency	Sub range (GHz)	RBW	VBW	Sweep time (s)
LTE Band 41	0.03~26.5	1 MHz	3 MHz	Auto

TEST RESULTS

EUT :	Smart POS Terminal	Test Date:	Nov. 12, 2021
Temperature:	25 ⁰ C	Tested by:	Gary Qian
Humidity:	55 % RH	Test Voltage	Normal Voltage
Operation Mode:	Normal Voltage- Tx Mode		

Remark:

1. We were tested all RB Configuration refer 3GPP TS136 521 for each Channel Bandwidth of LTE Band 41; recorded worst case at the QPSK Mode for each Channel Bandwidth of LTE Band 41



LTE Band 41-5 MHz Channel Bandwidth

Low Channel

QPSK

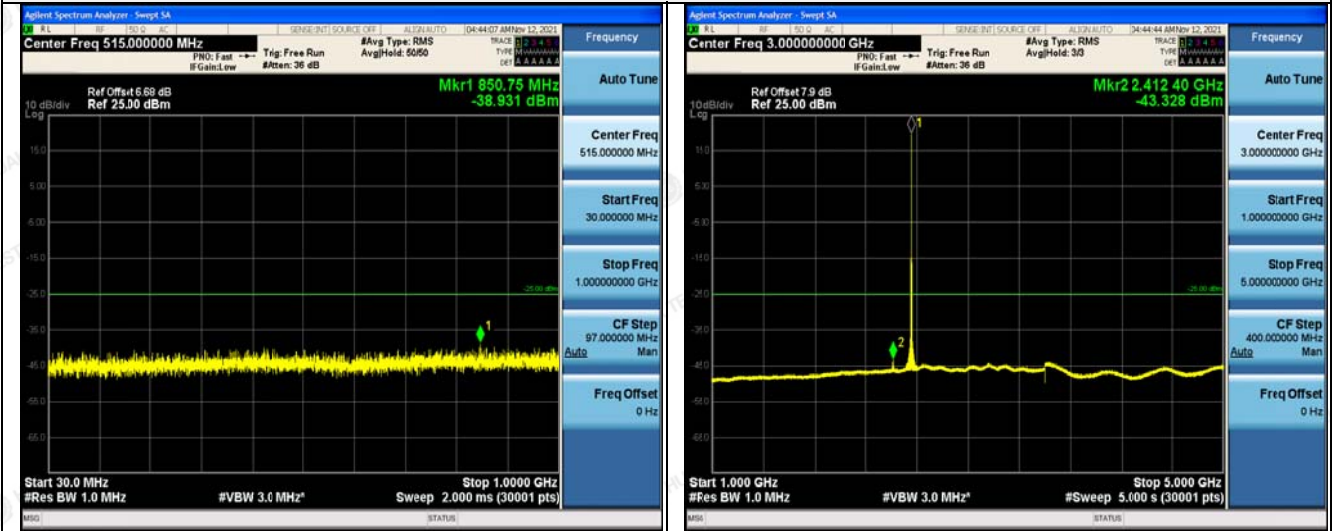

30MHz~1GHz

1GHz ~5GHz

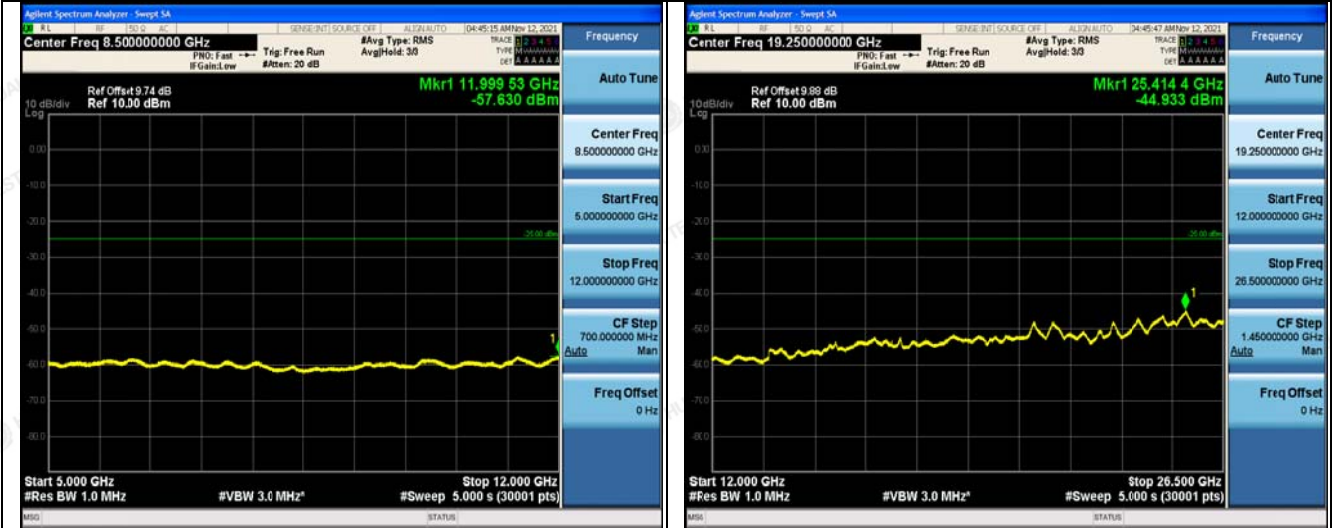

5GHz ~12GHz

12GHz ~26.5GHz

The results shown in this test report refer only to the sample(s) tested unless otherwise stated and the sample(s) are retained for 30 days only. The document is issued by HUAJ, this document cannot be reproduced except in full with our prior written permission. The more details and the authenticity of the report will be confirmed at <http://www.cer-mark.com>.



LTE Band 41-5 MHz Channel Bandwidth

Middle Channel

QPSK

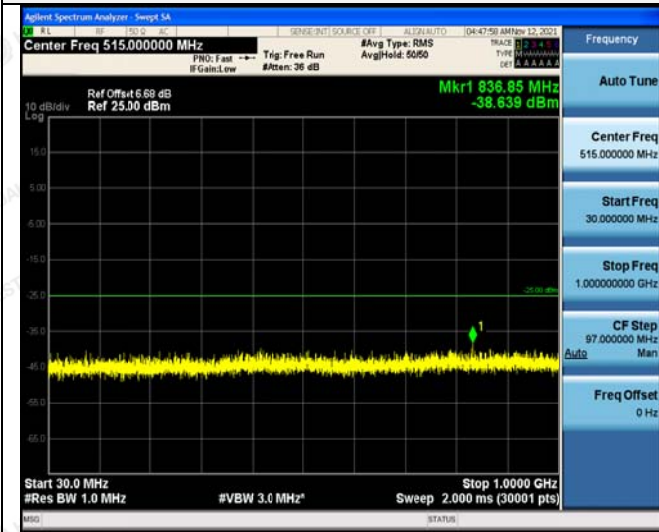

30MHz~1GHz

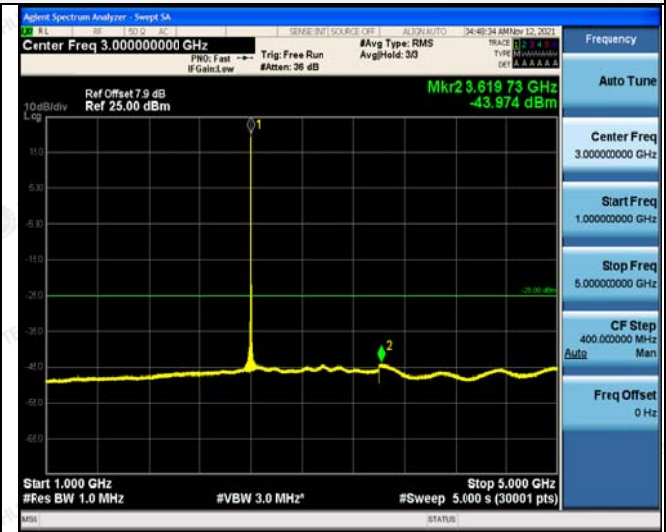

1GHz~5GHz



5GHz~12GHz



12GHz~26.5GHz

The results shown in this test report refer only to the sample(s) tested unless otherwise stated and the sample(s) are retained for 30 days only. The document is issued by HUAJ, this document cannot be reproduced except in full with our prior written permission. The more details and the authenticity of the report will be confirmed at <http://www.cer-mark.com>.



LTE Band 41-5 MHz Channel Bandwidth

High Channel

QPSK

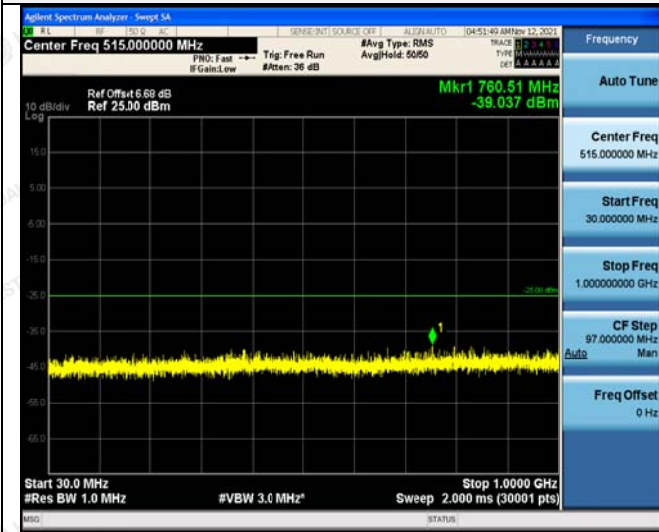

30MHz~1GHz

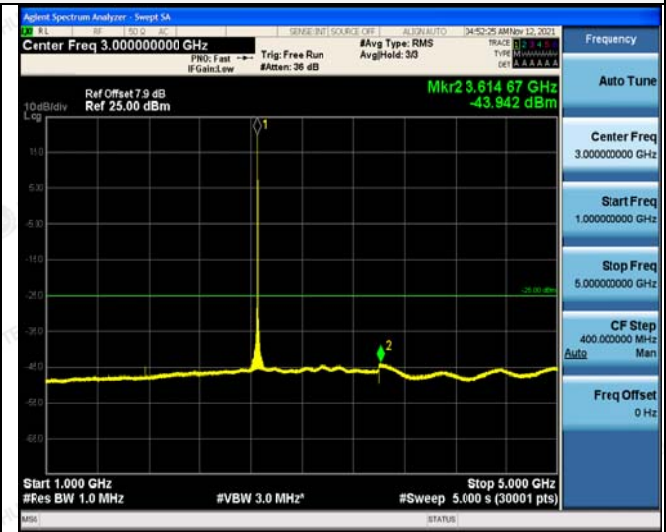

1GHz~5GHz



5GHz~12GHz



12GHz~26.5GHz

The results shown in this test report refer only to the sample(s) tested unless otherwise stated and the sample(s) are retained for 30 days only. The document is issued by HUAJ, this document cannot be reproduced except in full with our prior written permission. The more details and the authenticity of the report will be confirmed at <http://www.cer-mark.com>.



LTE Band 41-10 MHz Channel Bandwidth

Low Channel

QPSK

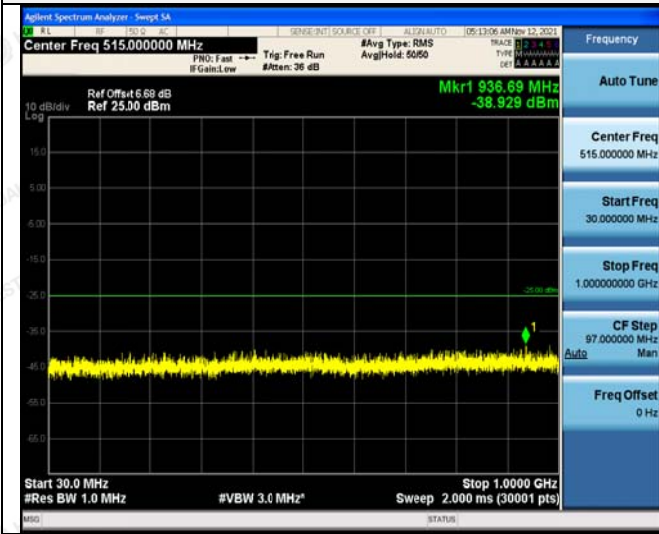

30MHz~1GHz

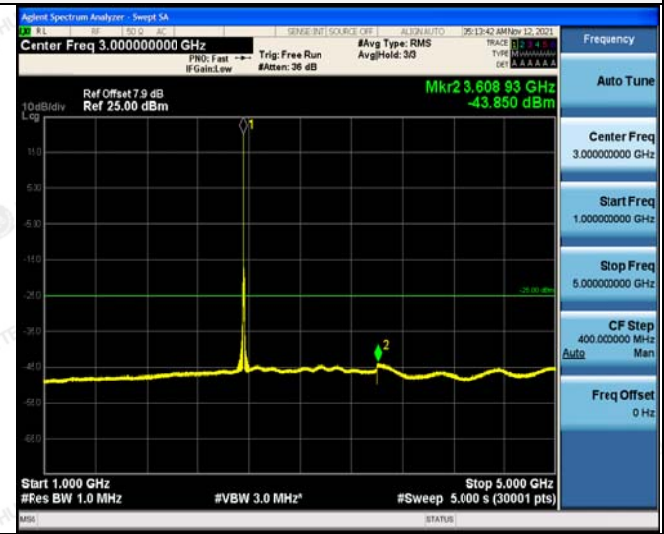

1GHz~5GHz



5GHz~12GHz



12GHz~26.5GHz

The results shown in this test report refer only to the sample(s) tested unless otherwise stated and the sample(s) are retained for 30 days only. The document is issued by HUAKE, this document cannot be reproduced except in full with our prior written permission. The more details and the authenticity of the report will be confirmed at <http://www.cer-mark.com>.



LTE Band 41-10 MHz Channel Bandwidth

Middle Channel

QPSK

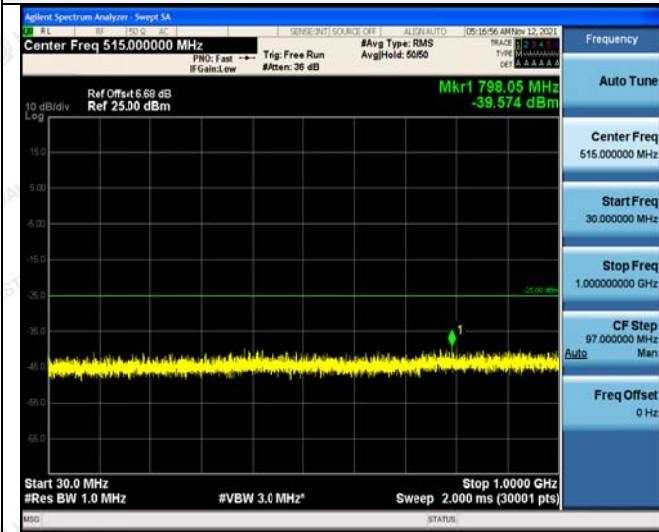

30MHz~1GHz

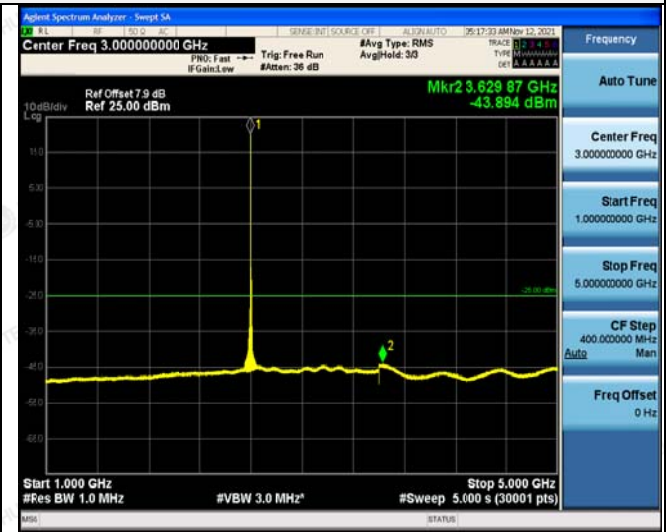

1GHz~5GHz



5GHz~12GHz



12GHz~26.5GHz

The results shown in this test report refer only to the sample(s) tested unless otherwise stated and the sample(s) are retained for 30 days only. The document is issued by HUAJ, this document cannot be reproduced except in full with our prior written permission. The more details and the authenticity of the report will be confirmed at <http://www.cer-mark.com>.



LTE Band 41-10 MHz Channel Bandwidth

High Channel

QPSK

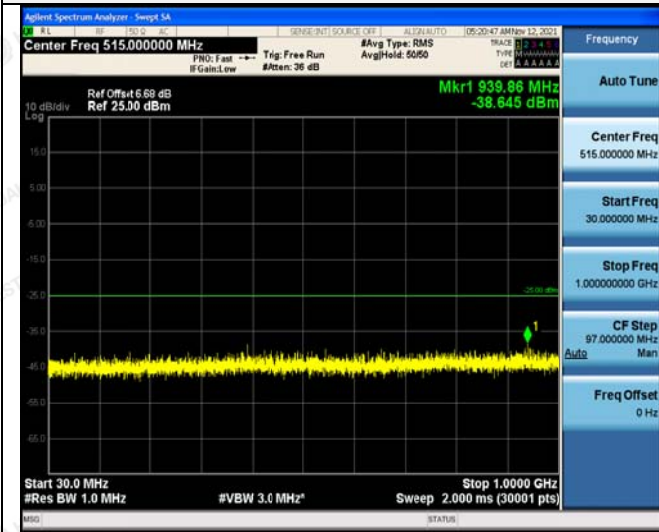

30MHz~1GHz

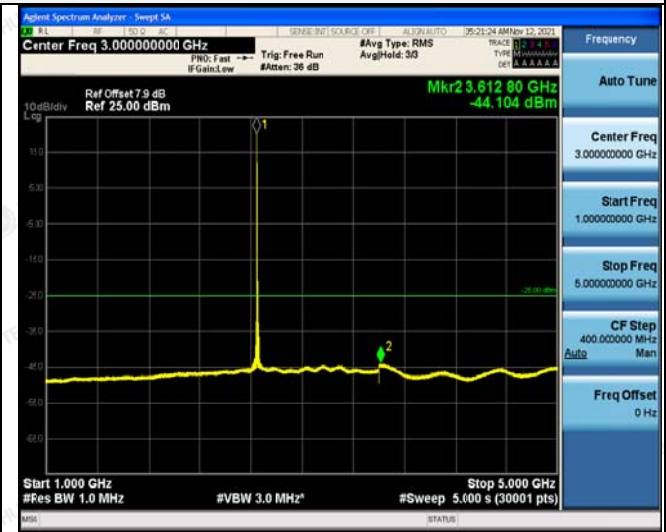

1GHz~5GHz



5GHz~12GHz



12GHz~26.5GHz

The results shown in this test report refer only to the sample(s) tested unless otherwise stated and the sample(s) are retained for 30 days only. The document is issued by HUAJ, this document cannot be reproduced except in full with our prior written permission. The more details and the authenticity of the report will be confirmed at <http://www.cer-mark.com>.



LTE Band 41-15 MHz Channel Bandwidth

Low Channel

QPSK

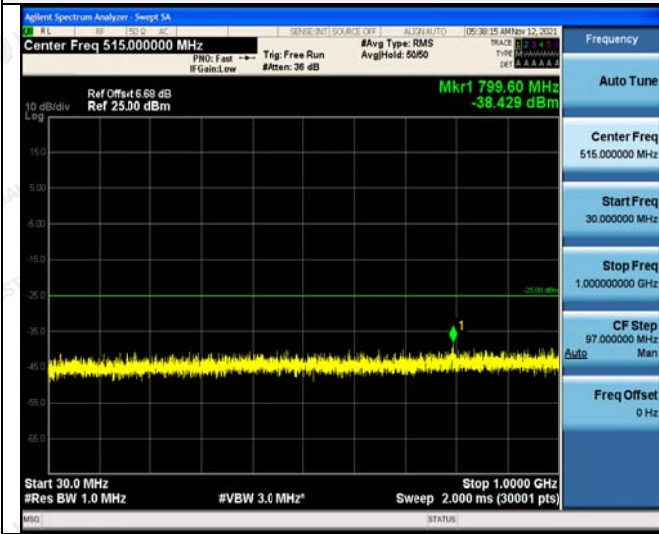

30MHz~1GHz



1GHz~5GHz



5GHz~12GHz



12GHz~26.5GHz

The results shown in this test report refer only to the sample(s) tested unless otherwise stated and the sample(s) are retained for 30 days only. The document is issued by HUAJ, this document cannot be reproduced except in full with our prior written permission. The more details and the authenticity of the report will be confirmed at <http://www.cer-mark.com>.



LTE Band 41-15 MHz Channel Bandwidth

Middle Channel

QPSK

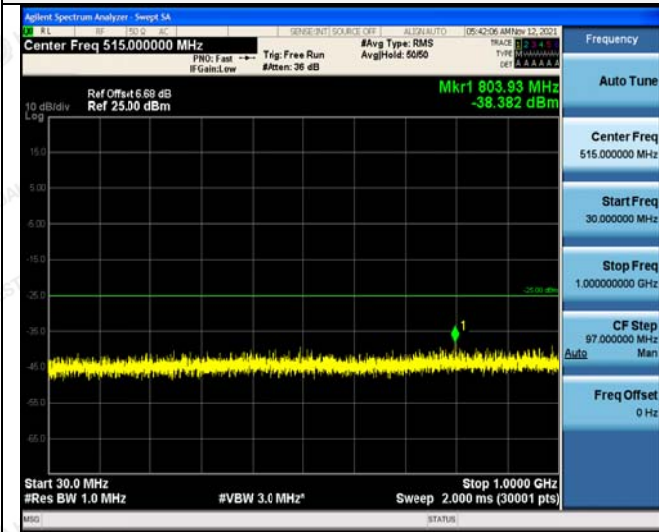

30MHz~1GHz

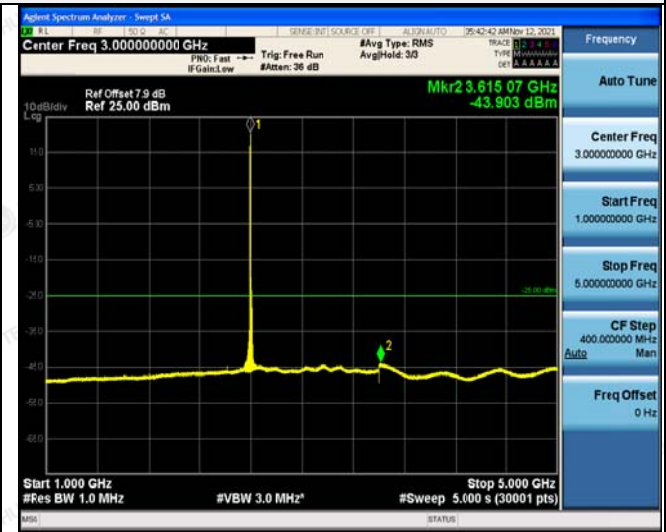

1GHz~5GHz



5GHz~12GHz



12GHz~26.5GHz

The results shown in this test report refer only to the sample(s) tested unless otherwise stated and the sample(s) are retained for 30 days only. The document is issued by HUAJ, this document cannot be reproduced except in full with our prior written permission. The more details and the authenticity of the report will be confirmed at <http://www.cer-mark.com>.



LTE Band 41-15 MHz Channel Bandwidth

High Channel

QPSK

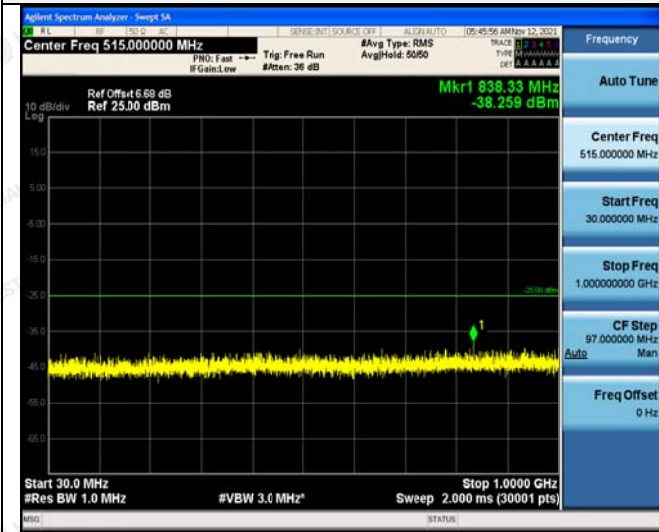

30MHz~1GHz

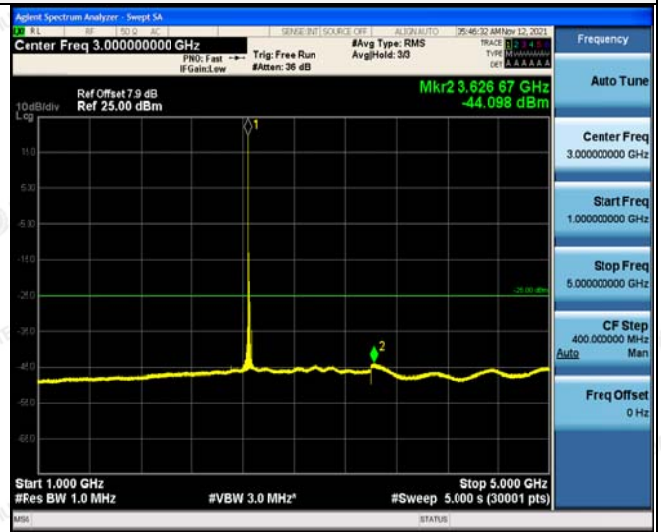

1GHz~5GHz



5GHz~12GHz



12GHz~26.5GHz

The results shown in this test report refer only to the sample(s) tested unless otherwise stated and the sample(s) are retained for 30 days only. The document is issued by HUAJ, this document cannot be reproduced except in full with our prior written permission. The more details and the authenticity of the report will be confirmed at <http://www.cer-mark.com>.



LTE Band 41-20 MHz Channel Bandwidth

Low Channel

QPSK

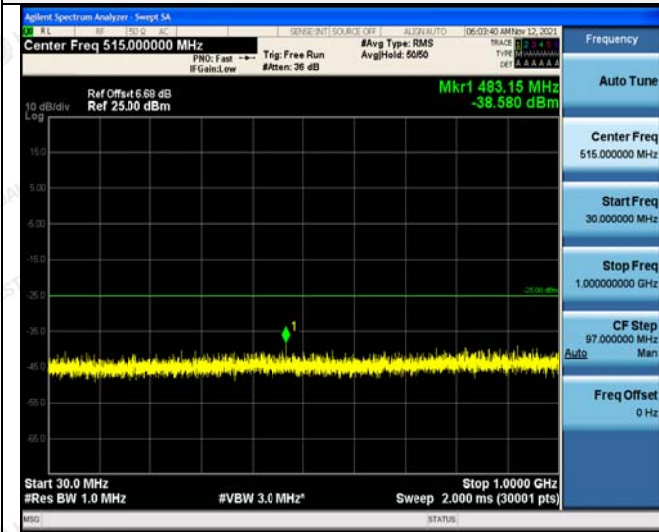

30MHz~1GHz



1GHz~5GHz



5GHz~12GHz



12GHz~26.5GHz

The results shown in this test report refer only to the sample(s) tested unless otherwise stated and the sample(s) are retained for 30 days only. The document is issued by HUAJ, this document cannot be reproduced except in full with our prior written permission. The more details and the authenticity of the report will be confirmed at <http://www.cer-mark.com>.



LTE Band 41-20 MHz Channel Bandwidth

Middle Channel

QPSK

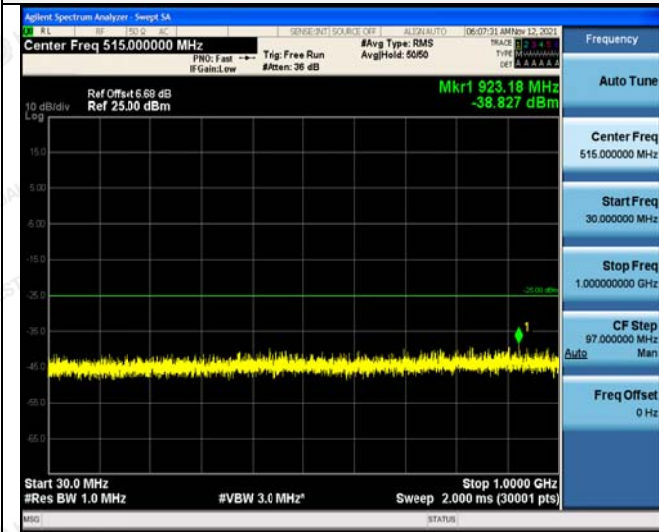

30MHz~1GHz



1GHz~5GHz



5GHz~12GHz



12GHz~26.5GHz

The results shown in this test report refer only to the sample(s) tested unless otherwise stated and the sample(s) are retained for 30 days only. The document is issued by HUAJ, this document cannot be reproduced except in full with our prior written permission. The more details and the authenticity of the report will be confirmed at <http://www.cer-mark.com>.



LTE Band 41-20 MHz Channel Bandwidth

High Channel

QPSK

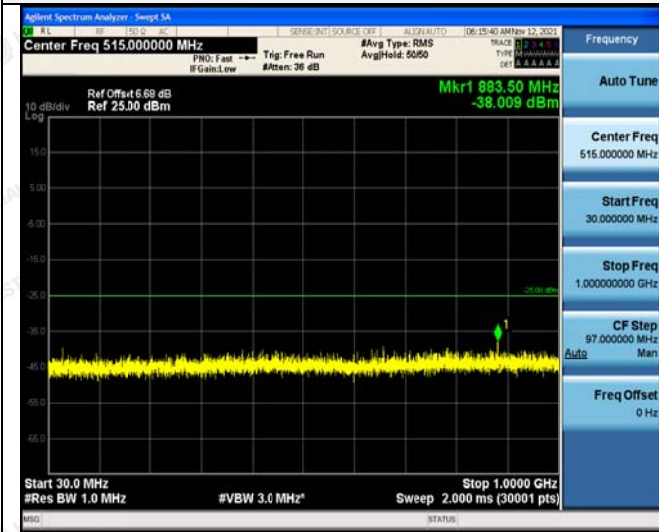

30MHz~1GHz

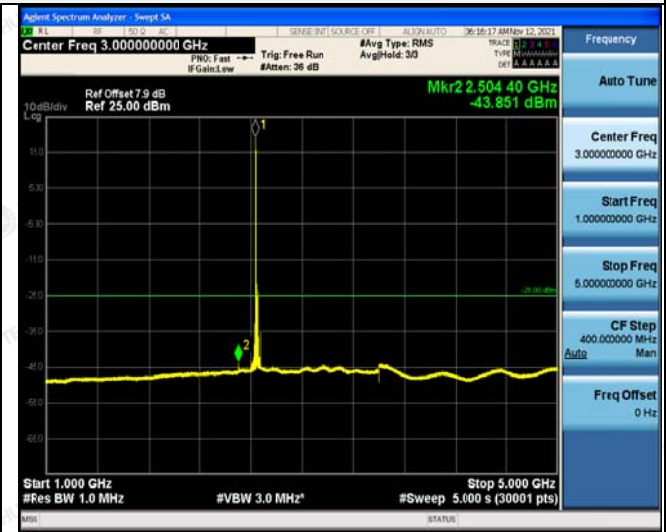

1GHz~5GHz



5GHz~12GHz



12GHz~26.5GHz

The results shown in this test report refer only to the sample(s) tested unless otherwise stated and the sample(s) are retained for 30 days only. The document is issued by HUAJ, this document cannot be reproduced except in full with our prior written permission. The more details and the authenticity of the report will be confirmed at <http://www.cer-mark.com>.

4.6 Radiated Spurious Emission

TEST APPLICABLE

The power of any emission outside of the authorized operating frequency ranges must be attenuated below the transmitting power (P) by a factor of at least $40 + 10 \log P$ dB (-10 dBm, 100 nW) on all frequencies between the channel edge and 5 MHz from the channel edge, $43 + 10 \log P$ dB (-13 dBm, 50 nW) on all frequencies between 5 MHz and X MHz from the channel edge, and $55 + 10 \log P$ dB (-25 dBm, 3 nW) on all frequencies more than 20 MHz from the channel edge, where X MHz is the greater of 6 MHz or the actual emission bandwidth (26 dB).

TEST CONFIGURATION

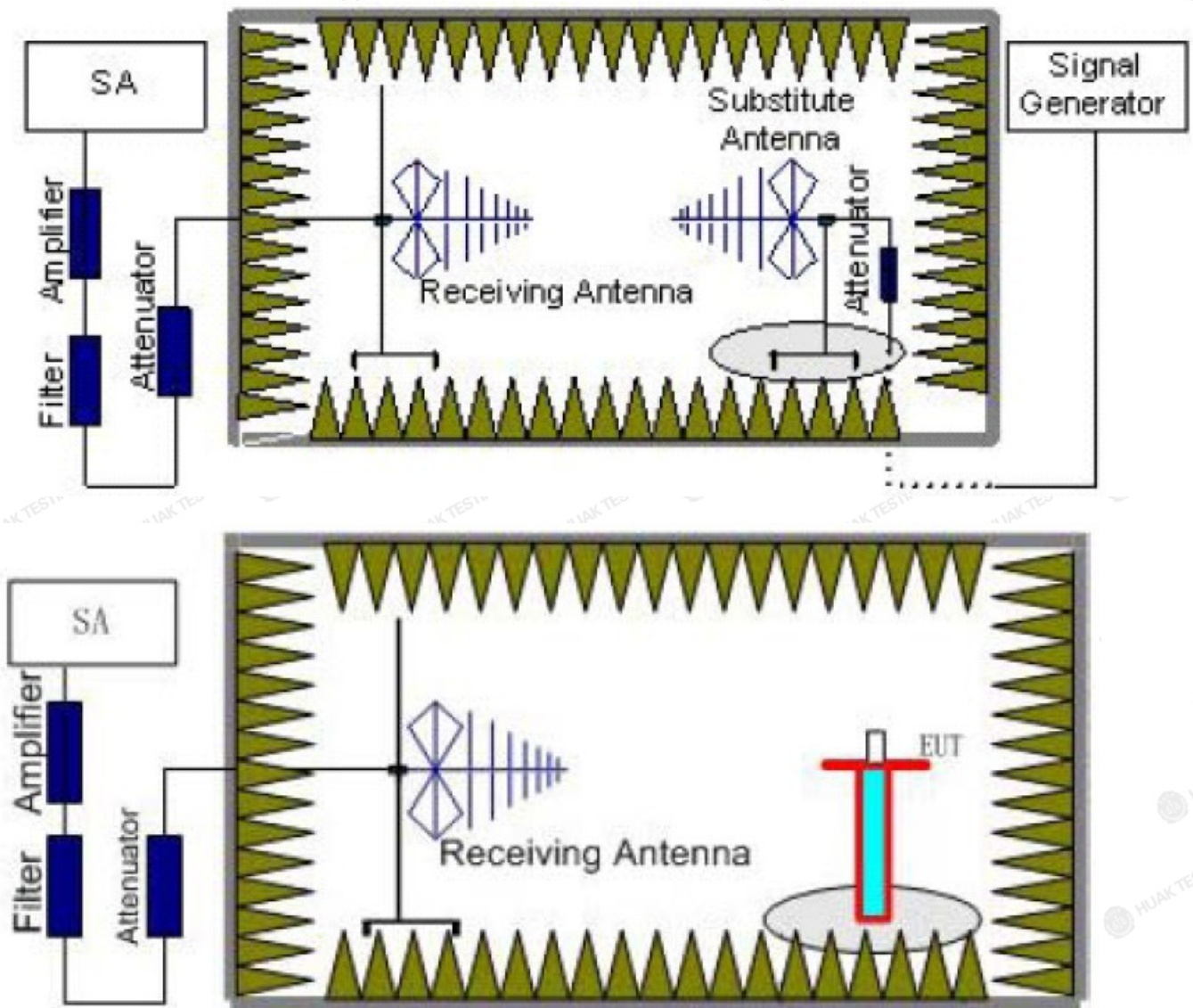

TEST PROCEDURE

The EUT was setup according to EIA/TIA 603D

- The EUT shall be placed at the specified height on a support, and in the position closest to normal use as declared by provider.
- The test antenna shall be oriented initially for vertical polarization and shall be chosen to correspond to the frequency of the transmitter
- The output of the test antenna shall be connected to the measuring receiver.
- The transmitter shall be switched on and the measuring receiver shall be tuned to the frequency of the transmitter under test.

The results shown in this test report are for only the sample(s) tested unless otherwise stated, and the sample(s) are retained for 30 days only. This document is issued by HUAKE, this document cannot be reproduced or copied in full with our prior written permission. The more details and the authenticity of the report will be confirmed at <http://www.cer-mark.com>.



- e. The test antenna shall be raised and lowered through the specified range of height until a maximum signal level is detected by the measuring receiver.
- f. The transmitter shall then be rotated through 360° in the horizontal plane, until the maximum signal level is detected by the measuring receiver.
- g. The test antenna shall be raised and lowered again through the specified range of height until a maximum signal level is detected by the measuring receiver.
- h. The maximum signal level detected by the measuring receiver shall be noted.
- i. The transmitter shall be replaced by a substitution antenna.
- j. The substitution antenna shall be orientated for vertical polarization and the length of the substitution antenna shall be adjusted to correspond to the frequency of the transmitter.
- k. The substitution antenna shall be connected to a calibrated signal generator.
- l. If necessary, the input attenuator setting of the measuring receiver shall be adjusted in order to increase the sensitivity of the measuring receiver.
- m. The test antenna shall be raised and lowered through the specified range of height to ensure that the maximum signal is received.
- n. The input signal to the substitution antenna shall be adjusted to the level that produces a level detected by the measuring receiver, that is equal to the level noted while the transmitter radiated power was measured, corrected for the change of input attenuator setting of the measuring receiver.
- o. The measurement shall be repeated with the test antenna and the substitution antenna orientated for horizontal polarization.
- p. The measure of the effective radiated power is the larger of the two levels recorded at the input to the substitution antenna, corrected for gain of the substitution antenna if necessary.
- q. Test site anechoic chamber refer to ANSI C63.4:2014.

Frequency	Channel	Frequency Range	Verdict
LTE Band 41	Low	30MHz -26.5GHz	PASS
	Middle	30MHz -26.5GHz	PASS
	High	30MHz -26.5GHz	PASS

Radiated Measurement:

EUT :	Smart POS Terminal	Test Date:	Nov. 12, 2021
Temperature:	25°C	Tested by:	Gary Qian
Humidity:	55 % RH	Test Voltage	Normal Voltage
Operation Mode:	Normal Voltage- Tx Mode		

Remark:

1. We measured all RB Configuration refer 3GPP TS136 521 for each Channel Bandwidth of LTE Band 41; recorded worst case for each Channel Bandwidth of LTE Band 41.
2. $EIRP = P_s(dBm) - P_{cl}(dB) + G_a(dBi)$
3. Not recorded other points means the reading of emissions are attenuated more than 20dB below the permissible limits or the field strength is too small to be measured.
4. $Margin = Limit - EIRP$

LTE Band 41_Channel Bandwidth 5MHz_QPSK_1RB#0

Frequency (MHz)	P _s (dBm)	P _{cl} (dB)	Distance	G _a Antenna Gain (dB)	Peak EIRP (dBm)	Limit (dBm)	Margin (dB)	Polarization
5115.0	-44.17	4.39	3	12.34	-36.22	-25	11.22	H
7672.5	-43.85	5.31	3	13.52	-35.64	-25	10.64	H
5115.0	-42.41	4.39	3	12.34	-34.46	-25	9.46	V
7672.5	-48.35	5.31	3	13.52	-40.14	-25	15.14	V

The results shown in this test report refer only to the sample(s) tested unless otherwise stated and the sample(s) are retained for 30 days only. The document is issued by HUAK, this document cannot be reproduced except in full with our prior written permission. The more details and the authenticity of the report will be confirmed at <http://www.cer-mark.com>.



LTE Band 41_Channel Bandwidth 5MHz_QPSK_1RB#0

Frequency (MHz)	Ps (dBm)	P _{cl} (dB)	Diatance	G _a Antenna Gain(dB)	Peak EIRP (dBm)	Limit (dBm)	Margin (dB)	Polarization
5200.0	-42.94	4.41	3	12.34	-35.01	-25	10.01	H
7800.0	-42.11	5.38	3	13.58	-33.91	-25	8.91	H
5200.0	-39.92	4.41	3	12.34	-31.99	-25	6.99	V
7800.0	-42.80	5.38	3	13.58	-34.60	-25	9.6	V

LTE Band 41_Channel Bandwidth 5MHz_QPSK_1RB#0

Frequency (MHz)	Ps (dBm)	P _{cl} (dB)	Diatance	G _a Antenna Gain(dB)	Peak EIRP (dBm)	Limit (dBm)	Margin (dB)	Polarization
5305.0	-42.25	4.45	3	12.45	-34.25	-25	9.25	H
7957.5	-50.70	5.47	3	13.66	-42.51	-25	17.51	H
5305.0	-44.34	4.45	3	12.45	-36.34	-25	11.34	V
7957.5	-42.31	5.48	3	13.66	-34.13	-25	9.13	V

LTE Band 41_Channel Bandwidth 10MHz_QPSK_1RB#0

Frequency (MHz)	Ps (dBm)	P _{cl} (dB)	Diatance	G _a Antenna Gain(dB)	Peak EIRP (dBm)	Limit (dBm)	Margin (dB)	Polarization
5120.0	-44.97	4.39	3	12.34	-37.02	-25	12.02	H
7680.0	-42.12	5.31	3	13.52	-33.91	-25	8.91	H
5120.0	-42.81	4.39	3	12.34	-34.86	-25	9.86	V
7680.0	-43.69	5.31	3	13.52	-35.48	-25	10.48	V

LTE Band 41_Channel Bandwidth 10MHz_QPSK_1RB#0

Frequency (MHz)	Ps (dBm)	P _{cl} (dB)	Diatance	G _a Antenna Gain(dB)	Peak EIRP (dBm)	Limit (dBm)	Margin (dB)	Polarization
5200.0	-44.23	4.41	3	12.34	-36.30	-25	11.3	H
7800.0	-42.04	5.38	3	13.58	-33.84	-25	8.84	H
5200.0	-40.79	4.41	3	12.34	-32.86	-25	7.86	V
7800.0	-42.45	5.38	3	13.58	-34.25	-25	9.25	V

LTE Band 41_Channel Bandwidth 10MHz_QPSK_1RB#0

Frequency (MHz)	Ps (dBm)	P _{cl} (dB)	Diatance	G _a Antenna Gain(dB)	Peak EIRP (dBm)	Limit (dBm)	Margin (dB)	Polarization
5300.0	-44.29	4.45	3	12.45	-36.29	-25	11.29	H
7950.0	-42.10	5.47	3	13.66	-33.91	-25	8.91	H
5300.0	-42.03	4.45	3	12.45	-34.03	-25	9.03	V
7950.0	-43.93	5.48	3	13.66	-35.75	-25	10.75	V

LTE Band 41_Channel Bandwidth 15MHz_QPSK_1RB#0

Frequency (MHz)	Ps (dBm)	P _{cl} (dB)	Diatance	G _a Antenna Gain(dB)	Peak EIRP (dBm)	Limit (dBm)	Margin (dB)	Polarization
5125.0	-44.76	4.39	3	12.34	-36.81	-25	11.81	H
7687.5	-42.17	5.31	3	13.52	-33.96	-25	8.96	H
5125.0	-41.70	4.39	3	12.34	-33.75	-25	8.75	V
7687.5	-43.98	5.31	3	13.52	-35.77	-25	10.77	V

The results shown in this test report refer only to the sample(s) tested unless otherwise stated and the sample(s) are retained for 30 days only. The document is issued by HUAKE, this document cannot be reproduced except in full with our prior written permission. The more details and the authenticity of the report will be confirmed at <http://www.cer-mark.com>.



LTE Band 41_Channel Bandwidth 15MHz_QPSK_1RB#0

Frequency (MHz)	Ps (dBm)	P _{cl} (dB)	Diatance	G _a Antenna Gain(dB)	Peak EIRP (dBm)	Limit (dBm)	Margin (dB)	Polarization
5200.0	-42.94	4.41	3	12.34	-35.01	-25	10.01	H
7800.0	-44.11	5.38	3	13.58	-35.91	-25	10.91	H
5200.0	-40.86	4.41	3	12.34	-32.93	-25	7.93	V
7800.0	-43.00	5.38	3	13.58	-34.80	-25	9.8	V

LTE Band 41_Channel Bandwidth 15MHz_QPSK_1RB#0

Frequency (MHz)	Ps (dBm)	P _{cl} (dB)	Diatance	G _a Antenna Gain(dB)	Peak EIRP (dBm)	Limit (dBm)	Margin (dB)	Polarization
5295.0	-44.03	4.45	3	12.45	-36.03	-25	11.03	H
7942.5	-41.79	5.47	3	13.66	-33.60	-25	8.6	H
5295.0	-42.24	4.45	3	12.45	-34.24	-25	9.24	V
7942.5	-43.65	5.48	3	13.66	-35.47	-25	10.47	V

LTE Band 41_Channel Bandwidth 20MHz_QPSK_1RB#0

Frequency (MHz)	Ps (dBm)	P _{cl} (dB)	Diatance	G _a Antenna Gain(dB)	Peak EIRP (dBm)	Limit (dBm)	Margin (dB)	Polarization
5130.0	-44.43	4.39	3	12.34	-36.48	-25	11.48	H
7695.0	-41.59	5.31	3	13.52	-33.38	-25	8.38	H
5130.0	-41.88	4.39	3	12.34	-33.93	-25	8.93	V
7695.0	-42.76	5.31	3	13.52	-34.55	-25	9.55	V

LTE Band 41_Channel Bandwidth 20MHz_QPSK_1RB#0

Frequency (MHz)	Ps (dBm)	P _{cl} (dB)	Diatance	G _a Antenna Gain(dB)	Peak EIRP (dBm)	Limit (dBm)	Margin (dB)	Polarization
5200.0	-41.48	4.41	3	12.34	-33.55	-25	8.55	H
7800.0	-48.26	5.38	3	13.58	-40.06	-25	15.06	H
5200.0	-40.56	4.41	3	12.34	-32.63	-25	7.63	V
7800.0	-41.48	5.38	3	13.58	-33.28	-25	8.28	V

LTE Band 41_Channel Bandwidth 20MHz_QPSK_1RB#0

Frequency (MHz)	Ps (dBm)	P _{cl} (dB)	Diatance	G _a Antenna Gain(dB)	Peak EIRP (dBm)	Limit (dBm)	Margin (dB)	Polarization
5290.0	-42.29	4.45	3	12.45	-34.29	-25	9.29	H
7935.0	-40.36	5.47	3	13.66	-32.17	-25	7.17	H
5290.0	-42.96	4.45	3	12.45	-34.96	-25	9.96	V
7935.0	-42.28	5.48	3	13.66	-34.10	-25	9.10	V

LTE Band 41_Channel Bandwidth 5MHz_16QAM_1RB#0

Frequency (MHz)	Ps (dBm)	P _{cl} (dB)	Diatance	G _a Antenna Gain(dB)	Peak EIRP (dBm)	Limit (dBm)	Margin (dB)	Polarization
5115.0	-45.13	4.39	3	12.34	-37.18	-25	12.18	H
7672.5	-41.27	5.31	3	13.52	-33.06	-25	8.06	H
5115.0	-42.21	4.39	3	12.34	-34.26	-25	9.26	V
7672.5	-42.83	5.31	3	13.52	-34.62	-25	9.62	V

The results shown in this test report refer only to the sample(s) tested unless otherwise stated and the sample(s) are retained for 30 days only. The document is issued by HUAKE, this document cannot be reproduced except in full with our prior written permission. The more details and the authenticity of the report will be confirmed at <http://www.cer-mark.com>.



LTE Band 41_Channel Bandwidth 5MHz_16QAM_1RB#0

Frequency (MHz)	Ps (dBm)	P _{cl} (dB)	Diatance	G _a Antenna Gain(dB)	Peak EIRP (dBm)	Limit (dBm)	Margin (dB)	Polarization
5200.0	-41.73	4.41	3	12.34	-33.80	-25	8.8	H
7800.0	-47.74	5.38	3	13.58	-39.54	-25	14.54	H
5200.0	-40.47	4.41	3	12.34	-32.54	-25	7.54	V
7800.0	-42.88	5.38	3	13.58	-34.68	-25	9.68	V

LTE Band 41_Channel Bandwidth 5MHz_16QAM_1RB#0

Frequency (MHz)	Ps (dBm)	P _{cl} (dB)	Diatance	G _a Antenna Gain(dB)	Peak EIRP (dBm)	Limit (dBm)	Margin (dB)	Polarization
5305.0	-42.15	4.45	3	12.45	-34.15	-25	9.15	H
7957.5	-40.62	5.47	3	13.66	-32.43	-25	7.43	H
5305.0	-43.94	4.45	3	12.45	-35.94	-25	10.94	V
7957.5	-42.26	5.48	3	13.66	-34.08	-25	9.08	V

LTE Band 41_Channel Bandwidth 10MHz_16QAM_1RB#0

Frequency (MHz)	Ps (dBm)	P _{cl} (dB)	Diatance	G _a Antenna Gain(dB)	Peak EIRP (dBm)	Limit (dBm)	Margin (dB)	Polarization
5120.0	-45.68	4.39	3	12.34	-37.73	-25	12.73	H
7680.0	-41.10	5.31	3	13.52	-32.89	-25	7.89	H
5120.0	-41.76	4.39	3	12.34	-33.81	-25	8.81	V
7680.0	-46.18	5.31	3	13.52	-37.97	-25	12.97	V

LTE Band 41_Channel Bandwidth 10MHz_16QAM_1RB#0

Frequency (MHz)	Ps (dBm)	P _{cl} (dB)	Diatance	G _a Antenna Gain(dB)	Peak EIRP (dBm)	Limit (dBm)	Margin (dB)	Polarization
5200.0	-40.89	4.41	3	12.34	-32.96	-25	7.96	H
7800.0	-46.13	5.38	3	13.58	-37.93	-25	12.93	H
5200.0	-41.01	4.41	3	12.34	-33.08	-25	8.08	V
7800.0	-42.05	5.38	3	13.58	-33.85	-25	8.85	V

LTE Band 41_Channel Bandwidth 10MHz_16QAM_1RB#0

Frequency (MHz)	Ps (dBm)	P _{cl} (dB)	Diatance	G _a Antenna Gain(dB)	Peak EIRP (dBm)	Limit (dBm)	Margin (dB)	Polarization
5300.0	-42.37	4.45	3	12.45	-34.37	-25	9.37	H
7950.0	-43.38	5.47	3	13.66	-35.19	-25	10.19	H
5300.0	-43.79	4.45	3	12.45	-35.79	-25	10.79	V
7950.0	-43.53	5.48	3	13.66	-35.35	-25	10.35	V

LTE Band 41_Channel Bandwidth 15MHz_16QAM_1RB#0

Frequency (MHz)	Ps (dBm)	P _{cl} (dB)	Diatance	G _a Antenna Gain(dB)	Peak EIRP (dBm)	Limit (dBm)	Margin (dB)	Polarization
5125.0	-44.42	4.39	3	12.34	-36.47	-25	11.47	H
7687.5	-43.32	5.31	3	13.52	-35.11	-25	10.11	H
5125.0	-41.97	4.39	3	12.34	-34.02	-25	9.02	V
7687.5	-44.94	5.31	3	13.52	-36.73	-25	11.73	V

LTE Band 41_Channel Bandwidth 15MHz_16QAM_1RB#0

Frequency (MHz)	Ps (dBm)	P _{cl} (dB)	Diatance	G _a Antenna Gain(dB)	Peak EIRP (dBm)	Limit (dBm)	Margin (dB)	Polarization
5200.0	-41.47	4.41	3	12.34	-33.54	-25	8.54	H
7800.0	-44.47	5.38	3	13.58	-36.27	-25	11.27	H
5200.0	-40.33	4.41	3	12.34	-32.40	-25	7.4	V
7800.0	-41.75	5.38	3	13.58	-33.55	-25	8.55	V

The results shown in this test report refer only to the sample(s) tested unless otherwise stated and the sample(s) are retained for 30 days only. The document is issued by HUAKE, this document cannot be reproduced except in full with our prior written permission. The more details and the authenticity of the report will be confirmed at <http://www.cer-mark.com>.



LTE Band 41_Channel Bandwidth 15MHz_16QAM_1RB#0

Frequency (MHz)	Ps (dBm)	P _{cl} (dB)	Diatance	G _a Antenna Gain(dB)	Peak EIRP (dBm)	Limit (dBm)	Margin (dB)	Polarization
5295.0	-47.13	4.45	3	12.45	-39.13	-25	14.13	H
7942.5	-43.09	5.47	3	13.66	-34.90	-25	9.9	H
5295.0	-48.23	4.45	3	12.45	-40.23	-25	15.23	V
7942.5	-43.06	5.48	3	13.66	-34.88	-25	9.88	V

LTE Band 41_Channel Bandwidth 20MHz_16QAM_1RB#0

Frequency (MHz)	Ps (dBm)	P _{cl} (dB)	Diatance	G _a Antenna Gain(dB)	Peak EIRP (dBm)	Limit (dBm)	Margin (dB)	Polarization
5130.0	-41.67	4.39	3	12.34	-33.72	-25	8.72	H
7695.0	-42.75	5.31	3	13.52	-34.54	-25	9.54	H
5130.0	-42.52	4.39	3	12.34	-34.57	-25	9.57	V
7695.0	-45.64	5.31	3	13.52	-37.43	-25	12.43	V

LTE Band 41_Channel Bandwidth 20MHz_16QAM_1RB#0

Frequency (MHz)	Ps (dBm)	P _{cl} (dB)	Diatance	G _a Antenna Gain(dB)	Peak EIRP (dBm)	Limit (dBm)	Margin (dB)	Polarization
5200.0	-41.25	4.41	3	12.34	-33.32	-25	8.32	H
7800.0	-50.39	5.38	3	13.58	-42.19	-25	17.19	H
5200.0	-40.37	4.41	3	12.34	-32.44	-25	7.44	V
7800.0	-42.44	5.38	3	13.58	-34.24	-25	9.24	V

LTE Band 41_Channel Bandwidth 20MHz_16QAM_1RB#0

Frequency (MHz)	Ps (dBm)	P _{cl} (dB)	Diatance	G _a Antenna Gain(dB)	Peak EIRP (dBm)	Limit (dBm)	Margin (dB)	Polarization
5290.0	-40.54	4.45	3	12.45	-32.54	-25	7.54	H
7935.0	-45.14	5.47	3	13.66	-36.95	-25	11.95	H
5290.0	-49.79	4.45	3	12.45	-41.79	-25	16.79	V
7935.0	-42.37	5.48	3	13.66	-34.19	-25	9.19	V

The results shown in this test report refer only to the sample(s) tested unless otherwise stated and the sample(s) are retained for 30 days only. The document is issued by HUAKE, this document cannot be reproduced except in full with our prior written permission. The more details and the authenticity of the report will be confirmed at <http://www.cer-mark.com>.



4.7 Frequency Stability

LIMIT

According to §2.1055 requirement, the frequency stability shall be sufficient to ensure that the fundamental emissions stay within the authorized bands of operation and should not exceed 2.5ppm.

TEST CONFIGURATION

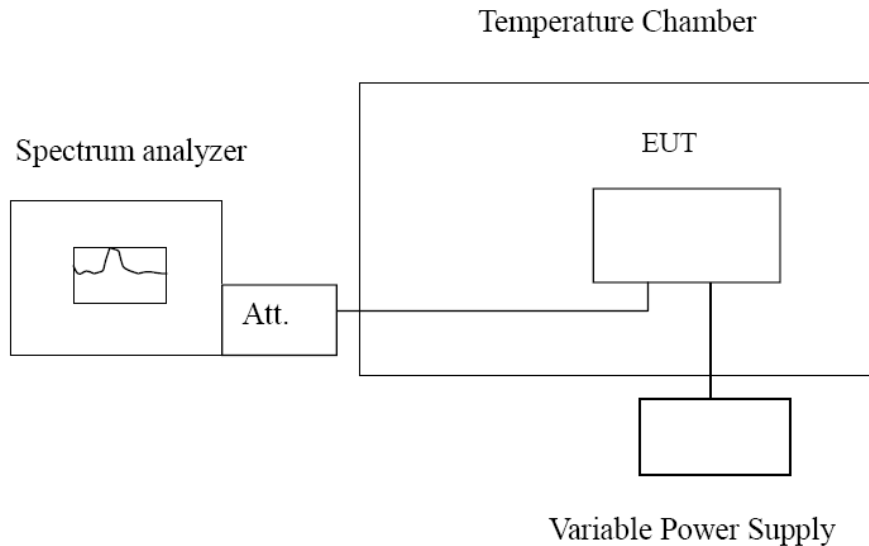

TEST PROCEDURE

The EUT was setup according to EIA/TIA 603D

Frequency Stability Under Temperature Variations:

In order to measure the carrier frequency under the condition of AFC lock, it is necessary to make measurements with the EUT in a “call mode”. This is accomplished with the use of R&S CMW500 DIGITAL RADIO COMMUNICATION TESTER.

1. Measure the carrier frequency at room temperature.
2. Subject the EUT to overnight soak at -30°C.
3. With the EUT, powered via nominal voltage, connected to the CMW500 and in a simulated call on middle channel for LTE band 41, measure the carrier frequency. These measurements should be made within 2 minutes of Powering up the EUT, to prevent significant self-warming.
4. Repeat the above measurements at 10°C increments from -30°C to +50°C. Allow at least 1.5 hours at each temperature, unpowered, before making measurements.
5. Re-measure carrier frequency at room temperature with nominal voltage. Vary supply voltage from minimum voltage to maximum voltage, in 0.1Volt increments re-measuring carrier frequency at each voltage. Pause at nominal voltage for 1.5 hours unpowered, to allow any self-heating to stabilize, before continuing.
6. Subject the EUT to overnight soak at +50°C.
7. With the EUT, powered via nominal voltage, connected to the CMW500 and in a simulated call on the centre channel, measure the carrier frequency. These measurements should be made within 2 minutes of Powering up the EUT, to prevent significant self-warming.
8. Repeat the above measurements at 10 °C increments from +50°C to -30°C. Allow at least 1.5 hours at each temperature, unpowered, before making measurements
9. At all temperature levels hold the temperature to +/- 0.5°C during the measurement procedure.

Frequency Stability Under Voltage Variations:

Set chamber temperature to 20°C. Use a variable AC power supply / DC power source to power the EUT and set the voltage to rated voltage. Set the spectrum analyzer RBW low enough to obtain the desired frequency resolution and recorded the frequency.

Reduce the input voltage to specify extreme voltage variation (±15%) and endpoint, record the maximum frequency change.



TEST RESULTS

EUT :	Smart POS Terminal	Test Date:	Nov. 12, 2021
Temperature:	25 ⁰ C	Tested by:	Gary Qian
Humidity:	55 % RH	Test Voltage	Normal Voltage
Operation Mode:	Normal Voltage- Tx Mode		

Remark:

1. We tested all RB Configuration refer 3GPP TS136 521 for each Channel Bandwidth of LTE Band 41; recorded worst case.

LTE Band 41_5MHz bandwidth_QPSK_1RB#0 (worst case of all bandwidths)

LTE Band 41					
DC Power	Temperature (°C)	Frequency error(Hz)	Frequency error(ppm)	Limit (ppm)	Verdict
3.27V	20	24.85	0.009707	2.50	PASS
3.85V	20	25.63	0.010012	2.50	PASS
4.43V	20	28.84	0.011266	2.50	PASS
3.85V	-30	10.41	0.004004	2.50	PASS
3.85V	-20	-19.58	-0.007531	2.50	PASS
3.85V	-10	-19.53	-0.007512	2.50	PASS
3.85V	0	-26.98	-0.010377	2.50	PASS
3.85V	10	-30.91	-0.011888	2.50	PASS
3.85V	20	-32.13	-0.012358	2.50	PASS
3.85V	30	-35.68	-0.013723	2.50	PASS
3.85V	40	-40.50	-0.015577	2.50	PASS
3.85V	50	-39.05	-0.015019	2.50	PASS

LTE Band 41_5MHz bandwidth_16QAM_1RB#0 (worst case of all bandwidths)

LTE Band 41					
DC Power	Temperature (°C)	Frequency error(Hz)	Frequency error(ppm)	Limit (ppm)	Verdict
3.27V	20	-34.36	-0.013215	2.50	PASS
3.85V	20	-35.88	-0.013800	2.50	PASS
4.43V	20	-27.55	-0.010596	2.50	PASS
3.85V	-30	-26.22	-0.010085	2.50	PASS
3.85V	-20	-28.45	-0.010942	2.50	PASS
3.85V	-10	-23.40	-0.009000	2.50	PASS
3.85V	0	-18.70	-0.007192	2.50	PASS
3.85V	10	-18.55	-0.007135	2.50	PASS
3.85V	20	-14.35	-0.005415	2.50	PASS
3.85V	30	-17.90	-0.006755	2.50	PASS
3.85V	40	-7.44	-0.002808	2.50	PASS
3.85V	50	-10.57	-0.003989	2.50	PASS

The results shown in this test report refer only to the sample(s) tested unless otherwise stated and the sample(s) are retained for 30 days only. The document is issued by HUAKE, this document cannot be reproduced except in full with our prior written permission. The more details and the authenticity of the report will be confirmed at <http://www.cer-mark.com>.



5 Test Setup Photos of the EUT

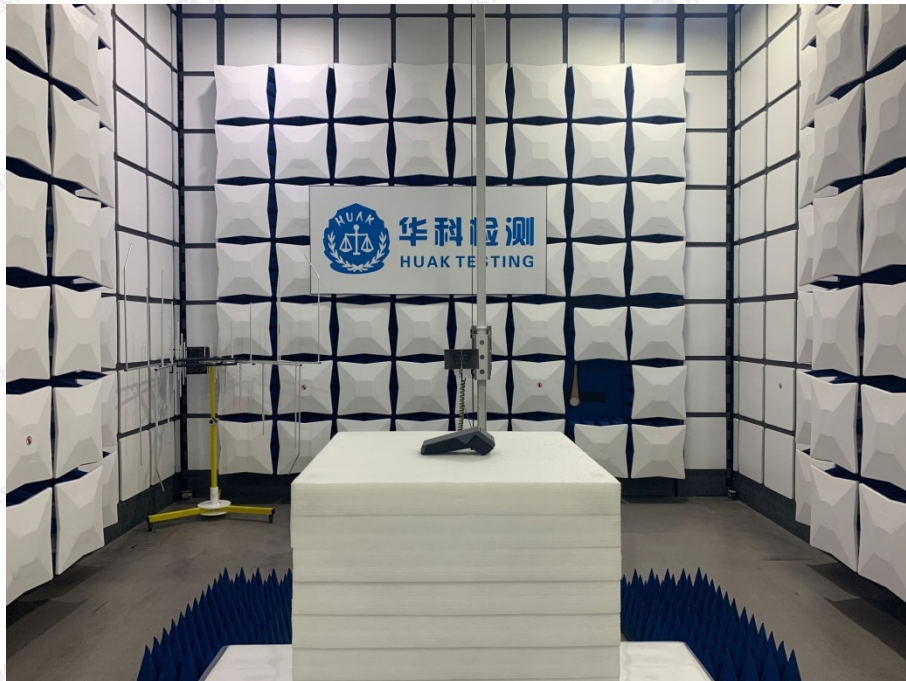
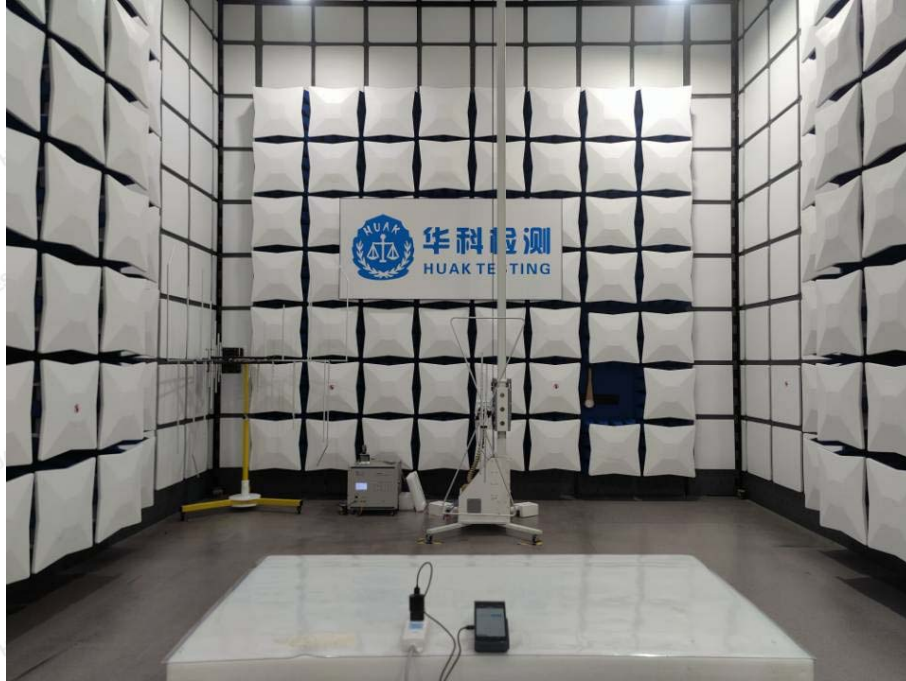

The results shown in this test report refer only to the sample(s) tested unless otherwise stated and the sample(s) are retained for 30 days only. The document is issued by HUAK, this document cannot be reproduced except in full with our prior written permission. The more details and the authenticity of the report will be confirmed at <http://www.cer-mark.com>.

HUAK Testing Lab TEL : +86-755 2302 9901 FAX : +86-755 2302 9901 E-mail : service@cer-mark.com

1-2/F., Building B2, Junfeng Zhongcheng Zhizao Innovation Park, Heping, Fuhai Street, Bao'an District, Shenzhen, Guangdong, China

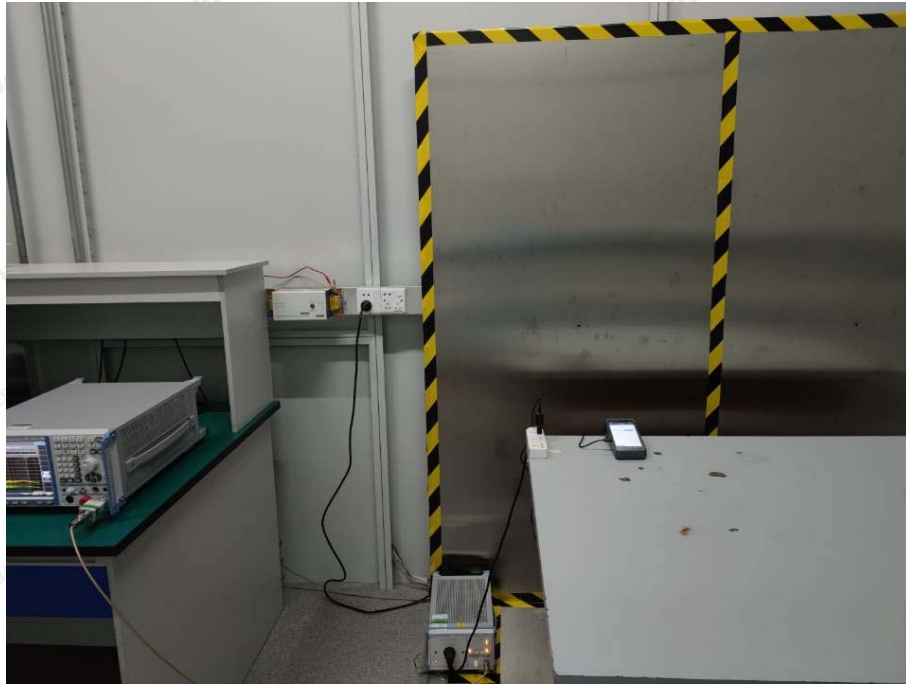

The results shown in this test report refer only to the sample(s) tested unless otherwise stated and the sample(s) are retained for 30 days only. The document is issued by HUAK, this document cannot be reproduced except in full with our prior written permission. The more details and the authenticity of the report will be confirmed at <http://www.cer-mark.com>.

HUAK Testing Lab TEL : +86-755 2302 9901 FAX : +86-755 2302 9901 E-mail : service@cer-mark.com

1-2/F., Building B2, Junfeng Zhongcheng Zhizao Innovation Park, Heping, Fuhai Street, Bao'an District, Shenzhen, Guangdong, China



6 External and Internal Photos of the EUT

Reference to the report :ANNEX A of external photos and ANNEX B of internal photos

*******End of Report*******