

FCC Test Report

Report No.: AGC02764180302FE04

FCC ID : 2ALJX-BD800
APPLICATION PURPOSE : Original Equipment
PRODUCT DESIGNATION : BD800
BRAND NAME : WK
MODEL NAME : BD800
CLIENT : Shenzhen WK Technology Co., Ltd
DATE OF ISSUE : Mar. 21, 2018
STANDARD(S) : FCC Part 15 Subpart C Section 15.247
REPORT VERSION : V1.0

Attestation of Global Compliance (Shenzhen) Co., Ltd

CAUTION:

This report shall not be reproduced except in full without the written permission of the test laboratory and shall not be quoted out of context.



The results shown in this test report refer only to the sample(s) tested unless otherwise stated and the sample(s) are retained for 30 days only. The document is issued by AGC, this document cannot be reproduced except in full with our prior written permission. The more details and the authenticity of the report will be confirmed at <http://www.agc-cert.com>.

Report Revise Record

Report Version	Revise Time	Issued Date	Valid Version	Notes
V1.0	/	Mar. 21, 2018	Valid	Initial release

The results shown in this test report refer only to the sample(s) tested unless otherwise stated and the sample(s) are retained for 30 days only. The document is issued by AGC, this document cannot be reproduced except in full with our prior written permission. The more details and the authenticity of the report will be confirmed at <http://www.agc-cert.com>.

TABLE OF CONTENTS

1. VERIFICATION OF CONFORMITY 5

2. GENERAL INFORMATION 6

2.1. PRODUCT DESCRIPTION 6

2.2. TABLE OF CARRIER FREQUENCIES 6

2.3. RECEIVER INPUT BANDWIDTH..... 7

2.4. EXAMPLE OF A HOPPING SEQUENCY IN DATA MODE 7

2.5. EQUALLY AVERAGE USE OF FREQUENCIES AND BEHAVIOUR..... 7

2.6. TEST METHOD 8

2.7. EQUIPMENT MODIFICATIONS..... 8

3. MEASUREMENT UNCERTAINTY 9

4. DESCRIPTION OF TEST MODES..... 10

5. SYSTEM TEST CONFIGURATION 12

5.1. CONFIGURATION OF EUT SYSTEM..... 12

5.2. EQUIPMENT USED IN EUT SYSTEM..... 12

5.3. SUMMARY OF TEST RESULTS..... 13

6. TEST FACILITY 14

7. TEST EQUIPMENT LIST 15

8. PEAK OUTPUT POWER 16

8.1. MEASUREMENT PROCEDURE..... 16

8.2. TEST SET-UP (BLOCK DIAGRAM OF CONFIGURATION) 16

8.3. LIMITS AND MEASUREMENT RESULT 17

9. BANDWIDTH 23

9.1. MEASUREMENT PROCEDURE..... 23

9.2. TEST SET-UP (BLOCK DIAGRAM OF CONFIGURATION) 23

9.3. LIMITS AND MEASUREMENT RESULTS..... 23

10. CONDUCTED SPURIOUS EMISSION 30

10.1. MEASUREMENT PROCEDURE..... 30

10.2. TEST SET-UP (BLOCK DIAGRAM OF CONFIGURATION) 30

10.3. LIMITS AND MEASUREMENT RESULT 30

The results shown in this test report refer only to the sample(s) tested unless otherwise stated and the sample(s) are retained for 30 days only. The document is issued by AGC, this document cannot be reproduced except in full with our prior written permission. The more details and the authenticity of the report will be confirmed at <http://www.agc-cert.com>.

11. RADIATED EMISSION	34
11.1. TEST LIMIT	34
11.2. MEASUREMENT PROCEDURE	34
11.3. TEST SETUP	36
11.4. TEST RESULT	38
12. BAND EDGE EMISSION	51
12.1. MEASUREMENT PROCEDURE	51
12.2. TEST SET-UP	51
12.3. TEST RESULT	52
13. NUMBER OF HOPPING FREQUENCY	56
13.1. MEASUREMENT PROCEDURE	56
13.2. TEST SETUP (BLOCK DIAGRAM OF CONFIGURATION)	56
13.3. LIMITS AND MEASUREMENT RESULT	56
14. TIME OF OCCUPANCY (DWELL TIME)	58
14.1. MEASUREMENT PROCEDURE	58
14.2. TEST SETUP (BLOCK DIAGRAM OF CONFIGURATION)	58
14.3. LIMITS AND MEASUREMENT RESULT	58
15. FREQUENCY SEPARATION	61
15.1. MEASUREMENT PROCEDURE	61
15.2. TEST SETUP (BLOCK DIAGRAM OF CONFIGURATION)	61
15.3. LIMITS AND MEASUREMENT RESULT	61
16. LINE CONDUCTED EMISSION TEST	63
16.1. LIMITS OF LINE CONDUCTED EMISSION TEST	63
16.2. BLOCK DIAGRAM OF LINE CONDUCTED EMISSION TEST	63
16.3. PRELIMINARY PROCEDURE OF LINE CONDUCTED EMISSION TEST	64
16.4. FINAL PROCEDURE OF LINE CONDUCTED EMISSION TEST	64
16.5. TEST RESULT OF LINE CONDUCTED EMISSION TEST	64
APPENDIX A: PHOTOGRAPHS OF TEST SETUP	65
APPENDIX B: PHOTOGRAPHS OF EUT	67

The results shown in this test report refer only to the sample(s) tested unless otherwise stated and the sample(s) are retained for 30 days only. The document is issued by AGC, this document cannot be reproduced except in full with our prior written permission. The more details and the authenticity of the report will be confirmed at <http://www.agc-cert.com>.

1. VERIFICATION OF CONFORMITY

Applicant	Shenzhen WK Technology Co., Ltd
Address	1F, A2 Building, Mingjun Industrial Park, Huarong Road. Longhua Area Shenzhen China.
Manufacturer	Shenzhen WK Technology Co., Ltd
Address	1F, A2 Building, Mingjun Industrial Park, Huarong Road. Longhua Area Shenzhen China.
Product Designation	BD800
Brand Name	WK
Test Model	BD800
Date of test	Mar. 12, 2018 to Mar. 19, 2018
Deviation	None
Condition of Test Sample	Normal
Report Template	AGCRT-US-BR/RF (2013-03-01)

We hereby certify that:

The above equipment was tested by Attestation of Global Compliance (Shenzhen) Co., Ltd. The test data, the energy emitted by the sample tested as described in this report is in compliance with the requirements of FCC Rules Part 15.247. The test results of this report relate only to the tested sample identified in this report.

Tested By

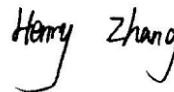

Henry Zhang(Zhang Zhuorui) Mar. 19, 2018

Reviewed By



Forrest Lei(Lei Yonggang) Mar. 21, 2018

The results shown in this test report refer only to the sample(s) tested unless otherwise stated and the sample(s) are retained for 30 days only. The document is issued by AGC, this document cannot be reproduced except in full with our prior written permission. The more details and the authenticity of the report will be confirmed at <http://www.agc-cert.com>.

2. GENERAL INFORMATION

2.1. PRODUCT DESCRIPTION

The EUT is "BD800" designed as a "Communication Device". It is designed by way of utilizing the FHSS technology to achieve the system operation.

A major technical description of EUT is described as following

Operation Frequency	2.402 GHz to 2.480GHz
RF Output Power	6.91dBm(Max)
Bluetooth Version	V4.2
Modulation	GFSK, $\pi/4$ -DQPSK, 8DPSK for BR/EDR
Number of channels	79
Hardware Version	A2
Software Version	V4.2
Antenna Designation	PCB Antenna
Antenna Gain	3.4dBi
Power Supply	DC3.7V by Battery

- Note: 1. The EUT comprises left and right channel earphone, both are the same and have been tested, only the test data of left earphone recorded in this report.
 2. The BT function of EUT didn't work when charging.
 3. The EUT didn't support BLE.

2.2. TABLE OF CARRIER FREQUENCIES

Frequency Band	Channel Number	Frequency
2402~2480MHz	0	2402MHz
	1	2403MHz
	:	:
	38	2440 MHz
	39	2441 MHz
	40	2442 MHz
	:	:
	77	2479 MHz
	78	2480 MHz

The results shown in this test report refer only to the sample(s) tested unless otherwise stated and the sample(s) are retained for 30 days only. The document is issued by AGC, this document cannot be reproduced except in full with our prior written permission. The more details and the authenticity of the report will be confirmed at <http://www.agc-cert.com>.

2.3. RECEIVER INPUT BANDWIDTH

The input bandwidth of the receiver is 1.3MHz, In every connection one Bluetooth device is the master and the other one is slave. The master determines the hopping sequence. The slave follows this sequence. Both devices shift between RX and TX time slot according to the clock of the master. Additionally the type of connection (e.g. single or multislotted packet) is set up at the beginning of the connection. The master adapts its hopping frequency and its TX/RX timing according to the packet type of the connection. Also the slave of the connection will use these settings.

Repeating of a packet has no influence on the hopping sequence. The hopping sequence generated by the master of the connection will be followed in any case. That means, a repeated packet will not be sent on the same frequency, it is sent on the next frequency of the hopping sequence.

2.4. EXAMPLE OF A HOPPING SEQUENCE IN DATA MODE

Example of a 79 hopping sequence in data mode:

40,21,44,23,42,53,46,55,48,33,52,35,50,65,54,67
56,37,60,39,58,69,62,71,64,25,68,27,66,57,70,59
72,29,76,31,74,61,78,63,01,41,05,43,03,73,07,75
09,45,13,47,11,77,15,00,64,49,66,53,68,02,70,06
01, 51, 03, 55, 05, 04

2.5. EQUALLY AVERAGE USE OF FREQUENCIES AND BEHAVIOUR

The generation of the hopping sequence in connection mode depends essentially on two input values:

1. LAP/UAP of the master of the connection.
2. Internal master clock

The LAP (lower address part) are the 24 LSB's of the 48 BD_ADDRESS. The BD_ADDRESS is an unambiguous number of every Bluetooth unit. The UAP (upper address part) are the 24 MSB's of the 48 BD_ADDRESS

The internal clock of a Bluetooth unit is derived from a free running clock which is never adjusted and is never turned off. For synchronization with other units only offset are used. It has no relation to the time of the day. Its resolution is at least half the RX/TX slot length of 312.5us. The clock has a cycle of about one day (23h30). In most cases it is implemented as 28 bit counter. For the deriving of the hopping sequence the entire LAP (24 bits), 4 LSB's (4 bits) (Input 1) and the 27 MSB's of the clock (Input 2) are used. With this input values different mathematical procedures (permutations, additions, XOR-operations) are performed to generate the sequence. This will be done at the beginning of every new transmission.

Regarding short transmissions the Bluetooth system has the following behavior:

The first connection between the two devices is established, a hopping sequence was generated. For transmitting the wanted data the complete hopping sequence was not used. The connection ended.

The second connection will be established. A new hopping sequence is generated. Due to the fact the Bluetooth clock has a different value, because the period between the two transmissions is longer (and it cannot be shorter) than the minimum resolution of the clock (312.5us). The hopping sequence will always differ from the first one.

2.6. TEST METHOD

All measurements contained in this report were conducted with ANSI C63.10-2013.

2.7. EQUIPMENT MODIFICATIONS

Not available for this EUT intended for grant.

The results shown in this test report refer only to the sample(s) tested unless otherwise stated and the sample(s) are retained for 30 days only. The document is issued by AGC, this document cannot be reproduced except in full with our prior written permission. The more details and the authenticity of the report will be confirmed at <http://www.agc-cert.com>.

3. MEASUREMENT UNCERTAINTY

The reported uncertainty of measurement $y \pm U$, where expanded uncertainty U is based on a standard uncertainty multiplied by a coverage factor of $k=2$, providing a level of confidence of approximately 95 %

- Uncertainty of Conducted Emission, $U_c = \pm 3.2$ dB
- Uncertainty of Radiated Emission below 1GHz, $U_c = \pm 3.9$ dB
- Uncertainty of Radiated Emission above 1GHz, $U_c = \pm 4.8$ dB

The results shown in this test report refer only to the sample(s) tested and unless otherwise stated and the sample(s) are retained for 30 days only. The document is issued by AGC, this document cannot be reproduced except in full with our prior written permission. The more details and the authenticity of the report will be confirmed at <http://www.agc-cert.com>.

4. DESCRIPTION OF TEST MODES

NO.	TEST MODE DESCRIPTION
1	Low channel GFSK
2	Middle channel GFSK
3	High channel GFSK
4	Low channel $\pi/4$ -DQPSK
5	Middle channel $\pi/4$ -DQPSK
6	High channel $\pi/4$ -DQPSK
7	Low channel 8DPSK
8	Middle channel 8DPSK
9	High channel 8DPSK
10	BT Link

Note:

1. Only the result of the worst case was recorded in the report, if no other cases.
2. For Radiated Emission, 3axis were chosen for testing for each applicable mode.
3. The EUT used fully-charged battery when tested.

The results shown in this test report refer only to the sample(s) tested unless otherwise stated and the sample(s) are retained for 30 days only. The document is issued by AGC, this document cannot be reproduced except in full with our prior written permission. The more details and the authenticity of the report will be confirmed at <http://www.agc-cert.com>.

Software Setting

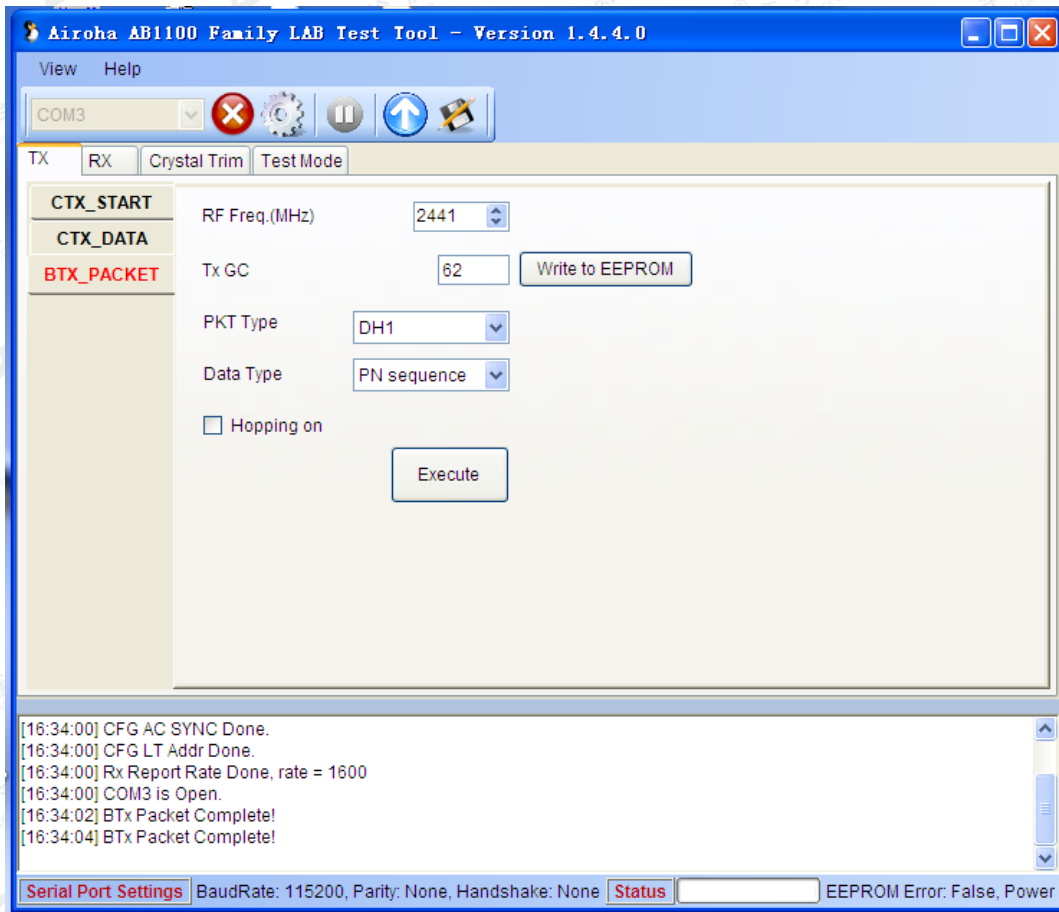

The results shown in this test report refer only to the sample(s) tested and unless otherwise stated and the sample(s) are retained for 30 days only. The document is issued by AGC, this document cannot be reproduced except in full with our prior written permission. The more details and the authenticity of the report will be confirmed at <http://www.agc-cert.com>.

5. SYSTEM TEST CONFIGURATION

5.1. CONFIGURATION OF EUT SYSTEM

Configure 1: (Normal hopping)

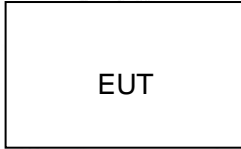

Configure 2: (Control continuous TX)

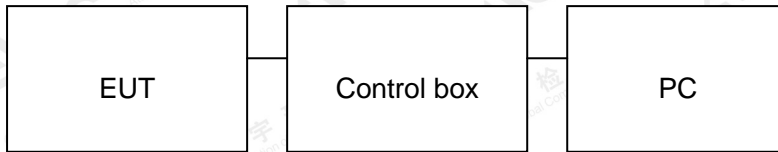

5.2. EQUIPMENT USED IN EUT SYSTEM

Item	Equipment	Mfr/Brand	Model/Type No.	Remark
1	BD800	WK	BD800	EUT
2	Battery	JYZ	501215	Accessory
3	PC	APPLE	A1465	A.E
4	Control box	AIROHA	N/A	A.E
5	Temporary Antenna	T10	N/A	A.E

The results shown in this test report refer only to the sample(s) tested unless otherwise stated and the sample(s) are retained for 30 days only. The document is issued by AGC, this document cannot be reproduced except in full with our prior written permission. The more details and the authenticity of the report will be confirmed at <http://www.agc-cert.com>.

5.3. SUMMARY OF TEST RESULTS

FCC RULES	DESCRIPTION OF TEST	RESULT
§15.247 b(1)	Peak Output Power	Compliant
§15.247 a(1)	20 dB Bandwidth	Compliant
§15.247 d	Conducted Spurious Emission	Compliant
§15.247 d §15.209	Radiated Emission	Compliant
§15.247 d	Band Edges	Compliant
§15.247 a(1)(iii)	Number of hopping frequency	Compliant
§15.247 a(1)(iii)	Time of Occupancy	Compliant
§15.247 a(1)	Frequency Separation	Compliant
§15.207	Line conduction Emission	N/A

Note: N/A means it's not applicable to this item.

The results shown in this test report refer only to the sample(s) tested unless otherwise stated and the sample(s) are retained for 30 days only. The document is issued by AGC, this document cannot be reproduced except in full with our prior written permission. The more details and the authenticity of the report will be confirmed at <http://www.agc-cert.com>.

6. TEST FACILITY

Test Site	Attestation of Global Compliance (Shenzhen) Co., Ltd
Location	1-2F., Bldg.2, No.1-4, Chaxi Sanwei Technical Industrial Park, Gushu, Xixiang, Bao'an District B112-B113, Bldg.12, Baoan Bldg Materials Center, No.1 of Xixiang Inner Ring Road, Baoan District, Shenzhen 518012
NVLAP Lab Code	600153-0
Designation Number	CN5028
Test Firm Registration Number	682566
Description	Attestation of Global Compliance(Shenzhen) Co., Ltd is accredited by National Voluntary Laboratory Accreditation program, NVLAP Code 600153-0

The results shown in this test report refer only to the sample(s) tested unless otherwise stated and the sample(s) are retained for 30 days only. The document is issued by AGC, this document cannot be reproduced except in full with our prior written permission. The more details and the authenticity of the report will be confirmed at <http://www.agc-cert.com>.

7. TEST EQUIPMENT LIST

TEST EQUIPMENT OF RADIATED EMISSION TEST

Equipment	Manufacturer	Model	S/N	Cal. Date	Cal. Due
TEST RECEIVER	R&S	ESCI	10096	Jun.20, 2017	Jun.19, 2018
EXA Signal Analyzer	Aglient	N9010A	MY53470504	Dec.08, 2017	Dec.07, 2018
Horn antenna	SCHWARZBECK	BBHA 9170	#768	Sep.20, 2017	Sep.19, 2018
preamplifier	ChengYi	EMC184045SE	980508	Sep.15, 2017	Sep.14, 2018
Double-Ridged Waveguide Horn	ETS LINDGREN	3117	00034609	May 18, 2017	May 17, 2019
Broadband Preamplifier	SCHWARZBECK	BBV 9718	9718-205	Jun.20, 2017	Jun.19, 2018
ANTENNA	SCHWARZBECK	VULB9168	D69250	Sep.28, 2017	Sep.27, 2018
Loop Antenna	A.H.Systems,Inc	SAS-562B	--	Mar. 01, 2018	Feb. 28, 2020

The results shown in this test report refer only to the sample(s) tested unless otherwise stated and the sample(s) are retained for 30 days only. The document is issued by AGC, this document cannot be reproduced except in full with our prior written permission. The more details and the authenticity of the report will be confirmed at <http://www.agc-cert.com>.

8. PEAK OUTPUT POWER

8.1. MEASUREMENT PROCEDURE

For peak power test:

1. Connect EUT RF output port to the Spectrum Analyzer through an RF attenuator
2. Set the EUT Work on the top, middle and the bottom operation frequency individually.
3. RBW > the 20 dB bandwidth of the emission being measured, VBW ≥ RBW.
4. Record the maximum power from the Spectrum Analyzer.
5. The maximum peak power shall be less 21dBm.

8.2. TEST SET-UP (BLOCK DIAGRAM OF CONFIGURATION)

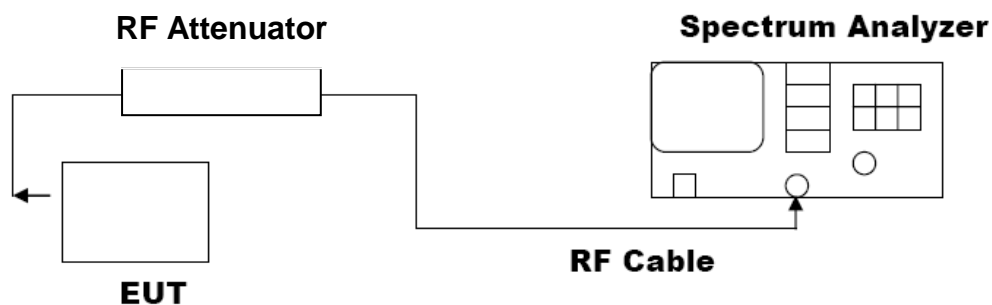

The results shown in this test report refer only to the sample(s) tested unless otherwise stated and the sample(s) are retained for 30 days only. The document is issued by AGC, this document cannot be reproduced except in full with our prior written permission. The more details and the authenticity of the report will be confirmed at <http://www.agc-cert.com>.

8.3. LIMITS AND MEASUREMENT RESULT

PEAK OUTPUT POWER MEASUREMENT RESULT FOR GFSK MODULATION			
Frequency (GHz)	Peak Power (dBm)	Applicable Limits (dBm)	Pass or Fail
2.402	5.39	21	Pass
2.441	4.99	21	Pass
2.480	4.32	21	Pass

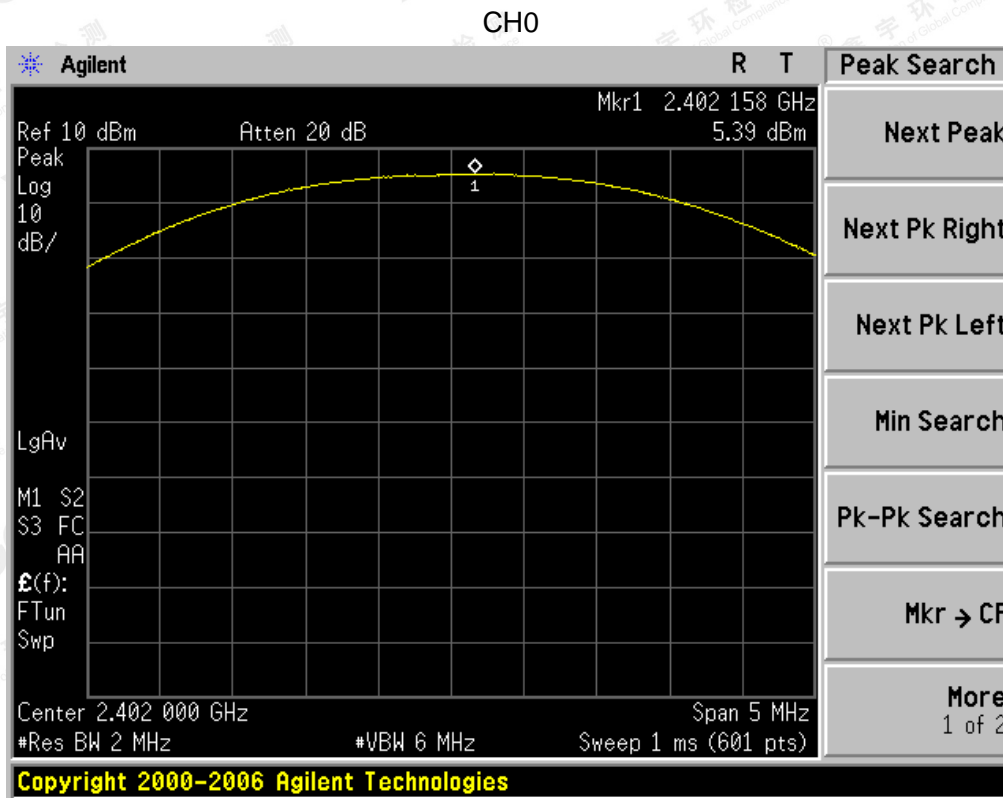

The results shown in this test report refer only to the sample(s) tested unless otherwise stated and the sample(s) are retained for 30 days only. The document is issued by AGC, this document cannot be reproduced except in full with our prior written permission. The more details and the authenticity of the report will be confirmed at <http://www.agc-cert.com>.

CH39

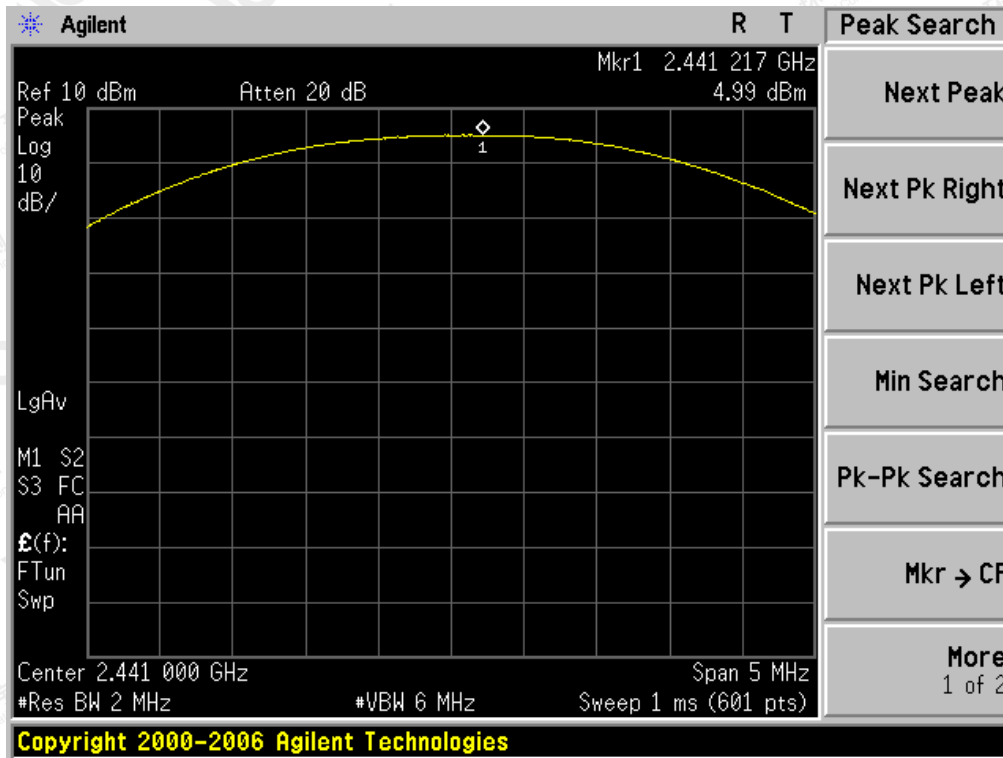

CH78

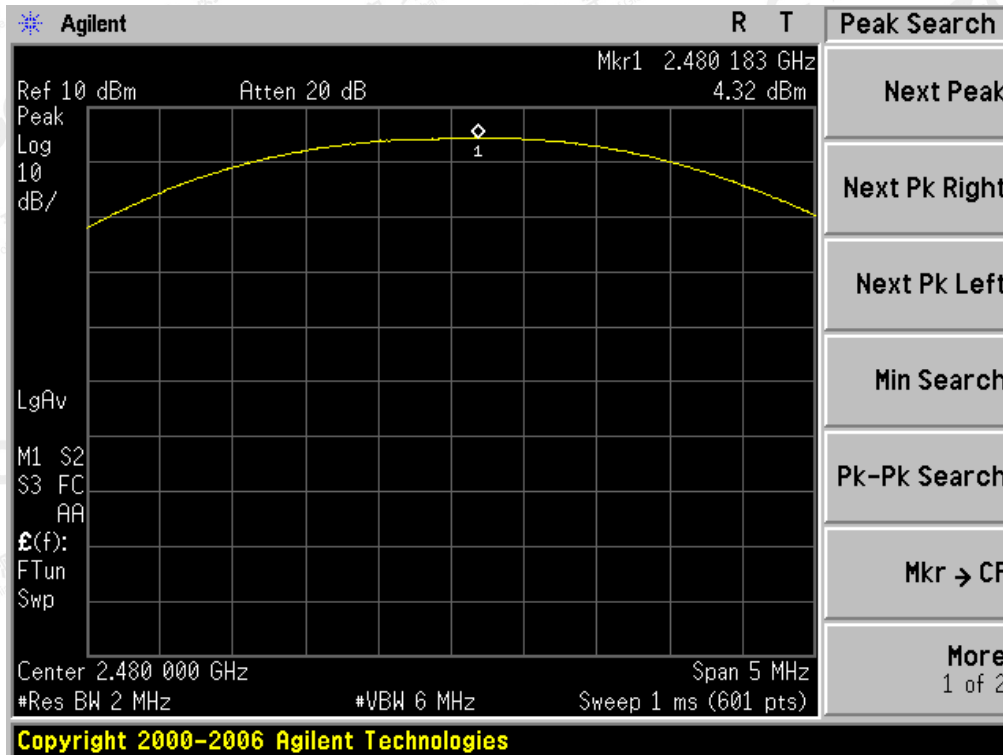

The results shown in this test report refer only to the sample(s) tested unless otherwise stated and the sample(s) are retained for 30 days only. The document is issued by AGC, this document cannot be reproduced except in full with our prior written permission. The more details and the authenticity of the report will be confirmed at <http://www.agc-cert.com>.

PEAK OUTPUT POWER MEASUREMENT RESULT FOR $\Pi/4$ -DQPSK MODULATION			
Frequency (GHz)	Peak Power (dBm)	Applicable Limits (dBm)	Pass or Fail
2.402	6.74	21	Pass
2.441	6.47	21	Pass
2.480	5.68	21	Pass

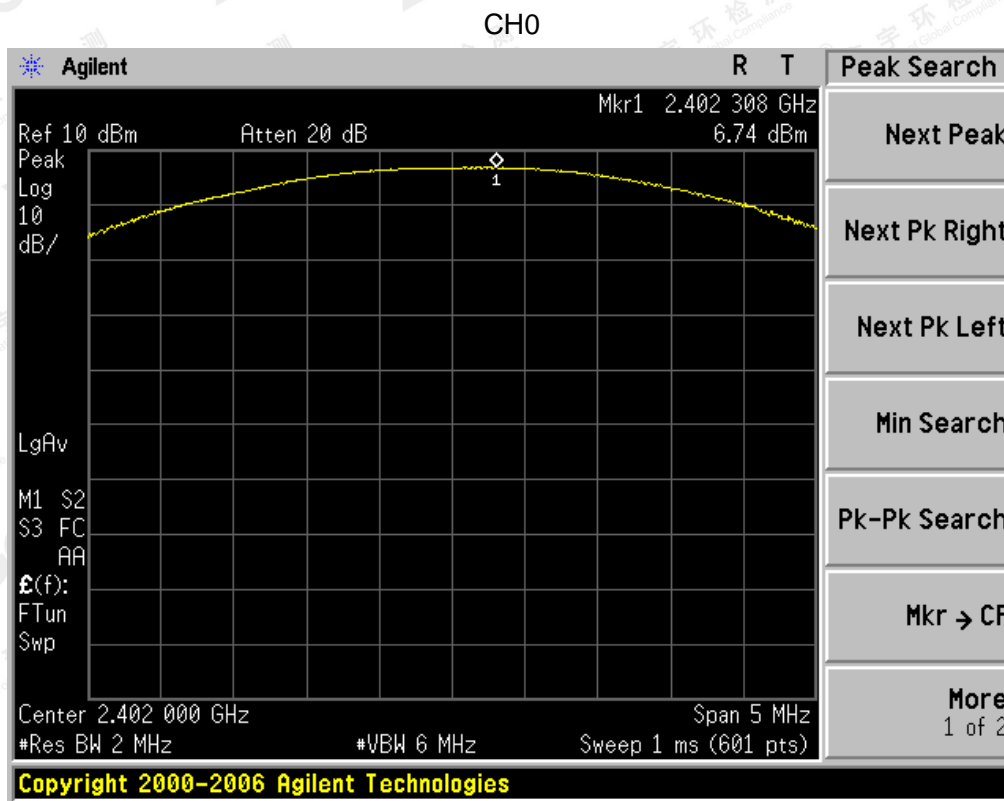

The results shown in this test report refer only to the sample(s) tested unless otherwise stated and the sample(s) are retained for 30 days only. The document is issued by AGC, this document cannot be reproduced except in full with our prior written permission. The more details and the authenticity of the report will be confirmed at <http://www.agc-cert.com>.

CH39

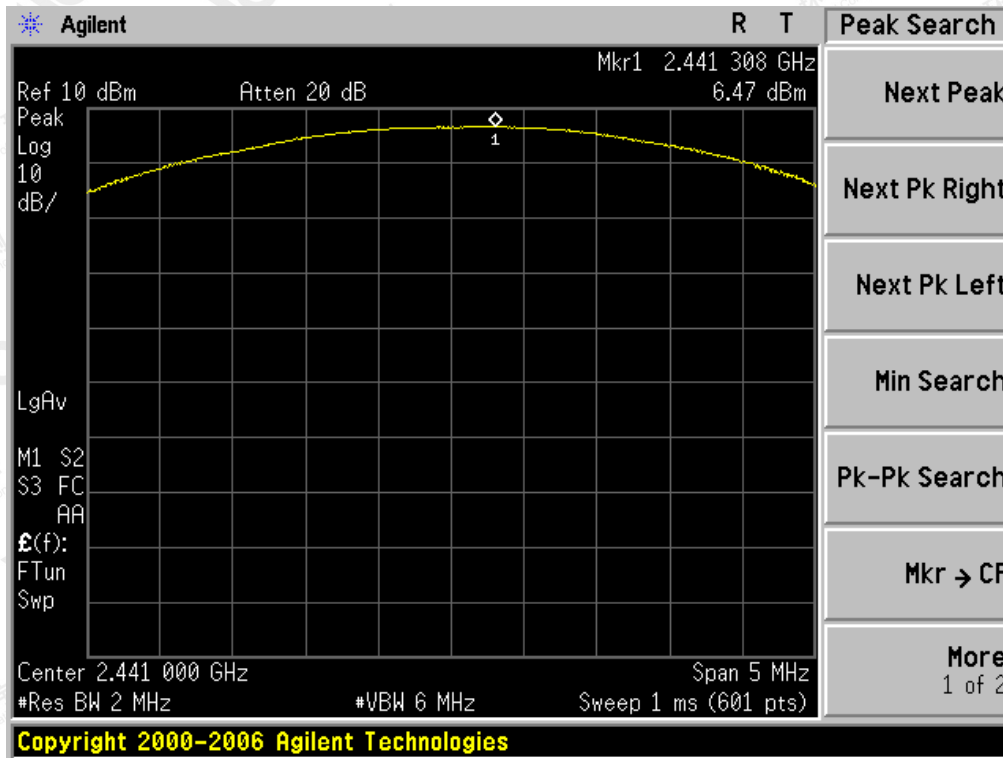

CH78

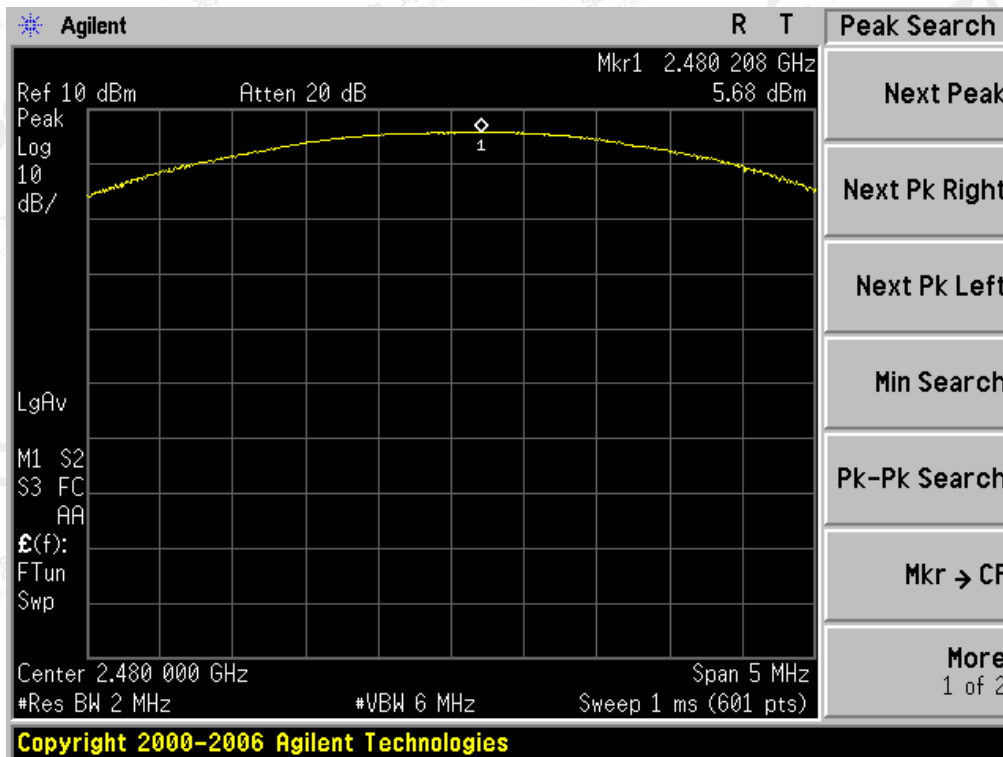

The results shown in this test report refer only to the sample(s) tested unless otherwise stated and the sample(s) are retained for 30 days only. The document is issued by AGC, this document cannot be reproduced except in full with our prior written permission. The more details and the authenticity of the report will be confirmed at <http://www.agc-cert.com>.

PEAK OUTPUT POWER MEASUREMENT RESULT FOR 8-DPSK MODULATION			
Frequency (GHz)	Peak Power (dBm)	Applicable Limits (dBm)	Pass or Fail
2.402	6.91	21	Pass
2.441	6.63	21	Pass
2.480	5.77	21	Pass

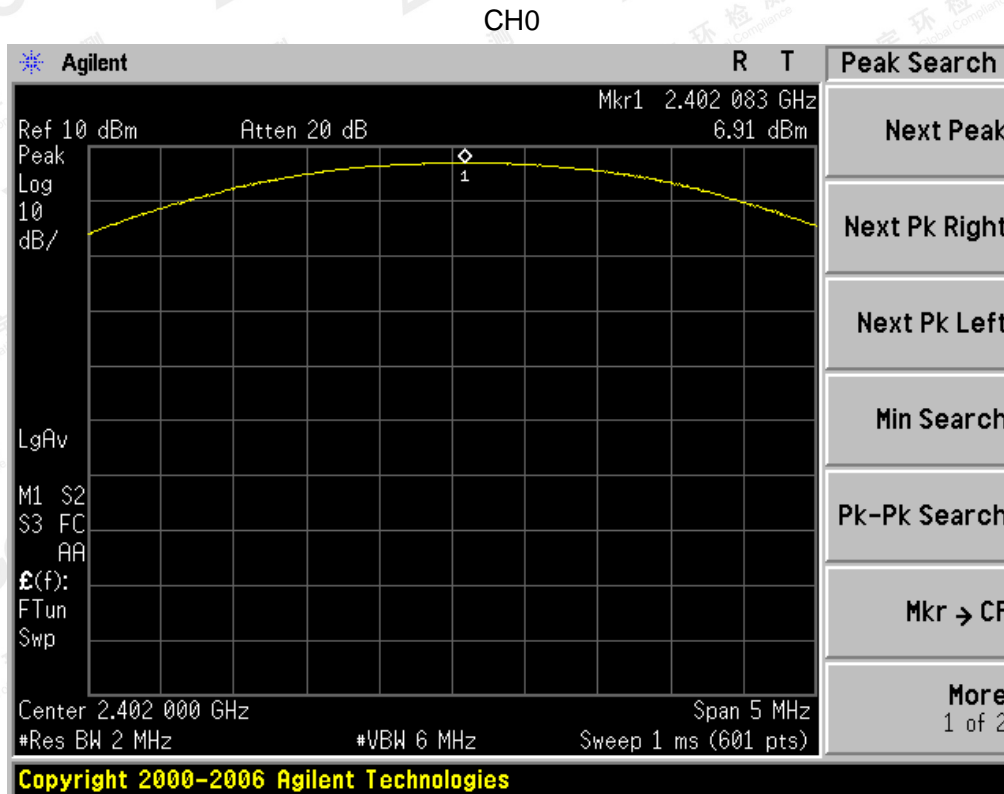

The results shown in this test report refer only to the sample(s) tested unless otherwise stated and the sample(s) are retained for 30 days only. The document is issued by AGC, this document cannot be reproduced except in full with our prior written permission. The more details and the authenticity of the report will be confirmed at <http://www.agc-cert.com>.

CH39

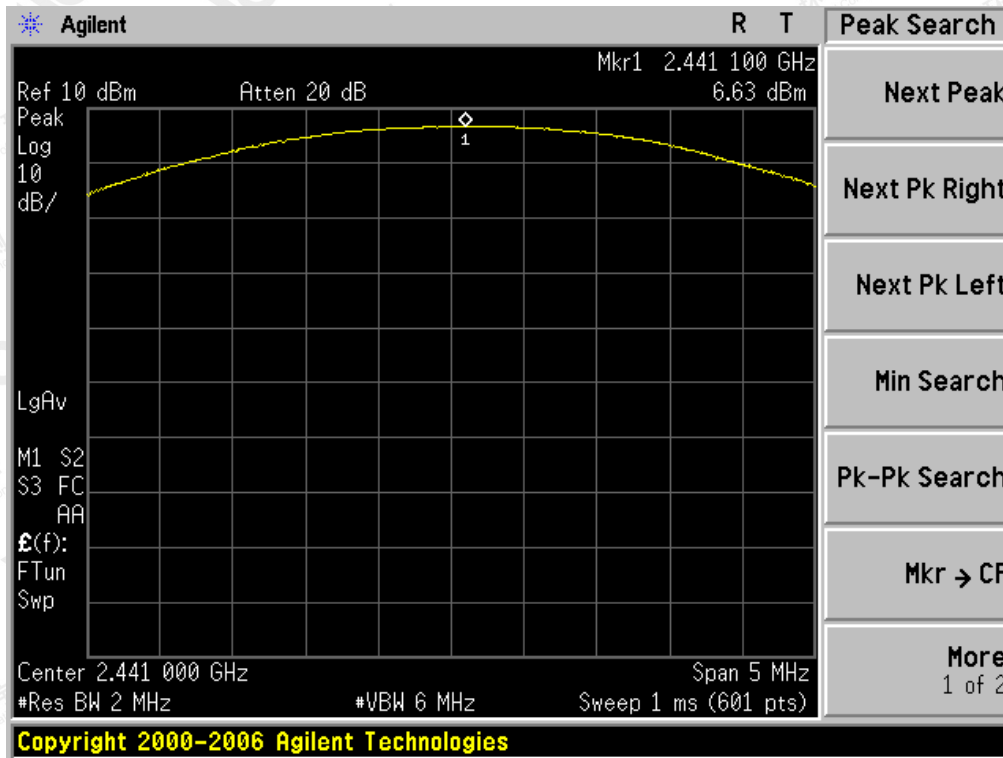

CH78

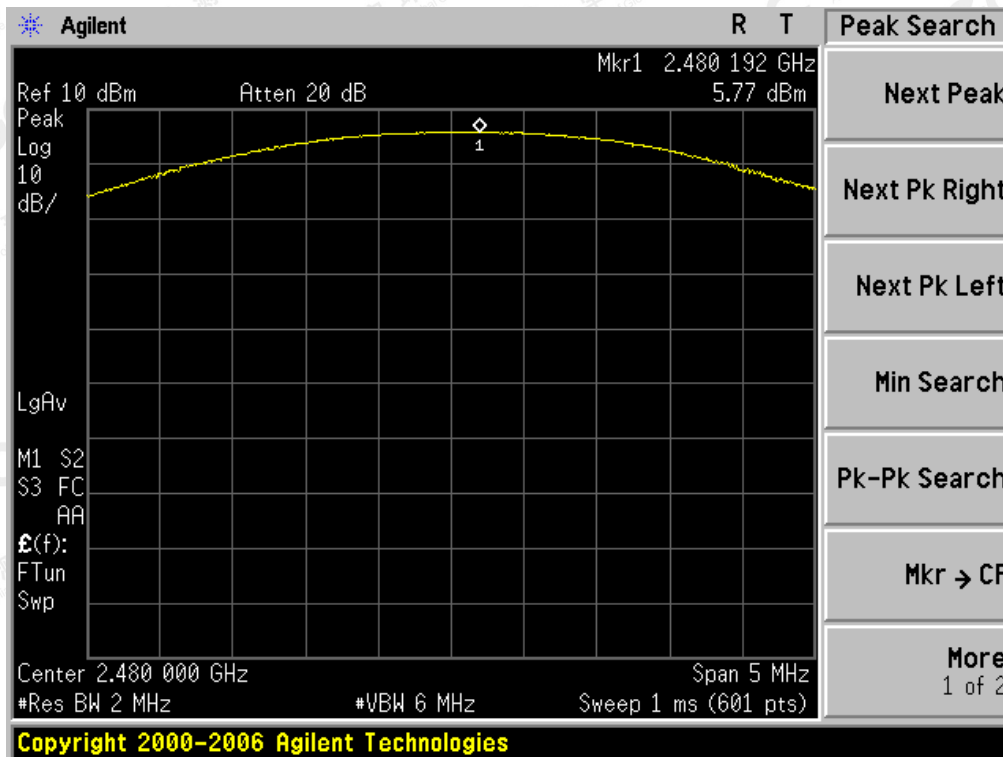

The results shown in this test report refer only to the sample(s) tested unless otherwise stated and the sample(s) are retained for 30 days only. The document is issued by AGC, this document cannot be reproduced except in full with our prior written permission. The more details and the authenticity of the report will be confirmed at <http://www.agc-cert.com>.

9. BANDWIDTH

9.1. MEASUREMENT PROCEDURE

1. Connect EUT RF output port to the Spectrum Analyzer through an RF attenuator
2. Set the EUT Work on the top, the middle and the bottom operation frequency individually.
3. Set Span = approximately 2 to 3 times the 20 dB bandwidth, centered on a hoping channel
RBW \geq 1% of the 20 dB bandwidth, VBW \geq 3RBW; Sweep = auto; Detector function = peak
4. Set SPA Trace 1 Max hold, then View.

9.2. TEST SET-UP (BLOCK DIAGRAM OF CONFIGURATION)

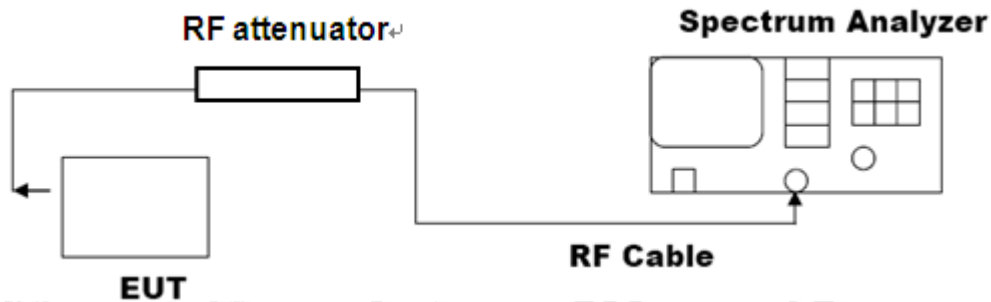

Note: The EUT has been used temporary antenna connector for testing.

9.3. LIMITS AND MEASUREMENT RESULTS

BLUETOOTH 1MBPS LIMITS AND MEASUREMENT RESULT				
Applicable Limits	Measurement Result			
	Test Data (MHz)			Result
		99%OBW (MHz)	-20dB BW(MHz)	
N/A	Low Channel	1.106	1.590	PASS
	Middle Channel	1.133	1.576	PASS
	High Channel	1.432	1.606	PASS

The results shown in this test report refer only to the sample(s) tested unless otherwise stated and the sample(s) are retained for 30 days only. The document is issued by AGC, this document cannot be reproduced except in full with our prior written permission. The more details and the authenticity of the report will be confirmed at <http://www.agc-cert.com>.

TEST PLOT OF BANDWIDTH FOR LOW CHANNEL

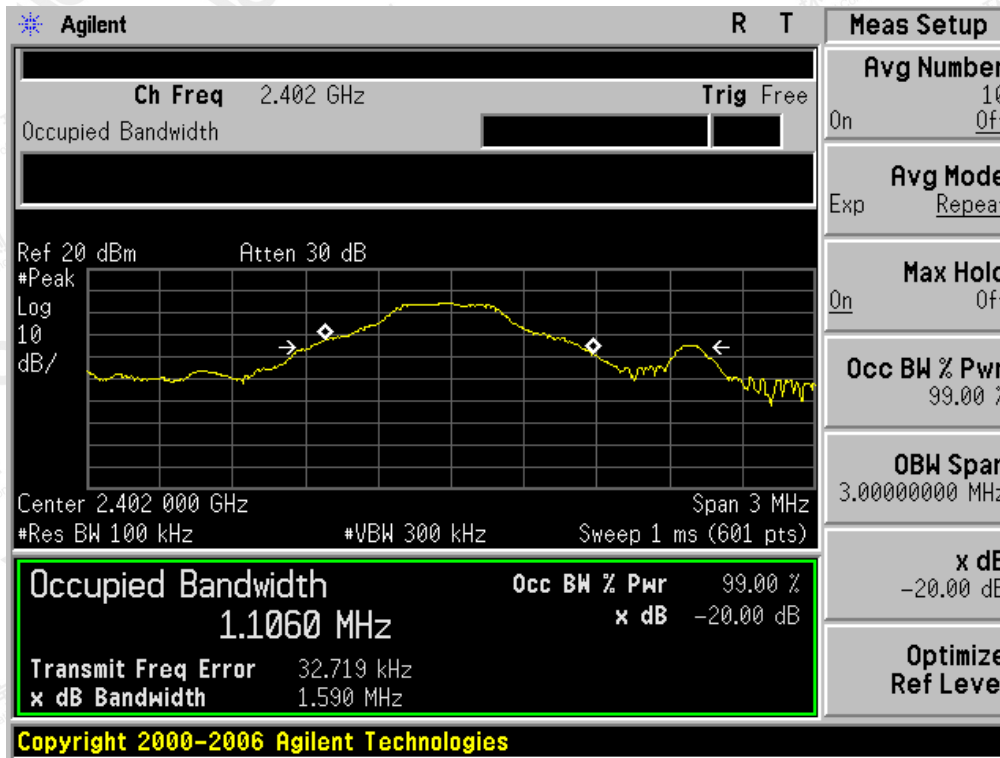

TEST PLOT OF BANDWIDTH FOR MIDDLE CHANNEL

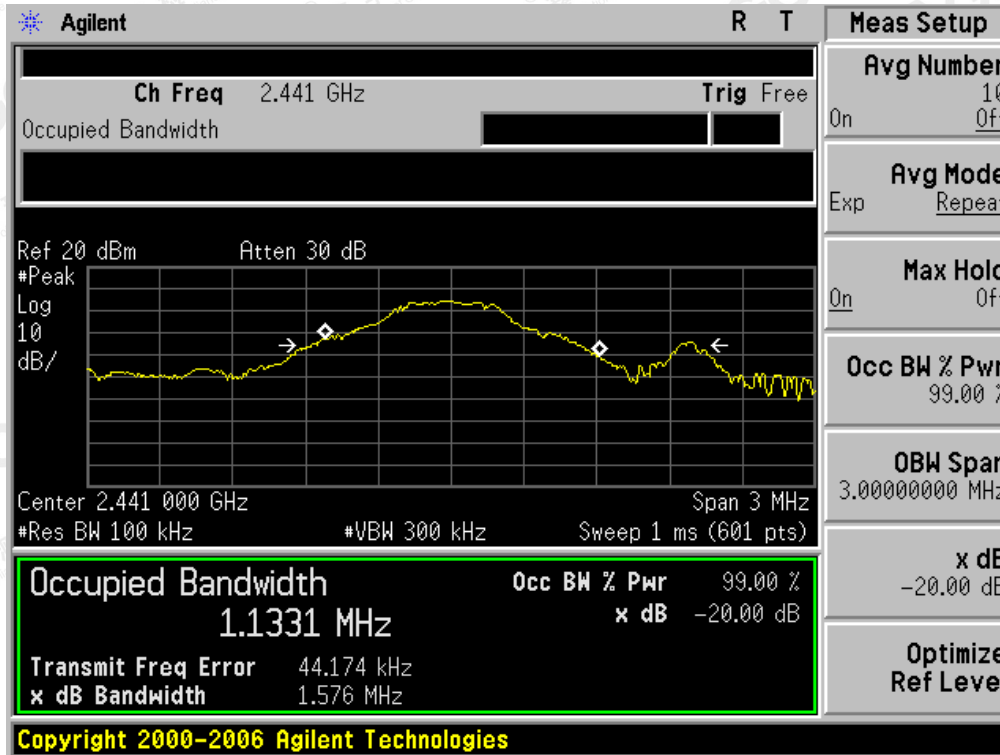

The results shown in this test report refer only to the sample(s) tested unless otherwise stated and the sample(s) are retained for 30 days only. The document is issued by AGC, this document cannot be reproduced except in full with our prior written permission. The more details and the authenticity of the report will be confirmed at <http://www.agc-cert.com>.

TEST PLOT OF BANDWIDTH FOR HIGH CHANNEL

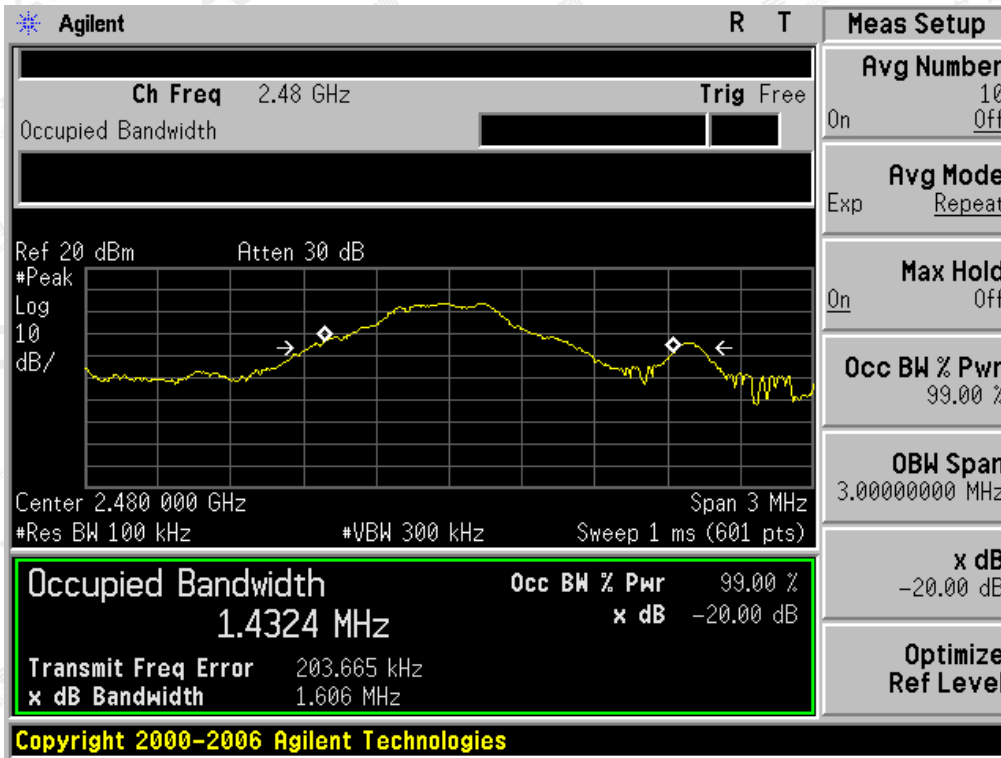

The results shown in this test report refer only to the sample(s) tested unless otherwise stated and the sample(s) are retained for 30 days only. The document is issued by AGC, this document cannot be reproduced except in full with our prior written permission. The more details and the authenticity of the report will be confirmed at <http://www.agc-cert.com>.

BLUETOOTH 2MBPS LIMITS AND MEASUREMENT RESULT				
Applicable Limits	Measurement Result			
		Test Data (MHz)		Result
		99%OBW (MHz)	-20dB BW(MHz)	
N/A	Low Channel	1.401	1.680	PASS
	Middle Channel	1.593	1.735	PASS
	High Channel	1.679	1.745	PASS

TEST PLOT OF BANDWIDTH FOR LOW CHANNEL

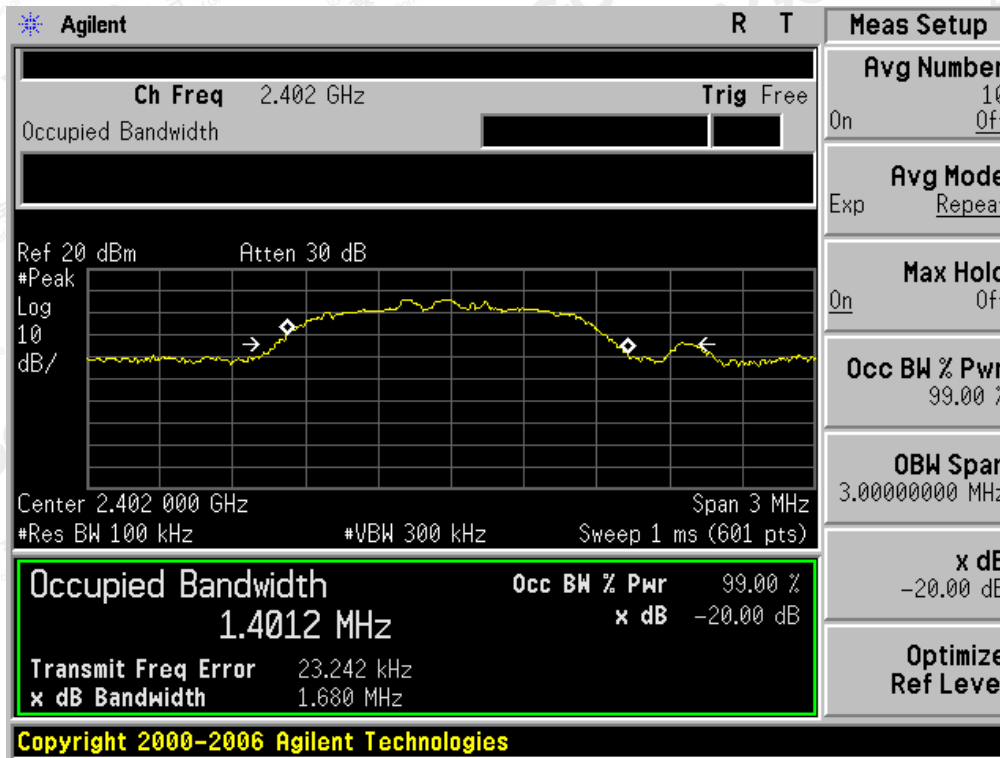

The results shown in this test report refer only to the sample(s) tested unless otherwise stated and the sample(s) are retained for 30 days only. The document is issued by AGC, this document cannot be reproduced except in full with our prior written permission. The more details and the authenticity of the report will be confirmed at <http://www.agc-cert.com>.

TEST PLOT OF BANDWIDTH FOR MIDDLE CHANNEL

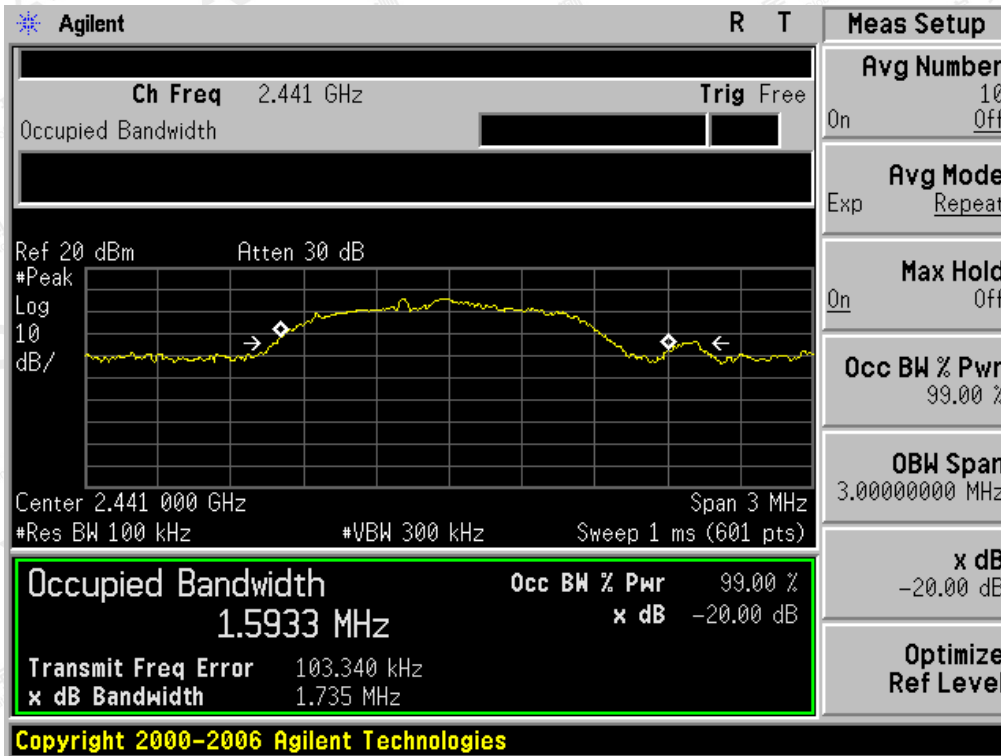

TEST PLOT OF BANDWIDTH FOR HIGH CHANNEL

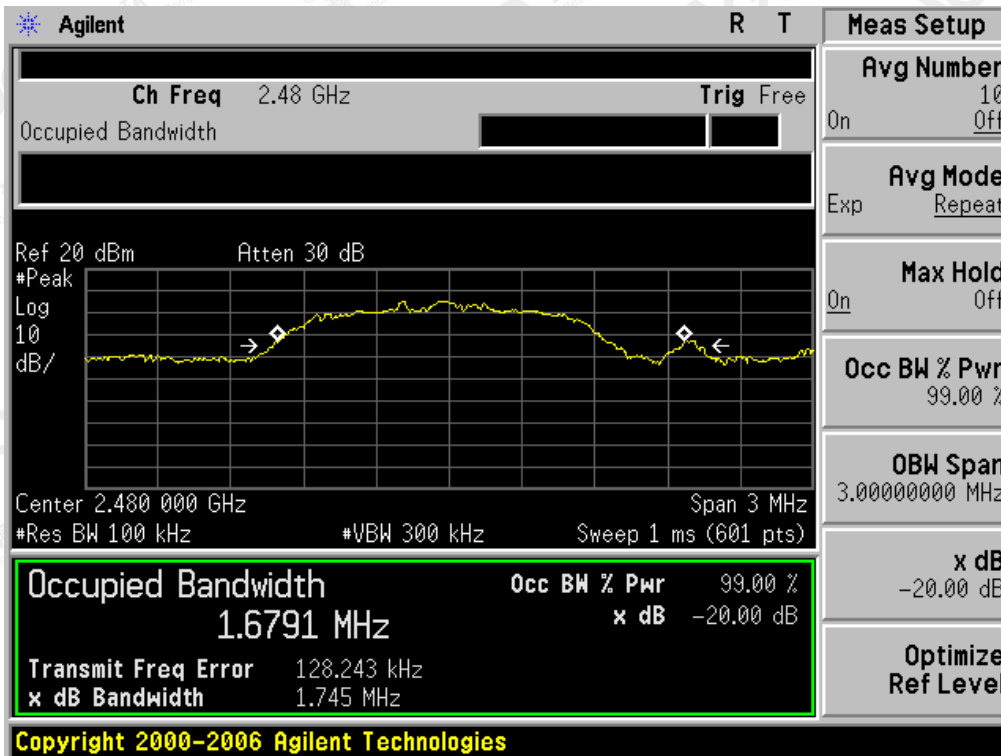

The results shown in this test report refer only to the sample(s) tested unless otherwise stated and the sample(s) are retained for 30 days only. The document is issued by AGC, this document cannot be reproduced except in full with our prior written permission. The more details and the authenticity of the report will be confirmed at <http://www.agc-cert.com>.

BLUETOOTH 3MBPS LIMITS AND MEASUREMENT RESULT				
Applicable Limits	Measurement Result			
		Test Data (MHz)		Result
		99%OBW (MHz)	-20dB BW(MHz)	
N/A	Low Channel	1.475	1.710	PASS
	Middle Channel	1.570	1.740	PASS
	High Channel	1.681	1.755	PASS

TEST PLOT OF BANDWIDTH FOR LOW CHANNEL



The results shown in this test report refer only to the sample(s) tested unless otherwise stated and the sample(s) are retained for 30 days only. The document is issued by AGC, this document cannot be reproduced except in full with our prior written permission. The more details and the authenticity of the report will be confirmed at <http://www.agc-cert.com>.

TEST PLOT OF BANDWIDTH FOR MIDDLE CHANNEL

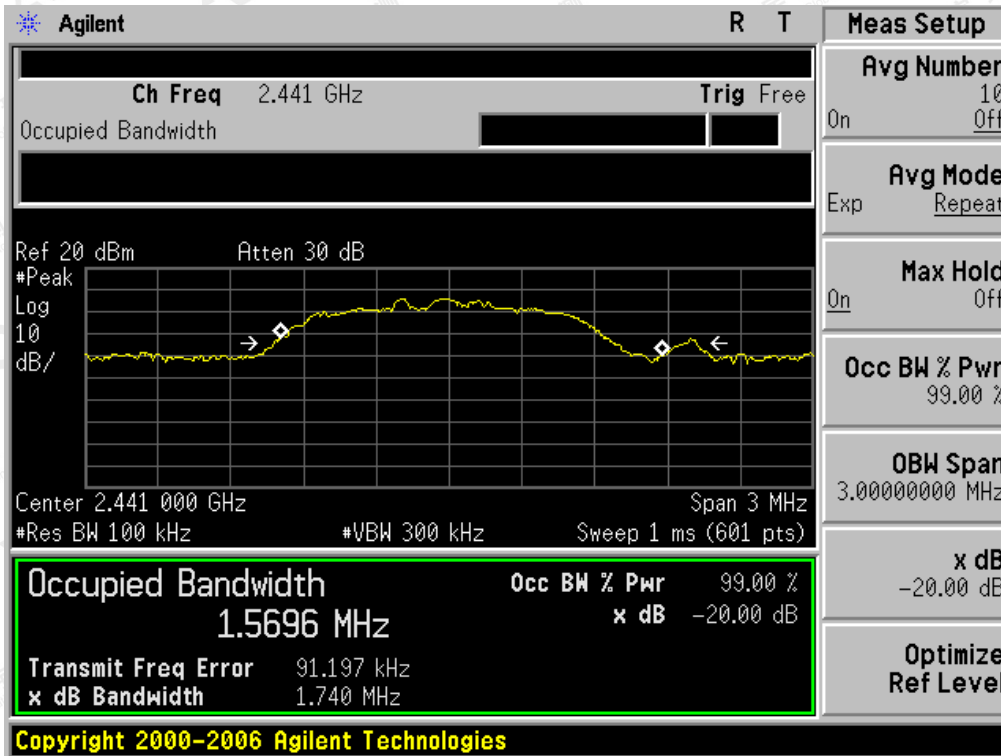

TEST PLOT OF BANDWIDTH FOR HIGH CHANNEL

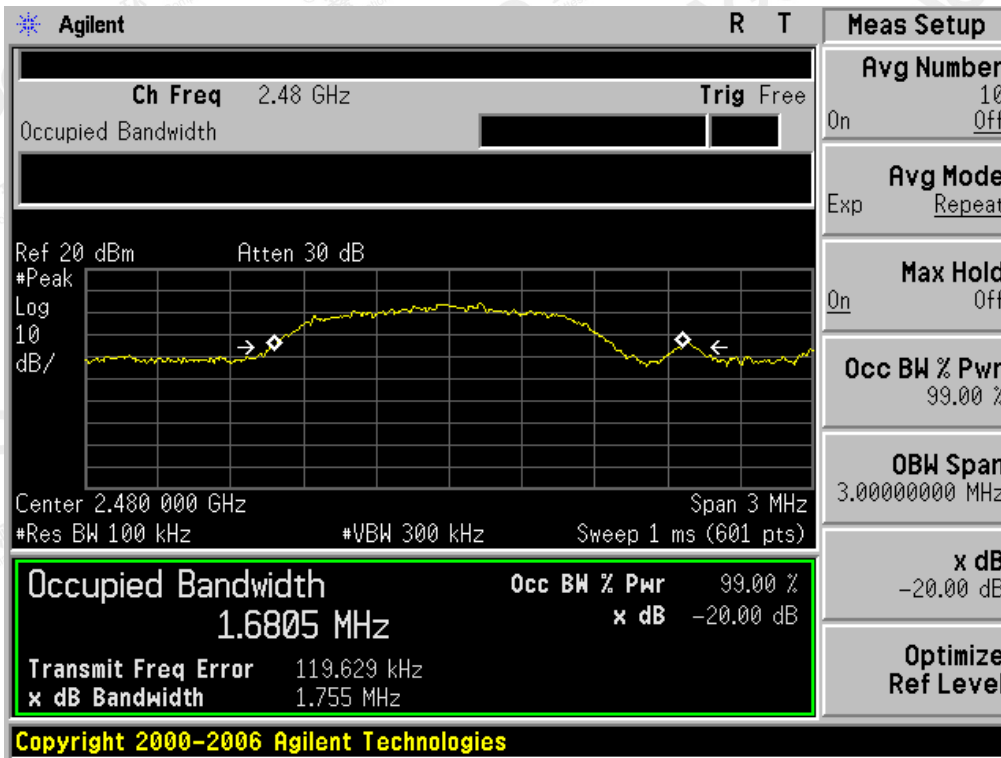

The results shown in this test report refer only to the sample(s) tested unless otherwise stated and the sample(s) are retained for 30 days only. The document is issued by AGC, this document cannot be reproduced except in full with our prior written permission. The more details and the authenticity of the report will be confirmed at <http://www.agc-cert.com>.

10. CONDUCTED SPURIOUS EMISSION

10.1. MEASUREMENT PROCEDURE

1. Connect EUT RF output port to the Spectrum Analyzer through an RF attenuator
2. Set the EUT Work on the top, the Middle and the bottom operation frequency individually.
3. Set the Span = wide enough to capture the peak level of the in-band emission and all spurious emissions from the lowest frequency generated in the EUT up through the 10th harmonic.
RBW = 100 kHz; VBW = 300kHz; Sweep = auto; Detector function = peak.
4. Set SPA Trace 1 Max hold, then View.

10.2. TEST SET-UP (BLOCK DIAGRAM OF CONFIGURATION)

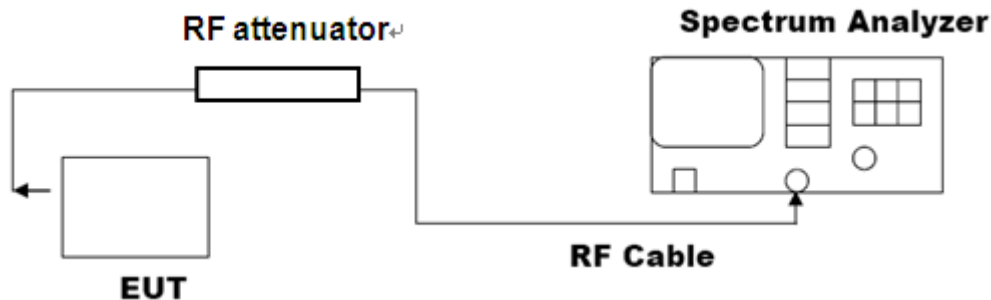

10.3. LIMITS AND MEASUREMENT RESULT

LIMITS AND MEASUREMENT RESULT		
Applicable Limits	Measurement Result	
	Test Data	Result
In any 100 KHz Bandwidth Outside the frequency band in which the spread spectrum intentional radiator is operating, the radio frequency power that is produce by the intentional radiator shall be at least 20 dB below that in 100KHz bandwidth within the band that contains the highest level of the desired power. In addition, radiation emissions which fall in the restricted bands, as defined in §15.205(a), must also comply with the radiated emission limits specified in§15.209(a))	At least -20dBc than the limit Specified on the BOTTOM Channel	PASS
	At least -20dBc than the limit Specified on the TOP Channel	PASS

The results shown in this test report refer only to the sample(s) tested unless otherwise stated and the sample(s) are retained for 30 days only. The document is issued by AGC, this document cannot be reproduced except in full with our prior written permission. The more details and the authenticity of the report will be confirmed at <http://www.agc-cert.com>.

TEST PLOT OF OUT OF BAND EMISSIONS WITH THE WORST CASE
OF 8DPSK MODULATION IN LOW CHANNEL

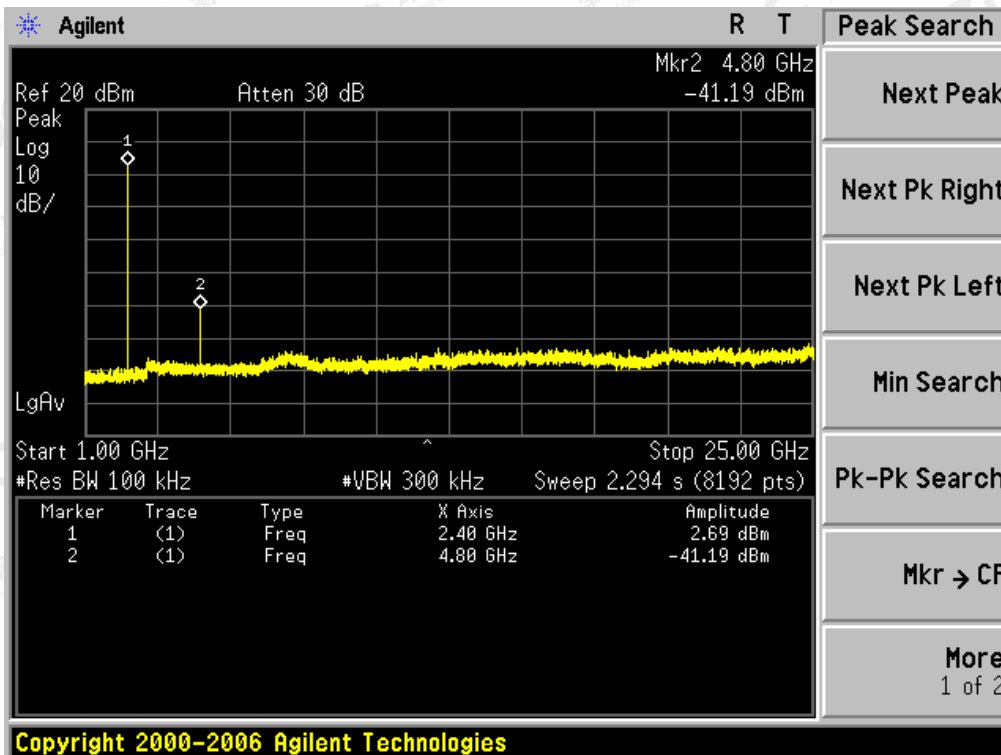
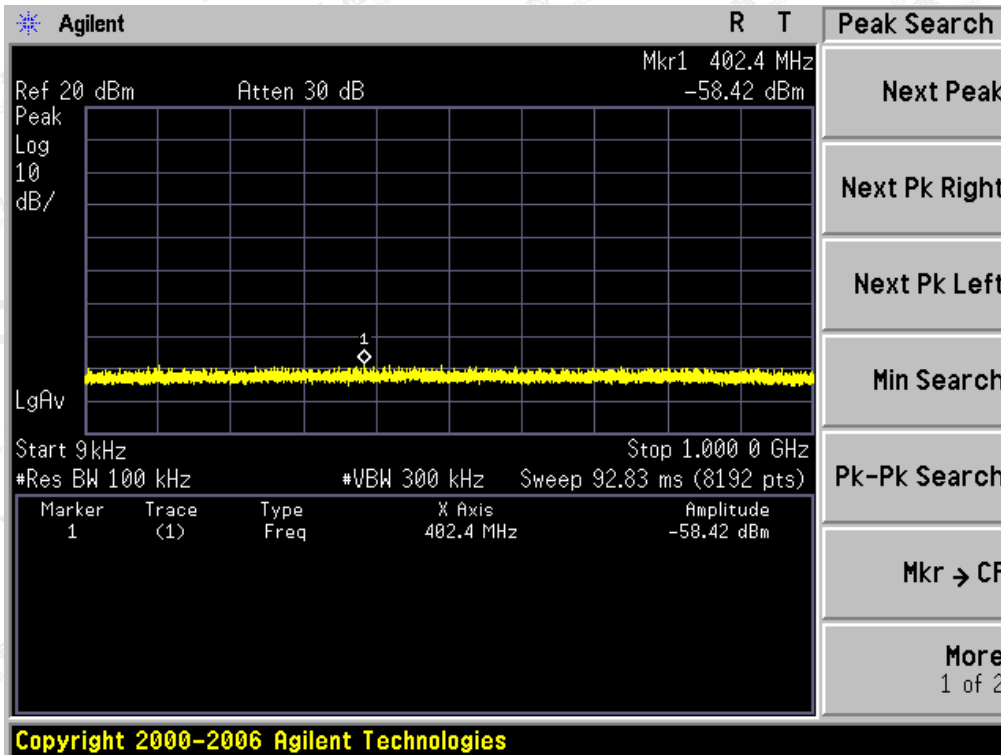

The results shown in this test report refer only to the sample(s) tested otherwise stated and the sample(s) are retained for 30 days only. The document is issued by AGC, this document cannot be reproduced except in full with our prior written permission. The more details and the authenticity of the report will be confirmed at <http://www.agc-cert.com>.

TEST PLOT OF OUT OF BAND EMISSIONS
OF 8DPSK MODULATION IN MIDDLE CHANNEL

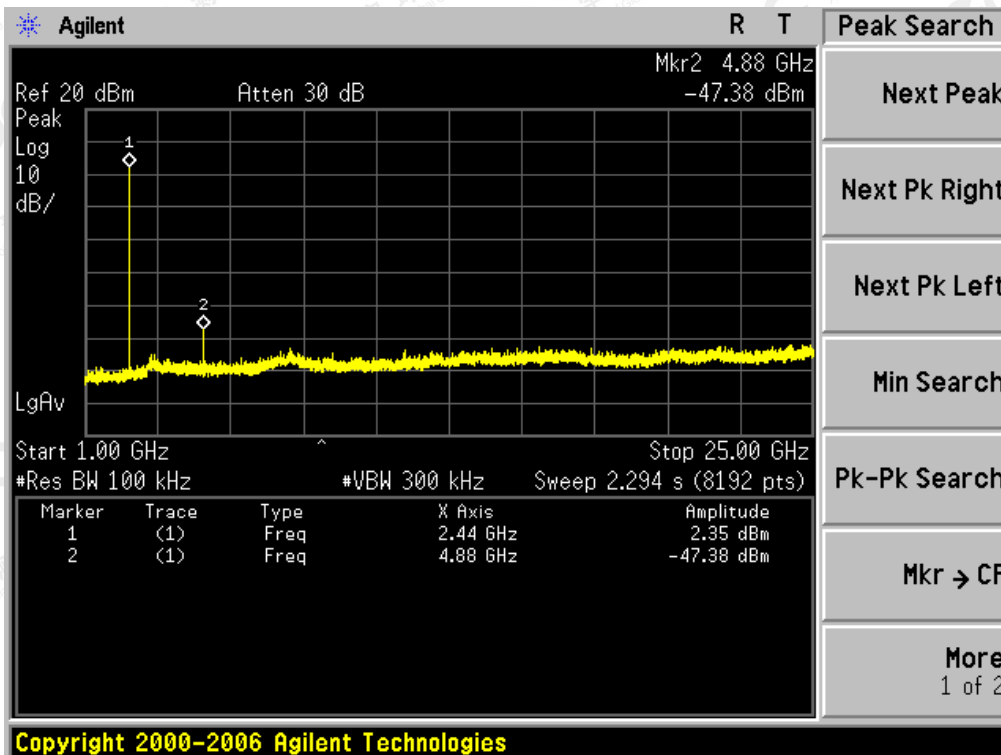
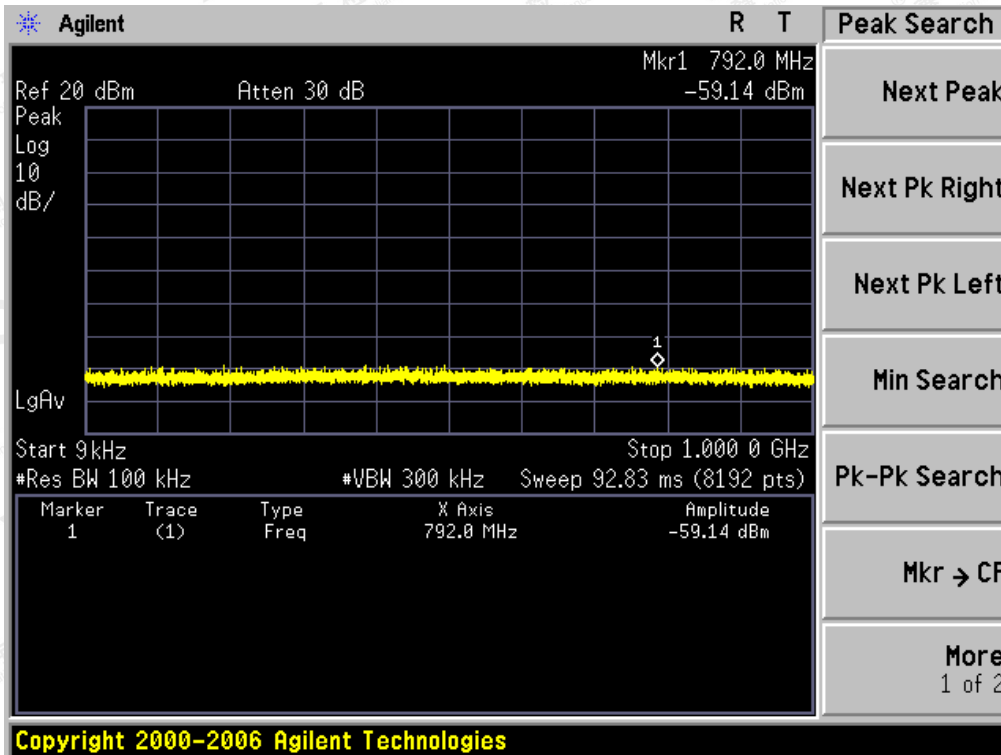

The results shown in this test report refer only to the sample(s) tested unless otherwise stated and the sample(s) are retained for 30 days only. The document is issued by AGC, this document cannot be reproduced except in full with our prior written permission. The more details and the authenticity of the report will be confirmed at <http://www.agc-cert.com>.

TEST PLOT OF OUT OF BAND EMISSIONS
OF 8DPSK MODULATION IN HIGH CHANNEL

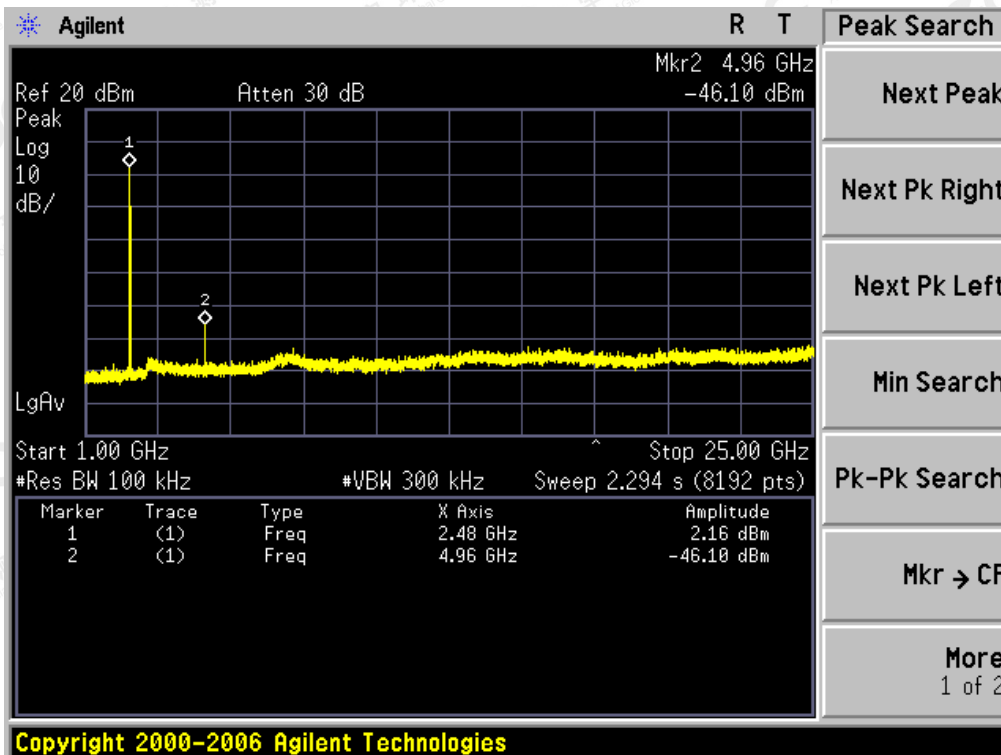
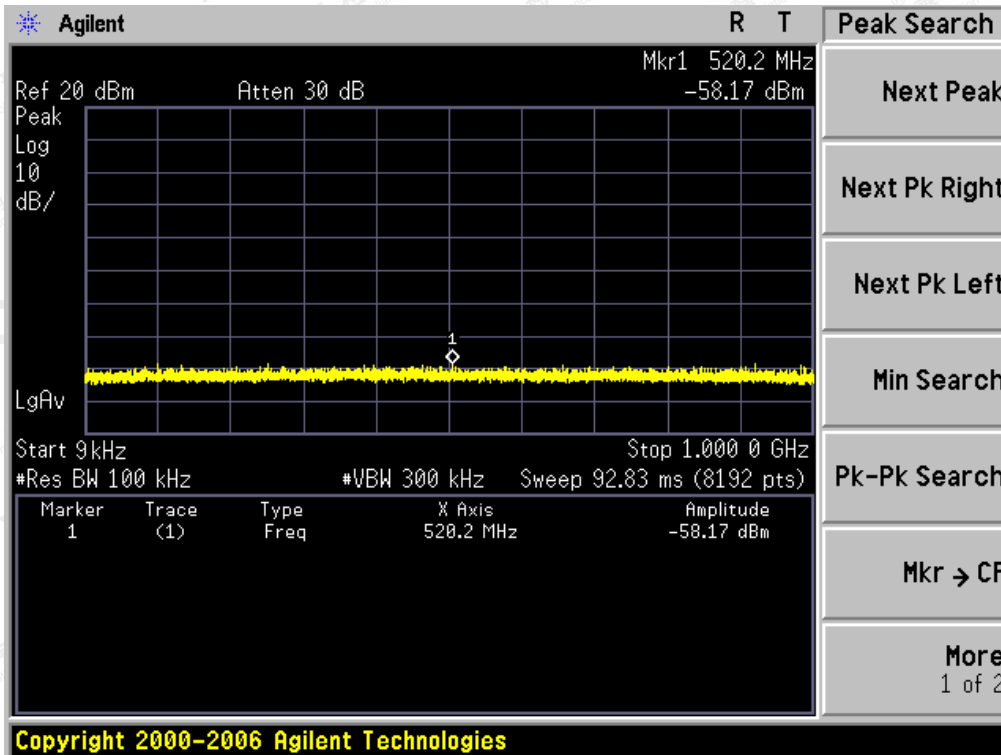

The results shown in this test report refer only to the sample(s) tested otherwise stated and the sample(s) are retained for 30 days only. The document is issued by AGC, this document cannot be reproduced except in full with our prior written permission. The more details and the authenticity of the report will be confirmed at <http://www.agc-cert.com>.

11. RADIATED EMISSION

11.1. TEST LIMIT

Frequency (MHz)	Distance Meters	Field Strengths Limit	
		μ V/m	dB(μ V)/m
0.009 ~ 0.490	300	2400/F(kHz)	---
0.490 ~ 1.705	30	24000/F(kHz)	---
1.705 ~ 30	30	30	---
30 ~ 88	3	100	40.0
88 ~ 216	3	150	43.5
216 ~ 960	3	200	46.0
960 ~ 1000	3	500	54.0
Above 1000	3	Other:74.0 dB(μ V)/m (Peak) 54.0 dB(μ V)/m (Average)	

Remark: (1) Emission level $\text{dB}\mu$ V = 20 log Emission level μ V/m
 (2) The smaller limit shall apply at the cross point between two frequency bands.
 (3) Distance is the distance in meters between the measuring instrument, antenna and the closest point of any part of the device or system.

11.2. MEASUREMENT PROCEDURE

- The measuring distance of 3m shall be used for measurements. The EUT was placed on the top of a rotating table 0.8 meter above the ground at a 3 meter semi-anechoic chamber. The table was rotated 360 degrees to determine the position of the highest radiation(Below 1GHz)
- The measuring distance of 3m shall used for measurements. The EUT was placed on the top of a rotating table 1.5 meter above the ground at a 3 meter semi-anechoic chamber. The table was rotated 360 degrees to determine the position of the highest radiation(Above 1GHz)
- The height of the test antenna shall vary between 1m to 4m.Both horizontal and vertical polarization Of the antenna are set to make the measurement.
- The initial step in collecting radiated emission data is a receive peak detector mode. Pre-scanning the measurement frequency range. Significant peaks are then marked and then Quasi Peak detector mode re-measured.
- All readings are peak unless otherwise stated QP in column of Note. Peak denoted that the Peak reading compliance with the QP limits and then QP Mode measurement didn't perform(Below 1GHz)
- All readings are Peak mode value unless otherwise stated AVG in column of Note. If the Peak mode measured value compliance with the Peak limits and lower than AVG Limits, the EUT shall be deemed to meet Peak&AVG limits and then only Peak mode was measured, but AVG mode didn't perform.(Above 1GHz)

The results shown in this test report refer only to the sample(s) tested unless otherwise stated and the sample(s) are retained for 30 days only. The document is issued by AGC, this document cannot be reproduced except in full with our prior written permission. The more details and the authenticity of the report will be confirmed at <http://www.agc-cert.com>.

The following table is the setting of spectrum analyzer and receiver.

Spectrum Parameter	Setting
Start ~Stop Frequency	9KHz~150KHz/RB 200Hz for QP
Start ~Stop Frequency	150KHz~30MHz/RB 9KHz for QP
Start ~Stop Frequency	30MHz~1000MHz/RB 120KHz for QP
Start ~Stop Frequency	1GHz~26.5GHz RBW 1MHz/ VBW 3MHz for Peak, RBW 1MHz/ VBW 10Hz for Average

Receiver Parameter	Setting
Start ~Stop Frequency	9KHz~150KHz/RB 200Hz for QP
Start ~Stop Frequency	150KHz~30MHz/RB 9KHz for QP
Start ~Stop Frequency	30MHz~1000MHz/RB 120KHz for QP

The results shown in this test report refer only to the sample(s) tested unless otherwise stated and the sample(s) are retained for 30 days only. The document is issued by AGC, this document cannot be reproduced except in full with our prior written permission. The more details and the authenticity of the report will be confirmed at <http://www.agc-cert.com>.

11.3. TEST SETUP

RADIATED EMISSION TEST SETUP BELOW 30MHz

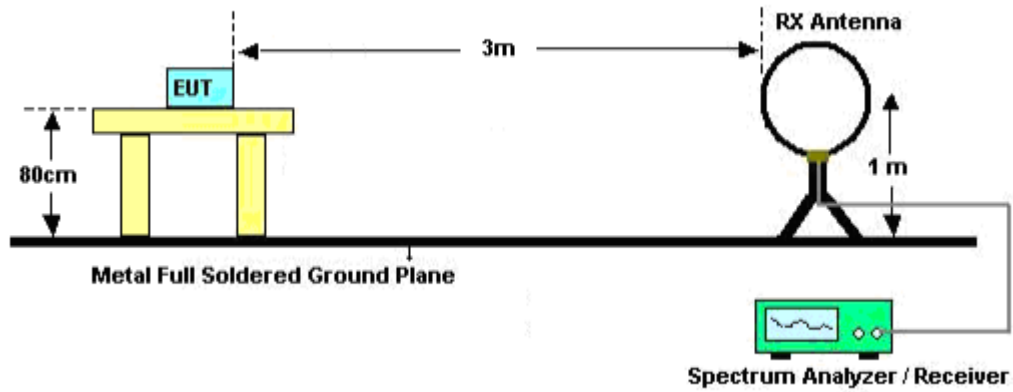

RADIATED EMISSION TEST SETUP 30MHz-1000MHz

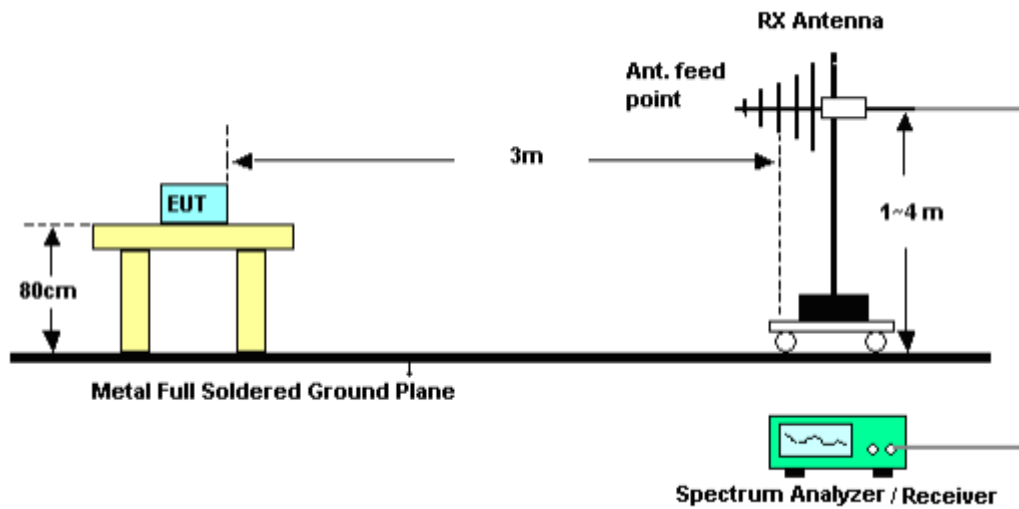

The results shown in this test report refer only to the sample(s) tested unless otherwise stated and the sample(s) are retained for 30 days only. The document is issued by AGC, this document cannot be reproduced except in full with our prior written permission. The more details and the authenticity of the report will be confirmed at <http://www.agc-cert.com>.

RADIATED EMISSION TEST SETUP ABOVE 1000MHz

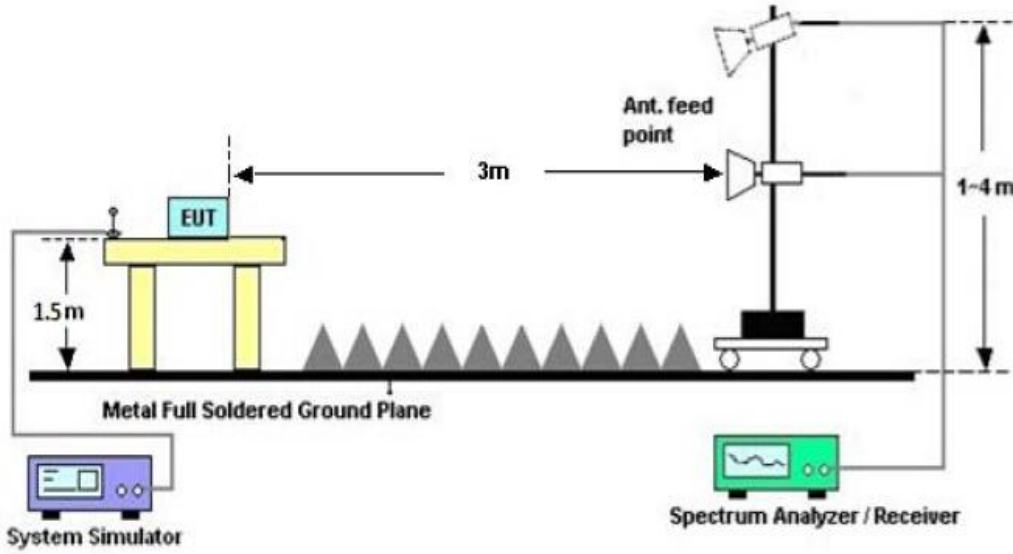

The results shown in this test report refer only to the sample(s) tested unless otherwise stated and the sample(s) are retained for 30 days only. The document is issued by AGC, this document cannot be reproduced except in full with our prior written permission. The more details and the authenticity of the report will be confirmed at <http://www.agc-cert.com>.

11.4. TEST RESULT

(Worst Modulation: 8DPSK)

RADIATED EMISSION BELOW 30MHz

No emission found between lowest internal used/generated frequencies to 30MHz.

The results shown in this test report refer only to the sample(s) tested unless otherwise stated and the sample(s) are retained for 30 days only. The document is issued by AGC, this document cannot be reproduced except in full with our prior written permission. The more details and the authenticity of the report will be confirmed at <http://www.agc-cert.com>.

RADIATED EMISSION BELOW 1GHz

RADIATED EMISSION TEST- (30MHz-1GHz)-LOW CHANNEL-HORIZONTAL

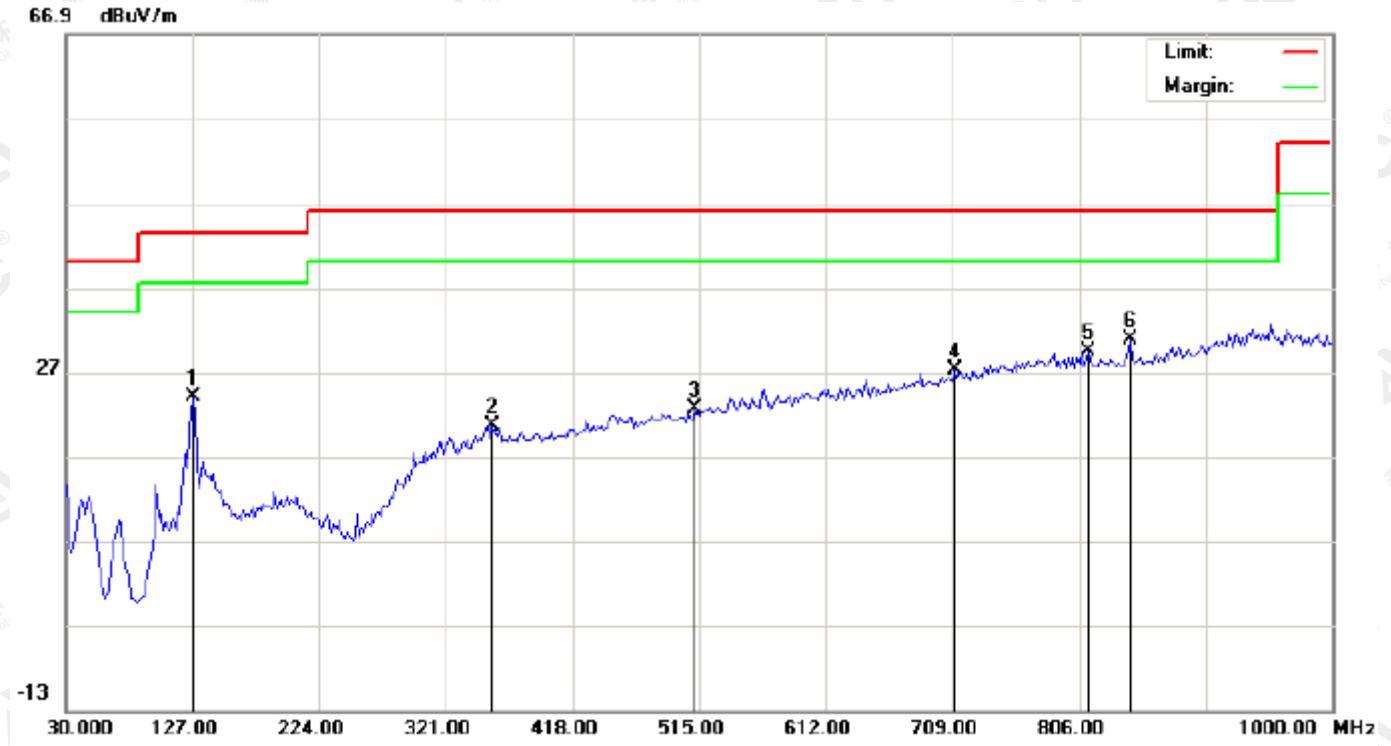

No.	Mk	Freq.	Reading	Factor	Measurement	Limit	Over	Detector	Antenna Height	Table Degree	Comment
		MHz	dBuV	dB/m	dBuV/m	dBuV/m	dB		cm	degree	
1		127.0000	14.94	9.13	24.07	43.50	-19.43	peak			
2		356.5667	1.78	18.78	20.56	46.00	-25.44	peak			
3		511.7667	1.10	21.45	22.55	46.00	-23.45	peak			
4		710.6167	1.65	25.52	27.17	46.00	-18.83	peak			
5		812.4667	2.07	27.32	29.39	46.00	-16.61	peak			
6	*	844.8000	3.43	27.31	30.74	46.00	-15.26	peak			

RESULT: PASS

The results shown in this test report refer only to the sample(s) tested unless otherwise stated and the sample(s) are retained for 30 days only. The document is issued by AGC, this document cannot be reproduced except in full with our prior written permission. The more details and the authenticity of the report will be confirmed at <http://www.agc-cert.com>.

RADIATED EMISSION TEST- (30MHz-1GHz)-LOW CHANNEL -VERTICAL

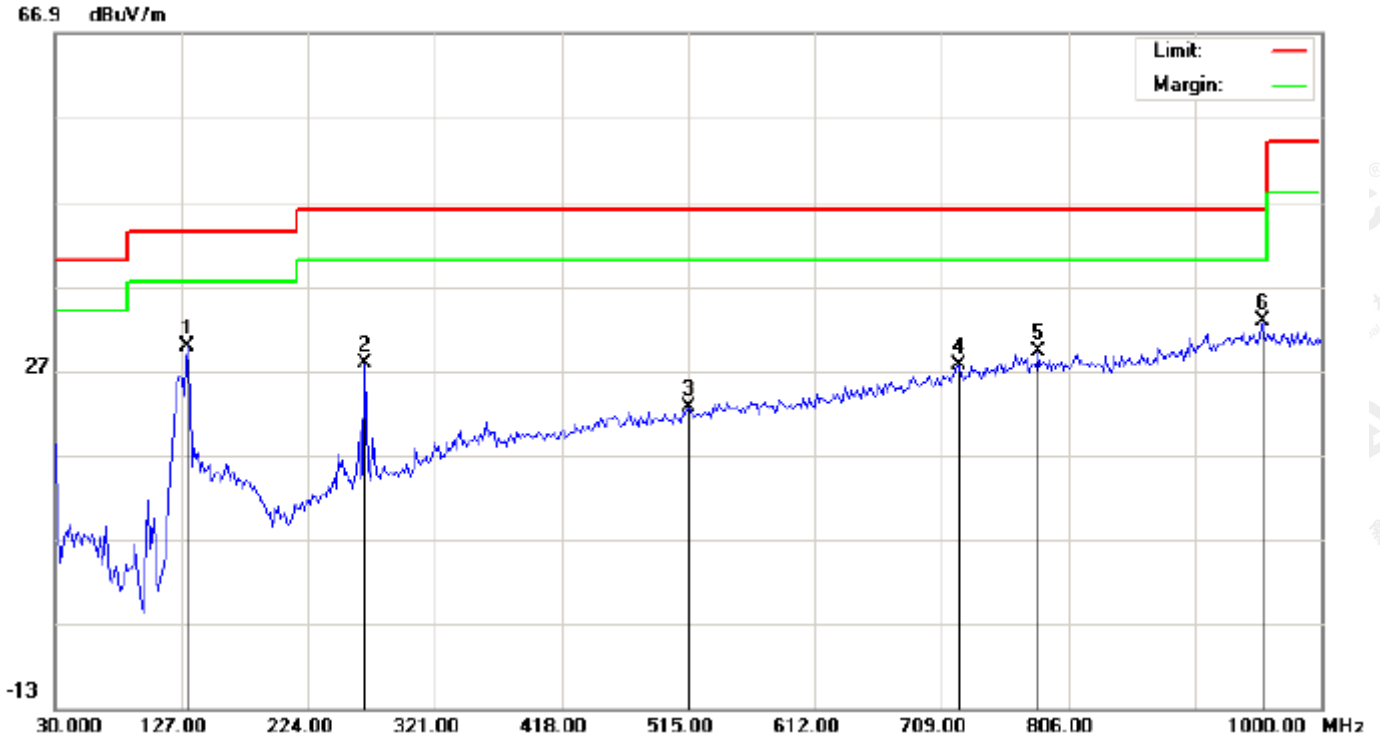

No.	Mk	Freq.	Reading	Factor	Measurement	Limit	Over	Detector	Antenna	Table	Comment
		MHz	dBuV	dB/m	dBuV/m	dBuV/m	dB		Height	Degree	
1		131.8500	18.05	11.80	29.85	43.50	-13.65	peak	cm	degree	
2		267.6500	13.30	14.43	27.73	46.00	-18.27	peak			
3		515.0000	1.11	21.53	22.64	46.00	-23.36	peak			
4		721.9333	1.81	25.82	27.63	46.00	-18.37	peak			
5		783.3667	2.07	27.09	29.16	46.00	-16.84	peak			
6	*	954.7333	2.88	29.95	32.83	46.00	-13.17	peak			

RESULT: PASS

Note: 1. Factor=Antenna Factor + Cable loss, Margin=Measurement-Limit.

2. The "Factor" value can be calculated automatically by software of measurement system.

The results shown in this test report refer only to the sample(s) tested unless otherwise stated and the sample(s) are retained for 30 days only. The document is issued by AGC, this document cannot be reproduced except in full with our prior written permission. The more details and the authenticity of the report will be confirmed at <http://www.agc-cert.com>.

RADIATED EMISSION TEST- (30MHz-1GHz)-MIDDLE CHANNEL-HORIZONTAL

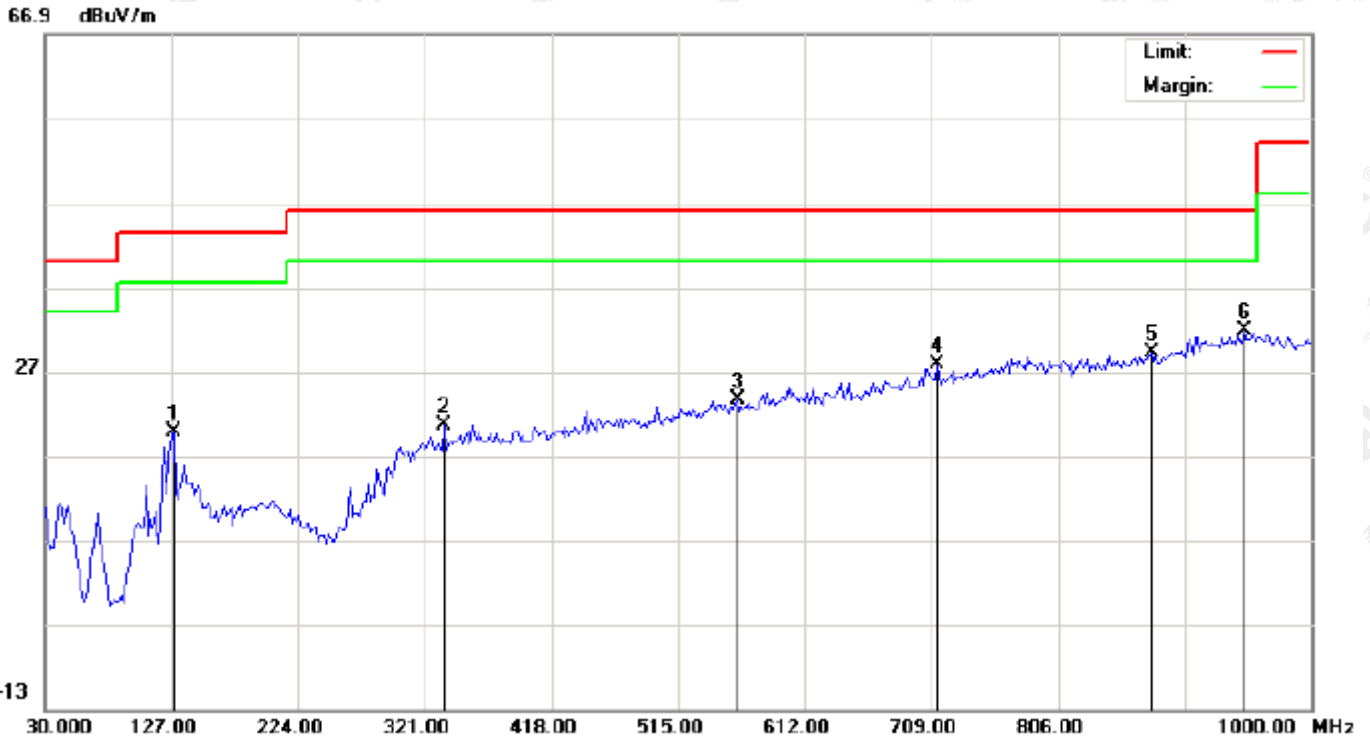

No.	Mk	Freq.	Reading	Factor	Measurement	Limit	Over	Detector	Antenna	Table	Comment
		MHz	dBuV	dB/m	dBuV/m	dBuV/m	dB		Height	Degree	
1		128.6167	9.89	9.88	19.77	43.50	-23.73	peak			
2		335.5500	2.83	17.78	20.61	46.00	-25.39	peak			
3		560.2667	0.79	22.74	23.53	46.00	-22.47	peak			
4		713.8500	2.27	25.61	27.88	46.00	-18.12	peak			
5		877.1333	1.27	28.02	29.29	46.00	-16.71	peak			
6	*	948.2667	1.76	29.95	31.71	46.00	-14.29	peak			

RESULT: PASS

The results shown in this test report refer only to the sample(s) tested unless otherwise stated and the sample(s) are retained for 30 days only. The document is issued by AGC, this document cannot be reproduced except in full with our prior written permission. The more details and the authenticity of the report will be confirmed at <http://www.agc-cert.com>.

RADIATED EMISSION TEST- (30MHz-1GHz)- MIDDLE CHANNEL -VERTICAL

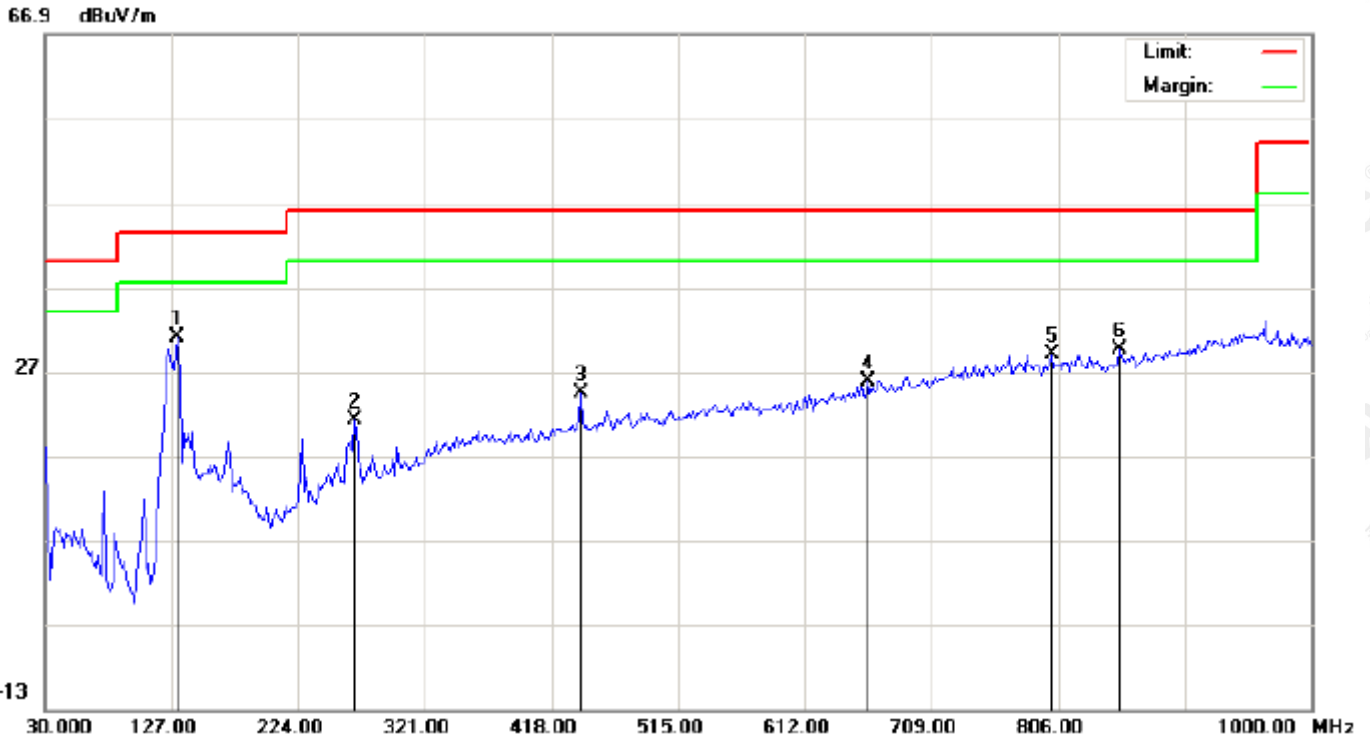

No.	Mk	Freq.	Reading	Factor	Measurement	Limit	Over	Detector	Antenna	Table	Comment
		MHz	dBuV	dB/m	dBuV/m	dBuV/m	dB		Height	Degree	
									cm	degree	
1	*	131.8500	19.18	11.80	30.98	43.50	-12.52	peak			
2		267.6500	6.75	14.43	21.18	46.00	-24.82	peak			
3		440.6333	4.05	20.31	24.36	46.00	-21.64	peak			
4		660.5000	1.67	24.13	25.80	46.00	-20.20	peak			
5		801.1500	1.73	27.32	29.05	46.00	-16.95	peak			
6		852.8833	2.17	27.38	29.55	46.00	-16.45	peak			

RESULT: PASS

Note: 1. Factor=Antenna Factor + Cable loss, Margin=Measurement-Limit.

2. The "Factor" value can be calculated automatically by software of measurement system.

The results shown in this test report refer only to the sample(s) tested unless otherwise stated and the sample(s) are retained for 30 days only. The document is issued by AGC, this document cannot be reproduced except in full with our prior written permission. The more details and the authenticity of the report will be confirmed at <http://www.agc-cert.com>.

RADIATED EMISSION TEST- (30MHz-1GHz)-HIGH CHANNEL-HORIZONTAL

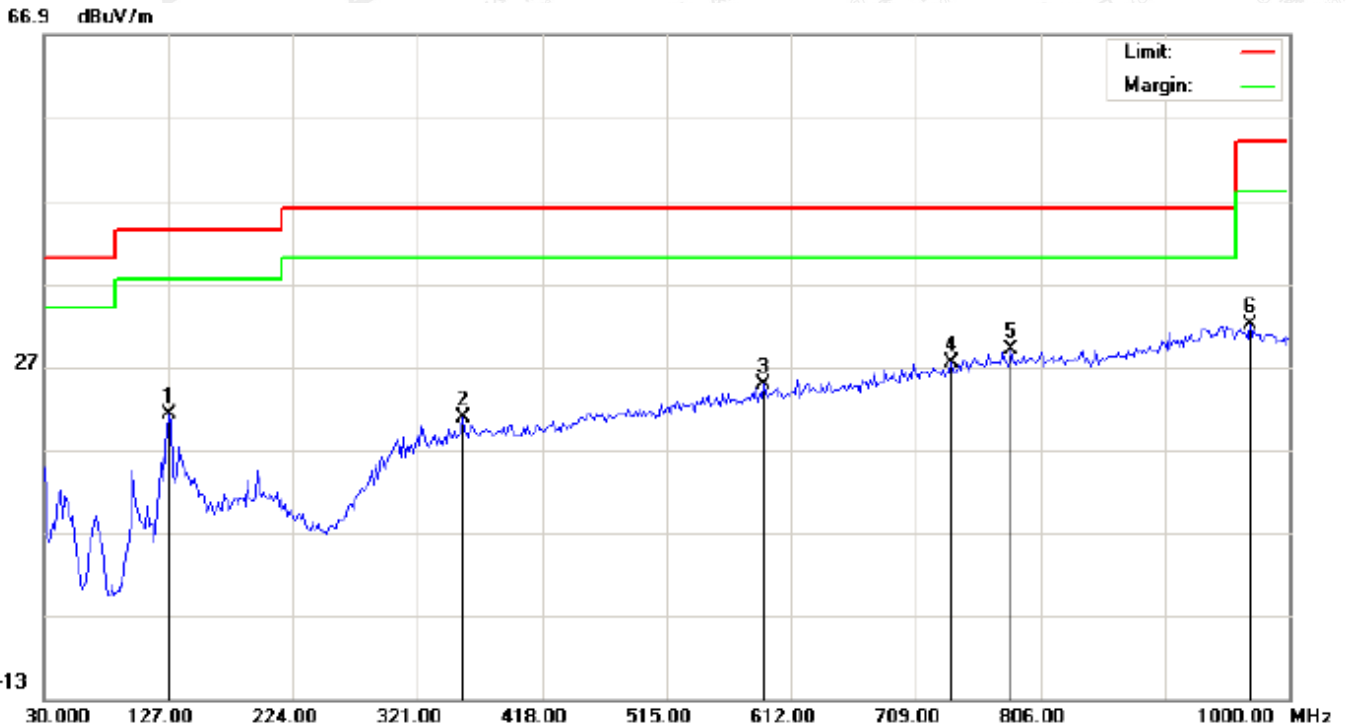

No.	Mk	Freq.	Reading	Factor	Measurement	Limit	Over	Detector	Antenna Height	Table Degree	Comment
		MHz	dBuV	dB/m	dBuV/m	dBuV/m	dB		cm	degree	
1		127.0000	12.13	9.13	21.26	43.50	-22.24	peak			
2		356.5667	1.98	18.78	20.76	46.00	-25.24	peak			
3		590.9833	1.22	23.50	24.72	46.00	-21.28	peak			
4		736.4833	1.25	26.25	27.50	46.00	-18.50	peak			
5	*	783.3667	1.84	27.09	28.93	46.00	-17.07	peak			
6		969.2833	2.19	29.81	32.00	54.00	-22.00	peak			

RESULT: PASS

The results shown in this test report refer only to the sample(s) tested unless otherwise stated and the sample(s) are retained for 30 days only. The document is issued by AGC, this document cannot be reproduced except in full with our prior written permission. The more details and the authenticity of the report will be confirmed at <http://www.agc-cert.com>.

RADIATED EMISSION TEST- (30MHz-1GHz)-HIGH CHANNEL -VERTICAL

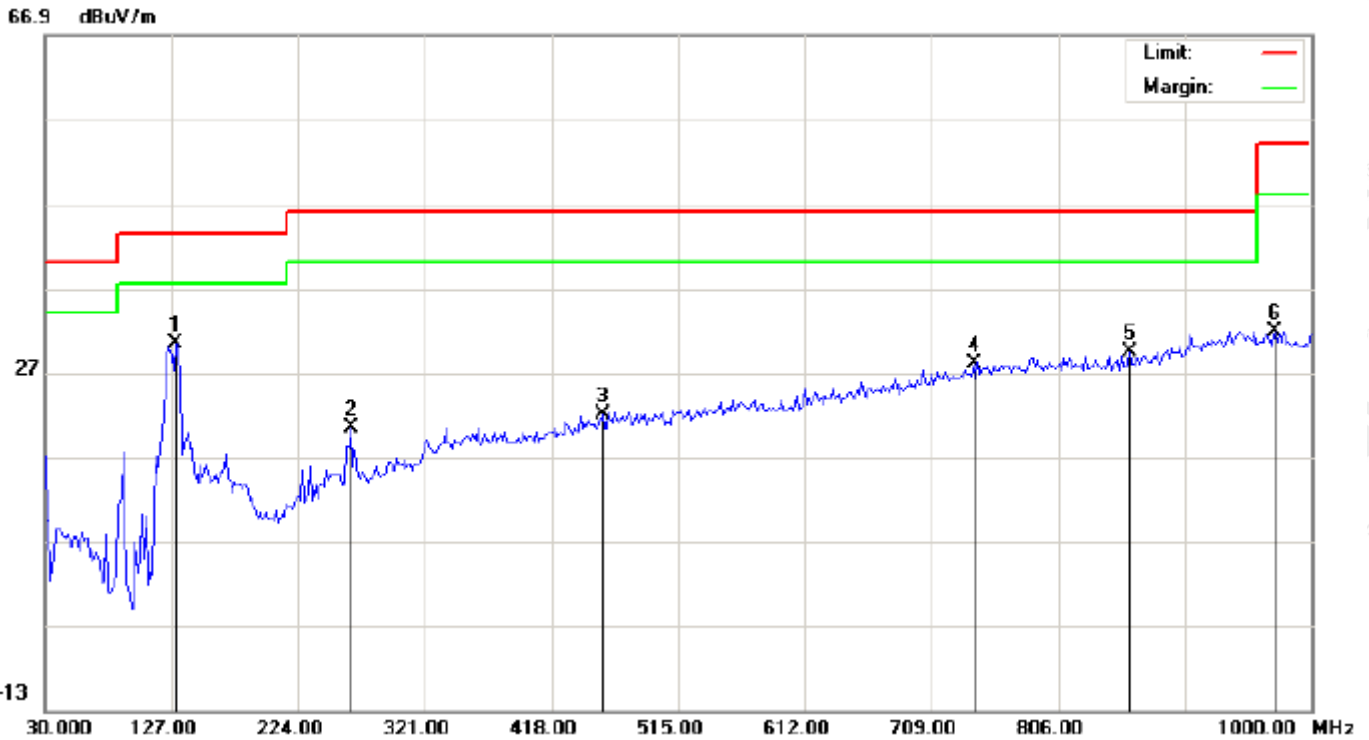

No.	Mk	Freq.	Reading	Factor	Measurement	Limit	Over	Detector	Antenna Height	Table Degree	Comment
		MHz	dBuV	dB/m	dBuV/m	dBuV/m	dB		cm	degree	
1	*	130.2332	19.34	11.13	30.47	43.50	-13.03	peak			
2		264.4166	6.03	14.34	20.37	46.00	-25.63	peak			
3		456.8000	1.28	20.66	21.94	46.00	-24.06	peak			
4		741.3333	1.68	26.38	28.06	46.00	-17.94	peak			
5		860.9667	1.74	27.60	29.34	46.00	-16.66	peak			
6		972.5167	2.08	29.78	31.86	54.00	-22.14	peak			

RESULT: PASS

Note: 1. Factor=Antenna Factor + Cable loss, Margin=Measurement-Limit.

2. The "Factor" value can be calculated automatically by software of measurement system.

The results shown in this test report refer only to the sample(s) tested unless otherwise stated and the sample(s) are retained for 30 days only. The document is issued by AGC, this document cannot be reproduced except in full with our prior written permission. The more details and the authenticity of the report will be confirmed at <http://www.agc-cert.com>.

RADIATED EMISSION ABOVE 1GHz

RADIATED EMISSION ABOVE 1GHz (1-10th Harmonics)-LOW CHANNEL-HORIZONTAL

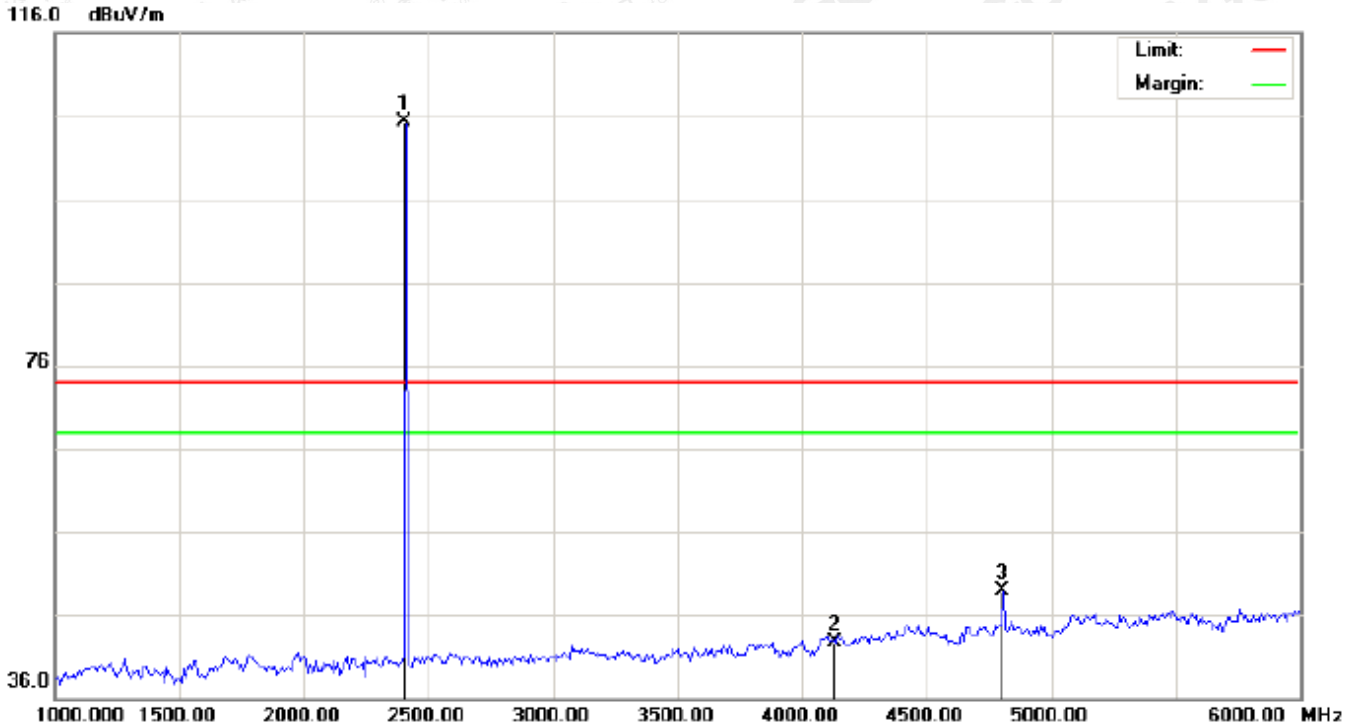

No.	Mk	Freq.	Reading	Factor	Measurement	Limit	Over	Detector	Antenna Height	Table Degree	Comment
		MHz	dBuV	dB/m	dBuV/m	dBuV/m	dB		cm	degree	
1	*	2402.000	94.90	10.32	105.22	74.00	31.22	peak			
2		4133.333	29.66	12.98	42.64	74.00	-31.36	peak			
3		4804.000	41.21	7.69	48.90	74.00	-25.10	peak			

RESULT: PASS

The results shown in this test report refer only to the sample(s) tested unless otherwise stated and the sample(s) are retained for 30 days only. The document is issued by AGC, this document cannot be reproduced except in full with our prior written permission. The more details and the authenticity of the report will be confirmed at <http://www.agc-cert.com>.

RADIATED EMISSION ABOVE 1GHz (1-10th Harmonics)-LOW CHANNEL -VERTICAL

116.0 dBuV/m

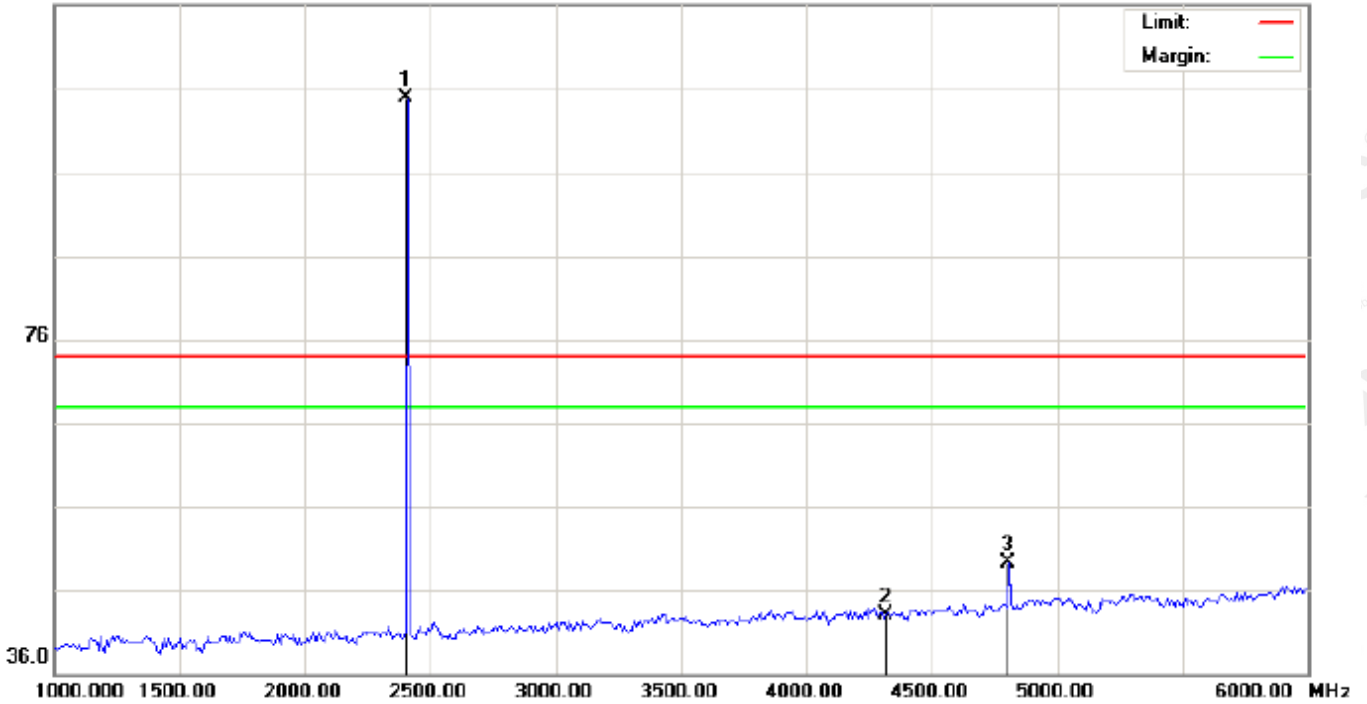

No.	Mk	Freq.	Reading	Factor	Measurement	Limit	Over	Detector	Antenna Height	Table Degree	Comment
		MHz	dBuV	dB/m	dBuV/m	dBuV/m	dB		cm	degree	
1	*	2402.000	94.57	10.32	104.89	74.00	30.89	peak			
2		4316.667	33.26	9.93	43.19	74.00	-30.81	peak			
3		4804.000	41.55	7.69	49.24	74.00	-24.76	peak			

RESULT: PASS

The results shown in this test report refer only to the sample(s) tested unless otherwise stated and the sample(s) are retained for 30 days only. The document is issued by AGC, this document cannot be reproduced except in full with our prior written permission. The more details and the authenticity of the report will be confirmed at <http://www.agc-cert.com>.

RADIATED EMISSION ABOVE 1GHz (1-10th Harmonics)-MIDDLE CHANNEL-HORIZONTAL

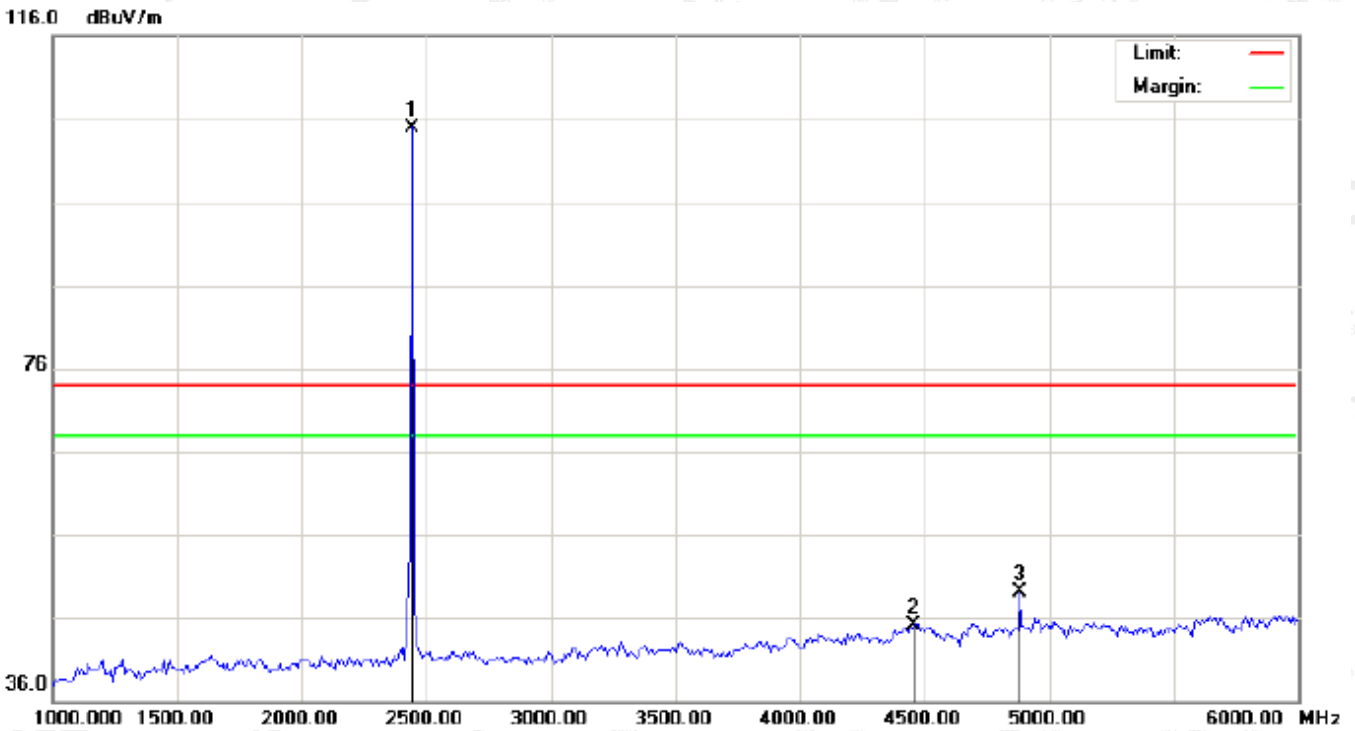

No.	Mk	Freq.	Reading	Factor	Measurement	Limit	Over	Detector	Antenna Height	Table Degree	Comment
		MHz	dBuV	dB/m	dBuV/m	dBuV/m	dB		cm	degree	
1	*	2441.000	94.55	10.36	104.91	74.00	30.91	peak			
2		4458.333	37.55	7.58	45.13	74.00	-28.87	peak			
3		4882.000	41.16	7.89	49.05	74.00	-24.95	peak			

RESULT: PASS

The results shown in this test report refer only to the sample(s) tested unless otherwise stated and the sample(s) are retained for 30 days only. The document is issued by AGC, this document cannot be reproduced except in full with our prior written permission. The more details and the authenticity of the report will be confirmed at <http://www.agc-cert.com>.

RADIATED EMISSION ABOVE 1GHz (1-10th Harmonics) - MIDDLE CHANNEL -VERTICAL

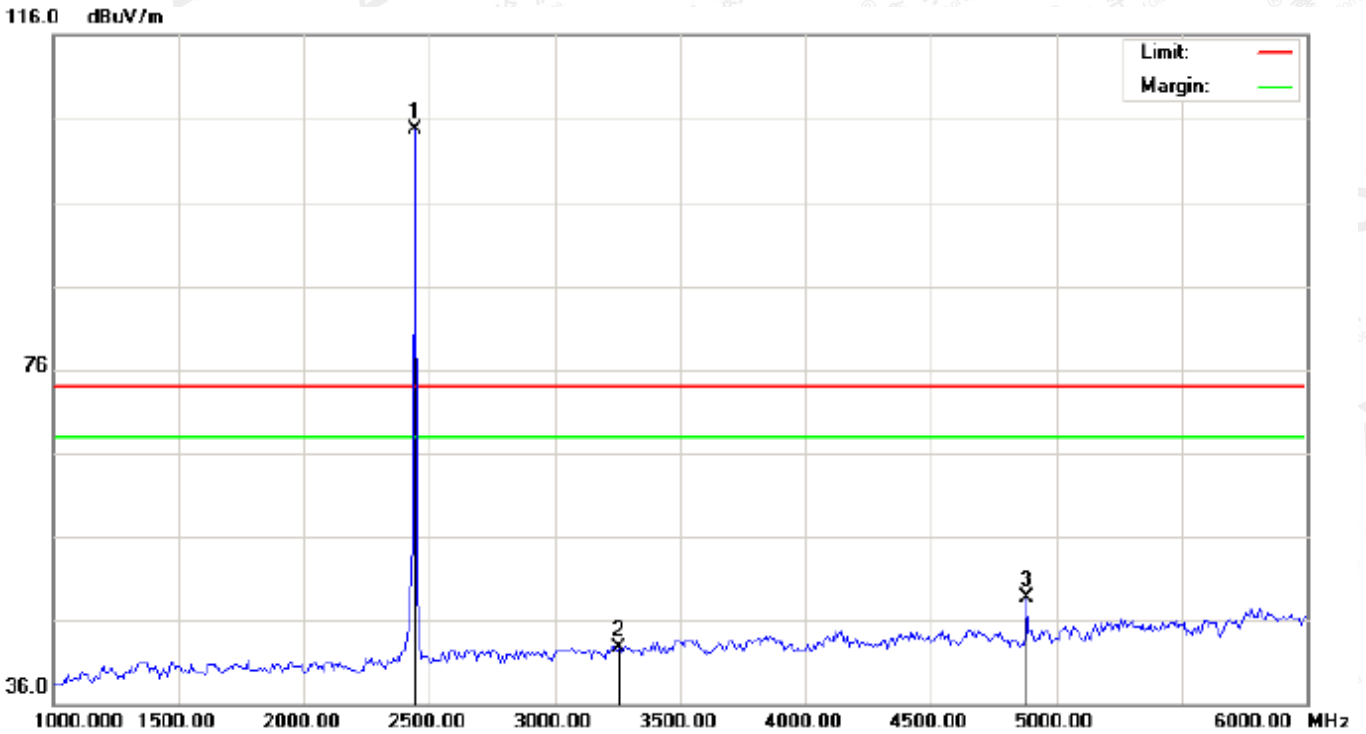

No.	Mk	Freq.	Reading	Factor	Measurement	Limit	Over	Detector	Antenna Height	Table Degree	Comment
		MHz	dBuV	dB/m	dBuV/m	dBuV/m	dB		cm	degree	
1	*	2441.000	94.27	10.36	104.63	74.00	30.63	peak			
2		3258.333	30.87	11.88	42.75	74.00	-31.25	peak			
3		4882.000	40.89	7.89	48.78	74.00	-25.22	peak			

RESULT: PASS

The results shown in this test report refer only to the sample(s) tested unless otherwise stated and the sample(s) are retained for 30 days only. The document is issued by AGC, this document cannot be reproduced except in full with our prior written permission. The more details and the authenticity of the report will be confirmed at <http://www.agc-cert.com>.

RADIATED EMISSION ABOVE 1GHz (1-10th Harmonics)-HIGH CHANNEL-HORIZONTAL

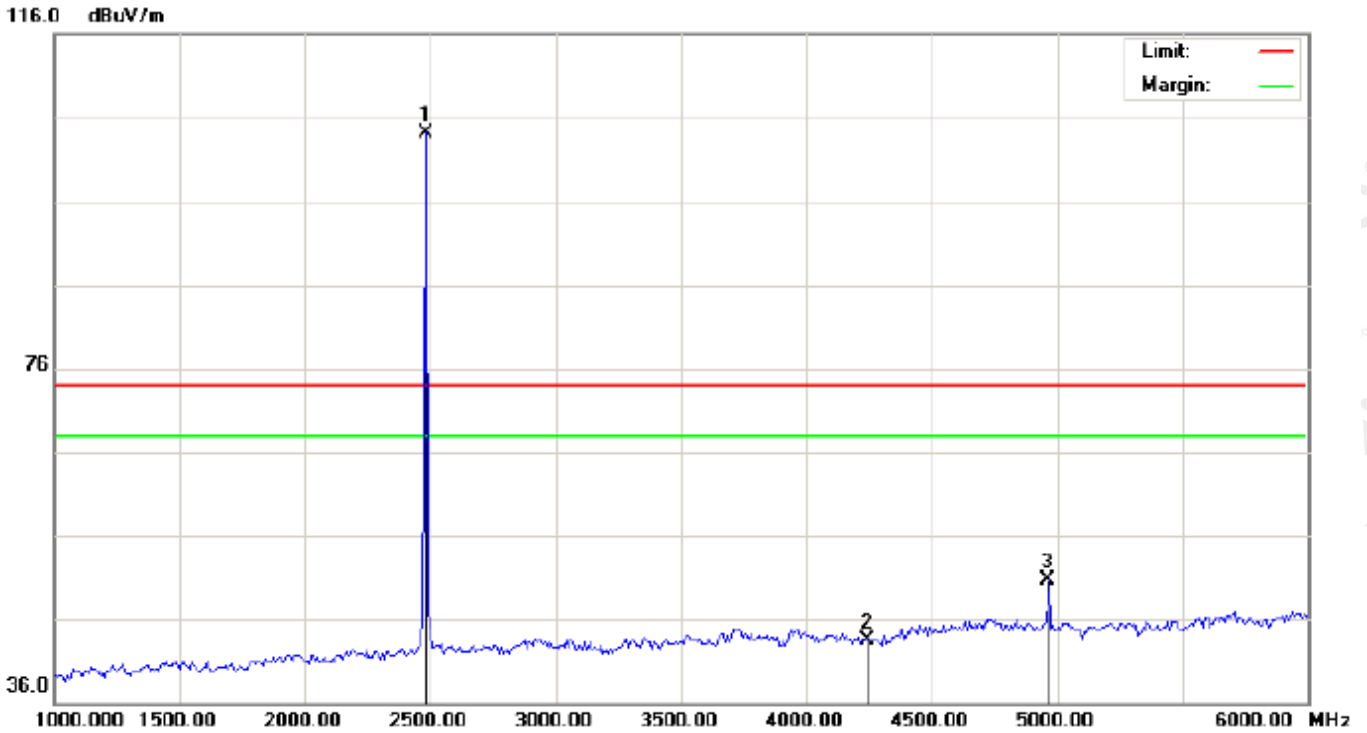

No.	Mk	Freq.	Reading	Factor	Measurement	Limit	Over	Detector	Antenna Height	Table Degree	Comment
		MHz	dBuV	dB/m	dBuV/m	dBuV/m	dB		cm	degree	
1	*	2480.000	93.63	10.41	104.04	74.00	30.04	peak			
2		4241.667	32.39	11.18	43.57	74.00	-30.43	peak			
3		4960.000	42.60	8.09	50.69	74.00	-23.31	peak			

RESULT: PASS

The results shown in this test report refer only to the sample(s) tested unless otherwise stated and the sample(s) are retained for 30 days only. The document is issued by AGC, this document cannot be reproduced except in full with our prior written permission. The more details and the authenticity of the report will be confirmed at <http://www.agc-cert.com>.

RADIATED EMISSION ABOVE 1GHz (1-10th Harmonics)-HIGH CHANNEL -VERTICAL

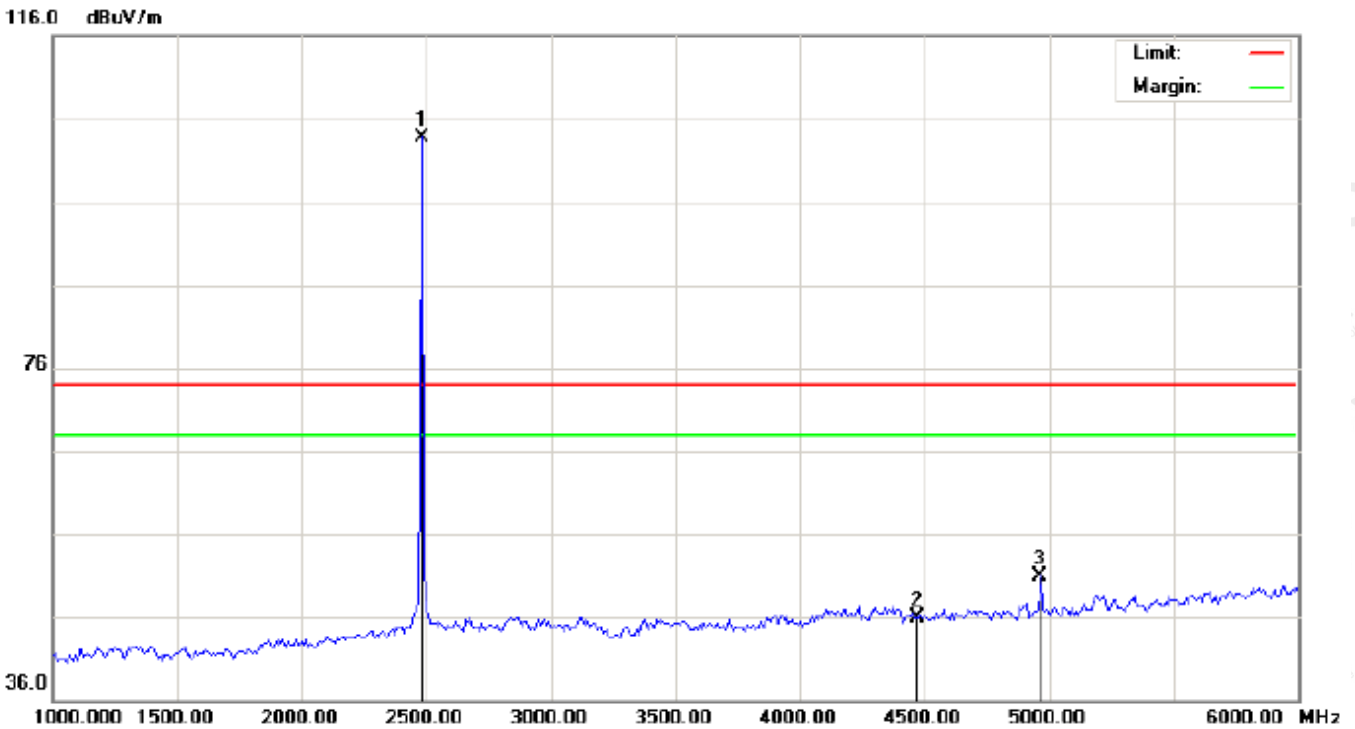

No.	Mk	Freq.	Reading	Factor	Measurement	Limit	Over	Detector	Antenna Height	Table Degree	Comment
		MHz	dBuV	dB/m	dBuV/m	dBuV/m	dB		cm	degree	
1	*	2480.000	93.30	10.41	103.71	74.00	29.71	peak			
2		4466.667	38.40	7.44	45.84	74.00	-28.16	peak			
3		4960.000	42.91	8.09	51.00	74.00	-23.00	peak			

RESULT: PASS

Note: 6~25GHz at least have 20dB margin. No recording in the test report.

Factor=Antenna Factor+ Cable loss-Amplifier gain, Margin=Measurement-Limit.

The "Factor" value can be calculated automatically by software of measurement system.

The results shown in this test report refer only to the sample(s) tested unless otherwise stated and the sample(s) are retained for 30 days only. The document is issued by AGC, this document cannot be reproduced except in full with our prior written permission. The more details and the authenticity of the report will be confirmed at <http://www.agc-cert.com>.

12. BAND EDGE EMISSION

12.1. MEASUREMENT PROCEDURE

1. Set the EUT Work on the top, the bottom operation frequency individually.
2. Set SPA Start or Stop Frequency=Operation Frequency,
For unrestricted band: RBW=100kHz, VBW=300kHz
For restricted band: RBW=1MHz, VBW=3*RBW
Center frequency =Operation frequency
3. The band edges was measured and recorded.

12.2. TEST SET-UP

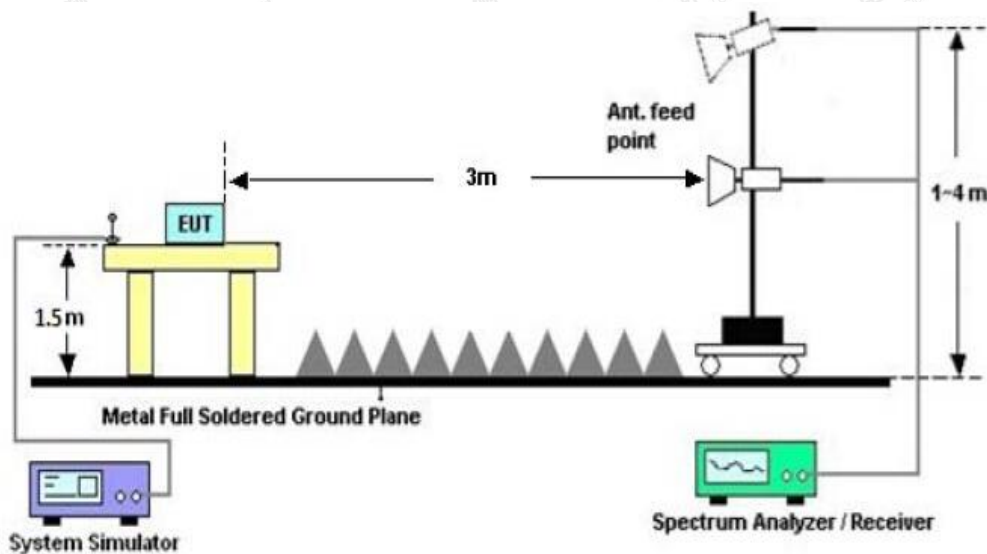

The results shown in this test report refer only to the sample(s) tested unless otherwise stated and the sample(s) are retained for 30 days only. The document is issued by AGC, this document cannot be reproduced except in full with our prior written permission. The more details and the authenticity of the report will be confirmed at <http://www.agc-cert.com>.

12.3. TEST RESULT

(Worst Modulation: 8DPSK)

TEST PLOT OF BAND EDGE FOR LOW CHANNEL (3Mbps)-Horizontal

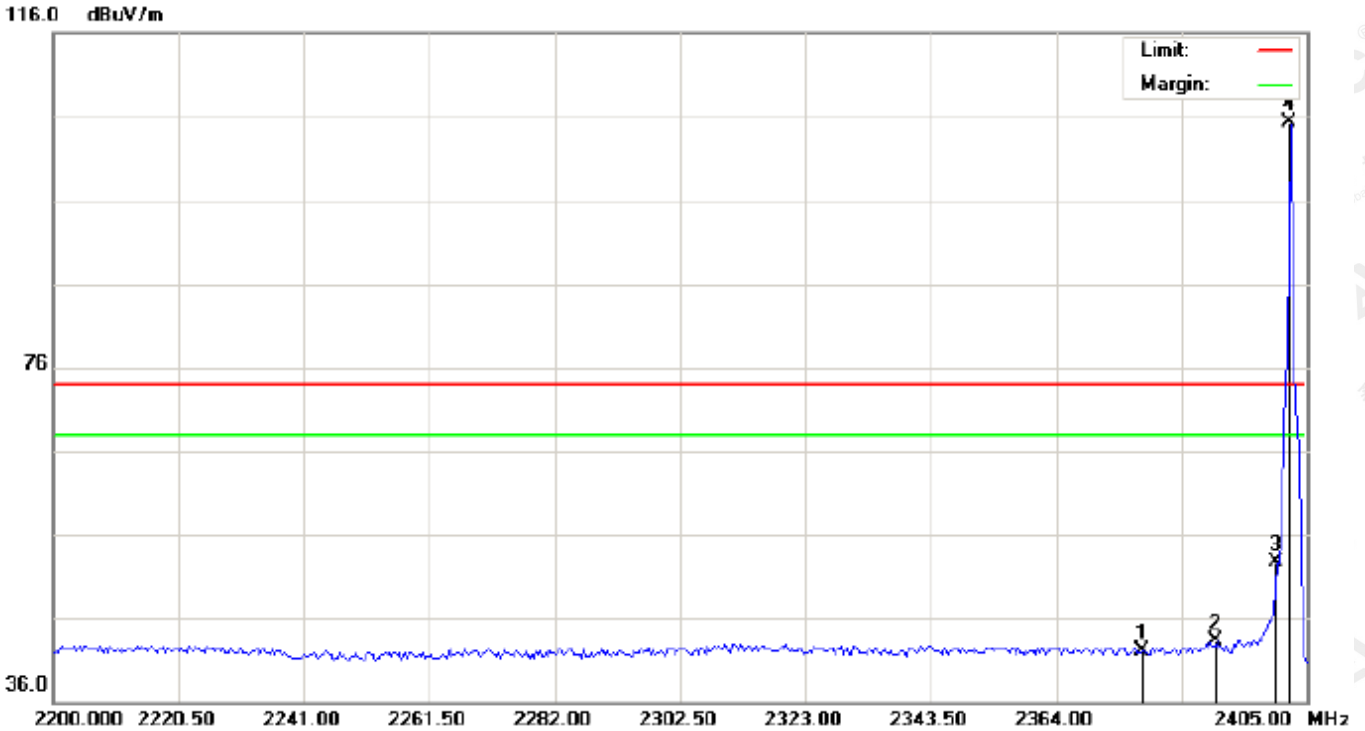

No.	Mk	Freq.	Reading	Factor	Measurement	Limit	Over	Detector	Antenna	Table	Comment
		MHz	dBuV	dB/m	dBuV/m	dBuV/m	dB		Height	Degree	
									cm	degree	
1		2378.008	31.89	10.30	42.19	74.00	-31.81	peak			
2		2390.000	33.00	10.31	43.31	74.00	-30.69	peak			
3		2400.000	42.47	10.32	52.79	74.00	-21.21	peak			
4	*	2402.000	94.91	10.32	105.23	74.00	31.23	peak			

The results shown in this test report refer only to the sample(s) tested unless otherwise stated and the sample(s) are retained for 30 days only. The document is issued by AGC, this document cannot be reproduced except in full with our prior written permission. The more details and the authenticity of the report will be confirmed at <http://www.agc-cert.com>.

TEST PLOT OF BAND EDGE FOR LOW CHANNEL (3Mbps)-Vertical

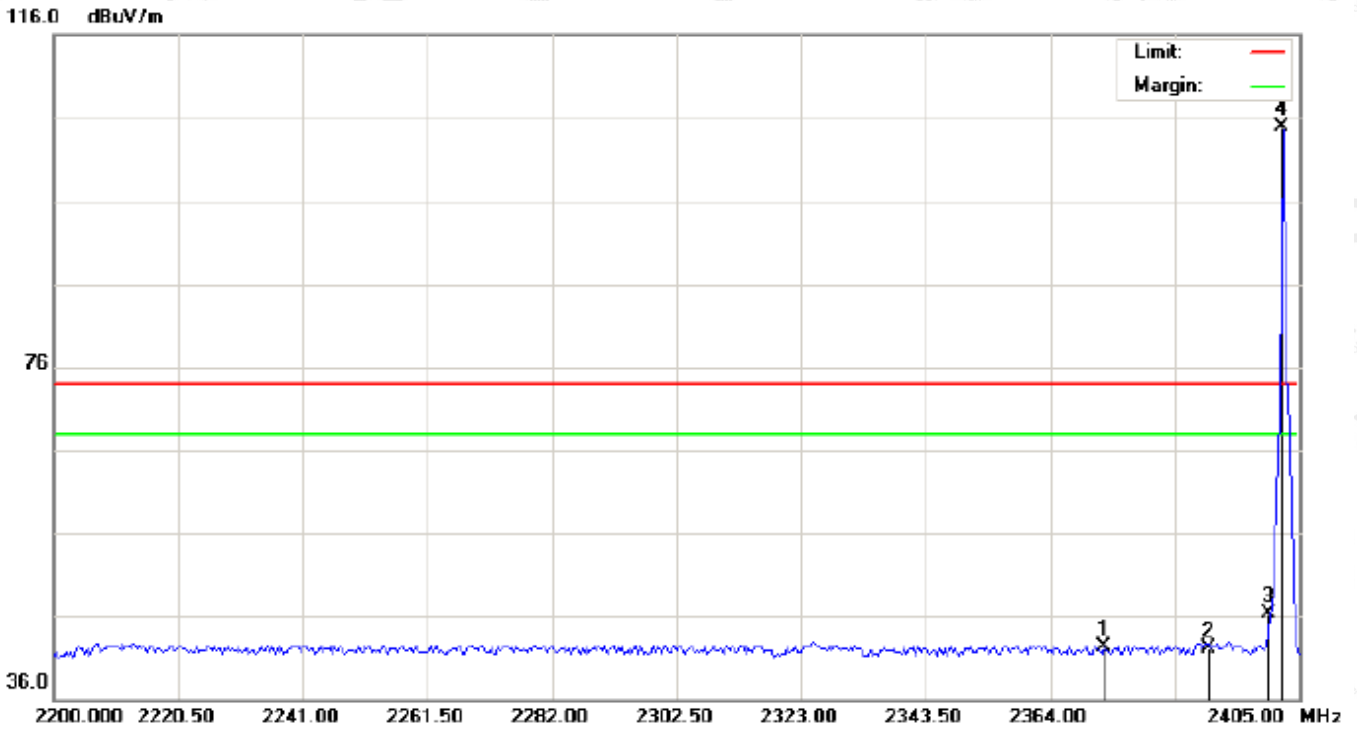

No.	Mk	Freq.	Reading	Factor	Measurement	Limit	Over	Detector	Antenna	Table	Comment
		MHz	dBuV	dB/m	dBuV/m	dBuV/m	dB		Height	Degree	
1		2372.883	32.02	10.29	42.31	74.00	-31.69	peak			
2		2390.000	31.71	10.31	42.02	74.00	-31.98	peak			
3		2400.000	36.06	10.32	46.38	74.00	-27.62	peak			
4	*	2402.000	94.55	10.32	104.87	74.00	30.87	peak			

The results shown in this test report refer only to the sample(s) tested and unless otherwise stated and the sample(s) are retained for 30 days only. The document is issued by AGC, this document cannot be reproduced except in full with our prior written permission. The more details and the authenticity of the report will be confirmed at <http://www.agc-cert.com>.

TEST PLOT OF BAND EDGE FOR HIGH CHANNEL (3Mbps)-Horizontal

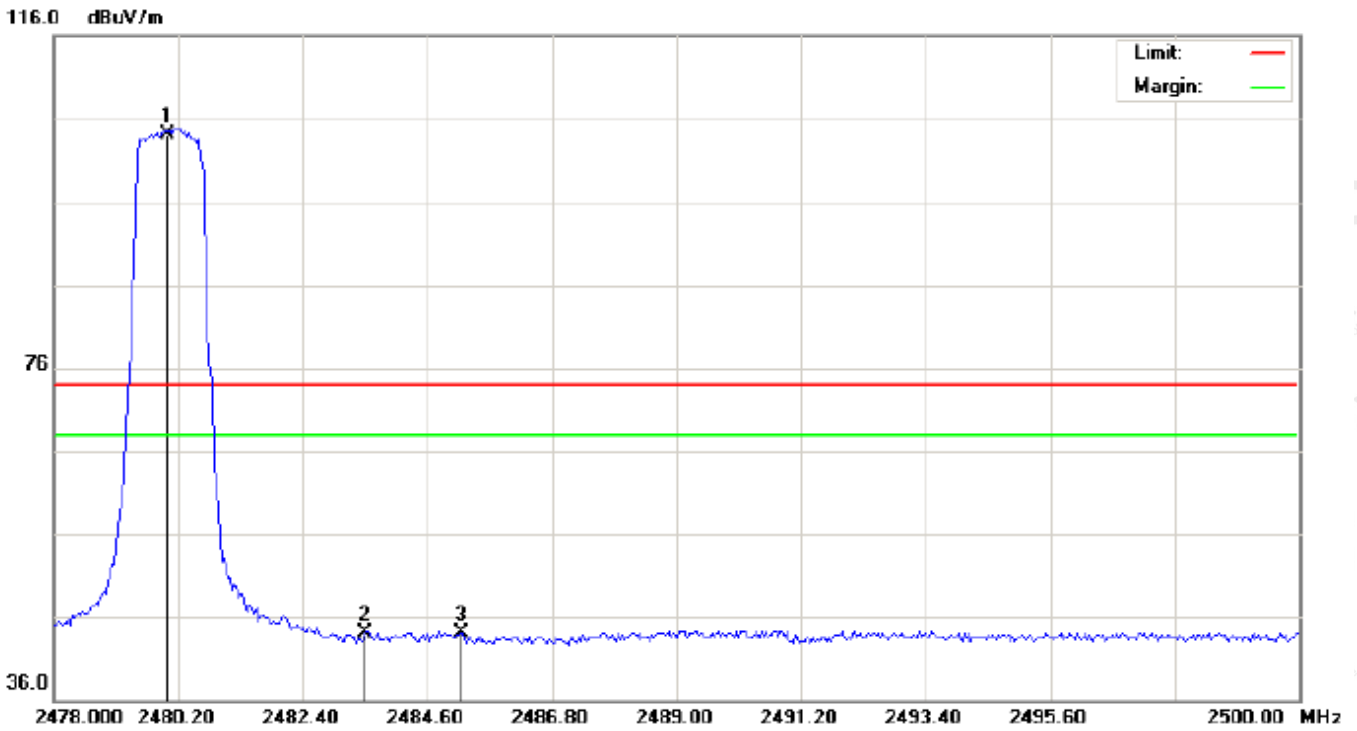

No.	Mk	Freq.	Reading	Factor	Measurement	Limit	Over	Detector	Antenna	Table	Comment
		MHz	dBuV	dB/m	dBuV/m	dBuV/m	dB		Height	Degree	
									cm	degree	
1	*	2480.000	93.64	10.41	104.05	74.00	30.05	peak			
2		2483.500	33.69	10.41	44.10	74.00	-29.90	peak			
3		2485.187	33.78	10.41	44.19	74.00	-29.81	peak			

The results shown in this test report refer only to the sample(s) tested unless otherwise stated and the sample(s) are retained for 30 days only. The document is issued by AGC, this document cannot be reproduced except in full with our prior written permission. The more details and the authenticity of the report will be confirmed at <http://www.agc-cert.com>.

TEST PLOT OF BAND EDGE FOR HIGH CHANNEL (3Mbps)-Vertical

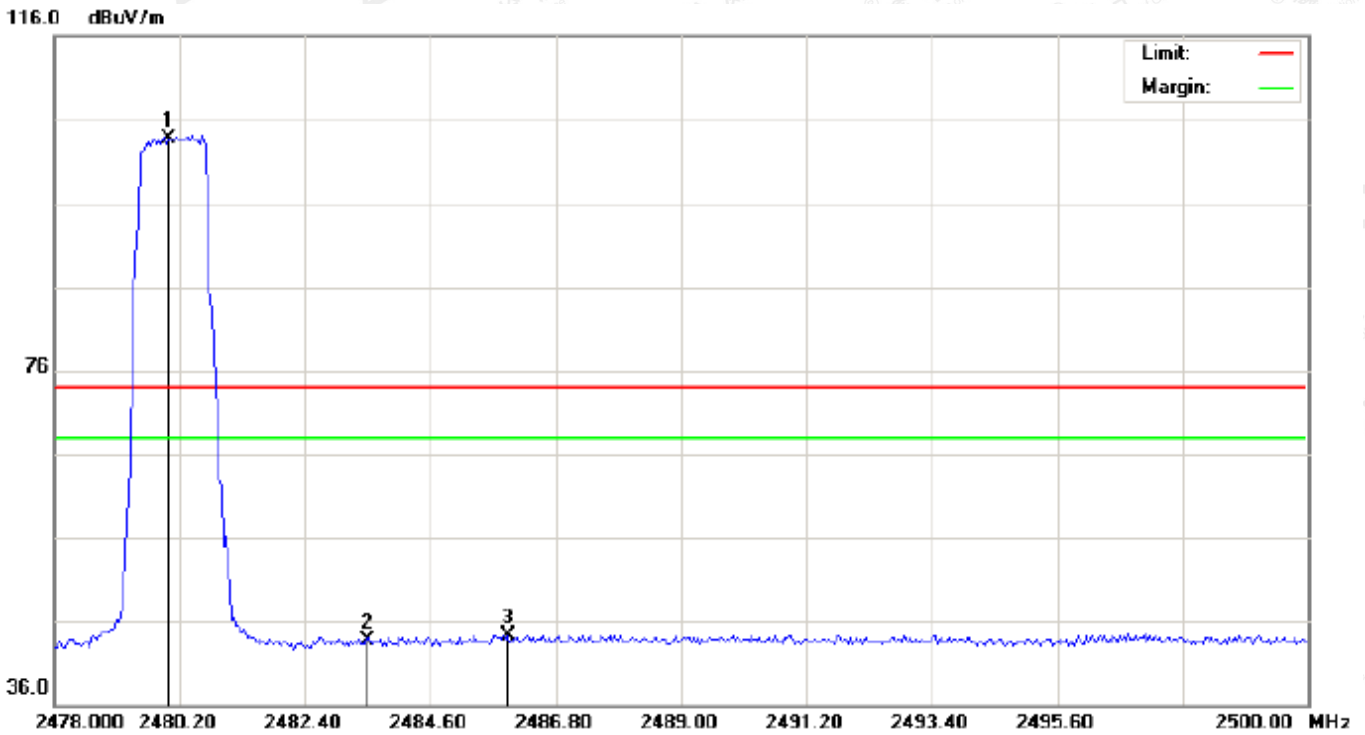

No.	Mk	Freq.	Reading	Factor	Measurement	Limit	Over	Detector	Antenna Height	Table Degree	Comment
		MHz	dBuV	dB/m	dBuV/m	dBuV/m	dB		cm	degree	
1	*	2480.000	93.29	10.41	103.70	74.00	29.70	peak			
2		2483.500	33.26	10.41	43.67	74.00	-30.33	peak			
3		2485.957	33.98	10.41	44.39	74.00	-29.61	peak			

RESULT: PASS

Note: 1. Factor=Antenna Factor + Cable loss, Margin=Measurement-Limit.

2. The "Factor" value can be calculated automatically by software of measurement system.
3. Hopping off and Hopping on have been tested and only worst case recorded

The results shown in this test report refer only to the sample(s) tested unless otherwise stated and the sample(s) are retained for 30 days only. The document is issued by AGC, this document cannot be reproduced except in full with our prior written permission. The more details and the authenticity of the report will be confirmed at <http://www.agc-cert.com>.

13. NUMBER OF HOPPING FREQUENCY

13.1. MEASUREMENT PROCEDURE

1. Place the EUT on the table and set it in transmitting mode.
2. Remove the antenna from the EUT and then connect a low RF cable from the antenna port to the spectrum analyzer.
3. Set the spectrum analyzer Start = 2.4GHz Stop = 2.4835GHz
4. Set the Spectrum Analyzer as RBW>=1%span, VBW>=3RBW.

13.2. TEST SETUP (BLOCK DIAGRAM OF CONFIGURATION)

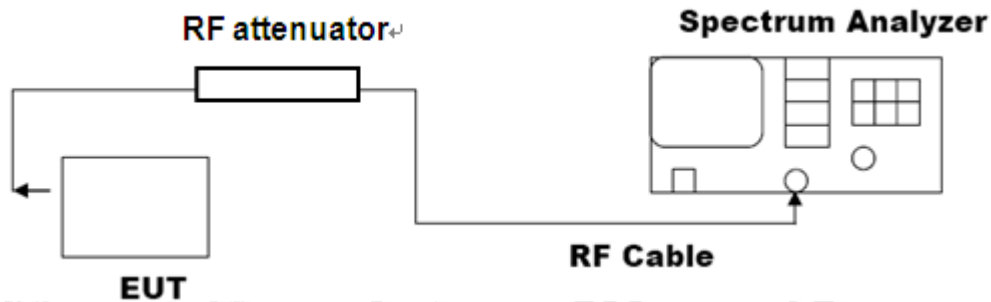

13.3. LIMITS AND MEASUREMENT RESULT

TOTAL NO. OF HOPPING CHANNEL	LIMIT (NO. OF CH)	MEASUREMENT (NO. OF CH)	RESULT
	>=15	79	PASS

The results shown in this test report refer only to the sample(s) tested unless otherwise stated and the sample(s) are retained for 30 days only. The document is issued by AGC, this document cannot be reproduced except in full with our prior written permission. The more details and the authenticity of the report will be confirmed at <http://www.agc-cert.com>.

TEST PLOT FOR NO. OF TOTAL CHANNELS

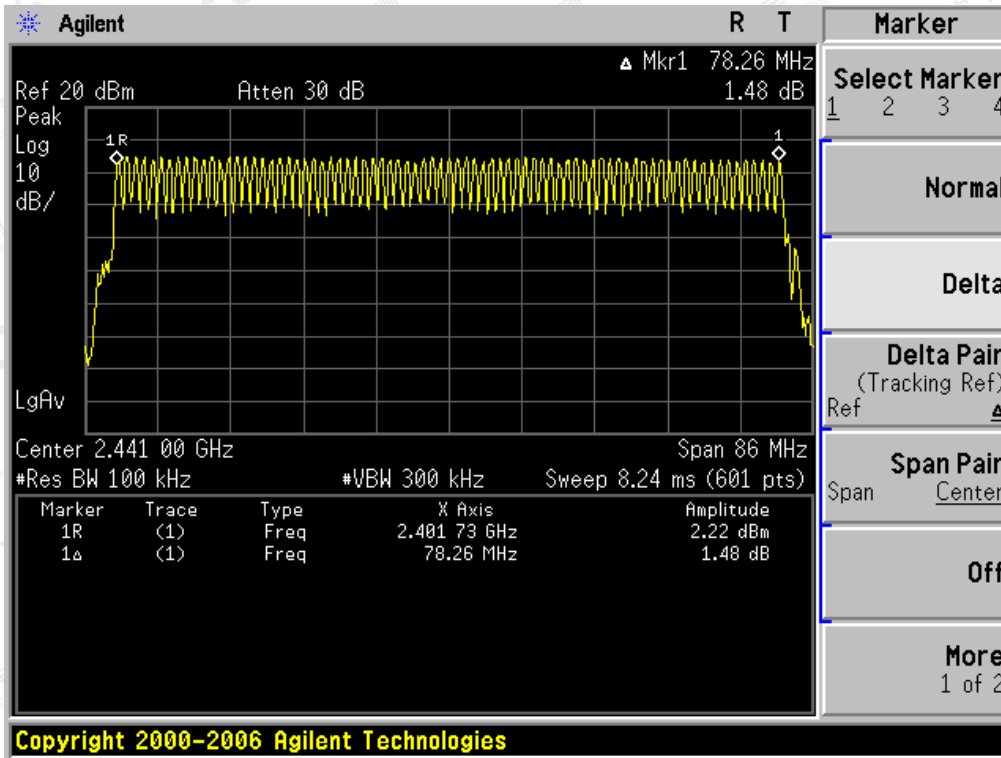

The results shown in this test report refer only to the sample(s) tested unless otherwise stated and the sample(s) are retained for 30 days only. The document is issued by AGC, this document cannot be reproduced except in full with our prior written permission. The more details and the authenticity of the report will be confirmed at <http://www.agc-cert.com>.

14. TIME OF OCCUPANCY (DWELL TIME)

14.1. MEASUREMENT PROCEDURE

1. Place the EUT on the table and set it in transmitting mode
2. Remove the antenna from the EUT and then connect a low RF cable from the antenna port to the spectrum analyzer.
3. Set Span = zero span, centered on a hopping channel
4. Set the spectrum analyzer as RBW=1MHz, VBW>=RBW, Span = 0 Hz

14.2. TEST SETUP (BLOCK DIAGRAM OF CONFIGURATION)

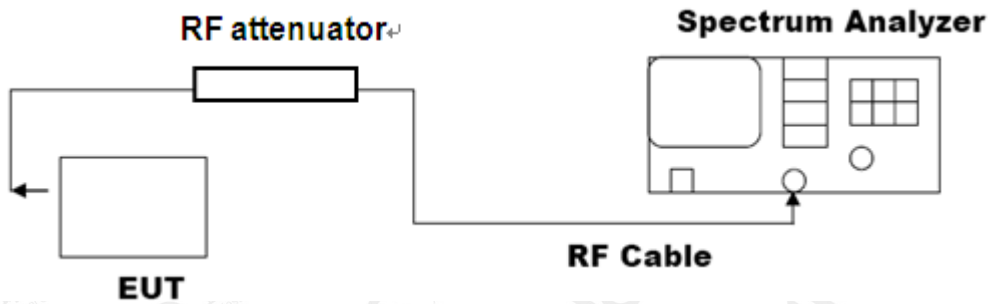

14.3. LIMITS AND MEASUREMENT RESULT

The Worst Case (3Mbps)

Channel	Time of Pulse for DH5 (ms)	Period Time (s)	Sweep Time (ms)	Limit (ms)
Low	2.935	31.6	313.07	400
Middle	2.935	31.6	313.07	400
High	2.935	31.6	313.07	400

Low Channel Time

$$2.935 * (1600/6) / 79 * 31.6 = 313.07 \text{ms}$$

Middle Channel Time

$$2.935 * (1600/6) / 79 * 31.6 = 313.07 \text{ms}$$

High Channel Time

$$2.935 * (1600/6) / 79 * 31.6 = 313.073 \text{ms}$$

The results shown in this test report refer only to the sample(s) tested unless otherwise stated and the sample(s) are retained for 30 days only. The document is issued by AGC, this document cannot be reproduced except in full with our prior written permission. The more details and the authenticity of the report will be confirmed at <http://www.agc-cert.com>.

TEST PLOT OF LOW CHANNEL

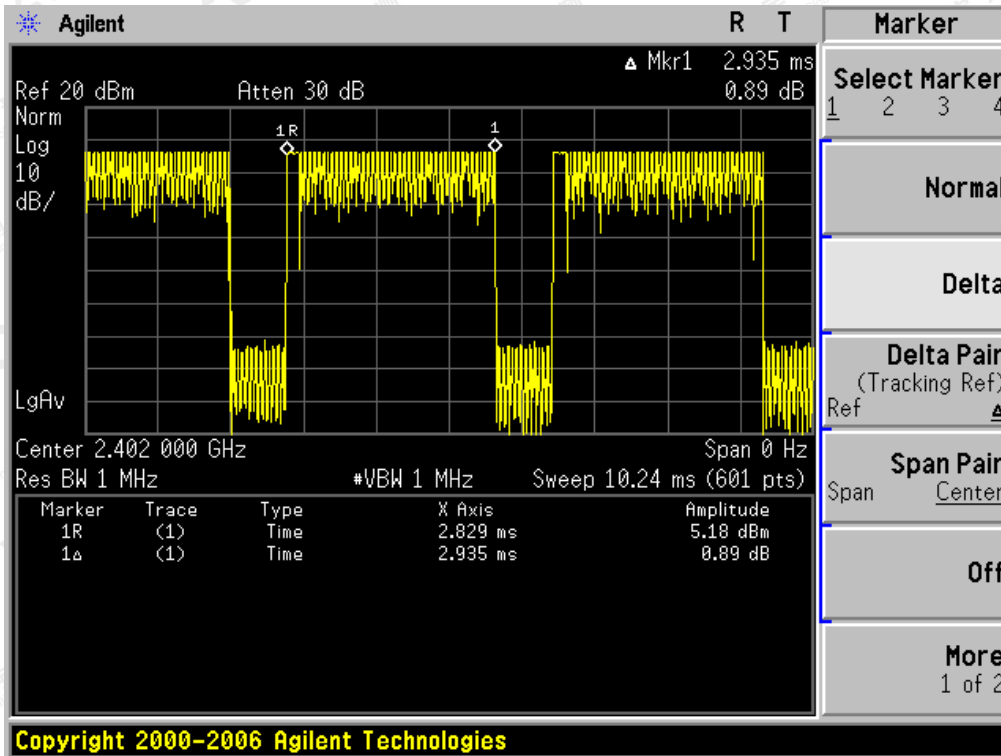

TEST PLOT OF MIDDLE CHANNEL

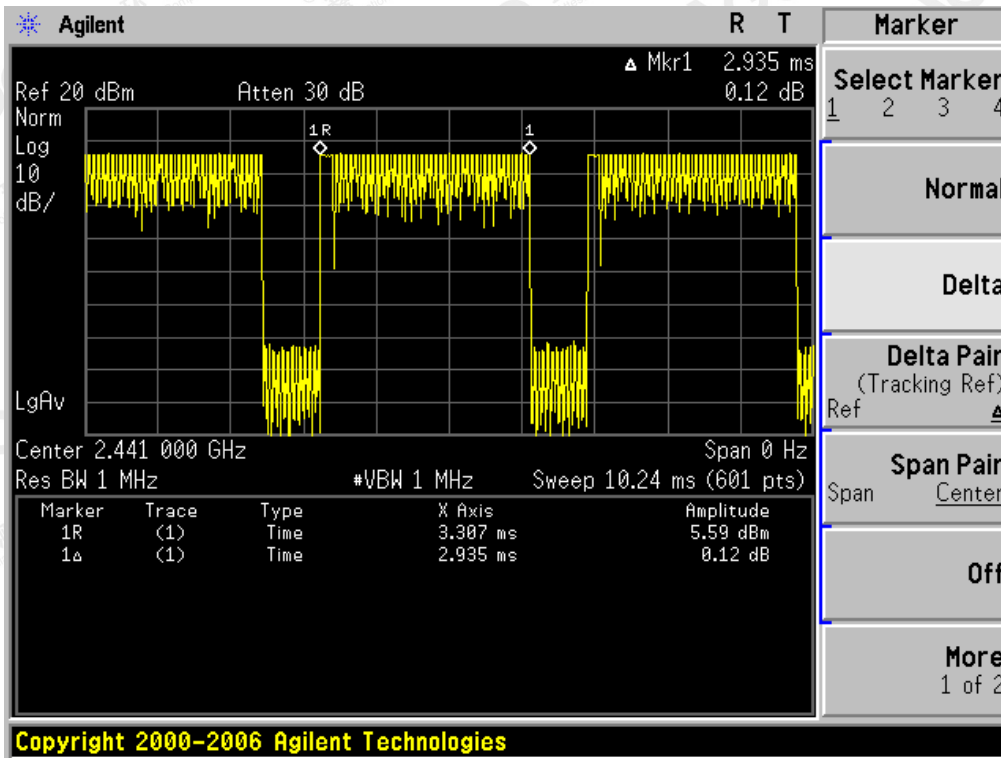

The results shown in this test report refer only to the sample(s) tested unless otherwise stated and the sample(s) are retained for 30 days only. The document is issued by AGC, this document cannot be reproduced except in full with our prior written permission. The more details and the authenticity of the report will be confirmed at <http://www.agc-cert.com>.

TEST PLOT OF HIGH CHANNEL

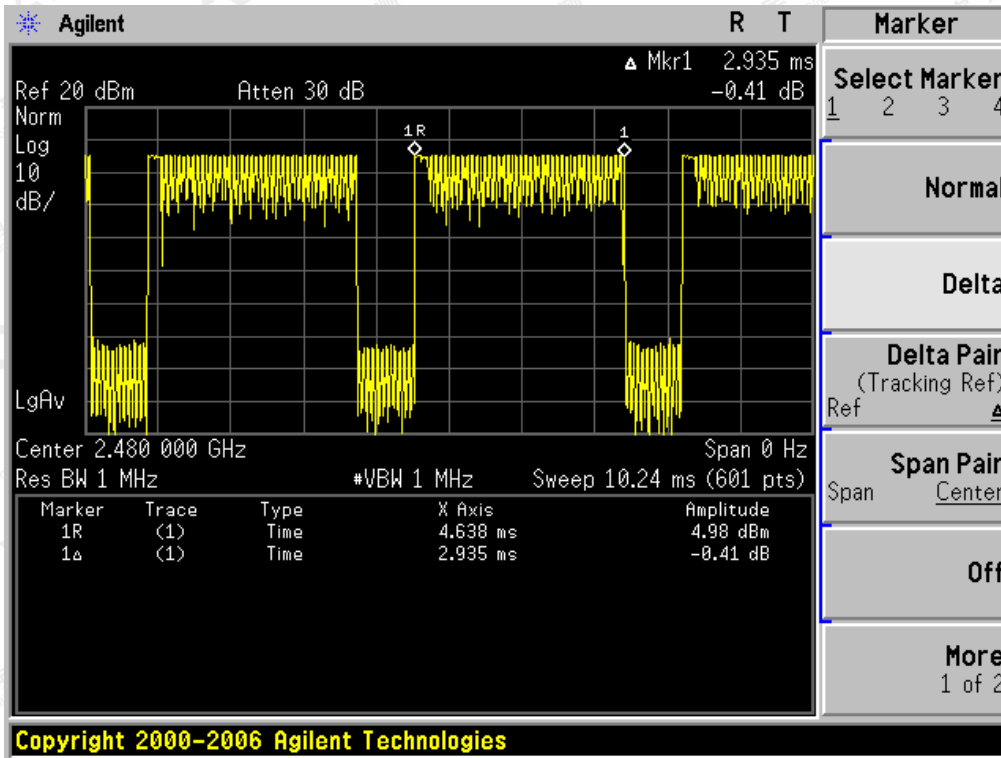

The results shown in this test report refer only to the sample(s) tested unless otherwise stated and the sample(s) are retained for 30 days only. The document is issued by AGC, this document cannot be reproduced except in full with our prior written permission. The more details and the authenticity of the report will be confirmed at <http://www.agc-cert.com>.

15. FREQUENCY SEPARATION

15.1. MEASUREMENT PROCEDURE

1. Place the EUT on the table and set it in transmitting mode
2. Remove the antenna from the EUT and then connect a low RF cable from the antenna port to the spectrum analyzer
3. Set Span = wide enough to capture the peaks of two adjacent channels Resolution (or IF) Bandwidth (RBW) \geq 1% of the span Video (or Average) Bandwidth (VBW) \geq RBW; Sweep = auto; Detector function = peak; Trace = max hold

15.2. TEST SETUP (BLOCK DIAGRAM OF CONFIGURATION)

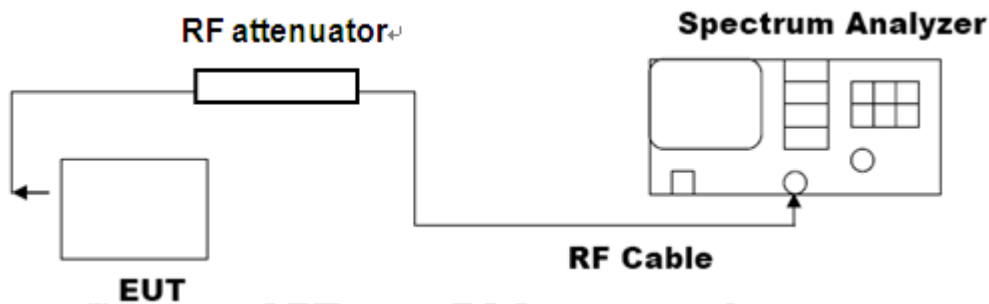

15.3. LIMITS AND MEASUREMENT RESULT

CHANNEL	CHANNEL SEPARATION	LIMIT	RESULT
	KHz	KHz	
CH00-CH01	1002	\geq 25 KHz or 2/3 20 dB BW	Pass

The results shown in this test report refer only to the sample(s) tested unless otherwise stated and the sample(s) are retained for 30 days only. The document is issued by AGC, this document cannot be reproduced except in full with our prior written permission. The more details and the authenticity of the report will be confirmed at <http://www.agc-cert.com>.

TEST PLOT FOR FREQUENCY SEPARATION (3Mbps)

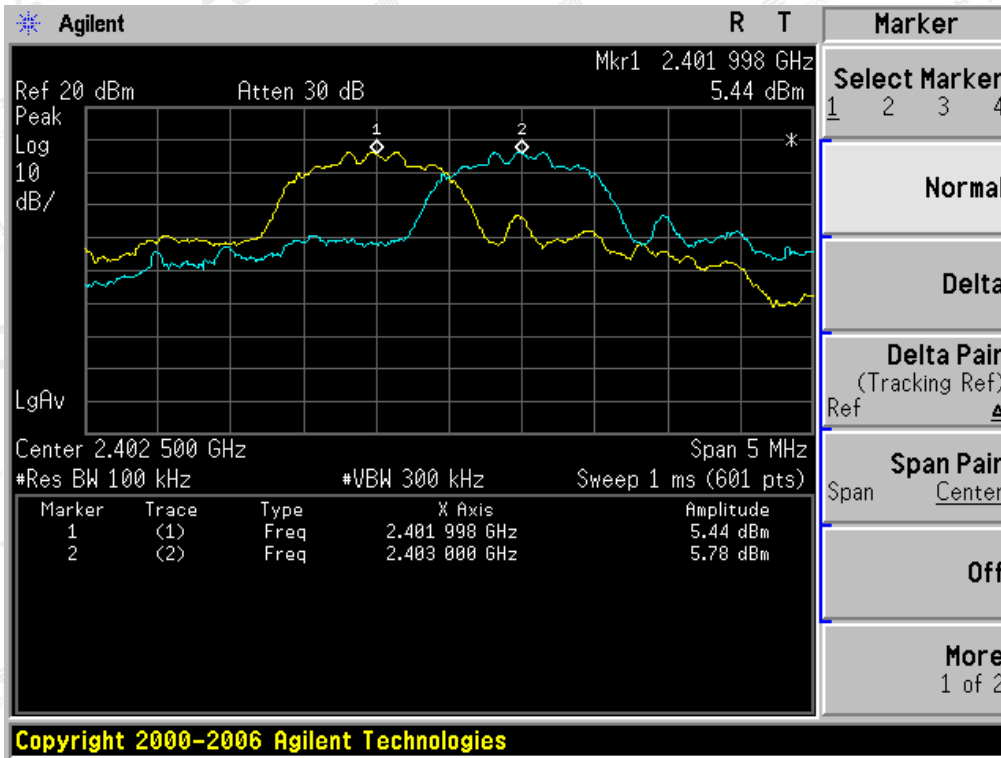

The results shown in this test report refer only to the sample(s) tested unless otherwise stated and the sample(s) are retained for 30 days only. The document is issued by AGC, this document cannot be reproduced except in full with our prior written permission. The more details and the authenticity of the report will be confirmed at <http://www.agc-cert.com>.

16. LINE CONDUCTED EMISSION TEST

16.1. LIMITS OF LINE CONDUCTED EMISSION TEST

Frequency	Maximum RF Line Voltage	
	Q.P.(dBuV)	Average(dBuV)
150kHz~500kHz	66-56	56-46
500kHz~5MHz	56	46
5MHz~30MHz	60	50

Note:

1. The lower limit shall apply at the transition frequency.
2. The limit decreases linearly with the logarithm of the frequency in the range 0.15 MHz to 0.50 MHz.

16.2. BLOCK DIAGRAM OF LINE CONDUCTED EMISSION TEST

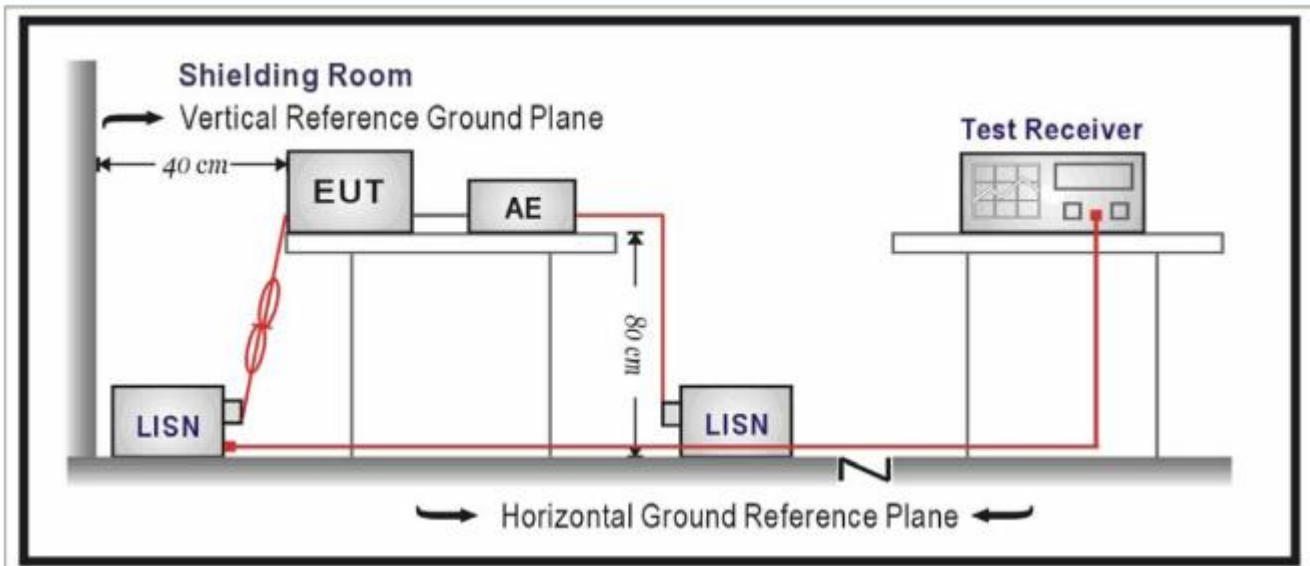

The results shown in this test report refer only to the sample(s) tested unless otherwise stated and the sample(s) are retained for 30 days only. The document is issued by AGC, this document cannot be reproduced except in full with our prior written permission. The more details and the authenticity of the report will be confirmed at <http://www.agc-cert.com>.

16.3. PRELIMINARY PROCEDURE OF LINE CONDUCTED EMISSION TEST

1. The equipment was set up as per the test configuration to simulate typical actual usage per the user's manual. When the EUT is a tabletop system, a wooden table with a height of 0.8 meters is used and is placed on the ground plane as per ANSI C63.10 (see Test Facility for the dimensions of the ground plane used). When the EUT is a floor-standing equipment, it is placed on the ground plane which has a 3-12 mm non-conductive covering to insulate the EUT from the ground plane.
2. Support equipment, if needed, was placed as per ANSI C63.10.
3. All I/O cables were positioned to simulate typical actual usage as per ANSI C63.10.
4. All support equipments received AC120V/60Hz power from a LISN, if any.
5. The EUT received DC charging voltage by adapter which received 120V/60Hz power by a LISN.
6. The test program was started. Emissions were measured on each current carrying line of the EUT using a spectrum Analyzer / Receiver connected to the LISN powering the EUT. The LISN has two monitoring points: Line 1 (Hot Side) and Line 2 (Neutral Side). Two scans were taken: one with Line 1 connected to Analyzer / Receiver and Line 2 connected to a 50 ohm load; the second scan had Line 1 connected to a 50 ohm load and Line 2 connected to the Analyzer / Receiver.
7. Analyzer / Receiver scanned from 150 kHz to 30MHz for emissions in each of the test modes.
8. During the above scans, the emissions were maximized by cable manipulation.
9. The test mode(s) were scanned during the preliminary test.

Then, the EUT configuration and cable configuration of the above highest emission level were recorded for reference of final testing.

16.4. FINAL PROCEDURE OF LINE CONDUCTED EMISSION TEST

1. EUT and support equipment was set up on the test bench as per step 2 of the preliminary test.
2. A scan was taken on both power lines, Line 1 and Line 2, recording at least the six highest emissions. Emission frequency and amplitude were recorded into a computer in which correction factors were used to calculate the emission level and compare reading to the applicable limit. If EUT emission level was less -2dB to the A.V. limit in Peak mode, then the emission signal was re-checked using Q.P and Average detector.
3. The test data of the worst case condition(s) was reported on the Summary Data page.

16.5. TEST RESULT OF LINE CONDUCTED EMISSION TEST

N/A

Note: The BT function of EUT didn't work when charging.

The results shown in this test report refer only to the sample(s) tested unless otherwise stated and the sample(s) are retained for 30 days only. The document is issued by AGC, this document cannot be reproduced except in full with our prior written permission. The more details and the authenticity of the report will be confirmed at <http://www.agc-cert.com>.

APPENDIX A: PHOTOGRAPHS OF TEST SETUP
FCC RADIATED EMISSION TEST SETUP

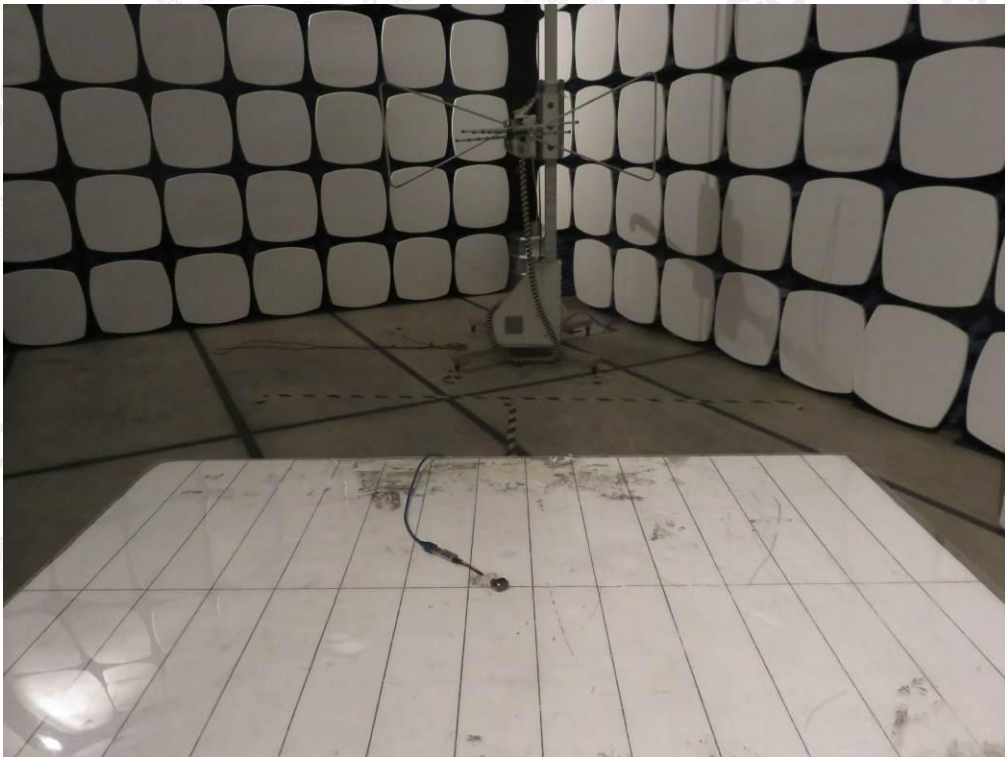
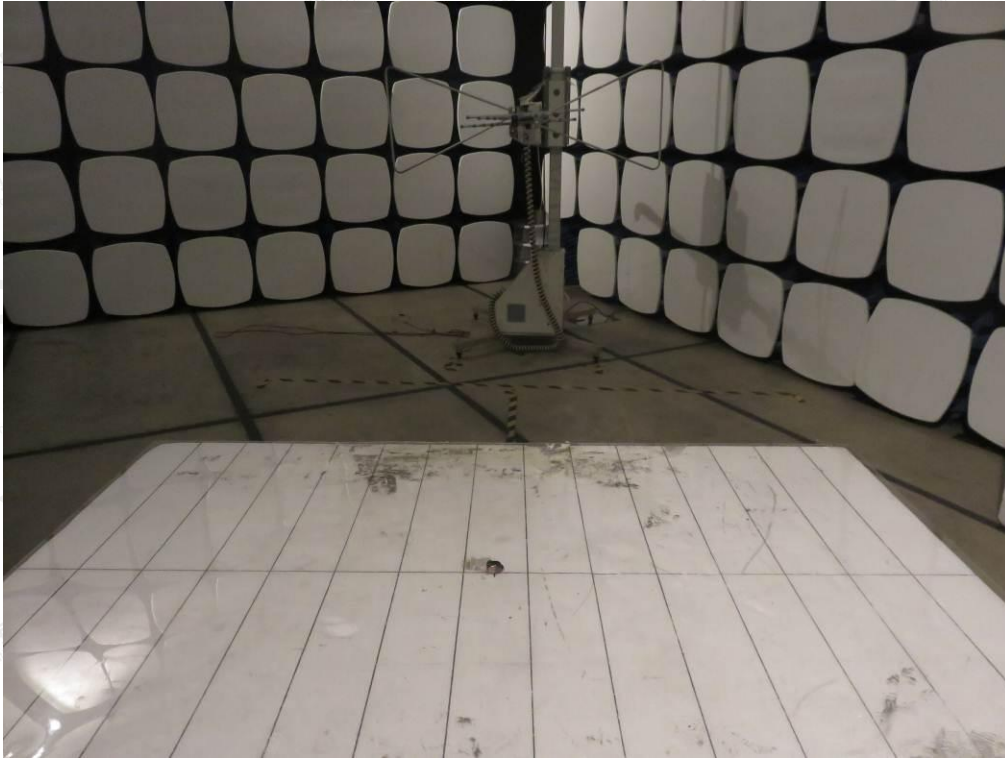

The results shown in this test report refer only to the sample(s) tested unless otherwise stated and the sample(s) are retained for 30 days only. The document is issued by AGC, this document cannot be reproduced except in full with our prior written permission. The more details and the authenticity of the report will be confirmed at <http://www.agc-cert.com>.

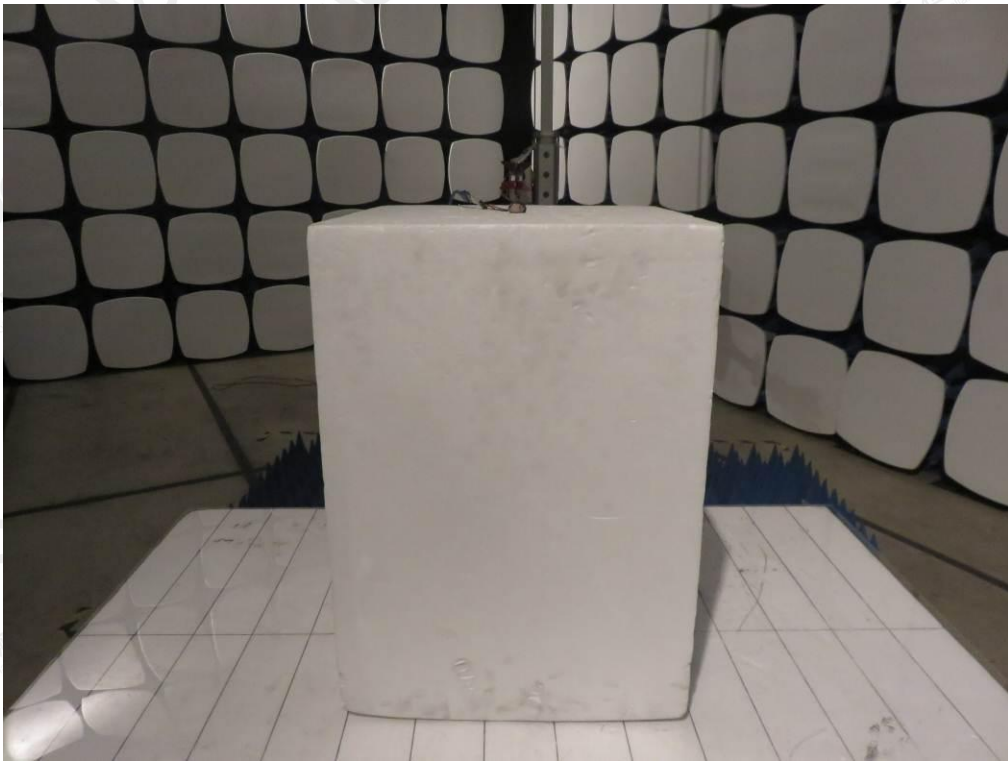
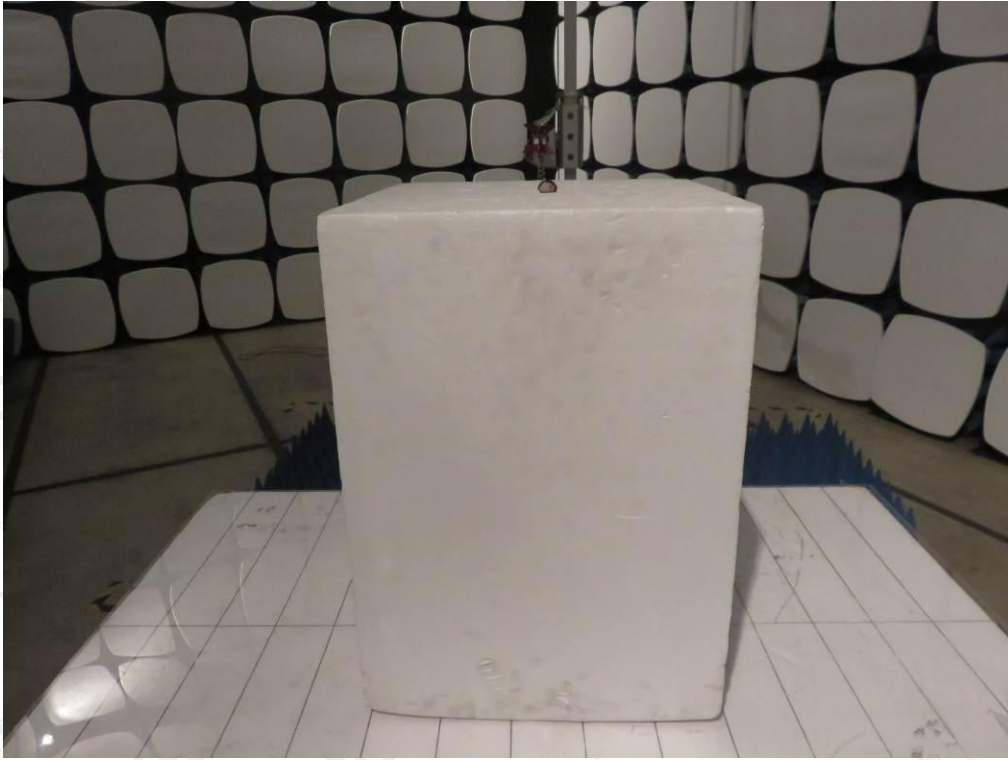

The results shown in this test report refer only to the sample(s) tested unless otherwise stated and the sample(s) are retained for 30 days only. The document is issued by AGC, this document cannot be reproduced except in full with our prior written permission. The more details and the authenticity of the report will be confirmed at <http://www.agc-cert.com>.

APPENDIX B: PHOTOGRAPHS OF EUT
WHOLE VIEW OF EUT



TOP VIEW OF EUT



The results shown in this test report refer only to the sample(s) tested unless otherwise stated and the sample(s) are retained for 30 days only. The document is issued by AGC, this document cannot be reproduced except in full with our prior written permission. The more details and the authenticity of the report will be confirmed at <http://www.agc-cert.com>.

BOTTOM VIEW OF EUT

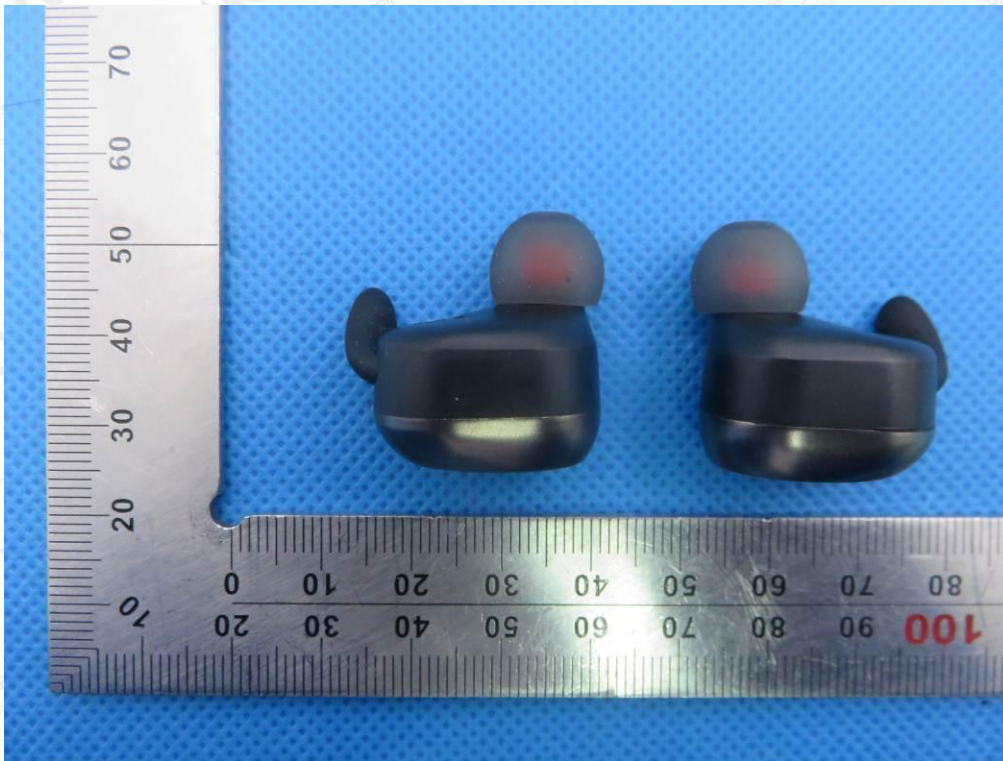

FRONT VIEW OF EUT

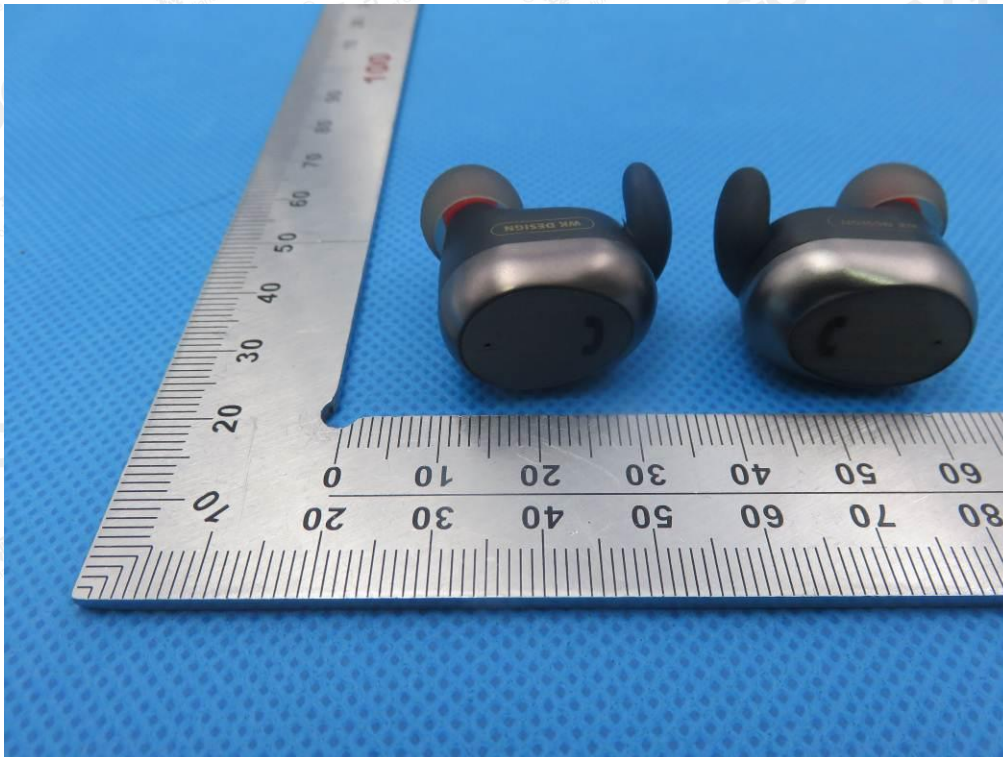

The results shown in this test report refer only to the sample(s) tested unless otherwise stated and the sample(s) are retained for 30 days only. The document is issued by AGC, this document cannot be reproduced except in full with our prior written permission. The more details and the authenticity of the report will be confirmed at <http://www.agc-cert.com>.

BACK VIEW OF EUT



LEFT VIEW OF EUT



The results shown in this test report refer only to the sample(s) tested unless otherwise stated and the sample(s) are retained for 30 days only. The document is issued by AGC, this document cannot be reproduced except in full with our prior written permission. The more details and the authenticity of the report will be confirmed at <http://www.agc-cert.com>.

RIGHT VIEW OF EUT



Left
VIEW OF EUT (PORT)

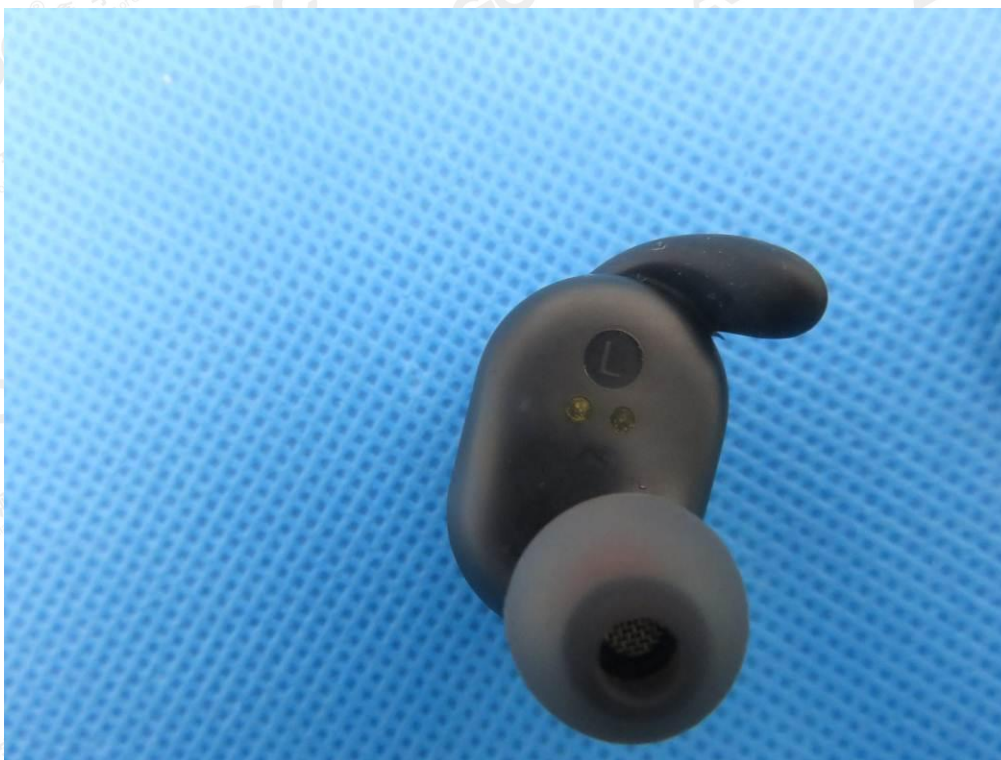

The results shown in this test report refer only to the sample(s) tested unless otherwise stated and the sample(s) are retained for 30 days only. The document is issued by AGC, this document cannot be reproduced except in full with our prior written permission. The more details and the authenticity of the report will be confirmed at <http://www.agc-cert.com>.

VIEW OF EUT (OPEN)

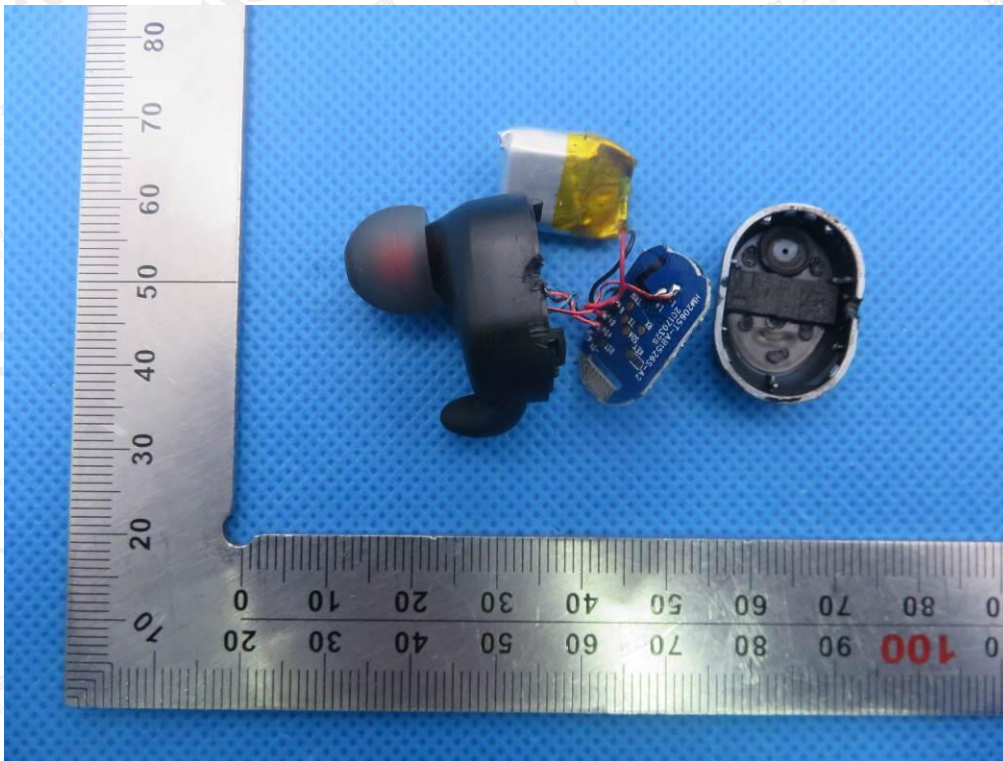

VIEW OF BATTERY



The results shown in this test report refer only to the sample(s) tested unless otherwise stated and the sample(s) are retained for 30 days only. The document is issued by AGC, this document cannot be reproduced except in full with our prior written permission. The more details and the authenticity of the report will be confirmed at <http://www.agc-cert.com>.

INTERNAL VIEW OF EUT-1

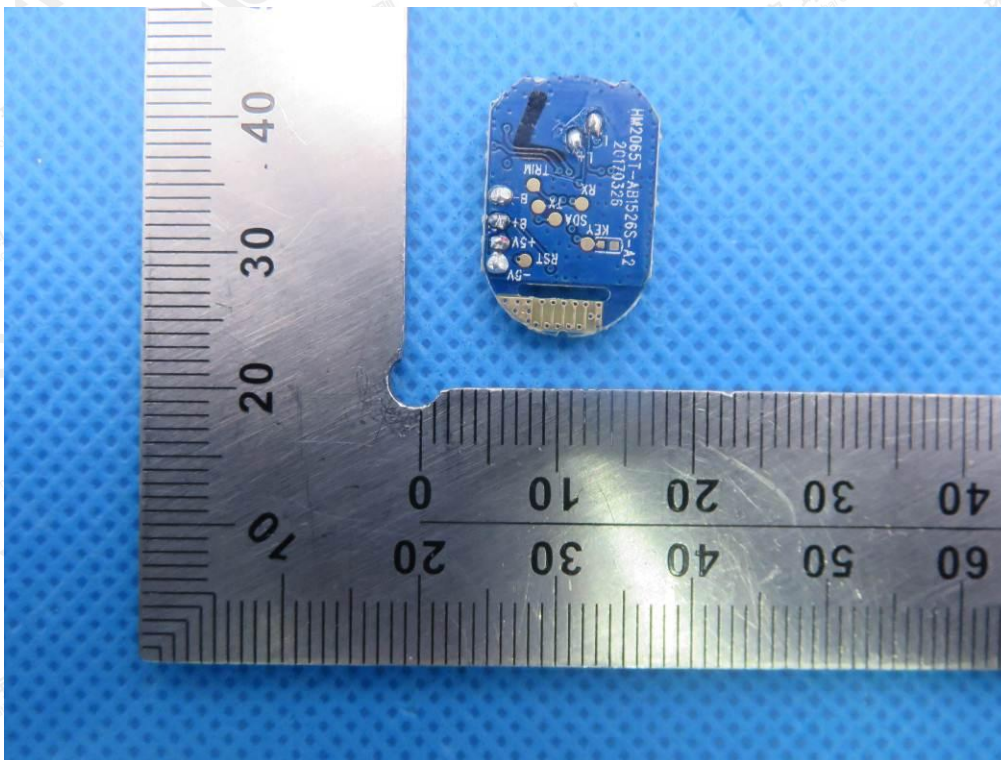

INTERNAL VIEW OF EUT-2

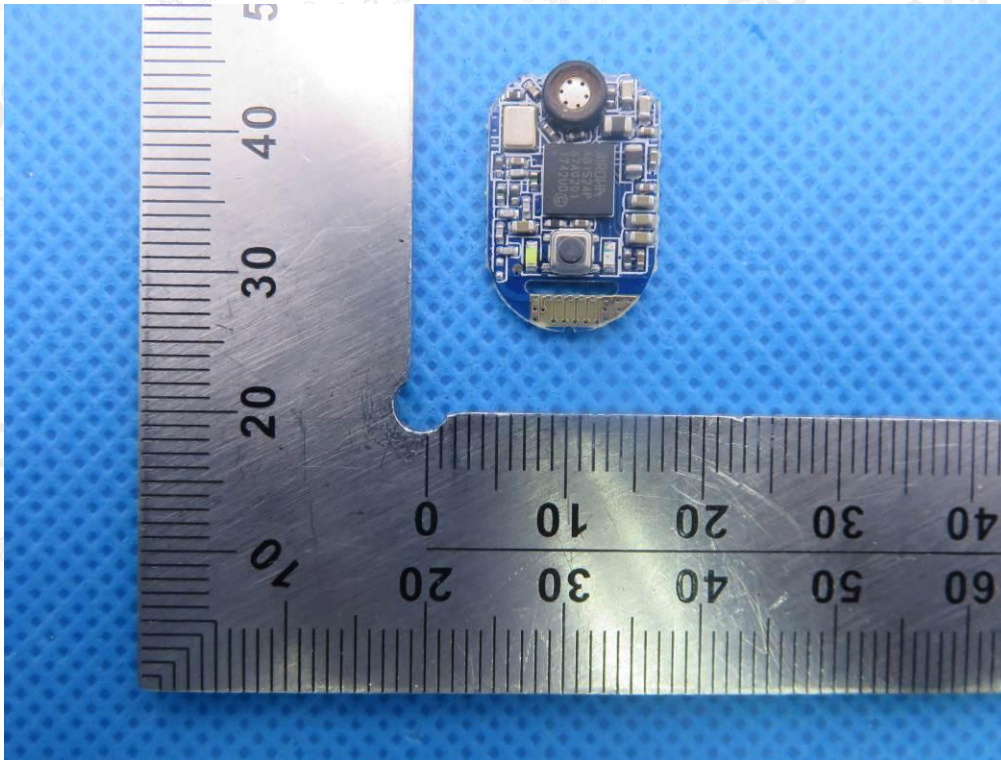

The results shown in this test report refer only to the sample(s) tested unless otherwise stated and the sample(s) are retained for 30 days only. The document is issued by AGC, this document cannot be reproduced except in full with our prior written permission. The more details and the authenticity of the report will be confirmed at <http://www.agc-cert.com>.

INTERNAL VIEW OF EUT-3

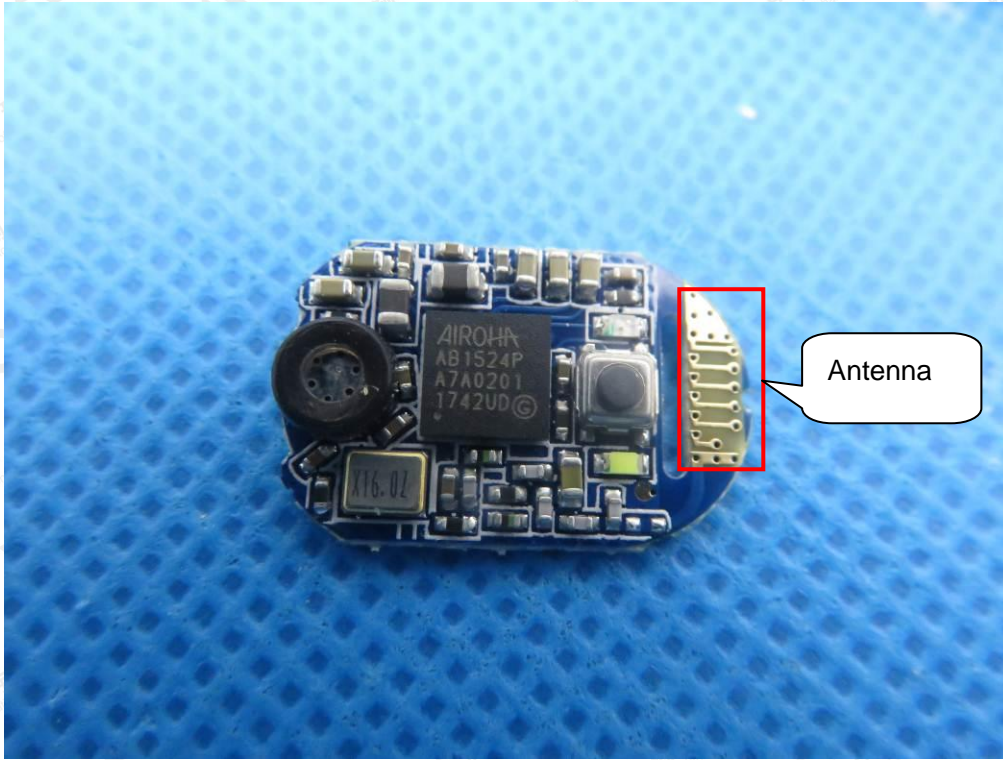

Right
VIEW OF EUT (PORT)



The results shown in this test report refer only to the sample(s) tested unless otherwise stated and the sample(s) are retained for 30 days only. The document is issued by AGC, this document cannot be reproduced except in full with our prior written permission. The more details and the authenticity of the report will be confirmed at <http://www.agc-cert.com>.

VIEW OF EUT (OPEN)

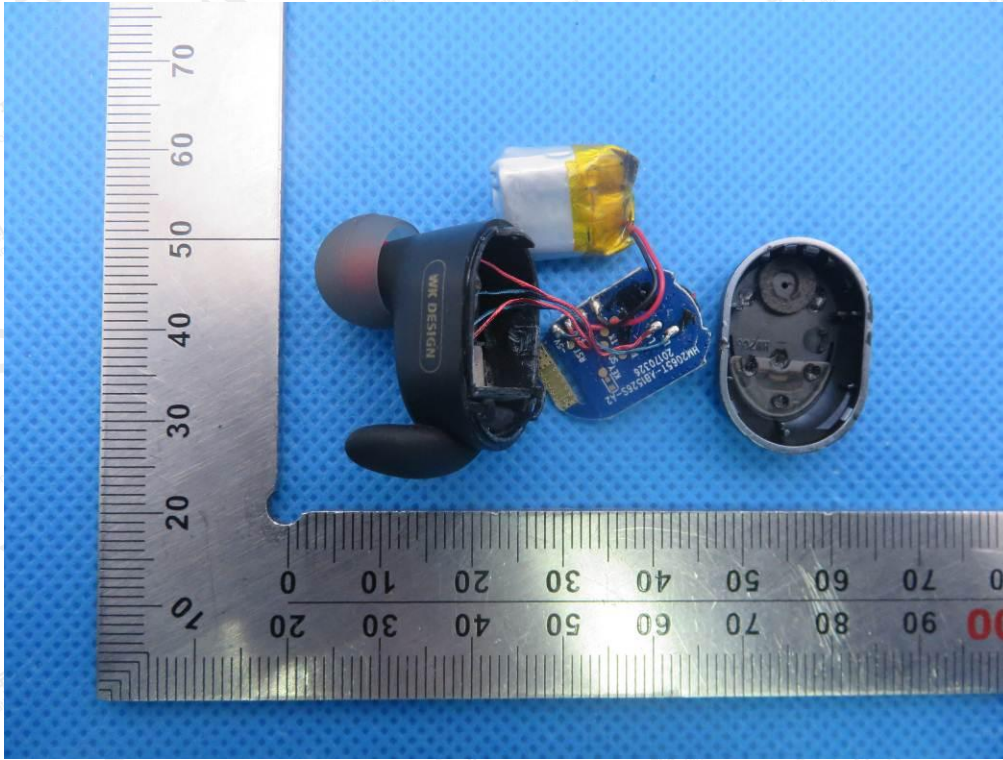

VIEW OF BATTERY



The results shown in this test report refer only to the sample(s) tested unless otherwise stated and the sample(s) are retained for 30 days only. The document is issued by AGC, this document cannot be reproduced except in full with our prior written permission. The more details and the authenticity of the report will be confirmed at <http://www.agc-cert.com>.

INTERNAL VIEW OF EUT-1

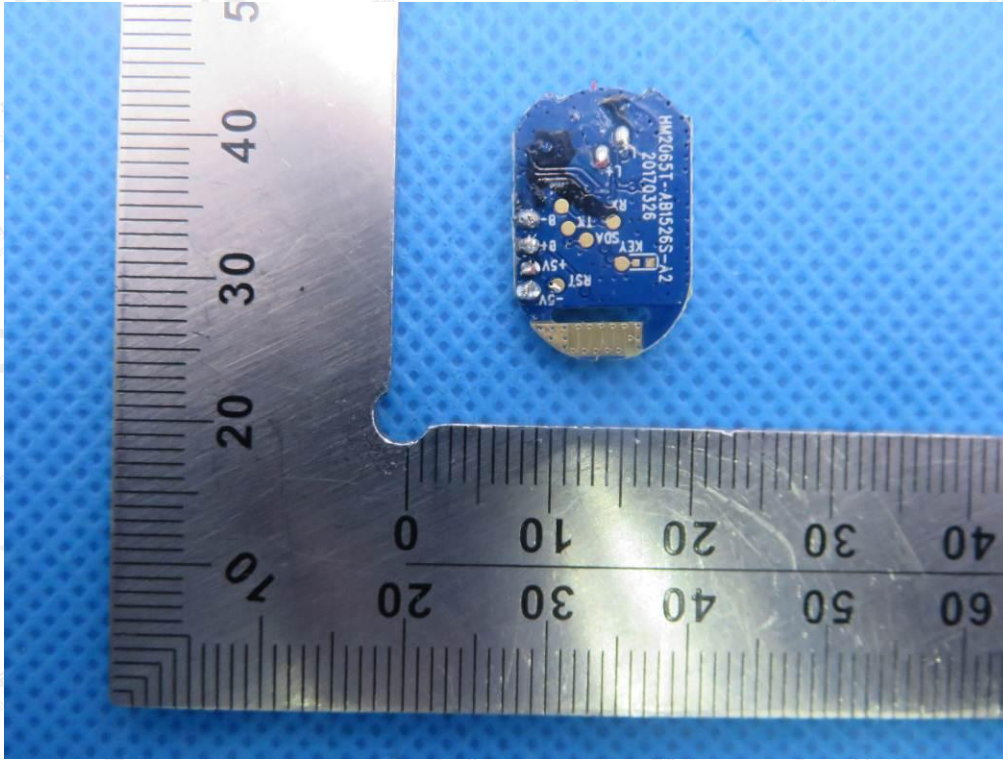

INTERNAL VIEW OF EUT-2

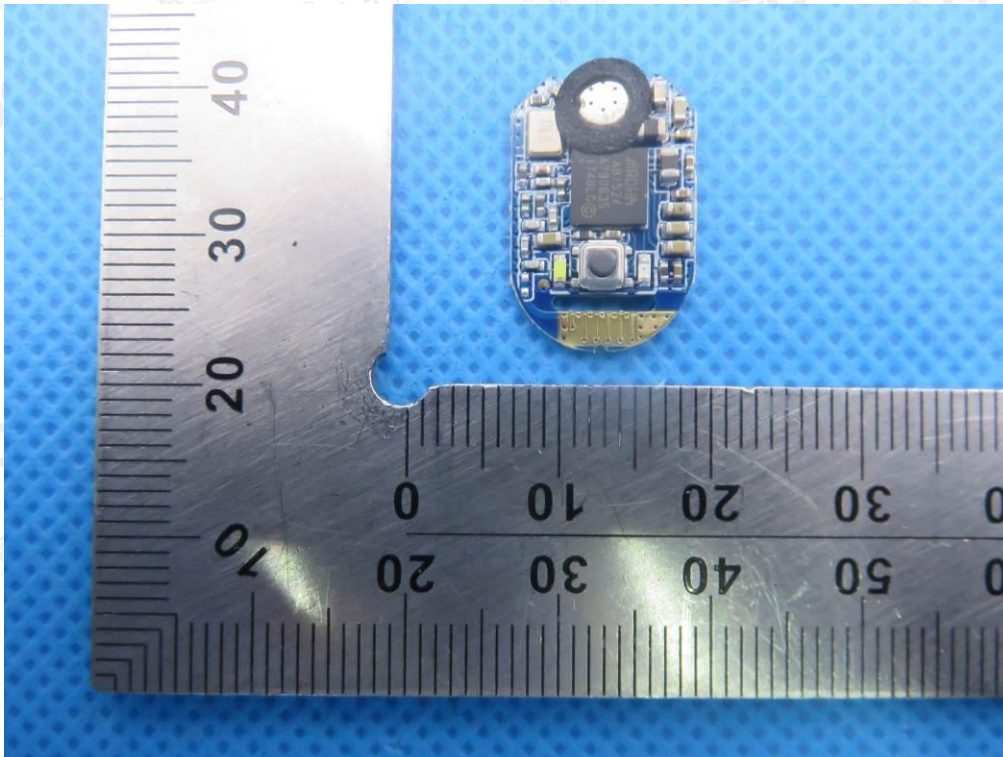

The results shown in this test report refer only to the sample(s) tested unless otherwise stated and the sample(s) are retained for 30 days only. The document is issued by AGC, this document cannot be reproduced except in full with our prior written permission. The more details and the authenticity of the report will be confirmed at <http://www.agc-cert.com>.

INTERNAL VIEW OF EUT-3

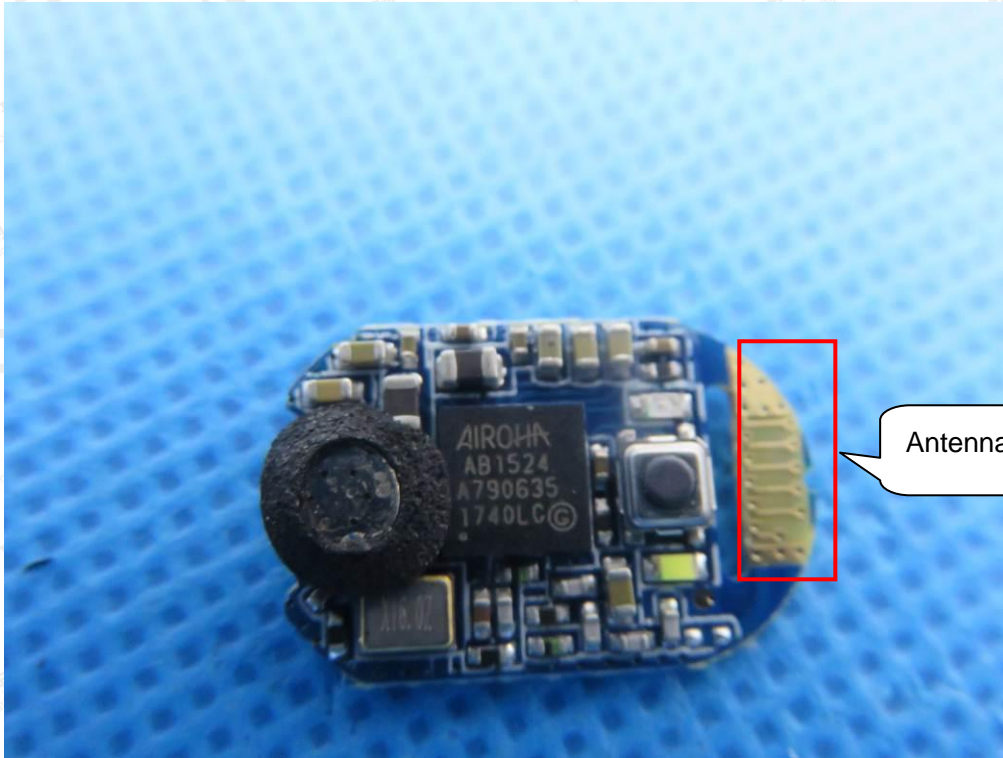

Charging Dock
VIEW OF EUT (PORT)-1



The results shown in this test report refer only to the sample(s) tested unless otherwise stated and the sample(s) are retained for 30 days only. The document is issued by AGC, this document cannot be reproduced except in full with our prior written permission. The more details and the authenticity of the report will be confirmed at <http://www.agc-cert.com>.

VIEW OF EUT (PORT)-2



----END OF REPORT----

The results shown in this test report refer only to the sample(s) tested unless otherwise stated and the sample(s) are retained for 30 days only. The document is issued by AGC, this document cannot be reproduced except in full with our prior written permission. The more details and the authenticity of the report will be confirmed at <http://www.agc-cert.com>.