

FCC REPORT

(LTE)

Applicant: PCD, LLC

Address of Applicant: 1500 Tradeport Drive, Orlando, Florida, 32824. United States

Equipment Under Test (EUT)

Product Name: Jaguar II LTE

Model No.: PL550

Trade mark: PCD

FCC ID: 2ALJJPL550

Applicable standards: FCC CFR Title 47 Part 2
FCC CFR Title 47 Part 24 Subpart E
FCC CFR Title 47 Part 27 Subpart L
FCC CFR Title 47 Part 27 Subpart H

Date of sample receipt: 10 Oct., 2019

Date of Test: 10 Oct., to 24 Oct., 2019

Date of report issued: 24 Oct., 2019

Test Result: PASS*

*In the configuration tested, the EUT complied with the standards specified above.

Authorized Signature:



Bruce Zhang
Laboratory Manager

This report details the results of the testing carried out on one sample. The results contained in this test report do not relate to other samples of the same product and does not permit the use of the CCIS product certification mark. The manufacturer should ensure that all products in series production are in conformity with the product sample detailed in this report.

This report may only be reproduced and distributed in full. If the product in this report is used in any configuration other than that detailed in the report, the manufacturer must ensure the new system complies with all relevant standards.

This document cannot be reproduced except in full, without prior written approval of the Company. Any unauthorized alteration, forgery or falsification of the content or appearance of this document is unlawful, and offenders may be prosecuted to the fullest extent of the law. Unless otherwise stated the results shown in this test report refer only to the sample(s) tested and such sample(s) are retained for 90 days only.

3. Contents

	Page
1. COVER PAGE	1
2. VERSION	2
3. CONTENTS	3
4. TEST SUMMARY	4
5. GENERAL INFORMATION	5
5.1 CLIENT INFORMATION.....	5
5.2 GENERAL DESCRIPTION OF E.U.T.....	5
5.3 TEST ENVIRONMENT AND MODE.....	9
5.4 DESCRIPTION OF SUPPORT UNITS.....	9
5.5 MEASUREMENT UNCERTAINTY.....	9
5.6 RELATED SUBMITTAL(S) / GRANT (S).....	9
5.7 ADDITIONS TO, DEVIATIONS, OR EXCLUSIONS FROM THE METHOD.....	9
5.8 LABORATORY FACILITY.....	9
5.9 LABORATORY LOCATION.....	10
5.10 TEST INSTRUMENTS LIST.....	10
6. TEST RESULTS	11
6.1 CONDUCTED OUTPUT POWER, ERP AND EIRP.....	11
6.2 PEAK-TO-AVERAGE RATIO.....	19
6.3 OCCUPY BANDWIDTH.....	22
6.4 OUT OF BAND EMISSION AT ANTENNA TERMINALS.....	54
6.5 FIELD STRENGTH OF SPURIOUS RADIATION MEASUREMENT.....	79
6.6 FREQUENCY STABILITY V.S. TEMPERATURE MEASUREMENT.....	86
6.7 FREQUENCY STABILITY V.S. VOLTAGE MEASUREMENT.....	90
7 TEST SETUP PHOTO	92
8 EUT CONSTRUCTIONAL DETAILS	93

4. Test Summary

Test Items	Section in CFR 47	Result
RF Exposure (SAR)	Part 1.1307 Part 2.1093	Passed (Please refer to SAR Report)
RF Output Power	Part 2.1046 Part 24.232 (c) Part 27.50 (c)(10) Part 27.50 (d)(4)	Pass
Peak-to-Average Ratio	Part 24.232 (d) Part 27.50(d)(5)	Pass
Modulation Characteristics	Part 2.1047	Pass
99% & -26 dB Occupied Bandwidth	Part 2.1049 Part 24.238(b) Part 27.53(g) Part 27.53(h)	Pass
Out of band emission at antenna terminals	Part 2.1053 Part 24.238 (a) Part 27.53 (g) Part 27.53 (h)	Pass
Field strength of spurious radiation	Part 24.238 (a) Part 27.53 (g) Part 27.53 (h)	Pass
Frequency stability vs. temperature	Part 22.355 Part 24.235 Part 27.54 Part 2.1055(a)(1)(b)	Pass
Frequency stability vs. voltage	Part 22.355 Part 24.235 Part 27.54 Part 2.1055(d)(2)	Pass
<p>Remark:</p> <ol style="list-style-type: none"> 1. Pass: The EUT complies with the essential requirements in the standard. 2. The cable insertion loss used by "RF Output Power" and other conduction measurement items is 0.5dB (provided by the customer). 		
Test Method:	ANSI/TIA-603-E-2016 ANSI C63.26-2015	

5. General Information

5.1 Client Information

Applicant:	PCD, LLC
Address:	1500 Tradeport Drive, Orlando, Florida, 32824. United States
Manufacturer:	PCD, LLC
Address:	1500 Tradeport Drive, Orlando, Florida, 32824. United States

5.2 General Description of E.U.T.

Product Name:	Jaguar II LTE
Model No.:	PL550
Operation Frequency range:	LTE Band 2: TX: 1850MHz-1910MHz, RX: 1930MHz-1990MHz LTE Band 4: TX: 1710MHz-1755MHz, RX: 2110MHz-2155MHz LTE Band 17: TX: 704MHz-716MHz, RX: 734MHz-746MHz
Modulation type:	QPSK, 16QAM
Antenna type:	Internal Antenna
Antenna gain:	LTE Band 2: 0.47dBi LTE Band 4: 0.37dBi LTE Band 17: -0.19dBi
Power supply:	Rechargeable Li-ion Battery DC3.8V-2500mAh
AC adapter:	Model: PL550 Input: AC100-240V, 50/60Hz, 0.2A Output: DC 5.0V, 1000mA
Test Sample Condition:	The applicant provided engineering samples for staying in continuously transmitting for testing.

Operation Frequency List:

LTE Band 2 (1.4MHz)		LTE Band 2 (3MHz)	
Channel	Frequency (MHz)	Channel	Frequency (MHz)
18607	1850.70	18615	1851.50
18608	1850.80	18616	1851.60
....
18899	1879.90	18899	1879.90
18900	1880.00	18900	1880.00
18901	1880.10	18901	1880.10
...
19193	1909.20	19185	1908.40
19194	1909.30	19186	1908.50
LTE Band 2 (5MHz)		LTE Band 2 (10MHz)	
Channel	Frequency (MHz)	Channel	Frequency (MHz)
18625	1852.50	18650	1855.00
18626	1852.60	18651	1855.10
....
18899	1879.90	18899	1879.90
18900	1880.00	18900	1880.00
18901	1880.10	18901	1880.10
...
19175	1907.40	19150	1904.90
19176	1907.50	19151	1905.00
LTE Band 2 (15MHz)		LTE Band 2 (20MHz)	
Channel	Frequency (MHz)	Channel	Frequency (MHz)
18675	1857.50	18700	1860.00
18676	1857.60	18701	1860.10
....
18899	1879.90	18899	1879.90
18900	1880.00	18900	1880.00
18901	1880.10	18901	1880.10
...
19125	1902.40	19100	1899.90
19126	1902.50	19101	1900.00

LTE Band 4 (1.4MHz)		LTE Band 4 (3MHz)	
Channel	Frequency (MHz)	Channel	Frequency (MHz)
19957	1710.70	19965	1711.50
19958	1710.80	19966	1711.60
....
20174	1732.40	20174	1732.40
20175	1732.50	20175	1732.50
20176	1732.60	20176	1732.60
...
20392	1754.20	20384	1753.40
20393	1754.30	20385	1753.50
LTE Band 4 (5MHz)		LTE Band 4 (10MHz)	
Channel	Frequency (MHz)	Channel	Frequency (MHz)
19975	1712.50	20000	1715.00
19976	1712.60	20001	1715.10
....
20174	1732.40	20174	1732.40
20175	1732.50	20175	1732.50
20176	1732.60	20176	1732.60
...
20374	1752.40	20349	1749.90
20375	1752.50	20350	1750.00
LTE Band 4 (15MHz)		LTE Band 4 (20MHz)	
Channel	Frequency (MHz)	Channel	Frequency (MHz)
20025	1717.50	20050	1720.00
20026	1717.60	20051	1720.10
....
20174	1732.40	20174	1732.40
20175	1732.50	20175	1732.50
20176	1732.60	20176	1732.60
...
20324	1747.40	20299	1744.90
20325	1747.50	20300	1745.00

LTE Band 17 (5MHz)		LTE Band 17 (10MHz)	
Channel	Frequency (MHz)	Channel	Frequency (MHz)
23755	706.50	23780	709.00
23756	706.60	23781	709.10
....
23789	709.90	23789	709.90
23790	710.00	23790	710.00
23791	710.10	23791	710.10
...
23824	713.40	23799	710.90
23825	713.50	23800	711.00

Regards to the operating frequency range, the lowest frequency, the middle frequency, and the highest frequency of channel were selected to perform the test, and the selected channels as below:

LTE Band 2 (1.4MHz)			LTE Band 2 (3MHz)		
Channel	Frequency (MHz)		Channel	Frequency (MHz)	
Lowest channel	18607	1850.70	Lowest channel	18615	1851.50
Middle channel	18900	1880.00	Middle channel	18900	1880.00
Highest channel	19193	1909.30	Highest channel	19185	1908.50
LTE Band 2 (5MHz)			LTE Band 2 (10MHz)		
Channel	Frequency (MHz)		Channel	Frequency (MHz)	
Lowest channel	18625	1852.50	Lowest channel	18650	1855.00
Middle channel	18900	1880.00	Middle channel	18900	1880.00
Highest channel	19175	1907.50	Highest channel	19150	1905.00
LTE Band 2 (15MHz)			LTE Band 2 (20MHz)		
Channel	Frequency (MHz)		Channel	Frequency (MHz)	
Lowest channel	18675	1857.50	Lowest channel	18700	1860.00
Middle channel	18900	1880.00	Middle channel	18900	1880.00
Highest channel	19125	1902.50	Highest channel	19100	1900.00

LTE Band 4 (1.4MHz)			LTE Band 4 (3MHz)		
Channel:	Frequency (MHz)		Channel	Frequency (MHz)	
Lowest channel	19957	1710.70	Lowest channel	19965	1711.50
Middle channel	20175	1732.50	Middle channel	20175	1732.50
Highest channel	20393	1754.30	Highest channel	20385	1753.50
LTE Band 4 (5MHz)			LTE Band 4 (10MHz)		
Channel	Frequency (MHz)		Channel	Frequency (MHz)	
Lowest channel	19975	1712.50	Lowest channel	20000	1715.00
Middle channel	20175	1732.50	Middle channel	20175	1732.50
Highest channel	20375	1752.50	Highest channel	20350	1750.00
LTE Band 4 (15MHz)			LTE Band 4 (20MHz)		
Channel	Frequency (MHz)		Channel	Frequency (MHz)	
Lowest channel	20025	1717.50	Lowest channel	20050	1720.00
Middle channel	20175	1732.50	Middle channel	20175	1732.50
Highest channel	20325	1747.50	Highest channel	20300	1745.00

LTE Band 17(5MHz)			LTE Band 17(10MHz)		
Channel	Frequency (MHz)		Channel	Frequency (MHz)	
Lowest channel	23755	706.50	Lowest channel	23780	709.00
Middle channel	23790	710.00	Middle channel	23790	710.00
Highest channel	23825	713.50	Highest channel	23800	711.00

5.3 Test environment and mode

Operating Environment:	
Temperature:	Normal: 15°C ~ 35°C, Extreme: -30°C ~ +50°C
Humidity:	20 % ~ 75 % RH
Atmospheric Pressure:	1008 mbar
Voltage:	Nominal: 3.8Vdc, Extreme: Low 3.5Vdc, High 4.35Vdc
Test mode:	
LTE QPSK mode	Keep the EUT communication with simulated station in QPSK mode
LTE 16-QAM mode	Keep the EUT communication with simulated station in 16-QAM mode
Remark: The EUT has been tested under continuous transmitting mode. Channel Low, Mid and High for each type band with rated data rate were chosen for full testing. The field strength of spurious radiation emission was measured as EUT stand-up position (H mode) and lie down position (E1, E2 mode) for these modes with power adaptor, earphone and Data cable. Just the worst case position (H mode) shown in report.	

5.4 Description of Support Units

Test Equipment	Manufacturer	Model No.	Serial No.
Simulated Station	Anritsu	MT8820C	6201026545

5.5 Measurement Uncertainty

Parameters	Expanded Uncertainty
Radiated Emission (9kHz ~ 30MHz)	±3.12 dB (k=2)
Radiated Emission (30MHz ~ 1000MHz)	±4.32 dB (k=2)
Radiated Emission (1GHz ~ 18GHz)	±5.38 dB (k=2)
Radiated Emission (18GHz ~ 40GHz)	±3.36 dB (k=2)

5.6 Related Submittal(s) / Grant (s)

This is an original grant, no related submittals and grants.
--

5.7 Additions to, deviations, or exclusions from the method

No

5.8 Laboratory Facility

<p>The test facility is recognized, certified, or accredited by the following organizations:</p> <ul style="list-style-type: none"> ● FCC - Designation No.: CN1211 Shenzhen Zhongjian Nanfang Testing Co., Ltd. has been accredited as a testing laboratory by FCC (Federal Communications Commission). The test firm Registration No. is 727551. ● ISED – CAB identifier.: CN0021 The 3m Semi-anechoic chamber of Shenzhen Zhongjian Nanfang Testing Co., Ltd. has been Registered by Certification and Engineering Bureau of Industry Canada for radio equipment testing with Registration No.: 10106A-1. ● CNAS - Registration No.: CNAS L6048 Shenzhen Zhongjian Nanfang Testing Co., Ltd. is accredited to ISO/IEC 17025:2005 General Requirements for the Competence of Testing and Calibration laboratories for the competence of testing. The Registration No. is CNAS L6048. ● A2LA - Registration No.: 4346.01 This laboratory is accredited in accordance with the recognized International Standard ISO/IEC 17025:2005 General requirements for the competence of testing and calibration laboratories. The test scope can be found as below link: https://portal.a2la.org/scopepdf/4346-01.pdf

5.9 Laboratory Location

Shenzhen Zhongjian Nanfang Testing Co., Ltd.
 Address: No. B-C, 1/F., Building 2, Laodong No.2 Industrial Park, Xixiang Road,
 Bao'an District, Shenzhen, Guangdong, China
 Tel: +86-755-23118282, Fax: +86-755-23116366
 Email: info@ccis-cb.com, Website: <http://www.ccis-cb.com>

5.10 Test Instruments list

Test Equipment	Manufacturer	Model No.	Serial No.	Cal. Date (mm-dd-yy)	Cal. Due date (mm-dd-yy)
3m SAC	SAEMC	9m*6m*6m	966	07-22-2017	07-21-2020
BiConiLog Antenna	SCHWARZBECK	VULB9163	497	03-18-2019	03-17-2020
Biconical Antenna	SCHWARZBECK	VUBA9117	359	06-22-2017	06-21-2020
Horn Antenna	SCHWARZBECK	BBHA9120D	916	03-18-2019	03-17-2020
Horn Antenna	SCHWARZBECK	BBHA9120D	1805	06-22-2017	06-21-2020
Horn Antenna	SCHWARZBECK	BBHA 9170	BBHA9170582	11-20-2018	11-19-2019
EMI Test Software	AUDIX	E3	Version: 6.110919b		
Pre-amplifier	HP	8447D	2944A09358	03-18-2019	03-17-2020
Pre-amplifier	CD	PAP-1G18	11804	03-18-2019	03-17-2020
Spectrum analyzer	Rohde & Schwarz	FSP30	101454	03-18-2019	03-17-2020
EMI Test Receiver	Rohde & Schwarz	ESRP7	101070	03-18-2019	03-17-2020
Spectrum Analyzer	Agilent	N9020A	MY50510123	11-07-2018	11-06-2019
Signal Generator	Rohde & Schwarz	SMX	835454/016	03-18-2019	03-17-2020
Signal Generator	R&S	SMR20	1008100050	03-18-2019	03-17-2020
RF Switch Unit	MWRFTTEST	MW200	N/A	N/A	N/A
Test Software	MWRFTTEST	MTS8200	Version: 2.0.0.0		
Cable	ZDECL	Z108-NJ-NJ-81	1608458	03-18-2019	03-17-2020
Cable	MICRO-COAX	MFR64639	K10742-5	03-18-2019	03-17-2020
Cable	SUHNER	SUCOFLEX100	58193/4PE	03-18-2019	03-17-2020
DC Power Supply	XinNuoEr	WYK-10020K	1409050110020	10-31-2018	10-30-2019
Temperature Humidity Chamber	HengPu	HPGDS-500	20140828008	09-24-2019	09-23-2020
Simulated Station	Rohde & Schwarz	CMW500	140493	07-16-2019	07-15-2020

6. Test results

6.1 Conducted Output Power, ERP and EIRP

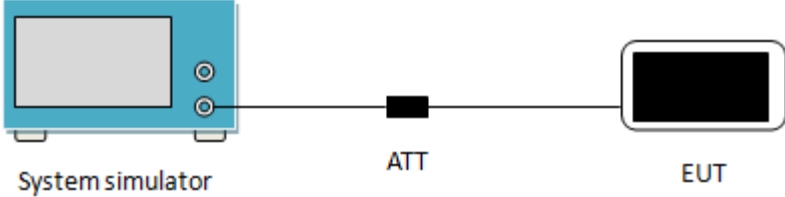
Test Requirement:	Part 24.232(c), part 27.50(c)(10), Part 27.50(d)(4)
Limit:	LTE Band 2: 2W, LTE Band 4: 1W, LTE Band 17: 3W
Test Setup:	 <p>The diagram illustrates the test setup. On the left is a blue 'System simulator' with a screen and two ports. A line connects it to a black 'ATT' (attenuator) block. Another line connects the 'ATT' to a black 'EUT' (Equipment Under Test) device.</p>
Test Procedure:	The transmitter output was connected to a calibrated attenuator, the other end of which was connected to the CMW500. Transmitter output power was read off in dBm.
Test Instruments:	Refer to section 5.10 for details
Test mode:	Refer to section 5.3 for details
Test results:	Passed

Measurement Data:

LTE Band	Bandwidth (MHz)	Modulation	RB Size	RB Offset	Average Power (dBm)				
					18607	18900	19193		
					1850.7MHz	1880.0MHz	1909.3MHz		
2	1.4	QPSK	1	0	21.91	21.81	21.49		
			1	2	21.98	21.90	21.78		
			1	5	21.94	21.67	21.54		
			3	0	21.12	20.84	20.67		
			3	1	21.13	20.81	20.73		
			3	2	21.02	20.85	20.80		
			6	0	21.11	21.01	20.93		
		Antenna Gain (dBi):					0.47		
		Max. EIRP (dBm):					22.45		
		EIRP Limit (dBm):					33.00		
		16QAM	1	0	21.06	21.13	21.48		
			1	2	21.29	21.15	21.74		
			1	5	21.28	21.11	21.61		
			3	0	20.35	20.13	20.71		
			3	1	20.29	20.04	20.86		
			3	2	20.12	20.00	20.68		
			6	0	20.02	20.01	20.04		
		Antenna Gain (dBi):					0.47		
		Max. EIRP (dBm):					22.21		
		EIRP Limit (dBm):					33.00		
LTE Band	Bandwidth (MHz)	Modulation	RB Size	RB Offset	Average Power (dBm)				
					18615	18900	19185		
					1851.5MHz	1880.0MHz	1908.5MHz		
2	3	QPSK	1	0	21.95	21.77	21.65		
			1	7	21.96	21.76	21.57		
			1	14	21.83	21.68	21.53		
			8	0	21.12	21.01	20.95		
			8	4	21.13	21.02	20.85		
			8	7	21.05	21.00	20.75		
			15	0	21.12	20.97	20.86		
		Antenna Gain (dBi):					0.47		
		Max. EIRP (dBm):					22.43		
		EIRP Limit (dBm):					33.00		
		16QAM	1	0	21.12	21.23	21.03		
			1	7	21.47	21.28	21.01		
			1	14	21.02	21.11	21.02		
			8	0	20.01	20.04	20.05		
			8	4	20.12	20.05	20.03		
			8	7	20.03	20.01	20.02		
			15	0	20.04	20.03	20.00		
		Antenna Gain (dBi):					0.47		
		Max. EIRP (dBm):					21.94		
		EIRP Limit (dBm):					33.00		

Note: EIRP (dBm) = Average power (dBm) + Antenna Gain (dBi).

LTE Band	Bandwidth (MHz)	Modulation	RB Size	RB Offset	Average Power (dBm)				
					18625	18900	19175		
					1852.5MHz	1880.0MHz	1907.5MHz		
2	5	QPSK	1	0	21.72	21.71	21.52		
			1	12	21.87	21.76	21.64		
			1	24	21.57	21.57	21.47		
			12	0	21.06	20.90	20.80		
			12	6	21.07	20.98	20.87		
			12	11	20.95	20.82	20.70		
			25	0	21.03	20.86	20.79		
		Antenna Gain (dBi):					0.47		
		Max. EIRP (dBm):					22.34		
		EIRP Limit (dBm):					33.00		
		16QAM	1	0	21.27	20.91	21.05		
			1	12	21.15	21.02	21.00		
			1	24	21.01	20.98	20.75		
			12	0	20.04	20.05	20.04		
			12	6	20.05	20.02	20.03		
			12	11	20.01	20.03	20.02		
			25	0	20.00	20.01	20.00		
		Antenna Gain (dBi):					0.47		
		Max. EIRP (dBm):					21.74		
		EIRP Limit (dBm):					33.00		

LTE Band	Bandwidth (MHz)	Modulation	RB Size	RB Offset	Average Power (dBm)				
					18650	18900	19150		
					1855.0MHz	1880.0MHz	1905.0MHz		
2	10	QPSK	1	0	21.80	21.69	21.23		
			1	24	21.98	21.93	21.21		
			1	49	21.86	21.97	21.11		
			25	0	21.13	20.90	20.54		
			25	12	21.14	20.96	20.38		
			25	24	20.98	20.93	20.40		
			50	0	21.06	20.87	20.35		
		Antenna Gain (dBi):					0.47		
		Max. EIRP (dBm):					22.45		
		EIRP Limit (dBm):					33.00		
		16QAM	1	0	21.04	20.85	20.63		
			1	24	21.08	21.01	20.75		
			1	49	21.09	21.07	20.40		
			25	0	20.10	20.08	20.05		
			25	12	20.02	20.06	20.03		
			25	24	20.00	20.04	20.02		
			50	0	20.01	20.00	20.01		
		Antenna Gain (dBi):					0.47		
		Max. EIRP (dBm):					21.56		
		EIRP Limit (dBm):					33.00		

Note: EIRP (dBm) = Average power (dBm) + Antenna Gain (dBi).

LTE Band	Bandwidth (MHz)	Modulation	RB Size	RB Offset	Average Power (dBm)				
					18675	18900	19125		
					1857.5MHz	1880.0MHz	1902.5MHz		
2	15	QPSK	1	0	21.44	21.23	21.04		
			1	37	21.59	21.39	21.23		
			1	74	21.25	21.38	21.06		
			36	0	20.60	20.42	20.40		
			36	16	20.67	20.53	20.42		
			36	35	20.53	20.40	20.48		
			75	0	20.61	20.47	20.34		
		Antenna Gain (dBi):					0.47		
		Max. EIRP (dBm):					22.06		
		EIRP Limit (dBm):					33.00		
		16QAM	1	0	21.02	20.95	20.86		
			1	37	21.25	21.04	21.02		
			1	74	21.03	21.02	20.60		
			36	0	20.12	20.11	20.08		
			36	16	20.05	20.08	20.05		
			36	35	20.11	20.07	20.04		
			75	0	20.05	20.03	20.02		
		Antenna Gain (dBi):					0.47		
		Max. EIRP (dBm):					21.72		
		EIRP Limit (dBm):					33.00		
		LTE Band	Bandwidth (MHz)	Modulation	RB Size	RB Offset	Average Power (dBm)		
18700	18900						19100		
1860.0MHz	1880.0MHz						1900.0MHz		
2	20	QPSK	1	0	21.67	21.42	21.31		
			1	49	21.86	21.61	21.63		
			1	99	21.68	21.57	21.40		
			50	0	21.07	20.73	20.82		
			50	24	21.04	20.81	20.74		
			50	49	20.95	20.71	20.78		
			100	0	21.06	20.87	20.71		
		Antenna Gain (dBi):					0.47		
		Max. EIRP (dBm):					22.33		
		EIRP Limit (dBm):					33.00		
		16QAM	1	0	20.86	20.77	20.65		
			1	49	21.30	20.97	21.07		
			1	99	20.84	20.67	20.49		
			50	0	20.12	20.07	20.11		
			50	24	20.14	20.05	20.08		
			50	49	20.08	20.03	20.04		
			100	0	20.07	20.01	20.02		
		Antenna Gain (dBi):					0.47		
		Max. EIRP (dBm):					21.77		
		EIRP Limit (dBm):					33.00		

Note: EIRP (dBm) = Average power (dBm) + Antenna Gain (dBi).

LTE Band	Bandwidth (MHz)	Modulation	RB Size	RB Offset	Average Power (dBm)				
					19957	20175	20393		
					1710.7MHz	1732.5MHz	1754.3MHz		
4	1.4	QPSK	1	0	22.03	21.88	21.95		
			1	2	22.30	22.18	21.04		
			1	5	22.00	22.07	21.96		
			3	0	21.17	21.06	21.05		
			3	1	21.20	21.17	21.31		
			3	2	21.07	21.22	21.04		
			6	0	21.14	21.13	21.15		
		Antenna Gain (dBi):					0.37		
		Max. EIRP (dBm):					22.67		
		EIRP Limit (dBm):					30.00		
		16QAM	1	0	21.58	21.08	21.28		
			1	2	21.34	21.28	21.19		
			1	5	21.48	21.19	21.06		
			3	0	20.31	20.07	20.17		
			3	1	20.37	20.24	20.11		
			3	2	20.17	20.06	20.20		
			6	0	20.20	20.12	20.07		
		Antenna Gain (dBi):					0.37		
		Max. EIRP (dBm):					21.95		
		EIRP Limit (dBm):					30.00		
		LTE Band	Bandwidth (MHz)	Modulation	RB Size	RB Offset	Average Power (dBm)		
19965	20175						20385		
1711.5MHz	1732.5MHz						1753.5MHz		
4	3	QPSK	1	0	22.11	21.95	21.86		
			1	7	22.12	22.06	21.99		
			1	14	21.98	21.96	21.89		
			8	0	21.19	21.14	21.05		
			8	4	21.23	21.20	21.22		
			8	7	21.13	21.05	21.09		
			15	0	21.06	21.09	21.07		
		Antenna Gain (dBi):					0.37		
		Max. EIRP (dBm):					22.49		
		EIRP Limit (dBm):					30.00		
		16QAM	1	0	21.52	21.16	20.87		
			1	7	21.29	21.15	21.04		
			1	14	21.13	21.07	20.93		
			8	0	20.13	20.08	20.08		
			8	4	20.22	20.11	20.06		
			8	7	20.04	20.10	20.05		
			15	0	20.18	20.08	20.02		
		Antenna Gain (dBi):					0.37		
		Max. EIRP (dBm):					21.89		
		EIRP Limit (dBm):					30.00		

Note: EIRP (dBm) = Average power (dBm) + Antenna Gain (dBi).

LTE Band	Bandwidth (MHz)	Modulation	RB Size	RB Offset	Average Power (dBm)				
					19975	20175	20375		
					1712.5MHz	1732.5MHz	1752.5MHz		
4	5	QPSK	1	0	21.43	21.25	21.37		
			1	12	21.67	21.63	21.58		
			1	24	21.44	21.44	21.39		
			12	0	20.56	20.57	20.54		
			12	6	20.58	20.65	20.60		
			12	11	20.55	20.49	20.52		
			25	0	20.65	20.61	20.51		
		Antenna Gain (dBi):					0.37		
		Max. EIRP (dBm):					22.04		
		EIRP Limit (dBm):					30.00		
		16QAM	1	0	20.48	20.45	20.45		
			1	12	20.78	20.65	20.69		
			1	24	20.82	20.81	20.52		
			12	0	20.08	20.12	20.05		
			12	6	20.05	20.07	20.03		
			12	11	20.04	20.06	20.02		
			25	0	20.01	20.03	20.00		
		Antenna Gain (dBi):					0.37		
		Max. EIRP (dBm):					21.19		
		EIRP Limit (dBm):					30.00		
		LTE Band	Bandwidth (MHz)	Modulation	RB Size	RB Offset	Average Power (dBm)		
20000	20175						20350		
1715.0MHz	1732.5MHz						1750.0MHz		
4	10	QPSK	1	0	22.03	21.87	22.01		
			1	24	22.15	22.20	22.33		
			1	49	21.90	21.93	21.95		
			25	0	21.21	21.17	21.20		
			25	12	21.16	21.14	21.14		
			25	24	21.18	21.11	21.10		
			50	0	21.15	21.10	21.19		
		Antenna Gain (dBi):					0.37		
		Max. EIRP (dBm):					22.70		
		EIRP Limit (dBm):					30.00		
		16QAM	1	0	21.40	21.42	21.36		
			1	24	21.41	21.37	21.50		
			1	49	21.03	21.08	21.12		
			25	0	20.16	20.10	20.18		
			25	12	20.17	20.08	20.11		
			25	24	20.10	20.13	20.15		
			50	0	20.21	20.16	20.15		
		Antenna Gain (dBi):					0.37		
		Max. EIRP (dBm):					21.87		
		EIRP Limit (dBm):					30.00		

Note: EIRP (dBm) = Average power (dBm) + Antenna Gain (dBi).

LTE Band	Bandwidth (MHz)	Modulation	RB Size	RB Offset	Average Power (dBm)				
					20025	20175	20325		
					1717.5MHz	1732.5MHz	1747.5MHz		
4	15	QPSK	1	0	21.88	22.07	22.00		
			1	37	22.03	22.15	22.06		
			1	74	21.89	21.95	22.22		
			36	0	21.16	21.15	21.23		
			36	16	21.10	21.09	21.11		
			36	35	21.13	21.11	21.08		
			75	0	21.20	21.08	21.22		
		Antenna Gain (dBi):					0.37		
		Max. EIRP (dBm):					22.59		
		EIRP Limit (dBm):					30.00		
		16QAM	1	0	21.68	21.14	21.62		
			1	37	21.76	21.17	21.39		
			1	74	21.14	21.09	21.50		
			36	0	20.21	20.14	20.24		
			36	16	20.16	20.07	20.12		
			36	35	20.24	20.10	20.11		
			75	0	20.18	20.17	20.12		
		Antenna Gain (dBi):					0.37		
		Max. EIRP (dBm):					22.13		
		EIRP Limit (dBm):					30.00		
		LTE Band	Bandwidth (MHz)	Modulation	RB Size	RB Offset	Average Power (dBm)		
20050	20175						20300		
1720.0MHz	1732.5MHz						1745.0MHz		
4	20	QPSK	1	0	21.79	21.79	21.78		
			1	49	22.20	22.17	22.19		
			1	99	21.64	21.69	21.74		
			50	0	21.30	21.21	21.25		
			50	24	21.12	21.14	21.18		
			50	49	21.21	21.09	21.05		
			100	0	21.16	21.06	21.29		
		Antenna Gain (dBi):					0.37		
		Max. EIRP (dBm):					22.57		
		EIRP Limit (dBm):					30.00		
		16QAM	1	0	21.48	21.10	21.13		
			1	49	21.28	21.31	21.10		
			1	99	21.30	21.44	21.02		
			50	0	20.27	20.24	20.34		
			50	24	20.14	20.06	20.14		
			50	49	20.16	20.09	20.02		
			100	0	20.20	20.05	20.25		
		Antenna Gain (dBi):					0.37		
		Max. EIRP (dBm):					21.85		
		EIRP Limit (dBm):					30.00		
		Note: EIRP (dBm) = Average power (dBm) + Antenna Gain (dBi).							

LTE Band	Bandwidth (MHz)	Modulation	RB Size	RB Offset	Average Power (dBm)				
					23755	23790	23825		
					706.5MHz	710.0MHz	713.5MHz		
17	5	QPSK	1	0	21.98	22.09	22.06		
			1	12	22.34	22.26	22.33		
			1	24	22.05	22.03	22.15		
			12	0	21.22	21.15	21.27		
			12	6	21.31	21.31	21.33		
			12	11	21.34	21.34	21.20		
			25	0	21.34	21.28	21.21		
		Antenna Gain(dBi):					-0.19		
		Max. ERP (dBm):					20.00		
		ERP Limit (dBm):					34.77		
		16QAM	1	0	21.43	21.10	21.23		
			1	12	21.23	21.22	21.53		
			1	24	21.18	21.15	21.29		
			12	0	20.30	20.27	20.40		
			12	6	20.42	20.42	20.44		
			12	11	20.41	20.39	20.23		
			25	0	20.30	20.22	20.31		
		Antenna Gain(dBi):					-0.19		
		Max. ERP (dBm):					19.19		
		ERP Limit (dBm):					34.77		
		LTE Band	Bandwidth (MHz)	Modulation	RB Size	RB Offset	Average Power (dBm)		
23780	23790						23800		
709.0MHz	710.0MHz						711.0MHz		
17	10	QPSK	1	0	22.09	22.09	22.05		
			1	24	22.34	22.26	22.30		
			1	49	22.14	22.29	22.24		
			25	0	21.28	21.21	21.23		
			25	12	21.38	21.35	21.27		
			25	24	21.22	21.31	21.16		
			50	0	21.33	21.28	21.28		
		Antenna Gain(dBi):					-0.19		
		Max. ERP (dBm):					20.00		
		ERP Limit (dBm):					34.77		
		16QAM	1	0	21.52	21.23	21.04		
			1	24	21.35	21.72	21.36		
			1	49	21.44	21.43	21.34		
			25	0	20.31	20.25	20.30		
			25	12	20.36	20.36	20.43		
			25	24	20.32	20.30	20.31		
			50	0	20.24	20.29	20.25		
		Antenna Gain(dBi):					-0.19		
		Max. ERP (dBm):					19.38		
		ERP Limit (dBm):					34.77		
		<p>Note: EIRP (dBm) = Average power (dBm) + Antenna Gain (dBi). ERP (dBm) = EIRP (dBm) - 2.15 (dB).</p>							

6.2 Peak-to-Average Ratio

Test Requirement:	Part 24.232 (d), Part 27.50(d)(5)
Limit:	The peak-to-average ratio (PAR) of the transmission may not exceed 13 dB.
Test Setup:	
Test Procedure:	<ol style="list-style-type: none"> 1 The RF output of the transceiver was connected to a spectrum analyzer through appropriate attenuation. 2 Set the CCDF option in spectrum analyzer, $RBW \geq OBW$, 3 Set the EUT working in highest power level, measured and recorded the 0.1% as PAPR level. 4 Repeat step 1~3 at other frequency and modulations.
Test Instruments:	Refer to section 5.10 for details
Test mode:	Refer to section 5.3 for details
Test results:	Passed

Measurement Data (Worst case):

Bandwidth	Modulation	RB Size	RB Offset	PAPR
LTE Band 2 (Middle Channel)				
20MHz	QPSK	100	0	5.01
	16QAM	100	0	5.94
LTE Band 4 (Middle Channel)				
20MHz	QPSK	100	0	4.99
	16QAM	100	0	5.88
LTE Band 17 (Middle Channel)				
10MHz	QPSK	50	0	5.33
	16QAM	50	0	6.12

Test plots as below:

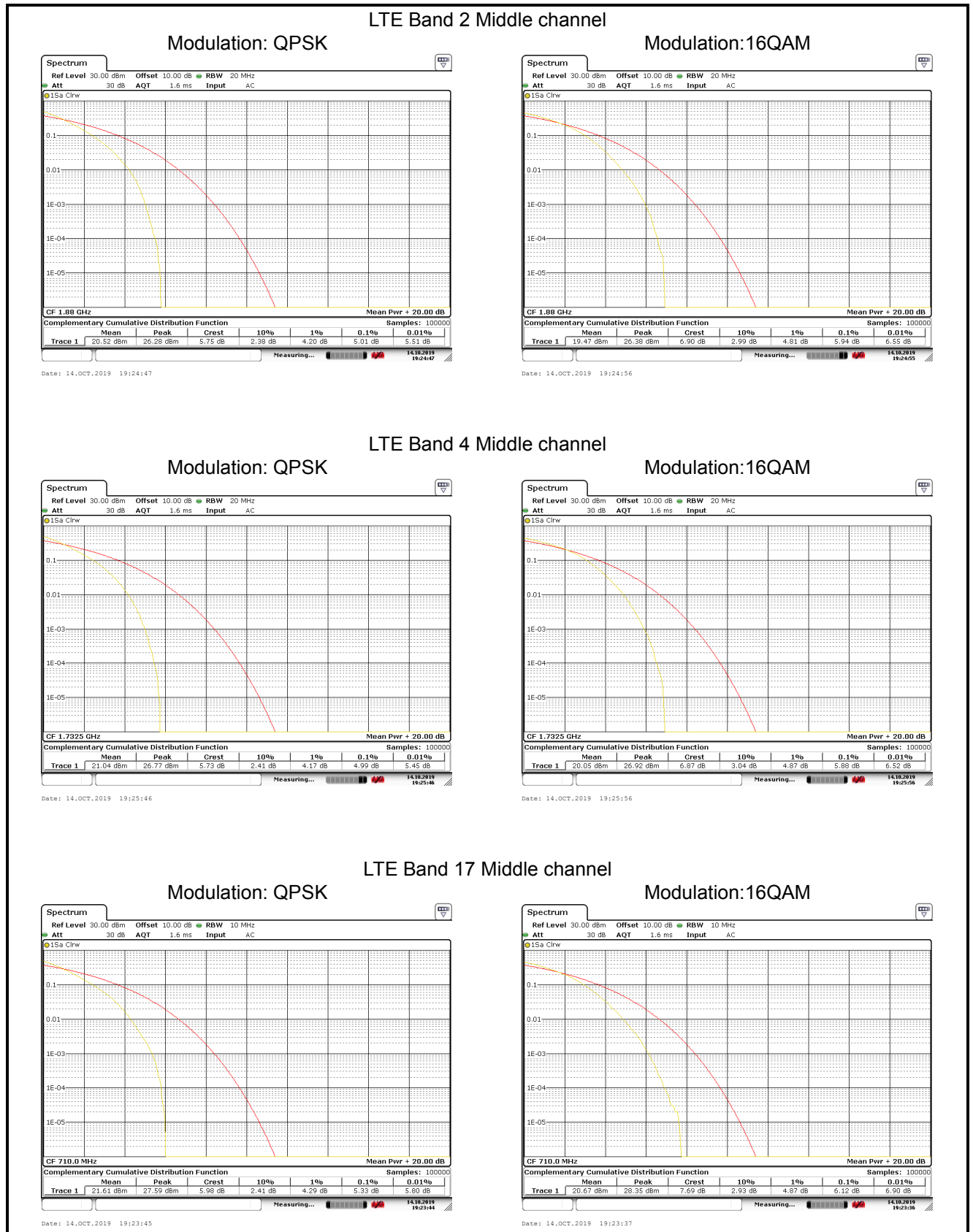

6.3 Occupy Bandwidth

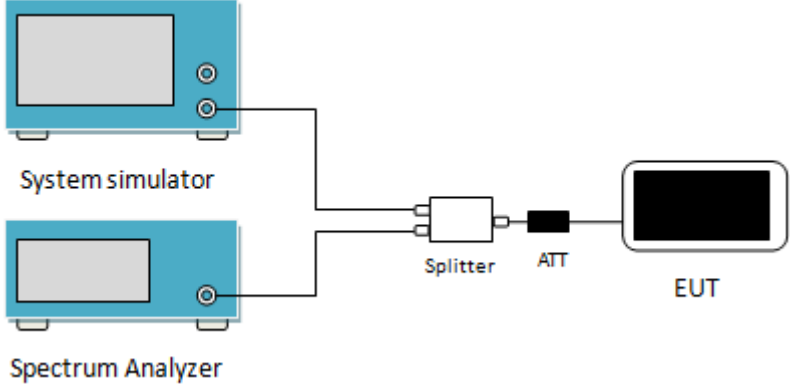
Test Requirement:	Part 24.238(b), Part 27.53(g), Part 27.53(h)
Test Setup:	 <p>The diagram shows a test setup. On the left, there are two blue rectangular units: the top one is labeled 'System simulator' and the bottom one is labeled 'Spectrum Analyzer'. Both have two circular ports on their right side. A single line from the top port of the System simulator and a single line from the top port of the Spectrum Analyzer merge into a single line that enters a white rectangular 'Splitter'. From the right side of the Splitter, a line goes to a black rectangular 'ATT' (Attenuator). From the right side of the ATT, a line goes to a black rectangular 'EUT' (Equipment Under Test).</p>
Test Procedure:	<ol style="list-style-type: none"> 1. The EUT's output RF connector was connected with a short cable to the spectrum analyzer 2. RBW was set to about 1% ~ 5% of emission BW, VBW= 3 times RBW. 3. -26dBc display line was placed on the screen (or 99% bandwidth), the occupied bandwidth is the delta frequency between the two points where the display line intersects the signal trace.
Test Instruments:	Refer to section 5.10 for details
Test mode:	Refer to section 5.3 for details
Test results:	Passed

Measurement Data:

LTE Band 2					
Bandwidth	Channel	Frequency (MHz)	Modulation	99% OBW (kHz)	-26dBcEBW (kHz)
1.4MHz	18607	1850.70	16QAM	1098	1266
			QPSK	1098	1284
	18900	1880.00	16QAM	1092	1272
			QPSK	1104	1290
	19193	1909.30	16QAM	1092	1242
			QPSK	1098	1296
3MHz	18615	1851.50	16QAM	2712	2952
			QPSK	2736	3000
	18900	1880.00	16QAM	2724	2952
			QPSK	2736	3012
	19185	1908.50	16QAM	2712	2940
			QPSK	2736	3024
5MHz	18625	1852.50	16QAM	4500	4900
			QPSK	4520	5120
	18900	1880.00	16QAM	4500	4940
			QPSK	4520	5020
	19175	1907.50	16QAM	4500	4880
			QPSK	4520	5000
10MHz	18650	1855.00	16QAM	9080	10040
			QPSK	9080	10240
	18900	1880.00	16QAM	9080	10040
			QPSK	9080	10320
	19150	1905.00	16QAM	9080	10160
			QPSK	9080	10200
15MHz	18675	1857.50	16QAM	13500	14580
			QPSK	13620	14820
	18900	1880.00	16QAM	13500	14640
			QPSK	13500	15000
	19125	1902.50	16QAM	13560	14820
			QPSK	13560	15060
20MHz	18700	1860.00	16QAM	18080	19280
			QPSK	18000	19600
	18900	1880.00	16QAM	17920	19200
			QPSK	17920	19600
	19100	1900.00	16QAM	18000	19360
			QPSK	18080	19520

LTE Band 4					
Bandwidth	Channel	Frequency (MHz)	Modulation	99% OBW (kHz)	-26dBcEBW (kHz)
1.4MHz	19957	1710.7	16QAM	1092	1284
			QPSK	1098	1272
	20175	1732.5	16QAM	1092	1296
			QPSK	1098	1278
	20393	1754.3	16QAM	1092	1266
			QPSK	1104	1266
3MHz	19965	1711.5	16QAM	2724	2976
			QPSK	2736	3012
	20175	1732.5	16QAM	2724	2952
			QPSK	2724	3000
	20385	1750.5	16QAM	2712	2952
			QPSK	2724	3012
5MHz	19975	1712.5	16QAM	4520	5060
			QPSK	4520	5100
	20175	1732.5	16QAM	4520	5040
			QPSK	4520	5060
	20375	1752.5	16QAM	4540	4940
			QPSK	4540	5120
10MHz	20000	1715.0	16QAM	9120	10320
			QPSK	9160	10400
	20175	1732.5	16QAM	9080	10280
			QPSK	9080	10480
	20350	1750.0	16QAM	9120	10240
			QPSK	9160	10400
15MHz	20025	1717.5	16QAM	13500	14640
			QPSK	13500	15120
	20175	1732.5	16QAM	13500	14640
			QPSK	13440	14880
	20325	1747.5	16QAM	13560	14880
			QPSK	13560	15120
20MHz	20050	1720.0	16QAM	18000	19280
			QPSK	18080	19680
	20175	1732.5	16QAM	17920	19440
			QPSK	18000	19640
	20300	1745.0	16QAM	17920	19280
			QPSK	18080	19520

LTE Band 17					
Bandwidth	Channel	Frequency (MHz)	Modulation	99% OBW (kHz)	-26dBcEBW (kHz)
5MHz	23755	706.5	16QAM	4520	4960
			QPSK	4520	5200
	23790	710.0	16QAM	4480	4920
			QPSK	4520	5080
	23825	713.5	16QAM	4520	4900
			QPSK	4520	5040
10MHz	23780	709.0	16QAM	9080	10000
			QPSK	9080	10480
	23790	710.0	16QAM	9080	10120
			QPSK	9080	10320
	23130	711.0	16QAM	9040	10040
			QPSK	9080	10320

Test plot as follows:
LTE Band 2 part:

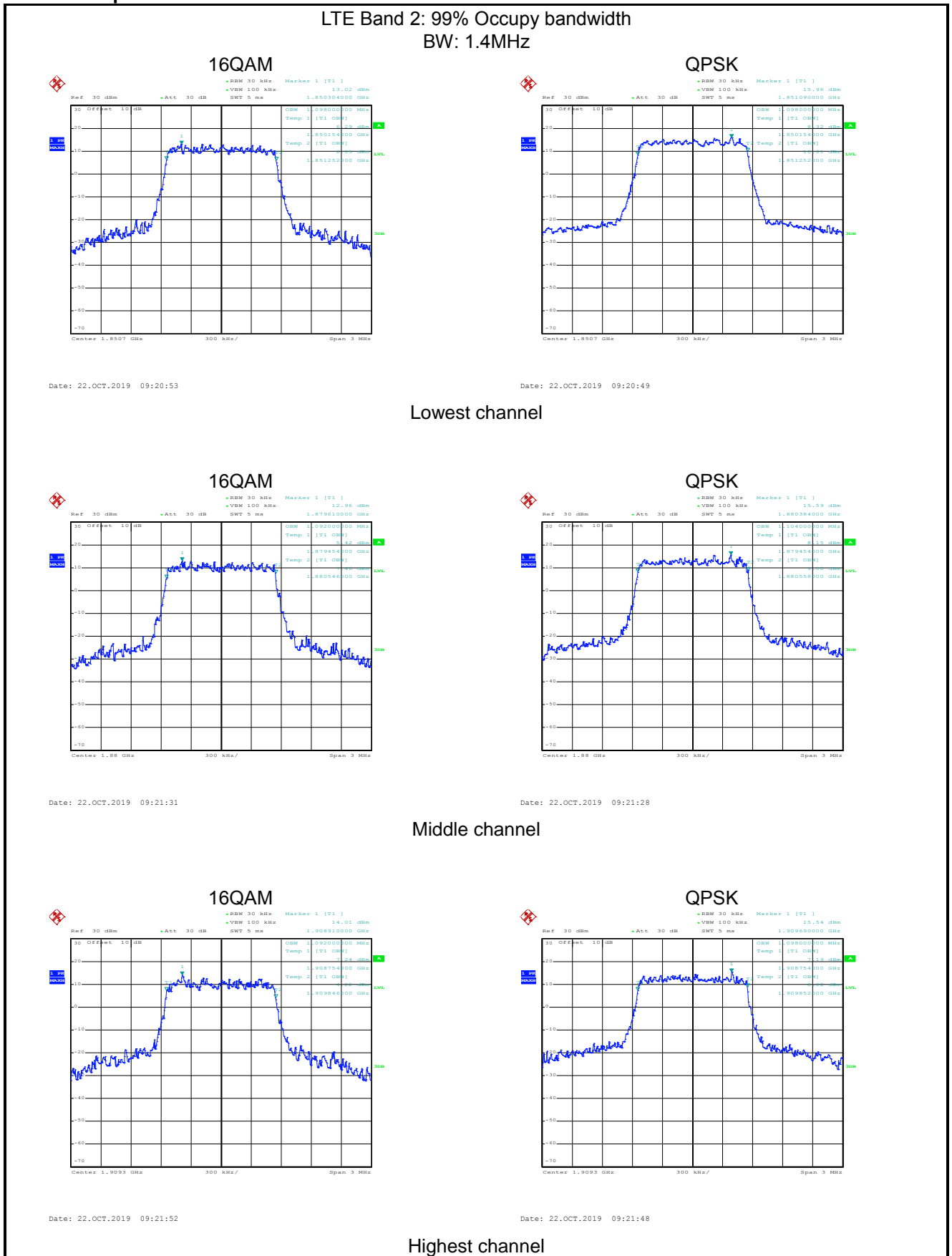

LTE Band 2: 99% Occupancy bandwidth
BW: 3MHz

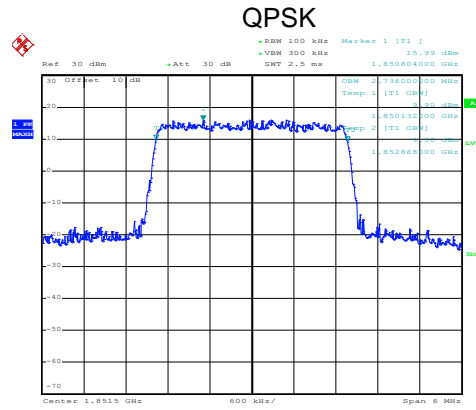
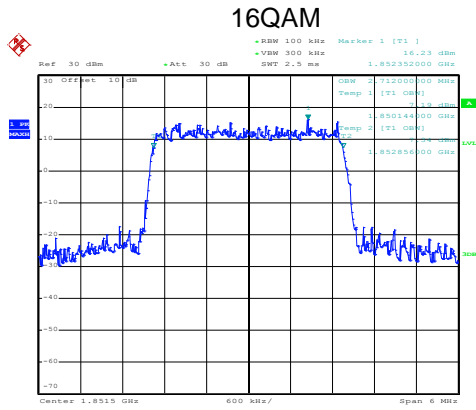

Date: 22.OCT.2019 09:22:48

Date: 22.OCT.2019 09:22:44

Lowest channel

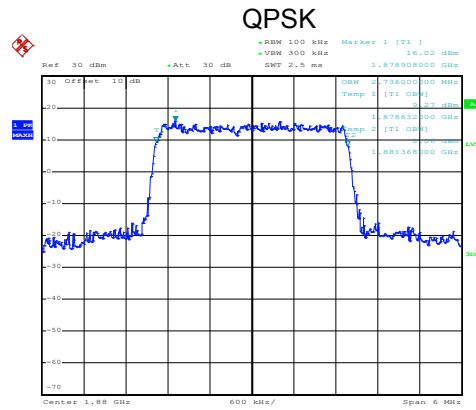
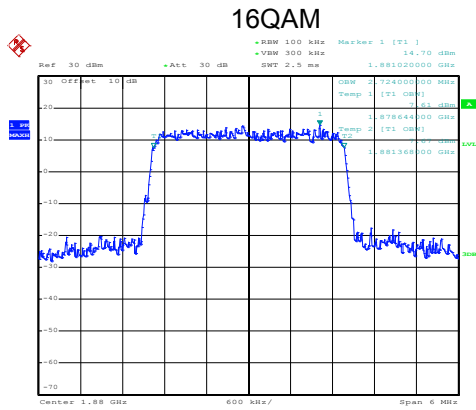

Date: 22.OCT.2019 09:23:01

Date: 22.OCT.2019 09:22:57

Middle channel

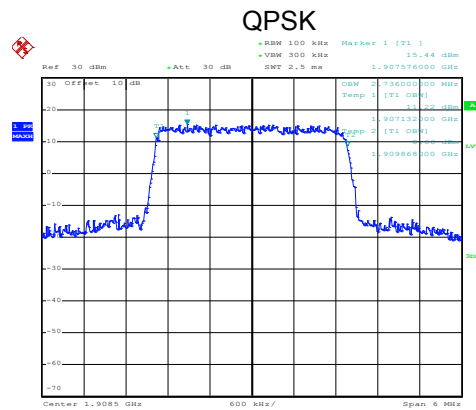
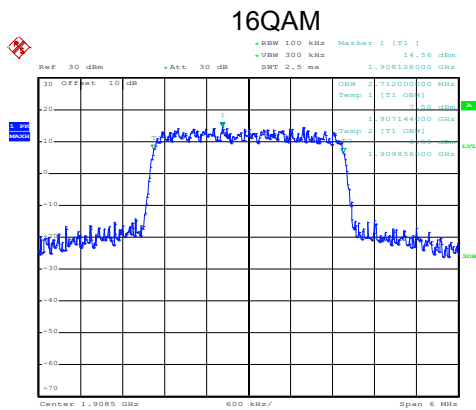

Date: 22.OCT.2019 09:23:40

Date: 22.OCT.2019 09:23:36

Highest channel

LTE Band 2: 99% Occupancy bandwidth
BW: 5MHz

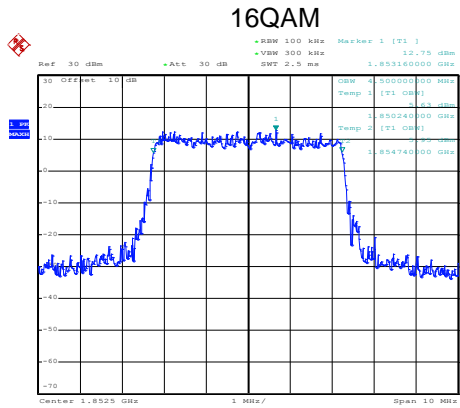

Date: 22.OCT.2019 09:24:10

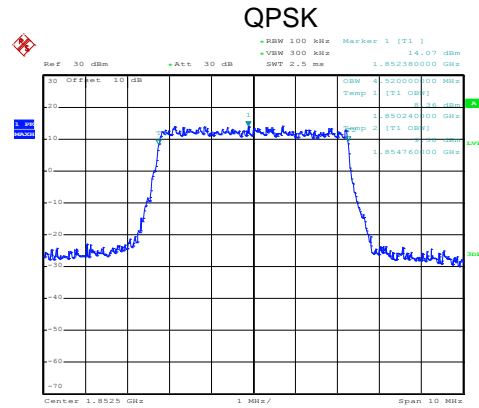

Date: 22.OCT.2019 09:24:06

Lowest channel

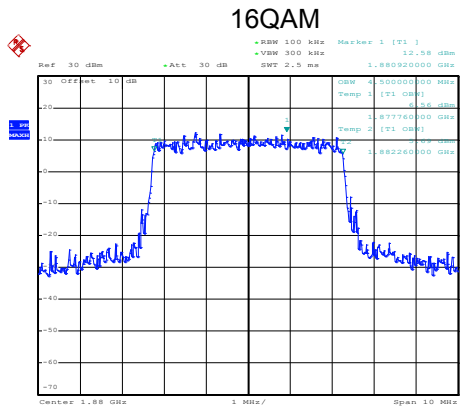

Date: 22.OCT.2019 09:24:41

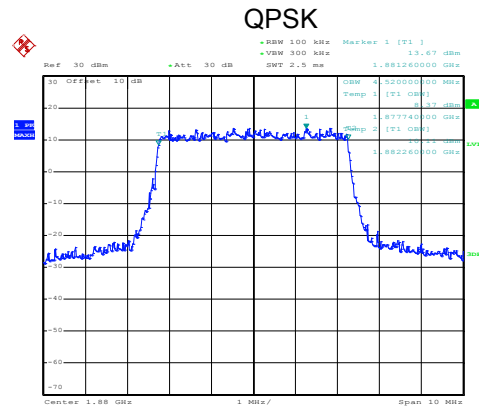

Date: 22.OCT.2019 09:24:37

Middle channel

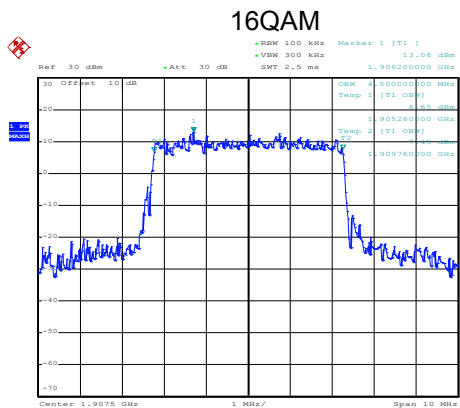

Date: 22.OCT.2019 09:24:59

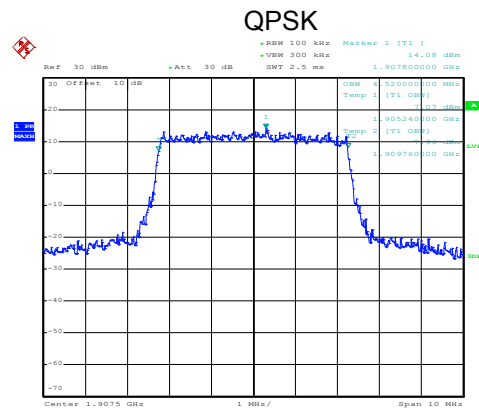

Date: 22.OCT.2019 09:24:55

Highest channel

LTE Band 2: 99% Occupy bandwidth
BW: 10MHz

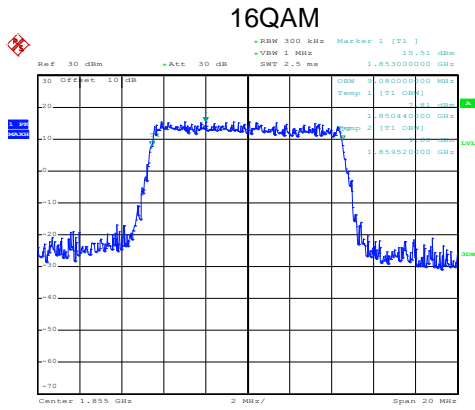

Date: 22.OCT.2019 09:25:53

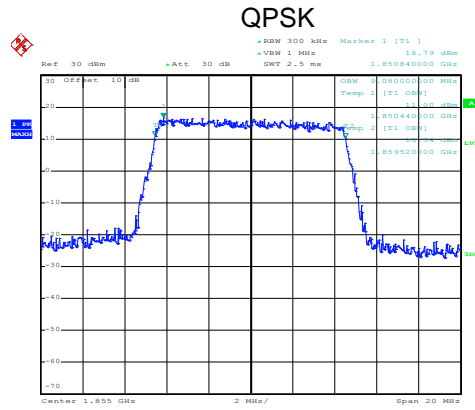

Date: 22.OCT.2019 09:25:49

Lowest channel

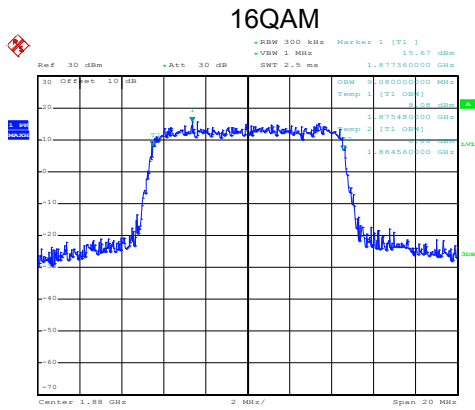

Date: 22.OCT.2019 09:26:04

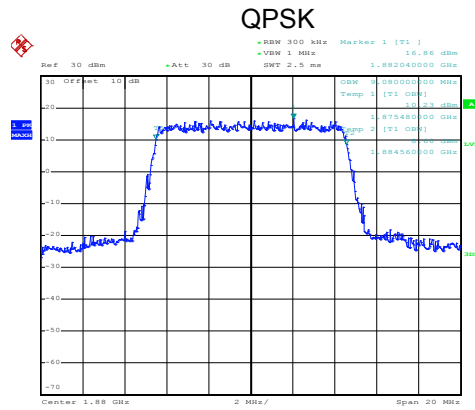

Date: 22.OCT.2019 09:26:01

Middle channel

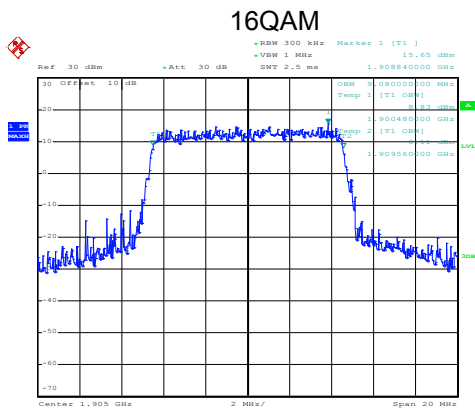

Date: 22.OCT.2019 09:26:38

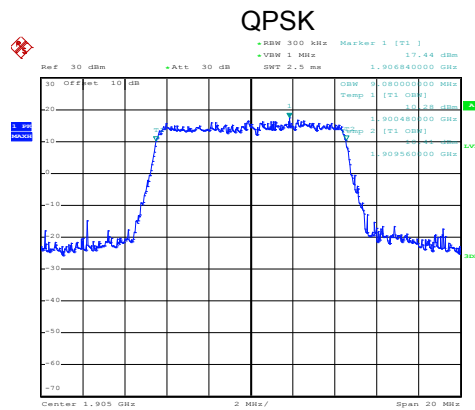

Date: 22.OCT.2019 09:26:35

Highest channel

LTE Band 2: 99% Occupancy bandwidth
BW: 15MHz

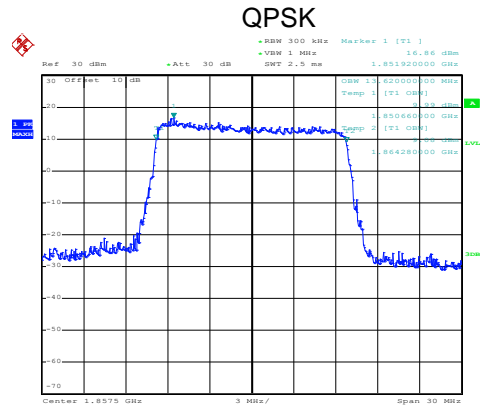
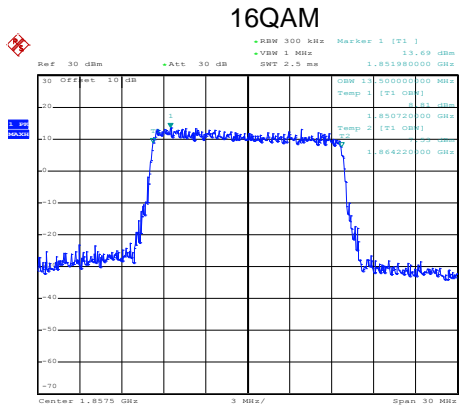

Lowest channel

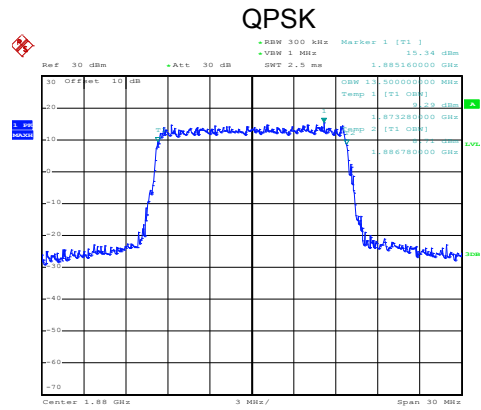
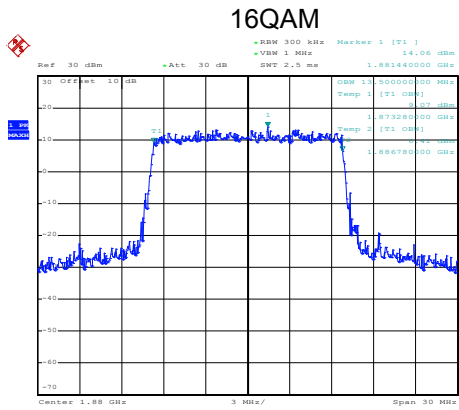

Middle channel

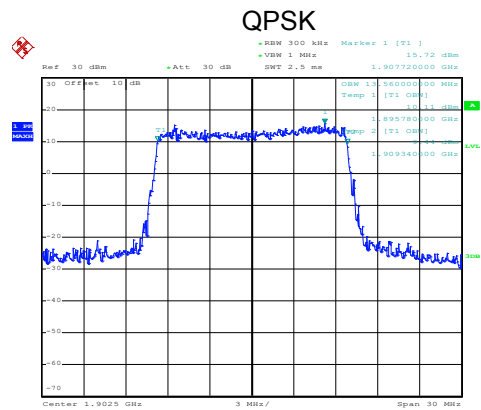
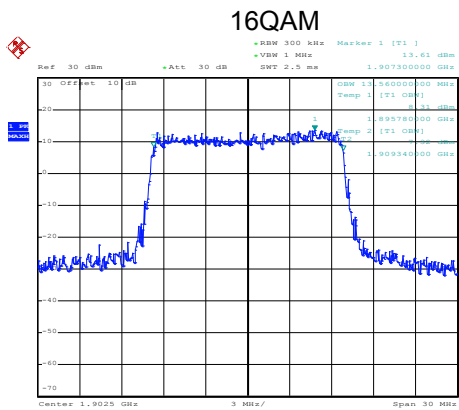

Highest channel

LTE Band 2: 99% Occupancy bandwidth
BW: 20MHz

16QAM

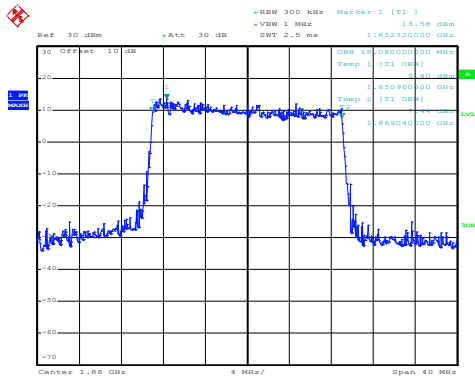

Date: 22.OCT.2019 09:28:44

QPSK

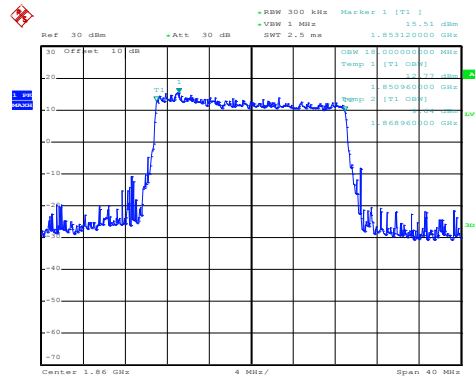

Date: 22.OCT.2019 09:28:41

Lowest channel

16QAM

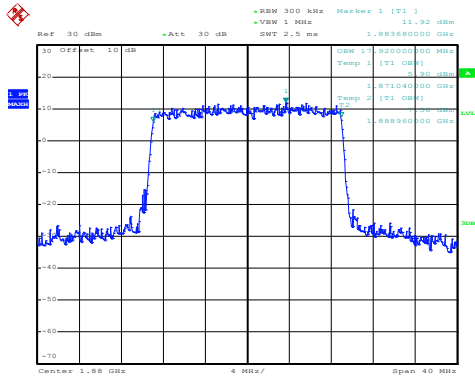

Date: 22.OCT.2019 09:28:57

QPSK

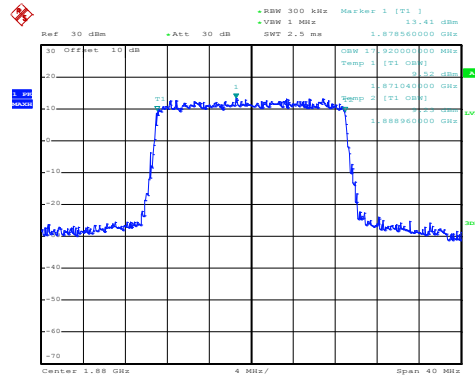

Date: 22.OCT.2019 09:28:54

Middle channel

16QAM

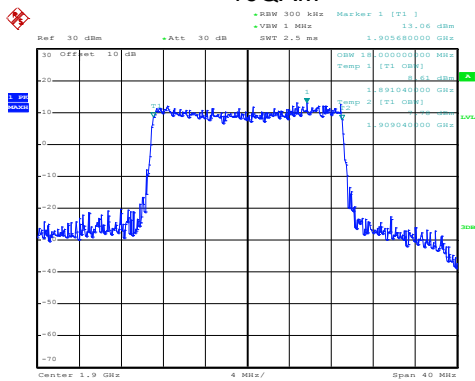

Date: 22.OCT.2019 09:29:50

QPSK

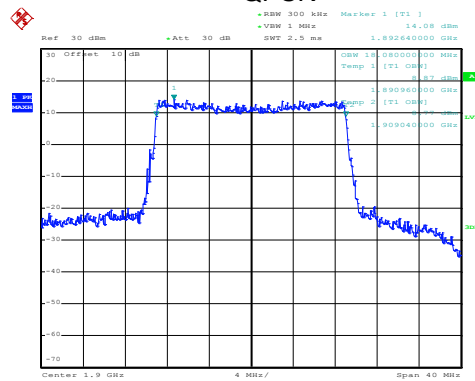

Date: 22.OCT.2019 09:29:46

Highest channel

LTE Band 2: -26dBc bandwidth
BW: 1.4MHz

16QAM

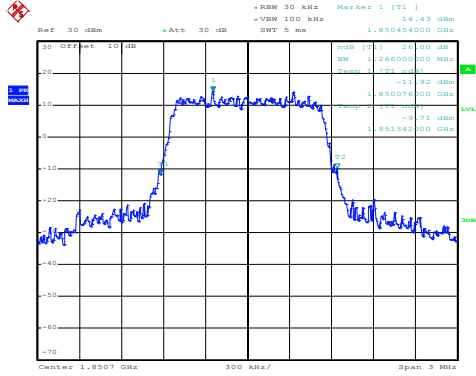

Date: 22.OCT.2019 09:21:06

QPSK

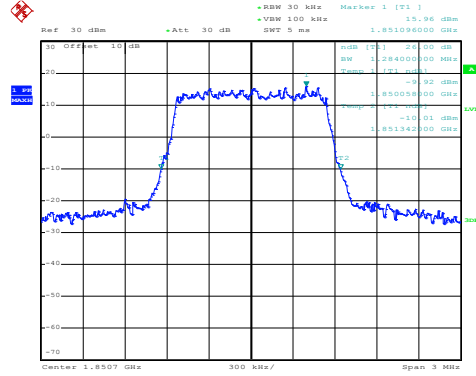

Date: 22.OCT.2019 09:21:02

Lowest channel

16QAM

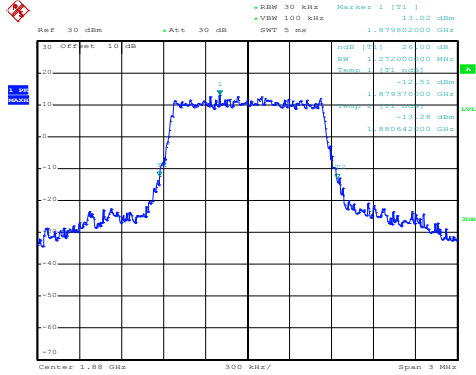

Date: 22.OCT.2019 09:21:22

QPSK

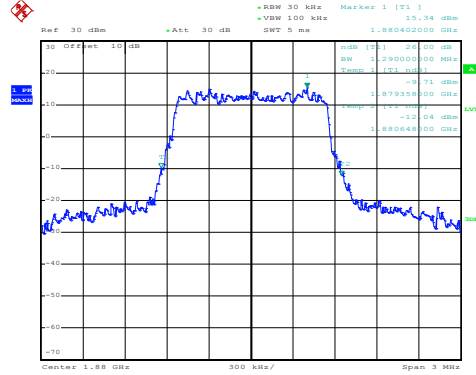

Date: 22.OCT.2019 09:21:17

Middle channel

16QAM

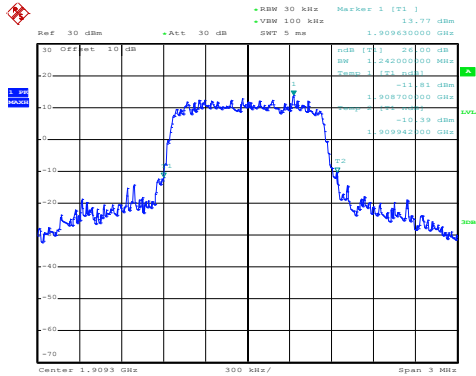

Date: 22.OCT.2019 09:22:02

QPSK

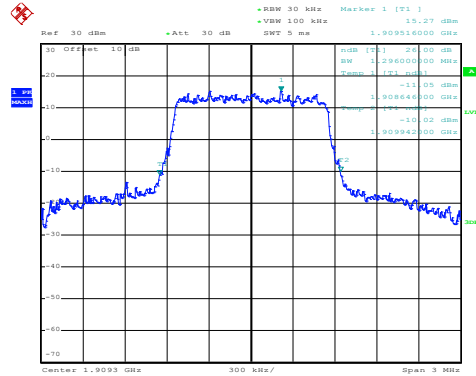

Date: 22.OCT.2019 09:21:58

Highest channel

LTE Band 2: -26dBc bandwidth
BW: 3MHz

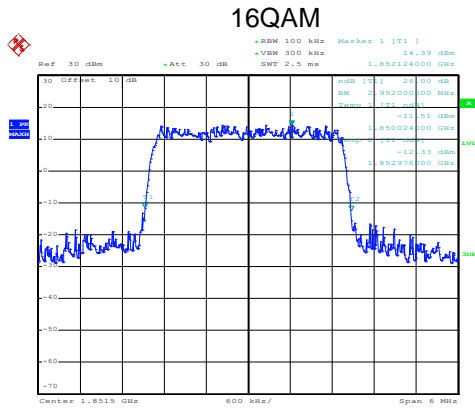

Date: 22.OCT.2019 09:22:38

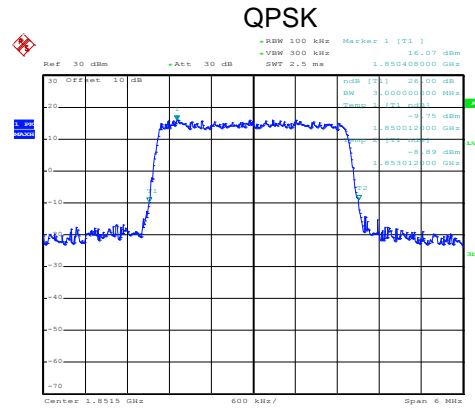

Date: 22.OCT.2019 09:22:35

Lowest channel

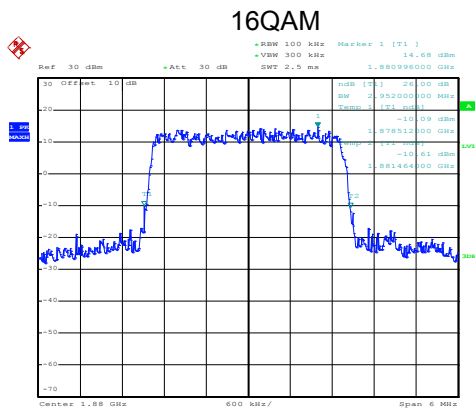

Date: 22.OCT.2019 09:23:14

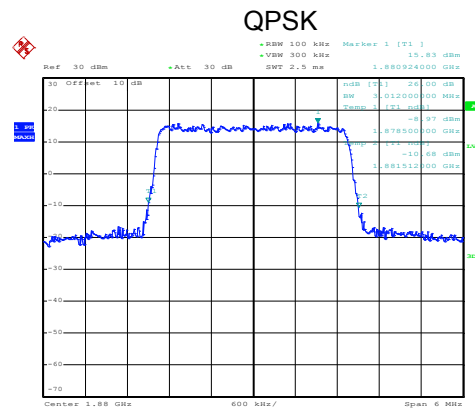

Date: 22.OCT.2019 09:23:10

Middle channel

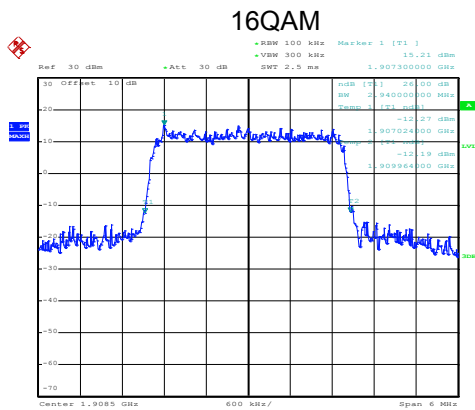

Date: 22.OCT.2019 09:23:30

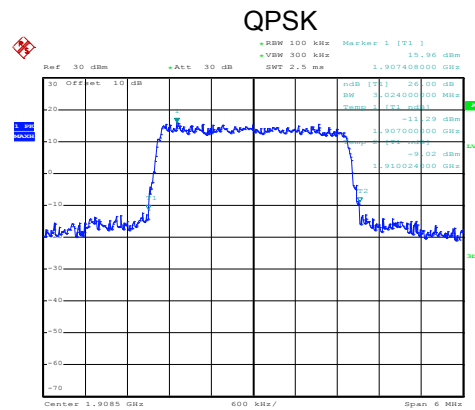

Date: 22.OCT.2019 09:23:27

Highest channel

LTE Band 2: -26dBc bandwidth
BW: 5MHz

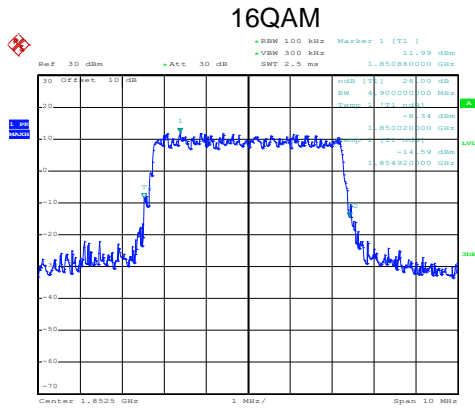

Date: 22.OCT.2019 09:24:20

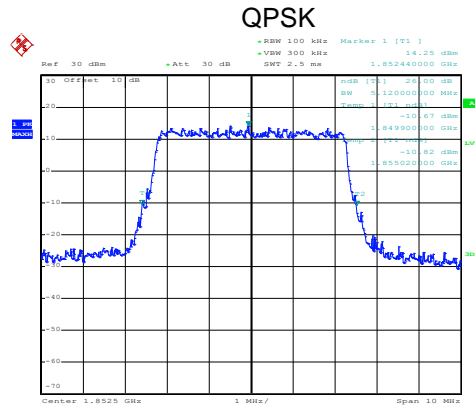

Date: 22.OCT.2019 09:24:17

Lowest channel

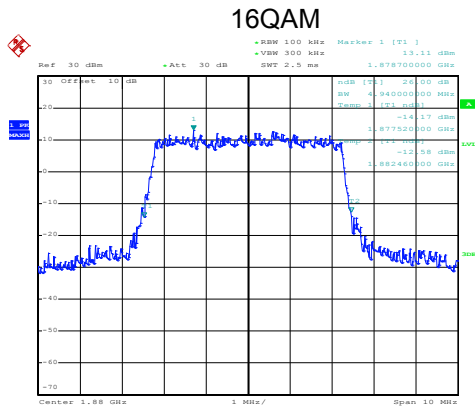

Date: 22.OCT.2019 09:24:32

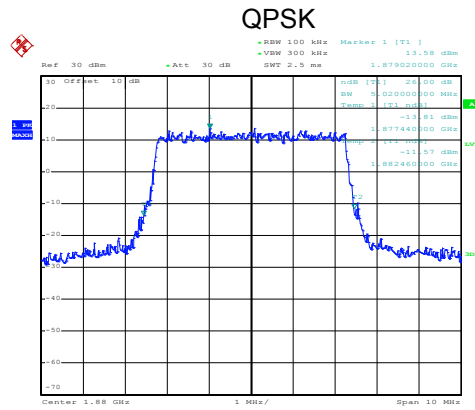

Date: 22.OCT.2019 09:24:28

Middle channel

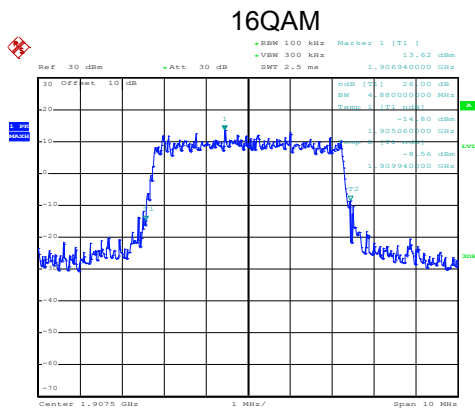

Date: 22.OCT.2019 09:25:08

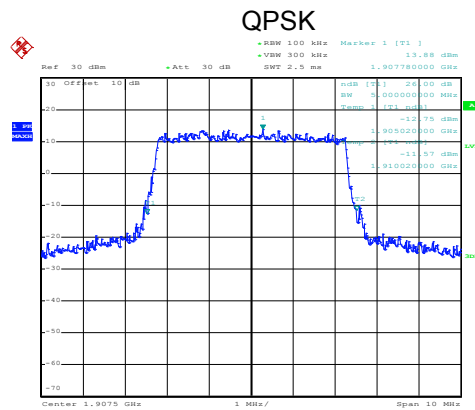

Date: 22.OCT.2019 09:25:05

Highest channel

LTE Band 2: -26dBc bandwidth
BW: 10MHz

16QAM

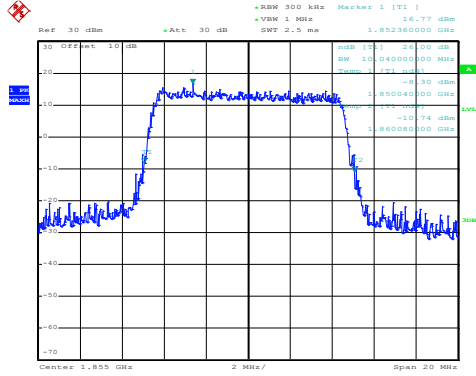

Date: 22.OCT.2019 09:25:42

QPSK

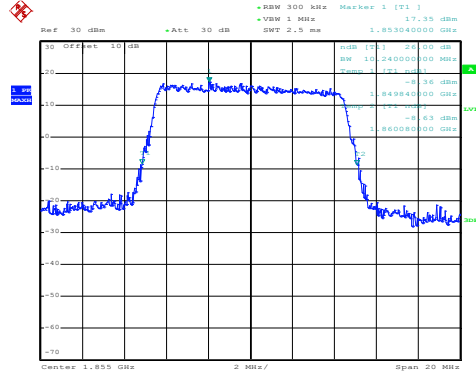

Date: 22.OCT.2019 09:25:38

Lowest channel

16QAM

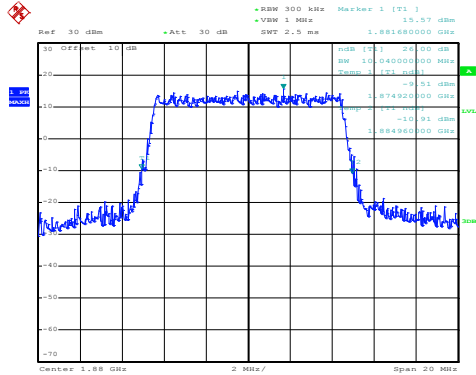

Date: 22.OCT.2019 09:26:14

QPSK

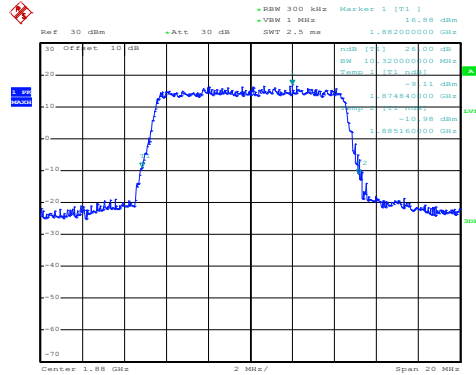

Date: 22.OCT.2019 09:26:10

Middle channel

16QAM

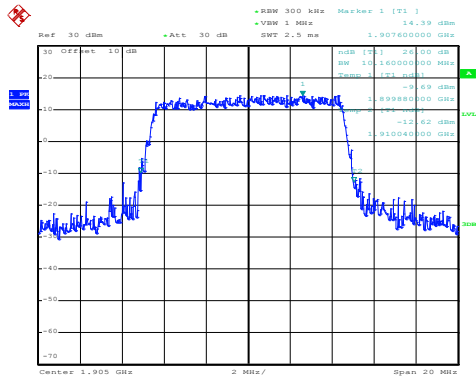

Date: 22.OCT.2019 09:26:28

QPSK

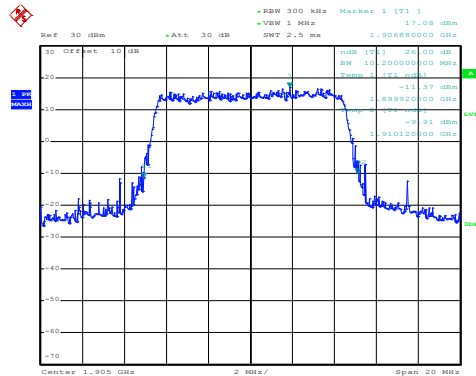

Date: 22.OCT.2019 09:26:25

Highest channel

LTE Band 2: -26dBc bandwidth
BW: 15MHz

16QAM

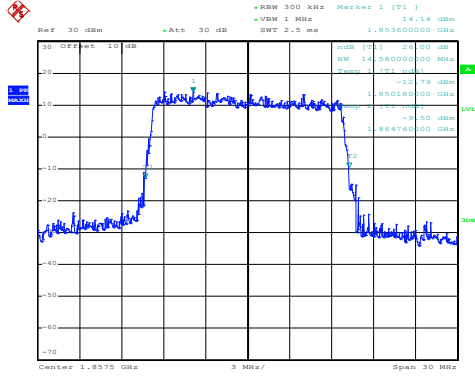

Date: 22.OCT.2019 09:27:14

QPSK

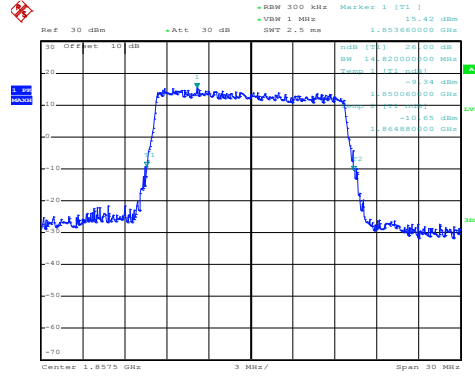

Date: 22.OCT.2019 09:27:11

Lowest channel

16QAM

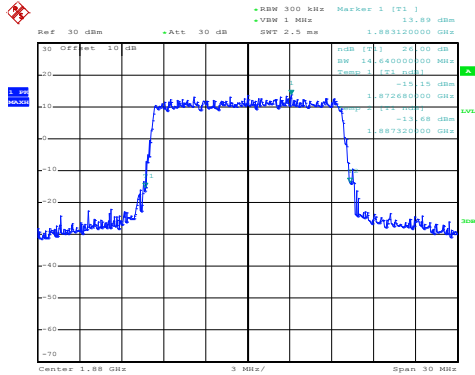

Date: 22.OCT.2019 09:27:27

QPSK

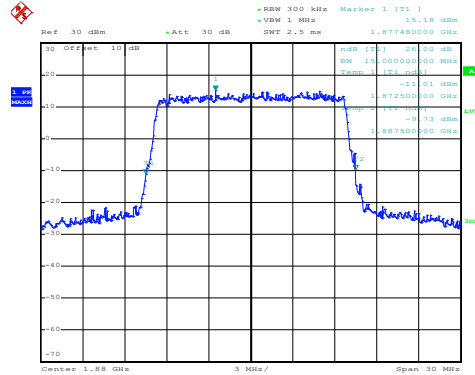

Date: 22.OCT.2019 09:27:24

Middle channel

16QAM

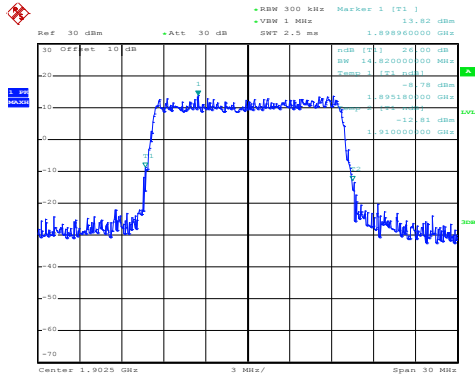

Date: 22.OCT.2019 09:27:59

QPSK

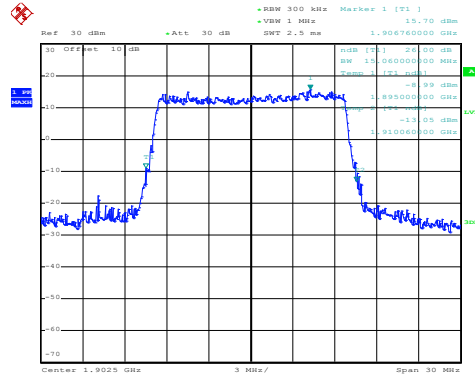

Date: 22.OCT.2019 09:27:56

Highest channel

LTE Band 2: -26dBc bandwidth
BW: 20MHz

16QAM

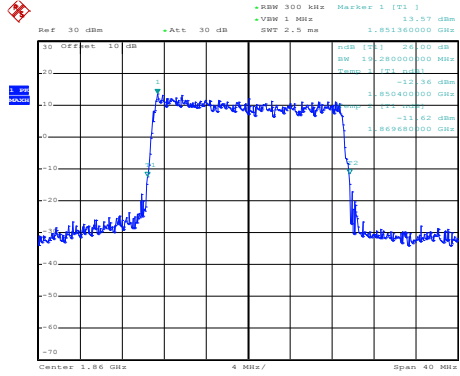

Date: 22.OCT.2019 09:28:31

QPSK

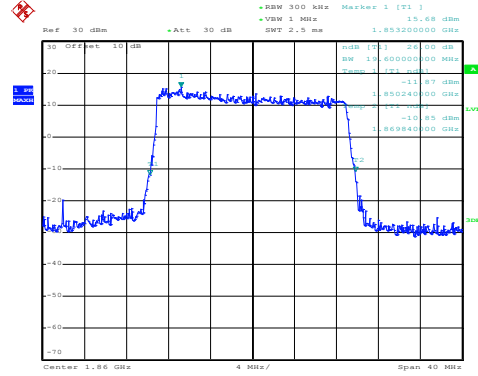

Date: 22.OCT.2019 09:28:28

Lowest channel

16QAM

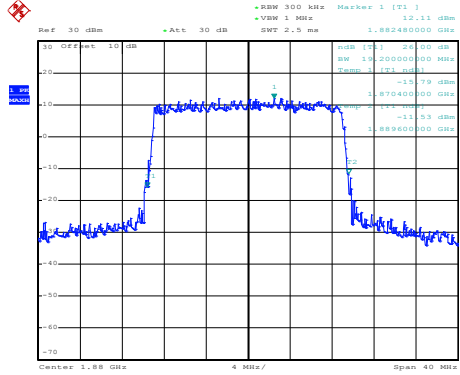

Date: 22.OCT.2019 09:29:09

QPSK

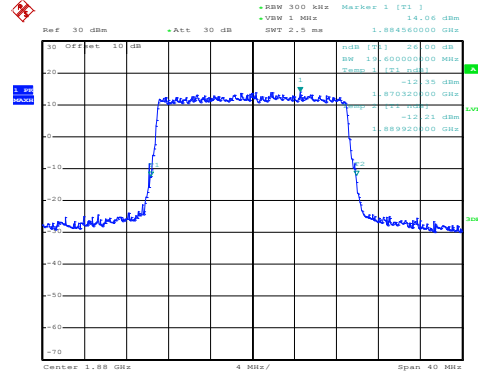

Date: 22.OCT.2019 09:29:05

Middle channel

16QAM

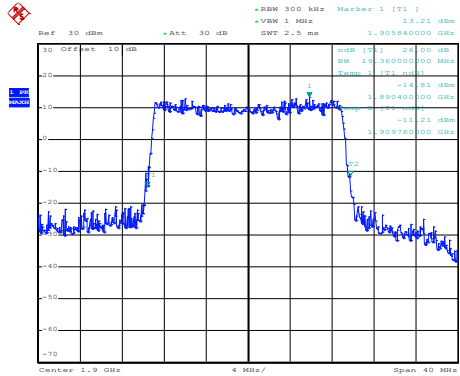

Date: 22.OCT.2019 09:29:39

QPSK

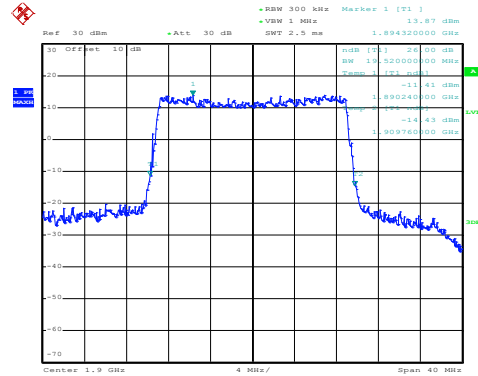

Date: 22.OCT.2019 09:29:36

Highest channel

LTE Band 4 part:

LTE Band 4: 99% Occupy bandwidth
BW: 1.4MHz

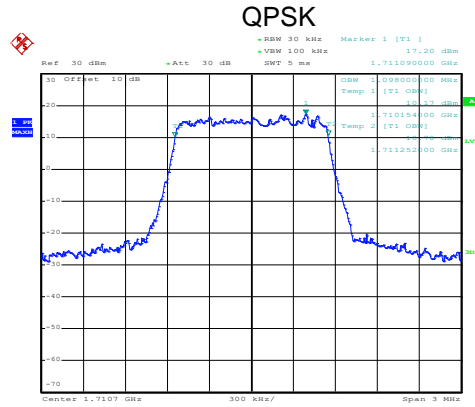
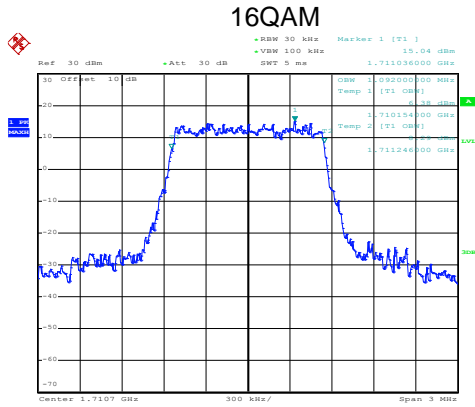

Date: 12.OCT.2019 16:54:55

Date: 12.OCT.2019 16:54:52

Lowest channel

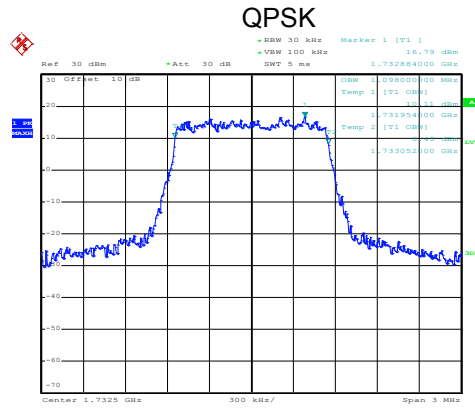
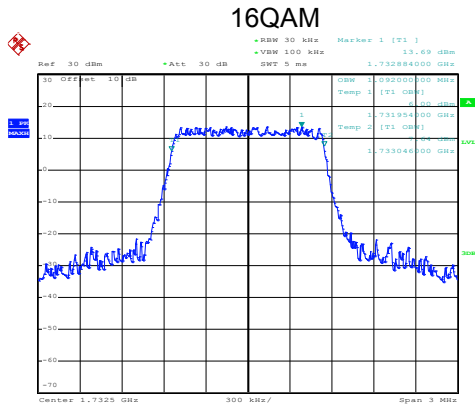

Date: 12.OCT.2019 16:55:34

Date: 12.OCT.2019 16:55:31

Middle channel

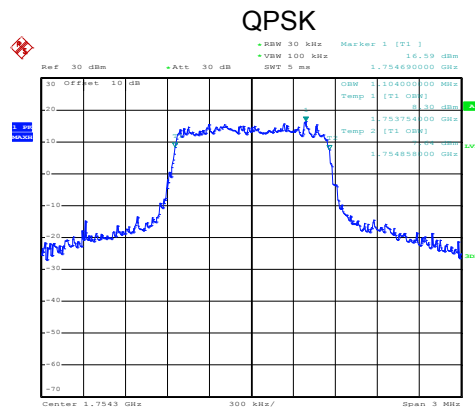
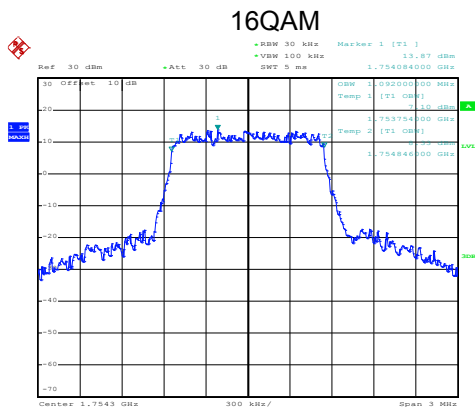

Date: 12.OCT.2019 16:55:52

Date: 12.OCT.2019 16:55:48

Highest channel

LTE Band 4: 99% Occupancy bandwidth
BW: 3MHz

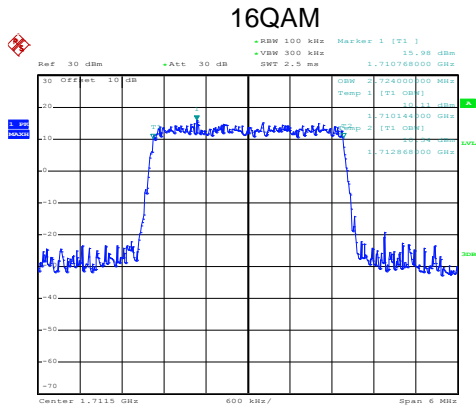

Date: 12.OCT.2019 16:56:39

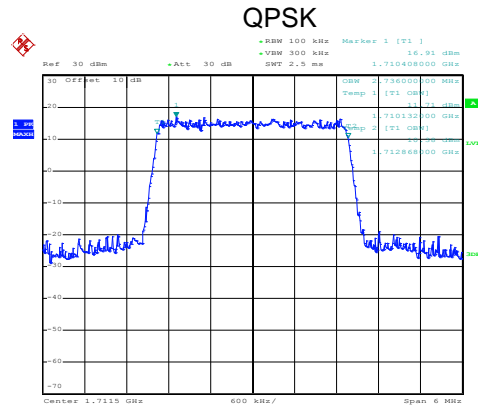

Date: 12.OCT.2019 16:56:36

Lowest channel

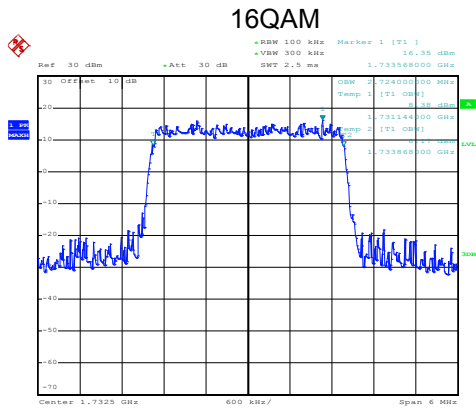

Date: 12.OCT.2019 16:56:58

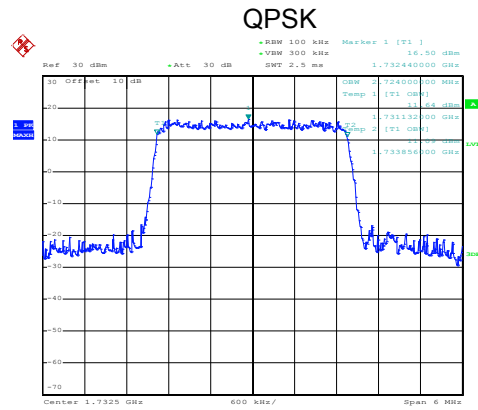

Date: 12.OCT.2019 16:56:55

Middle channel

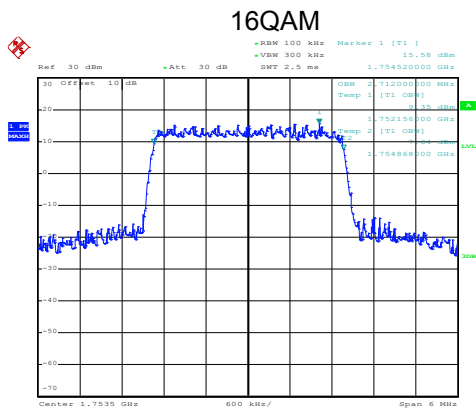

Date: 12.OCT.2019 16:57:37

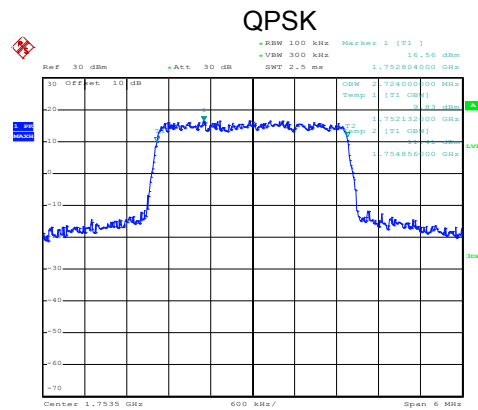

Date: 12.OCT.2019 16:57:34

Highest channel

LTE Band 4: 99% Occupancy bandwidth
BW: 5MHz

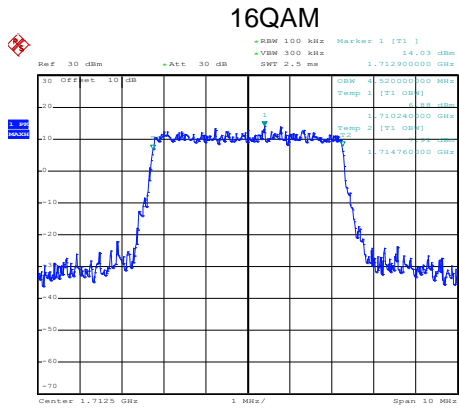

Date: 12.OCT.2019 16:57:58

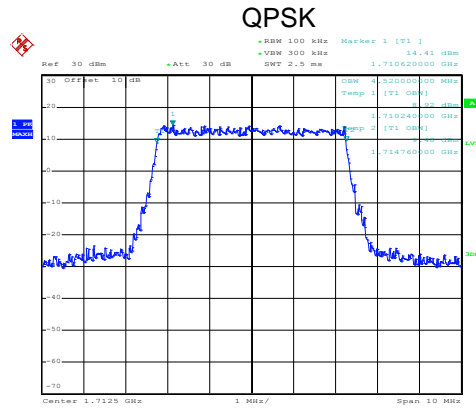

Date: 12.OCT.2019 16:57:55

Lowest channel

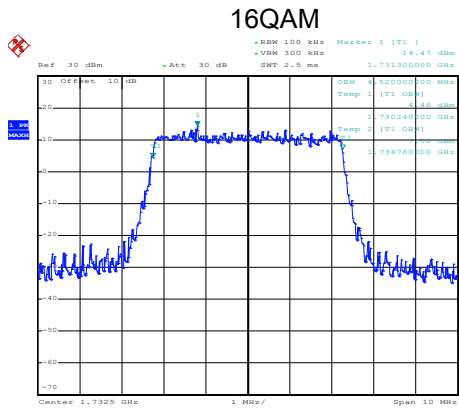

Date: 12.OCT.2019 16:58:44

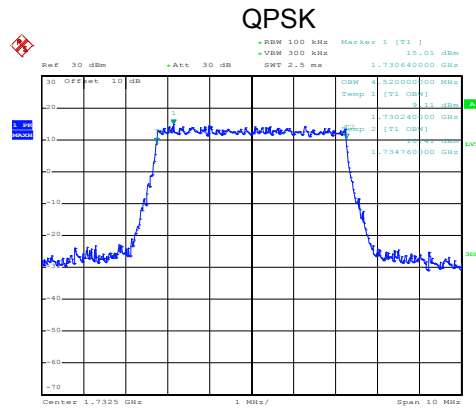

Date: 12.OCT.2019 16:58:40

Middle channel

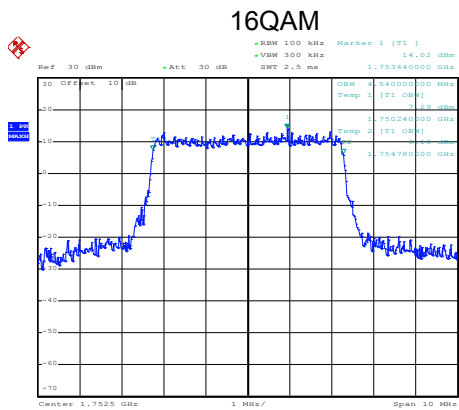

Date: 12.OCT.2019 16:58:58

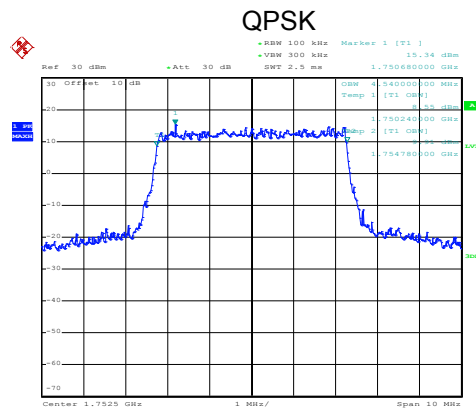

Date: 12.OCT.2019 16:58:55

Highest channel

LTE Band 4: 99% Occupancy bandwidth
BW: 10MHz

16QAM

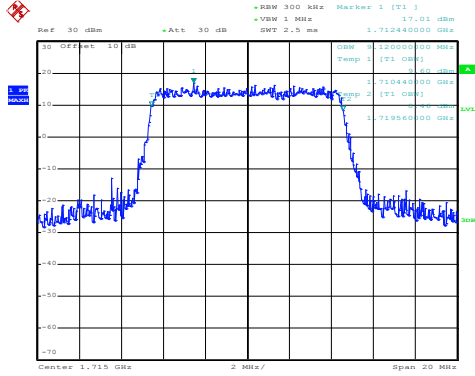

Date: 12.OCT.2019 17:02:04

QPSK

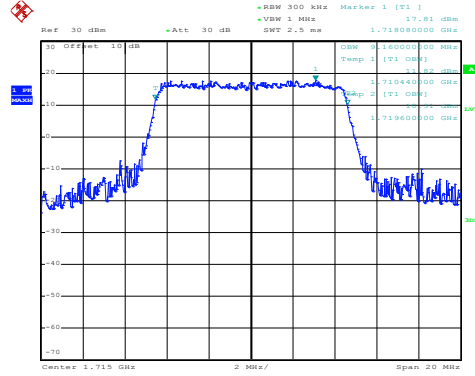

Date: 12.OCT.2019 17:01:59

Lowest channel

16QAM

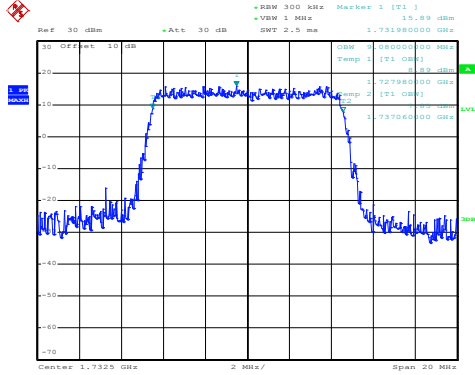

Date: 12.OCT.2019 17:00:52

QPSK

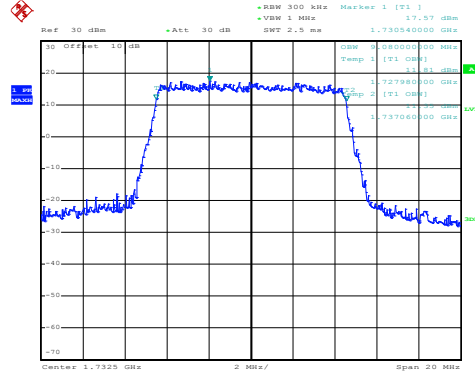

Date: 12.OCT.2019 17:00:49

Middle channel

16QAM

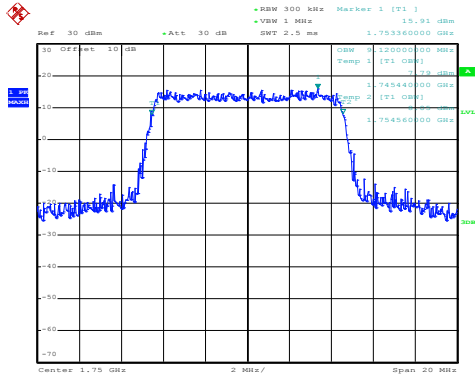

Date: 12.OCT.2019 17:01:08

QPSK

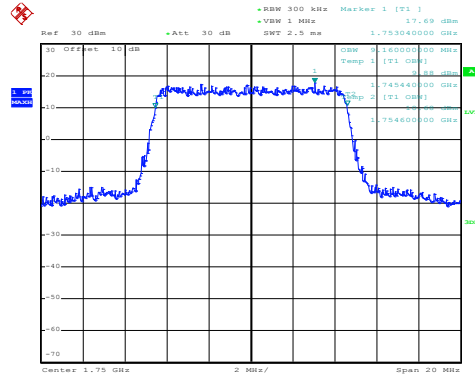

Date: 12.OCT.2019 17:01:05

Highest channel

LTE Band 4: 99% Occupancy bandwidth
BW: 15MHz

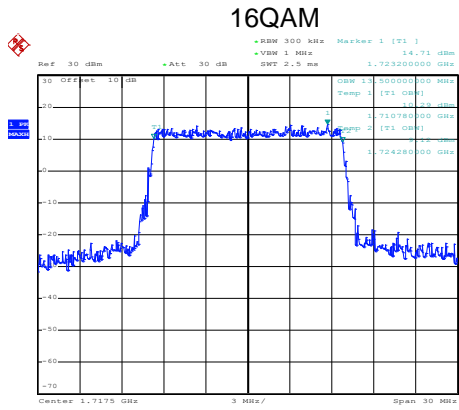

Date: 12.OCT.2019 17:02:52

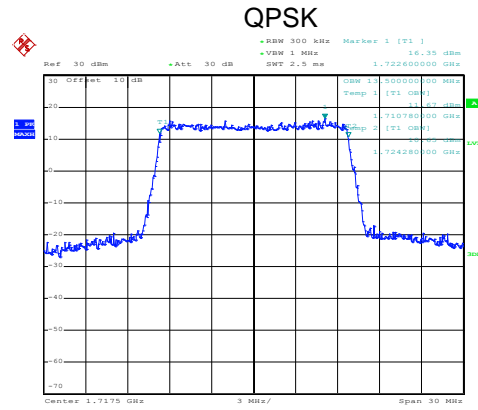

Date: 12.OCT.2019 17:02:49

Lowest channel

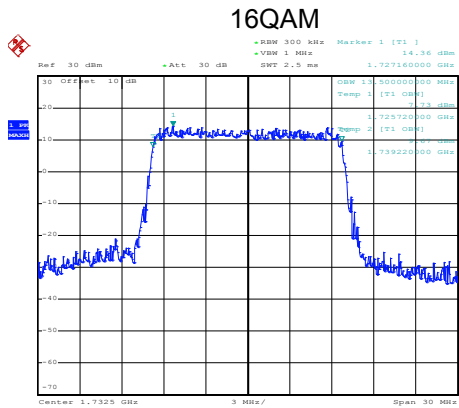

Date: 12.OCT.2019 17:03:04

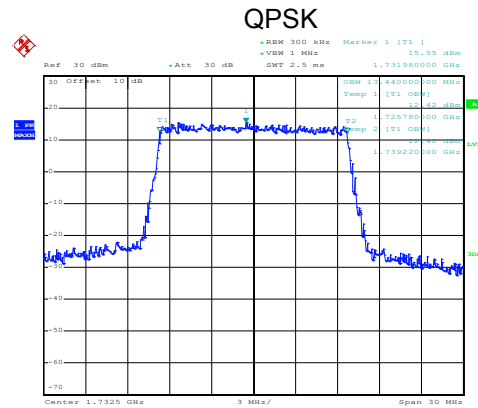

Date: 12.OCT.2019 17:03:01

Middle channel

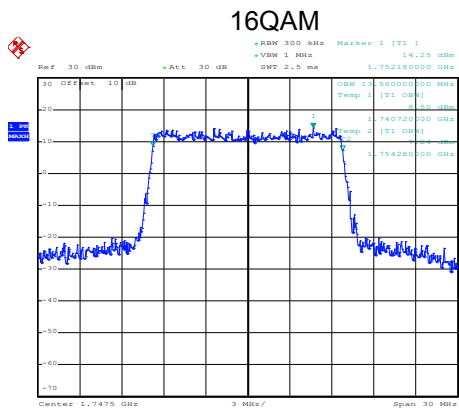

Date: 12.OCT.2019 17:03:43

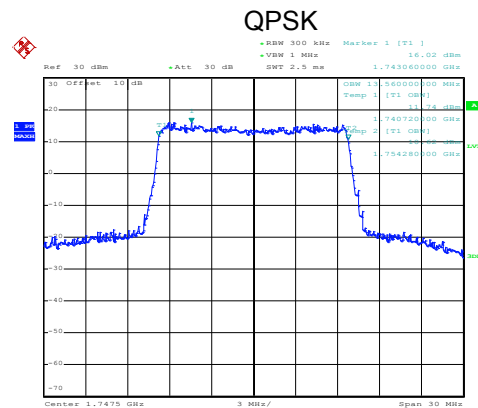

Date: 12.OCT.2019 17:03:40

Highest channel

LTE Band 4: 99% Occupancy bandwidth
BW: 20MHz

16QAM

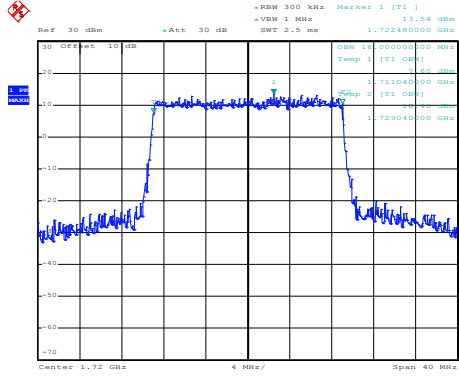

Date: 12.OCT.2019 17:04:05

QPSK

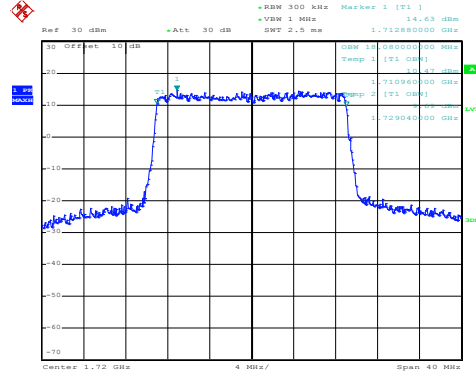

Date: 12.OCT.2019 17:04:02

Lowest channel

16QAM

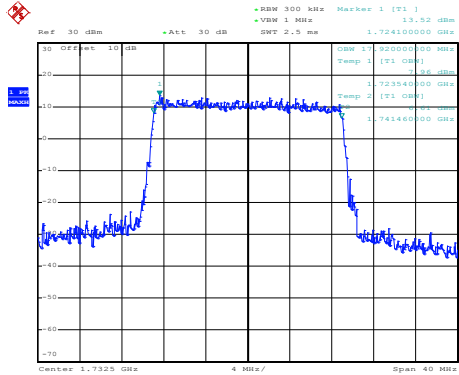

Date: 12.OCT.2019 17:04:36

QPSK

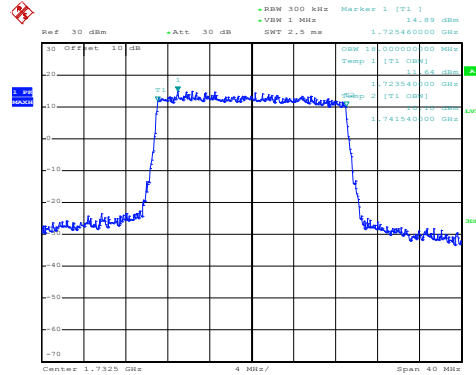

Date: 12.OCT.2019 17:04:32

Middle channel

16QAM

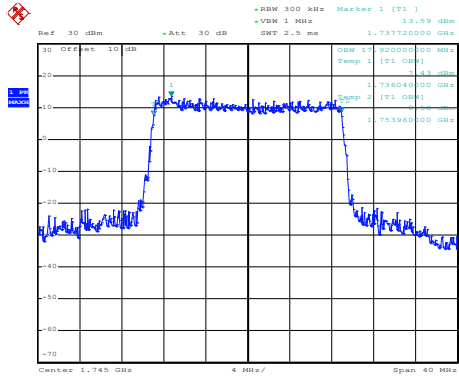

Date: 12.OCT.2019 17:04:49

QPSK

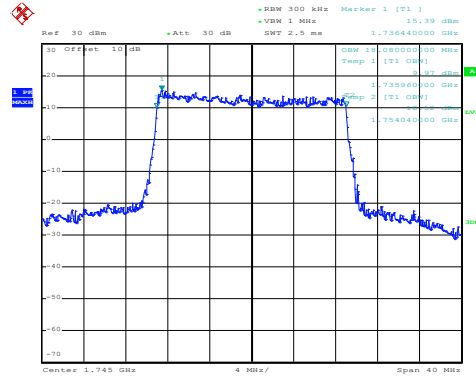

Date: 12.OCT.2019 17:04:45

Highest channel

LTE Band 4: -26dBc bandwidth
BW: 1.4MHz

16QAM

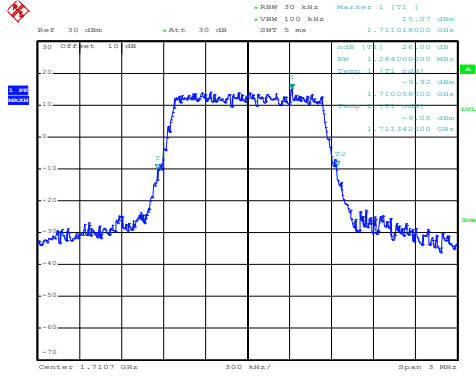

Date: 12.OCT.2019 16:55:09

QPSK

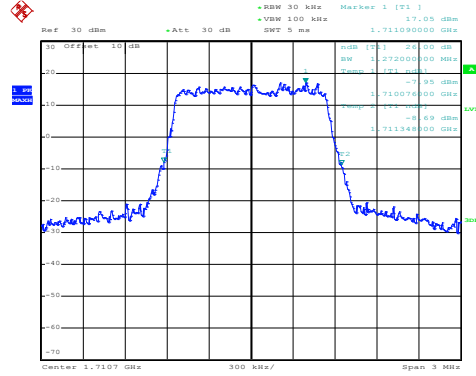

Date: 12.OCT.2019 16:55:06

Lowest channel

16QAM

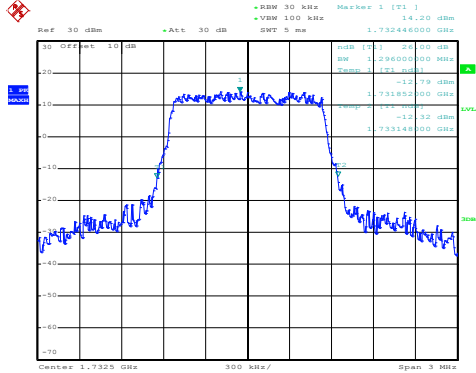

Date: 12.OCT.2019 16:55:24

QPSK

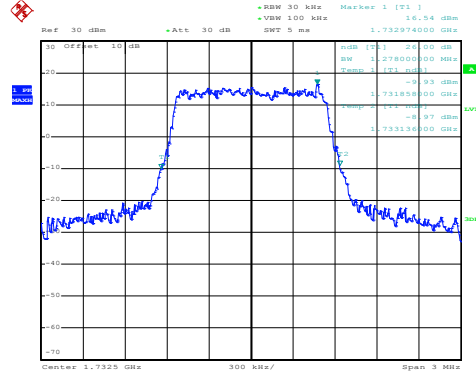

Date: 12.OCT.2019 16:55:21

Middle channel

16QAM

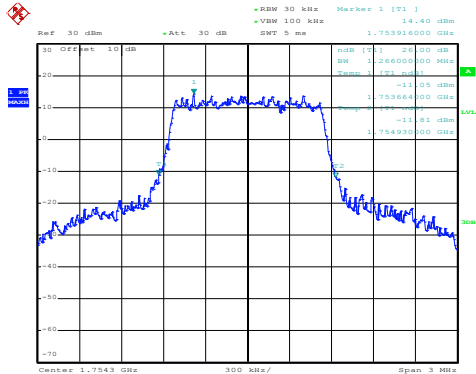

Date: 12.OCT.2019 16:56:02

QPSK

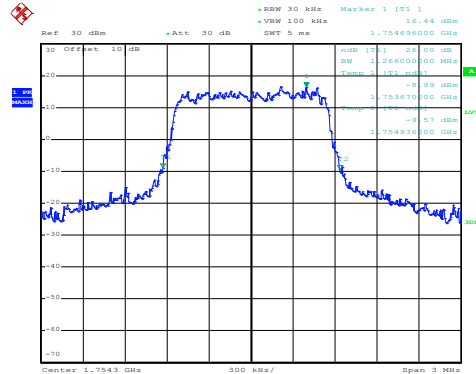

Date: 12.OCT.2019 16:55:58

Highest channel

LTE Band 4: -26dBc bandwidth
BW: 3MHz

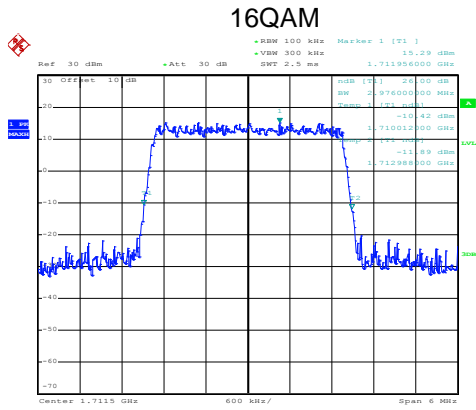

Date: 12.OCT.2019 16:56:30

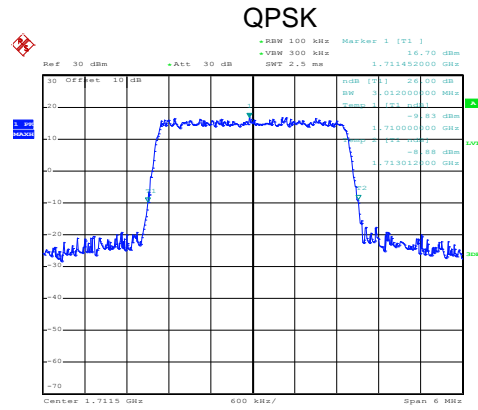

Date: 12.OCT.2019 16:56:26

Lowest channel

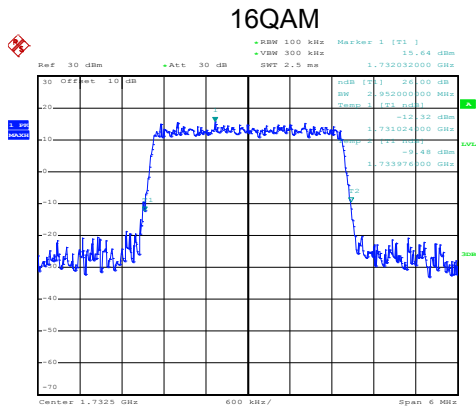

Date: 12.OCT.2019 16:57:09

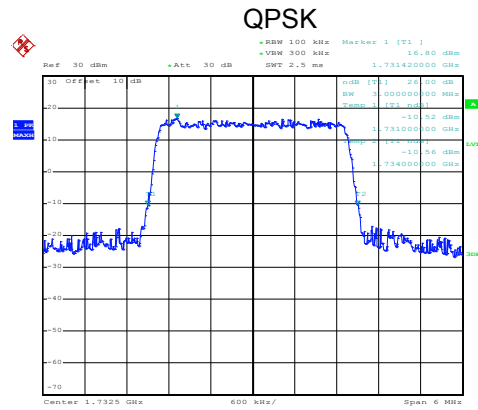

Date: 12.OCT.2019 16:57:06

Middle channel

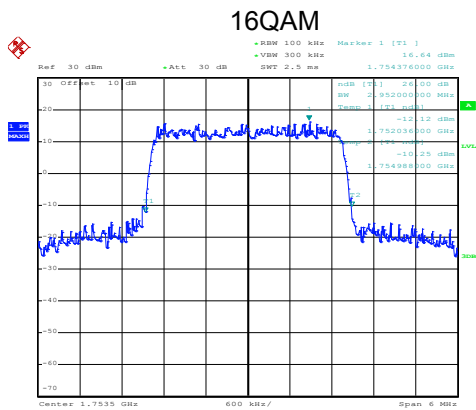

Date: 12.OCT.2019 16:57:27

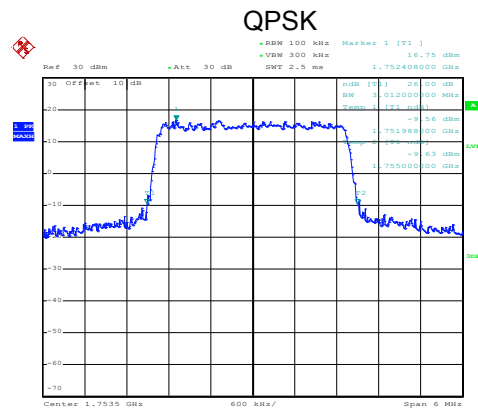

Date: 12.OCT.2019 16:57:24

Highest channel

LTE Band 4: -26dBc bandwidth
BW: 5MHz

16QAM

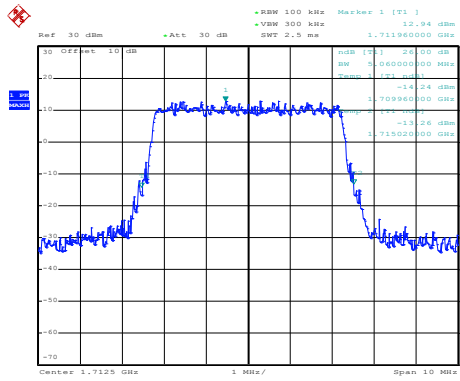

Date: 12.OCT.2019 16:58:17

QPSK

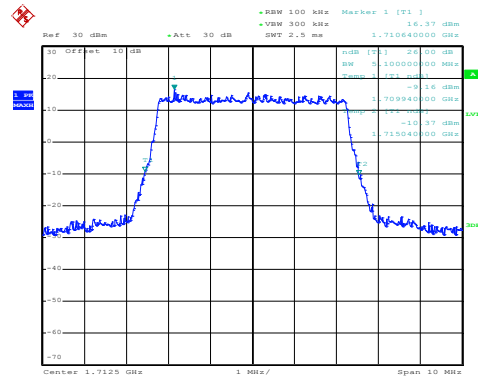

Date: 12.OCT.2019 16:58:14

Lowest channel

16QAM

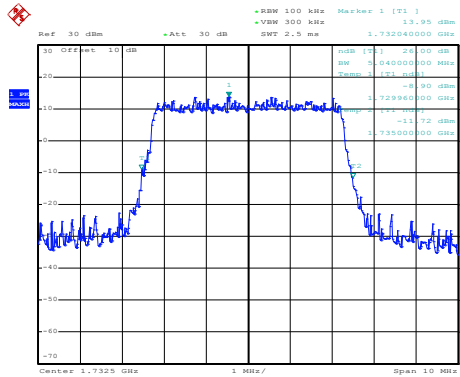

Date: 12.OCT.2019 16:58:32

QPSK

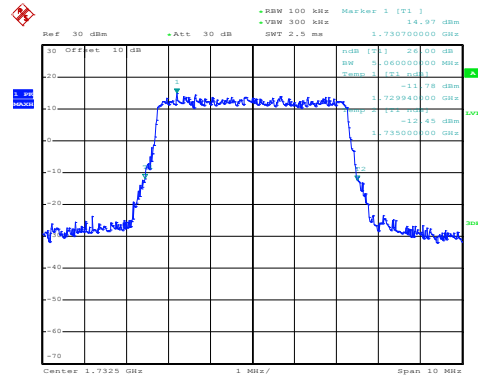

Date: 12.OCT.2019 16:58:28

Middle channel

16QAM

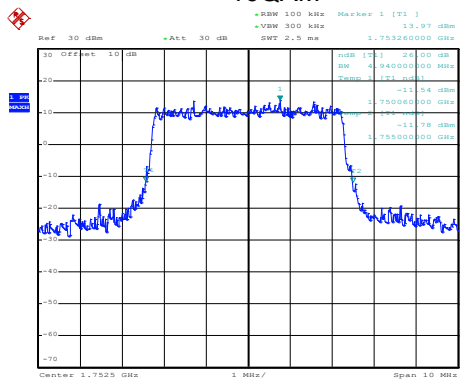

Date: 12.OCT.2019 16:59:09

QPSK

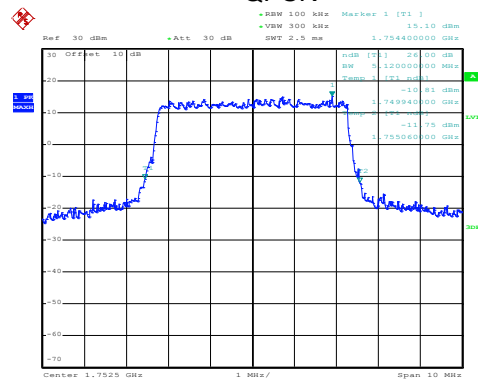

Date: 12.OCT.2019 16:59:05

Highest channel

LTE Band 4: -26dBc bandwidth
BW: 10MHz

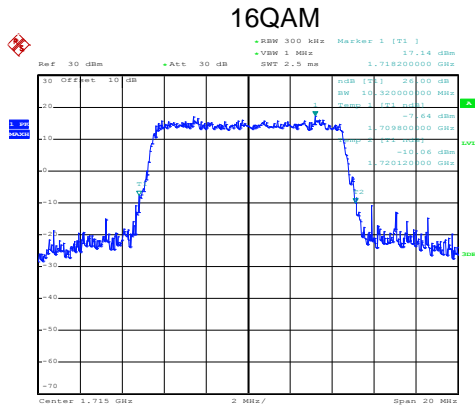

Date: 12.OCT.2019 17:02:18

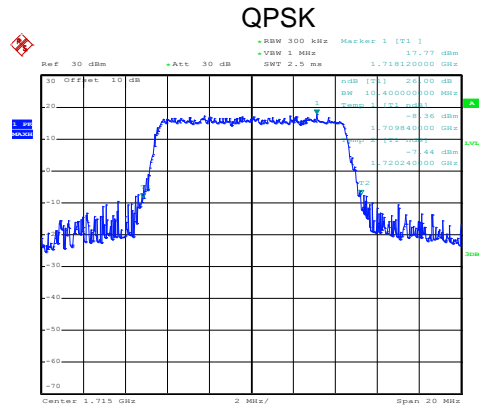

Date: 12.OCT.2019 17:02:12

Lowest channel

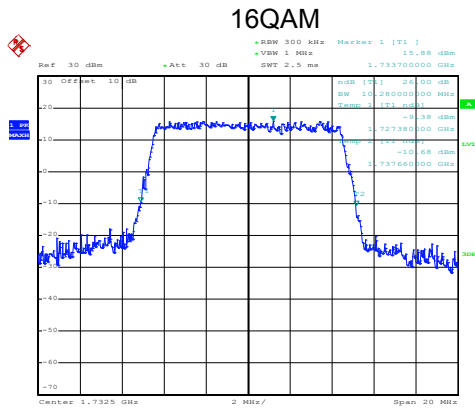

Date: 12.OCT.2019 17:00:41

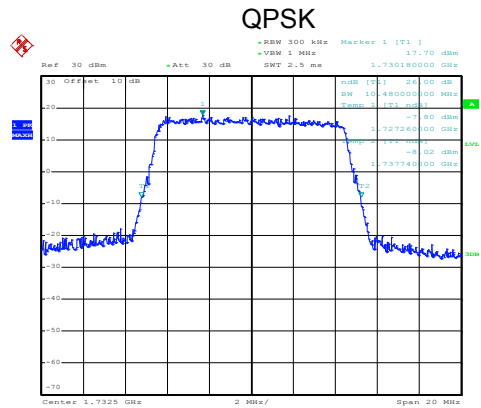

Date: 12.OCT.2019 17:00:35

Middle channel

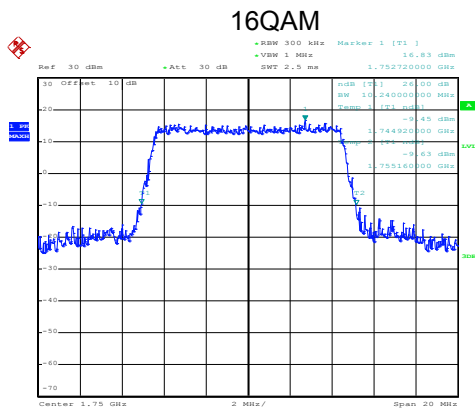

Date: 12.OCT.2019 17:01:20

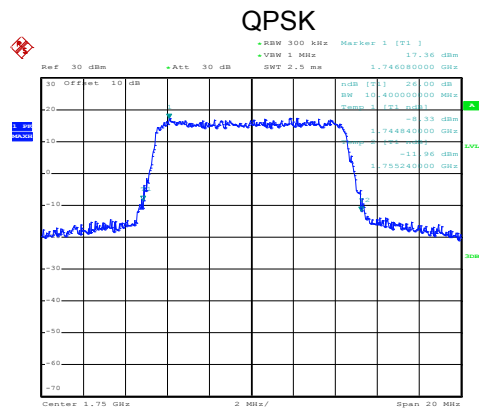

Date: 12.OCT.2019 17:01:16

Highest channel

LTE Band 4: -26dBc bandwidth
BW: 15MHz

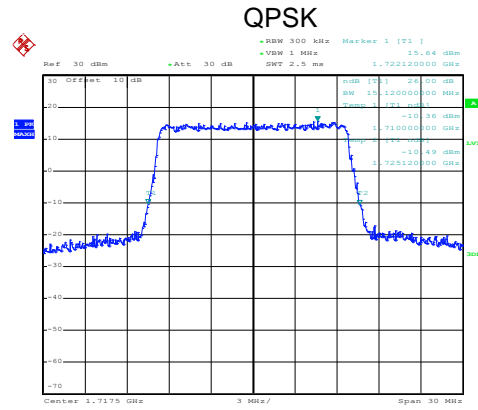
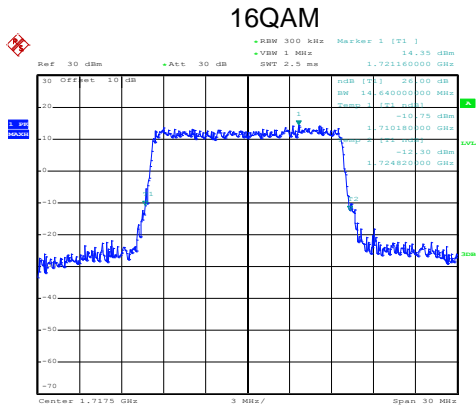

Date: 12.OCT.2019 17:02:41

Date: 12.OCT.2019 17:02:38

Lowest channel

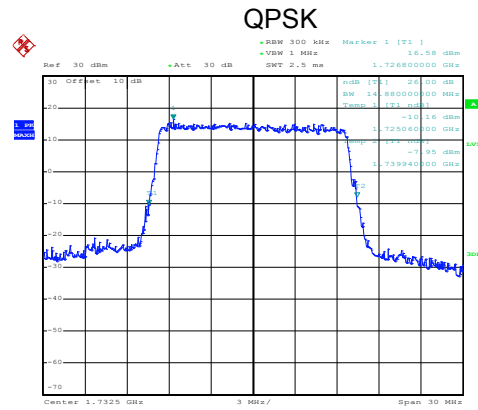
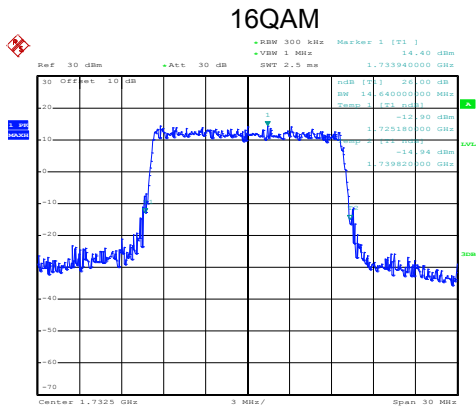

Date: 12.OCT.2019 17:03:15

Date: 12.OCT.2019 17:03:11

Middle channel

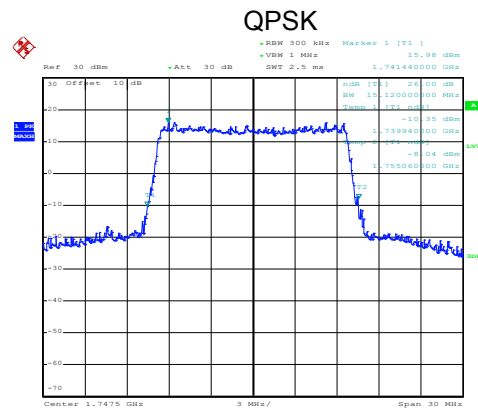
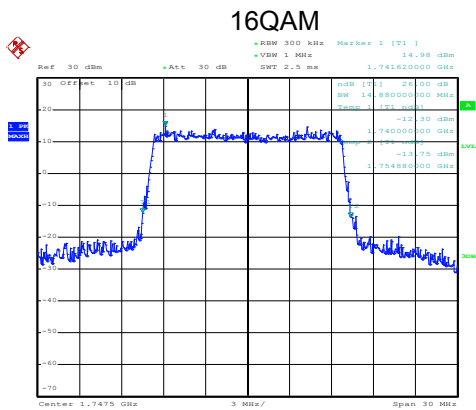

Date: 12.OCT.2019 17:03:33

Date: 12.OCT.2019 17:03:28

Highest channel

LTE Band 4: -26dBc bandwidth
BW: 20MHz

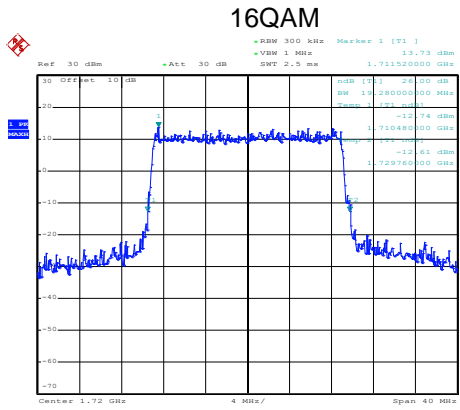

Date: 12.OCT.2019 17:04:15

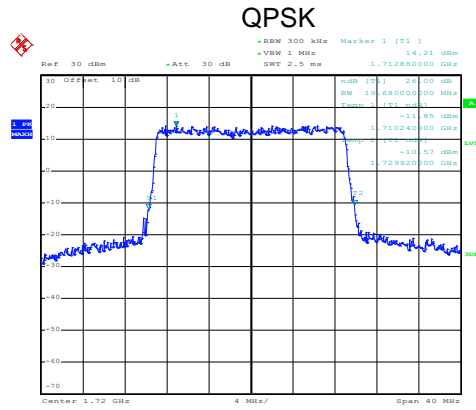

Date: 12.OCT.2019 17:04:12

Lowest channel

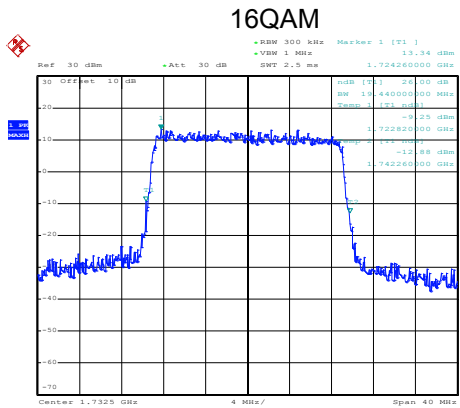

Date: 12.OCT.2019 17:04:27

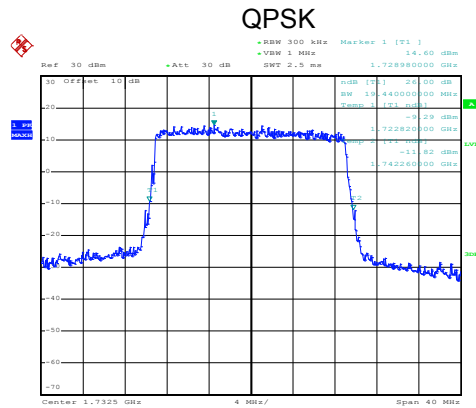

Date: 12.OCT.2019 17:04:23

Middle channel

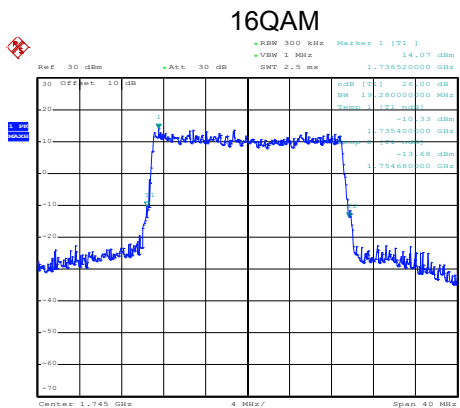

Date: 12.OCT.2019 17:04:58

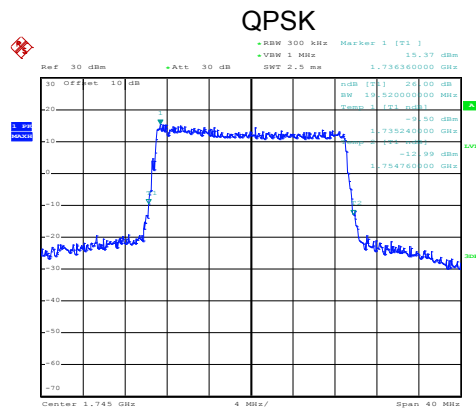

Date: 12.OCT.2019 17:04:55

Highest channel

LTE Band 17 part:

LTE Band 17: 99% Occupy bandwidth
BW: 5MHz

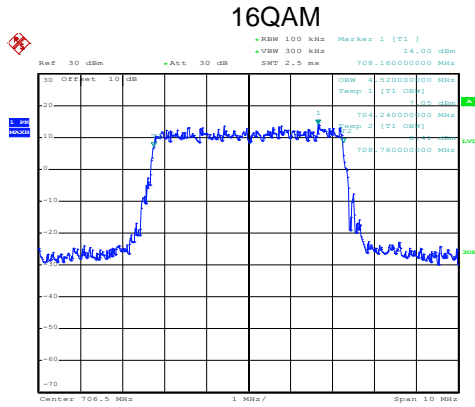

Date: 12.OCT.2019 17:08:54

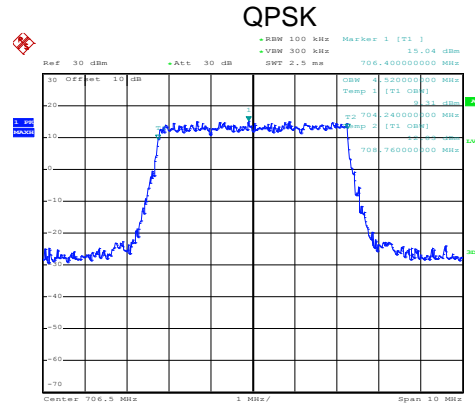

Date: 12.OCT.2019 17:08:51

Lowest channel

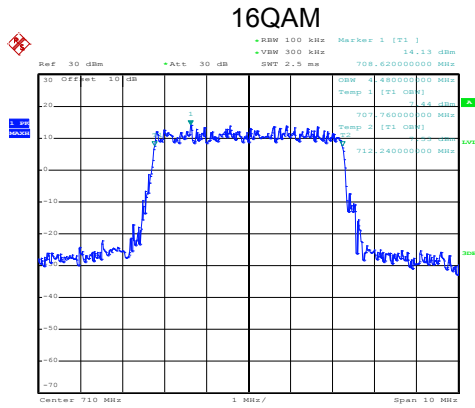

Date: 12.OCT.2019 17:09:07

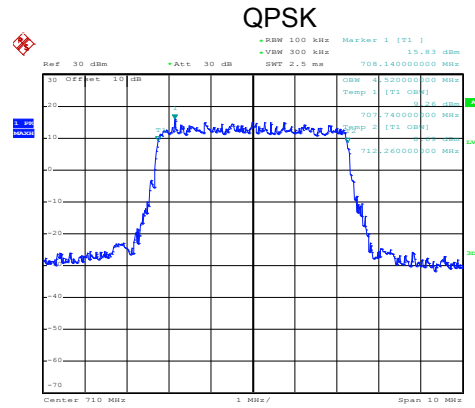

Date: 12.OCT.2019 17:09:04

Middle channel

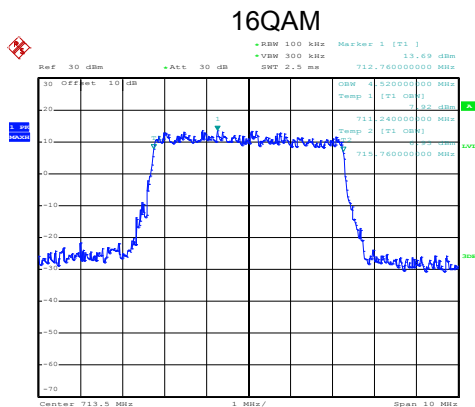

Date: 12.OCT.2019 17:09:43

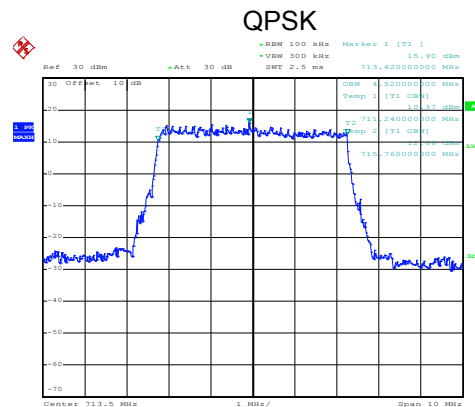

Date: 12.OCT.2019 17:09:40

Highest channel

LTE Band 17: 99% Occupy bandwidth
BW: 10MHz

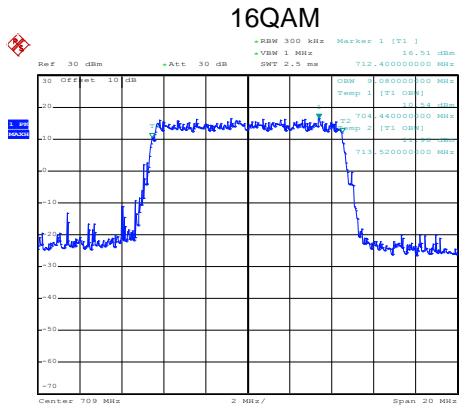

Date: 12.OCT.2019 17:11:10

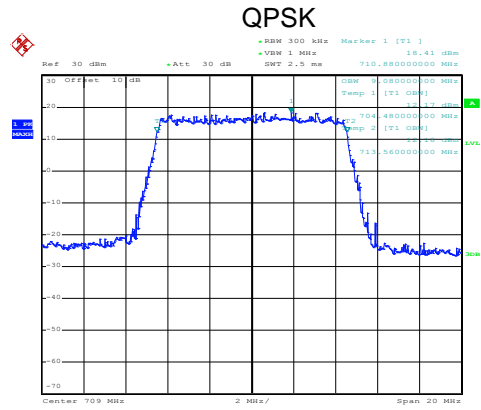

Date: 12.OCT.2019 17:11:34

Lowest channel

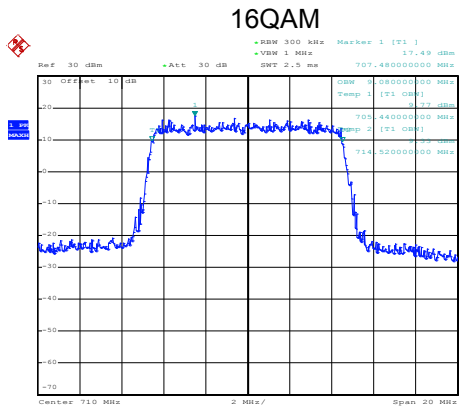

Date: 12.OCT.2019 17:11:53

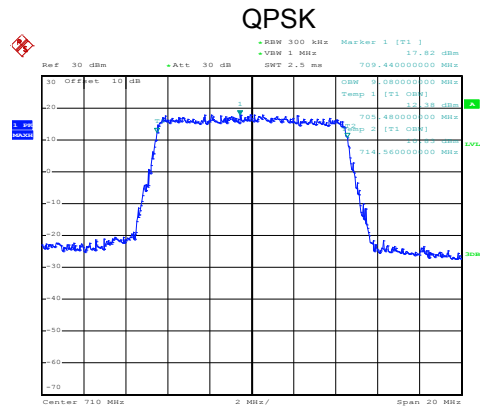

Date: 12.OCT.2019 17:12:10

Middle channel

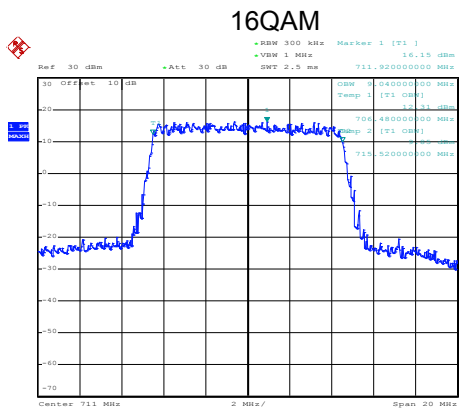

Date: 12.OCT.2019 17:12:29

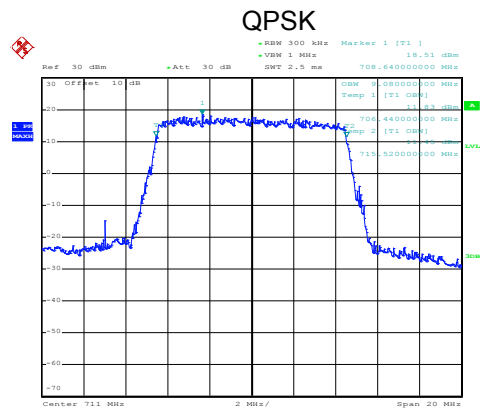

Date: 12.OCT.2019 17:12:25

Highest channel

LTE Band 17: -26dBc bandwidth
BW: 5MHz

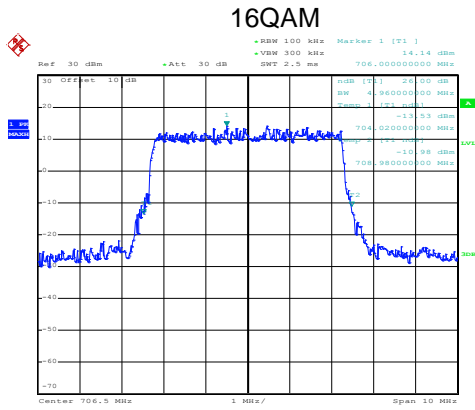

Date: 12.OCT.2019 17:08:44

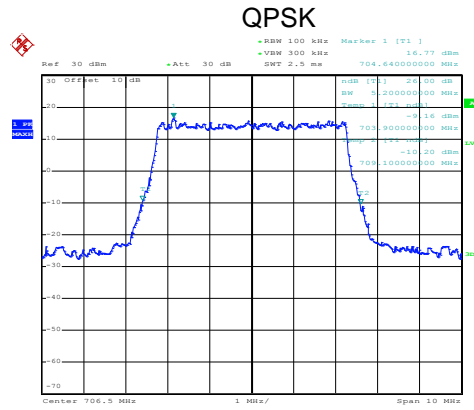

Date: 12.OCT.2019 17:08:40

Lowest channel

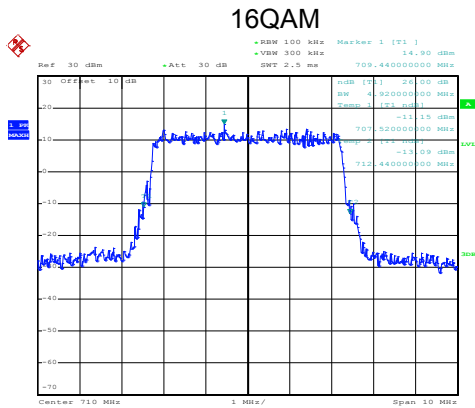

Date: 12.OCT.2019 17:09:16

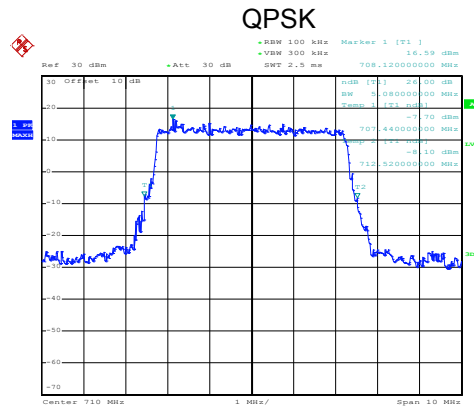

Date: 12.OCT.2019 17:09:13

Middle channel

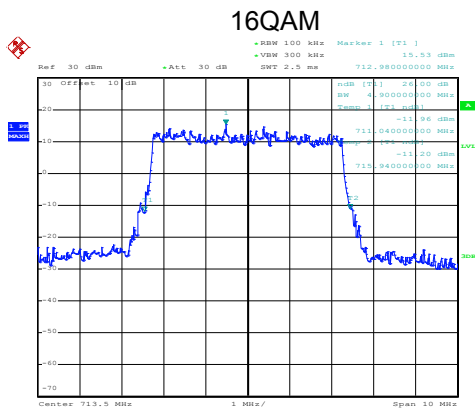

Date: 12.OCT.2019 17:09:34

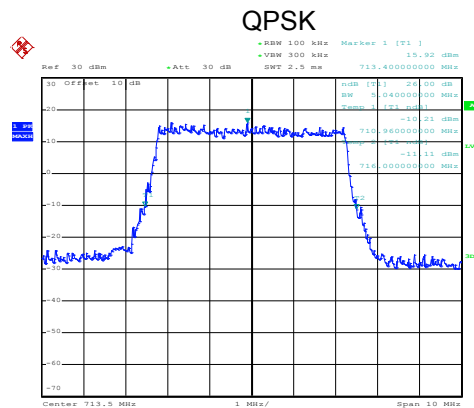

Date: 12.OCT.2019 17:09:30

Highest channel

LTE Band 17: -26dBc bandwidth
BW: 10MHz

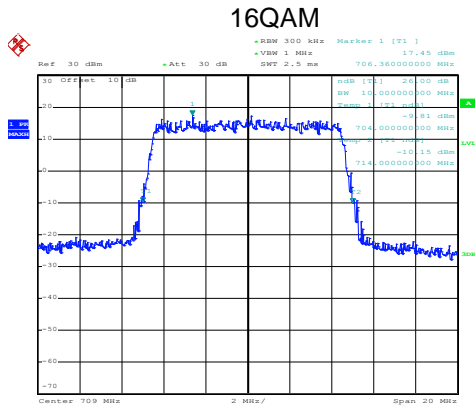

Date: 12.OCT.2019 17:11:21

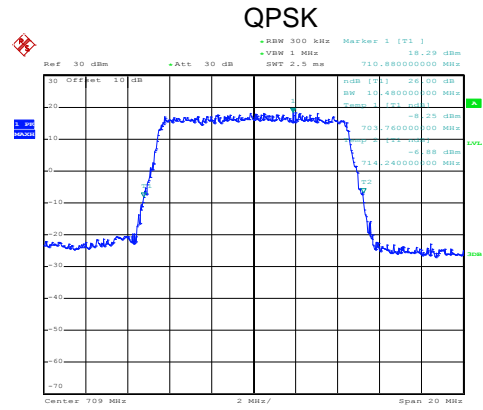

Date: 12.OCT.2019 17:11:18

Lowest channel

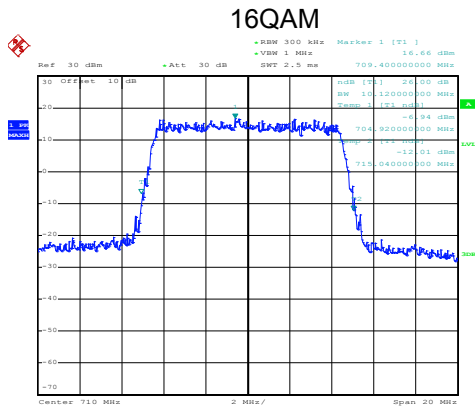

Date: 12.OCT.2019 17:12:03

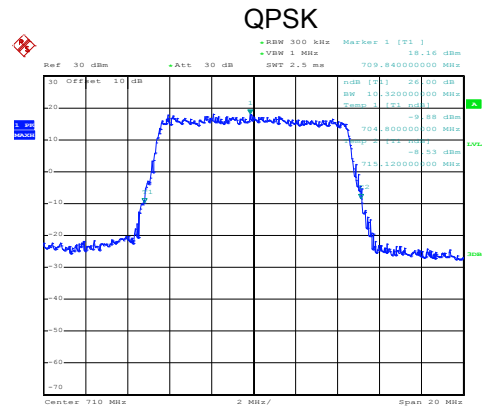

Date: 12.OCT.2019 17:11:59

Middle channel

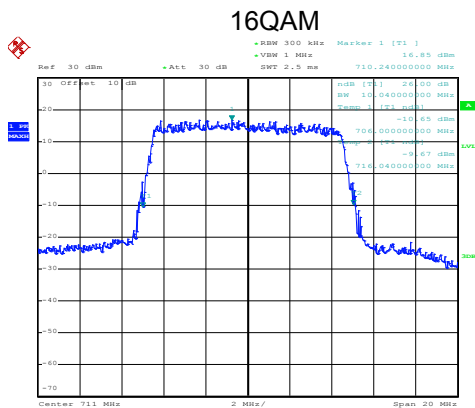

Date: 12.OCT.2019 17:12:40

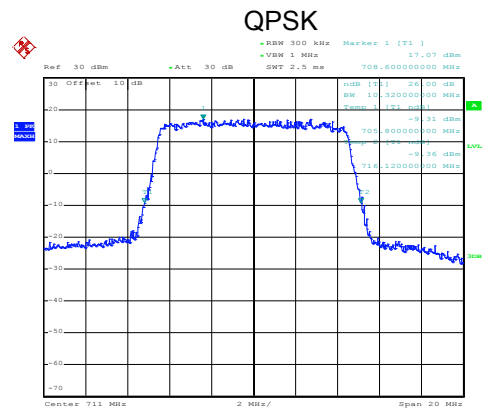

Date: 12.OCT.2019 17:12:37

Highest channel

6.4 Out of band emission at antenna terminals

Test Requirement:	Part 24.238 (a), part 27.53(g), part 27.53(h)
Limit:	LTE Band 2 & 4 & 17: The power of any emission outside a licensee's frequency block shall be attenuated below the transmitter power (P) in watts by at least $43 + 10 \log_{10}(P)$ dB (-13 dBm).
Test Setup:	
Test Procedure:	<ol style="list-style-type: none"> 1 The RF output of the transceiver was connected to a spectrum analyzer through appropriate attenuation. 2 The resolution bandwidth of the spectrum analyzer was set at 100 kHz when below 1GHz, 1MHz when above 1 GHz; sufficient scans were taken to show the out of band Emissions if any up to 10th harmonic. 3 For the out of band: Set the RBW=100 kHz, VBW=300 kHz when below 1 GHz, RBW =1 MHz, VBW=3 MHz when above 1 GHz, Start=30MHz, Stop= 10th harmonic. 4 Band Edge Requirements: In the 1 MHz bands immediately outside and adjacent to the frequency block, a resolution bandwidth of at least 1 percent of the emission bandwidth of the fundamental emission of the transmitter may be employed to measure the out of band Emissions.
Test Instruments:	Refer to section 5.10 for details
Test mode:	Refer to section 5.3 for details
Test results:	Passed
Remark:	Pre-scan all RB Size and offset, and found the RB Size and offset of worst case, so the report shows only the worst case test data.

Test plots as follows (Conducted spurious emission) (worst case):
 LTE Band 2 part:

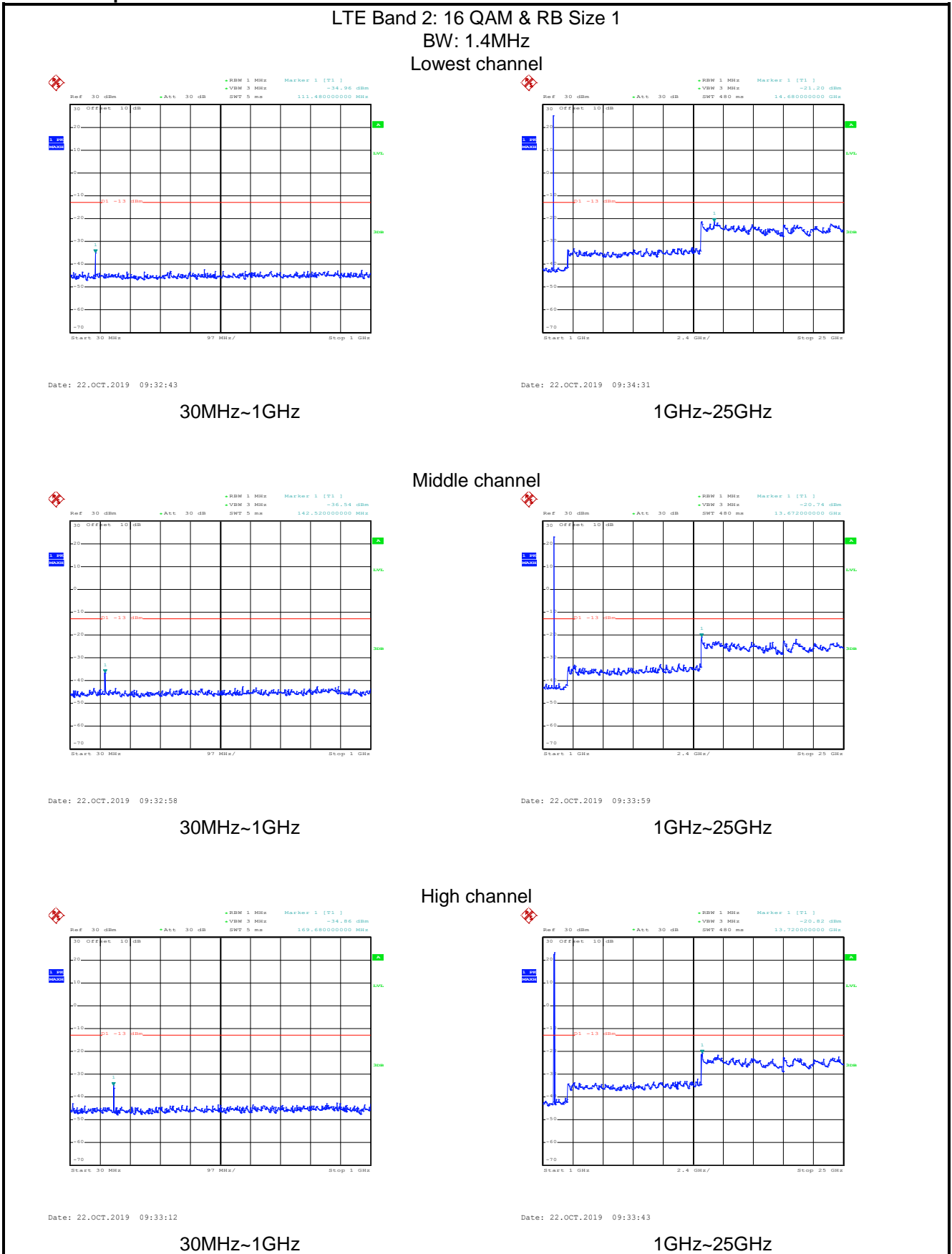

LTE Band 2: QPSK & RB Size 1 BW: 1.4MHz Lowest channel

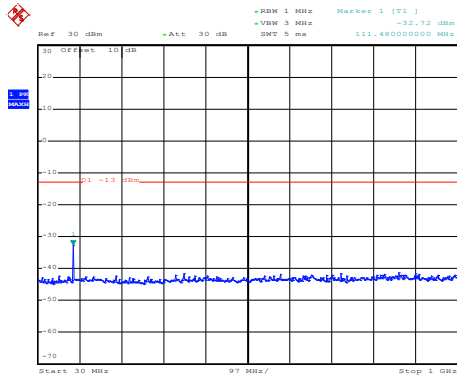

30MHz~1GHz

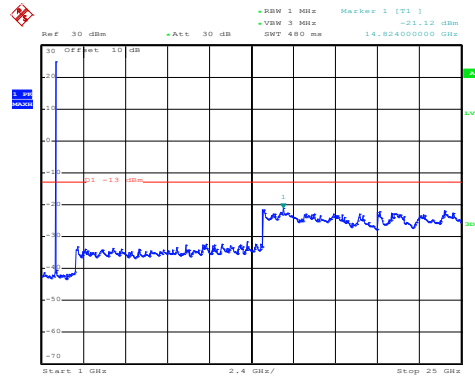

1GHz~25GHz

Middle channel

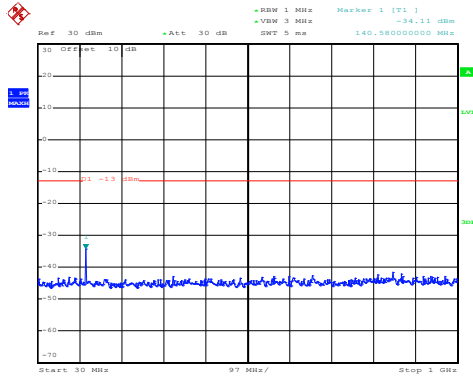

30MHz~1GHz

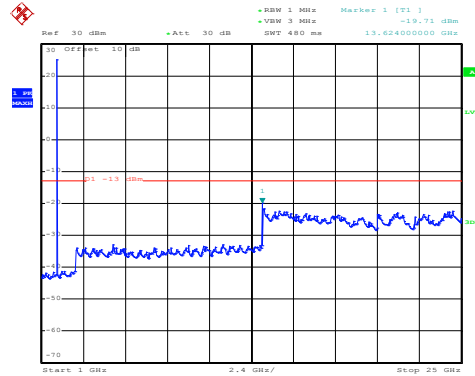

1GHz~25GHz

High channel

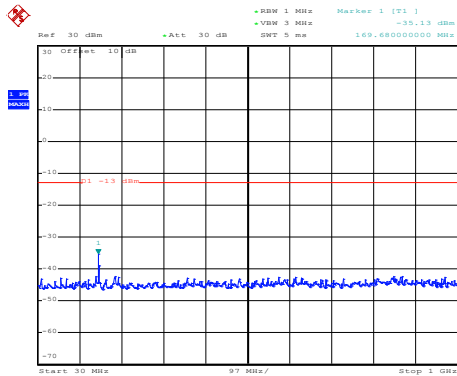

30MHz~1GHz

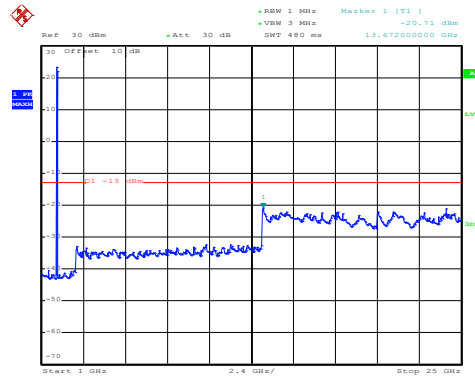

1GHz~25GHz

LTE Band 2: 16 QAM & RB Size 1 BW: 20MHz Lowest channel

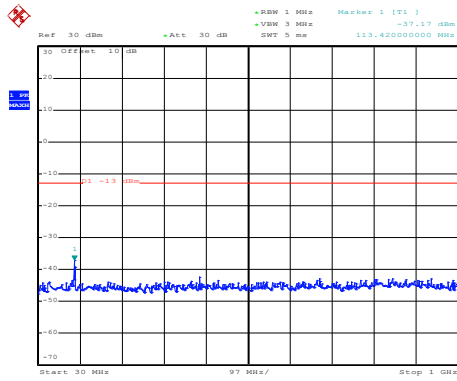

Date: 14.OCT.2019 09:05:29

30MHz~1GHz

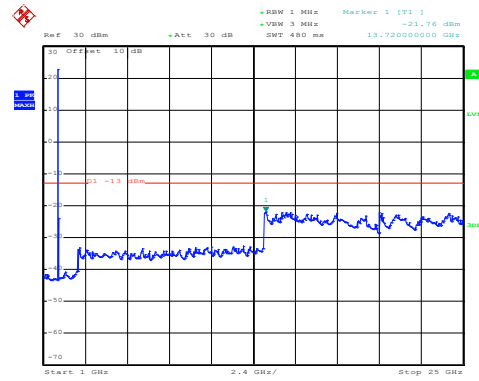

Date: 14.OCT.2019 09:09:31

1GHz~25GHz

Middle channel

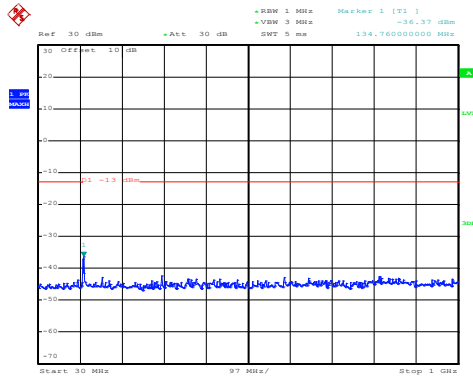

Date: 14.OCT.2019 09:07:09

30MHz~1GHz

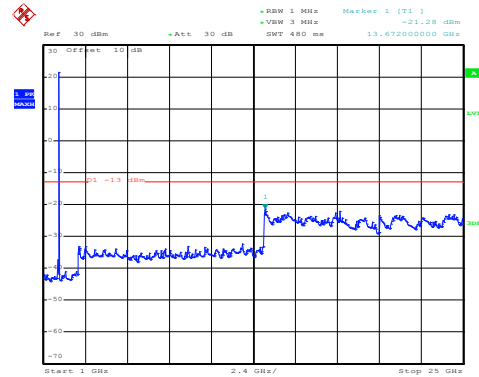

Date: 14.OCT.2019 09:08:52

1GHz~25GHz

High channel

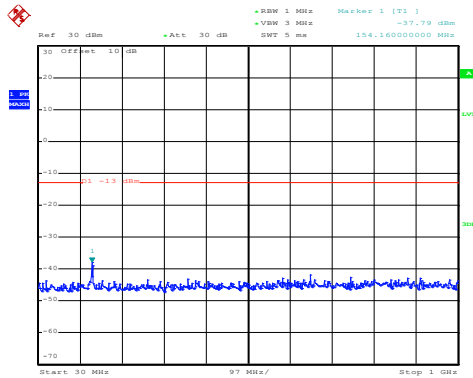

Date: 14.OCT.2019 09:07:42

30MHz~1GHz

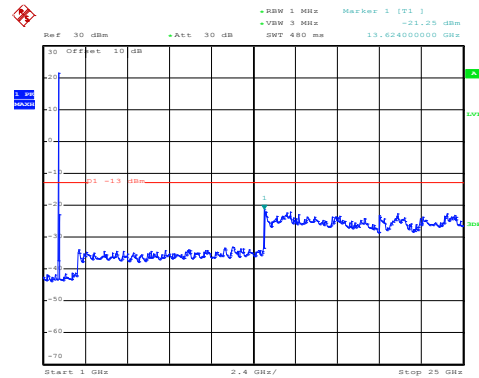

Date: 14.OCT.2019 09:08:12

1GHz~25GHz

LTE Band 2: QPSK & RB Size 1 BW: 20MHz Lowest channel

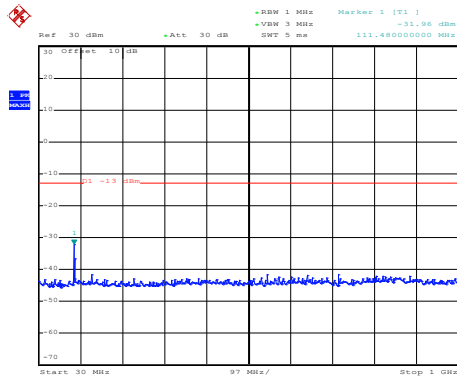

Date: 14.OCT.2019 09:05:14

30MHz~1GHz

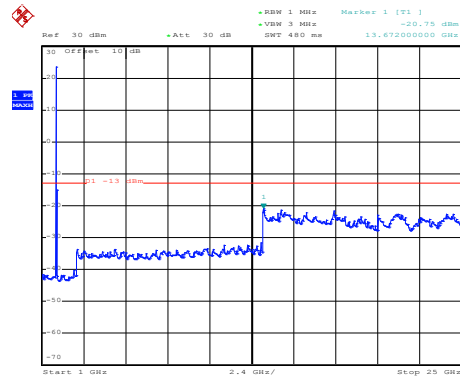

Date: 14.OCT.2019 09:09:20

1GHz~25GHz

Middle channel

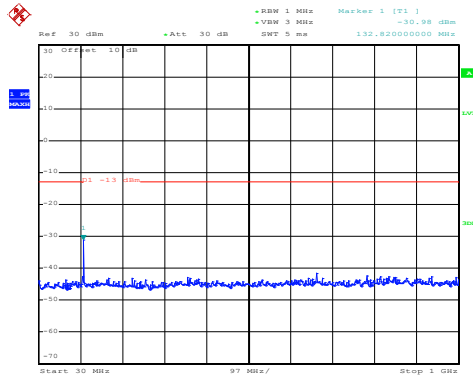

Date: 14.OCT.2019 09:07:05

30MHz~1GHz

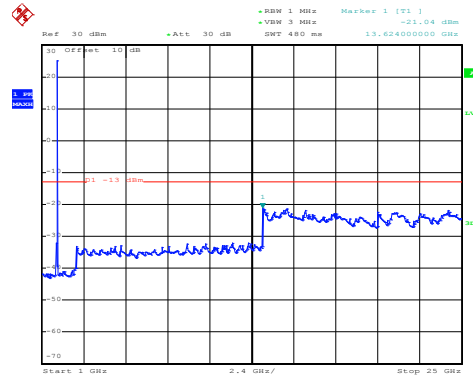

Date: 14.OCT.2019 09:08:46

1GHz~25GHz

High channel

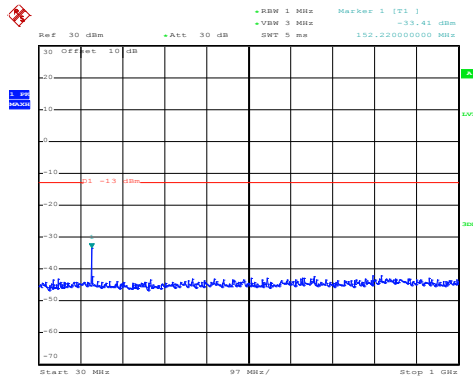

Date: 14.OCT.2019 09:07:38

30MHz~1GHz

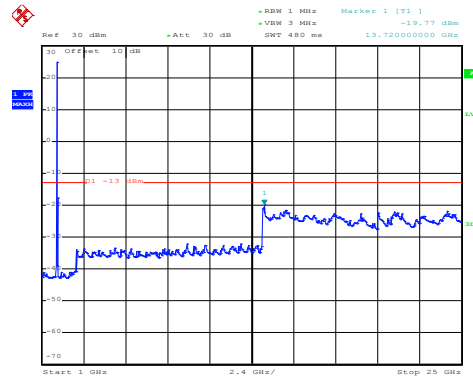

Date: 14.OCT.2019 09:08:07

1GHz~25GHz

LTE Band 4 part:

LTE Band 4: 16 QAM & RB Size 1 BW: 1.4MHz Lowest channel

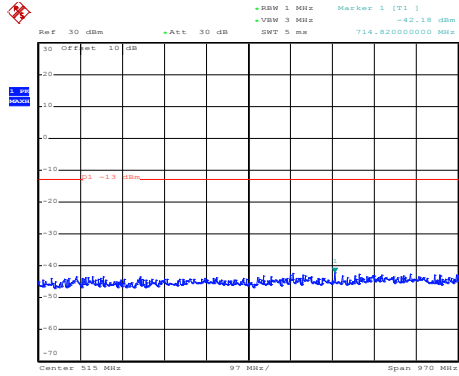

Date: 13.OCT.2019 19:34:01

30MHz~1GHz

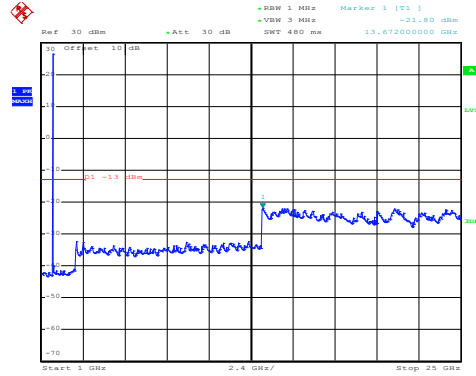

Date: 13.OCT.2019 19:39:17

1GHz~25GHz

Middle channel

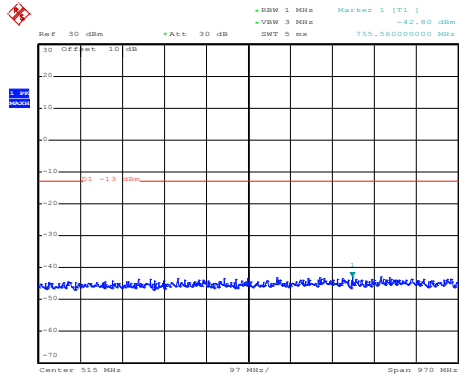

Date: 13.OCT.2019 19:34:14

30MHz~1GHz

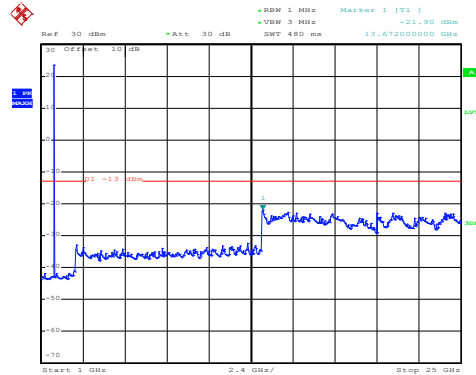

Date: 13.OCT.2019 19:38:55

1GHz~25GHz

High channel

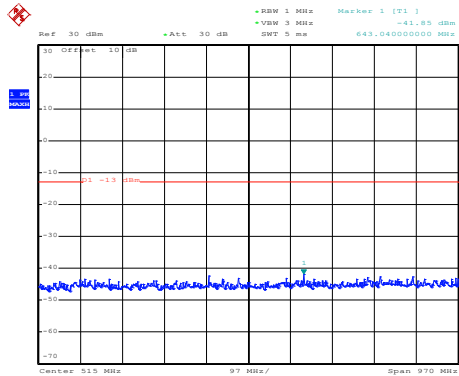

Date: 13.OCT.2019 19:34:57

30MHz~1GHz

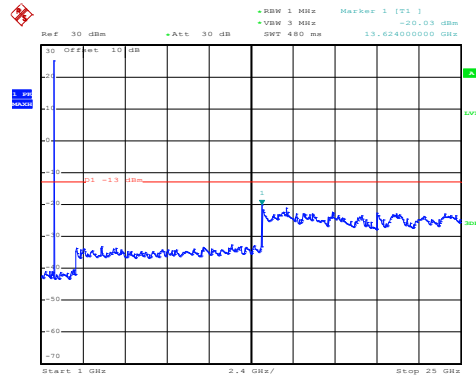

Date: 13.OCT.2019 19:38:42

1GHz~25GHz

LTE Band 4: QPSK & RB Size 1 BW: 1.4MHz Lowest channel

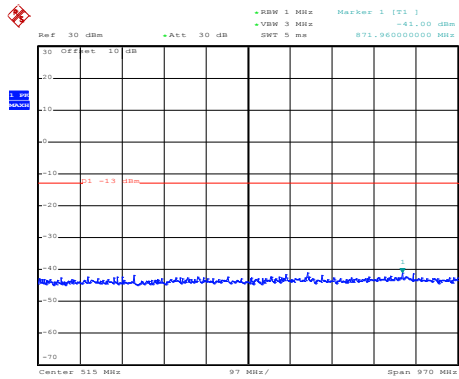

Date: 13.OCT.2019 19:33:54

30MHz~1GHz

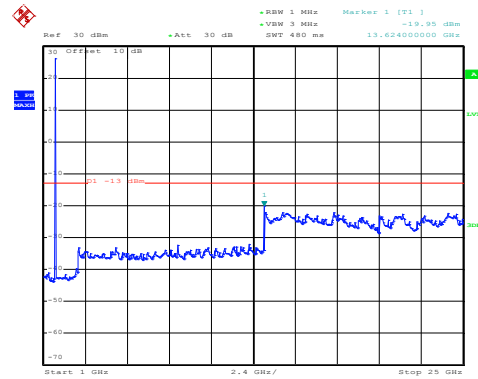

Date: 13.OCT.2019 19:39:06

1GHz~25GHz

Middle channel

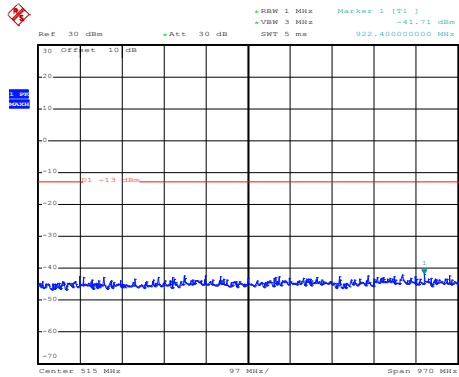

Date: 13.OCT.2019 19:34:10

30MHz~1GHz

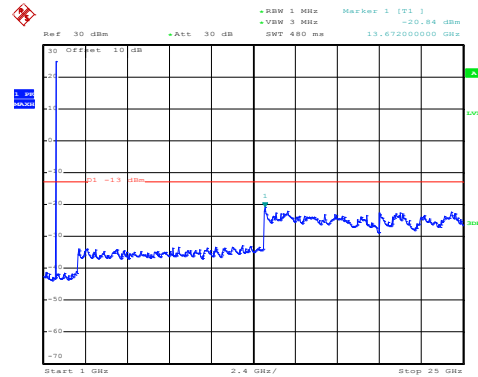

Date: 13.OCT.2019 19:38:50

1GHz~25GHz

High channel

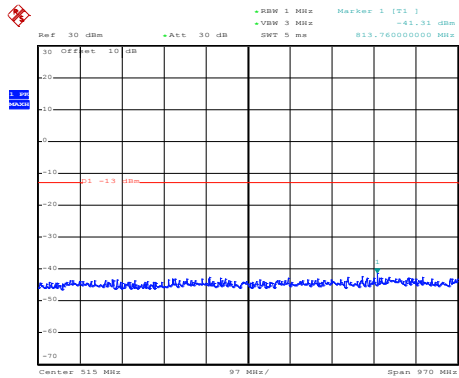

Date: 13.OCT.2019 19:34:53

30MHz~1GHz

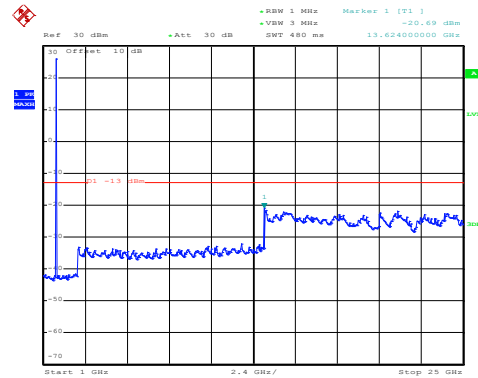

Date: 13.OCT.2019 19:38:32

1GHz~25GHz

LTE Band 4: 16 QAM & RB Size 1 BW: 20MHz Lowest channel

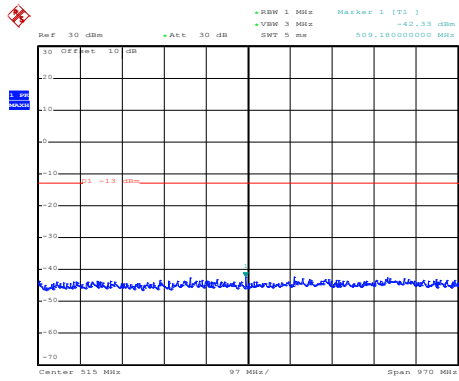

Date: 13.OCT.2019 19:36:56

30MHz~1GHz

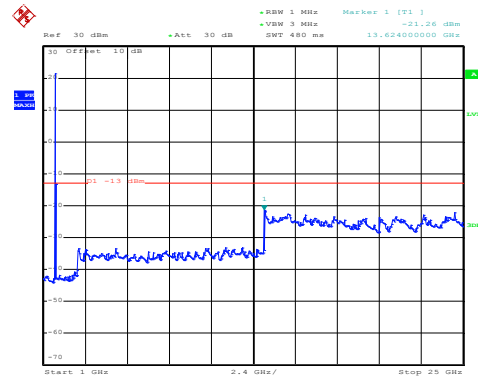

Date: 13.OCT.2019 19:37:25

1GHz~25GHz

Middle channel

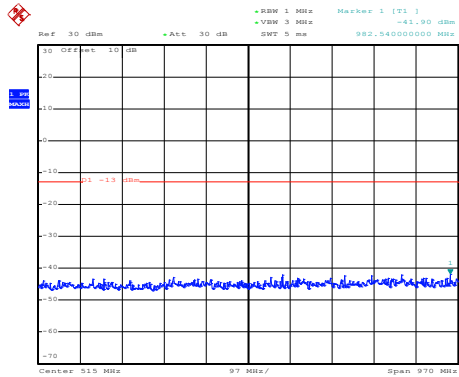

Date: 13.OCT.2019 19:36:08

30MHz~1GHz

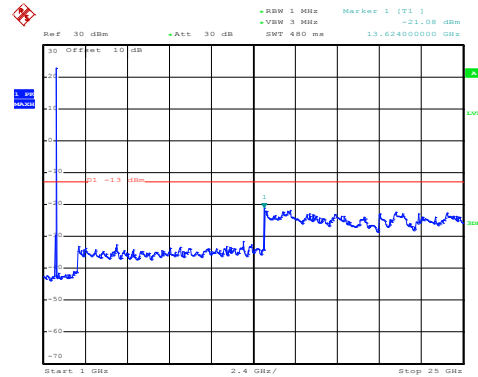

Date: 13.OCT.2019 19:37:44

1GHz~25GHz

High channel

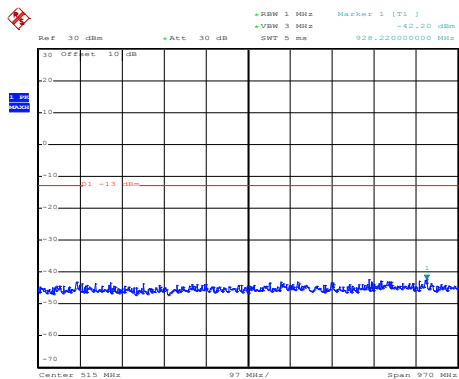

Date: 13.OCT.2019 19:36:42

30MHz~1GHz

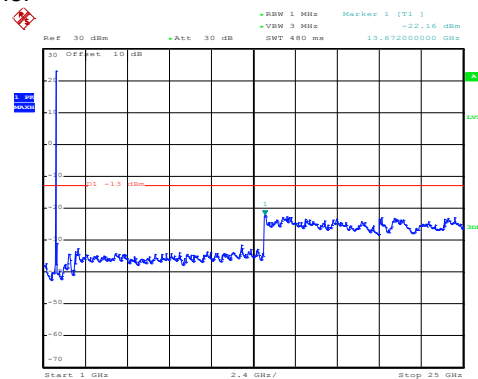

Date: 13.OCT.2019 19:38:04

1GHz~25GHz

LTE Band 4: QPSK & RB Size 1 BW: 20MHz Lowest channel

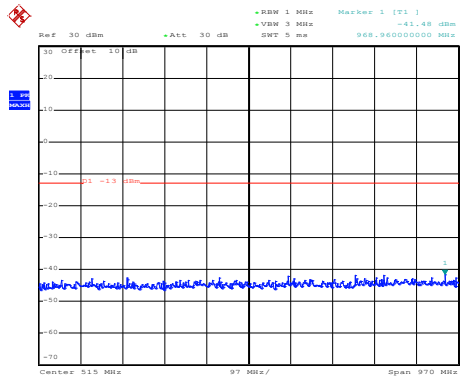

Date: 13.OCT.2019 19:36:51

30MHz~1GHz

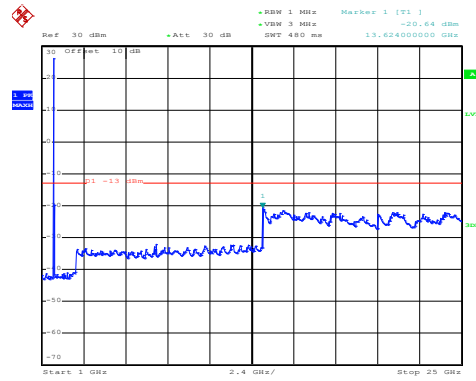

Date: 13.OCT.2019 19:37:20

1GHz~25GHz

Middle channel

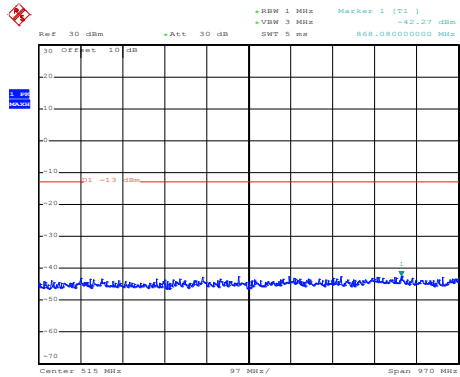

Date: 13.OCT.2019 19:36:04

30MHz~1GHz

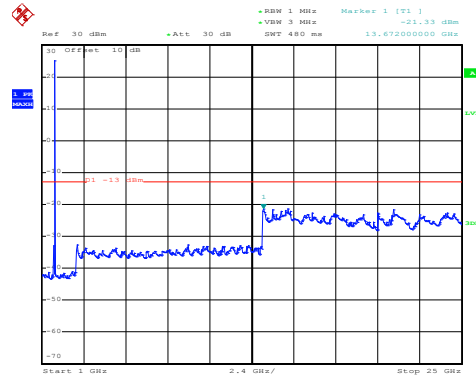

Date: 13.OCT.2019 19:37:37

1GHz~25GHz

High channel

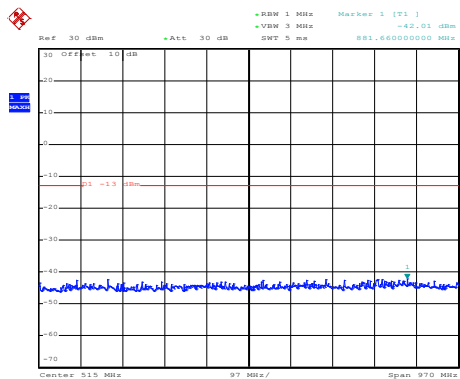

Date: 13.OCT.2019 19:36:39

30MHz~1GHz

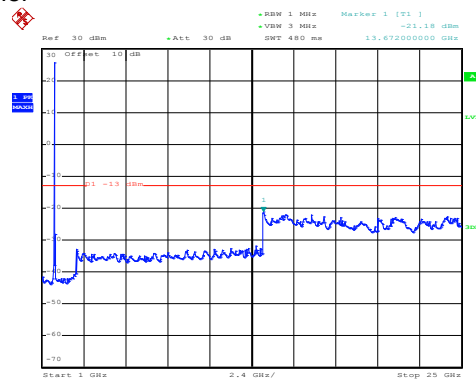

Date: 13.OCT.2019 19:37:56

1GHz~25GHz

LTE Band 17 part:

LTE Band 17: 16 QAM & RB Size 1
 BW: 5MHz
 Lowest channel

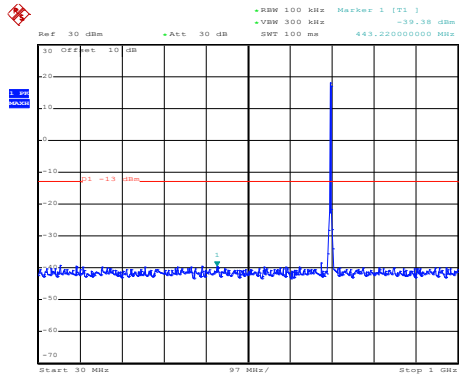

Date: 14.OCT.2019 08:58:51

30MHz~1GHz

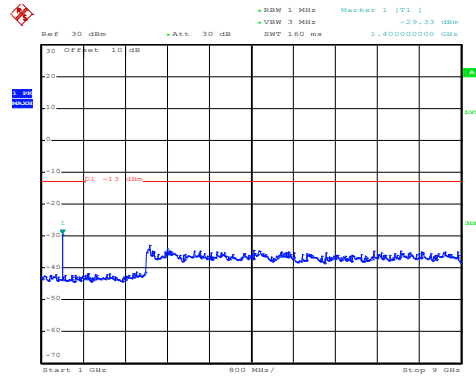

Date: 14.OCT.2019 09:01:28

1GHz~9GHz

Middle channel

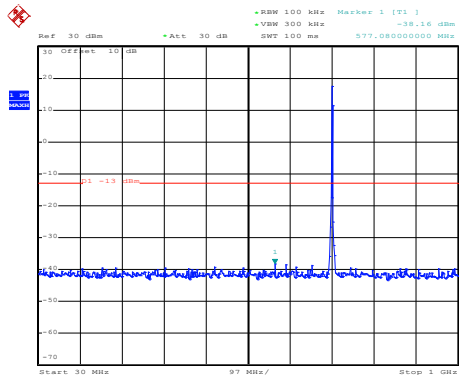

Date: 14.OCT.2019 08:59:10

30MHz~1GHz

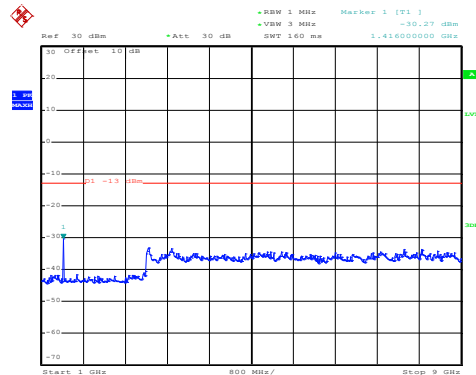

Date: 14.OCT.2019 09:01:44

1GHz~9GHz

High channel

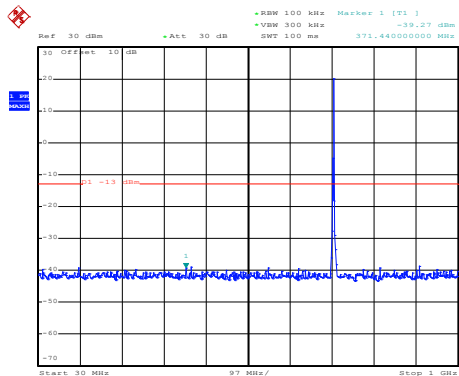

Date: 14.OCT.2019 08:59:32

30MHz~1GHz

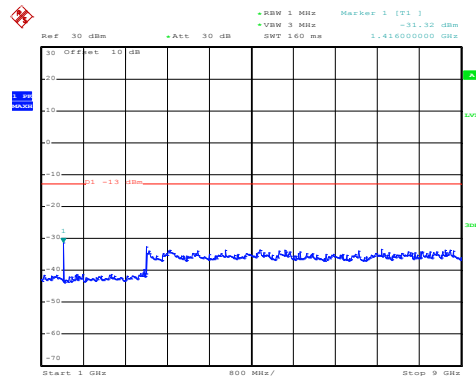

Date: 14.OCT.2019 09:02:05

1GHz~9GHz

LTE Band 17: QPSK & RB Size 1
 BW: 5MHz
 Lowest channel

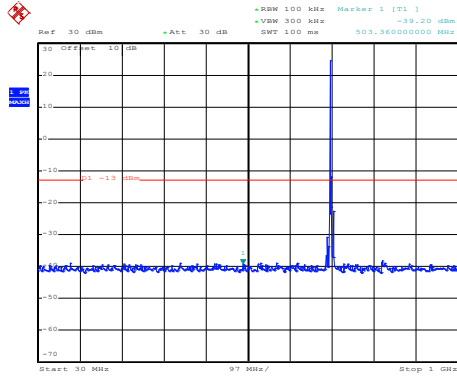

30MHz~1GHz

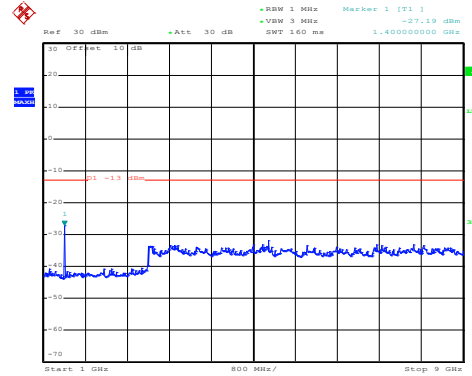

1GHz~9GHz

Middle channel

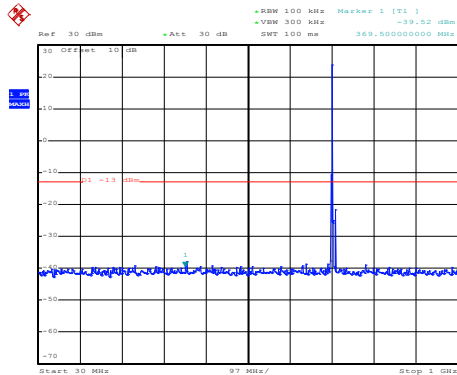

30MHz~1GHz

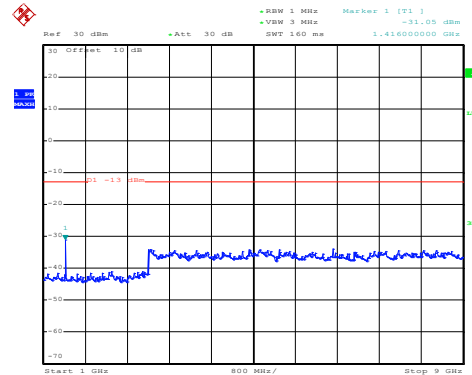

1GHz~9GHz

High channel

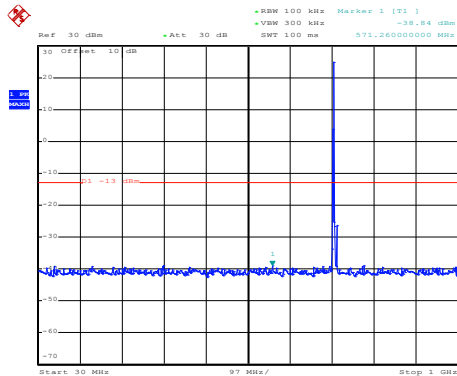

30MHz~1GHz

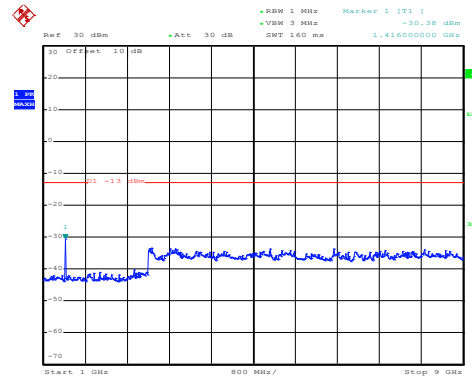

1GHz~9GHz

LTE Band 17: 16 QAM & RB Size 1 BW: 10MHz Lowest channel

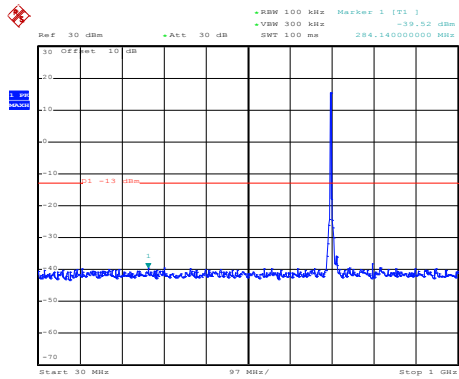

Date: 14.OCT.2019 09:03:37

30MHz~1GHz

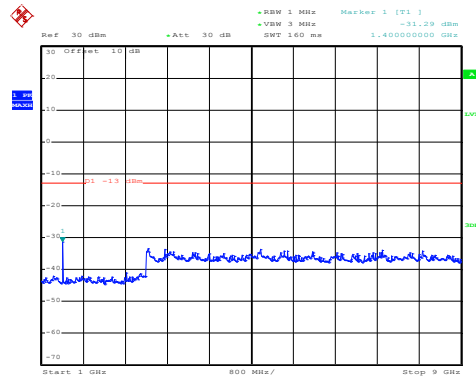

Date: 14.OCT.2019 09:02:59

1GHz~9GHz

Middle channel

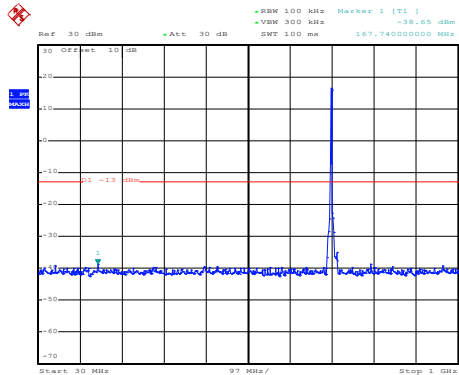

Date: 14.OCT.2019 09:04:10

30MHz~1GHz

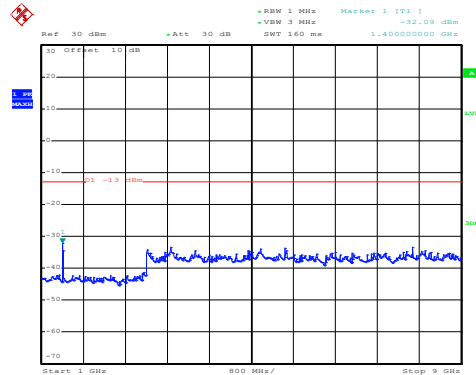

Date: 14.OCT.2019 09:02:46

1GHz~9GHz

High channel

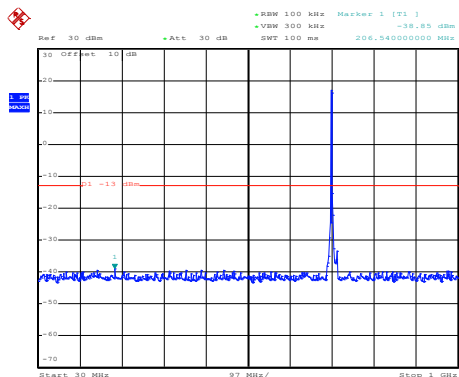

Date: 14.OCT.2019 09:04:21

30MHz~1GHz

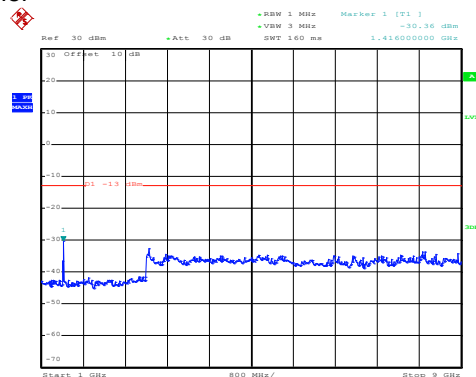

Date: 14.OCT.2019 09:02:33

1GHz~9GHz

LTE Band 17: QPSK & RB Size 1 BW: 10MHz Lowest channel

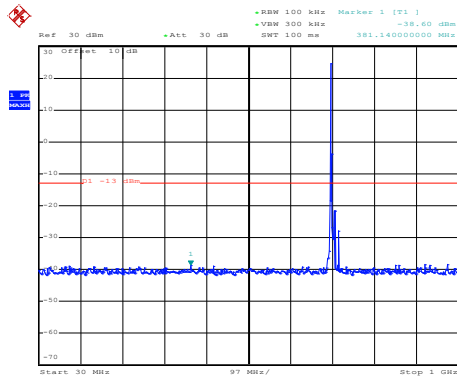

Date: 14.OCT.2019 09:03:30

30MHz~1GHz

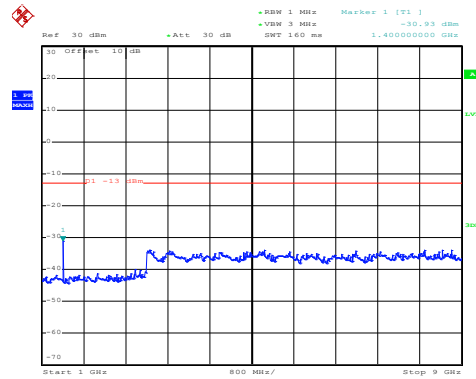

Date: 14.OCT.2019 09:02:55

1GHz~9GHz

Middle channel

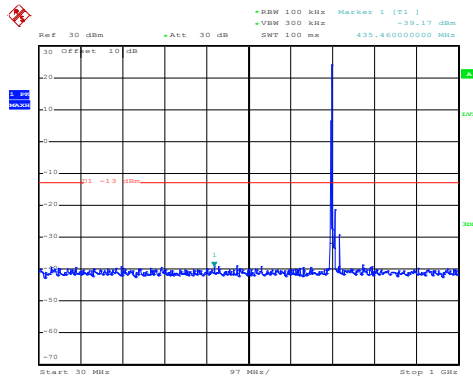

Date: 14.OCT.2019 09:03:50

30MHz~1GHz

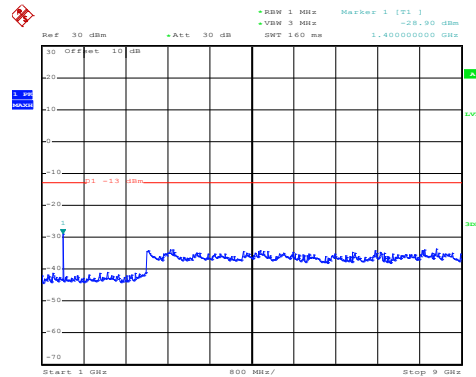

Date: 14.OCT.2019 09:02:42

1GHz~9GHz

High channel

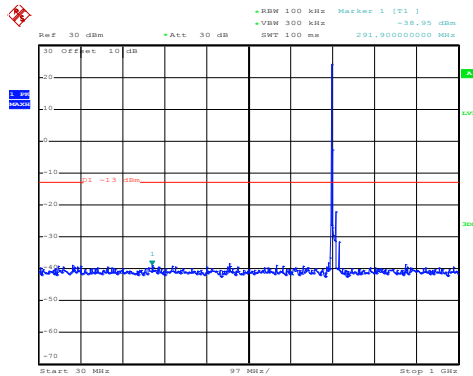

Date: 14.OCT.2019 09:04:15

30MHz~1GHz

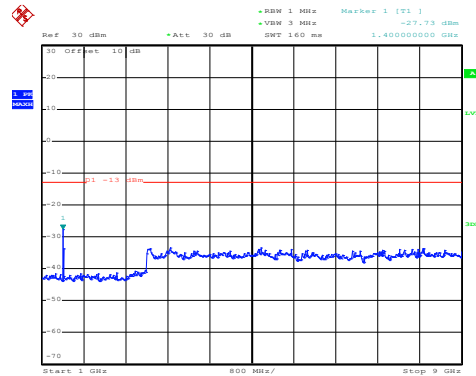

Date: 14.OCT.2019 09:02:29

1GHz~9GHz

Band edge emission:

LTE Band 2 part:

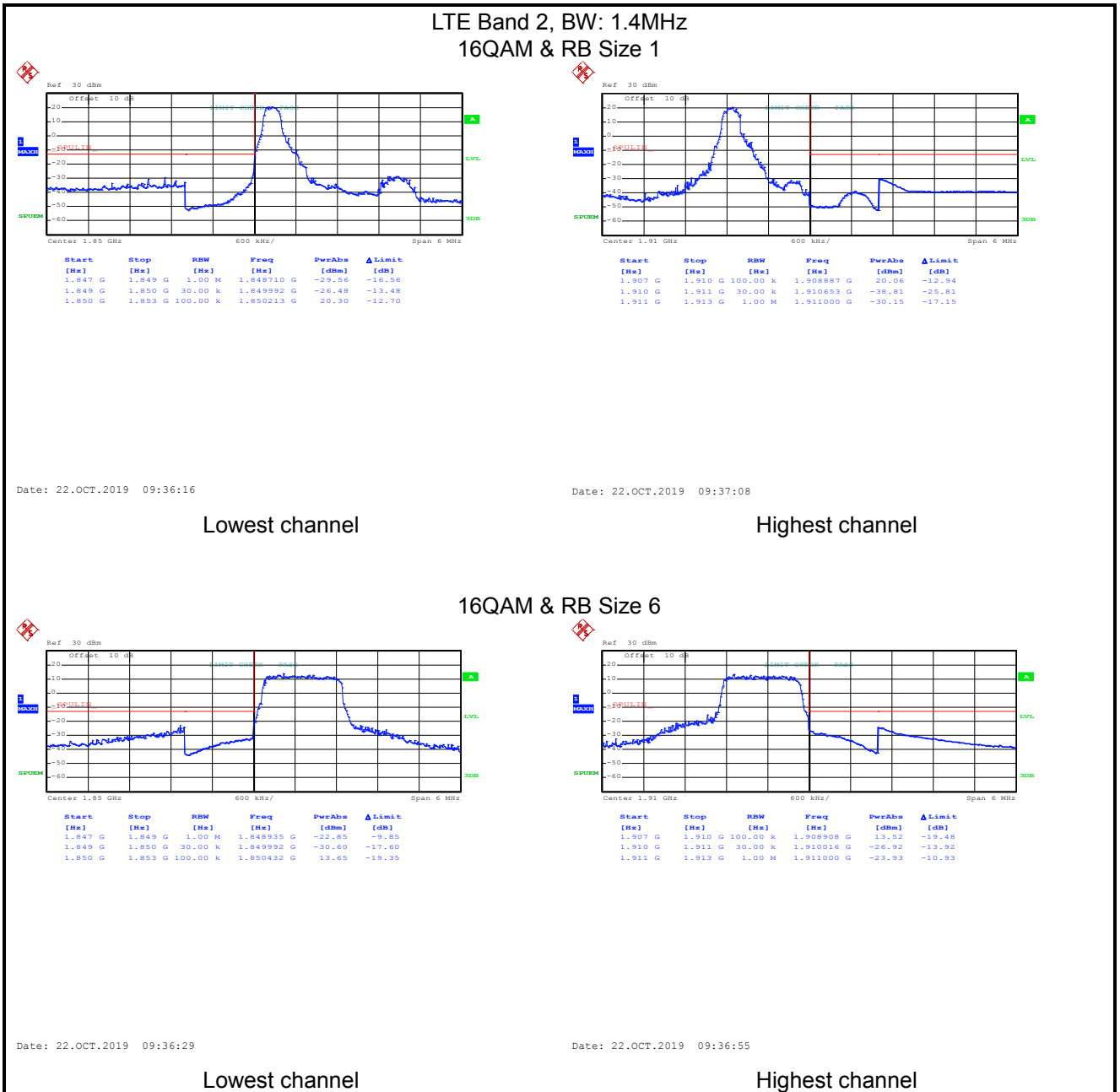

LTE Band 2, BW: 1.4MHz QPSK & RB Size 1

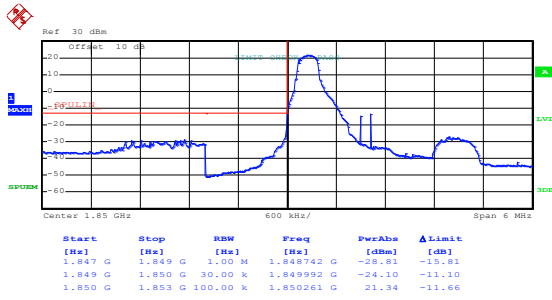

Date: 22.OCT.2019 09:36:07

Lowest channel

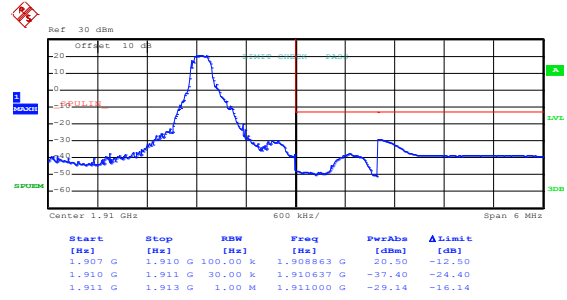

Date: 22.OCT.2019 09:37:02

Highest channel

QPSK & RB Size 6

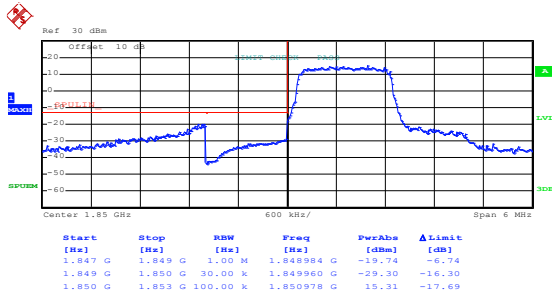

Date: 22.OCT.2019 09:36:24

Lowest channel

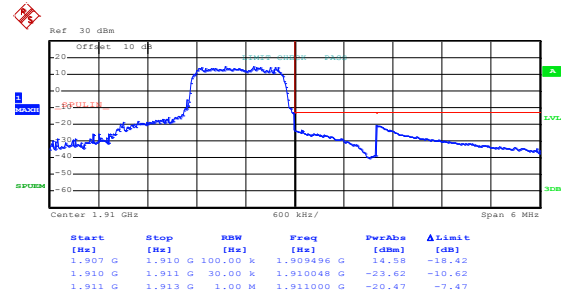

Date: 22.OCT.2019 09:36:50

Highest channel

LTE Band 2, BW: 20MHz 16QAM & RB Size 1

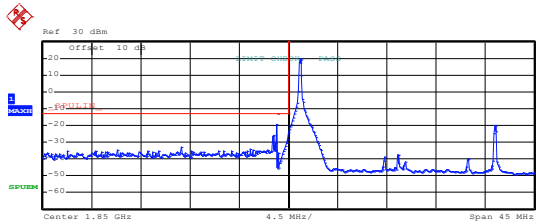

Start [Hz]	Stop [Hz]	RBW [Hz]	Freq [Hz]	PwrAbs [dBm]	ΔLimit [dB]
1.827 G	1.849 G	1.00 M	1.848871 G	-19.17	-6.17
1.849 G	1.850 G	30.00 k	1.849998 G	-28.08	-15.08
1.850 G	1.873 G	100.00 k	1.851103 G	19.75	-13.25

Date: 14.OCT.2019 08:48:39

Lowest channel

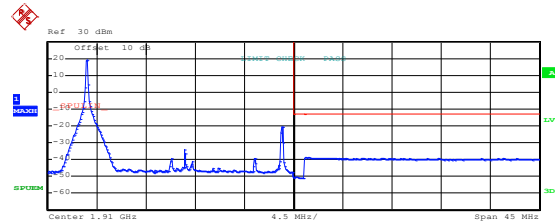

Start [Hz]	Stop [Hz]	RBW [Hz]	Freq [Hz]	PwrAbs [dBm]	ΔLimit [dB]
1.888 G	1.910 G	100.00 k	1.891100 G	19.40	-13.60
1.910 G	1.911 G	30.00 k	1.910065 G	-50.17	-37.17
1.911 G	1.933 G	1.00 M	1.911409 G	-38.76	-25.76

Date: 14.OCT.2019 08:49:34

Highest channel

16QAM & RB Size 100

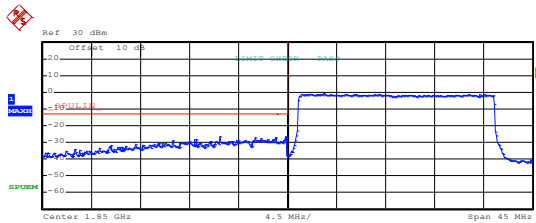

Start [Hz]	Stop [Hz]	RBW [Hz]	Freq [Hz]	PwrAbs [dBm]	ΔLimit [dB]
1.827 G	1.849 G	1.00 M	1.849754 G	-26.70	-13.70
1.849 G	1.850 G	300.00 k	1.849830 G	-26.68	-13.68
1.850 G	1.873 G	100.00 k	1.853308 G	-0.97	-33.97

Date: 14.OCT.2019 08:48:55

Lowest channel

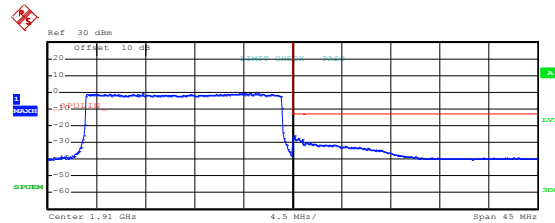

Start [Hz]	Stop [Hz]	RBW [Hz]	Freq [Hz]	PwrAbs [dBm]	ΔLimit [dB]
1.888 G	1.910 G	100.00 k	1.905095 G	-0.61	-33.61
1.910 G	1.911 G	300.00 k	1.910216 G	-25.66	-12.66
1.911 G	1.933 G	1.00 M	1.911258 G	-30.21	-17.21

Date: 14.OCT.2019 08:49:57

Highest channel

LTE Band 2, BW: 20MHz QPSK & RB Size 1

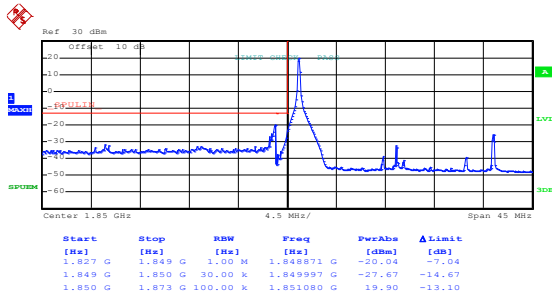

Date: 14.OCT.2019 08:48:31

Lowest channel

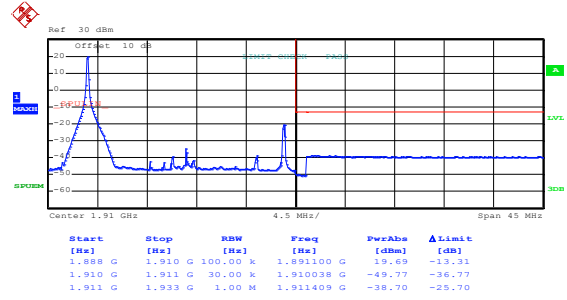

Date: 14.OCT.2019 08:49:27

Highest channel

QPSK & RB Size 100

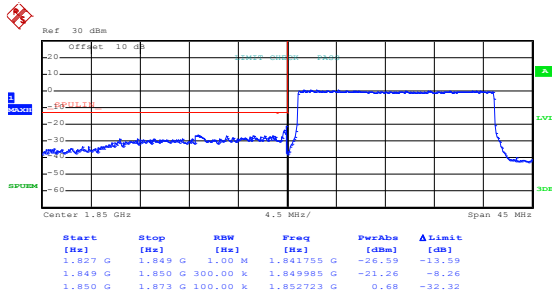

Date: 14.OCT.2019 08:48:50

Lowest channel

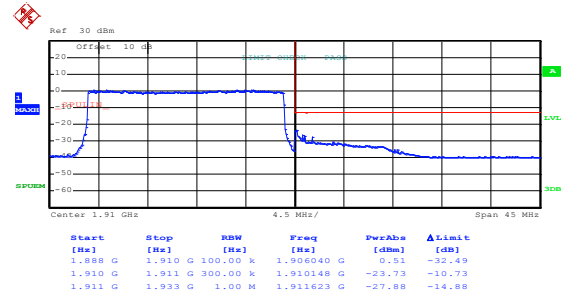

Date: 14.OCT.2019 08:49:50

Highest channel

LTE Band 4 part:

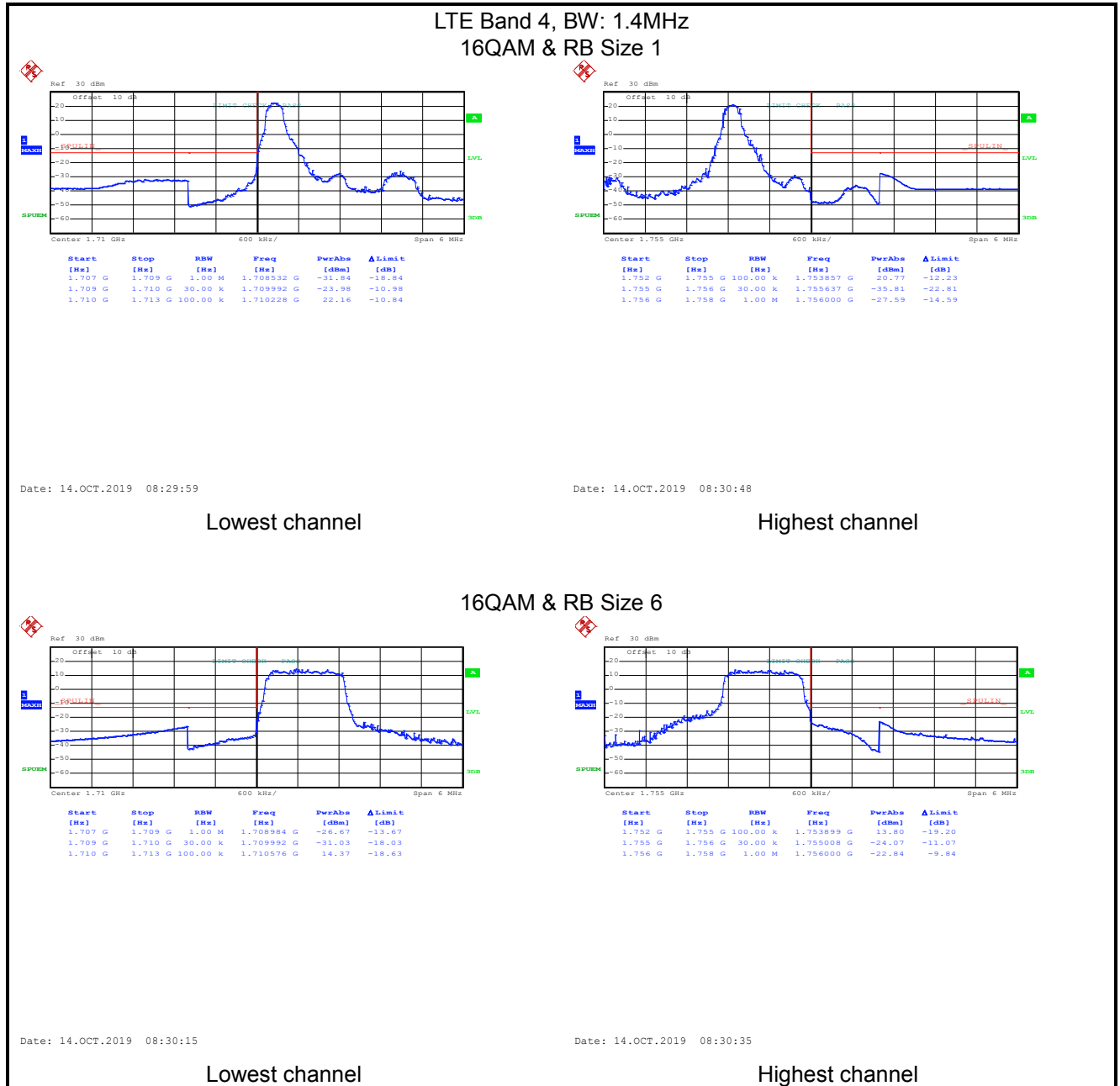

LTE Band 4, BW: 1.4MHz QPSK & RB Size 1

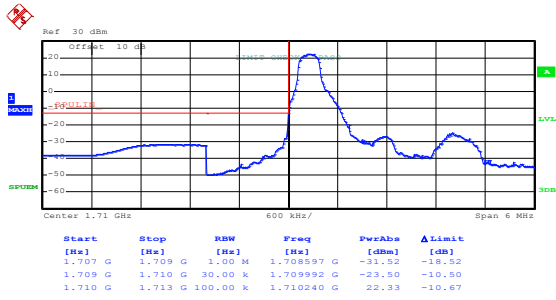

Date: 14.OCT.2019 08:29:51

Lowest channel

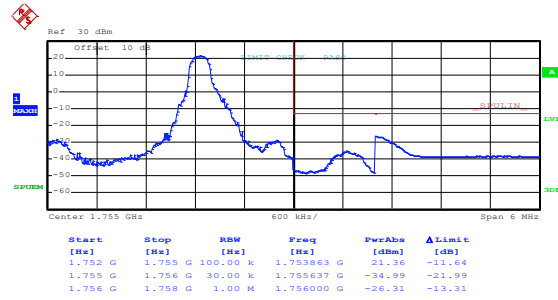

Date: 14.OCT.2019 08:30:44

Highest channel

QPSK & RB Size 6

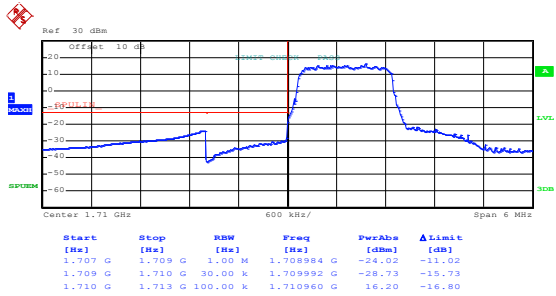

Date: 14.OCT.2019 08:30:10

Lowest channel

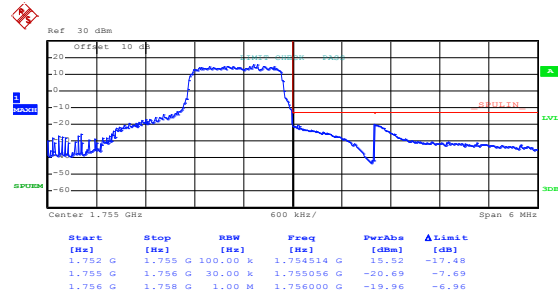

Date: 14.OCT.2019 08:30:30

Highest channel

LTE Band 4, BW: 20MHz 16QAM & RB Size 1

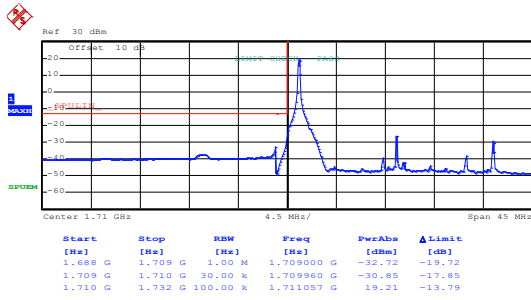

Date: 14.OCT.2019 08:32:03

Lowest channel

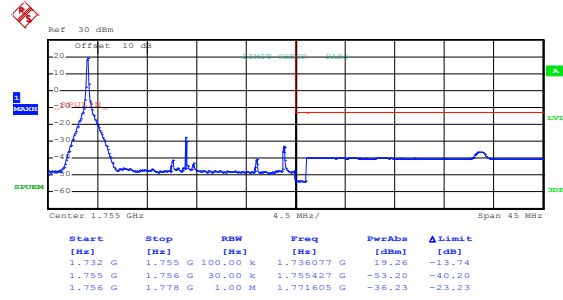

Date: 14.OCT.2019 08:31:16

Highest channel

16QAM & RB Size 100

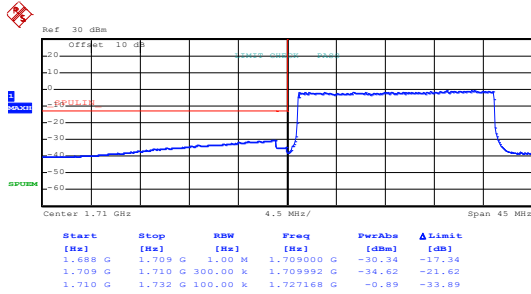

Date: 14.OCT.2019 08:32:21

Lowest channel

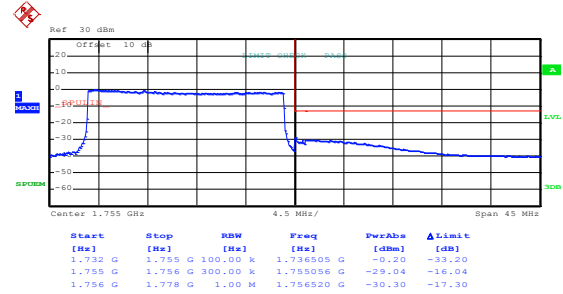

Date: 14.OCT.2019 08:31:35

Highest channel

LTE Band 4, BW: 20MHz QPSK & RB Size 1

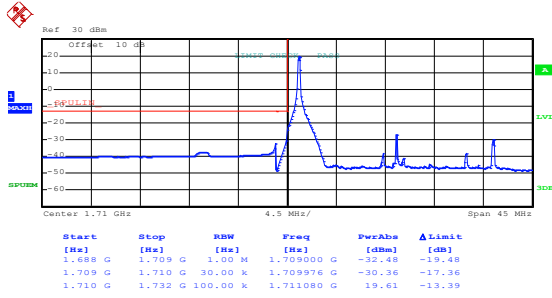

Date: 14.OCT.2019 08:31:59

Lowest channel

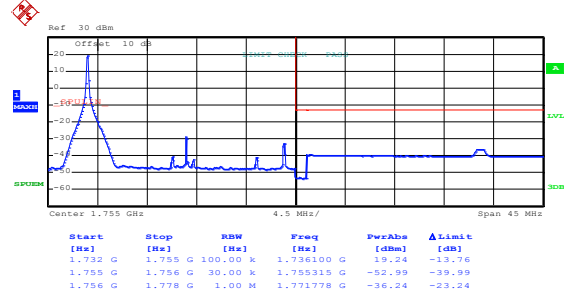

Date: 14.OCT.2019 08:31:11

Highest channel

QPSK & RB Size 100

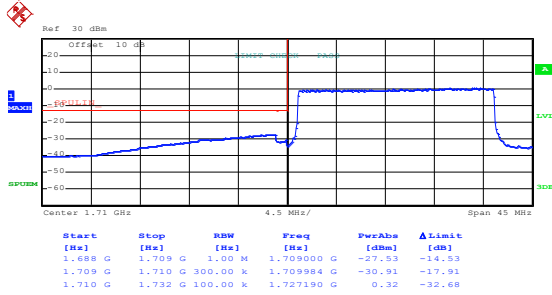

Date: 14.OCT.2019 08:32:16

Lowest channel

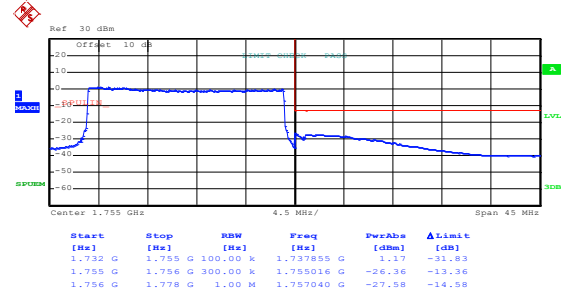

Date: 14.OCT.2019 08:31:31

Highest channel

LTE Band 17 part:

LTE Band 17, BW: 5MHz
16QAM & RB Size 1

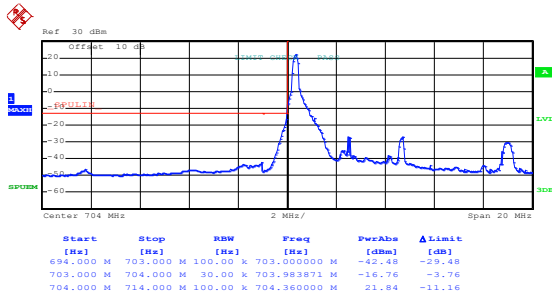

Date: 14.OCT.2019 08:43:34

Lowest channel

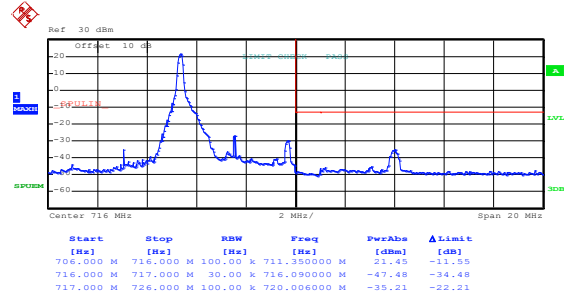

Date: 14.OCT.2019 08:43:56

Highest channel

16QAM & RB Size 25

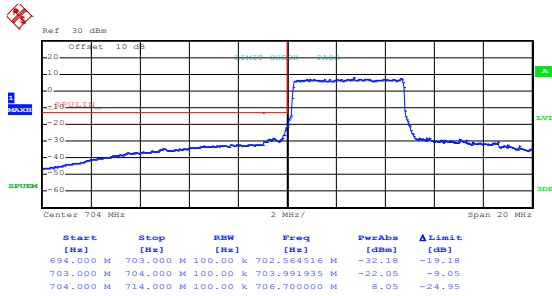

Date: 14.OCT.2019 08:43:05

Lowest channel

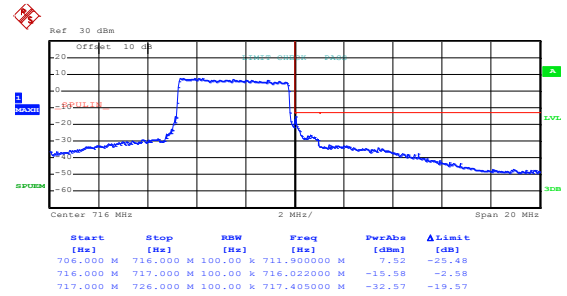

Date: 14.OCT.2019 08:44:22

Highest channel

LTE Band 17, BW: 5MHz QPSK & RB Size 1

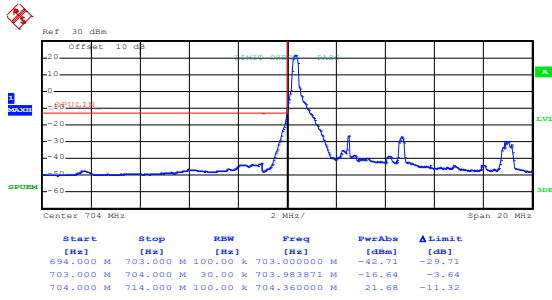

Date: 14.OCT.2019 08:43:29

Lowest channel

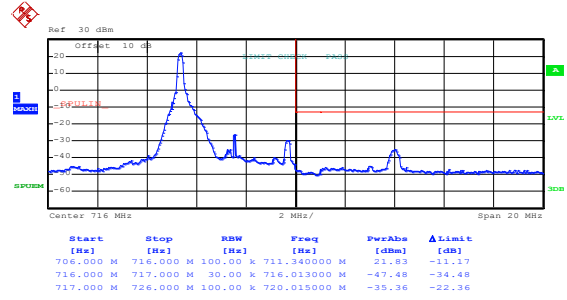

Date: 14.OCT.2019 08:43:51

Highest channel

QPSK & RB Size 25

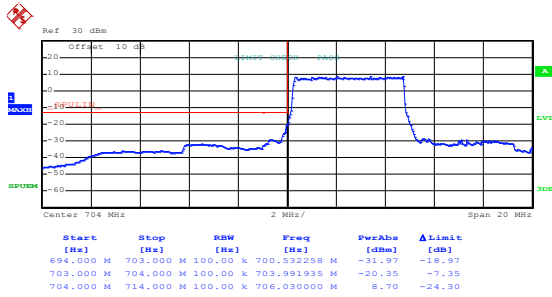

Date: 14.OCT.2019 08:42:57

Lowest channel

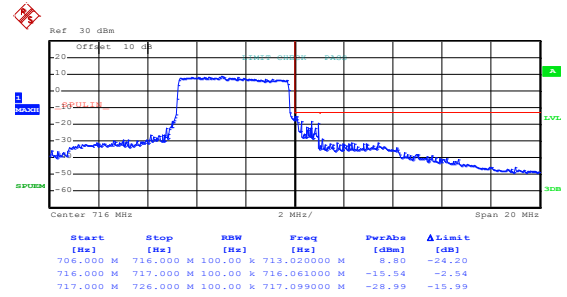

Date: 14.OCT.2019 08:44:16

Highest channel

LTE Band 17, BW: 10MHz 16QAM & RB Size 1

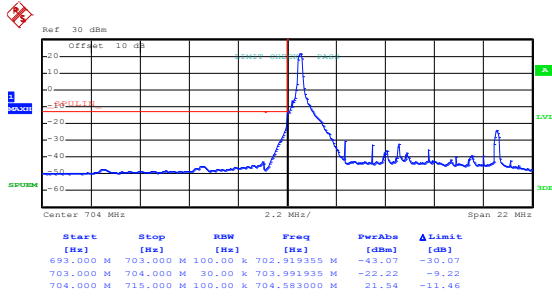

Date: 14.OCT.2019 08:46:20

Lowest channel

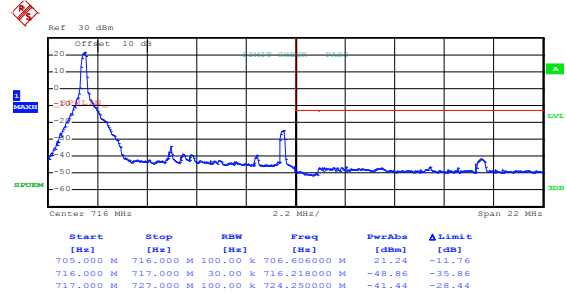

Date: 14.OCT.2019 08:45:11

Highest channel

16QAM & RB Size 50

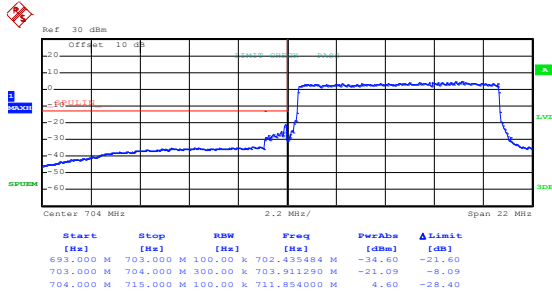

Date: 14.OCT.2019 08:46:39

Lowest channel

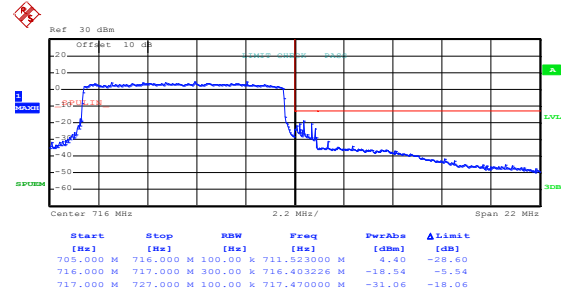

Date: 14.OCT.2019 08:45:52

Highest channel

LTE Band 17, BW: 10MHz QPSK & RB Size 1

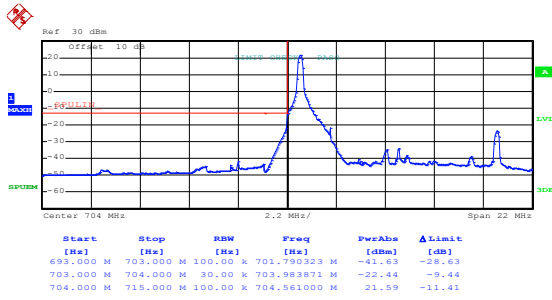

Date: 14.OCT.2019 08:46:13

Lowest channel

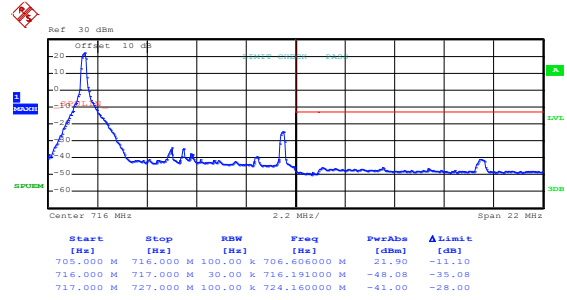

Date: 14.OCT.2019 08:45:08

Highest channel

QPSK & RB Size 50

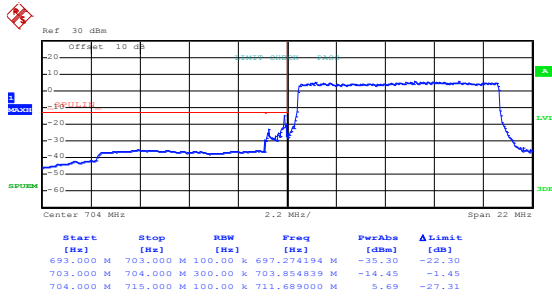

Date: 14.OCT.2019 08:46:35

Lowest channel

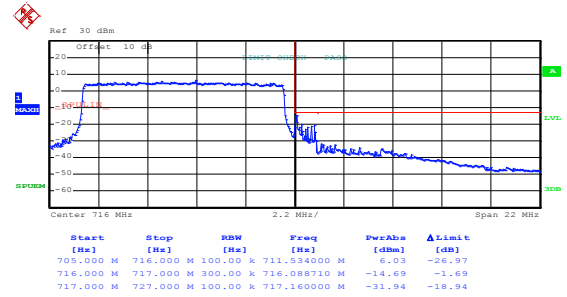

Date: 14.OCT.2019 08:45:46

Highest channel

6.5 Field strength of spurious radiation measurement

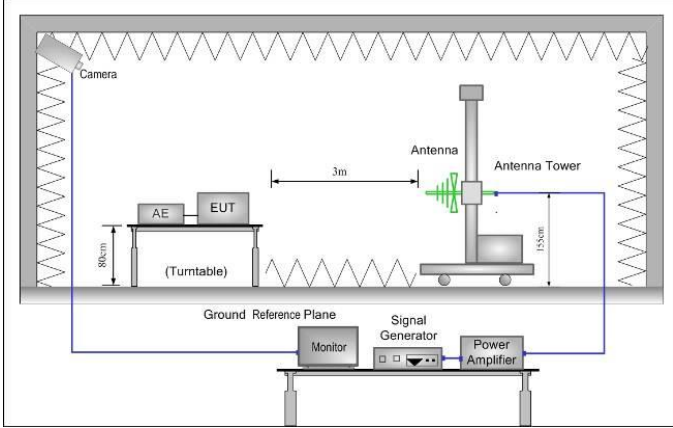
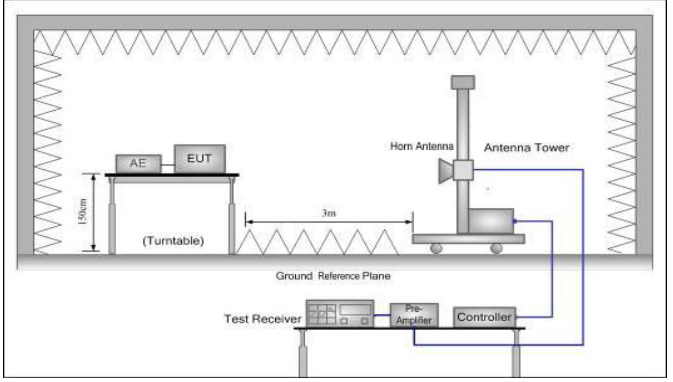
<p>Test Requirement:</p>	<p>Part 22.917(b), Part 24.238 (a), Part 27.53(g), Part 27.53(m), Part 27.53(h)</p>
<p>Limit:</p>	<p>LTE Band 2 & 4 & 17: The power of any emission outside a licensee's frequency block shall be attenuated below the transmitter power (P) in watts by at least $43 + 10 \log_{10}(P)$ dB (-13 dBm).</p>
<p>Test setup:</p>	<p>Below 1GHz</p>  <p>Above 1GHz</p> 
<p>Test Procedure:</p>	<ol style="list-style-type: none"> 1. The EUT was placed on an non-conductive turntable using a non-conductive support. The radiated emission at the fundamental frequency was measured at 3 m with a test antenna and EMI spectrum analyzer. 2. During the tests, the antenna height and the EUT azimuth were varied in order to identify the maximum level of emissions from the EUT. This maximization process was repeated with the EUT positioned in each of its three orthogonal orientations. 3. The frequency range up to tenth harmonic was investigated for each of three fundamental frequency (low, middle and high channels). Once spurious emission was identified, the power of the emission was determined using the substitution method. 4. The spurious emissions attenuation was calculated as the difference between radiated power at the fundamental frequency and the spurious emissions frequency. $ERP / EIRP = S.G. \text{ output (dBm)} + \text{Antenna Gain(dB/dBi)} - \text{Cable Loss (dB)}$
<p>Test Instruments:</p>	<p>Refer to section 5.10 for details</p>
<p>Test mode:</p>	<p>Refer to section 5.3 for details.</p>
<p>Test results:</p>	<p>Passed</p>

Measurement Data:

LTE Band 2 part:

LTE Band 2, WB: 1.4MHz				
RB size 1 & RB offset 0				
Frequency (MHz)	Spurious Emission		Limit (dBm)	Result
	Polarization	Level (dBm)		
Lowest Channel				
3701.40	Vertical	-45.98	-13.00	Pass
5552.10	V	-40.71		
7402.00	V	-22.32		
3701.40	Horizontal	-47.30		
5552.10	H	-43.48		
7402.00	H	-22.00		
Middle Channel				
3760.00	Vertical	-45.37	-13.00	Pass
5640.00	V	-40.56		
7520.00	V	-22.75		
3760.00	Horizontal	-47.75		
5640.00	H	-43.64		
7520.00	H	-22.52		
Highest Channel				
3816.60	Vertical	-45.57	-13.00	Pass
5724.90	V	-40.46		
7633.20	V	-22.27		
3816.60	Horizontal	-47.72		
5724.90	H	-43.60		
7633.20	H	-22.78		
<p>Note:</p> <ol style="list-style-type: none"> The emission levels of below 1 GHz are 20 dB lower than the limit so not show in this report. For above 1 GHz, all test modes were performed, and just the worst case shown in the report. 				

LTE Band 2, WB: 20MHz				
RB size 1 & RB offset 0				
Frequency (MHz)	Spurious Emission		Limit (dBm)	Result
	Polarization	Level (dBm)		
Lowest Channel				
3720.00	Vertical	-45.20	-13.00	Pass
5580.00	V	-40.07		
7440.00	V	-22.82		
3720.00	Horizontal	-47.08		
5580.00	H	-43.79		
7440.00	H	-22.26		
Middle Channel				
3760.00	Vertical	-45.85	-13.00	Pass
5640.00	V	-40.95		
7520.00	V	-22.64		
3760.00	Horizontal	-47.56		
5640.00	H	-43.58		
7520.00	H	-22.41		
Highest Channel				
3800.00	Vertical	-45.41	-13.00	Pass
5700.00	V	-40.88		
7600.00	V	-22.69		
3800.00	Horizontal	-47.14		
5700.00	H	-43.84		
7600.00	H	-22.16		
<p><i>Note:</i></p> <ol style="list-style-type: none"> <i>The emission levels of below 1 GHz are 20 dB lower than the limit so not show in this report.</i> <i>For above 1 GHz, all test modes were performed, and just the worst case shown in the report.</i> 				

LTE Band 4 part:

LTE Band 4, WB: 1.4MHz				
RB size 1 & RB offset 0				
Frequency (MHz)	Spurious Emission		Limit (dBm)	Result
	Polarization	Level (dBm)		
Lowest Channel				
3421.40	Vertical	-42.73	-13.00	Pass
5132.10	V	-43.77		
6842.80	V	-37.15		
3421.40	Horizontal	-45.86		
5132.10	H	-44.74		
6842.80	H	-38.04		
Middle Channel				
3465.00	Vertical	-42.34	-13.00	Pass
5197.50	V	-43.29		
6930.00	V	-37.69		
3465.00	Horizontal	-45.48		
5197.50	H	-44.19		
6930.00	H	-38.92		
Highest Channel				
3508.60	Vertical	-42.63	-13.00	Pass
5262.90	V	-43.91		
7017.20	V	-37.21		
3508.60	Horizontal	-45.32		
5262.90	H	-44.11		
7017.20	H	-38.13		
<p><i>Note:</i></p> <ol style="list-style-type: none"> <i>The emission levels of below 1 GHz are 20 dB lower than the limit so not show in this report.</i> <i>For above 1 GHz, all test modes were performed, and just the worst case shown in the report.</i> 				

LTE Band 4, WB: 20MHz				
RB size 1 & RB offset 0				
Frequency (MHz)	Spurious Emission		Limit (dBm)	Result
	Polarization	Level (dBm)		
Lowest Channel				
3440.00	Vertical	-42.29	-13.00	Pass
5160.00	V	-43.16		
6880.00	V	-37.30		
3440.00	Horizontal	-45.91		
5160.00	H	-44.68		
6880.00	H	-38.01		
Middle Channel				
3465.00	Vertical	-42.15	-13.00	Pass
5197.50	V	-43.85		
6930.00	V	-37.15		
3465.00	Horizontal	-45.51		
5197.50	H	-44.57		
6930.00	H	-38.56		
Highest Channel				
3490.00	Vertical	-42.42	-13.00	Pass
5235.00	V	-43.46		
6980.00	V	-37.45		
3490.00	Horizontal	-45.71		
5235.00	H	-44.42		
6980.00	H	-38.12		
<p><i>Note:</i></p> <ol style="list-style-type: none"> <i>The emission levels of below 1 GHz are 20 dB lower than the limit so not show in this report.</i> <i>For above 1 GHz, all test modes were performed, and just the worst case shown in the report.</i> 				

LTE Band 17 part:

LTE Band 17, WB: 5MHz				
RB size 1 & RB offset 0				
Frequency (MHz)	Spurious Emission		Limit (dBm)	Result
	Polarization	Level (dBm)		
Lowest Channel				
1413.00	Vertical	-57.56	-13.00	Pass
2119.50	V	-55.22		
2826.00	V	-53.56		
1413.00	Horizontal	-57.81		
2119.50	H	-57.51		
2826.00	H	-53.10		
Middle Channel				
1420.00	Vertical	-57.17	-13.00	Pass
2130.00	V	-55.12		
2840.00	V	-53.83		
1420.00	Horizontal	-57.41		
2130.00	H	-57.24		
2840.00	H	-53.39		
Highest Channel				
1427.00	Vertical	-57.72	-13.00	Pass
2140.50	V	-55.43		
2854.00	V	-53.96		
1427.00	Horizontal	-57.27		
2140.50	H	-57.37		
2854.00	H	-53.61		
<p>Note:</p> <ol style="list-style-type: none"> The emission levels of below 1 GHz are 20 dB lower than the limit so not show in this report. For above 1 GHz, all test modes were performed, and just the worst case shown in the report. 				

LTE Band 17, WB: 10MHz				
RB size 1 & RB offset 0				
Frequency (MHz)	Spurious Emission		Limit (dBm)	Result
	Polarization	Level (dBm)		
Lowest Channel				
1418.00	Vertical	-57.64	-13.00	Pass
2127.00	V	-55.44		
2836.00	V	-53.18		
1418.00	Horizontal	-57.84		
2127.00	H	-57.96		
2836.00	H	-53.26		
Middle Channel				
1420.00	Vertical	-57.38	-13.00	Pass
2130.00	V	-55.87		
2840.00	V	-53.75		
1420.00	Horizontal	-57.58		
2130.00	H	-57.78		
2840.00	H	-53.62		
Highest Channel				
1422.00	Vertical	-57.44	-13.00	Pass
2133.00	V	-55.67		
2844.00	V	-53.81		
1422.00	Horizontal	-57.18		
2133.00	H	-57.53		
2844.00	H	-53.36		
<p><i>Note:</i></p> <ol style="list-style-type: none"> <i>The emission levels of below 1 GHz are 20 dB lower than the limit so not show in this report.</i> <i>For above 1 GHz, all test modes were performed, and just the worst case shown in the report.</i> 				

6.6 Frequency stability V.S. Temperature measurement

Test Requirement:	Part 22.355, Part 24.235, Part 27.54, Part 2.1055(a)(1)(b)
Limit:	±2.5ppm
Test setup:	
Test procedure:	<ol style="list-style-type: none"> 1. The equipment under test was connected to an external DC power supply and input rated voltage. 2. RF output was connected to a frequency counter or spectrum analyzer via feed through attenuators. 3. The EUT was placed inside the temperature chamber. 4. Set the spectrum analyzer RBW low enough to obtain the desired frequency resolution and measure EUT 25°C operating frequency as reference frequency. 5. Turn EUT off and set the chamber temperature to -30°C. After the temperature stabilized for approximately 30 minutes recorded the frequency. 6. Repeat step measure with 10°C increased per stage until the highest temperature of +50°C reached
Test Instruments:	Refer to section 5.10 for details
Test mode:	Refer to section 5.3 for details
Test results:	Passed

Measurement Data (worst case):

LTE Band 2 part:

Reference Frequency: LTE Band 2 (10MHz) Middle channel=18900 channel=1880.00MHz					
Power supplied (Vdc)	Temperature (°C)	Frequency error		Limit (ppm)	Result
		Hz	ppm		
QPSK					
3.80	-30	199	0.105851	±2.5	Pass
	-20	181	0.096277		
	-10	165	0.087766		
	0	177	0.094149		
	10	123	0.065426		
	20	135	0.071809		
	30	144	0.076596		
	40	150	0.079787		
	50	107	0.056915		
16QAM					
3.80	-30	196	0.104255	±2.5	Pass
	-20	165	0.087766		
	-10	132	0.070213		
	0	121	0.064362		
	10	141	0.075000		
	20	102	0.054255		
	30	174	0.092553		
	40	180	0.095745		
	50	129	0.068617		
<i>Note: Only the worst case shown in the report.</i>					

LTE Band 4 part:

Reference Frequency: LTE Band 4 (10MHz) Middle channel=20175 channel=1732.50MHz					
Power supplied (Vdc)	Temperature (°C)	Frequency error		Limit (ppm)	Result
		Hz	ppm		
QPSK					
3.80	-30	198	0.114286	±2.5	Pass
	-20	151	0.087157		
	-10	165	0.095238		
	0	184	0.106205		
	10	174	0.100433		
	20	123	0.070996		
	30	138	0.079654		
	40	115	0.066378		
	50	106	0.061183		
16QAM					
3.80	-30	196	0.113131	±2.5	Pass
	-20	131	0.075613		
	-10	118	0.068110		
	0	181	0.104473		
	10	174	0.100433		
	20	165	0.095238		
	30	149	0.086003		
	40	102	0.058874		
	50	126	0.072727		
<i>Note: Only the worst case shown in the report.</i>					

LTE Band 17 part:

Reference Frequency: LTE Band 17 (10MHz) Middle channel=23790 channel=710.00MHz					
Power supplied (Vdc)	Temperature (°C)	Frequency error		Limit (ppm)	Result
		Hz	ppm		
QPSK					
3.80	-30	196	0.276056	±2.5	Pass
	-20	165	0.232394		
	-10	184	0.259155		
	0	123	0.173239		
	10	134	0.188732		
	20	170	0.239437		
	30	116	0.163380		
	40	108	0.152113		
	50	146	0.205634		
16QAM					
3.80	-30	196	0.276056	±2.5	Pass
	-20	161	0.226761		
	-10	132	0.185915		
	0	151	0.212676		
	10	184	0.259155		
	20	170	0.239437		
	30	123	0.173239		
	40	105	0.147887		
	50	118	0.166197		
<i>Note: Only the worst case shown in the report.</i>					

6.7 Frequency stability V.S. Voltage measurement

Test Requirement:	Part 22.355, Part 24.235, Part 27.54, Part 2.1055(d)(2)
Limit:	±2.5ppm
Test setup:	
Test procedure:	<ol style="list-style-type: none"> 1. Set chamber temperature to 25°C. Use a variable DC power source to power the EUT and set the voltage to rated voltage. 2. Set the spectrum analyzer RBW low enough to obtain the desired frequency resolution and recorded the frequency. 3. Reduce the input voltage to specify extreme voltage variation (+/- 15%) and endpoint, record the maximum frequency change.
Test Instruments:	Refer to section 5.10 for details
Test mode:	Refer to section 5.3 for details
Test results:	Passed

Measurement Data (worst case):

LTE Band 2 part:

Reference Frequency: LTE Band 2(10MHz) Middle channel=18900 channel=1880.00MHz					
Temperature (°C)	Power supplied (Vdc)	Frequency error		Limit (ppm)	Result
		Hz	ppm		
QPSK					
25	4.35	96	0.051064	±2.5	Pass
	3.80	84	0.044681		
	3.50	74	0.039362		
16QAM					
25	4.35	90	0.047872	±2.5	Pass
	3.80	87	0.046277		
	3.50	48	0.025532		

Note: Only the worst case shown in the report.

LTE Band 4 part:

Reference Frequency: LTE Band 4(10MHz) Middle channel=20175 channel=1732.50MHz					
Temperature (°C)	Power supplied (Vdc)	Frequency error		Limit (ppm)	Result
		Hz	ppm		
QPSK					
25	4.35	99	0.057143	±2.5	Pass
	3.80	84	0.048485		
	3.50	65	0.037518		
16QAM					
25	4.35	88	0.050794	±2.5	Pass
	3.80	90	0.051948		
	3.50	67	0.038672		

Note: Only the worst case shown in the report.

LTE Band 17 part:

Reference Frequency: LTE Band 17(10MHz) Middle channel=23790 channel=710.00MHz					
Temperature (°C)	Power supplied (Vdc)	Frequency error		Limit (ppm)	Result
		Hz	ppm		
QPSK					
25	4.35	97	0.136620	±2.5	Pass
	3.80	84	0.118310		
	3.50	76	0.107042		
16QAM					
25	4.35	80	0.112676	±2.5	Pass
	3.80	74	0.104225		
	3.50	45	0.063380		

Note: Only the worst case shown in the report.