

FCC REPORT (LTE)

Applicant: PCD, LLC

Address of Applicant: 1500 Tradeport Drive, Orlando, Florida, 32824. United States

Equipment Under Test (EUT)

Product Name: Monkey II LTE

Model No.: PL504

Trade mark: PCD

FCC ID: 2ALJJPL504

Applicable standards: FCC CFR Title 47 Part 2
FCC CFR Title 47 Part 24 Subpart E
FCC CFR Title 47 Part 27 Subpart L
FCC CFR Title 47 Part 27 Subpart M

Date of sample receipt: 01 Mar., 2019

Date of Test: 01 Mar., to 13 Mar., 2019

Date of report issued: 13 Mar., 2019

Test Result: PASS*

*In the configuration tested, the EUT complied with the standards specified above.

Authorized Signature:



Bruce Zhang
Laboratory Manager

This report details the results of the testing carried out on one sample. The results contained in this test report do not relate to other samples of the same product and does not permit the use of the CCIS product certification mark. The manufacturer should ensure that all products in series production are in conformity with the product sample detailed in this report.

This report may only be reproduced and distributed in full. If the product in this report is used in any configuration other than that detailed in the report, the manufacturer must ensure the new system complies with all relevant standards.

This document cannot be reproduced except in full, without prior written approval of the Company. Any unauthorized alteration, forgery or falsification of the content or appearance of this document is unlawful, and offenders may be prosecuted to the fullest extent of the law. Unless otherwise stated the results shown in this test report refer only to the sample(s) tested and such sample(s) are retained for 90 days only.

2. Version

Version No.	Date	Description
00	13 Mar., 2019	Original

Tested by: Mike.ou **Date:** 13 Mar., 2019
Test Engineer

Reviewed by: Wimer Zhang **Date:** 13 Mar., 2019
Project Engineer

3. Contents

	Page
1. COVER PAGE	1
2. VERSION	2
3. CONTENTS	3
4. TEST SUMMARY	4
5. GENERAL INFORMATION	5
5.1 CLIENT INFORMATION.....	5
5.2 GENERAL DESCRIPTION OF E.U.T.....	5
5.3 TEST ENVIRONMENT AND MODE	10
5.4 DESCRIPTION OF SUPPORT UNITS.....	10
5.5 MEASUREMENT UNCERTAINTY.....	10
5.6 RELATED SUBMITTAL(S) / GRANT (S).....	10
5.7 LABORATORY FACILITY.....	10
5.8 LABORATORY LOCATION	10
5.9 TEST INSTRUMENTS LIST.....	11
6. TEST RESULTS	12
6.1 CONDUCTED OUTPUT POWER, ERP AND EIRP	12
6.2 PEAK-TO-AVERAGE RATIO.....	21
6.3 OCCUPY BANDWIDTH.....	24
6.4 OUT OF BAND EMISSION AT ANTENNA TERMINALS	60
6.5 FIELD STRENGTH OF SPURIOUS RADIATION MEASUREMENT.....	157
6.6 FREQUENCY STABILITY V.S. TEMPERATURE MEASUREMENT.....	174
6.7 FREQUENCY STABILITY V.S. VOLTAGE MEASUREMENT	178
7 TEST SETUP PHOTO	180
8 EUT CONSTRUCTIONAL DETAILS	181

4. Test Summary

Test Items	Section in CFR 47	Result
RF Exposure (SAR)	Part 1.1307 Part 2.1093	Passed (Please refer to SAR Report)
RF Output Power	Part 2.1046 Part 24.232 (c) Part 27.50 (d)(4) Part 27.50 (h)(2)	Pass
Peak-to-Average Ratio	Part 24.232 (d) Part 27.50(d)(5)	Pass
Modulation Characteristics	Part 2.1047	Pass
99% & -26 dB Occupied Bandwidth	Part 2.1049 Part 24.238(b) Part 27.53(h) Part 27.53(m)	Pass
Out of band emission at antenna terminals	Part 2.1053 Part 24.238 (a) Part 27.53 (h) Part 27.53(m)	Pass
Field strength of spurious radiation	Part 24.238 (a) Part 27.53 (h) Part 27.53(m)	Pass
Frequency stability vs. temperature	Part 24.235 Part 27.54 Part 2.1055(a)(1)(b)	Pass
Frequency stability vs. voltage	Part 24.235 Part 27.54 Part 2.1055(d)(2)	Pass

Pass: The EUT complies with the essential requirements in the standard.

5. General Information

5.1 Client Information

Applicant:	PCD, LLC
Address:	1500 Tradeport Drive, Orlando, Florida, 32824. United States
Manufacturer:	PCD,LLC
Address:	1500 Tradeport Drive, Orlando, Florida, 32824. United States

5.2 General Description of E.U.T.

Product Name:	Monkey II LTE
Model No.:	PL504
Operation Frequency range:	LTE Band 2: TX: 1850MHz-1910MHz, RX: 1930MHz-1990MHz LTE Band 4: TX: 1710MHz-1755MHz, RX: 2110MHz-2155MHz LTE Band 7: TX: 2500MHz-2570MHz, RX: 2620MHz-2690MHz
Modulation type:	QPSK, 16QAM
Antenna type:	Internal Antenna
Antenna gain:	LTE Band 2: -0.13 dBi LTE Band 4: -0.26 dBi LTE Band 7: -0.72 dBi
Power supply:	Rechargeable Li-ion Battery DC3.8V-2000mAh
AC adapter:	Model: PL504 Input: AC100-240V, 50/60Hz, 0.1A Output: DC 5.0V, 700mA
Test Sample Condition:	The applicant provided engineering samples for staying in continuously transmitting for testing.

Operation Frequency List:

LTE Band 2 (1.4MHz)		LTE Band 2 (3MHz)	
Channel	Frequency (MHz)	Channel	Frequency (MHz)
18607	1850.70	18615	1851.50
18608	1850.80	18616	1851.60
....
18899	1879.90	18899	1879.90
18900	1880.00	18900	1880.00
18901	1880.10	18901	1880.10
...
19193	1909.20	19185	1908.40
19194	1909.30	19186	1908.50
LTE Band 2 (5MHz)		LTE Band 2 (10MHz)	
Channel	Frequency (MHz)	Channel	Frequency (MHz)
18625	1852.50	18650	1855.00
18626	1852.60	18651	1855.10
....
18899	1879.90	18899	1879.90
18900	1880.00	18900	1880.00
18901	1880.10	18901	1880.10
...
19175	1907.40	19150	1904.90
19176	1907.50	19151	1905.00
LTE Band 2 (15MHz)		LTE Band 2 (20MHz)	
Channel	Frequency (MHz)	Channel	Frequency (MHz)
18675	1857.50	18700	1860.00
18676	1857.60	18701	1860.10
....
18899	1879.90	18899	1879.90
18900	1880.00	18900	1880.00
18901	1880.10	18901	1880.10
...
19125	1902.40	19100	1899.90
19126	1902.50	19101	1900.00

LTE Band 4 (1.4MHz)		LTE Band 4 (3MHz)	
Channel	Frequency (MHz)	Channel	Frequency (MHz)
19957	1710.70	19965	1711.50
19958	1710.80	19966	1711.60
....
20174	1732.40	20174	1732.40
20175	1732.50	20175	1732.50
20176	1732.60	20176	1732.60
...
20392	1754.20	20384	1753.40
20393	1754.30	20385	1753.50
LTE Band 4 (5MHz)		LTE Band 4 (10MHz)	
Channel	Frequency (MHz)	Channel	Frequency (MHz)
19975	1712.50	20000	1715.00
19976	1712.60	20001	1715.10
....
20174	1732.40	20174	1732.40
20175	1732.50	20175	1732.50
20176	1732.60	20176	1732.60
...
20374	1752.40	20349	1749.90
20375	1752.50	20350	1750.00
LTE Band 4 (15MHz)		LTE Band 4 (20MHz)	
Channel	Frequency (MHz)	Channel	Frequency (MHz)
20025	1717.50	20050	1720.00
20026	1717.60	20051	1720.10
....
20174	1732.40	20174	1732.40
20175	1732.50	20175	1732.50
20176	1732.60	20176	1732.60
...
20324	1747.40	20299	1744.90
20325	1747.50	20300	1745.00

LTE Band 7 (5MHz)		LTE Band 7 (10MHz)	
Channel	Frequency (MHz)	Channel	Frequency (MHz)
20775	2502.50	20800	2505.00
20776	2502.60	20801	2502.10
....
21099	2534.90	21099	2534.90
21100	2535.00	21100	2535.00
21101	2535.20	21101	2535.20
...
21424	2567.40	21399	2564.90
21425	2567.50	21400	2565.00
LTE Band 7 (15MHz)		LTE Band 7 (20MHz)	
Channel	Frequency (MHz)	Channel	Frequency (MHz)
20825	2507.50	20850	2510.00
20826	2507.60	20851	2510.10
....
21099	2534.90	21099	2534.90
21100	2535.00	21100	2535.00
21101	2535.20	21101	2535.20
...
21374	2562.40	21349	2559.90
21375	2562.50	21350	2560.00

Regards to the operating frequency range, the lowest frequency, the middle frequency, and the highest frequency of channel were selected to perform the test, and the selected channels as below:

LTE Band 2 (1.4MHz)			LTE Band 2 (3MHz)		
Channel		Frequency (MHz)	Channel		Frequency (MHz)
Lowest channel	18607	1850.70	Lowest channel	18615	1851.50
Middle channel	18900	1880.00	Middle channel	18900	1880.00
Highest channel	19193	1909.30	Highest channel	19185	1908.50
LTE Band 2 (5MHz)			LTE Band 2 (10MHz)		
Channel		Frequency (MHz)	Channel		Frequency (MHz)
Lowest channel	18625	1852.50	Lowest channel	18650	1855.00
Middle channel	18900	1880.00	Middle channel	18900	1880.00
Highest channel	19175	1907.50	Highest channel	19150	1905.00
LTE Band 2 (15MHz)			LTE Band 2 (20MHz)		
Channel		Frequency (MHz)	Channel		Frequency (MHz)
Lowest channel	18675	1857.50	Lowest channel	18700	1860.00
Middle channel	18900	1880.00	Middle channel	18900	1880.00
Highest channel	19125	1902.50	Highest channel	19100	1900.00

LTE Band 4 (1.4MHz)			LTE Band 4 (3MHz)		
Channel:		Frequency (MHz)	Channel		Frequency (MHz)
Lowest channel	19957	1710.70	Lowest channel	19965	1711.50
Middle channel	20175	1732.50	Middle channel	20175	1732.50
Highest channel	20393	1754.30	Highest channel	20385	1753.50
LTE Band 4 (5MHz)			LTE Band 4 (10MHz)		
Channel		Frequency (MHz)	Channel		Frequency (MHz)
Lowest channel	19975	1712.50	Lowest channel	20000	1715.00
Middle channel	20175	1732.50	Middle channel	20175	1732.50
Highest channel	20375	1752.50	Highest channel	20350	1750.00
LTE Band 4 (15MHz)			LTE Band 4 (20MHz)		
Channel		Frequency (MHz)	Channel		Frequency (MHz)
Lowest channel	20025	1717.50	Lowest channel	20050	1720.00
Middle channel	20175	1732.50	Middle channel	20175	1732.50
Highest channel	20325	1747.50	Highest channel	20300	1745.00

LTE Band 7 (5MHz)			LTE Band 7 (10MHz)		
Channel		Frequency (MHz)	Channel		Frequency (MHz)
Lowest channel	20775	2502.50	Lowest channel	20800	2505.00
Middle channel	21100	2535.00	Middle channel	21100	2535.00
Highest channel	21425	2567.50	Highest channel	21400	2565.00
LTE Band 7 (15MHz)			LTE Band 7 (20MHz)		
Channel		Frequency (MHz)	Channel		Frequency (MHz)
Lowest channel	20825	2507.50	Lowest channel	20850	2510.00
Middle channel	21100	2535.00	Middle channel	21100	2535.00
Highest channel	21375	2562.50	Highest channel	21350	2560.00

5.3 Test environment and mode

Operating Environment:	
Temperature:	Normal: 15°C ~ 35°C, Extreme: -30°C ~ +50°C
Humidity:	20 % ~ 75 % RH
Atmospheric Pressure:	1008 mbar
Voltage:	Nominal: 3.8Vdc, Extreme: Low 3.5Vdc, High 4.35Vdc
Test mode:	
LTE QPSK mode	Keep the EUT communication with simulated station in QPSK mode
LTE 16-QAM mode	Keep the EUT communication with simulated station in 16-QAM mode
Remark: The EUT has been tested under continuous transmitting mode. Channel Low, Mid and High for each type band with rated data rate were chosen for full testing. The field strength of spurious radiation emission was measured as EUT stand-up position (H mode) and lie down position (E1, E2 mode) for these modes with power adaptor, earphone and Data cable. Just the worst case position (H mode) shown in report.	

5.4 Description of Support Units

Test Equipment	Manufacturer	Model No.	Serial No.
Simulated Station	Anritsu	MT8820C	6201026545

5.5 Measurement Uncertainty

Parameters	Expanded Uncertainty
Radiated Emission (9kHz ~ 30MHz)	±2.76 dB (k=2)
Radiated Emission (30MHz ~ 1000MHz)	±4.28 dB (k=2)
Radiated Emission (1GHz ~ 18GHz)	±5.72 dB (k=2)
Radiated Emission (18GHz ~ 40GHz)	±2.88 dB (k=2)

5.6 Related Submittal(s) / Grant (s)

This is an original grant, no related submittals and grants.
--

5.7 Laboratory Facility

<p>The test facility is recognized, certified, or accredited by the following organizations:</p> <ul style="list-style-type: none"> ● FCC - Registration No.: 727551 Shenzhen Zhongjian Nanfang Testing Co., Ltd. has been accredited as a testing laboratory by FCC (Federal Communications Commission). The Registration No. is 727551. ● IC - Registration No.: 10106A-1 The 3m Semi-anechoic chamber of Shenzhen Zhongjian Nanfang Testing Co., Ltd. has been Registered by Certification and Engineering Bureau of Industry Canada for radio equipment testing with Registration No.: 10106A-1. ● CNAS - Registration No.: CNAS L6048 Shenzhen Zhongjian Nanfang Testing Co., Ltd. is accredited to ISO/IEC 17025:2005 General Requirements for the Competence of Testing and Calibration laboratories for the competence of testing. The Registration No. is CNAS L6048. ● A2LA - Registration No.: 4346.01 This laboratory is accredited in accordance with the recognized International Standard ISO/IEC 17025:2005 General requirements for the competence of testing and calibration laboratories. The test scope can be found as below link: https://portal.a2la.org/scopepdf/4346-01.pdf

5.8 Laboratory Location

<p>Shenzhen Zhongjian Nanfang Testing Co., Ltd. Address: No. B-C, 1/F., Building 2, Laodong No.2 Industrial Park, Xixiang Road, Bao'an District, Shenzhen, Guangdong, China Tel: +86-755-23118282, Fax: +86-755-23116366 Email: info@ccis-cb.com, Website: http://www.ccis-cb.com</p>

5.9 Test Instruments list

Test Equipment	Manufacturer	Model No.	Serial No.	Cal. Date (mm-dd-yy)	Cal. Due date (mm-dd-yy)
3m SAC	SAEMC	9m*6m*6m	966	07-22-2017	07-21-2020
BiConiLog Antenna	SCHWARZBECK	VULB9163	497	03-16-2018	03-15-2019
Biconical Antenna	SCHWARZBECK	VUBA9117	359	06-22-2017	06-21-2020
Horn Antenna	SCHWARZBECK	BBHA9120D	916	03-16-2018	03-15-2019
Horn Antenna	SCHWARZBECK	BBHA9120D	1805	06-22-2017	06-21-2020
Horn Antenna	SCHWARZBECK	BBHA 9170	BBHA9170582	11-21-2018	11-20-2019
EMI Test Software	AUDIX	E3	Version: 6.110919b		
Pre-amplifier	HP	8447D	2944A09358	03-07-2018	03-06-2019
				03-07-2019	03-06-2020
Pre-amplifier	CD	PAP-1G18	11804	03-07-2018	03-06-2019
				03-07-2019	03-06-2020
Spectrum analyzer	Rohde & Schwarz	FSP30	101454	03-07-2018	03-06-2019
				03-07-2019	03-06-2020
EMI Test Receiver	Rohde & Schwarz	ESRP7	101070	03-07-2018	03-06-2019
				03-07-2019	03-06-2020
Spectrum Analyzer	Agilent	N9020A	MY50510123	10-29-2018	10-28-2019
Signal Generator	Rohde & Schwarz	SMX	835454/016	03-07-2018	03-06-2019
				03-07-2019	03-06-2020
Signal Generator	R&S	SMR20	1008100050	03-07-2018	03-06-2019
				03-07-2019	03-06-2020
RF Switch Unit	MWRFTTEST	MW200	N/A	N/A	N/A
Test Software	MWRFTTEST	MTS8200	Version: 2.0.0.0		
Cable	ZDECL	Z108-NJ-NJ-81	1608458	03-07-2018	03-06-2019
				03-07-2019	03-06-2020
Cable	MICRO-COAX	MFR64639	K10742-5	03-07-2018	03-06-2019
				03-07-2019	03-06-2020
Cable	SUHNER	SUCOFLEX100	58193/4PE	03-07-2018	03-06-2019
				03-07-2019	03-06-2020
DC Power Supply	XinNuoEr	WYK-10020K	1409050110020	10-31-2018	10-30-2019
Temperature Humidity Chamber	HengPu	HPGDS-500	20140828008	09-24-2018	09-23-2019
Simulated Station	Rohde & Schwarz	CMW500	140493	07-16-2018	07-15-2019

6. Test results

6.1 Conducted Output Power, ERP and EIRP

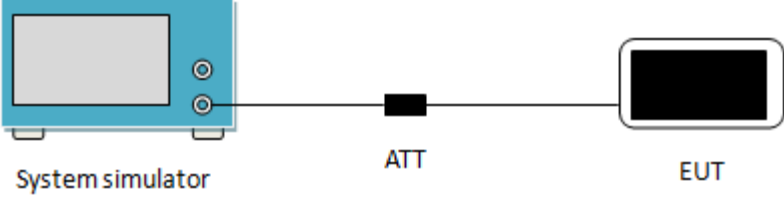
Test Requirement:	Part 24.232(c), Part 27.50(d)(4), Part 27.50 (h)(2)
Test Method:	ANSI/TIA-603-D 2010
Limit:	LTE Band 2: 2W, LTE Band 4: 1W, LTE Band 7: 2W,
Test Setup:	 <p>The diagram illustrates the test setup. On the left is a blue 'System simulator' with a screen and two ports. A line connects it to a black 'ATT' (attenuator) block. Another line connects the 'ATT' to a black 'EUT' (Equipment Under Test) device.</p>
Test Procedure:	The transmitter output was connected to a calibrated attenuator, the other end of which was connected to the CMW500. Transmitter output power was read off in dBm.
Test Instruments:	Refer to section 5.9 for details
Test mode:	Refer to section 5.3 for details
Test results:	Passed

Measurement Data:

LTE Band	Bandwidth (MHz)	Modulation	RB Size	RB Offset	Average Power (dBm)				
					18607	18900	19193		
					1850.7MHz	1880.0MHz	1909.3MHz		
2	1.4	QPSK	1	0	22.56	22.57	22.57		
			1	2	22.64	22.61	22.61		
			1	5	22.48	22.54	22.59		
			3	0	22.74	22.78	22.62		
			3	1	22.34	22.38	22.32		
			3	2	22.30	22.48	22.47		
			6	0	22.25	22.35	22.41		
		Antenna Gain (dBi):					-0.13		
		Max. EIRP (dBm):					22.65		
		EIRP Limit (dBm):					33.00		
		16QAM	1	0	22.38	21.77	22.50		
			1	2	22.29	22.05	22.33		
			1	5	22.14	22.16	22.59		
			3	0	22.42	22.31	22.19		
			3	1	22.55	22.28	22.48		
			3	2	22.48	22.13	22.44		
			6	0	21.21	21.44	21.30		
		Antenna Gain (dBi):					-0.13		
		Max. EIRP (dBm):					22.46		
		EIRP Limit (dBm):					33.00		
		LTE Band	Bandwidth (MHz)	Modulation	RB Size	RB Offset	Average Power (dBm)		
18615	18900						19185		
1851.5MHz	1880.0MHz						1908.5MHz		
2	3	QPSK	1	0	22.51	22.51	22.45		
			1	7	22.53	22.67	22.61		
			1	14	22.49	22.45	22.54		
			8	0	22.23	22.08	22.65		
			8	4	22.17	22.24	22.60		
			8	7	22.11	22.19	22.64		
			15	0	22.12	22.20	22.12		
		Antenna Gain (dBi):					-0.13		
		Max. EIRP (dBm):					22.54		
		EIRP Limit (dBm):					33.00		
		16QAM	1	0	22.15	22.31	22.17		
			1	7	22.24	22.54	22.32		
			1	14	22.54	22.06	22.05		
			8	0	21.33	21.43	21.32		
			8	4	21.48	21.66	21.25		
			8	7	21.53	21.37	21.19		
			15	0	21.31	21.35	21.43		
		Antenna Gain (dBi):					-0.13		
		Max. EIRP (dBm):					22.41		
		EIRP Limit (dBm):					33.00		

Note: EIRP (dBm) = Average power (dBm) + Antenna Gain (dBi).

LTE Band	Bandwidth (MHz)	Modulation	RB Size	RB Offset	Average Power (dBm)				
					18625	18900	19175		
					1852.5MHz	1880.0MHz	1907.5MHz		
2	5	QPSK	1	0	22.49	22.50	22.80		
			1	12	22.61	22.52	22.85		
			1	24	22.61	22.48	22.76		
			12	0	22.21	22.21	22.41		
			12	6	22.14	22.25	22.50		
			12	11	22.20	22.09	22.43		
			25	0	22.23	22.11	22.40		
		Antenna Gain (dBi):					-0.13		
		Max. EIRP (dBm):					22.72		
		EIRP Limit (dBm):					33.00		
		16QAM	1	0	22.66	22.45	22.71		
			1	12	22.70	22.48	22.68		
			1	24	22.58	22.32	22.43		
			12	0	21.50	21.35	21.54		
			12	6	21.58	21.28	21.40		
			12	11	21.74	21.35	21.38		
			25	0	21.60	21.37	21.47		
		Antenna Gain (dBi):					-0.13		
		Max. EIRP (dBm):					22.58		
		EIRP Limit (dBm):					33.00		

LTE Band	Bandwidth (MHz)	Modulation	RB Size	RB Offset	Average Power (dBm)				
					18650	18900	19150		
					1855.0MHz	1880.0MHz	1905.0MHz		
2	10	QPSK	1	0	22.72	22.77	22.90		
			1	24	22.81	22.65	22.86		
			1	49	22.67	22.57	22.78		
			25	0	22.44	22.26	22.25		
			25	12	22.38	22.36	22.27		
			25	24	22.24	22.28	22.43		
			50	0	22.40	22.37	22.42		
		Antenna Gain (dBi):					-0.13		
		Max. EIRP (dBm):					22.97		
		EIRP Limit (dBm):					33.00		
		16QAM	1	0	22.51	22.44	22.50		
			1	24	22.73	22.39	22.81		
			1	49	22.60	22.17	22.66		
			25	0	21.53	21.52	21.45		
			25	12	21.70	21.43	21.57		
			25	24	21.32	21.48	21.64		
			50	0	21.48	21.52	21.47		
		Antenna Gain (dBi):					-0.13		
		Max. EIRP (dBm):					22.68		
		EIRP Limit (dBm):					33.00		

Note: EIRP (dBm) = Average power (dBm) + Antenna Gain (dBi).

LTE Band	Bandwidth (MHz)	Modulation	RB Size	RB Offset	Average Power (dBm)				
					18675	18900	19125		
					1857.5MHz	1880.0MHz	1902.5MHz		
2	15	QPSK	1	0	22.68	22.54	22.71		
			1	37	22.78	22.45	22.77		
			1	74	22.64	22.52	22.70		
			36	0	22.32	22.20	22.32		
			36	16	22.34	22.29	22.46		
			36	35	22.27	22.30	22.45		
			75	0	22.24	22.31	22.33		
		Antenna Gain (dBi):					-0.13		
		Max. EIRP (dBm):					22.65		
		EIRP Limit (dBm):					33.00		
		16QAM	1	0	22.32	22.59	22.11		
			1	37	22.25	22.57	22.03		
			1	74	22.57	22.18	22.68		
			36	0	21.33	21.45	21.50		
			36	16	21.42	21.52	21.44		
			36	35	21.43	21.38	21.47		
			75	0	21.39	21.36	21.37		
		Antenna Gain (dBi):					-0.13		
		Max. EIRP (dBm):					22.55		
		EIRP Limit (dBm):					33.00		
		LTE Band	Bandwidth (MHz)	Modulation	RB Size	RB Offset	Average Power (dBm)		
18700	18900						19100		
1860.0MHz	1880.0MHz						1900.0MHz		
2	20	QPSK	1	0	22.62	22.59	22.57		
			1	49	22.73	22.70	22.80		
			1	99	22.52	22.65	22.66		
			50	0	22.36	22.36	22.54		
			50	24	22.31	22.17	22.36		
			50	49	22.30	22.20	22.21		
			100	0	22.16	22.27	22.44		
		Antenna Gain (dBi):					-0.13		
		Max. EIRP (dBm):					22.67		
		EIRP Limit (dBm):					33.00		
		16QAM	1	0	21.98	21.70	21.95		
			1	49	22.16	21.75	21.80		
			1	99	22.10	21.83	21.97		
			50	0	21.34	21.49	21.43		
			50	24	21.25	21.35	21.45		
			50	49	21.36	21.31	21.32		
			100	0	21.39	21.37	21.50		
		Antenna Gain (dBi):					-0.13		
		Max. EIRP (dBm):					22.03		
		EIRP Limit (dBm):					33.00		
		Note: EIRP (dBm) = Average power (dBm) + Antenna Gain (dBi).							

LTE Band	Bandwidth (MHz)	Modulation	RB Size	RB Offset	Average Power (dBm)				
					19957	20175	20393		
					1710.7MHz	1732.5MHz	1754.3MHz		
4	1.4	QPSK	1	0	22.41	22.42	22.39		
			1	2	22.54	22.55	22.53		
			1	5	22.46	22.37	22.43		
			3	0	22.35	22.34	22.37		
			3	1	22.27	22.35	22.41		
			3	2	22.22	22.28	22.33		
			6	0	22.14	22.09	22.04		
		Antenna Gain (dBi):					-0.26		
		Max. EIRP (dBm):					22.29		
		EIRP Limit (dBm):					30.00		
		16QAM	1	0	22.10	21.84	22.15		
			1	2	22.18	22.02	22.17		
			1	5	22.35	21.98	22.25		
			3	0	22.33	22.23	22.31		
			3	1	22.45	22.24	22.25		
			3	2	22.31	22.31	22.24		
			6	0	21.15	21.03	21.11		
		Antenna Gain (dBi):					-0.26		
		Max. EIRP (dBm):					22.19		
		EIRP Limit (dBm):					30.00		
		LTE Band	Bandwidth (MHz)	Modulation	RB Size	RB Offset	Average Power (dBm)		
19965	20175						20385		
1711.5MHz	1732.5MHz						1753.5MHz		
4	3	QPSK	1	0	22.51	22.39	22.32		
			1	7	22.57	22.53	22.43		
			1	14	22.46	22.45	22.34		
			8	0	22.10	22.04	22.12		
			8	4	22.16	22.11	22.11		
			8	7	22.12	22.03	21.97		
			15	0	21.98	22.06	22.05		
		Antenna Gain (dBi):					-0.26		
		Max. EIRP (dBm):					22.31		
		EIRP Limit (dBm):					30.00		
		16QAM	1	0	22.25	21.97	22.33		
			1	7	22.58	22.03	22.28		
			1	14	22.14	22.10	22.34		
			8	0	21.15	21.03	21.02		
			8	4	21.13	21.06	21.26		
			8	7	21.17	21.13	21.04		
			15	0	21.24	21.18	21.44		
		Antenna Gain (dBi):					-0.26		
		Max. EIRP (dBm):					22.32		
		EIRP Limit (dBm):					30.00		
		Note: EIRP (dBm) = Average power (dBm) + Antenna Gain (dBi).							

LTE Band	Bandwidth (MHz)	Modulation	RB Size	RB Offset	Average Power (dBm)				
					19975	20175	20375		
					1712.5MHz	1732.5MHz	1752.5MHz		
4	5	QPSK	1	0	22.44	22.40	22.30		
			1	12	22.53	22.57	22.37		
			1	24	22.49	22.38	22.36		
			12	0	22.08	22.04	22.10		
			12	6	22.03	22.16	22.14		
			12	11	22.11	22.18	22.09		
			25	0	22.10	22.03	22.08		
		Antenna Gain (dBi):					-0.26		
		Max. EIRP (dBm):					22.31		
		EIRP Limit (dBm):					30.00		
		16QAM	1	0	22.56	22.10	21.92		
			1	12	22.30	22.39	22.13		
			1	24	22.21	22.06	21.96		
			12	0	21.40	21.33	21.30		
			12	6	21.25	21.20	21.29		
			12	11	21.12	21.10	21.33		
			25	0	21.36	21.10	21.35		
		Antenna Gain (dBi):					-0.26		
		Max. EIRP (dBm):					22.30		
		EIRP Limit (dBm):					30.00		
		LTE Band	Bandwidth (MHz)	Modulation	RB Size	RB Offset	Average Power (dBm)		
20000	20175						20350		
1715.0MHz	1732.5MHz						1750.0MHz		
4	10	QPSK	1	0	22.50	22.37	22.51		
			1	24	22.61	22.52	22.50		
			1	49	22.41	22.36	22.38		
			25	0	22.13	21.98	22.11		
			25	12	22.02	21.99	22.03		
			25	24	22.14	22.06	22.09		
			50	0	22.04	22.10	22.16		
		Antenna Gain (dBi):					-0.26		
		Max. EIRP (dBm):					22.35		
		EIRP Limit (dBm):					30.00		
		16QAM	1	0	22.27	22.03	22.43		
			1	24	22.41	21.93	22.15		
			1	49	22.19	21.99	22.05		
			25	0	21.25	21.16	21.19		
			25	12	21.36	21.29	21.16		
			25	24	21.34	21.16	21.07		
			50	0	21.34	21.18	21.12		
		Antenna Gain (dBi):					-0.26		
		Max. EIRP (dBm):					22.15		
		EIRP Limit (dBm):					30.00		
		Note: EIRP (dBm) = Average power (dBm) + Antenna Gain (dBi).							

LTE Band	Bandwidth (MHz)	Modulation	RB Size	RB Offset	Average Power (dBm)				
					20025	20175	20325		
					1717.5MHz	1732.5MHz	1747.5MHz		
4	15	QPSK	1	0	22.57	22.78	22.67		
			1	37	22.68	22.74	22.85		
			1	74	22.41	22.55	22.54		
			36	0	22.34	22.25	22.41		
			36	16	22.23	22.23	22.34		
			36	35	22.13	22.28	22.32		
			75	0	22.32	22.33	22.35		
		Antenna Gain (dBi):					-0.26		
		Max. EIRP (dBm):					22.59		
		EIRP Limit (dBm):					30.00		
		16QAM	1	0	22.13	22.30	22.52		
			1	37	22.47	22.38	22.46		
			1	74	22.40	22.19	22.32		
			36	0	21.46	21.45	21.57		
			36	16	21.34	21.15	21.40		
			36	35	21.46	21.47	21.35		
			75	0	21.37	21.26	21.39		
		Antenna Gain (dBi):					-0.26		
		Max. EIRP (dBm):					22.26		
		EIRP Limit (dBm):					30.00		
		LTE Band	Bandwidth (MHz)	Modulation	RB Size	RB Offset	Average Power (dBm)		
20050	20175						20300		
1720.0MHz	1732.5MHz						1745.0MHz		
4	20	QPSK	1	0	22.76	22.61	22.57		
			1	49	22.75	22.73	22.63		
			1	99	22.56	22.40	22.37		
			50	0	22.32	22.39	22.27		
			50	24	22.18	22.15	22.18		
			50	49	22.30	22.25	22.12		
			100	0	22.32	22.15	22.21		
		Antenna Gain (dBi):					-0.26		
		Max. EIRP (dBm):					22.50		
		EIRP Limit (dBm):					30.00		
		16QAM	1	0	22.65	22.24	22.47		
			1	49	22.05	22.37	22.13		
			1	99	22.59	22.40	22.11		
			50	0	21.46	21.51	21.38		
			50	24	21.31	21.28	21.59		
			50	49	21.26	21.37	21.33		
			100	0	21.32	21.49	21.31		
		Antenna Gain (dBi):					-0.26		
		Max. EIRP (dBm):					22.39		
		EIRP Limit (dBm):					30.00		
		Note: EIRP (dBm) = Average power (dBm) + Antenna Gain (dBi).							

LTE Band	Bandwidth (MHz)	Modulation	RB Size	RB Offset	Average Power (dBm)				
					20775	21100	21425		
					2502.5MHz	2535.0MHz	2567.5MHz		
7	5	QPSK	1	0	22.16	22.02	22.04		
			1	12	22.14	22.19	22.14		
			1	24	22.03	22.16	22.06		
			12	0	21.87	21.93	21.82		
			12	6	21.79	21.75	21.86		
			12	11	21.91	21.94	21.85		
			25	0	21.87	21.78	21.85		
		Antenna Gain (dBi):					-0.72		
		Max. EIRP (dBm):					21.44		
		EIRP Limit (dBm):					33.00		
		16QAM	1	0	21.74	21.76	21.65		
			1	12	21.44	21.81	21.84		
			1	24	21.80	21.74	21.74		
			12	0	20.65	20.77	20.55		
			12	6	20.59	20.49	20.69		
			12	11	20.57	20.68	20.46		
			25	0	20.53	20.54	20.60		
		Antenna Gain (dBi):					-0.72		
Max. EIRP (dBm):					21.12				
EIRP Limit (dBm):					33.00				
LTE Band	Bandwidth (MHz)	Modulation	RB Size	RB Offset	Average Power (dBm)				
					20800	21100	21400		
					2505.0MHz	2535.0MHz	2565.0MHz		
7	10	QPSK	1	0	22.17	22.02	22.13		
			1	24	22.26	22.23	22.16		
			1	49	22.25	22.11	22.05		
			25	0	21.82	21.81	21.81		
			25	12	21.96	21.95	21.84		
			25	24	21.90	21.92	22.01		
			50	0	21.81	21.82	21.85		
		Antenna Gain (dBi):					-0.72		
		Max. EIRP (dBm):					21.54		
		EIRP Limit (dBm):					33.00		
		16QAM	1	0	21.67	21.98	21.84		
			1	24	21.46	22.35	22.03		
			1	49	21.98	22.13	21.91		
			25	0	20.71	20.55	20.51		
			25	12	20.62	20.62	20.60		
			25	24	20.78	20.48	20.63		
			50	0	20.58	20.43	20.38		
		Antenna Gain (dBi):					-0.72		
Max. EIRP (dBm):					21.63				
EIRP Limit (dBm):					33.00				
Note: EIRP (dBm) = Average power (dBm) + Antenna Gain (dBi).									

LTE Band	Bandwidth (MHz)	Modulation	RB Size	RB Offset	Average Power (dBm)				
					20825	21100	21375		
					2507.5MHz	2535.0MHz	2562.5MHz		
7	15	QPSK	1	0	22.21	22.27	22.18		
			1	37	22.26	22.34	22.27		
			1	74	22.11	22.30	22.18		
			36	0	21.90	21.89	21.84		
			36	16	21.87	21.84	21.90		
			36	35	21.96	21.83	21.93		
			75	0	21.86	21.87	21.82		
		Antenna Gain (dBi):					-0.72		
		Max. EIRP (dBm):					21.62		
		EIRP Limit (dBm):					33.00		
		16QAM	1	0	21.87	22.23	21.89		
			1	37	22.03	21.70	21.81		
			1	74	21.38	21.52	21.75		
			36	0	20.68	20.72	20.60		
			36	16	20.75	20.77	20.75		
			36	35	20.77	20.68	20.71		
			75	0	20.54	20.64	20.66		
		Antenna Gain (dBi):					-0.72		
		Max. EIRP (dBm):					21.31		
		EIRP Limit (dBm):					33.00		
		LTE Band	Bandwidth (MHz)	Modulation	RB Size	RB Offset	Average Power (dBm)		
20850	21100						21350		
2510.0MHz	2535.0MHz						2560.0MHz		
7	20	QPSK	1	0	22.26	22.30	22.21		
			1	49	22.33	22.65	22.44		
			1	99	22.40	22.27	22.21		
			50	0	22.02	21.88	21.83		
			50	24	21.88	21.95	22.05		
			50	49	21.90	22.01	22.01		
			100	0	21.88	21.88	21.90		
		Antenna Gain (dBi):					-0.72		
		Max. EIRP (dBm):					21.93		
		EIRP Limit (dBm):					33.00		
		16QAM	1	0	21.85	21.84	21.41		
			1	49	21.97	21.57	21.57		
			1	99	21.86	21.35	21.68		
			50	0	20.55	20.70	20.61		
			50	24	20.61	20.53	20.74		
			50	49	20.70	20.68	20.70		
			100	0	20.59	20.56	20.56		
		Antenna Gain (dBi):					-0.72		
		Max. EIRP (dBm):					21.25		
		EIRP Limit (dBm):					33.00		
		Note: EIRP (dBm) = Average power (dBm) + Antenna Gain (dBi).							

6.2 Peak-to-Average Ratio

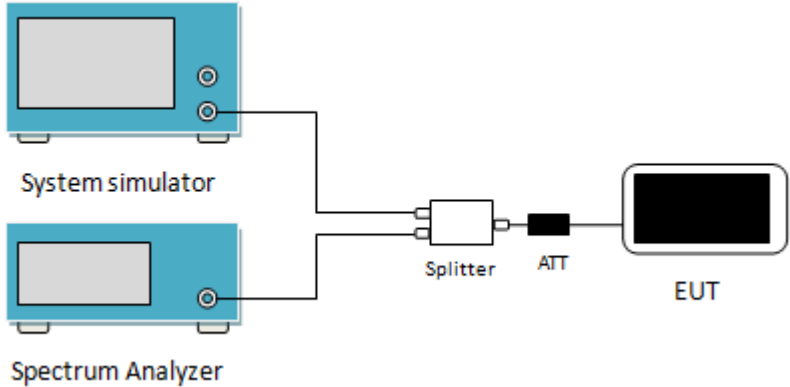
Test Requirement:	Part 24.232 (d), Part 27.50(d)(5)
Test Method:	ANSI/TIA-603-D 2010
Limit:	The peak-to-average ratio (PAR) of the transmission may not exceed 13 dB.
Test Setup:	 <p>The diagram shows a test setup for measuring Peak-to-Average Ratio (PAR). On the left, there are two blue rectangular devices: a 'System simulator' on top and a 'Spectrum Analyzer' on the bottom. Both have their output ports connected to a central 'Splitter' box. From the 'Splitter', one line goes to an 'ATT' (attenuator) box, and another line goes to an 'EUT' (Equipment Under Test) box. The 'ATT' and 'EUT' are connected in series.</p>
Test Procedure:	<ol style="list-style-type: none"> 1 The RF output of the transceiver was connected to a spectrum analyzer through appropriate attenuation. 2 Set the CCDF option in spectrum analyzer, $RBW \geq OBW$, 3 Set the EUT working in highest power level, measured and recorded the 0.1% as PAPR level. 4 Repeat step 1~3 at other frequency and modulations.
Test Instruments:	Refer to section 5.9 for details
Test mode:	Refer to section 5.3 for details
Test results:	Passed

Measurement Data (Worst case):

Bandwidth	Modulation	RB Size	RB Offset	PAPR
LTE Band 2 (Middle Channel)				
20MHz	QPSK	100	0	4.12
	16QAM	100	0	5.80
LTE Band 4 (Middle Channel)				
20MHz	QPSK	100	0	4.06
	16QAM	100	0	5.74
LTE Band 7 (Middle Channel)				
20MHz	QPSK	100	0	4.23
	16QAM	100	0	5.97

Test plots as below:

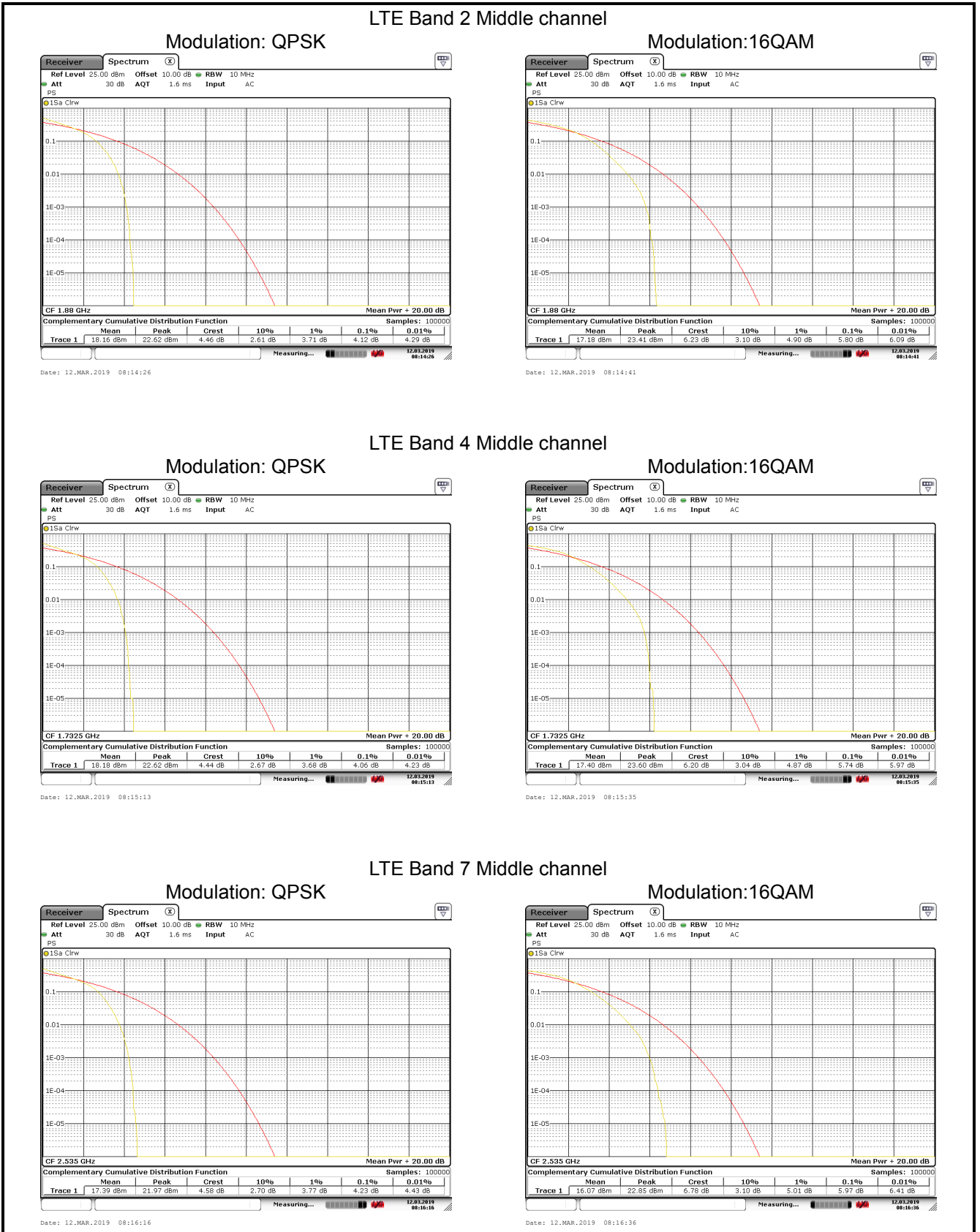

6.3 Occupy Bandwidth

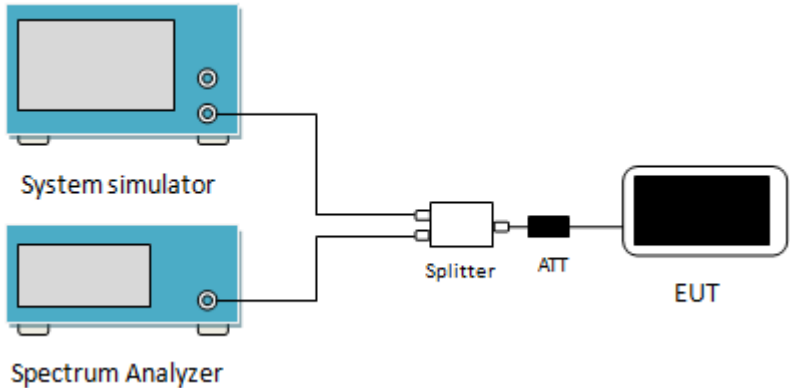
Test Requirement:	Part 24.238(b), Part 27.53(h), Part 27.53(m)
Test Method:	ANSI/TIA-603-D 2010
Test Setup:	 <p>The diagram illustrates the test setup. On the left, there are two blue rectangular units: the top one is labeled 'System simulator' and the bottom one is labeled 'Spectrum Analyzer'. Both have a screen and two circular ports on the right side. A single cable connects the two ports of the System simulator to the top two ports of a white 'Splitter' box. From the bottom port of the Splitter, a cable goes to a black 'ATT' (attenuator) box. From the right side of the ATT, a cable connects to the left side of a white 'EUT' (Equipment Under Test) box, which has a black screen on its front.</p>
Test Procedure:	<ol style="list-style-type: none"> 1. The EUT's output RF connector was connected with a short cable to the spectrum analyzer 2. RBW was set to about 1% ~ 5% of emission BW, VBW= 3 times RBW. 3. -26dBc display line was placed on the screen (or 99% bandwidth), the occupied bandwidth is the delta frequency between the two points where the display line intersects the signal trace.
Test Instruments:	Refer to section 5.9 for details
Test mode:	Refer to section 5.3 for details
Test results:	Passed

Measurement Data:

LTE Band 2					
Bandwidth	Channel	Frequency (MHz)	Modulation	99% OBW (kHz)	-26dBcEBW (kHz)
1.4MHz	18607	1850.70	16QAM	1098	1266
			QPSK	1104	1290
	18900	1880.00	16QAM	1104	1290
			QPSK	1104	1272
	19193	1909.30	16QAM	1098	1254
			QPSK	1104	1278
3MHz	18615	1851.50	16QAM	2748	3084
			QPSK	2772	3228
	18900	1880.00	16QAM	2736	3132
			QPSK	2772	3228
	19185	1908.50	16QAM	2748	3072
			QPSK	2784	3132
5MHz	18625	1852.50	16QAM	4520	4980
			QPSK	4500	1980
	18900	1880.00	16QAM	4500	4980
			QPSK	4520	4980
	19175	1907.50	16QAM	4500	1960
			QPSK	4520	5080
10MHz	18650	1855.00	16QAM	9160	10160
			QPSK	9200	10280
	18900	1880.00	16QAM	9120	10280
			QPSK	9120	10240
	19150	1905.00	16QAM	9120	10280
			QPSK	9120	10320
15MHz	18675	1857.50	16QAM	13500	14880
			QPSK	13560	15240
	18900	1880.00	16QAM	13560	15000
			QPSK	13560	15000
	19125	1902.50	16QAM	13560	15000
			QPSK	13560	15180
20MHz	18700	1860.00	16QAM	18000	19680
			QPSK	18080	19760
	18900	1880.00	16QAM	18080	19520
			QPSK	18080	20080
	19100	1900.00	16QAM	17920	19520
			QPSK	18000	19680

LTE Band 4					
Bandwidth	Channel	Frequency (MHz)	Modulation	99% OBW (kHz)	-26dBcEBW (kHz)
1.4MHz	19957	1710.7	16QAM	1098	1266
			QPSK	1104	1302
	20175	1732.5	16QAM	1104	1278
			QPSK	1104	1290
	20393	1754.3	16QAM	1098	1296
			QPSK	1104	1302
3MHz	19965	1711.5	16QAM	2748	3096
			QPSK	2772	3156
	20175	1732.5	16QAM	2736	3108
			QPSK	2760	3252
	20385	1750.5	16QAM	2760	3096
			QPSK	2784	3276
5MHz	19975	1712.5	16QAM	4500	4920
			QPSK	4540	5100
	20175	1732.5	16QAM	4500	4940
			QPSK	4540	4960
	20375	1752.5	16QAM	4500	4980
			QPSK	4540	5060
10MHz	20000	1715.0	16QAM	9120	10160
			QPSK	9120	10360
	20175	1732.5	16QAM	9120	10240
			QPSK	9120	10520
	20350	1750.0	16QAM	9120	10200
			QPSK	9120	10400
15MHz	20025	1717.5	16QAM	13560	14880
			QPSK	13500	15300
	20175	1732.5	16QAM	13560	15000
			QPSK	13560	15000
	20325	1747.5	16QAM	13560	15180
			QPSK	13560	15180
20MHz	20050	1720.0	16QAM	18080	19680
			QPSK	18080	19520
	20175	1732.5	16QAM	18080	19840
			QPSK	18080	19840
	20300	1745.0	16QAM	18000	19840
			QPSK	18000	2000

LTE Band 7					
Bandwidth	Channel	Frequency (MHz)	Modulation	99% OBW (kHz)	-26dBcEBW (kHz)
5MHz	20775	2502.5	16QAM	4500	5000
			QPSK	4520	5040
	21100	2535.0	16QAM	4500	4940
			QPSK	4520	4980
	21425	2567.5	16QAM	4500	4920
			QPSK	4540	4960
10MHz	20800	2505.0	16QAM	9080	10160
			QPSK	9120	10280
	21100	2535.0	16QAM	9080	10080
			QPSK	9120	10200
	21400	2565.0	16QAM	9160	10160
			QPSK	9160	10200
15MHz	20825	2507.5	16QAM	13500	14880
			QPSK	13500	15060
	21100	2535.0	16QAM	13500	14700
			QPSK	13560	15000
	21375	2562.5	16QAM	13500	15000
			QPSK	13620	15000
20MHz	20850	2510.0	16QAM	18000	19280
			QPSK	18000	19520
	21100	2535.0	16QAM	17320	19600
			QPSK	18080	19760
	21350	2560.0	16QAM	18080	19760
			QPSK	18080	19840

Test plot as follows:
LTE Band 2 part:

LTE Band 2: 99% Occupy bandwidth
BW: 1.4MHz

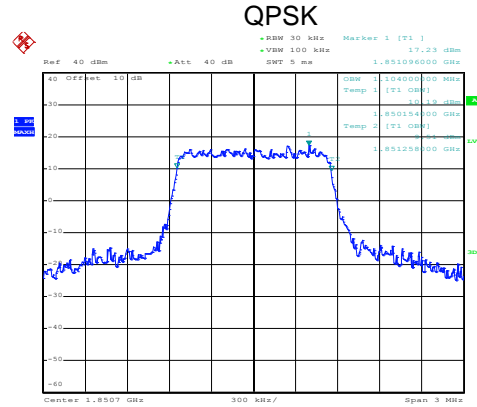
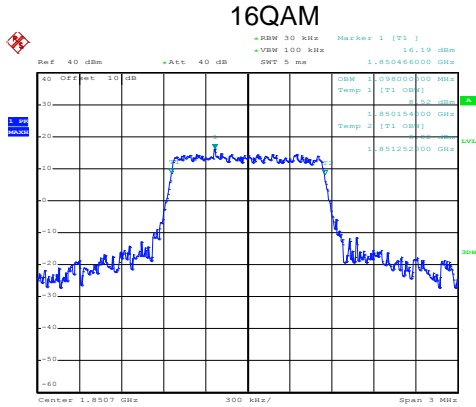

Date: 10.MAR.2019 13:24:49

Date: 10.MAR.2019 13:24:42

Lowest channel

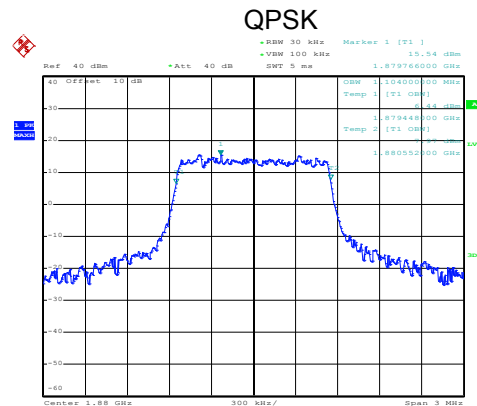
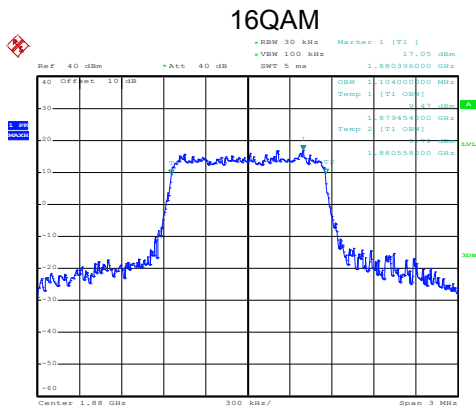

Date: 10.MAR.2019 13:24:20

Date: 10.MAR.2019 13:24:13

Middle channel

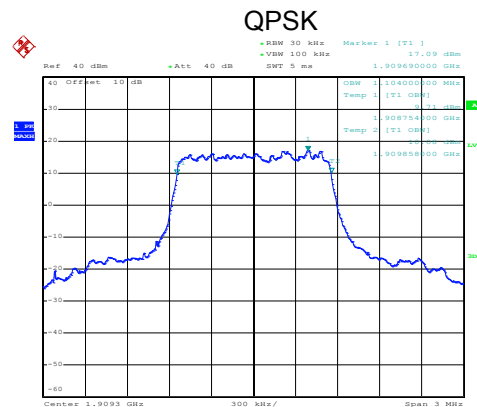
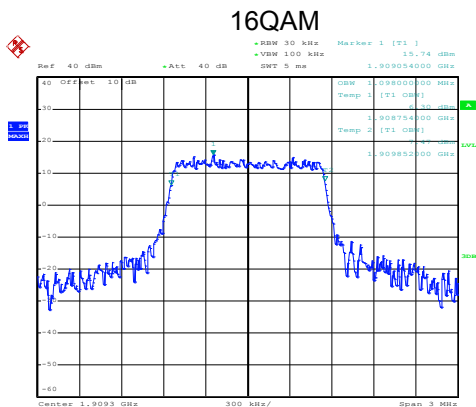

Date: 10.MAR.2019 13:23:18

Date: 10.MAR.2019 13:23:10

Highest channel

LTE Band 2: 99% Occupancy bandwidth BW: 3MHz

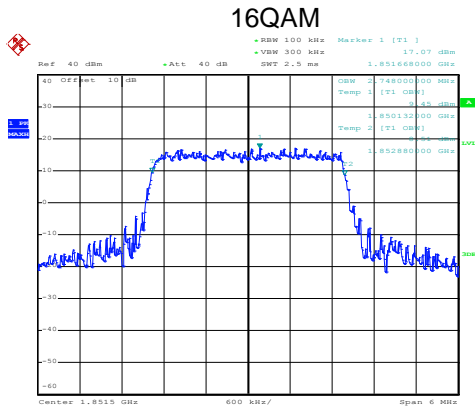

Date: 10.MAR.2019 13:14:44

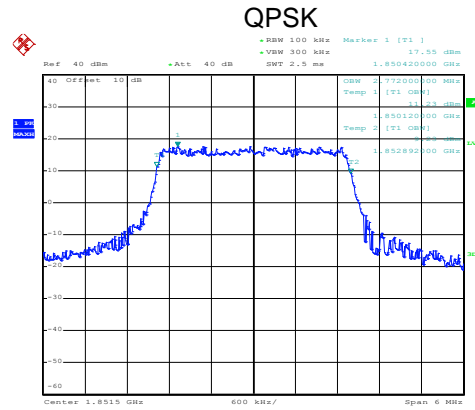

Date: 10.MAR.2019 13:14:38

Lowest channel

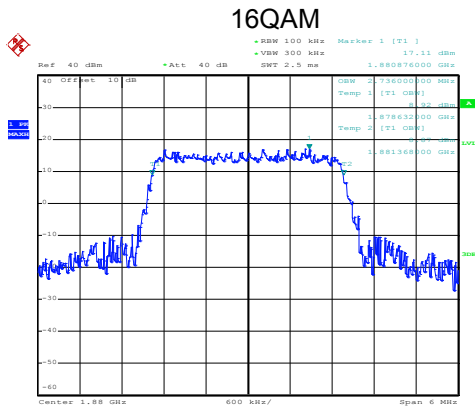

Date: 10.MAR.2019 13:15:12

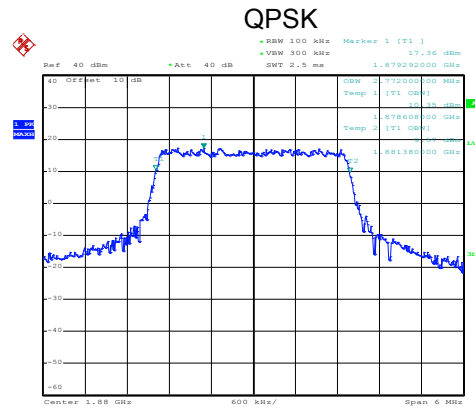

Date: 10.MAR.2019 13:15:06

Middle channel

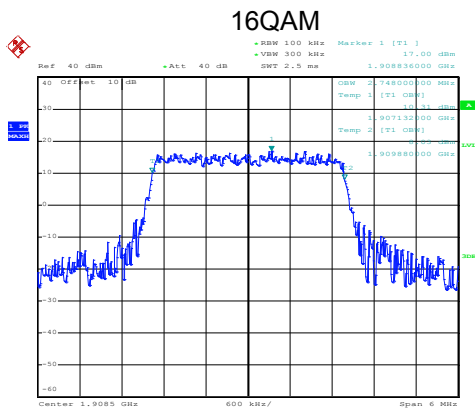

Date: 10.MAR.2019 13:16:43

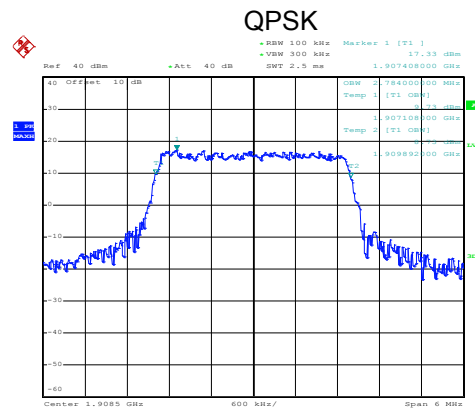

Date: 10.MAR.2019 13:16:37

Highest channel

LTE Band 2: 99% Occupy bandwidth
BW: 5MHz

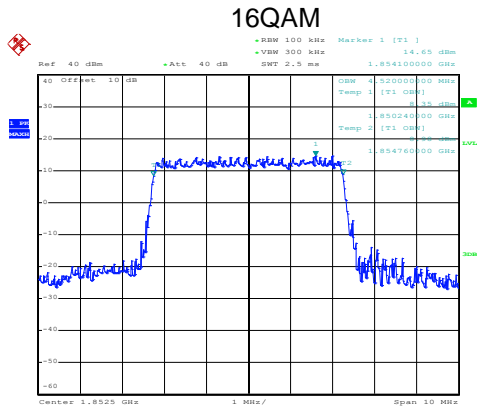

Date: 10.MAR.2019 13:13:08

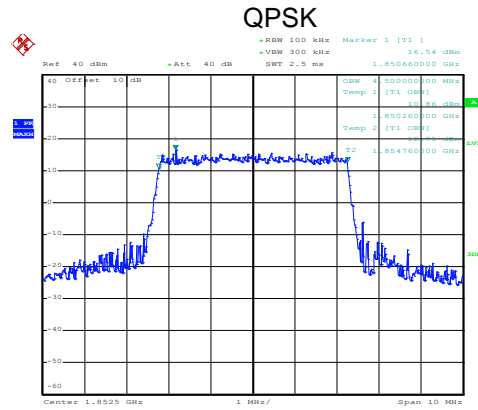

Date: 10.MAR.2019 13:13:02

Lowest channel

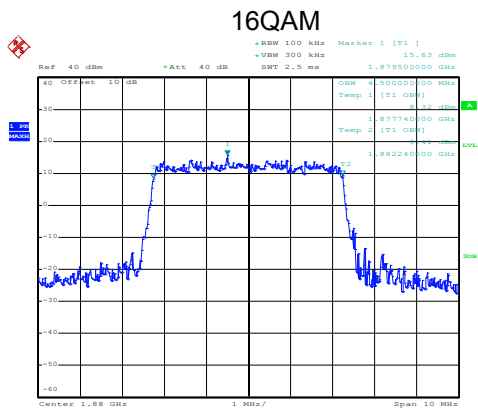

Date: 10.MAR.2019 13:12:10

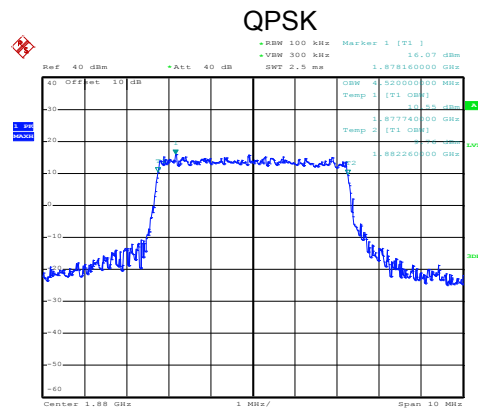

Date: 10.MAR.2019 13:12:04

Middle channel

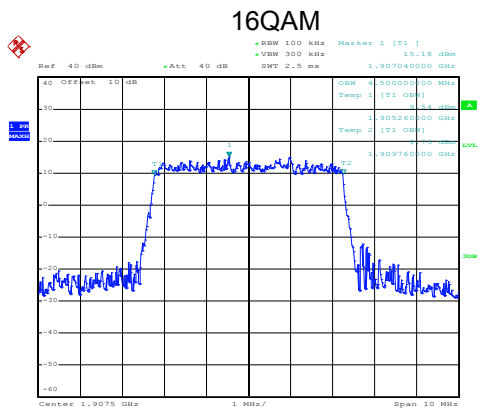

Date: 10.MAR.2019 13:12:41

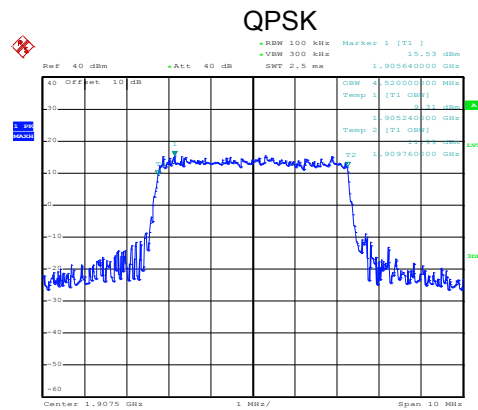

Date: 10.MAR.2019 13:12:35

Highest channel

LTE Band 2: 99% Occupy bandwidth
BW: 10MHz

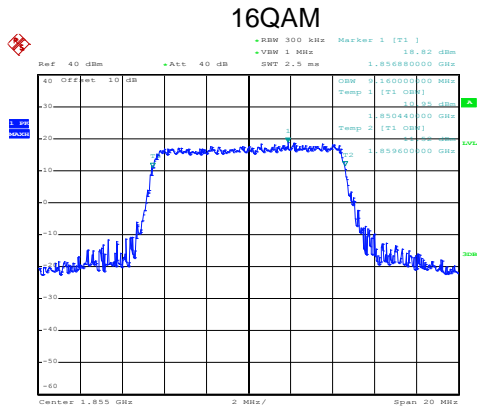

Date: 10.MAR.2019 13:05:33

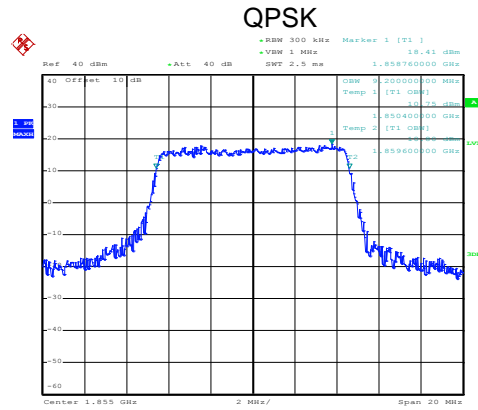

Date: 10.MAR.2019 13:05:23

Lowest channel

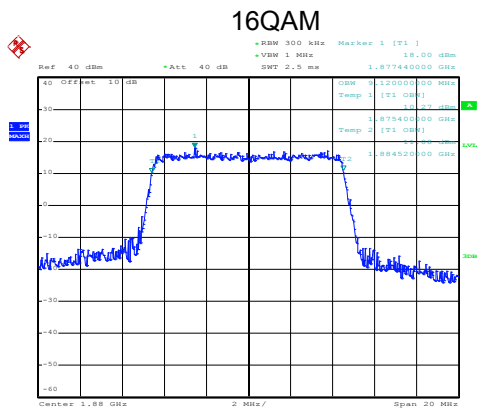

Date: 10.MAR.2019 13:06:45

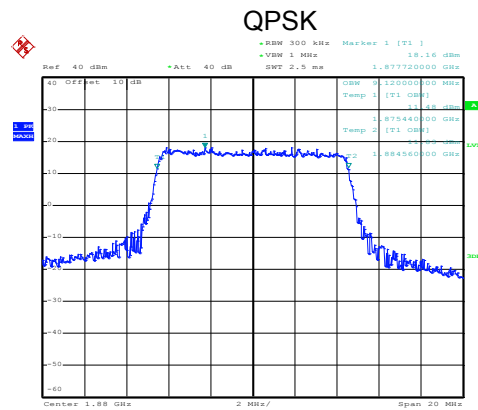

Date: 10.MAR.2019 13:06:37

Middle channel

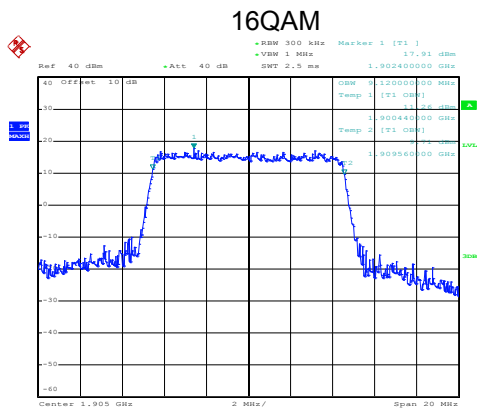

Date: 10.MAR.2019 13:07:11

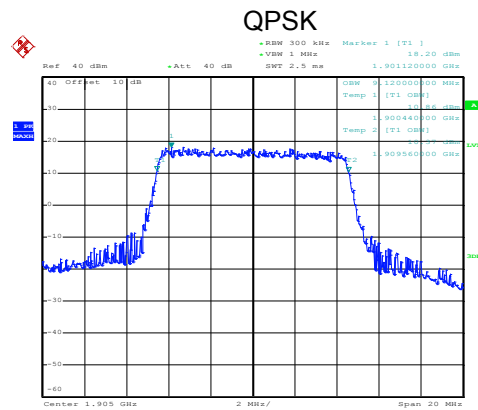

Date: 10.MAR.2019 13:07:04

Highest channel

LTE Band 2: 99% Occupancy bandwidth
BW: 15MHz

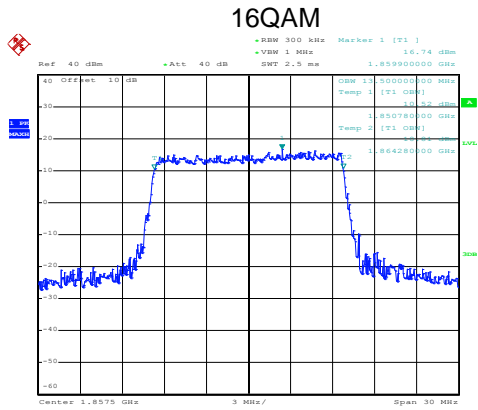

Date: 10.MAR.2019 13:04:23

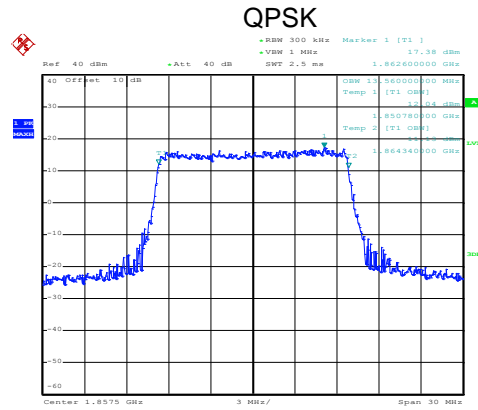

Date: 10.MAR.2019 13:04:15

Lowest channel

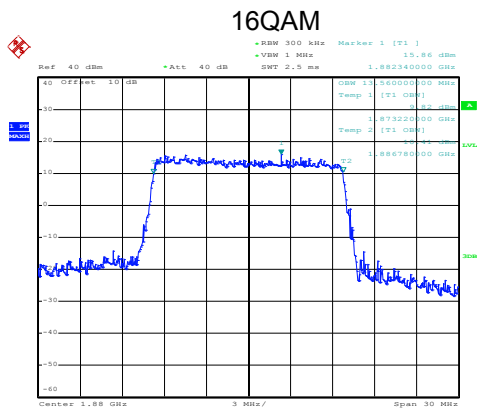

Date: 10.MAR.2019 13:02:32

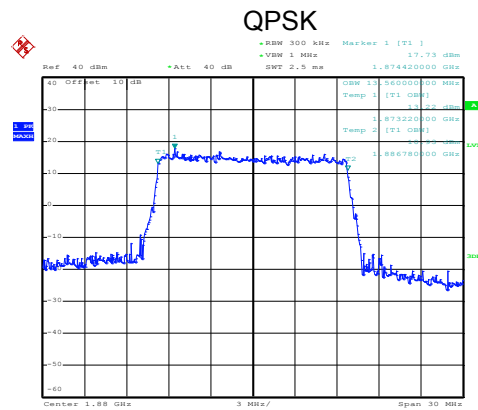

Date: 10.MAR.2019 13:02:26

Middle channel

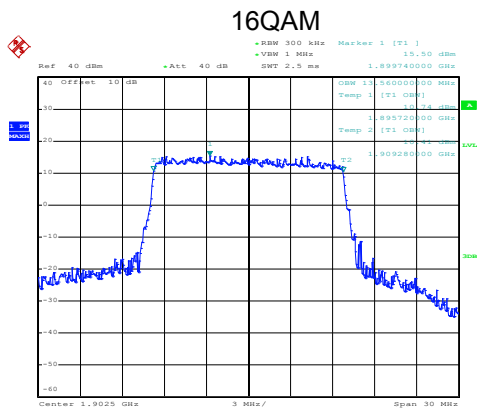

Date: 10.MAR.2019 13:02:06

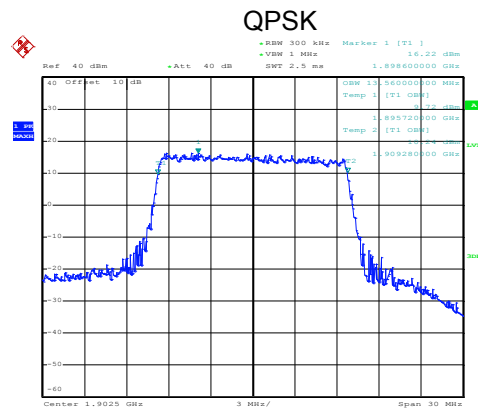

Date: 10.MAR.2019 13:01:58

Highest channel

LTE Band 2: 99% Occupancy bandwidth
BW: 20MHz

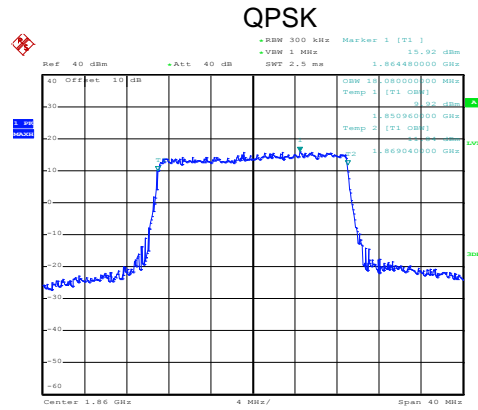
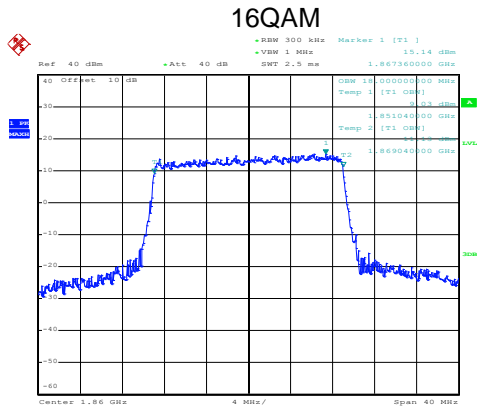

Date: 10.MAR.2019 12:58:00

Date: 10.MAR.2019 12:57:45

Lowest channel

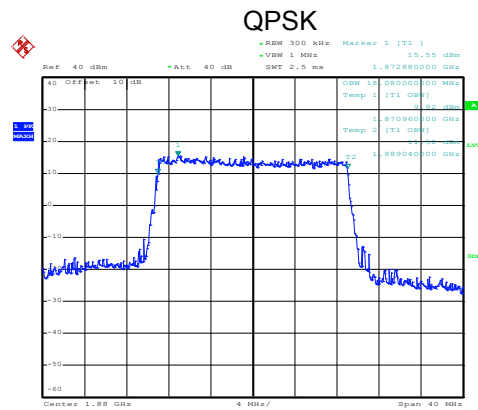
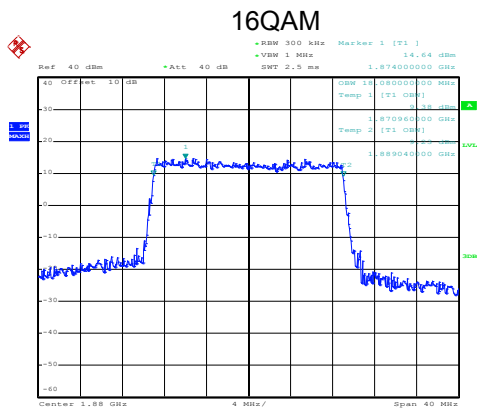

Date: 10.MAR.2019 12:59:59

Date: 10.MAR.2019 12:59:51

Middle channel

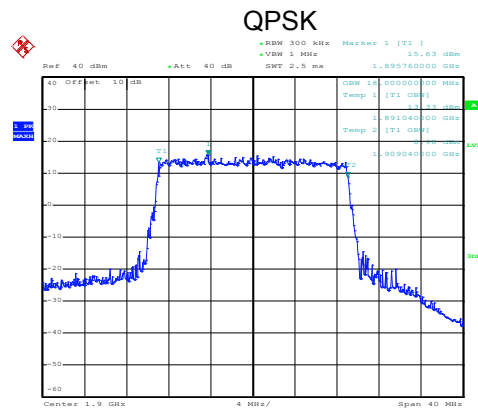
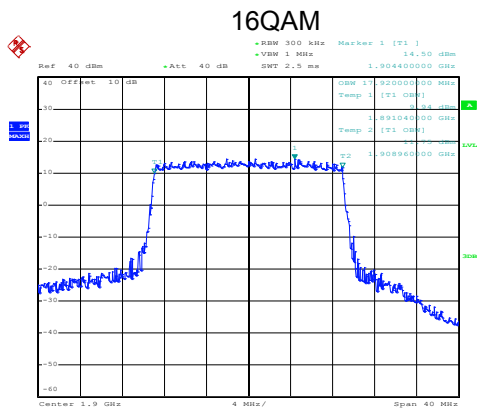

Date: 10.MAR.2019 13:00:28

Date: 10.MAR.2019 13:00:18

Highest channel

LTE Band 2: -26dBc bandwidth
BW: 1.4MHz

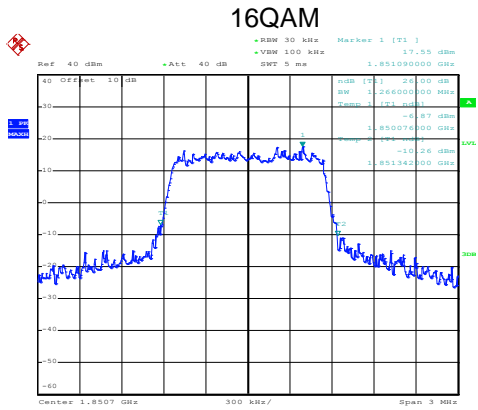

Date: 10.MAR.2019 13:25:07

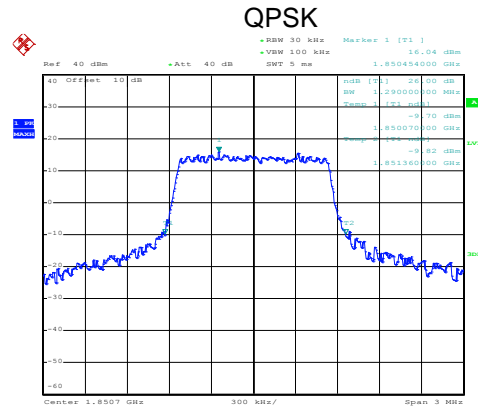

Date: 10.MAR.2019 13:25:01

Lowest channel

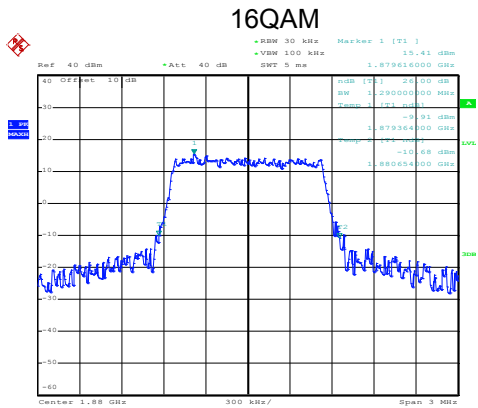

Date: 10.MAR.2019 13:24:03

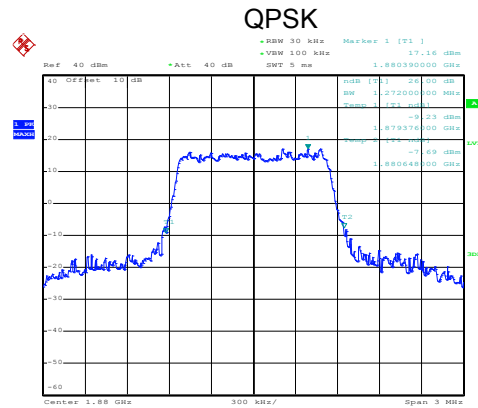

Date: 10.MAR.2019 13:23:57

Middle channel

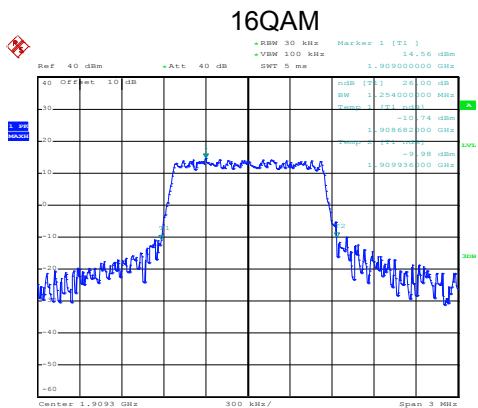

Date: 10.MAR.2019 13:23:38

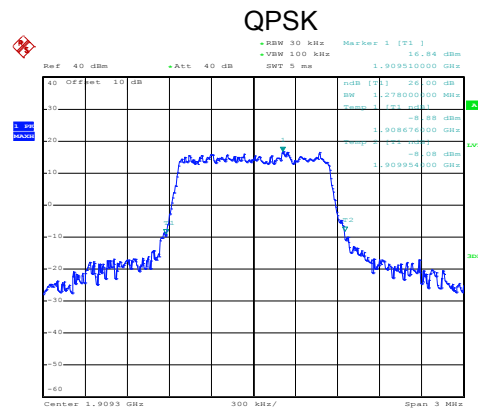

Date: 10.MAR.2019 13:23:31

Highest channel

LTE Band 2: -26dBc bandwidth
BW: 3MHz

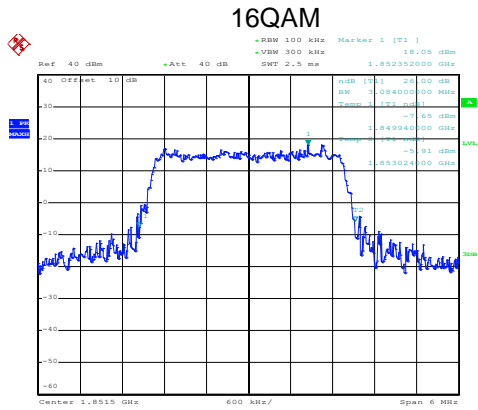

Date: 10.MAR.2019 13:14:26

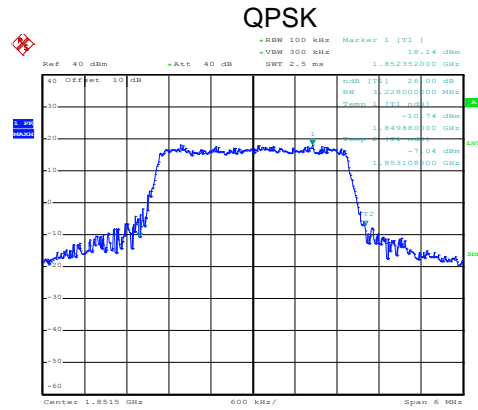

Date: 10.MAR.2019 13:14:20

Lowest channel

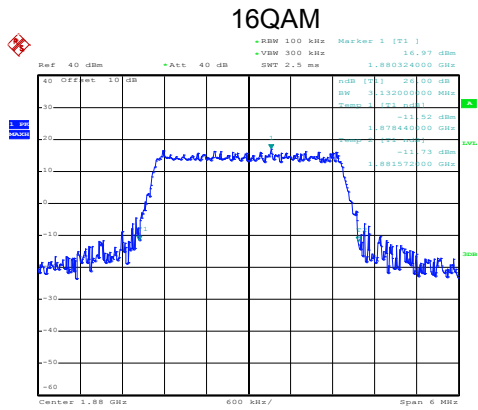

Date: 10.MAR.2019 13:15:32

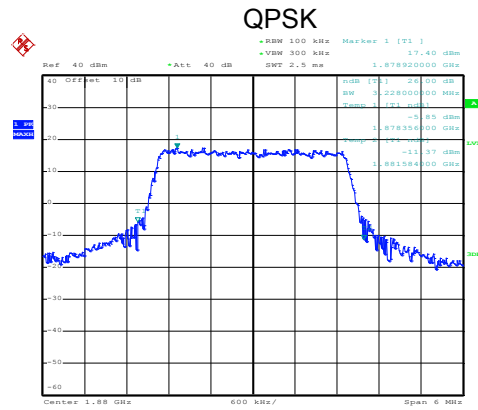

Date: 10.MAR.2019 13:15:26

Middle channel

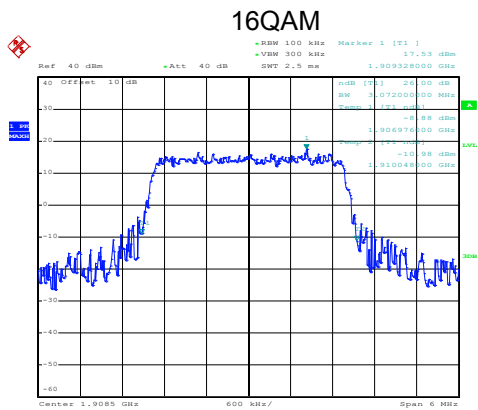

Date: 10.MAR.2019 13:16:25

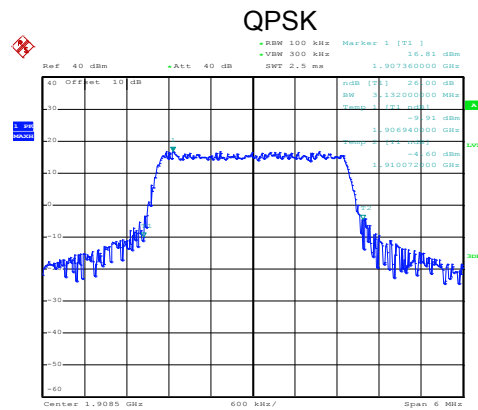

Date: 10.MAR.2019 13:16:20

Highest channel

LTE Band 2: -26dBc bandwidth
BW: 5MHz

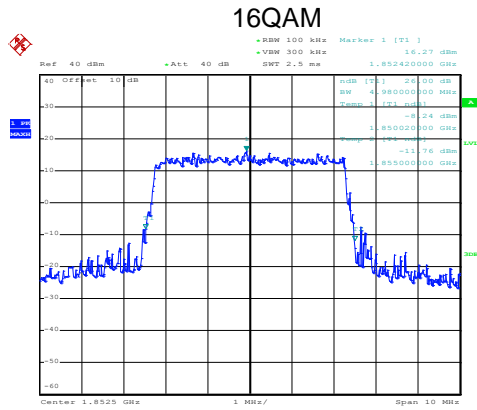

Date: 10.MAR.2019 13:13:26

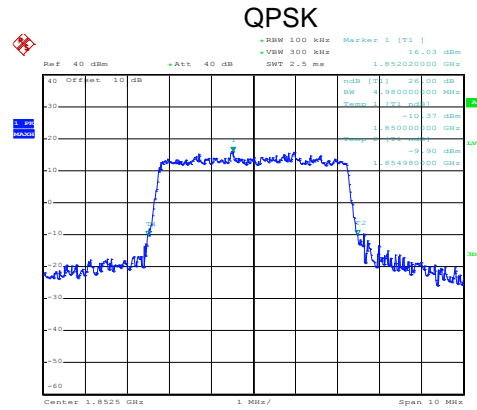

Date: 10.MAR.2019 13:13:20

Lowest channel

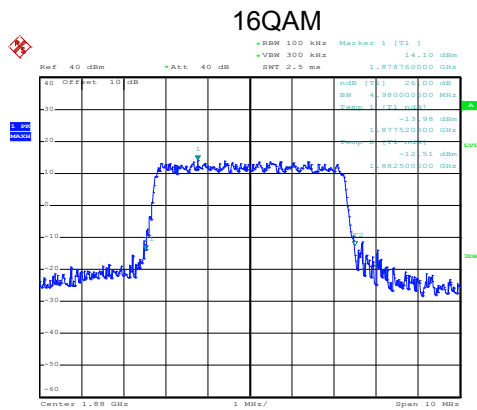

Date: 10.MAR.2019 13:11:43

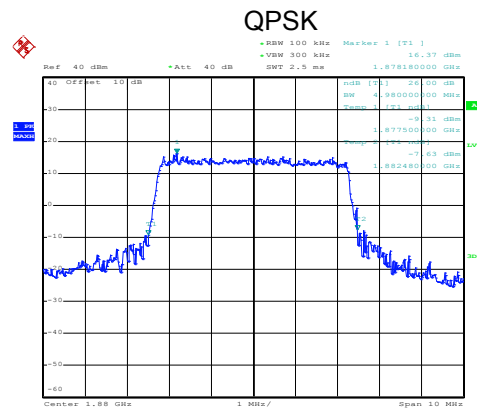

Date: 10.MAR.2019 13:11:36

Middle channel

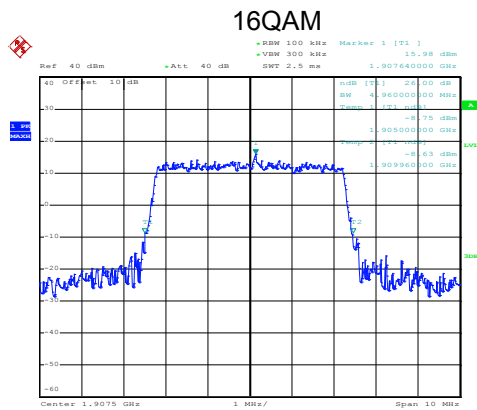

Date: 10.MAR.2019 13:11:11

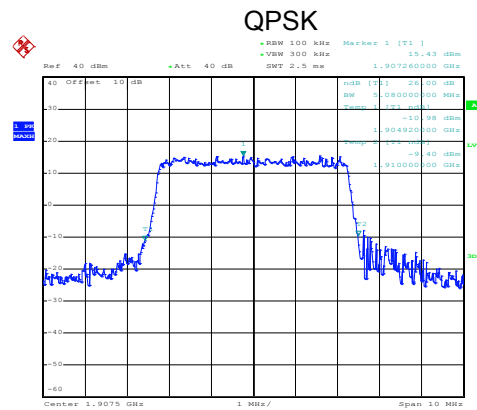

Date: 10.MAR.2019 13:11:04

Highest channel

LTE Band 2: -26dBc bandwidth
BW: 10MHz

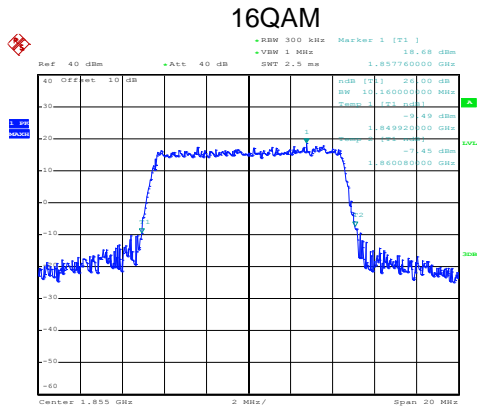

Date: 10.MAR.2019 13:05:51

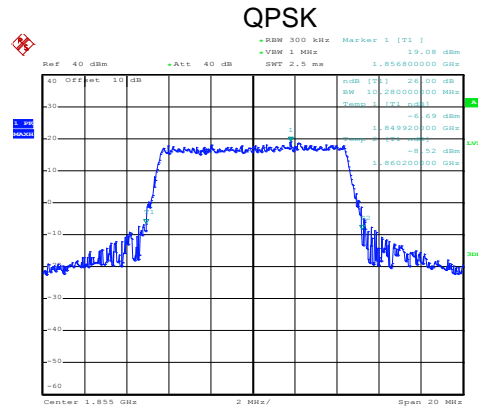

Date: 10.MAR.2019 13:05:43

Lowest channel

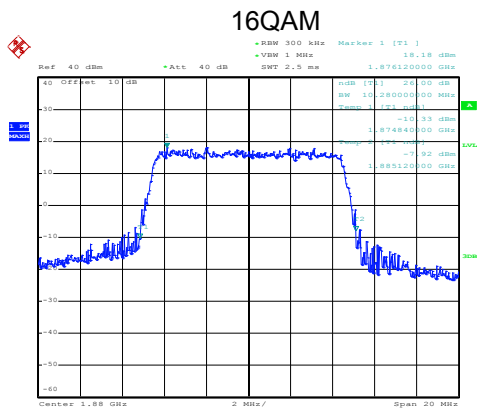

Date: 10.MAR.2019 13:06:23

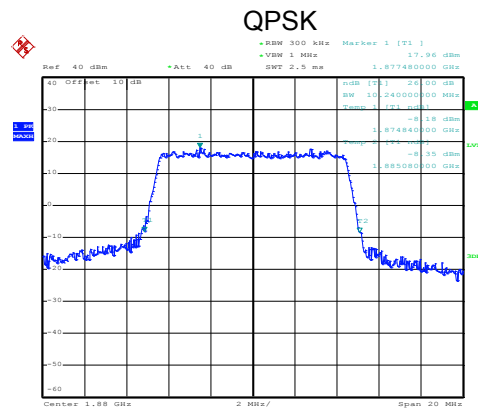

Date: 10.MAR.2019 13:06:15

Middle channel

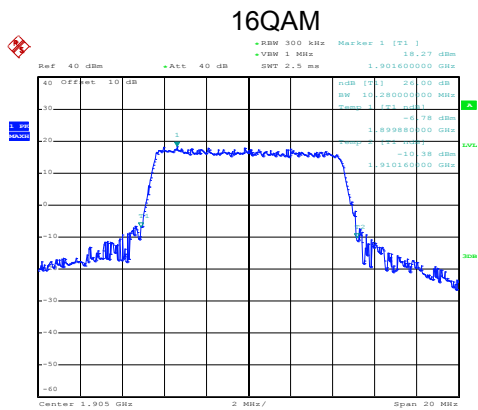

Date: 10.MAR.2019 13:07:38

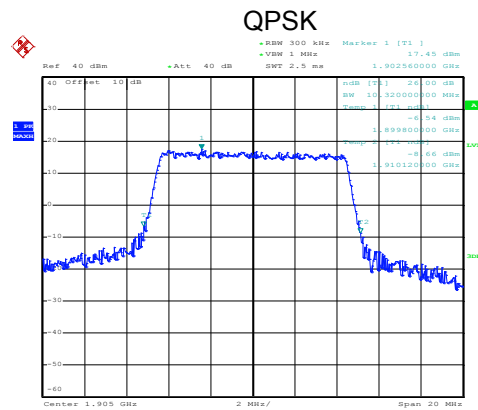

Date: 10.MAR.2019 13:07:24

Highest channel

LTE Band 2: -26dBc bandwidth
BW: 15MHz

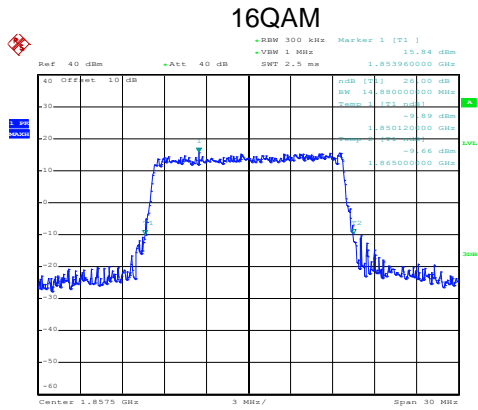

Date: 10.MAR.2019 13:03:59

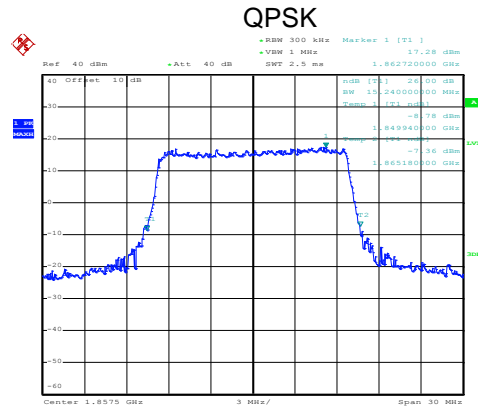

Date: 10.MAR.2019 13:03:50

Lowest channel

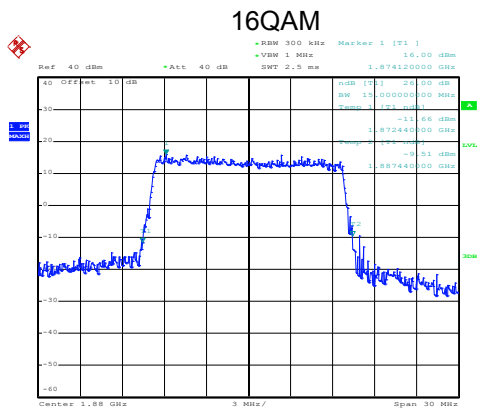

Date: 10.MAR.2019 13:02:59

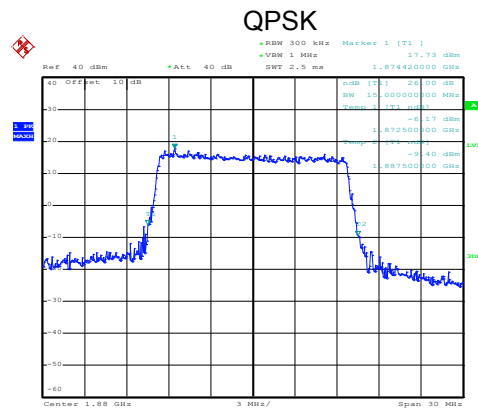

Date: 10.MAR.2019 13:02:52

Middle channel

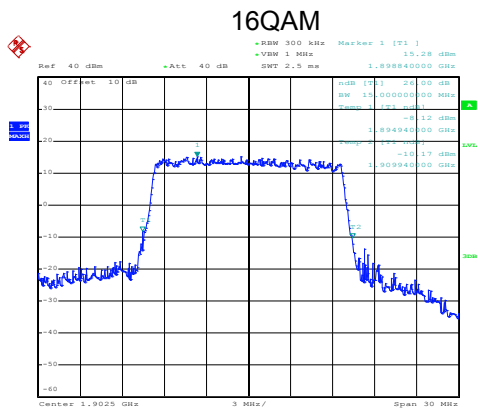

Date: 10.MAR.2019 13:01:44

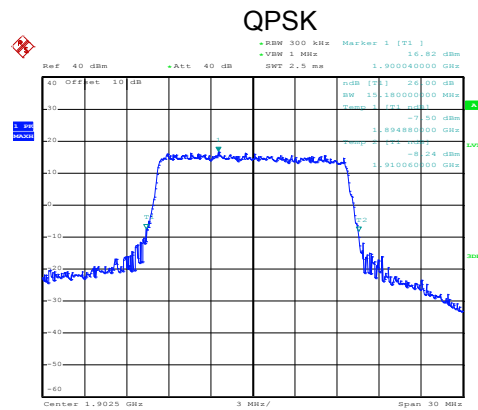

Date: 10.MAR.2019 13:01:38

Highest channel

LTE Band 2: -26dBc bandwidth
BW: 20MHz

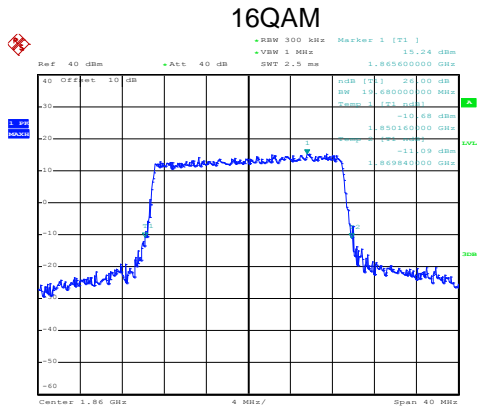

Date: 10.MAR.2019 12:58:42

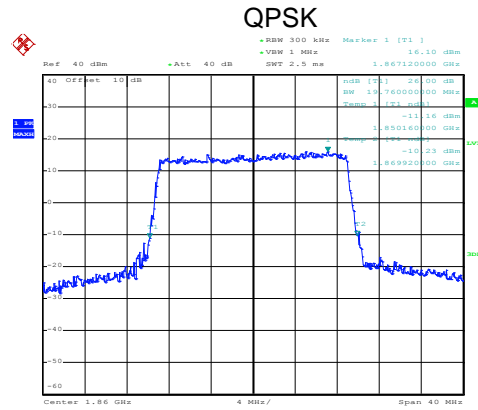

Date: 10.MAR.2019 12:58:28

Lowest channel

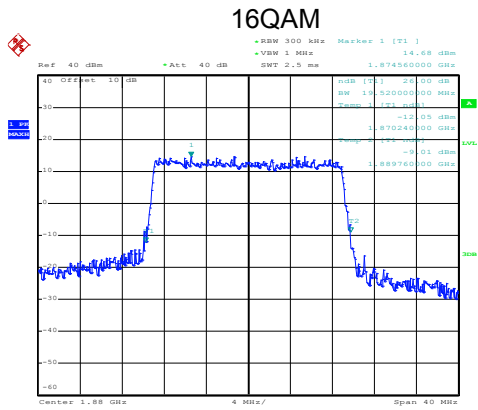

Date: 10.MAR.2019 12:59:37

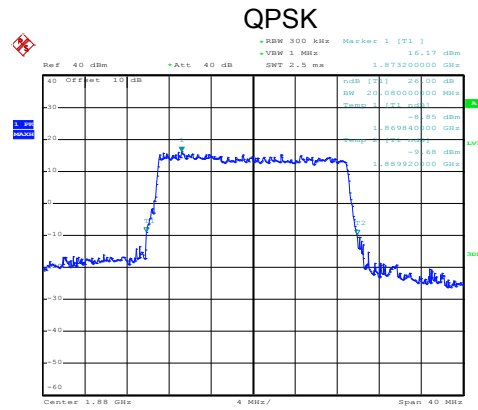

Date: 10.MAR.2019 12:59:29

Middle channel

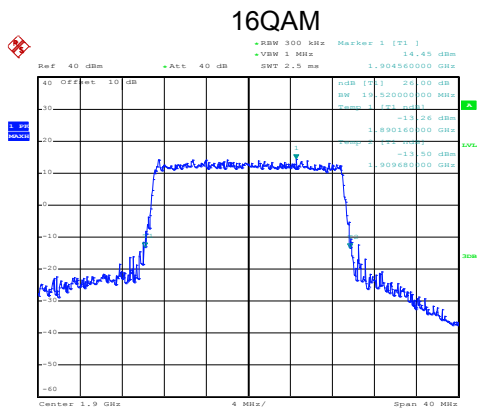

Date: 10.MAR.2019 13:00:53

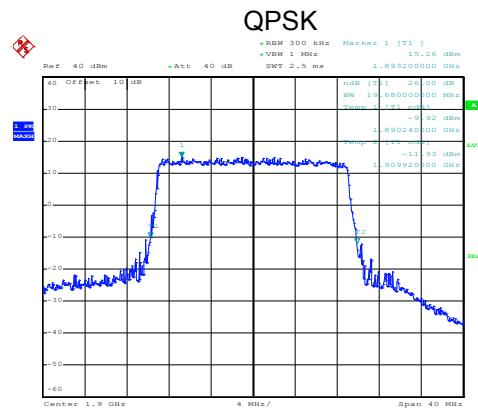

Date: 10.MAR.2019 13:00:47

Highest channel

LTE Band 4 part:

LTE Band 4: 99% Occupancy bandwidth
BW: 1.4MHz

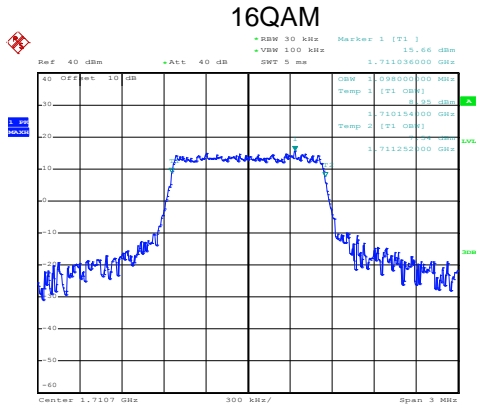

Date: 10.MAR.2019 13:26:20

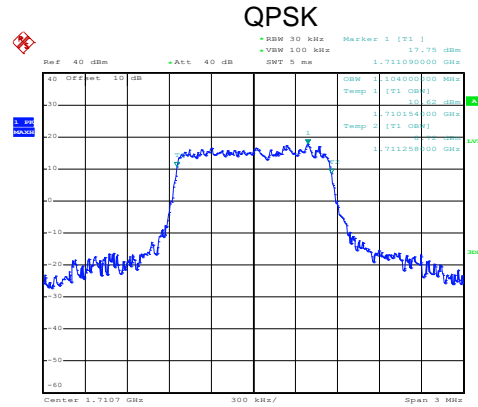

Date: 10.MAR.2019 13:26:13

Lowest channel

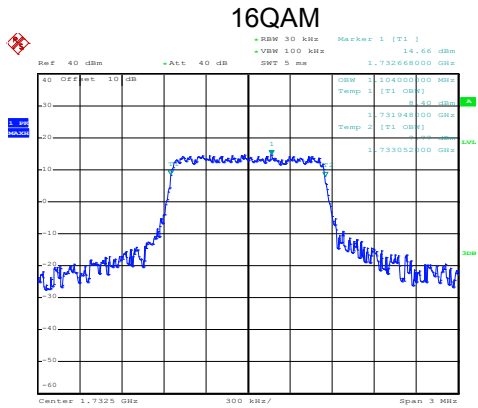

Date: 10.MAR.2019 13:26:48

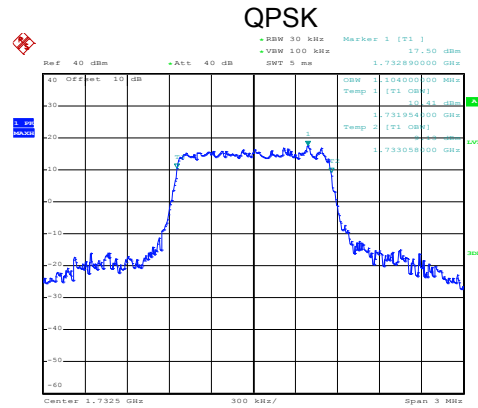

Date: 10.MAR.2019 13:26:41

Middle channel

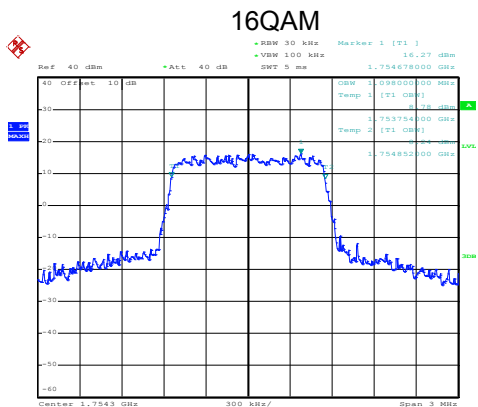

Date: 10.MAR.2019 13:27:55

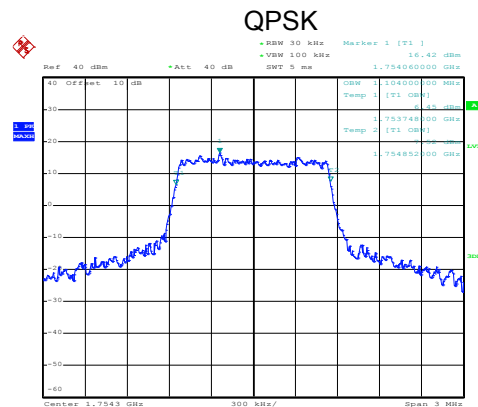

Date: 10.MAR.2019 13:27:49

Highest channel

LTE Band 4: 99% Occupancy bandwidth
BW: 3MHz

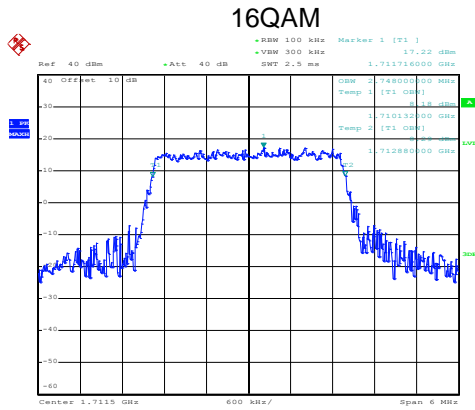

Date: 10.MAR.2019 13:34:20

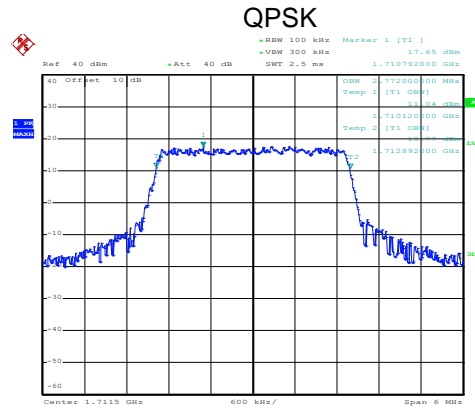

Date: 10.MAR.2019 13:34:14

Lowest channel

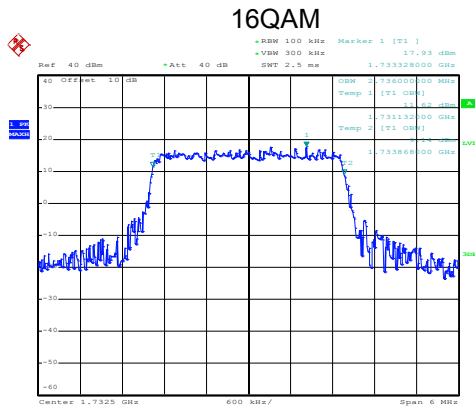

Date: 10.MAR.2019 13:33:49

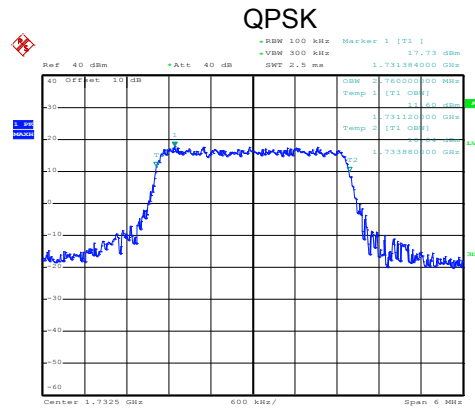

Date: 10.MAR.2019 13:33:43

Middle channel

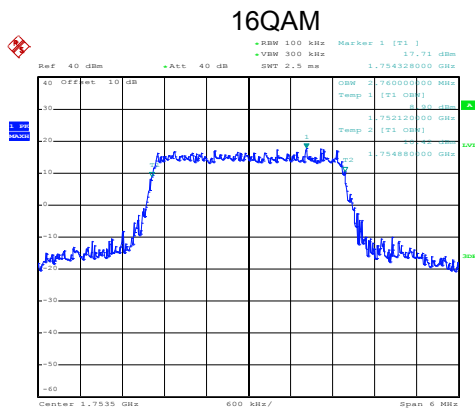

Date: 10.MAR.2019 13:32:47

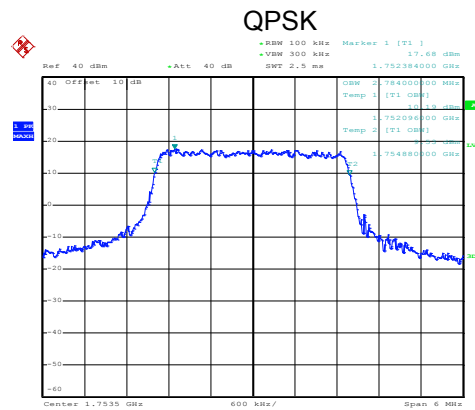

Date: 10.MAR.2019 13:32:40

Highest channel

LTE Band 4: 99% Occupancy bandwidth
BW: 5MHz

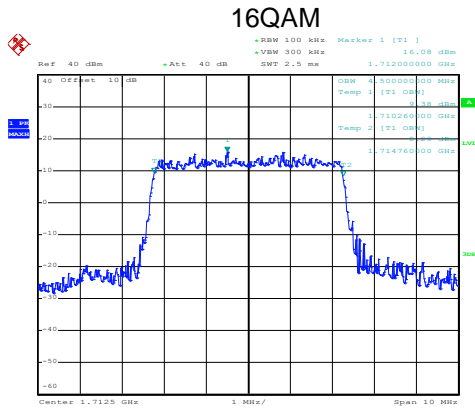

Date: 10.MAR.2019 13:35:43

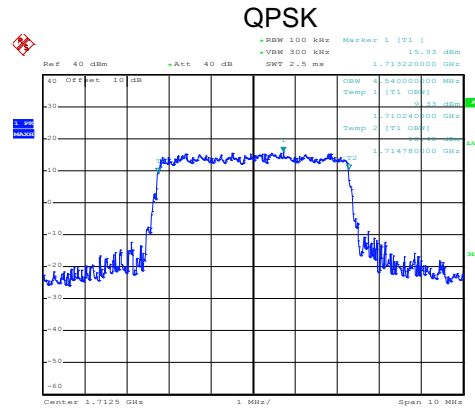

Date: 10.MAR.2019 13:35:36

Lowest channel

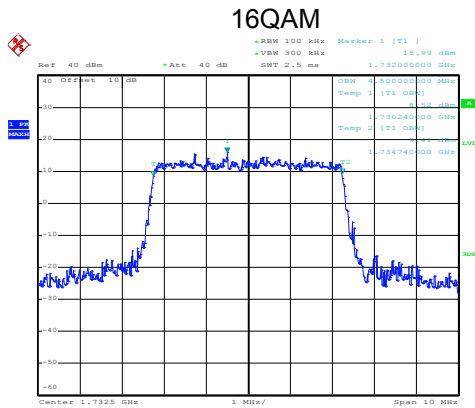

Date: 10.MAR.2019 13:36:08

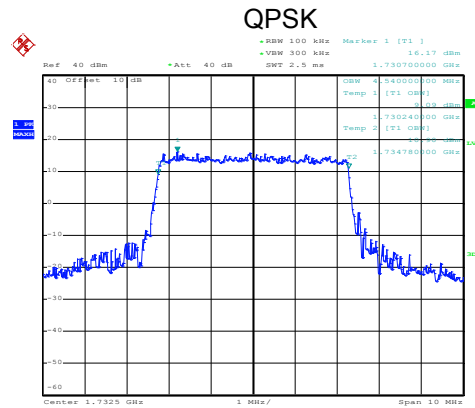

Date: 10.MAR.2019 13:36:02

Middle channel

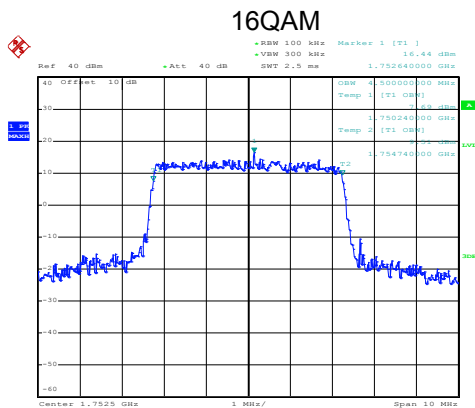

Date: 10.MAR.2019 13:37:11

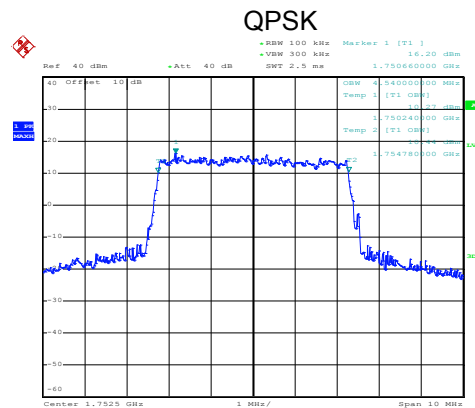

Date: 10.MAR.2019 13:37:05

Highest channel

LTE Band 4: 99% Occupy bandwidth
BW: 10MHz

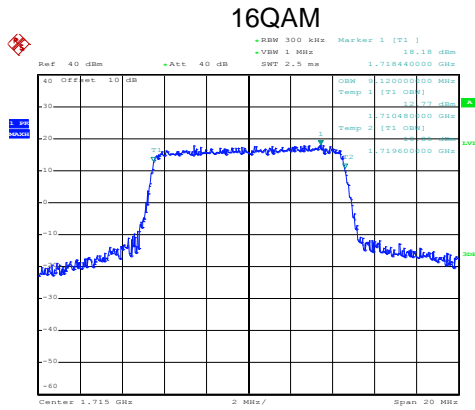

Date: 10.MAR.2019 13:14:24

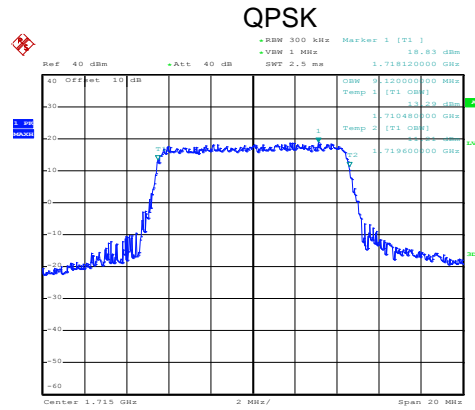

Date: 10.MAR.2019 13:14:14

Lowest channel

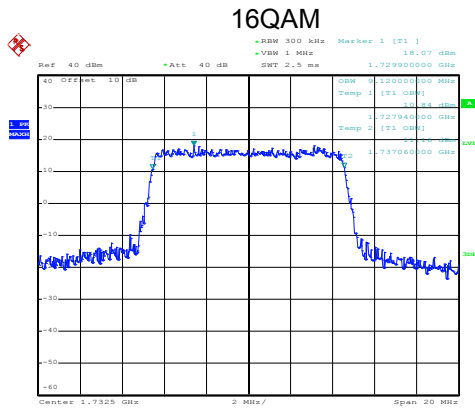

Date: 10.MAR.2019 13:13:15

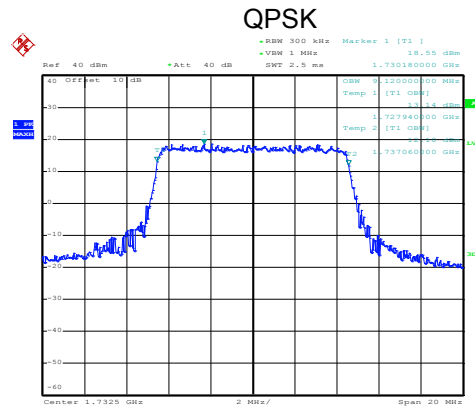

Date: 10.MAR.2019 13:13:06

Middle channel

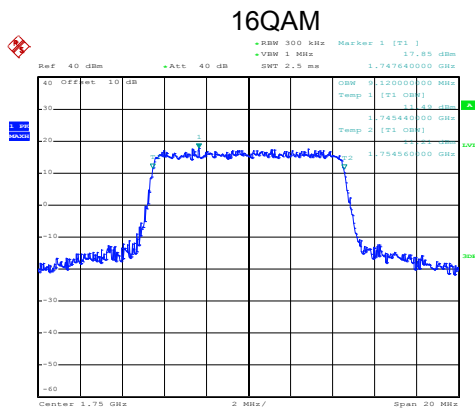

Date: 10.MAR.2019 13:12:32

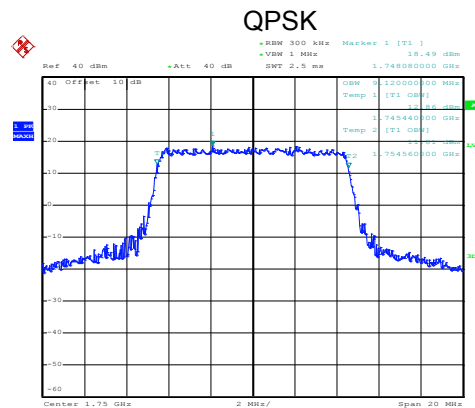

Date: 10.MAR.2019 13:12:22

Highest channel

LTE Band 4: 99% Occupancy bandwidth
BW: 15MHz

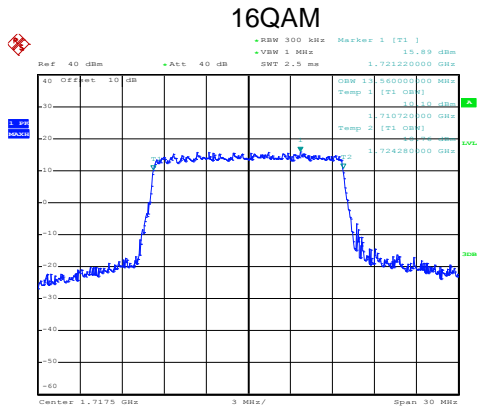

Date: 10.MAR.2019 13:08:48

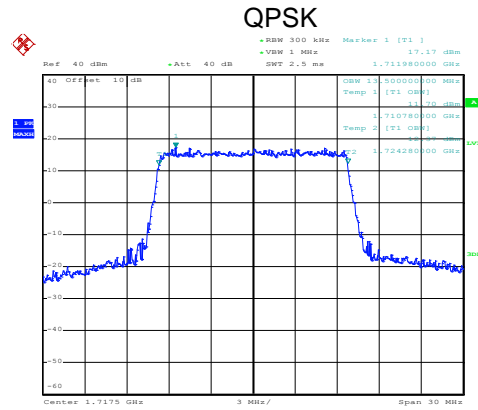

Date: 10.MAR.2019 13:08:39

Lowest channel

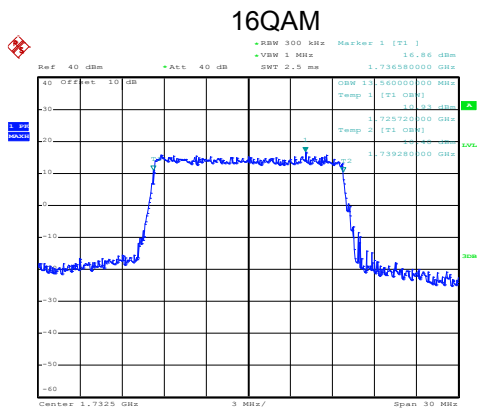

Date: 10.MAR.2019 13:09:57

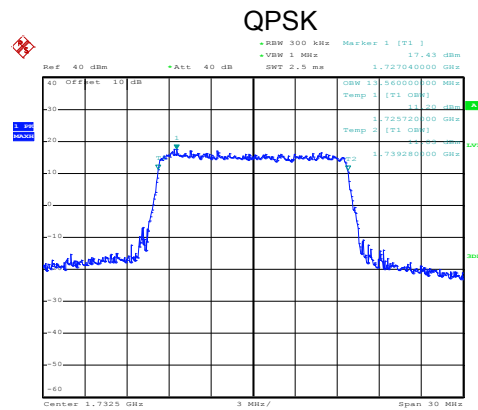

Date: 10.MAR.2019 13:09:48

Middle channel

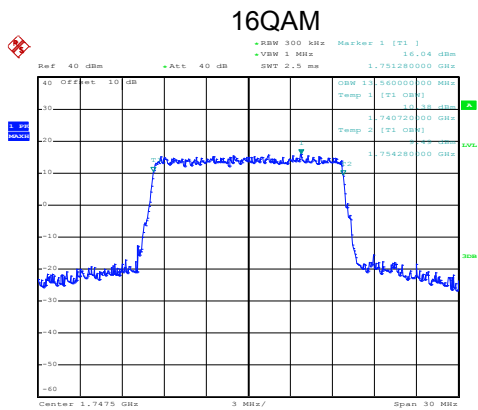

Date: 10.MAR.2019 13:10:27

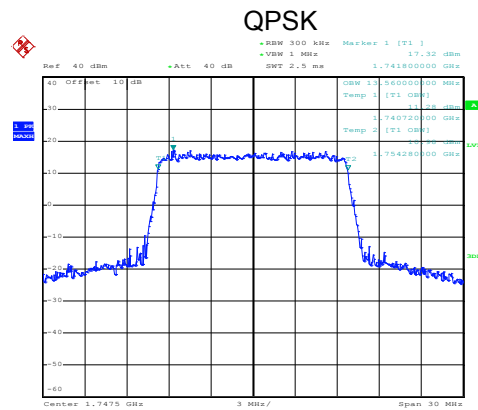

Date: 10.MAR.2019 13:10:18

Highest channel

LTE Band 4: 99% Occupy bandwidth
BW: 20MHz

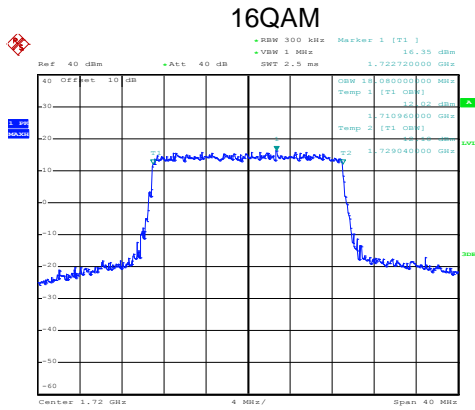

Date: 10.MAR.2019 13:06:47

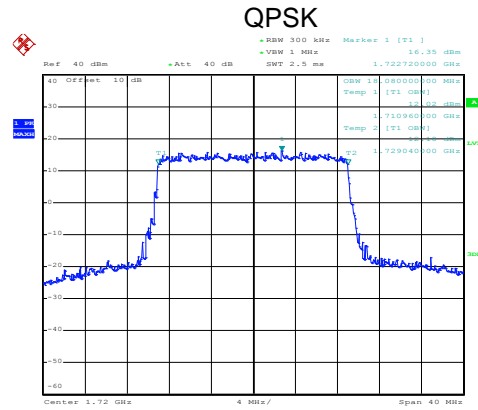

Date: 10.MAR.2019 13:06:38

Lowest channel

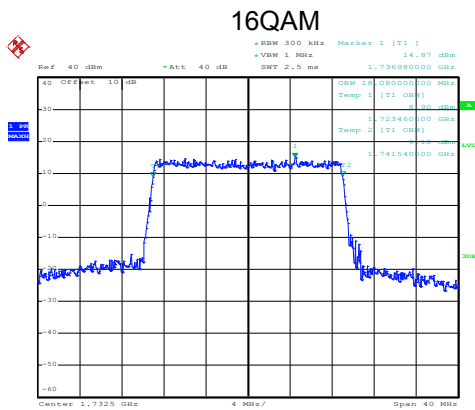

Date: 10.MAR.2019 13:05:29

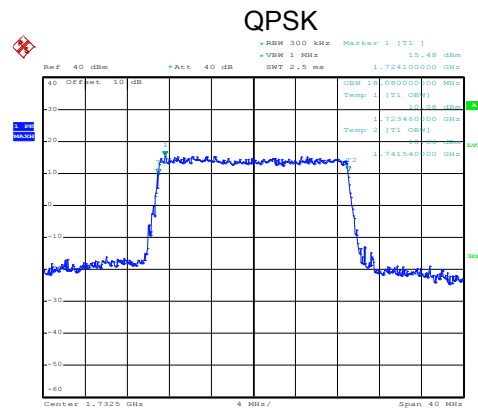

Date: 10.MAR.2019 13:05:20

Middle channel

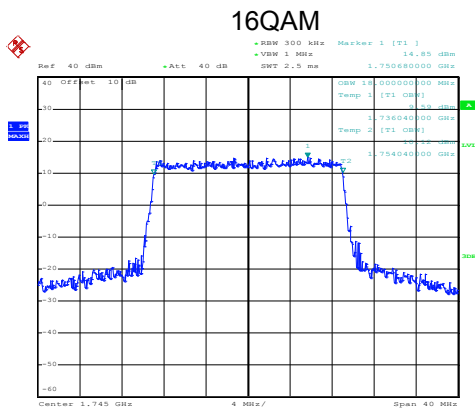

Date: 10.MAR.2019 13:04:52

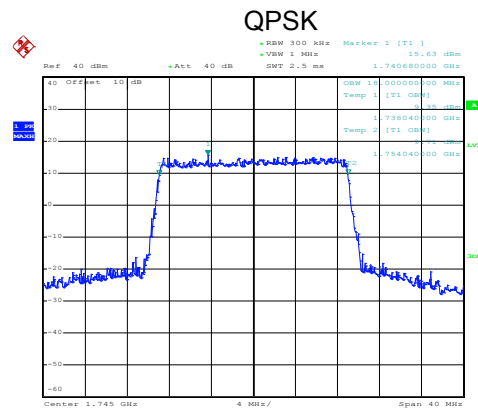

Date: 10.MAR.2019 13:04:44

Highest channel

LTE Band 4: -26dBc bandwidth
BW: 1.4MHz

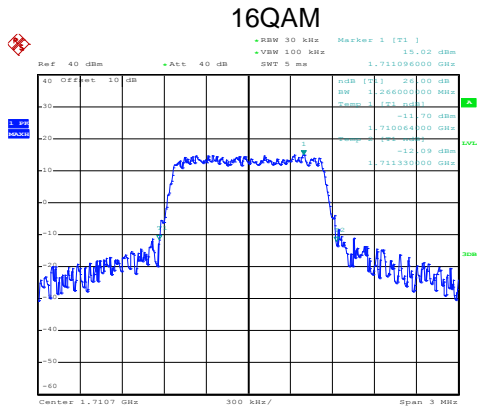

Date: 10.MAR.2019 13:25:57

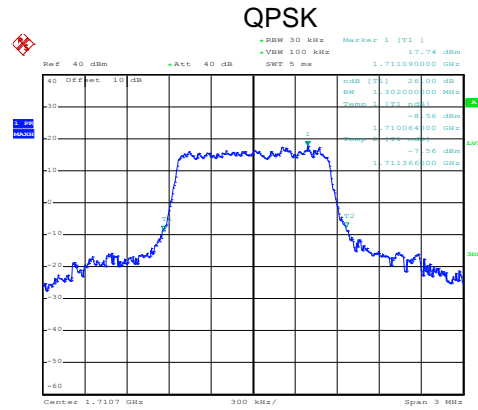

Date: 10.MAR.2019 13:25:51

Lowest channel

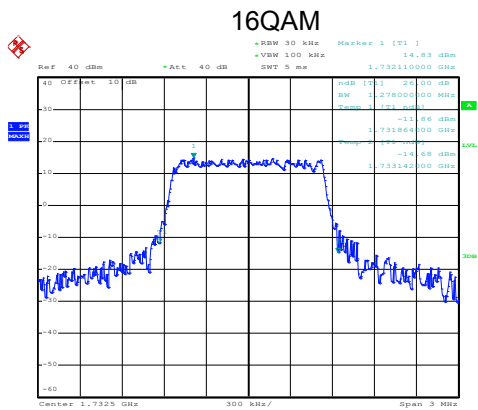

Date: 10.MAR.2019 13:27:12

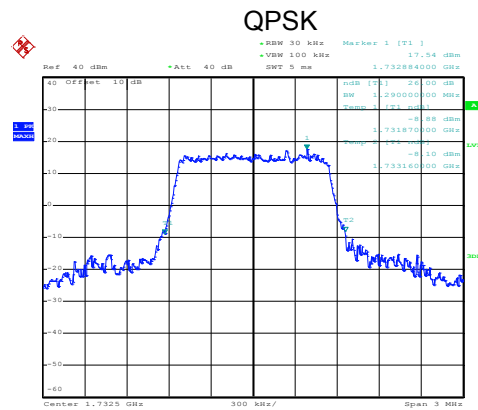

Date: 10.MAR.2019 13:27:06

Middle channel

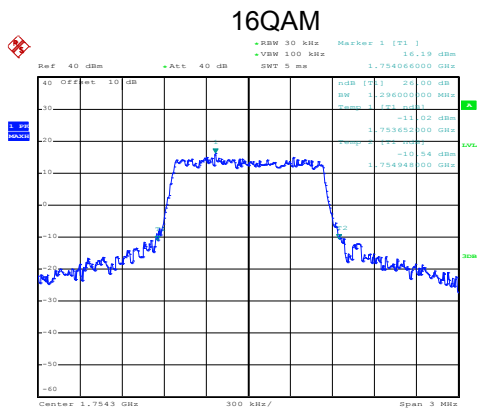

Date: 10.MAR.2019 13:27:39

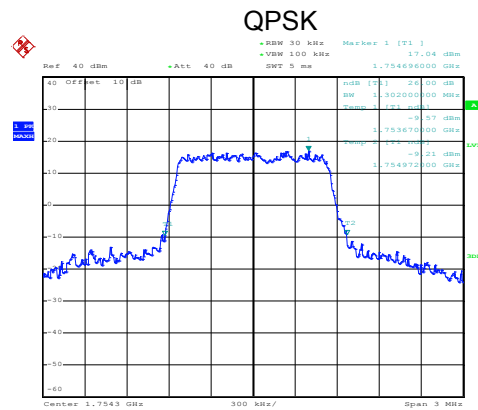

Date: 10.MAR.2019 13:27:32

Highest channel

LTE Band 4: -26dBc bandwidth
BW: 3MHz

16QAM

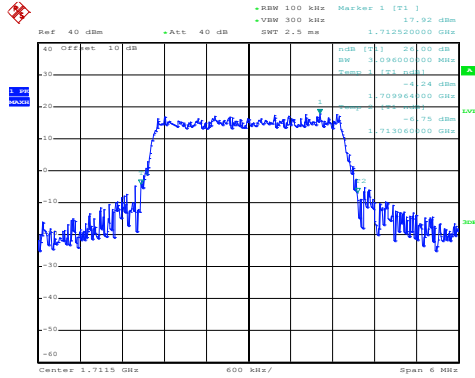

Date: 10.MAR.2019 13:34:38

QPSK

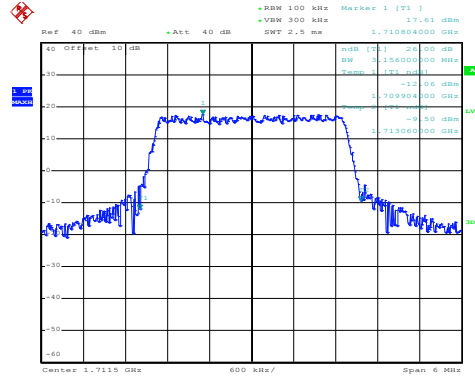

Date: 10.MAR.2019 13:34:31

Lowest channel

16QAM

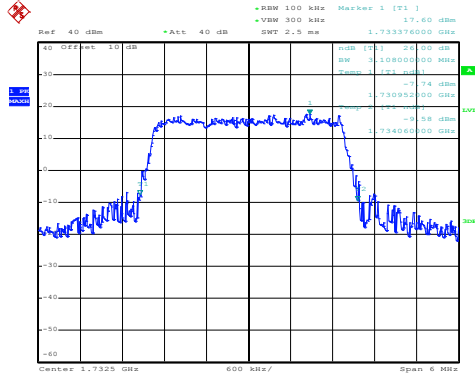

Date: 10.MAR.2019 13:33:32

QPSK

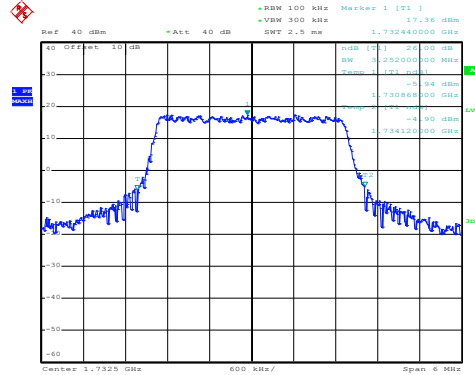

Date: 10.MAR.2019 13:33:24

Middle channel

16QAM

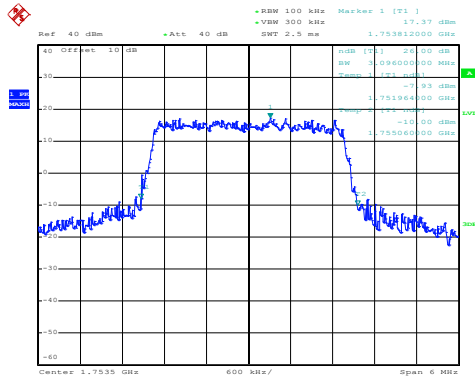

Date: 10.MAR.2019 13:33:04

QPSK

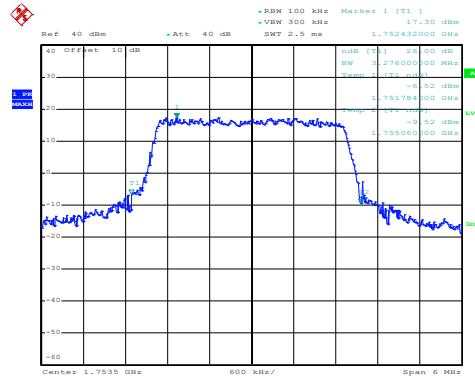

Date: 10.MAR.2019 13:32:58

Highest channel

LTE Band 4: -26dBc bandwidth
BW: 5MHz

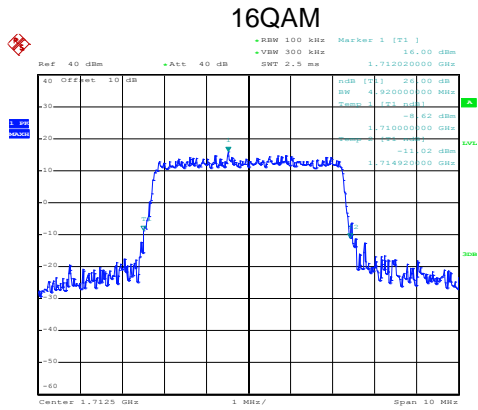

Date: 10.MAR.2019 13:35:26

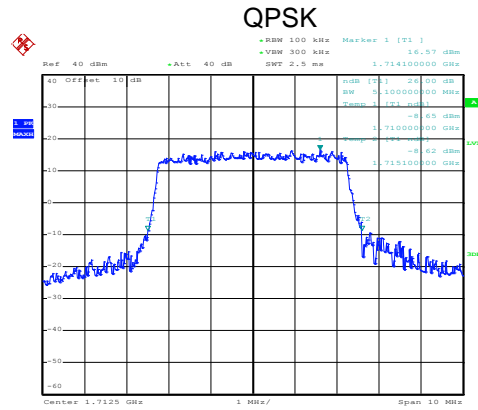

Date: 10.MAR.2019 13:35:20

Lowest channel

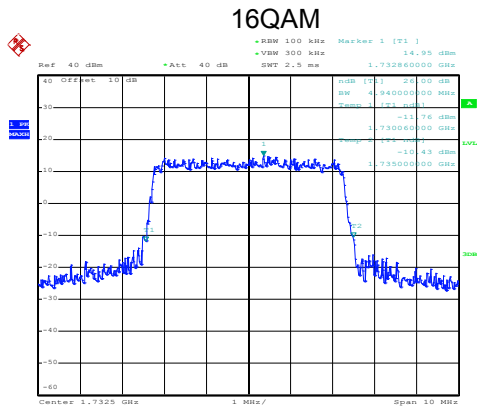

Date: 10.MAR.2019 13:36:24

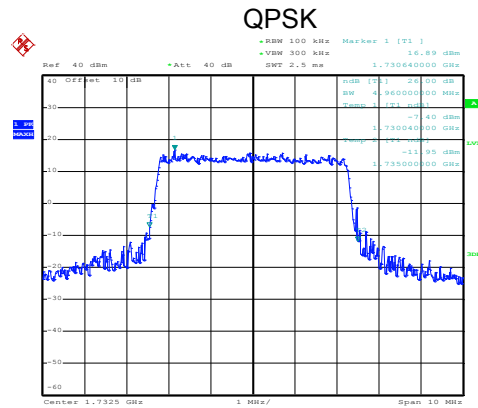

Date: 10.MAR.2019 13:36:19

Middle channel

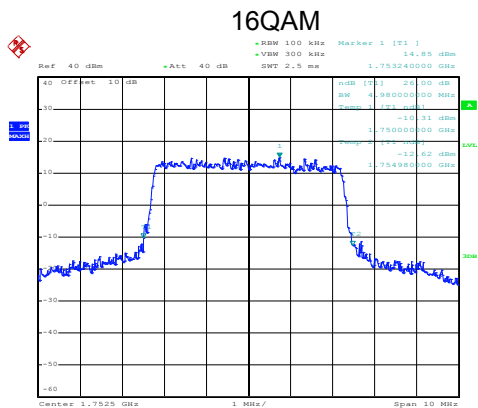

Date: 10.MAR.2019 13:36:53

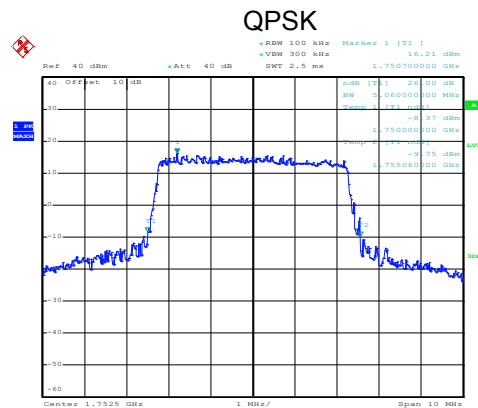

Date: 10.MAR.2019 13:36:46

Highest channel

LTE Band 4: -26dBc bandwidth
BW: 10MHz

16QAM

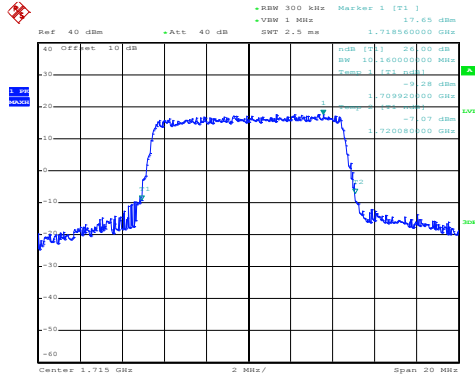

Date: 10.MAR.2019 13:14:04

QPSK

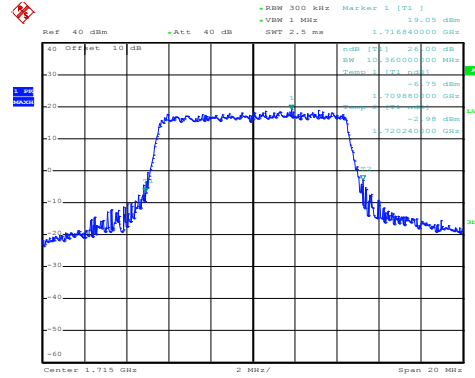

Date: 10.MAR.2019 13:13:56

Lowest channel

16QAM

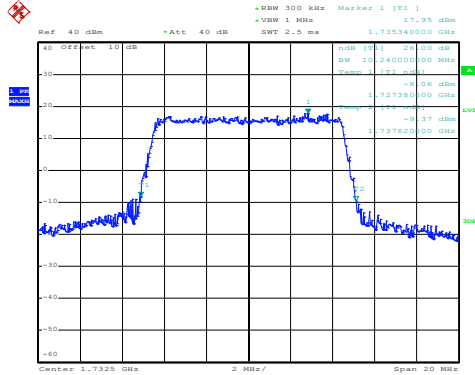

Date: 10.MAR.2019 13:13:38

QPSK

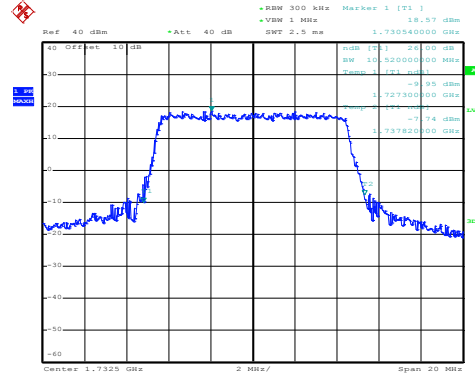

Date: 10.MAR.2019 13:13:30

Middle channel

16QAM

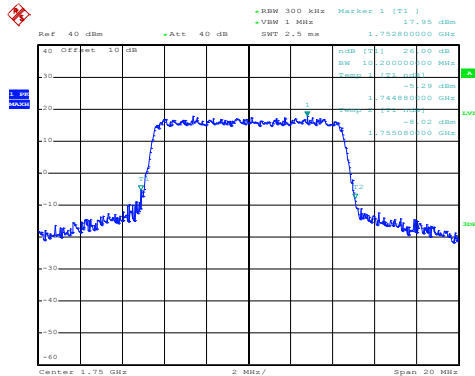

Date: 10.MAR.2019 13:12:07

QPSK

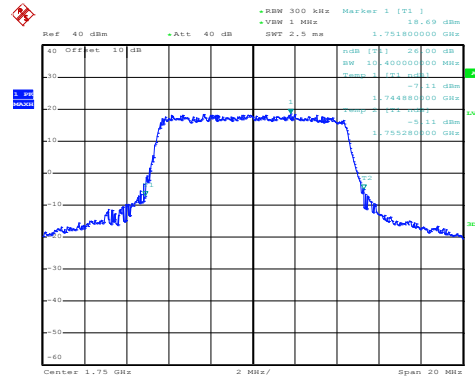

Date: 10.MAR.2019 13:11:56

Highest channel

LTE Band 4: -26dBc bandwidth
BW: 15MHz

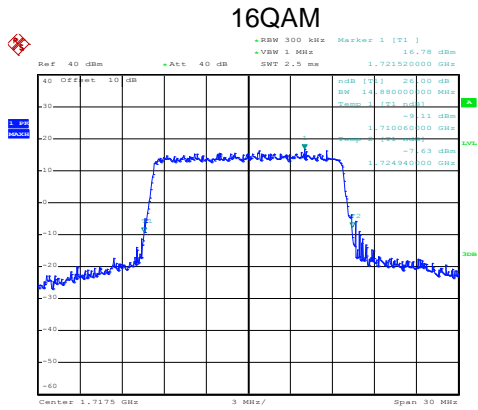

Date: 10.MAR.2019 13:09:07

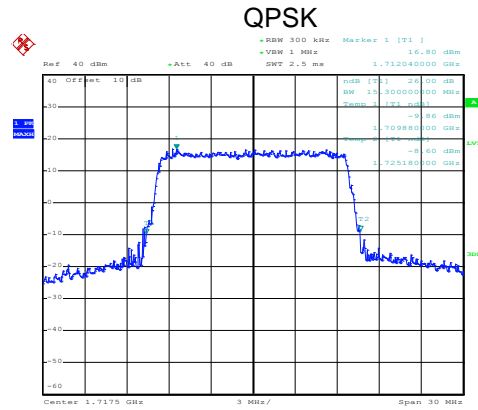

Date: 10.MAR.2019 13:08:59

Lowest channel

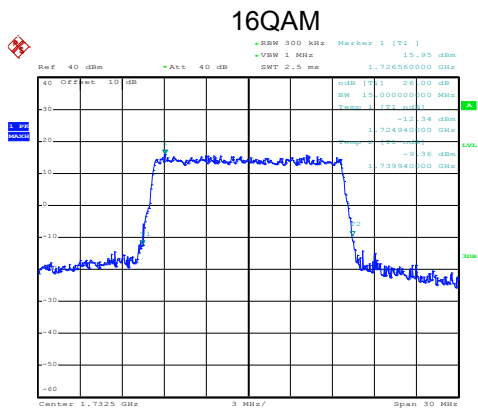

Date: 10.MAR.2019 13:09:35

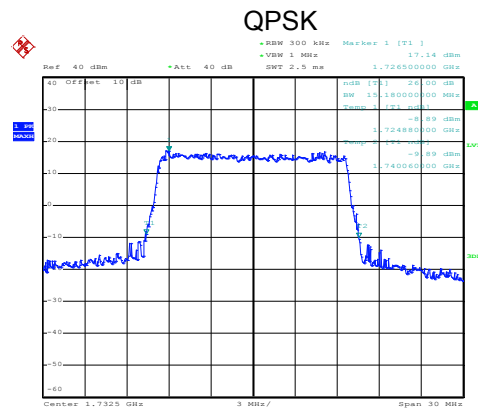

Date: 10.MAR.2019 13:09:26

Middle channel

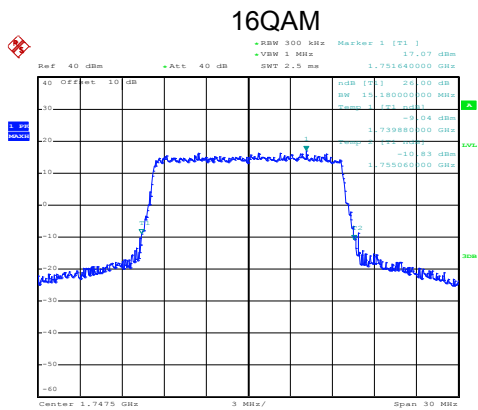

Date: 10.MAR.2019 13:10:59

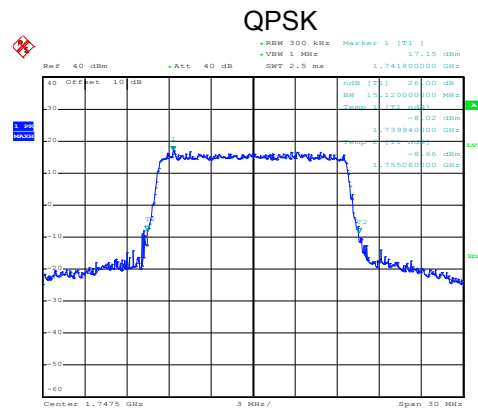

Date: 10.MAR.2019 13:10:42

Highest channel

LTE Band 4: -26dBc bandwidth
BW: 20MHz

16QAM

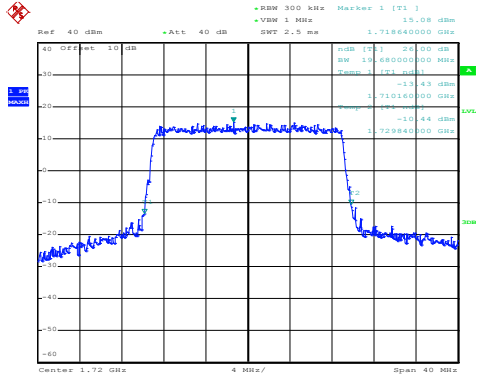

Date: 10.MAR.2019 13:06:23

QPSK

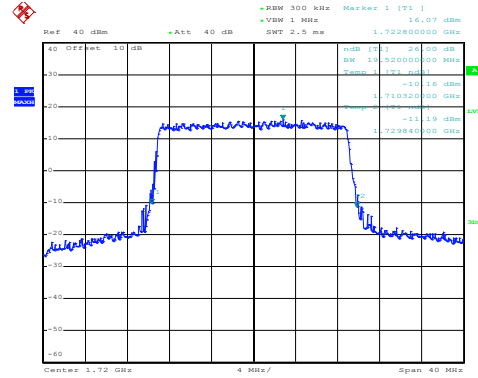

Date: 10.MAR.2019 13:06:15

Lowest channel

16QAM

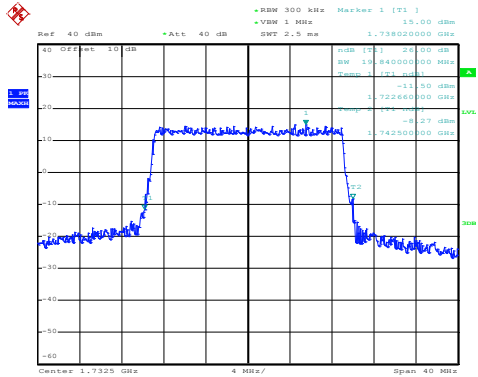

Date: 10.MAR.2019 13:05:52

QPSK

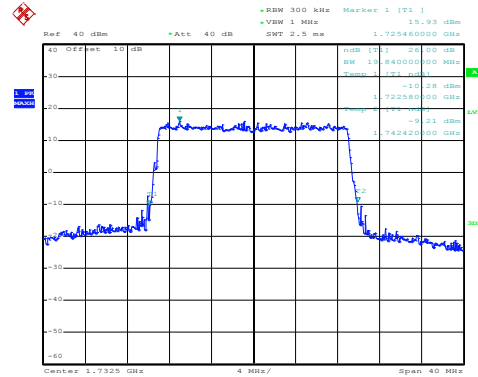

Date: 10.MAR.2019 13:05:44

Middle channel

16QAM

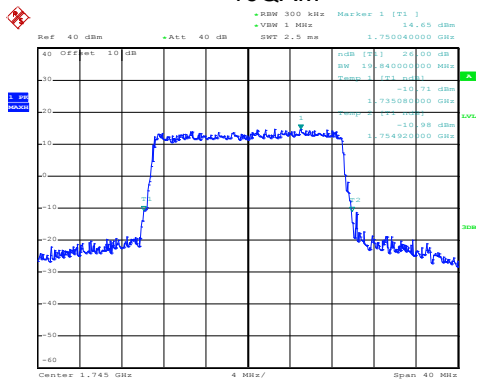

Date: 10.MAR.2019 13:04:19

QPSK

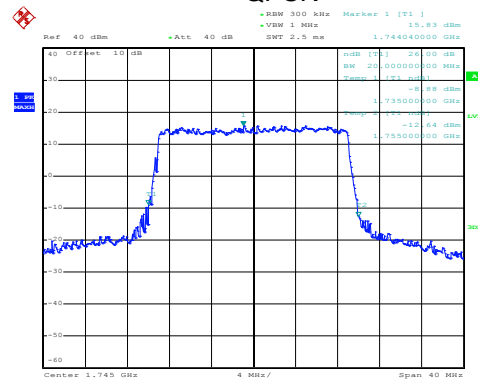

Date: 10.MAR.2019 13:04:09

Highest channel

LTE-Band 7 part:

LTE Band 7: 99% Occupy bandwidth
BW: 5MHz

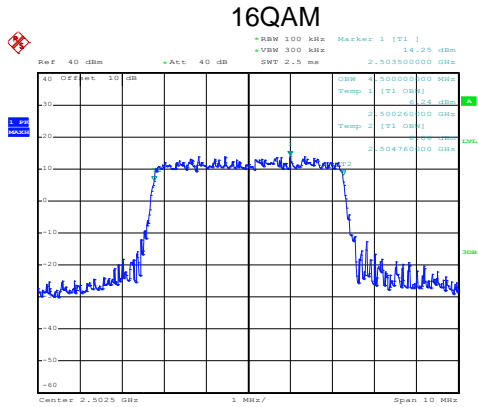

Date: 10.MAR.2019 13:20:08

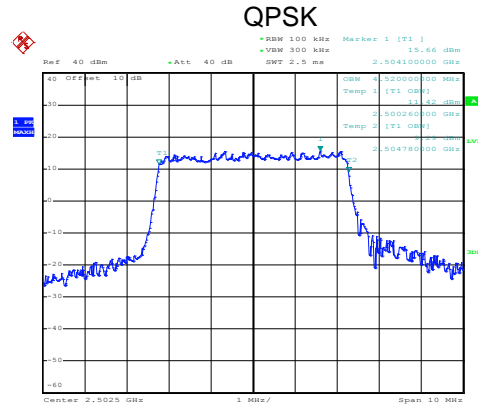

Date: 10.MAR.2019 13:19:59

Lowest channel

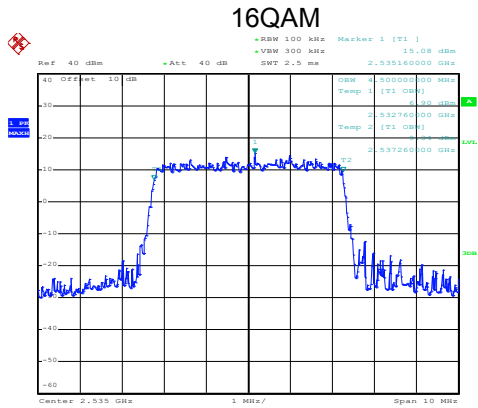

Date: 10.MAR.2019 13:21:13

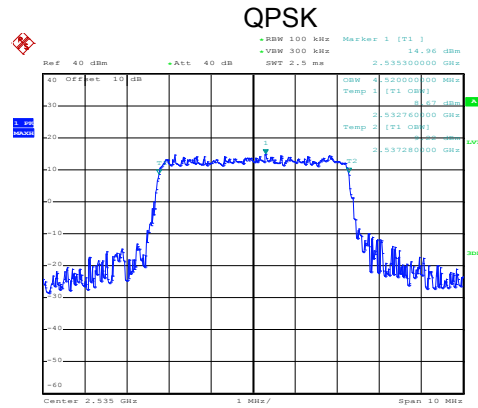

Date: 10.MAR.2019 13:21:06

Middle channel

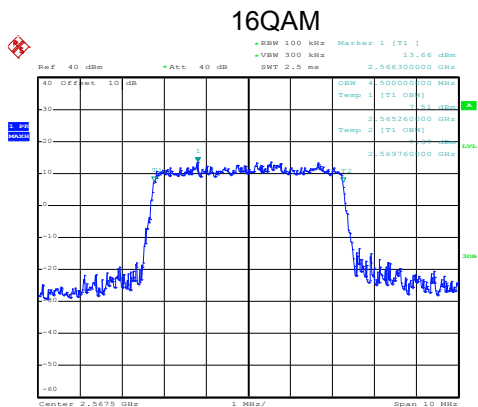

Date: 10.MAR.2019 13:22:17

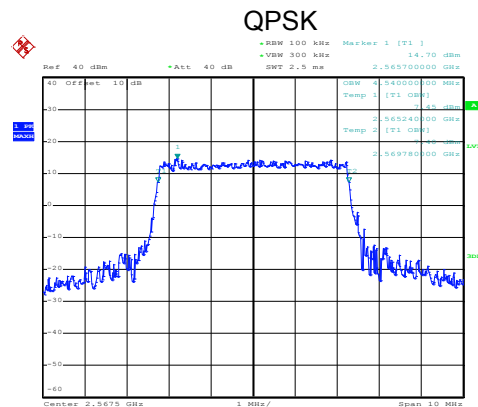

Date: 10.MAR.2019 13:22:12

Highest channel

LTE Band 7: 99% Occupancy bandwidth
BW: 10MHz

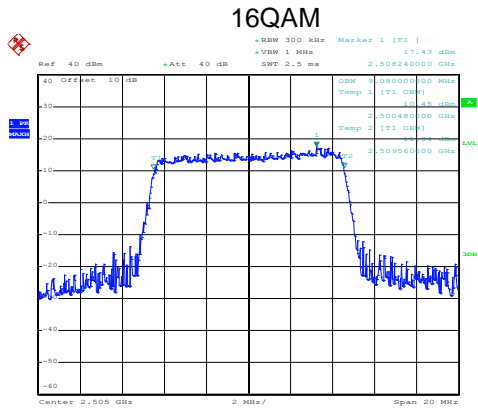

Date: 10.MAR.2019 13:25:15

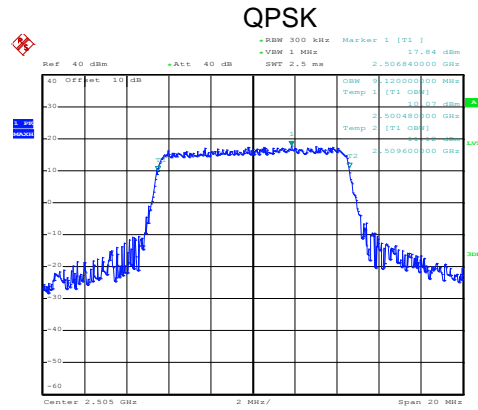

Date: 10.MAR.2019 13:25:10

Lowest channel

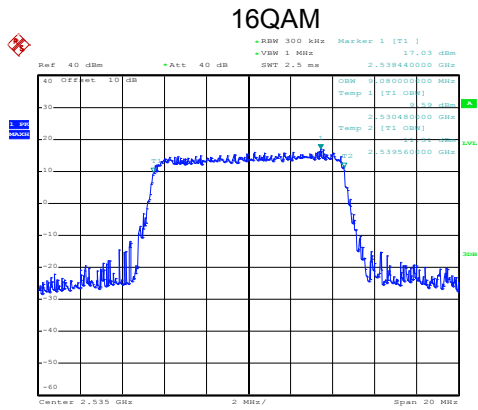

Date: 10.MAR.2019 13:24:51

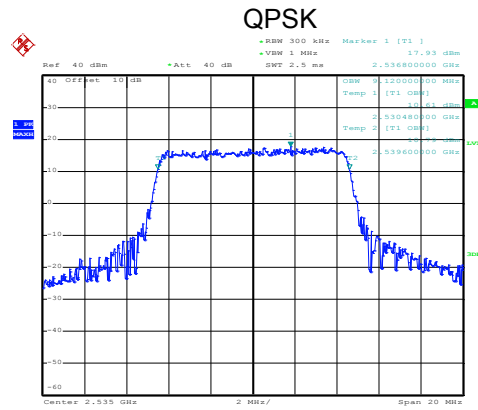

Date: 10.MAR.2019 13:24:45

Middle channel

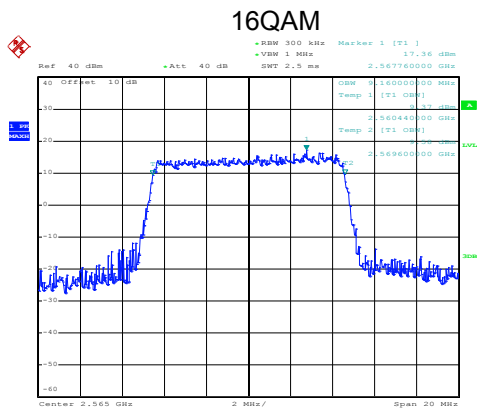

Date: 10.MAR.2019 13:23:20

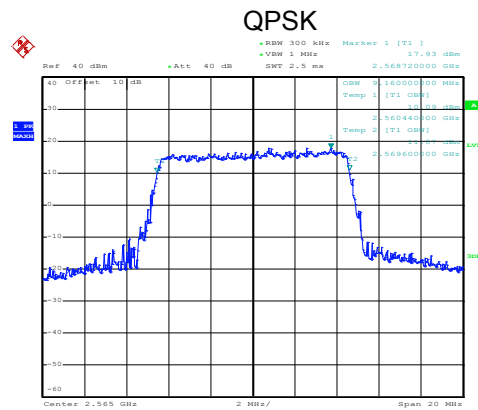

Date: 10.MAR.2019 13:23:15

Highest channel

LTE Band 7: 99% Occupy bandwidth
BW: 15MHz

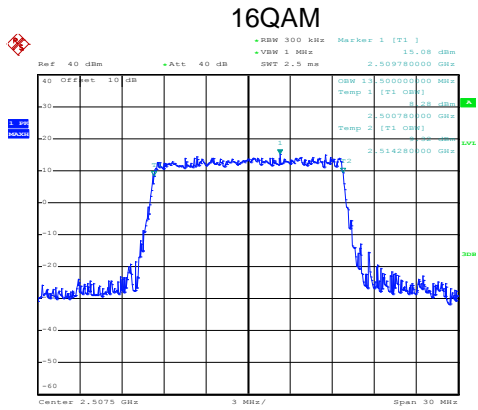

Date: 10.MAR.2019 13:26:37

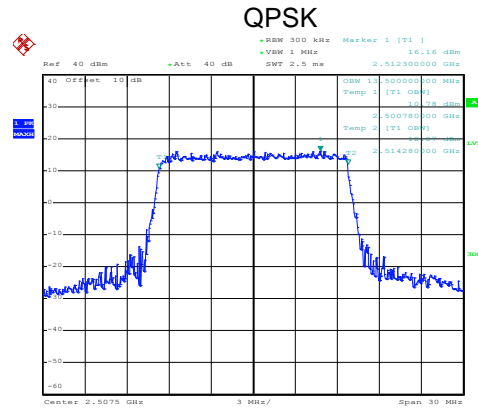

Date: 10.MAR.2019 13:26:30

Lowest channel

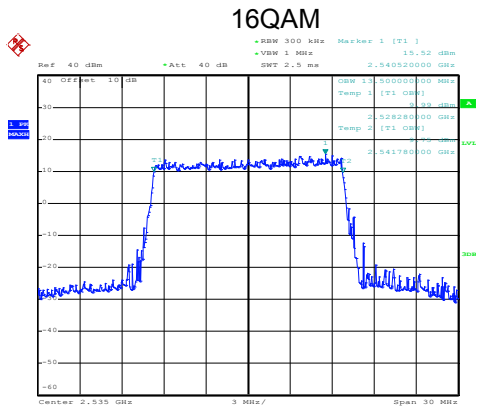

Date: 10.MAR.2019 13:27:01

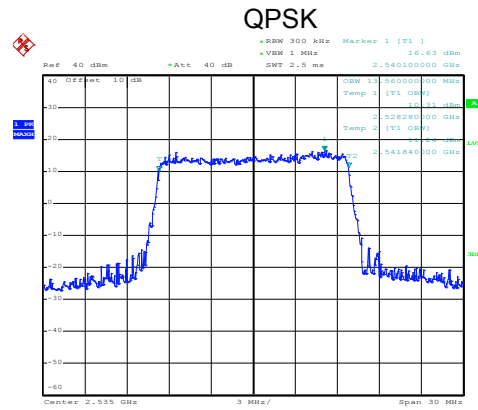

Date: 10.MAR.2019 13:26:56

Middle channel

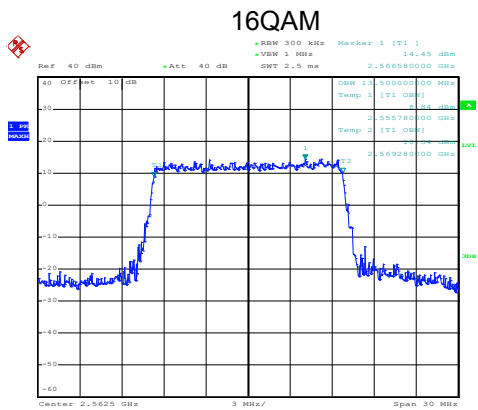

Date: 10.MAR.2019 13:28:09

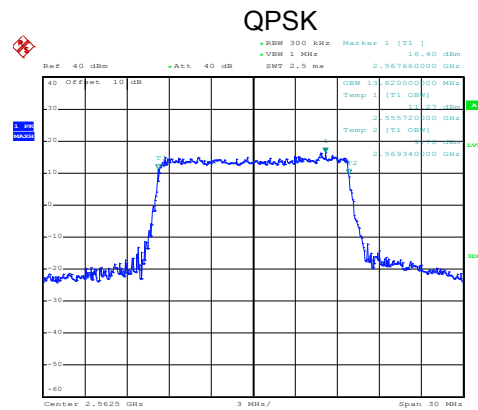

Date: 10.MAR.2019 13:28:03

Highest channel

LTE Band 7: 99% Occupy bandwidth
BW: 20MHz

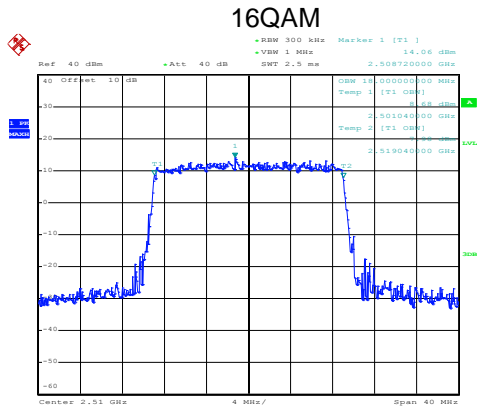

Date: 10.MAR.2019 13:30:43

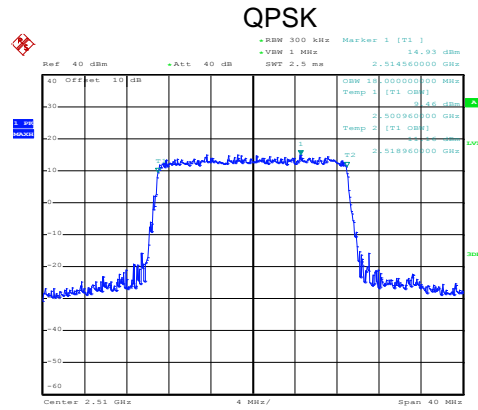

Date: 10.MAR.2019 13:30:37

Lowest channel

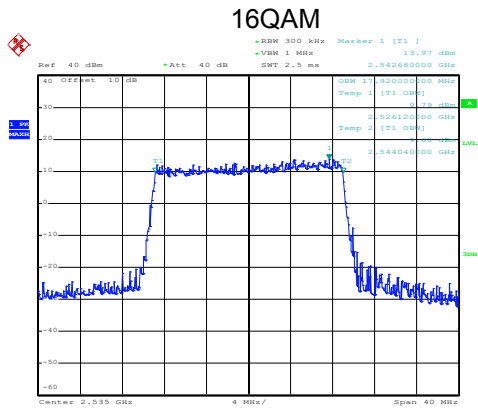

Date: 10.MAR.2019 13:29:22

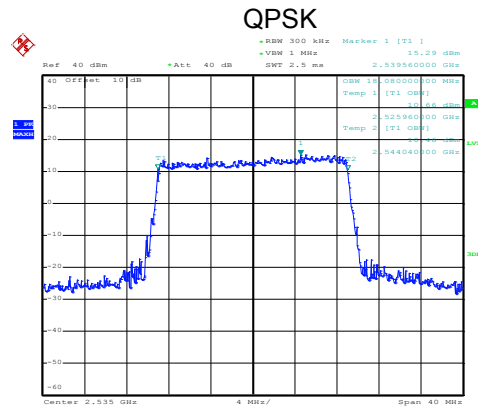

Date: 10.MAR.2019 13:29:16

Middle channel

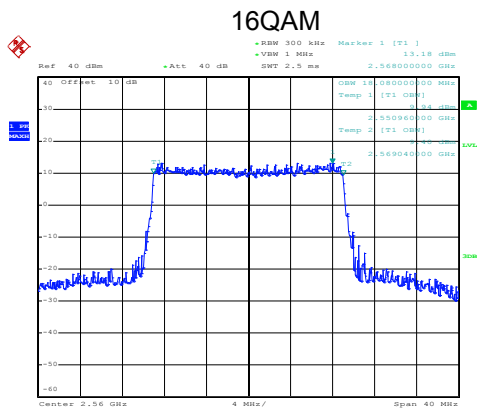

Date: 10.MAR.2019 13:28:55

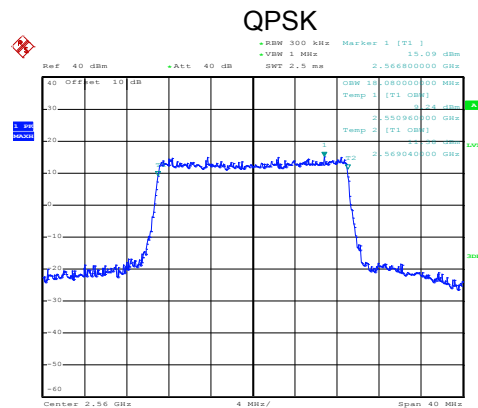

Date: 10.MAR.2019 13:28:49

Highest channel

LTE Band 7: -26dBc bandwidth
BW: 5MHz

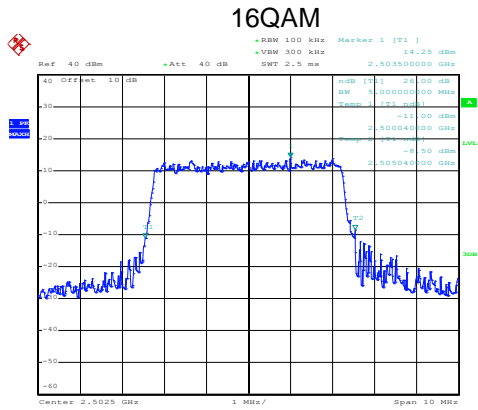

Date: 10.MAR.2019 13:20:32

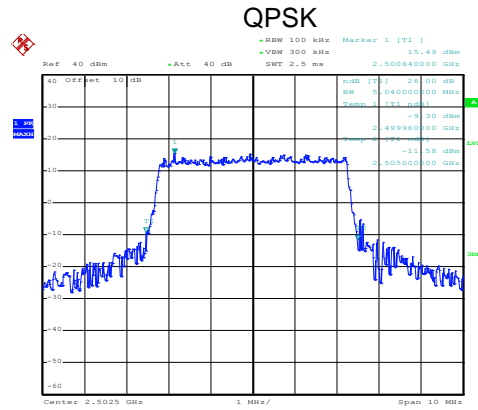

Date: 10.MAR.2019 13:20:25

Lowest channel

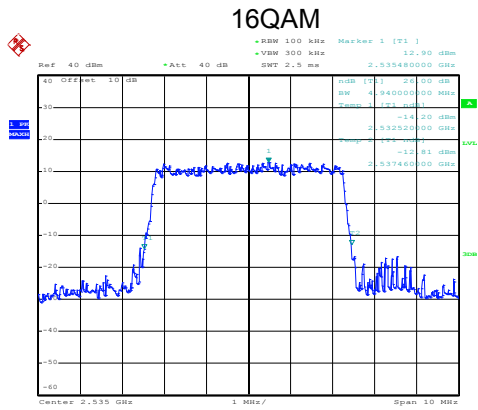

Date: 10.MAR.2019 13:20:53

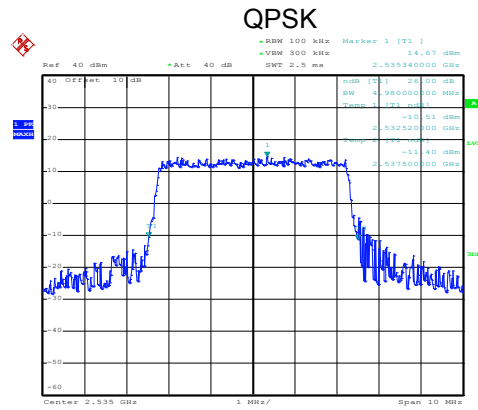

Date: 10.MAR.2019 13:20:48

Middle channel

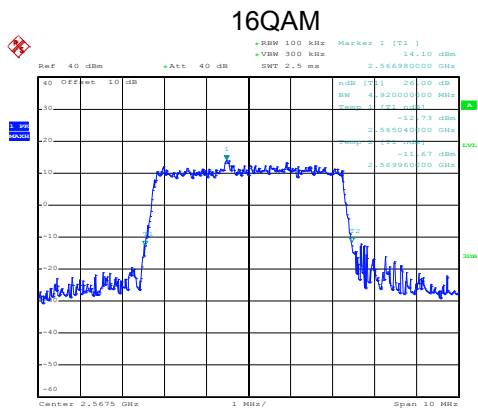

Date: 10.MAR.2019 13:22:01

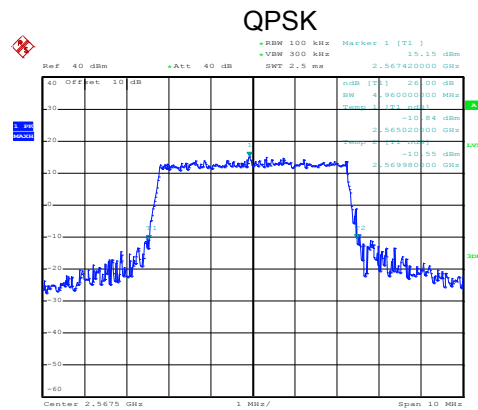

Date: 10.MAR.2019 13:21:54

Highest channel

LTE Band 7: -26dBc bandwidth
BW: 10MHz

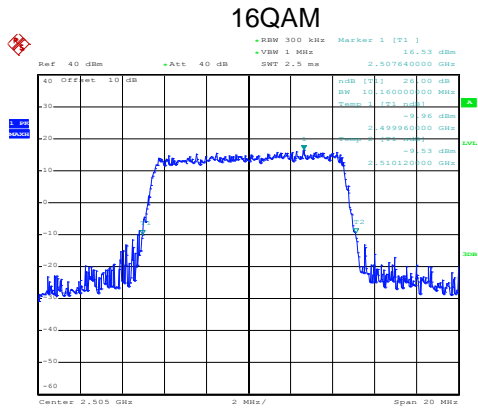

Date: 10.MAR.2019 13:25:32

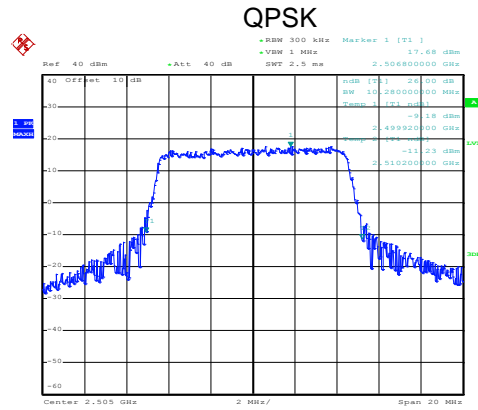

Date: 10.MAR.2019 13:25:26

Lowest channel

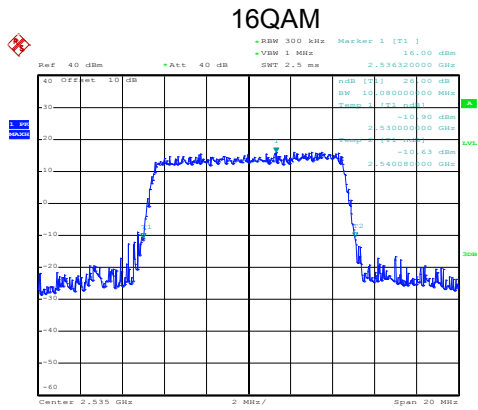

Date: 10.MAR.2019 13:24:30

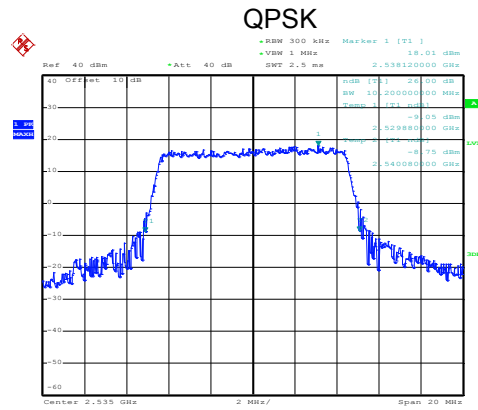

Date: 10.MAR.2019 13:24:25

Middle channel

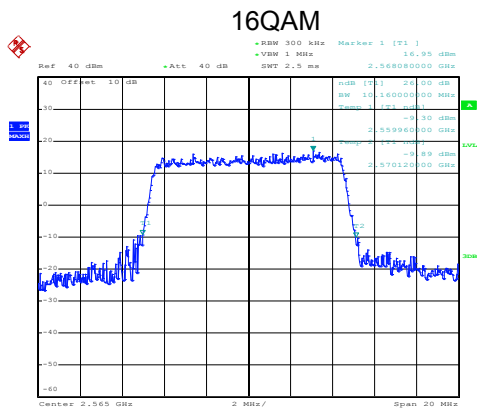

Date: 10.MAR.2019 13:23:39

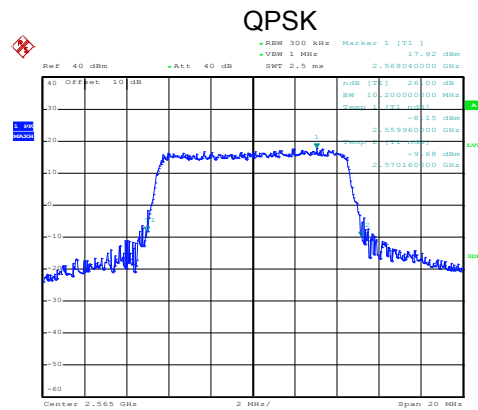

Date: 10.MAR.2019 13:23:33

Highest channel

LTE Band 7: -26dBc bandwidth
BW: 15MHz

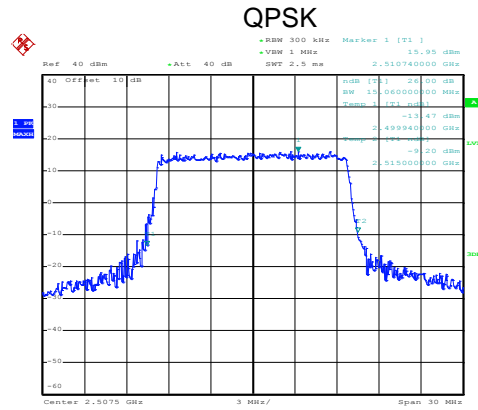
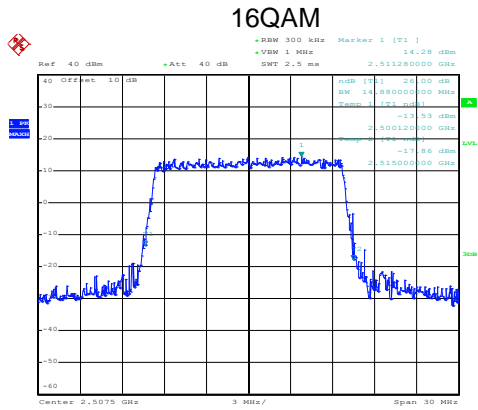

Date: 10.MAR.2019 13:26:20

Date: 10.MAR.2019 13:26:13

Lowest channel

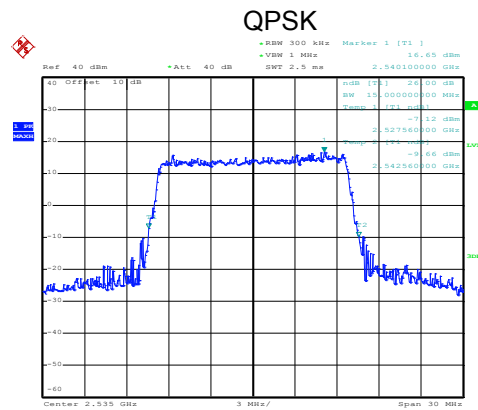
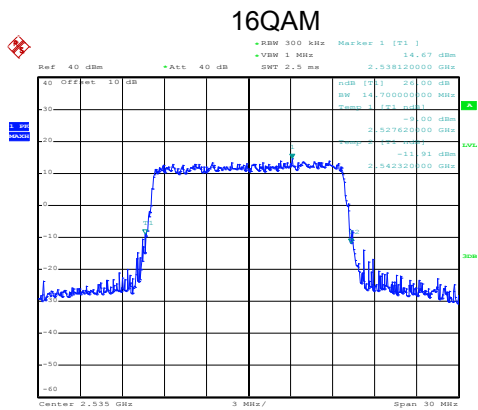

Date: 10.MAR.2019 13:27:19

Date: 10.MAR.2019 13:27:11

Middle channel

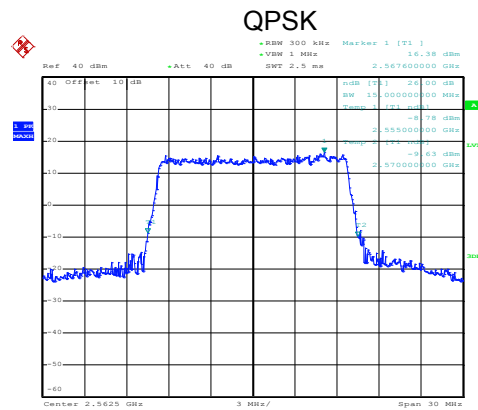
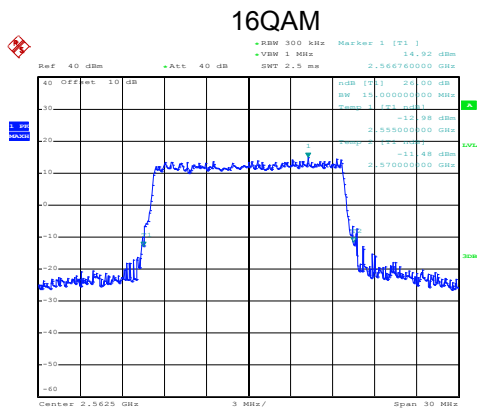

Date: 10.MAR.2019 13:27:48

Date: 10.MAR.2019 13:27:41

Highest channel

LTE Band 7: -26dBc bandwidth
BW: 20MHz

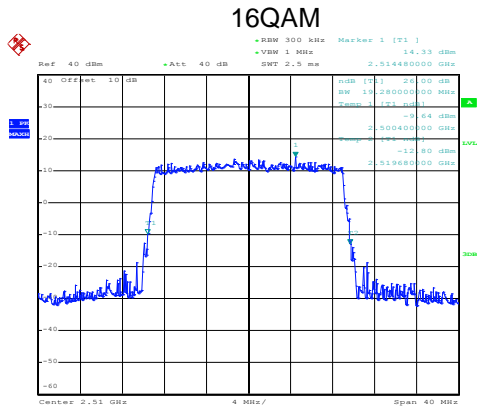

Date: 10.MAR.2019 13:30:27

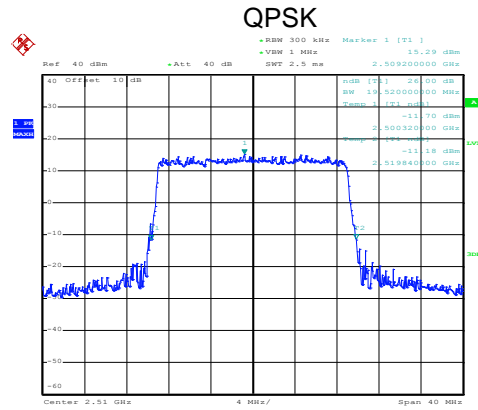

Date: 10.MAR.2019 13:30:21

Lowest channel

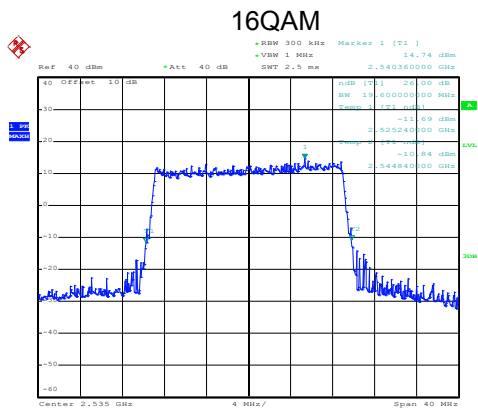

Date: 10.MAR.2019 13:29:37

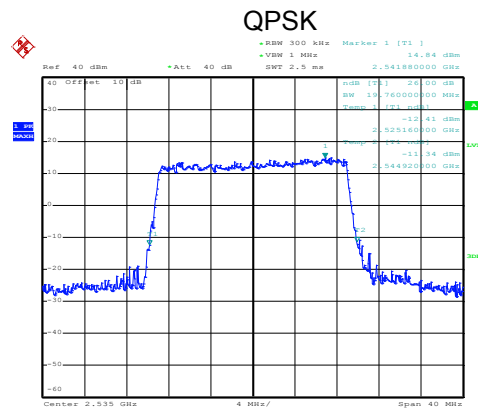

Date: 10.MAR.2019 13:29:32

Middle channel

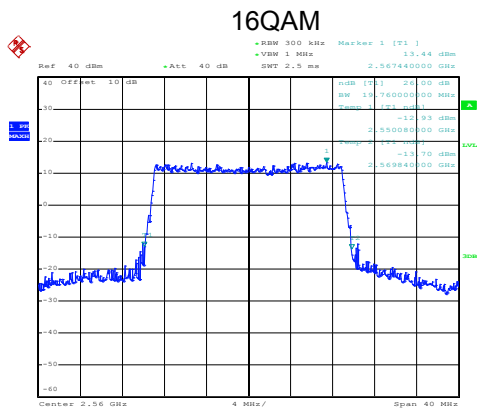

Date: 10.MAR.2019 13:30:03

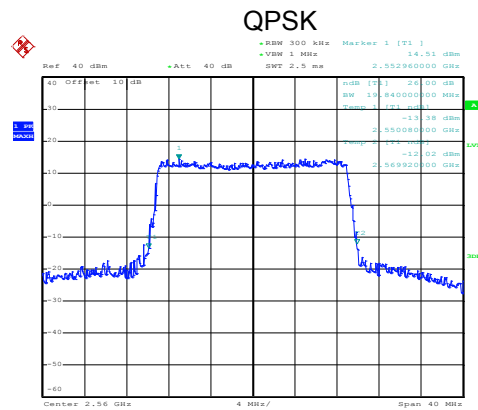

Date: 10.MAR.2019 13:29:54

Highest channel

6.4 Out of band emission at antenna terminals

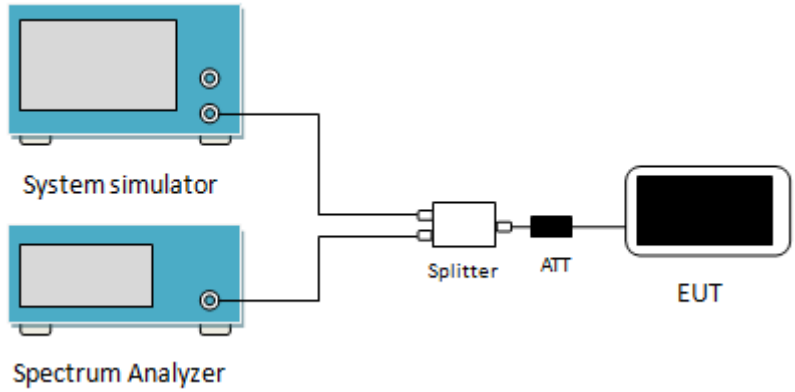
Test Requirement:	Part 24.238 (a), part 27.53(h), Part 27.53(m)
Test Method:	ANSI/TIA-603-D 2010
Limit:	<p>LTE Band 2 & 4 & 5 & 12 & 17: The power of any emission outside a licensee's frequency block shall be attenuated below the transmitter power (P) in watts by at least $43 + 10 \log_{10}(P)$ dB (-13 dBm).</p> <p>LTE Band 7: For mobile digital stations, the attenuation factor shall be not less than $40 + 10 \log(P)$ dB on all frequencies between the channel edge and 5 megahertz from the channel edge, $43 + 10 \log(P)$ dB on all frequencies between 5 megahertz and X megahertz from the channel edge, and $55 + 10 \log(P)$ dB on all frequencies more than X megahertz from the channel edge, where X is the greater of 6 megahertz or the actual emission bandwidth as defined in paragraph (m)(6) of this section. In addition, the attenuation factor shall not be less that $43 + 10 \log(P)$ dB on all frequencies between 2490.5 MHz and 2496 MHz and $55 + 10 \log(P)$ dB at or below 2490.5 MHz.</p>
Test Setup:	 <p>The diagram illustrates the test setup. On the left, there are two blue rectangular units: the top one is labeled 'System simulator' and the bottom one is labeled 'Spectrum Analyzer'. Both have a screen and two circular ports on the right side. A single line connects the two ports of the System simulator to the top port of a white 'Splitter' box. Another line connects the two ports of the Spectrum Analyzer to the bottom port of the Splitter. From the right side of the Splitter, a line goes to a black rectangular 'ATT' (attenuator) block. Finally, a line connects the right side of the ATT to the left side of a black rectangular 'EUT' (Equipment Under Test) device.</p>
Test Procedure:	<ol style="list-style-type: none"> 1 The RF output of the transceiver was connected to a spectrum analyzer through appropriate attenuation. 2 The resolution bandwidth of the spectrum analyzer was set at 100 kHz when below 1GHz, 1MHz when above 1 GHz; sufficient scans were taken to show the out of band Emissions if any up to 10th harmonic. 3 For the out of band: Set the RBW=100 kHz, VBW=300 kHz when below 1 GHz, RBW =1 MHz, VBW=3 MHz when above 1 GHz, Start=30MHz, Stop= 10th harmonic. 4 Band Edge Requirements: In the 1 MHz bands immediately outside and adjacent to the frequency block, a resolution bandwidth of at least 1 percent of the emission bandwidth of the fundamental emission of the transmitter may be employed to measure the out of band Emissions.
Test Instruments:	Refer to section 5.9 for details
Test mode:	Refer to section 5.3 for details
Test results:	Passed
Remark:	Pre-scan all RB Size and offset, and found the RB Size and offset of worst case, so the report shows only the worst case test data.