

# FCC SAR

## Measurement and Test Report

For

### PCD, LLC.

1500 Tradeport Drive, Suite A. Orlando, FL.

**FCC ID: 2ALJJPL5003**

<b>Test Standards:</b>	FCC Part 2.1093 ANSI / IEEE C95.1 :2005 ANSI / IEEE C95.3 :2002 <u>IEEE 1528 :2013</u>
<b>Product Description:</b>	<u>Monkey II LTE</u>
<b>Tested Model:</b>	<u>PL5003</u>
<b>Report No.:</b>	<u>STR17088335H</u>
<b>Tested Date:</b>	<u>2017-08-21 to 2017-09-01</u>
<b>Issued Date:</b>	<u>2017-09-01</u>
<b>Tested By:</b>	<u>Lucy Wei / Engineer</u>
<b>Reviewed By:</b>	<u>Silin Chen / EMC Manager</u>
<b>Approved &amp; Authorized By:</b>	<u>Jandy So / PSQ Manager</u>
<b>Prepared By:</b>	

*Lucy Wei*

*Silin Chen*

*Jandy So*

**Shenzhen SEM Test Technology Co., Ltd.**

1/F, Building A, Hongwei Industrial Park, Liuxian 2nd Road,  
Bao'an District, Shenzhen, P.R.C. (518101)

Tel.: +86-755-33663308 Fax.: +86-755-33663309 Website: www.semtest.com.cn

Note: This test report is limited to the above client company and the product model only. It may not be duplicated without prior permitted by Shenzhen SEM Test Technology Co., Ltd.

## **TABLE OF CONTENTS**

<b>1. General Information</b>	<b>3</b>
1.1 Product Description for Equipment Under Test (EUT)	3
1.2 Test Standards	6
1.3 Test Methodology	6
1.4 Test Facility	6
<b>2. Summary of Test Results</b>	<b>7</b>
<b>3. Specific Absorption Rate (SAR)</b>	<b>8</b>
3.1 Introduction	8
3.2 SAR Definition	8
<b>4. SAR Measurement System</b>	<b>9</b>
4.1 The Measurement System	9
4.2 Probe	9
4.3 Probe Calibration Process	11
4.4 Phantom	12
4.5 Device Holder	12
4.6 Test Equipment List	13
<b>5. Tissue Simulating Liquids</b>	<b>14</b>
5.1 Composition of Tissue Simulating Liquid	14
5.2 Tissue Dielectric Parameters for Head and Body Phantoms	15
5.3 Tissue Calibration Result	16
<b>6. SAR Measurement Evaluation</b>	<b>17</b>
6.1 Purpose of System Performance Check	17
6.2 System Setup	17
6.3 Validation Results	18
<b>7. EUT Testing Position</b>	<b>19</b>
7.1 Define Two Imaginary Lines on The Handset	19
7.2 Cheek Position	20
7.3 Tilted Position	20
7.4 Body Worn Position	21
7.5 EUT Antenna Position	21
7.6 EUT Testing Position	22
<b>8. SAR Measurement Procedures</b>	<b>23</b>
8.1 Measurement Procedures	23
8.2 Spatial Peak SAR Evaluation	23
8.3 Area & Zoom Scan Procedures	24
8.4 Volume Scan Procedures	24
8.5 SAR Averaged Methods	24
8.6 Power Drift Monitoring	24
<b>9. SAR Test Result</b>	<b>25</b>
9.1 Conducted RF Output Power	25
9.2 Test Results for Standalone SAR Test	53
9.3 Simultaneous Multi-band Transmission SAR Analysis	61
<b>10. Measurement Uncertainty</b>	<b>68</b>
10.1 Uncertainty for EUT SAR Test	68
10.2 Uncertainty for System Performance Check	69
<b>Annex A. Plots of System Performance Check</b>	<b>71</b>
<b>Annex B. Plots of SAR Measurement</b>	<b>91</b>
<b>Annex C. EUT Photos</b>	<b>137</b>
<b>Annex D. Test Setup Photos</b>	<b>138</b>
<b>Annex E. Calibration Certificate</b>	<b>143</b>

## 1. General Information

### 1.1 Product Description for Equipment Under Test (EUT)

#### Client Information

Applicant: PCD, LLC.  
Address of applicant: 1500 Tradeport Drive, Suite A. Orlando, FL

Manufacturer: Guizhou Fortuneship Technology Co., Ltd.  
Address of manufacturer: 2nd Floor, Factory Building 4, Hi-Tech Industrial Park, Xinpu Economic Development Zone, Xinpu New District, Zunyi City, Guizhou Province, P. R. China

General Description of EUT:	
Product Name:	Monkey II LTE
Brand Name:	PCD
Model No.:	PL5003
Adding Model(s):	/
Rated Voltage:	DC 3.8V by Battery
Battery Capacity:	2000mAh
Device Category:	Portable Device
<i>The EUT Main board support GSM850/900/DCS1800/PCS1900, WCDMA Band 2/5, LTE Band 2/4/5/7 function. It is intended for speech, Multimedia Message Service (MMS) transmission. It is equipped with GPRS class 12 for GSM850/900/DCS1800/PCS1900, GPS, FM, Bluetooth and Wi-Fi functions. For more information see the following datasheet</i>	
<i>Note: The test data is gathered from a production sample provided by the manufacturer.</i>	

<b>Technical Characteristics of EUT:</b>	
<b>2G</b>	
Support Networks:	GSM, GPRS, EDGE
Support Band:	GSM850/PCS1900
Uplink Frequency:	GSM/GPRS 850: 824~849MHz GSM/GPRS 1900: 1850~1910MHz
Downlink Frequency:	GSM/GPRS 850: 869~894MHz GSM/GPRS 1900: 1930~1990MHz
Type of Modulation:	GMSK
Type of Antenna:	Integral Antenna
GPRS Class:	Class 12
<b>3G</b>	
Support Networks:	WCDMA, HSDPA, HSUPA
Support Band:	WCDMA Band 2, WCDMA Band 5
Uplink Frequency:	WCDMA Band 2: 1850~1910MHz WCDMA Band 5: 824~849MHz
Downlink Frequency:	WCDMA Band 2: 1930~1990MHz WCDMA Band 5: 869~894MHz
Type of Modulation:	BPSK
Antenna Type:	Integral Antenna
<b>4G</b>	
Support Networks:	FDD-LTE
Support Band:	FDD-LTE Band 2, 4,5,7
Uplink Frequency:	FDD-LTE Band 2: Tx: 1850-1910MHz, FDD-LTE Band 4: Tx: 1710-1755MHz, FDD-LTE Band 5: Tx: 824-849MHz, FDD-LTE Band 7: Tx: 2500-2570MHz
Downlink Frequency:	FDD-LTE Band 2: Rx: 1930-1990MHz, FDD-LTE Band 4: Rx: 2110-2155MHz, FDD-LTE Band 5: Rx: 869-894MHz, FDD-LTE Band 7: Rx: 2620-2690MHz,
Type of Modulation:	QPSK, 16QAM
Antenna Type:	Integral Antenna
<b>WIFI</b>	
Support Standards:	802.11b, 802.11g, 802.11n
Frequency Range:	2412-2462MHz for 11b/g/n(HT20) 2422-2452MHz for 11n(HT40)
Type of Modulation:	CCK, OFDM, QPSK, BPSK, 16QAM, 64QAM
Data Rate:	1-11Mbps, 6-54Mbps, up to 150Mbps
Quantity of Channels:	11/7
Channel Separation:	5MHz
Antenna Type:	Integral Antenna

<b>Bluetooth</b>	
Bluetooth Version:	V4.0
Frequency Range:	2402-2480MHz
Data Rate:	1Mbps, 2Mbps, 3Mbps
Modulation:	GFSK, Pi/4 QDPSK, 8DPSK
Quantity of Channels:	79/40
Channel Separation:	1MHz/2MHz
Antenna Type:	Integral Antenna

## 1.2 Test Standards

The following report is prepared on behalf of the PCD, LLC. in accordance with FCC 47 CFR Part 2.1093, ANSI/IEEE C95.1-2005, ANSI / IEEE C95.3 :2002, IEEE 1528-2013, KDB 447498 D01 v06, KDB 648474 D04 v01r03, KDB 248227 D01 v02r02, KDB 941225 D01 v03r01, KDB 941225 D05 v02r05 ,KDB 941225 D06 v02r01, and KDB 865664 D01 v01r04 and KDB 865664 D02 v01r02.

The objective is to determine compliance with FCC Part 2.1093 of the Federal Communication Commissions rules.

*Maintenance of compliance* is the responsibility of the manufacturer. Any modification of the product, which result in lowering the emission, should be checked to ensure compliance has been maintained.

## 1.3 Test Methodology

All measurements contained in this report were conducted with KDB 865664 D01 v01r04 and KDB 865664 D02 v01r02. The public notice KDB 447498 D01 v06 for Mobile and Portable Devices RF Exposure Procedure also.

## 1.4 Test Facility

### **FCC – Registration No.: 125990**

Shenzhen SEM Test Technology Co., Ltd. Laboratory has been recognized to perform compliance testing on equipment subject to the Commissions Declaration Of Conformity (DOC). The Designation Number is CN5010, and Test Firm Registration Number is 125990.

## 2. Summary of Test Results

The maximum results of Specific Absorption Rate (SAR) have found during testing are as follows:

Frequency Band	Head SAR	Body-worn (10mm Gap)	Hotspot (10mm Gap)	SAR <sub>1g</sub> Limit (W/kg)
	Maximum SAR <sub>1g</sub> (W/kg)	Maximum SAR <sub>1g</sub> (W/kg)	Maximum SAR <sub>1g</sub> (W/kg)	
GSM	<b>0.693</b>	0.442	<b>0.771</b>	1.6
WCDMA	0.507	<b>0.444</b>	0.444	1.6
FDD-LTE	0.146	0.289	0.289	1.6
WLAN 2.4G	0.370	0.214	0.214	1.6
Simultaneous Transmission	<b>1.063</b>	0.656	0.985	1.6

**Remark:**

*The highest reported SAR values for head, body-worn accessory, wireless router(hotspot), and simultaneous transmission conditions are **0.693 W/kg, 0.444W/kg, 0.771W/kg, and 1.063W/kg** respectively.*

The device is in compliance with Specific Absorption Rate (SAR) for general population/uncontrolled exposure limits (1.6 W/kg) specified in FCC 47 CFR Part 2.1093 and ANSI/IEEE C95.1-2005, and had been tested in accordance with the measurement methods and procedure specified in IEEE 1528-2013 and KDB 865664 D01 v01r04 and KDB 865664 D02 v01r02

### 3. Specific Absorption Rate (SAR)

---

#### 3.1 Introduction

SAR is related to the rate at which energy is absorbed per unit mass in an object exposed to a radio field. The SAR distribution in a biological body is complicated and is usually carried out by experimental techniques or numerical modeling. The standard recommends limits for two tiers of groups, occupational/controlled and general population/uncontrolled, based on a person's awareness and ability to exercise control over his or her exposure. In general, occupational/controlled exposure limits are higher than the limits for general population/uncontrolled.

#### 3.2 SAR Definition

The SAR definition is the time derivative (rate) of the incremental energy (dW) absorbed by (dissipated in) an incremental mass (dm) contained in a volume element (dv) of a given density ( $\rho$ ). The equation description is as below:

$$\text{SAR} = \frac{d}{dt} \left( \frac{dW}{dm} \right) = \frac{d}{dt} \left( \frac{dW}{\rho dv} \right)$$

SAR is expressed in units of Watts per kilogram (W/kg)

SAR measurement can be either related to the temperature elevation in tissue by

$$\text{SAR} = C \left( \frac{\delta T}{\delta t} \right)$$

Where: C is the specific heat capacity,  $\delta T$  is the temperature rise and  $\delta t$  is the exposure duration, or related to the electrical field in the tissue by

$$\text{SAR} = \frac{\sigma |E|^2}{\rho}$$

Where:  $\sigma$  is the conductivity of the tissue,  $\rho$  is the mass density of the tissue and E is the RMS electrical field strength.

However for evaluating SAR of low power transmitter, electrical field measurement is typically applied.



## 4. SAR Measurement System

---

### 4.1 The Measurement System

Comosar is a system that is able to determine the SAR distribution inside a phantom of human being according to different standards. The Comosar system consists of the following items:

- Main computer to control all the system
- 6 axis robot
- Data acquisition system
- Miniature E-field probe
- Phone holder
- Head simulating tissue

The following figure shows the system.



The EUT under test operating at the maximum power level is placed in the phone holder, under the phantom, which is filled with head simulating liquid. The E-Field probe measures the electric field inside the phantom. The OpenSAR software computes the results to give a SAR value in a 1g or 10g mass.

### 4.2 Probe

For the measurements the Specific Dosimetric E-Field Probe SSE5 SN 09/13 EP168 with following specifications is used

- Dynamic range: 0.01-100 W/kg
- Probe Length: 330 mm
- Length of Individual Dipoles: 4.5 mm
- Maximum external diameter: 8 mm
- Probe Tip External Diameter : 5 mm
- Distance between dipoles / probe extremity: 2.7mm

- Probe linearity: <0.25 dB
  - Axial Isotropy: <0.25 dB
  - Spherical Isotropy: <0.50 dB
  - Calibration range: 700 to 3000MHz for head & body simulating liquid.
- Angle between probe axis (evaluation axis) and surface normal line: less than 30°

Probe calibration is realized, in compliance with EN 62209-1 and IEEE 1528 STD, with CALISAR, Antenna proprietary calibration system. The calibration is performed with the EN 62209-1 annexe technique using reference guide at the five frequencies.

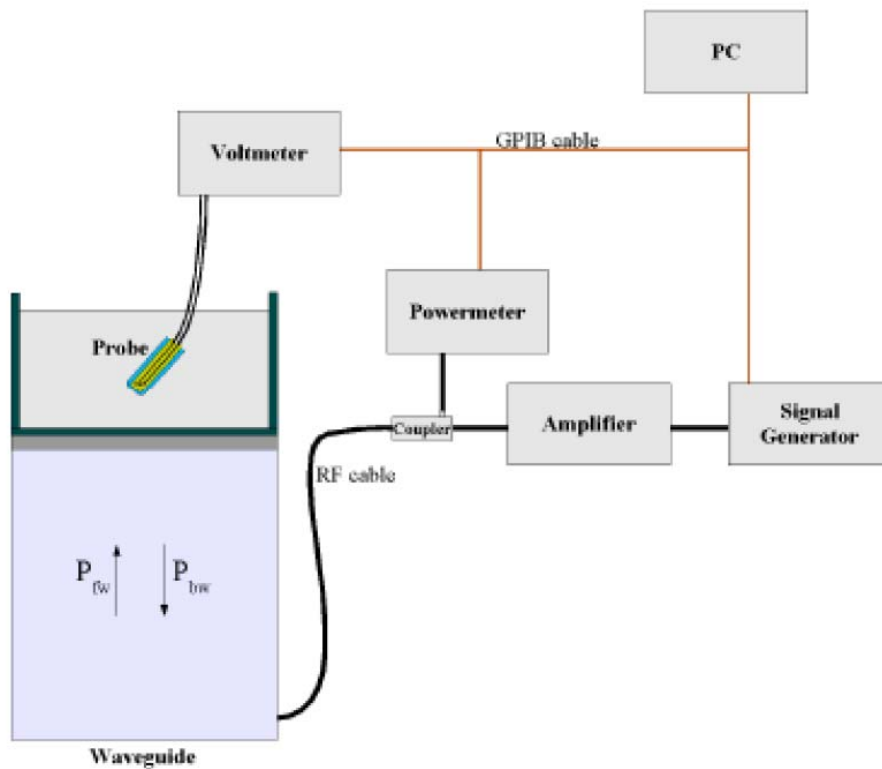

$$SAR = \frac{4(P_{fw} - P_{bw})}{ab\delta} \cos^2\left(\pi \frac{y}{a}\right) c \quad (2z/\delta)$$

Where :

$P_{fw}$  = Forward Power

$P_{bw}$  = Backward Power

a and b = Waveguide dimensions

$\delta$  = Skin depth

Keithley configuration:

Rate = Medium; Filter = ON; RDGS = 10; Filter type = Moving Average; Range auto after each calibration, a SAR measurement is performed on a validation dipole and compared with a NPL calibrated probe, to verify it.

The calibration factors, CF(N), for the 3 sensors corresponding to dipole 1, dipole 2 and dipole 3 are:

$$CF(N)=SAR(N)/V_{lin}(N) \quad (N=1,2,3)$$

The linearised output voltage  $V_{lin}(N)$  is obtained from the displayed output voltage  $V(N)$  using

$$V_{lin}(N)=V(N)*(1+V(N)/DCP(N)) \quad (N=1,2,3)$$

where DCP is the diode compression point in mV.

### 4.3 Probe Calibration Process

#### Dosimetric Assessment Procedure

Each E-Probe/Probe Amplifier combination has unique calibration parameters. SATIMO Probe calibration procedure is conducted to determine the proper amplifier settings to enter in the probe parameters. The amplifier settings are determined for a given frequency by subjecting the probe to a known E-field density (1 mW/cm<sup>2</sup>) using an with CALISAR, Antenna proprietary calibration system.

#### Free Space Assessment Procedure

The free space E-field from amplified probe outputs is determined in a test chamber. This calibration can be performed in a TEM cell if the frequency is below 1 GHz and in a waveguide or other methodologies above 1 GHz for free space. For the free space calibration, the probe is placed in the volumetric center of the cavity and at the proper orientation with the field. The probe is rotated 360 degrees until the three channels show the maximum reading. The power density readings equates to 1mW/cm<sup>2</sup>.

#### Temperature Assessment Procedure

E-field temperature correlation calibration is performed in a flat phantom filled with the appropriate simulated head tissue. The E-field in the medium correlates with the temperature rise in the dielectric medium. For temperature correlation calibration a RF transparent thermistor-based temperature probe is used in conjunction with the E-field probe.

Where:

$$SAR = C \frac{\Delta T}{\Delta t}$$

$\Delta t$  = exposure time (30 seconds),

$C$  = heat capacity of tissue (brain or muscle),

$\Delta T$  = temperature increase due to RF exposure.

SAR is proportional to  $\Delta T / \Delta t$ , the initial rate of tissue heating, before thermal diffusion takes place. The electric field in the simulated tissue can be used to estimate SAR by equating the thermally derived SAR to that with the E- field component.

$$\text{SAR} = \frac{|E|^2 \cdot \sigma}{\rho}$$

Where:

$\sigma$  = simulated tissue conductivity,

$\rho$  = Tissue density (1.25 g/cm<sup>3</sup> for brain tissue)

#### 4.4 Phantom

For the measurements the Specific Anthropomorphic Mannequin (SAM) defined by the IEEE SCC-34/SC2 group is used. The phantom is a polyurethane shell integrated in a wooden table. The thickness of the phantom amounts to 2mm +/- 0.2mm. It enables the dosimetric evaluation of left and right phone usage and includes an additional flat phantom part for the simplified performance check. The phantom set-up includes a cover, which prevents the evaporation of the liquid.

#### 4.5 Device Holder

The positioning system allows obtaining cheek and tilting position with a very good accuracy. In compliance with CENELEC, the tilt angle uncertainty is lower than 1°.

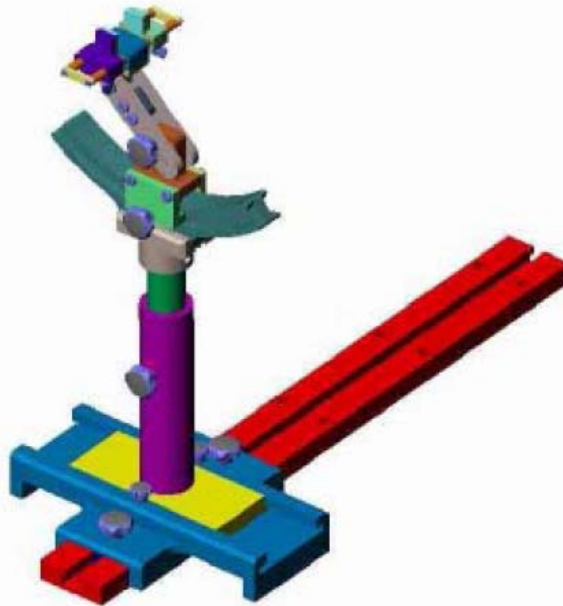

System Material	Permittivity	Loss Tangent
Delrin	3.7	0.005

#### 4.6 Test Equipment List

Description	Manufacturer	Model	Serial Number	Cal. Date	Due. Date
E-Field Probe	SATIMO	SSE5	SN 09/13 EP168	2017-06-01	2018-05-31
835MHz Dipole	SATIMO	SID835	SN 47/12 DIP 0G835-204	2017-03-16	2018-03-15
1800MHz Dipole	SATIMO	SID1800	SN 47/12 DIP 1G800-206	2017-03-16	2018-03-15
1900MHz Dipole	SATIMO	SID1900	SN 47/12 DIP 1G900-207	2017-03-16	2018-03-15
2450MHz Dipole	SATIMO	SID2450	SN 13/15 DIP 2G450-364	2017-03-16	2018-03-15
2600MHz Dipole	SATIMO	SID2600	SN 13/15 DIP 2G600-365	2017-03-16	2018-03-15
Dielectric Probe Kit	SATIMO	SCLMP	SN 47/12 OCPG49	2017-03-16	2018-03-15
SAM Phantom	SATIMO	SAM	SN/ 47/12 SAM95	N/A	N/A
MULTIMETER	KEITHLEY	Keithley 2000	4006367	2017-06-12	2018-06-11
Signal Generator	Rohde & Schwarz	SMR20	100047	2017-06-12	2018-06-11
Universal Tester	Rohde & Schwarz	CMU200	112012	2017-06-12	2018-06-11
Network Analyzer	HP	8753C	2901A00831	2017-06-12	2018-06-11
Directional Couplers	Agilent	778D	20160	2017-06-12	2018-06-11

## 5. Tissue Simulating Liquids

### 5.1 Composition of Tissue Simulating Liquid

For the measurement of the field distribution inside the SAM phantom with SMTIMO, the phantom must be filled with around 25 liters of homogeneous body tissue simulating liquid. For head SAR testing, the liquid height from the ear reference point (ERP) of the phantom to the liquid top surface is larger than 15 cm. For body SAR testing, the liquid height from the center of the flat phantom to the liquid top surface is larger than 15 cm. Please see the following photos for the liquid height.



**Liquid Height for Head SAR**

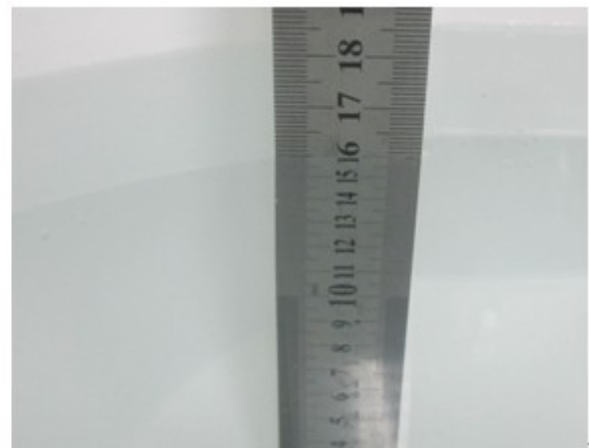

**Liquid Height for Body SAR**

#### The Composition of Tissue Simulating Liquid

Frequency (MHz)	Water (%)	Salt (%)	Sugar (%)	HEC (%)	Preventol (%)	DGBE (%)
<b>Head</b>						
835	40.3	1.4	57.9	0.2	0.2	0
1800-1900	55.2	0.3	0	0	0	44.5
2450	55.0	0.1	0	0	0	44.9
2600	54.9	0.1	0	0	0	45.0
<b>Body</b>						
835	50.8	0.9	48.1	0.1	0.1	0
1800-1900	70.2	0.4	0	0	0	29.4
2450	68.6	0.1	0	0	0	31.3
2600	68.2	0.1	0	0	0	31.7

## 5.2 Tissue Dielectric Parameters for Head and Body Phantoms

The head tissue dielectric parameters recommended by the IEEE SCC-34/SC-2 in P1528 have been incorporated in the following table. These head parameters are derived from planar layer models simulating the highest expected SAR for the dielectric properties and tissue thickness variations in a human head. Other head and body tissue parameters that have not been specified in P1528 are derived from the tissue dielectric parameters computed from the 4-Cole-Cole equations described in Reference [12] and extrapolated according to the head parameters specified in P1528.

Target Frequency (MHz)	Head		Body	
	Conductivity ( $\sigma$ )	Permittivity ( $\epsilon_r$ )	Conductivity ( $\sigma$ )	Permittivity ( $\epsilon_r$ )
150	0.76	52.3	0.80	61.9
300	0.87	45.3	0.92	58.2
450	0.87	43.5	0.94	56.7
<b>750</b>	<b>0.89</b>	<b>41.9</b>	<b>0.96</b>	<b>55.5</b>
<b>835</b>	<b>0.90</b>	<b>41.5</b>	<b>0.97</b>	<b>55.2</b>
900	0.97	41.5	1.05	55.0
915	0.98	41.5	1.06	55.0
1450	1.20	40.5	1.30	54.0
1610	1.29	40.3	1.40	53.8
<b>1800-2000</b>	<b>1.40</b>	<b>40.0</b>	<b>1.52</b>	<b>53.3</b>
<b>2450</b>	<b>1.80</b>	<b>39.2</b>	<b>1.95</b>	<b>52.7</b>
3000	2.40	38.5	2.73	52.0
5800	5.27	35.3	6.00	48.2

### 5.3 Tissue Calibration Result

The dielectric parameters of the liquids were verified prior to the SAR evaluation using COMOSAR Dielectric Probe Kit and an Agilent Network Analyzer.

#### Calibration Result for Dielectric Parameters of Tissue Simulating Liquid

Head Tissue Simulating Liquid									
Freq. MHz.	Temp. (°C)	Conductivity			Permittivity			Limit (%)	Date
		Reading ( $\sigma$ )	Target ( $\sigma$ )	Delta (%)	Reading ( $\epsilon_r$ )	Target ( $\epsilon_r$ )	Delta (%)		
835	21.2	0.87	0.90	-3.33	41.11	41.50	-0.94	±5	2017-08-20
1800	21.3	1.37	1.40	-2.14	39.02	40.0	-2.45	±5	2017-08-20
1900	21.3	1.38	1.40	-1.43	38.56	40.00	-3.60	±5	2017-08-20
2450	21.3	1.74	1.80	-3.33	38.15	39.20	-2.68	±5	2017-08-20
2600	21.3	1.93	1.96	-1.53	38.63	39.0	-0.95	±5	2017-08-20

Body Tissue Simulating Liquid									
Freq. MHz.	Temp. (°C)	Conductivity			Permittivity			Limit (%)	Date
		Reading ( $\sigma$ )	Target ( $\sigma$ )	Delta (%)	Reading ( $\epsilon_r$ )	Target ( $\epsilon_r$ )	Delta (%)		
835	21.2	0.95	0.97	-2.06	54.85	55.20	-0.63	±5	2017-08-20
1800	21.3	1.46	1.52	-3.95	51.22	53.30	-3.90	±5	2017-08-20
1900	21.3	1.50	1.52	-1.32	52.42	53.30	-1.65	±5	2017-08-20
2450	21.3	1.91	1.95	-2.05	52.01	52.70	-1.31	±5	2017-08-20
2600	21.3	2.12	2.16	-1.85	52.24	52.50	-0.50	±5	2017-08-20



## 6. SAR Measurement Evaluation

### 6.1 Purpose of System Performance Check

The system performance check verifies that the system operates within its specifications. System and operator errors can be detected and corrected. It is recommended that the system performance check be performed prior to any usage of the system in order to guarantee reproducible results. The system performance check uses normal SAR measurements in a simplified setup with a well characterized source. This setup was selected to give a high sensitivity to all parameters that might fail or vary over time. The system check does not intend to replace the calibration of the components, but indicates situations where the system uncertainty is exceeded due to drift or failure.

### 6.2 System Setup

In the simplified setup for system evaluation, the EUT is replaced by a calibrated dipole and the power source is replaced by a continuous wave which comes from a signal generator at frequency 835 MHz and 1900 MHz. The calibrated dipole must be placed beneath the flat phantom section of the SAM twin phantom with the correct distance holder. The distance holder should touch the phantom surface with a light pressure at the reference marking and be oriented parallel to the long side of the phantom.

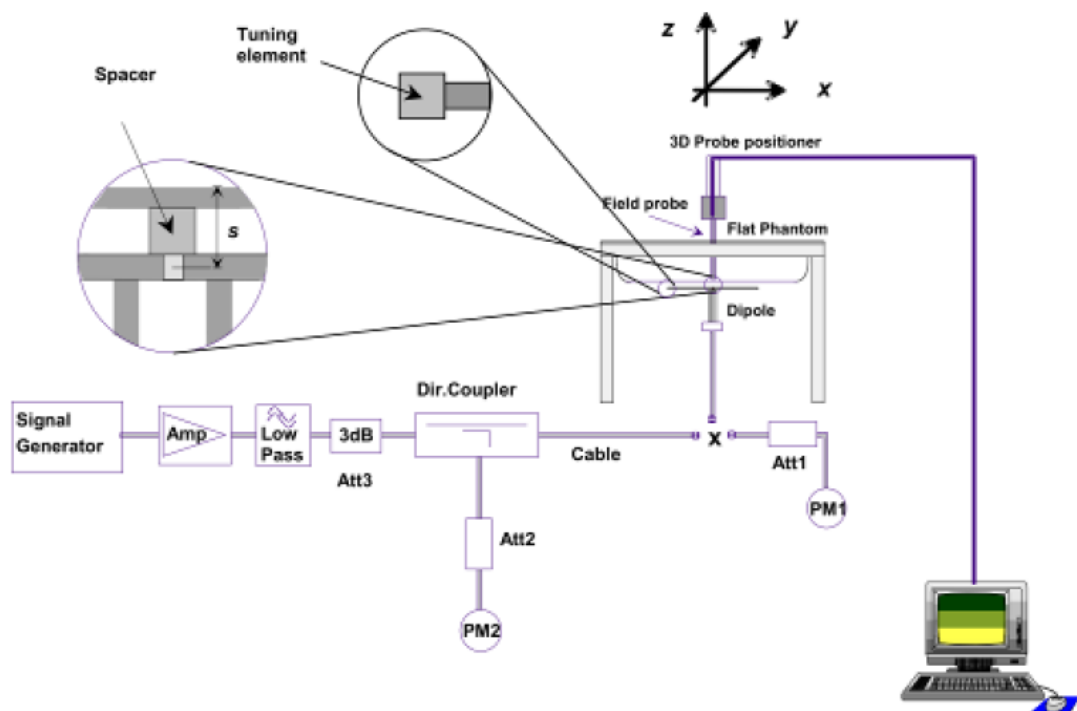

System Verification Setup Block Diagram



**Setup Photo of Dipole Antenna**

The output power on dipole port must be calibrated to 24 dBm(250 mW) before dipole is connected.

### 6.3 Validation Results

Comparing to the original SAR value provided by SATIMO, the validation data should be within its specification of 10 %. Table 6.1 shows the target SAR and measured SAR after normalized to 1W input power. The table below indicates the system performance check can meet the variation criterion.

Frequency	Targeted SAR <sub>1g</sub>	Measured SAR <sub>1g</sub>	Normalized SAR <sub>1g</sub>	Tolerance
MHz	(W/kg)	(W/kg)	(W/kg)	(%)
Head				
835	9.65	2.41	9.64	-0.10
1800	38.49	9.61	38.44	-0.13
1900	39.59	9.91	39.64	0.13
2450	53.76	13.45	53.8	0.07
2600	55.07	13.67	54.68	-0.71
Body				
835	9.36	2.35	9.4	0.43
1800	38.29	9.58	38.32	0.08
1900	39.01	9.78	39.12	0.28
2450	50.33	12.59	50.36	0.06
2600	53.92	13.43	53.72	-0.37

Targeted and Measurement SAR

*Please refer to Annex A for the plots of system performance check.*

## 7. EUT Testing Position

### 7.1 Define Two Imaginary Lines on The Handset

- (a) The vertical centerline passes through two points on the front side of the handset - the midpoint of the width  $w_t$  of the handset at the level of the acoustic output, and the midpoint of the width  $w_b$  of the bottom of the handset.
- (b) The horizontal line is perpendicular to the vertical centerline and passes through the center of the acoustic output. The horizontal line is also tangential to the face of the handset at point A.
- (c) The two lines intersect at point A. Note that for many handsets, point A coincides with the center of the acoustic output; however, the acoustic output may be located elsewhere on the horizontal line. Also note that the vertical centerline is not necessarily parallel to the front face of the handset, especially for clamshell handsets, handsets with flip covers, and other irregularly shaped handsets.

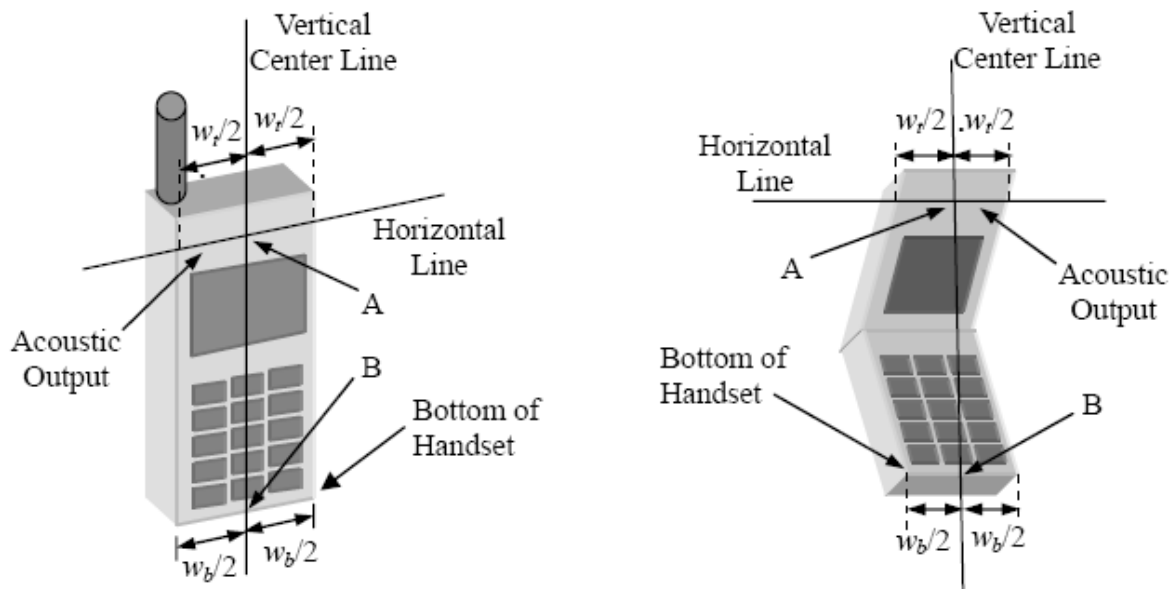

**Illustration for Handset Vertical and Horizontal Reference Lines**

## 7.2 Cheek Position

(a) To position the device with the vertical center line of the body of the device and the horizontal line crossing the center piece in a plane parallel to the sagittal plane of the phantom. While maintaining the device in this plane, align the vertical center line with the reference plane containing the three ear and mouth reference point (M: Mouth, RE: Right Ear, and LE: Left Ear) and align the center of the ear piece with the line RE-LE.

(b) To move the device towards the phantom with the ear piece aligned with the line LE-RE until the phone touched the ear. While maintaining the device in the reference plane and maintaining the phone contact with the ear, move the bottom of the phone until any point on the front side is in contact with the cheek of the phantom or until contact with the ear is lost (see Fig. 7.2).

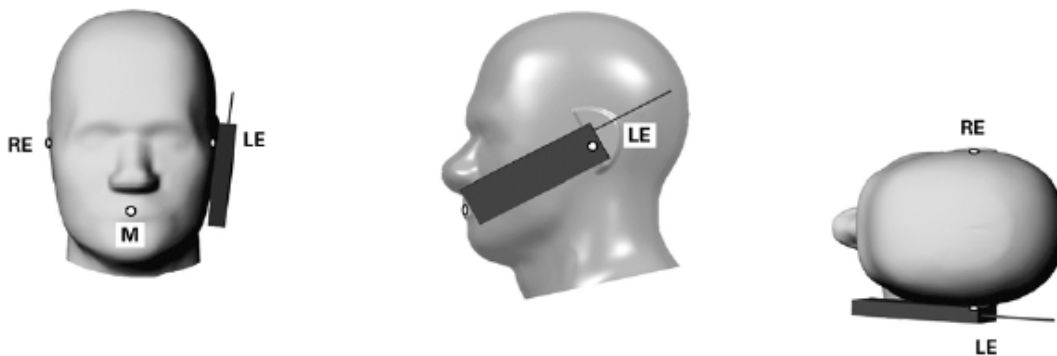

Illustration for Cheek Position

## 7.3 Tilted Position

(a) To position the device in the “cheek” position described above.

(b) While maintaining the device the reference plane described above and pivoting against the ear, moves it outward away from the mouth by an angle of 15 degrees or until contact with the ear is lost (see Fig. 7.3).

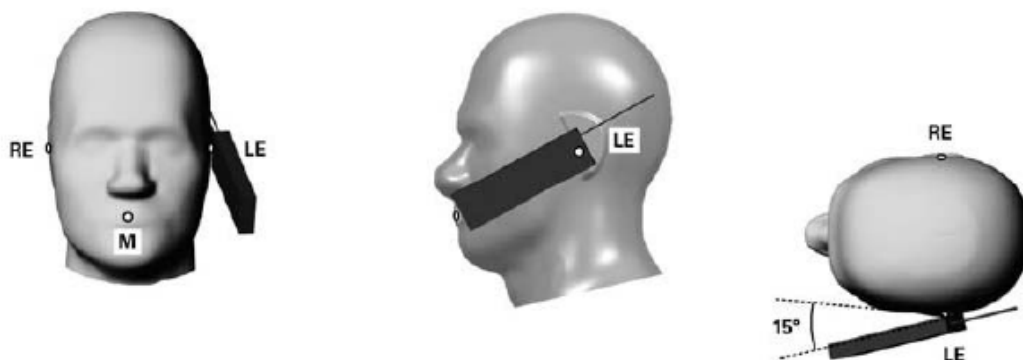

Illustration for Tilted Position

### 7.4 Body Worn Position

- (a) To position the device parallel to the phantom surface with either keypad up or down.
- (b) To adjust the device parallel to the flat phantom.
- (c) To adjust the distance between the device surface and the flat phantom to 10mm.

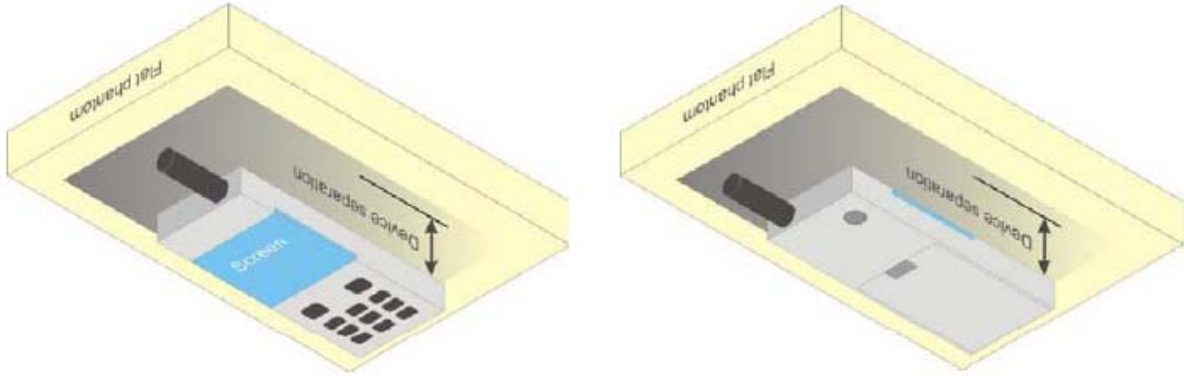
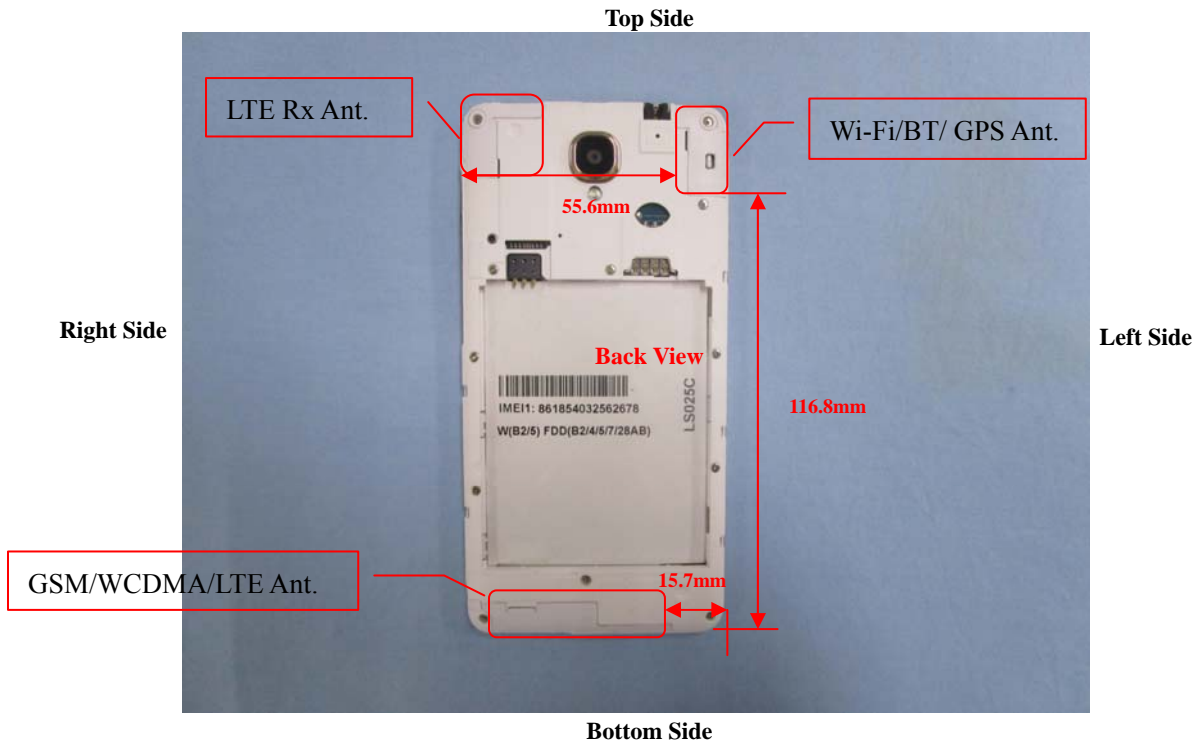

Illustration for Body Worn Position

### 7.5 EUT Antenna Position



Block Diagram for EUT Antenna Position

## 7.6 EUT Testing Position

Head/Body-worn/Hotspot mode SAR assessments are required for this device. This EUT was tested in different positions for different SAR test modes, more information as below:

Head SAR tests				
Antennas	Right Cheek	Left Cheek	Right Tilted	Left Tilted
WWAN	Yes	Yes	Yes	Yes
WLAN	Yes	Yes	Yes	Yes

Hotspot SAR tests, Test distance: 10mm						
Antennas	Front	Back	Right Side	Left Side	Top Side	Bottom Side
WWAN	Yes	Yes	Yes	Yes	No	Yes
WLAN	Yes	Yes	No	Yes	Yes	No

Body-worn SAR tests		
Antennas	Front	Back
WWAN	Yes	Yes
WLAN	Yes	Yes

**Remark:**

1. Referring to KDB 941225 D06, when the overall device length and width are  $\geq 9\text{cm} \times 5\text{cm}$ , the test separation distances is 10 mm. SAR must be measured for all sides and surfaces with a transmitting antenna located within 25mm from that surface or edge.

2. Referring to KDB 648474 D04 Handset SAR v01r03, 10-g extremity SAR is required only for the surfaces and edges with hotspot mode 1-g reported SAR  $> 1.2 \text{ W/kg}$ ; however, the highest reported SAR is  $0.771 \text{ W/kg} < 1.2 \text{ W/kg}$ , so 10-g extremity SAR is not required.

*Please refer to Annex D for the EUT test setup photos.*

---

## 8. SAR Measurement Procedures

---

### 8.1 Measurement Procedures

The measurement procedures are as follows:

- (a) Use base station simulator (if applicable) or engineering software to transmit RF power continuously (continuous Tx) in the highest power channel.
- (b) Keep EUT to radiate maximum output power or 100% factor (if applicable)
- (c) Measure output power through RF cable and power meter.
- (d) Place the EUT in the positions as Annex D demonstrates.
- (e) Set scan area, grid size and other setting on the SATIMO software.
- (f) Measure SAR results for the highest power channel on each testing position.
- (g) Find out the largest SAR result on these testing positions of each band
- (h) Measure SAR results for other channels in worst SAR testing position if the SAR of highest power channel is larger than 0.8 W/kg

According to the test standard, the recommended procedure for assessing the peak spatial-average SAR value consists of the following steps:

- (a) Power reference measurement
- (b) Area scan
- (c) Zoom scan
- (d) Power drift measurement

### 8.2 Spatial Peak SAR Evaluation

The procedure for spatial peak SAR evaluation has been implemented according to the test standard. It can be conducted for 1g and 10g, as well as for user-specific masses. The SATIMO software includes all numerical procedures necessary to evaluate the spatial peak SAR value.

The base for the evaluation is a "cube" measurement. The measured volume must include the 1g and 10g cubes with the highest averaged SAR values. For that purpose, the center of the measured volume is aligned to the interpolated peak SAR value of a previously performed area scan.

The entire evaluation of the spatial peak values is performed within the post-processing engine. The system always gives the maximum values for the 1g and 10g cubes. The algorithm to find the cube with highest averaged SAR is divided into the following stages:

- (a) Extraction of the measured data (grid and values) from the Zoom Scan
- (b) Calculation of the SAR value at every measurement point based on all stored data
- (c) Generation of a high-resolution mesh within the measured volume
- (d) Interpolation of all measured values from the measurement grid to the high-resolution grid
- (e) Extrapolation of the entire 3D field distribution to the phantom surface over the distance from sensor to surface
- (f) Calculation of the averaged SAR within masses of 1g and 10g

### **8.3 Area & Zoom Scan Procedures**

First Area Scan is used to locate the approximate location(s) of the local peak SAR value(s). The measurement grid within an Area Scan is defined by the grid extent, grid step size and grid offset. Next, in order to determine the EM field distribution in a three-dimensional spatial extension, Zoom Scan is required. The Zoom Scan measures 5x5x7 points with step size 8, 8 and 5 mm for 300 MHz to 3 GHz, and 8x8x8 points with step size 4, 4 and 2.5 mm for 3 GHz to 6 GHz. The Zoom Scan is performed around the highest E-field value to determine the averaged SAR-distribution over 10 g.

### **8.4 Volume Scan Procedures**

The volume scan is used for assess overlapping SAR distributions for antennas transmitting in different frequency bands. It is equivalent to an oversized zoom scan used in standalone measurements. The measurement volume will be used to enclose all the simultaneous transmitting antennas. For antennas transmitting simultaneously in different frequency bands, the volume scan is measured separately in each frequency band. In order to sum correctly to compute the 1g aggregate SAR, the EUT remain in the same test position for all measurements and all volume scan use the same spatial resolution and grid spacing (step-size is 4, 4 and 2.5 mm). When all volume scan were completed, the software can combine and subsequently superpose these measurement data to calculating the multiband SAR.

### **8.5 SAR Averaged Methods**

The local SAR inside the phantom is measured using small dipole sensing elements inside a probe body. The probe tip must not be in contact with the phantom surface in order to minimize measurements errors, but the highest local SAR will occur at the surface of the phantom.

An extrapolation is using to determinate this highest local SAR values. The extrapolation is based on a fourth-order least-square polynomial fit of measured data. The local SAR value is then extrapolated from the liquid surface with a 1mm step.

The measurements have to be performed over a limited time (due to the duration of the battery) so the step of measurement is high. It could vary between 5 and 8 mm. To obtain an accurate assessment of the maximum SAR averaged over 10g and 1 g requires a very fine resolution in the three dimensional scanned data array.

### **8.6 Power Drift Monitoring**

All SAR testing is under the EUT install full charged battery and transmit maximum output power. In SATIMO measurement software, the power reference measurement and power drift measurement procedures are used for monitoring the power drift of EUT during SAR test. Both these procedures measure the field at a specified reference position before and after the SAR testing. The software will calculate the field difference in dB. If the power drift more than 5%, the SAR will be retested.



## 9. SAR Test Result

### 9.1 Conducted RF Output Power

GSM - Burst Average Power (dBm)								
Band	GSM850			Tune-up power (dBm)	PCS1900			Tune-up power (dBm)
Channel	128	190	251		512	661	810	
Frequency (MHz)	824.2	836.6	848.8		1850.2	1880	1909.8	
GSM	33.49	33.49	33.43	34.0	29.33	29.42	29.41	30.0
GPRS (1 slot)	33.46	33.46	33.41	34.0	29.30	29.39	29.40	30.0
GPRS (2 slots)	30.84	30.92	30.86	31.0	27.01	27.16	27.15	28.0
GPRS (3 slots)	29.09	29.13	29.05	29.5	25.48	25.59	25.56	26.0
GPRS (4 slots)	27.93	27.94	27.97	28.5	24.37	24.46	24.43	25.0

GSM - Source-Based Time-Average Power (dBm)								
Band	GSM850			Tune-up power (dBm)	PCS1900			Tune-up power (dBm)
Channel	128	190	251		512	661	810	
Frequency (MHz)	824.2	836.6	848.8		1850.2	1880	1909.8	
GSM	24.46	24.46	24.40	25.0	20.30	20.39	20.38	21.0
GPRS (1 slot)	24.43	24.43	24.38	25.0	20.27	20.36	20.37	21.0
GPRS (2 slots)	24.82	24.90	24.84	25.0	20.99	21.14	21.13	22.0
GPRS (3 slots)	24.83	24.87	24.79	25.0	21.22	21.33	21.30	22.0
GPRS (4 slots)	24.92	24.93	24.96	25.0	21.36	21.45	21.42	22.0

Note: The source-based time-averaged power is linearly scaled the maximum burst averaged power based on time slots. The calculated method are shown as below:

Source based time-average power = Burst averaged power - Duty cycle factor in dB

Duty cycle factor = 9 dB for 1 Tx slot, 6 dB for 2 Tx slots, 4.25 dB for 3 Tx slots, 3 dB for 4 Tx slots

#### Remark:

1. For Head SAR testing, GSM and GPRS (4TX slots) should be evaluated, therefore the EUT was set in GSM for GSM850 and GSM1900 due to its highest source-based time-average power.
2. For Body SAR testing, GPRS should be evaluated, therefore the EUT was set in GPRS (4TX slots) for GSM850 and GSM1900 due to its highest source-based time-average power.
3. Per KDB 447498 D01 v06, the maximum output power channel is used for SAR testing and for further SAR test reduction.
4. The DUT do not support DTM function.
5. This device supports VOIP capability through 3rd party apps software.

WCDMA - Average Power (dBm)								
Band	WCDMA Band II				WCDMA Band V			
Channel	9262	9400	9538	Tune-up power (dBm)	4132	4182	4233	Tune-up power (dBm)
Frequency (MHz)	1852.4	1880.0	1907.6		826.4	836.6	846.6	
RMC 12.2k	22.93	22.98	22.92	23.5	23.34	23.36	23.32	23.5
HSDPA Subtest-1	21.66	21.6	21.53	22.0	21.85	21.89	21.68	22.0
HSDPA Subtest-2	21.37	21.83	21.08	22.0	21.24	21.59	21.23	22.0
HSDPA Subtest-3	21.83	21.98	21.54	22.0	21.58	21.34	21.91	22.0
HSDPA Subtest-4	21.25	21.34	21.11	22.0	21.32	21.32	21.85	22.0
HSUPA Subtest-1	21.54	21.59	21.88	22.0	21.87	21.62	21.58	22.0
HSUPA Subtest-2	21.25	21.58	21.39	22.0	21.87	21.22	21.9	22.0
HSUPA Subtest-3	21.94	21.46	21.78	22.0	21.96	21.61	21.19	22.0
HSUPA Subtest-4	21.55	21.77	21.47	22.0	21.8	21.43	21.75	22.0
HSUPA Subtest-5	21.50	21.83	21.54	22.0	21.87	21.59	21.51	22.0

**Remark:**

1. For Head SAR, per KDB 941225 D01 v03, RMC 12.2kbps setting is used to evaluate SAR. If AMR 12.2kbps power is < 1/4 dB higher than RMC, SAR tests with AMR 12.2kbps can be excluded.
2. For Body SAR, per KDB 941225 D01 v03, RMC 12.2kbps setting is used to evaluate SAR. If HSDPA subset-1 output power is < 1/4 dB higher than RMC, and SAR with RMC 12.2kbps setting is  $\leq 1.2\text{W/kg}$ , HSDPA SAR evaluation can be excluded

**FDD-LTE Band 2:**

Channel Bandwidth: 1.4 MHz					
Modulation	Channel	RB Configuration		Average Power [dBm]	Tune-up power (dBm)
		Size	Offset		
QPSK	LCH	1	0	22.65	23.0
		1	3	22.60	23.0
		1	5	22.55	23.0
		3	0	22.69	23.0
		3	2	22.63	23.0
		3	3	22.65	23.0
		6	0	21.43	23.0
	MCH	1	0	22.00	23.0
		1	3	22.08	23.0
		1	5	22.11	23.0
		3	0	22.04	23.0
		3	2	21.95	23.0
		3	3	22.01	23.0
		6	0	20.93	23.0
	HCH	1	0	22.72	23.0
		1	3	22.74	23.0
		1	5	22.76	23.0
		3	0	22.85	23.0
		3	2	22.80	23.0
		3	3	22.81	23.0
		6	0	21.72	23.0
16QAM	LCH	1	0	21.93	23.0
		1	3	21.98	23.0
		1	5	21.89	23.0
		3	0	21.75	23.0
		3	2	21.66	23.0
		3	3	21.67	23.0
		6	0	20.46	23.0
	MCH	1	0	21.39	23.0
		1	3	21.53	23.0
		1	5	21.41	23.0
		3	0	21.12	23.0
		3	2	21.07	23.0
		3	3	21.12	23.0
		6	0	19.93	23.0
HCH	1	0	22.00	23.0	

		1	3	22.07	23.0
		1	5	22.02	23.0
		3	0	21.90	23.0
		3	2	21.86	23.0
		3	3	21.90	23.0
		6	0	20.87	23.0

Channel Bandwidth: 3 MHz					
Modulation	Channel	RB Configuration		Average Power [dBm]	Tune-up power (dBm)
		Size	Offset		
QPSK	LCH	1	0	22.11	23.0
		1	7	22.71	23.0
		1	14	22.50	23.0
		8	0	22.47	23.0
		8	4	22.05	23.0
		8	7	22.61	23.0
		15	0	22.61	23.0
	MCH	1	0	22.27	23.0
		1	7	22.17	23.0
		1	14	22.14	23.0
		8	0	22.36	23.0
		8	4	22.23	23.0
		8	7	22.21	23.0
		15	0	22.26	23.0
	HCH	1	0	22.67	23.0
		1	7	22.41	23.0
		1	14	22.03	23.0
		8	0	22.79	23.0
		8	4	22.32	23.0
		8	7	22.18	23.0
		15	0	22.09	23.0
16QAM	LCH	1	0	22.85	23.0
		1	7	22.59	23.0
		1	14	22.67	23.0
		8	0	22.49	23.0
		8	4	21.9	23.0
		8	7	22.16	23.0
		15	0	21.95	23.0
	MCH	1	0	22.35	23.0
		1	7	22.75	23.0
		1	14	22.67	23.0
		8	0	22.34	23.0

		8	4	22.73	23.0
		8	7	22.77	23.0
		15	0	22.59	23.0
	HCH	1	0	22.26	23.0
		1	7	22.44	23.0
		1	14	22.81	23.0
		8	0	22.11	23.0
		8	4	22.19	23.0
		8	7	22.58	23.0
		15	0	22.63	23.0

Channel Bandwidth: 5 MHz					
Modulation	Channel	RB Configuration		Average Power [dBm]	Tune-up power (dBm)
		Size	Offset		
QPSK	LCH	1	0	22.78	23.0
		1	12	22.55	23.0
		1	24	22.23	23.0
		12	0	22.48	23.0
		12	6	22.13	23.0
		12	13	22.79	23.0
		25	0	22.09	23.0
	MCH	1	0	22.63	23.0
		1	12	22.65	23.0
		1	24	22.32	23.0
		12	0	22.23	23.0
		12	6	22.64	23.0
		12	13	22.75	23.0
		25	0	22.15	23.0
	HCH	1	0	22.45	23.0
		1	12	22.36	23.0
		1	24	21.94	23.0
		12	0	21.95	23.0
		12	6	21.91	23.0
		12	13	21.91	23.0
		25	0	22.21	23.0
16QAM	LCH	1	0	22.85	23.0
		1	12	22.38	23.0
		1	24	22.45	23.0
		12	0	22.61	23.0
		12	6	22.27	23.0
		12	13	22.01	23.0
		25	0	22.42	23.0

	MCH	1	0	22.38	23.0
		1	12	22.04	23.0
		1	24	22.24	23.0
		12	0	22.63	23.0
		12	6	21.89	23.0
		12	13	22.68	23.0
		25	0	22.27	23.0
	HCH	1	0	22.17	23.0
		1	12	22.28	23.0
		1	24	21.94	23.0
		12	0	22.49	23.0
		12	6	22.23	23.0
		12	13	22.23	23.0
		25	0	22.08	23.0

Channel Bandwidth: 10 MHz					
Modulation	Channel	RB Configuration		Average Power [dBm]	Tune-up power (dBm)
		Size	Offset		
QPSK	LCH	1	0	22.26	23.0
		1	24	22.88	23.0
		1	49	22.68	23.0
		25	0	21.97	23.0
		25	12	22.75	23.0
		25	25	21.98	23.0
		50	0	21.98	23.0
	MCH	1	0	21.97	23.0
		1	24	21.98	23.0
		1	49	22.52	23.0
		25	0	22.88	23.0
		25	12	22.06	23.0
		25	25	22.59	23.0
		50	0	22.87	23.0
	HCH	1	0	22.02	23.0
		1	24	22.47	23.0
		1	49	22.64	23.0
		25	0	22.73	23.0
		25	12	22.32	23.0
		25	25	22.82	23.0
		50	0	22.32	23.0
16QAM	LCH	1	0	21.94	23.0
		1	24	22.06	23.0
		1	49	22.76	23.0

		25	0	21.97	23.0
		25	12	22.64	23.0
		25	25	22.89	23.0
		50	0	22.31	23.0
	MCH	1	0	22.66	23.0
		1	24	22.32	23.0
		1	49	21.97	23.0
		25	0	22.43	23.0
		25	12	22.24	23.0
		25	25	22.65	23.0
		50	0	22.69	23.0
	HCH	1	0	22.82	23.0
		1	24	22.46	23.0
		1	49	22.12	23.0
		25	0	22.63	23.0
		25	12	22.07	23.0
		25	25	21.95	23.0
50		0	22.30	23.0	

Channel Bandwidth: 15 MHz					
Modulation	Channel	RB Configuration		Average Power [dBm]	Tune-up power (dBm)
		Size	Offset		
QPSK	LCH	1	0	22.59	23.0
		1	37	22.74	23.0
		1	74	22.04	23.0
		37	0	22.34	23.0
		37	18	22.83	23.0
		37	38	21.94	23.0
		75	0	22.22	23.0
	MCH	1	0	22.13	23.0
		1	37	21.93	23.0
		1	74	22.25	23.0
		37	0	22.47	23.0
		37	18	22.42	23.0
		37	38	22.62	23.0
		75	0	22.66	23.0
	HCH	1	0	22.36	23.0
		1	37	22.47	23.0
		1	74	22.52	23.0
		37	0	22.21	23.0
		37	18	22.14	23.0
		37	38	22.13	23.0

		75	0	21.93	23.0
16QAM	LCH	1	0	22.29	23.0
		1	37	22.57	23.0
		1	74	22.33	23.0
		37	0	22.64	23.0
		37	18	22.57	23.0
		37	38	22.64	23.0
		75	0	22.84	23.0
	MCH	1	0	22.63	23.0
		1	37	22.07	23.0
		1	74	22.81	23.0
		37	0	22.19	23.0
		37	18	21.95	23.0
		37	38	21.97	23.0
		75	0	22.43	23.0
	HCH	1	0	22.52	23.0
		1	37	22.65	23.0
		1	74	22.36	23.0
		37	0	22.31	23.0
		37	18	22.29	23.0
		37	38	22.77	23.0
		75	0	22.00	23.0

Channel Bandwidth: 20 MHz					
Modulation	Channel	RB Configuration		Average Power [dBm]	Tune-up power (dBm)
		Size	Offset		
QPSK	LCH	1	0	22.87	23.0
		1	49	22.57	23.0
		1	99	22.38	23.0
		50	0	22.12	23.0
		50	25	22.46	23.0
		50	50	22.05	23.0
		100	0	22.37	23.0
	MCH	1	0	22.78	23.0
		1	49	22.16	23.0
		1	99	22.87	23.0
		50	0	22.26	23.0
		50	25	22.12	23.0
		50	50	22.64	23.0
		100	0	22.72	23.0
	HCH	1	0	22.81	23.0
		1	49	22.34	23.0



		1	99	22.07	23.0
		50	0	22.04	23.0
		50	25	21.95	23.0
		50	50	22.44	23.0
		100	0	22.28	23.0
16QAM	LCH	1	0	22.61	23.0
		1	49	22.72	23.0
		1	99	22.31	23.0
		50	0	22.77	23.0
		50	25	22.57	23.0
		50	50	22.19	23.0
		100	0	22.05	23.0
	MCH	1	0	22.54	23.0
		1	49	22.57	23.0
		1	99	22.76	23.0
		50	0	22.41	23.0
		50	25	22.46	23.0
		50	50	22.25	23.0
		100	0	22.64	23.0
	HCH	1	0	22.61	23.0
		1	49	22.85	23.0
		1	99	22.22	23.0
		50	0	22.80	23.0
		50	25	22.44	23.0
		50	50	22.86	23.0
		100	0	22.86	23.0

**FDD-LTE Band 4:**

Channel Bandwidth: 1.4 MHz					
Modulation	Channel	RB Configuration		Average Power [dBm]	Tune-up power (dBm)
		Size	Offset		
QPSK	LCH	1	0	22.49	23.0
		1	3	22.83	23.0
		1	5	22.27	23.0
		3	0	22.18	23.0
		3	2	22.29	23.0
		3	3	22.38	23.0
		6	0	22.14	23.0
	MCH	1	0	22.53	23.0
		1	3	21.89	23.0

		1	5	22.35	23.0	
		3	0	22.52	23.0	
		3	2	22.66	23.0	
		3	3	22.61	23.0	
		6	0	22.02	23.0	
	HCH	1	0	22.71	23.0	
		1	3	22.19	23.0	
		1	5	22.36	23.0	
		3	0	22.38	23.0	
		3	2	22.66	23.0	
		3	3	22.35	23.0	
		6	0	21.94	23.0	
	16QAM	LCH	1	0	22.21	23.0
			1	3	22.15	23.0
1			5	22.43	23.0	
3			0	22.11	23.0	
3			2	21.99	23.0	
3			3	22.45	23.0	
6			0	22.73	23.0	
MCH		1	0	22.19	23.0	
		1	3	22.52	23.0	
		1	5	22.67	23.0	
		3	0	22.1	23.0	
		3	2	22.62	23.0	
		3	3	22.49	23.0	
		6	0	21.99	23.0	
HCH		1	0	22.53	23.0	
		1	3	22.72	23.0	
		1	5	21.97	23.0	
		3	0	21.96	23.0	
		3	2	21.99	23.0	
		3	3	22.42	23.0	
		6	0	22.35	23.0	

Channel Bandwidth: 3 MHz					
Modulation	Channel	RB Configuration		Average Power [dBm]	Tune-up power (dBm)
		Size	Offset		
QPSK	LCH	1	0	22.46	23.0
		1	7	22.43	23.0
		1	14	22.79	23.0
		8	0	22.65	23.0
		8	4	22.09	23.0

		8	7	22.49	23.0
		15	0	22.34	23.0
	MCH	1	0	22.59	23.0
		1	7	22.38	23.0
		1	14	22.18	23.0
		8	0	21.99	23.0
		8	4	22.56	23.0
		8	7	22.7	23.0
		15	0	22.58	23.0
		HCH	1	0	22.34
	1		7	22.42	23.0
	1		14	22.81	23.0
	8		0	22.44	23.0
	8		4	22.46	23.0
	8		7	22.56	23.0
	15		0	22.72	23.0
16QAM	LCH	1	0	22.47	23.0
		1	7	22.75	23.0
		1	14	22.38	23.0
		8	0	22.23	23.0
		8	4	21.97	23.0
		8	7	22.25	23.0
		15	0	21.95	23.0
	MCH	1	0	22.29	23.0
		1	7	22.44	23.0
		1	14	22.57	23.0
		8	0	22.63	23.0
		8	4	22.84	23.0
		8	7	22.26	23.0
		15	0	22.36	23.0
	HCH	1	0	22.64	23.0
		1	7	22.56	23.0
		1	14	22.14	23.0
		8	0	22.88	23.0
		8	4	22.86	23.0
		8	7	22.24	23.0
		15	0	22.86	23.0

Channel Bandwidth: 5 MHz					
Modulation	Channel	RB Configuration		Average Power [dBm]	Tune-up power (dBm)
		Size	Offset		
QPSK	LCH	1	0	22.45	23.0

		1	12	22.82	23.0	
		1	24	22.16	23.0	
		12	0	22.06	23.0	
		12	6	22.13	23.0	
		12	13	22.75	23.0	
		25	0	22.13	23.0	
	MCH	1	0	22.64	23.0	
		1	12	22.58	23.0	
		1	24	22.55	23.0	
		12	0	22.08	23.0	
		12	6	22.73	23.0	
		12	13	22.49	23.0	
	HCH	25	0	22.92	23.0	
		1	0	22.17	23.0	
		1	12	22.12	23.0	
		1	24	22.46	23.0	
		12	0	22.34	23.0	
		12	6	22.21	23.0	
	16QAM	LCH	12	13	22.52	23.0
			25	0	22.66	23.0
			1	0	22.57	23.0
1			12	22.07	23.0	
1			24	22.58	23.0	
12			0	21.98	23.0	
MCH		12	6	22.09	23.0	
		12	13	22.41	23.0	
		25	0	22.39	23.0	
		1	0	22.88	23.0	
		1	12	22.71	23.0	
		1	24	22.05	23.0	
HCH		12	0	22.02	23.0	
		12	6	22.73	23.0	
		12	13	22.69	23.0	
		25	0	22.31	23.0	
		1	0	22.01	23.0	
		1	12	22.29	23.0	
			1	24	22.87	23.0
			12	0	22.24	23.0
			12	6	22.24	23.0
	12		13	22.63	23.0	
	25		0	22.75	23.0	

Channel Bandwidth: 10 MHz					
Modulation	Channel	RB Configuration		Average Power [dBm]	Tune-up power (dBm)
		Size	Offset		
QPSK	LCH	1	0	22.18	23.0
		1	24	22.14	23.0
		1	49	22.29	23.0
		25	0	22.36	23.0
		25	12	22.49	23.0
		25	25	22.34	23.0
		50	0	21.89	23.0
	MCH	1	0	22.27	23.0
		1	24	22.82	23.0
		1	49	22.28	23.0
		25	0	22.77	23.0
		25	12	22.32	23.0
		25	25	22.13	23.0
		50	0	22.53	23.0
	HCH	1	0	22.84	23.0
		1	24	21.95	23.0
		1	49	22.33	23.0
		25	0	22.54	23.0
		25	12	22.22	23.0
		25	25	22.09	23.0
		50	0	22.41	23.0
16QAM	LCH	1	0	22.61	23.0
		1	24	22.44	23.0
		1	49	22.69	23.0
		25	0	22.43	23.0
		25	12	22.89	23.0
		25	25	22.79	23.0
		50	0	22.49	23.0
	MCH	1	0	21.97	23.0
		1	24	22.86	23.0
		1	49	21.97	23.0
		25	0	22.59	23.0
		25	12	22.39	23.0
		25	25	22.43	23.0
		50	0	22.54	23.0
	HCH	1	0	21.95	23.0
		1	24	22.82	23.0
		1	49	22.79	23.0

		25	0	22.68	23.0
		25	12	22.28	23.0
		25	25	22.77	23.0
		50	0	22.45	23.0

Channel Bandwidth: 15 MHz					
Modulation	Channel	RB Configuration		Average Power [dBm]	Tune-up power (dBm)
		Size	Offset		
QPSK	LCH	1	0	21.91	23.0
		1	37	22.46	23.0
		1	74	22.32	23.0
		37	0	22.47	23.0
		37	18	22.57	23.0
		37	38	21.98	23.0
		75	0	22.38	23.0
	MCH	1	0	21.91	23.0
		1	37	22.29	23.0
		1	74	22.25	23.0
		37	0	22.37	23.0
		37	18	22.21	23.0
		37	38	22.81	23.0
		75	0	22.14	23.0
	HCH	1	0	22.28	23.0
		1	37	22.12	23.0
		1	74	22.54	23.0
		37	0	22.85	23.0
		37	18	22.69	23.0
		37	38	22.27	23.0
		75	0	22.21	23.0
16QAM	LCH	1	0	22.52	23.0
		1	37	22.21	23.0
		1	74	22.02	23.0
		37	0	22.43	23.0
		37	18	22.17	23.0
		37	38	22.23	23.0
		75	0	22.74	23.0
	MCH	1	0	22.43	23.0
		1	37	22.46	23.0
		1	74	21.94	23.0
		37	0	22.24	23.0
		37	18	22.43	23.0
		37	38	22.77	23.0

		75	0	22.86	23.0
	HCH	1	0	21.89	23.0
		1	37	22.52	23.0
		1	74	21.89	23.0
		37	0	22.21	23.0
		37	18	22.08	23.0
		37	38	22.18	23.0
		75	0	21.92	23.0

Channel Bandwidth: 20 MHz						
Modulation	Channel	RB Configuration		Average Power [dBm]	Tune-up power (dBm)	
		Size	Offset			
QPSK	LCH	1	0	22.75	23.0	
		1	49	22.64	23.0	
		1	99	22.05	23.0	
		50	0	22.24	23.0	
		50	25	22.85	23.0	
		50	50	21.93	23.0	
		100	0	22.87	23.0	
	MCH	1	0	22.35	23.0	
		1	49	22.73	23.0	
		1	99	22.47	23.0	
		50	0	22.45	23.0	
		50	25	22.85	23.0	
		50	50	22.86	23.0	
		100	0	22.13	23.0	
	HCH	1	0	22.02	23.0	
		1	49	22.68	23.0	
		1	99	22.38	23.0	
		50	0	22.19	23.0	
		50	25	21.91	23.0	
		50	50	22.05	23.0	
		100	0	22.66	23.0	
	16QAM	LCH	1	0	22.26	23.0
			1	49	22.32	23.0
			1	99	22.14	23.0
50			0	22.04	23.0	
50			25	22.75	23.0	
50			50	22.87	23.0	
100			0	22.53	23.0	
MCH		1	0	22.84	23.0	
		1	49	22.17	23.0	

		1	99	22.07	23.0
		50	0	22.06	23.0
		50	25	22.21	23.0
		50	50	22.27	23.0
		100	0	21.97	23.0
	HCH	1	0	22.81	23.0
		1	49	22.66	23.0
		1	99	22.46	23.0
		50	0	22.27	23.0
		50	25	22.13	23.0
		50	50	22.03	23.0
		100	0	22.54	23.0



**FDD-LTE Band 5:**

Channel Bandwidth: 1.4 MHz					
Modulation	Channel	RB Configuration		Average Power [dBm]	Tune-up power (dBm)
		Size	Offset		
QPSK	LCH	1	0	22.22	24.0
		1	3	22.07	24.0
		1	5	22.44	24.0
		3	0	22.51	24.0
		3	2	23.75	24.0
		3	3	23.67	24.0
		6	0	23.73	24.0
	MCH	1	0	23.74	24.0
		1	3	23.73	24.0
		1	5	22.47	24.0
		3	0	22.88	24.0
		3	2	23.34	24.0
		3	3	23.19	24.0
		6	0	23.68	24.0
	HCH	1	0	22.14	24.0
		1	3	22.64	24.0
		1	5	23.01	24.0
		3	0	22.48	24.0
		3	2	22.07	24.0
		3	3	23.78	24.0
		6	0	22.79	24.0
16QAM	LCH	1	0	23.5	24.0
		1	3	23.84	24.0
		1	5	23.18	24.0
		3	0	22.82	24.0
		3	2	22.33	24.0
		3	3	22.67	24.0
		6	0	22.66	24.0
	MCH	1	0	22.27	24.0
		1	3	23.48	24.0
		1	5	21.91	24.0
		3	0	22.89	24.0
		3	2	22.07	24.0
		3	3	23.35	24.0
		6	0	23.71	24.0
HCH	1	0	22.72	24.0	

		1	3	22.03	24.0
		1	5	23.29	24.0
		3	0	23.73	24.0
		3	2	22.17	24.0
		3	3	22.45	24.0
		6	0	23.04	24.0

Channel Bandwidth: 3 MHz					
Modulation	Channel	RB Configuration		Average Power [dBm]	Tune-up power (dBm)
		Size	Offset		
QPSK	LCH	1	0	22.47	24.0
		1	7	23.12	24.0
		1	14	23.13	24.0
		8	0	23.55	24.0
		8	4	22.66	24.0
		8	7	22.45	24.0
		15	0	23.55	24.0
	MCH	1	0	23.15	24.0
		1	7	22.73	24.0
		1	14	23.83	24.0
		8	0	22.21	24.0
		8	4	23.79	24.0
		8	7	23.04	24.0
		15	0	22.41	24.0
	HCH	1	0	23.71	24.0
		1	7	22.32	24.0
		1	14	23.62	24.0
		8	0	22.97	24.0
		8	4	21.99	24.0
		8	7	22.77	24.0
		15	0	22.18	24.0
16QAM	LCH	1	0	23.73	24.0
		1	7	23.37	24.0
		1	14	22.48	24.0
		8	0	23.03	24.0
		8	4	23.21	24.0
		8	7	22.89	24.0
		15	0	22.57	24.0
	MCH	1	0	23.13	24.0
		1	7	22.25	24.0
		1	14	23.25	24.0
		8	0	23.75	24.0

		8	4	23.35	24.0
		8	7	22.99	24.0
		15	0	23.37	24.0
	HCH	1	0	22.03	24.0
		1	7	22.62	24.0
		1	14	23.06	24.0
		8	0	23.02	24.0
		8	4	23.31	24.0
		8	7	22.68	24.0
		15	0	22.37	24.0

Channel Bandwidth: 5 MHz					
Modulation	Channel	RB Configuration		Average Power [dBm]	Tune-up power (dBm)
		Size	Offset		
QPSK	LCH	1	0	22.01	24.0
		1	12	23.53	24.0
		1	24	22.54	24.0
		12	0	22.15	24.0
		12	6	23.48	24.0
		12	13	22.81	24.0
		25	0	23.23	24.0
	MCH	1	0	23.47	24.0
		1	12	22.31	24.0
		1	24	23.04	24.0
		12	0	22.41	24.0
		12	6	22.44	24.0
		12	13	23.08	24.0
		25	0	21.98	24.0
	HCH	1	0	22.09	24.0
		1	12	22.19	24.0
		1	24	22.74	24.0
		12	0	22.41	24.0
		12	6	22.85	24.0
		12	13	22.26	24.0
		25	0	21.97	24.0
16QAM	LCH	1	0	23.27	24.0
		1	12	22.17	24.0
		1	24	22.78	24.0
		12	0	22.72	24.0
		12	6	23.37	24.0
		12	13	21.95	24.0
		25	0	23.07	24.0

	MCH	1	0	23.48	24.0
		1	12	21.98	24.0
		1	24	22.37	24.0
		12	0	23.15	24.0
		12	6	22.68	24.0
		12	13	22.71	24.0
		25	0	23.76	24.0
	HCH	1	0	23.56	24.0
		1	12	22.64	24.0
		1	24	22.65	24.0
		12	0	22.64	24.0
		12	6	23.67	24.0
		12	13	22.45	24.0
		25	0	22.14	24.0

Channel Bandwidth: 10 MHz					
Modulation	Channel	RB Configuration		Average Power [dBm]	Tune-up power (dBm)
		Size	Offset		
QPSK	LCH	1	0	23.89	24.0
		1	24	23.87	24.0
		1	49	22.69	24.0
		25	0	23.37	24.0
		25	12	22.07	24.0
		25	25	22.11	24.0
		50	0	23.79	24.0
	MCH	1	0	21.97	24.0
		1	24	23.63	24.0
		1	49	22.62	24.0
		25	0	22.13	24.0
		25	12	22.22	24.0
		25	25	22.43	24.0
		50	0	22.85	24.0
	HCH	1	0	23.61	24.0
		1	24	23.66	24.0
		1	49	22.69	24.0
		25	0	23.65	24.0
		25	12	23.61	24.0
		25	25	21.96	24.0
		50	0	22.52	24.0
16QAM	LCH	1	0	23.89	24.0
		1	24	23.87	24.0
		1	49	22.69	24.0

		25	0	23.37	24.0
		25	12	22.07	24.0
		25	25	22.11	24.0
		50	0	23.79	24.0
	MCH	1	0	21.97	24.0
		1	24	23.63	24.0
		1	49	22.62	24.0
		25	0	22.13	24.0
		25	12	22.22	24.0
		25	25	22.43	24.0
		50	0	22.85	24.0
		HCH	1	0	23.61
	1		24	23.66	24.0
	1		49	22.69	24.0
	25		0	23.65	24.0
	25		12	23.61	24.0
	25		25	21.96	24.0
	50		0	22.52	24.0

**FDD-LTE Band 7:**

Channel Bandwidth: 5 MHz					
Modulation	Channel	RB Configuration		Average Power [dBm]	Tune-up power (dBm)
		Size	Offset		
QPSK	LCH	1	0	22.34	24.0
		1	12	21.89	24.0
		1	24	22.33	24.0
		12	0	23.57	24.0
		12	6	22.42	24.0
		12	13	22.86	24.0
		25	0	23.17	24.0
	MCH	1	0	22.62	24.0
		1	12	23.04	24.0
		1	24	23.87	24.0
		12	0	22.09	24.0
		12	6	23.21	24.0
		12	13	22.11	24.0
		25	0	22.59	24.0
	HCH	1	0	23.02	24.0
		1	12	21.81	24.0
		1	24	21.69	24.0
		12	0	23.56	24.0

		12	6	22.49	24.0
		12	13	22.11	24.0
		25	0	22.45	24.0
16QAM	LCH	1	0	23.04	24.0
		1	12	22.28	24.0
		1	24	23.45	24.0
		12	0	23.23	24.0
		12	6	22.88	24.0
		12	13	22.59	24.0
		25	0	22.21	24.0
	MCH	1	0	22.83	24.0
		1	12	21.99	24.0
		1	24	22.34	24.0
		12	0	22.13	24.0
		12	6	22.46	24.0
		12	13	22.81	24.0
		25	0	22.05	24.0
	HCH	1	0	22.19	24.0
		1	12	22.76	24.0
		1	24	23.25	24.0
		12	0	22.81	24.0
		12	6	23.27	24.0
		12	13	22.71	24.0
		25	0	22.42	24.0

Channel Bandwidth: 10 MHz					
Modulation	Channel	RB Configuration		Average Power [dBm]	Tune-up power (dBm)
		Size	Offset		
QPSK	LCH	1	0	22.47	24.0
		1	24	22.91	24.0
		1	49	22.65	24.0
		25	0	21.77	24.0
		25	12	22.92	24.0
		25	25	21.86	24.0
		50	0	22.74	24.0
	MCH	1	0	22.66	24.0
		1	24	22.06	24.0
		1	49	22.91	24.0
		25	0	23.43	24.0
		25	12	22.71	24.0
		25	25	21.89	24.0
		50	0	22.07	24.0

	HCH	1	0	23.39	24.0
		1	24	23.29	24.0
		1	49	23.25	24.0
		25	0	23.48	24.0
		25	12	21.71	24.0
		25	25	22.81	24.0
		50	0	21.65	24.0
16QAM	LCH	1	0	21.59	24.0
		1	24	23.28	24.0
		1	49	23.41	24.0
		25	0	23.04	24.0
		25	12	22.08	24.0
		25	25	22.29	24.0
		50	0	21.43	24.0
	MCH	1	0	21.99	24.0
		1	24	23.38	24.0
		1	49	22.68	24.0
		25	0	23.08	24.0
		25	12	23.17	24.0
		25	25	23.19	24.0
		50	0	23.48	24.0
	HCH	1	0	22.68	24.0
		1	24	22.18	24.0
		1	49	22.59	24.0
		25	0	23.05	24.0
		25	12	21.93	24.0
		25	25	22.63	24.0
		50	0	23.29	24.0

Channel Bandwidth: 15 MHz					
Modulation	Channel	RB Configuration		Average Power [dBm]	Tune-up power (dBm)
		Size	Offset		
QPSK	LCH	1	0	22.65	24.0
		1	37	22.42	24.0
		1	74	22.74	24.0
		37	0	23.31	24.0
		37	18	22.72	24.0
		37	38	22.14	24.0
		75	0	22.03	24.0
	MCH	1	0	21.81	24.0
		1	37	21.65	24.0
		1	74	22.98	24.0

		37	0	22.94	24.0		
		37	18	22.21	24.0		
		37	38	22.47	24.0		
		75	0	22.77	24.0		
	HCH	1	0	21.77	24.0		
		1	37	23.17	24.0		
		1	74	23.08	24.0		
		37	0	21.63	24.0		
		37	18	22.53	24.0		
		37	38	23.41	24.0		
		75	0	22.75	24.0		
		16QAM	LCH	1	0	23.14	24.0
				1	37	22.16	24.0
1	74			21.75	24.0		
37	0			21.31	24.0		
37	18			22.75	24.0		
37	38			22.46	24.0		
75	0			21.87	24.0		
MCH	1		0	21.96	24.0		
	1		37	22.35	24.0		
	1		74	23.15	24.0		
	37		0	21.68	24.0		
	37		18	22.65	24.0		
	37		38	23.12	24.0		
	75	0	22.05	24.0			
HCH	1	0	21.55	24.0			
	1	37	22.85	24.0			
	1	74	22.29	24.0			
	37	0	21.96	24.0			
	37	18	21.82	24.0			
	37	38	23.17	24.0			
	75	0	23.54	24.0			

Channel Bandwidth: 20 MHz					
Modulation	Channel	RB Configuration		Average Power [dBm]	Tune-up power (dBm)
		Size	Offset		
QPSK	LCH	1	0	21.67	24.0
		1	49	21.42	24.0
		1	99	22.42	24.0
		50	0	21.49	24.0
		50	25	22.41	24.0
		50	50	21.67	24.0



	MCH	100	0	23.15	24.0
		1	0	22.43	24.0
		1	49	22.23	24.0
		1	99	22.01	24.0
		50	0	23.49	24.0
		50	25	22.17	24.0
		50	50	22.38	24.0
		100	0	23.31	24.0
	HCH	1	0	21.92	24.0
		1	49	23.06	24.0
		1	99	22.09	24.0
		50	0	23.01	24.0
		50	25	22.76	24.0
		50	50	23.21	24.0
100		0	22.15	24.0	
16QAM	LCH	1	0	22.10	24.0
		1	49	22.94	24.0
		1	99	22.36	24.0
		50	0	21.75	24.0
		50	25	22.67	24.0
		50	50	22.66	24.0
		100	0	23.21	24.0
	MCH	1	0	23.38	24.0
		1	49	23.52	24.0
		1	99	22.28	24.0
		50	0	23.38	24.0
		50	25	23.26	24.0
		50	50	23.13	24.0
		100	0	23.42	24.0
	HCH	1	0	21.89	24.0
		1	49	23.25	24.0
		1	99	22.47	24.0
		50	0	23.01	24.0
		50	25	22.04	24.0
		50	50	23.24	24.0
		100	0	22.87	24.0

**Remark:**

1. Per KDB941225 D05 v02r05, Start with the largest channel bandwidth then measure SAR for QPSK with 1 RB allocation, using the RB offset and required test channel combination with the highest maximum output power among RB offsets at the upper edge, middle, and lower edge of each required test channel. When the reported SAR is  $\leq 0.8$  W/kg, testing of the remaining RB offset configurations and required test channels is not required for 1 RB allocation; otherwise, SAR is required for the remaining required test channels and only for the RB offset configuration with the highest output power for that channel. 6 When the reported SAR of a

required test channel is  $> 1.45$  W/kg, SAR is required for all three RB offset configurations for that required test channel.

2. Per KDB941225 D05 v02r05, The procedures required for 1 RB allocation in 5.2.1 are applied to measure the SAR for QPSK with 50% RB allocation.

3. Per KDB941225 D05 v02r05, For QPSK with 100% RB allocation, SAR is not required when the highest maximum output power for 100 % RB allocation is less than the highest maximum output power in 50% and 1 RB allocations, and the highest reported SAR for 1 RB and 50% RB allocation in 5.2.1 and 5.2.2 are  $\leq 0.8$  W/kg. Otherwise, SAR is measured for the highest output power channel; and if the reported SAR is  $> 1.45$  W/kg, the remaining required test channels must also be tested.

4. Per KDB941225 D05 v02r05, For each modulation besides QPSK; e.g., 16-QAM, 64-QAM, apply the QPSK procedures in 5.2.1, 5.2.2, and 5.2.3 to determine the QAM configurations that may need SAR measurement. For each configuration identified as required for testing, SAR is required only when the highest maximum output power for the configuration in the higher order modulation is  $> \frac{1}{2}$  dB higher than the same configuration in QPSK or when the reported SAR for the QPSK configuration is  $> 1.45$  W/kg.

WLAN - Maximum Average Power					
Test Mode	Data Rate	Channel	Frequency (MHz)	Average Power (dBm)	Tune-up power (dBm)
802.11b	1Mbps	CH 01	2412	14.57	15.0
		CH 06	2437	14.39	15.0
		CH 11	2462	13.88	14.0
802.11g	54Mbps	CH 01	2412	10.56	12.0
		CH 06	2437	11.93	12.0
		CH 11	2462	11.52	12.0
802.11n (20MHz)	MCS7	CH 01	2412	10.50	13.0
		CH 06	2437	12.00	13.0
		CH 11	2462	11.51	13.0
802.11n (40MHz)	MCS7	CH 03	2422	11.20	12.0
		CH 06	2437	11.09	12.0
		CH 09	2452	10.80	12.0

**Remark:**

- Per KDB 248227 D01 v02r02, For 802.11b DSSS SAR measurements, DSSS SAR procedure applies to fixed exposure test position and initial test position procedure applies to multiple exposure test positions.
- Per KDB 248227 D01 v02r02, For 802.11b DSSS SAR measurements, when the reported SAR of the highest measured maximum output power channel (see 3.1) for the exposure configuration is  $\leq 0.8$  W/kg, no further SAR testing is required for 802.11b DSSS in that exposure configuration. When the reported SAR is  $> 0.8$  W/kg, SAR is required for that exposure configuration using the next highest measured output power channel. When any reported SAR is  $> 1.2$  W/kg, SAR is required for the third channel; i.e., all channels require testing.
- For OFDM modes (802.11g/n), SAR is not required when the highest reported SAR for DSSS is adjusted by the ratio of OFDM to DSSS specified maximum output power and it is  $\leq 1.2$ W/kg.

Bluetooth - Maximum Average Power			
Test Mode	Data Rate	Average Power(dBm)	Tune-up power (dBm)
GFSK	1Mbps	2.33	3.0
Pi/4 QDPSK	2Mbps	1.44	3.0
8DPSK	3Mbps	1.50	3.0

Bluetooth - Maximum Average Power					
Test Mode	Data Rate	Channel	Frequency (MHz)	Average Power (dBm)	Tune-up power (dBm)
BLE	1Mbps	CH 00	2402	2.51	3.0
		CH 19	2440	2.01	3.0
		CH 39	2480	1.68	3.0

**Remark:**

Bluetooth maximum output power is 2.51dBm, and Maximum Tune-Up output power is 3.0dBm. Per KDB 447498 D01 V06, the 1-g and 10-g SAR test exclusion thresholds for 100 MHz to 6 GHz at test separation distances  $\leq 50$  mm are determined by:

$[(\text{max. power of channel, including tune-up tolerance, mW})/(\text{min. test separation distance, mm})] \cdot [\sqrt{f(\text{GHz})}] \leq 3.0$  for 1-g SAR and  $\leq 7.5$  for 10-g extremity SAR, where

- $f(\text{GHz})$  is the RF channel transmit frequency in GHz
- Power and distance are rounded to the nearest mW and mm before calculation<sup>17</sup>
- The result is rounded to one decimal place for comparison

Tune-Up Power (dBm)	Max. Power (mW)	Distance (mm)	Frequency (GHz)	Result	Limit
3.0	2.00	5	2.402	0.62	3

The exclusion thresholds is  $0.62 < 3$ , therefore, the RF exposure evaluation is not required.

## 9.2 Test Results for Standalone SAR Test

### Head SAR

GSM850 – Head SAR Test									
Plot No.	Mode	Test Position Head	Frequency		Output Power (dBm)	Rated Limit (dBm)	Scaling Factor	SAR1g (W/kg)	Scaled SAR1g (W/kg)
			CH.	MHz					
1.	GSM	Right Cheek	190	836.6	33.49	34.00	1.125	0.343	0.386
2.	GSM	Right Tilted	190	836.6	33.49	34.00	1.125	0.092	0.103
3.	GSM	Left Cheek	190	836.6	33.49	34.00	1.125	0.278	0.313
4.	GSM	Left Tilted	190	836.6	33.49	34.00	1.125	0.085	0.096

GSM1900 – Head SAR Test									
Plot No.	Mode	Test Position Head	Frequency		Output Power (dBm)	Rated Limit (dBm)	Scaling Factor	SAR1g (W/kg)	Scaled SAR1g (W/kg)
			CH.	M Hz					
5.	GSM	Right Cheek	661	1880.0	29.42	30.00	1.143	0.121	0.138
6.	GSM	Right Tilted	661	1880.0	29.42	30.00	1.143	0.083	0.095
7.	GSM	Left Cheek	661	1880.0	29.42	30.00	1.143	0.044	0.050
8.	GSM	Left Tilted	661	1880.0	29.42	30.00	1.143	0.006	0.007

GPRS850 – Head SAR Test									
Plot No.	Mode	Test Position Head	Frequency		Output Power (dBm)	Rated Limit (dBm)	Scaling Factor	SAR1g (W/kg)	Scaled SAR1g (W/kg)
			CH.	MHz					
9.	GPRS_4TX	Right Cheek	251	848.8	27.97	28.50	1.130	0.613	0.693
10.	GPRS_4TX	Right Tilted	251	848.8	27.97	28.50	1.130	0.216	0.244
11.	GPRS_4TX	Left Cheek	251	848.8	27.97	28.50	1.130	0.559	0.632
12.	GPRS_4TX	Left Tilted	251	848.8	27.97	28.50	1.130	0.206	0.233

GPRS1900 – Head SAR Test									
Plot No.	Mode	Test Position Head	Frequency		Output Power (dBm)	Rated Limit (dBm)	Scaling Factor	SAR1g (W/kg)	Scaled SAR1g (W/kg)
			CH.	M Hz					
13.	GPRS_4TX	Right Cheek	661	1880.0	24.46	25.00	1.132	0.115	0.130
14.	GPRS_4TX	Right Tilted	661	1880.0	24.46	25.00	1.132	0.063	0.071
15.	GPRS_4TX	Left Cheek	661	1880.0	24.46	25.00	1.132	0.141	0.160
16.	GPRS_4TX	Left Tilted	661	1880.0	24.46	25.00	1.132	0.084	0.095

WCDMA Band 2 – Head SAR Test									
Plot No.	Mode	Test Position Head	Frequency		Output Power (dBm)	Rated Limit (dBm)	Scaling Factor	SAR1g (W/kg)	Scaled SAR1g (W/kg)
			CH.	MHz					
17.	RMC	Right Cheek	9400	1880.0	22.98	23.50	1.127	0.218	0.246
18.	RMC	Right Tilted	9400	1880.0	22.98	23.50	1.127	0.053	0.060
19.	RMC	Left Cheek	9400	1880.0	22.98	23.50	1.127	0.115	0.130
20.	RMC	Left Tilted	9400	1880.0	22.98	23.50	1.127	0.042	0.047

WCDMA Band 5 – Head SAR Test									
Plot No.	Mode	Test Position Head	Frequency		Output Power (dBm)	Rated Limit (dBm)	Scaling Factor	SAR1g (W/kg)	Scaled SAR1g (W/kg)
			CH.	MHz					
21.	RMC	Right Cheek	4183	836.6	23.36	23.50	1.033	0.491	0.507
22.	RMC	Right Tilted	4183	836.6	23.36	23.50	1.033	0.104	0.107
23.	RMC	Left Cheek	4183	836.6	23.36	23.50	1.033	0.48	0.496
24.	RMC	Left Tilted	4183	836.6	23.36	23.50	1.033	0.113	0.117

LTE Band 2– Head SAR Test									
Plot No.	Mode	Test Position Head	Frequency MHz	Output Power (dBm)	Rated Limit (dBm)	Scaling Factor	SAR1g (W/kg)	Scaled SAR1g (W/kg)	
	Modulation, Bandwidth, RB								
25.	RMC QPSK 20MHz 1RB	Right Cheek	1860.0	22.87	23	1.030	0.131	0.135	
26.	RMC QPSK 20MHz 1RB	Right Tilted	1860.0	22.87	23	1.030	0.051	0.053	
27.	RMC QPSK 20MHz 1RB	Left Cheek	1860.0	22.87	23	1.030	0.106	0.109	
28.	RMC QPSK 20MHz 1RB	Left Tilted	1860.0	22.87	23	1.030	0.035	0.036	
29.	RMC QPSK 20MHz 50%RB	Right Cheek	1880.0	22.64	23	1.086	0.107	0.116	
30.	RMC QPSK 20MHz 50%RB	Right Tilted	1880.0	22.64	23	1.086	0.039	0.042	
31.	RMC QPSK 20MHz 50%RB	Left Cheek	1880.0	22.64	23	1.086	0.087	0.095	
32.	RMC QPSK 20MHz 50%RB	Left Tilted	1880.0	22.64	23	1.086	0.025	0.027	

LTE Band 4– Head SAR Test									
Plot No.	Mode	Test Position Head	Frequency MHz	Output Power (dBm)	Rated Limit (dBm)	Scaling Factor	SAR1g (W/kg)	Scaled SAR1g (W/kg)	
	Modulation, Bandwidth, RB								
33.	RMC QPSK 20MHz 1RB	Right Cheek	1720.0	22.75	23	1.059	0.105	0.111	
34.	RMC QPSK 20MHz 1RB	Right Tilted	1720.0	22.75	23	1.059	0.031	0.033	
35.	RMC QPSK 20MHz 1RB	Left Cheek	1720.0	22.75	23	1.059	0.09	0.095	
36.	RMC QPSK 20MHz 1RB	Left Tilted	1720.0	22.75	23	1.059	0.006	0.006	
37.	RMC QPSK 20MHz 50%RB	Right Cheek	1732.5	22.85	23	1.035	0.085	0.088	
38.	RMC QPSK 20MHz 50%RB	Right Tilted	1732.5	22.85	23	1.035	0.023	0.024	
39.	RMC QPSK 20MHz 50%RB	Left Cheek	1732.5	22.85	23	1.035	0.074	0.077	

40.	RMC QPSK 20MHz 50%RB	Left Tilted	1732.5	22.85	23	1.035	0.004	0.004
-----	----------------------	-------------	--------	-------	----	-------	-------	-------

LTE Band 5– Head SAR Test								
Plot No.	Mode	Test Position Head	Frequency	Output Power (dBm)	Rated Limit (dBm)	Scaling Factor	SAR1g (W/kg)	Scaled SAR1g (W/kg)
	Modulation, Bandwidth, RB		MHz					
41.	RMC QPSK 10MHz 1RB	Right Cheek	829.0	23.89	24	1.026	0.142	0.146
42.	RMC QPSK 10MHz 1RB	Right Tilted	829.0	23.89	24	1.026	0.061	0.063
43.	RMC QPSK 10MHz 1RB	Left Cheek	829.0	23.89	24	1.026	0.136	0.139
44.	RMC QPSK 10MHz 1RB	Left Tilted	829.0	23.89	24	1.026	0.032	0.033
45.	RMC QPSK 10MHz 50%RB	Right Cheek	844.0	23.65	24	1.084	0.115	0.125
46.	RMC QPSK 10MHz 50%RB	Right Tilted	844.0	23.65	24	1.084	0.047	0.051
47.	RMC QPSK 10MHz 50%RB	Left Cheek	844.0	23.65	24	1.084	0.112	0.121
48.	RMC QPSK 10MHz 50%RB	Left Tilted	844.0	23.65	24	1.084	0.023	0.025

LTE Band 7– Head SAR Test								
Plot No.	Mode	Test Position Head	Frequency	Output Power (dBm)	Rated Limit (dBm)	Scaling Factor	SAR1g (W/kg)	Scaled SAR1g (W/kg)
	Modulation, Bandwidth		MHz					
49.	RMC QPSK 20MHz 1RB	Right Cheek	2560.0	23.06	24	1.242	0.014	0.017
50.	RMC QPSK 20MHz 1RB	Right Tilted	2560.0	23.06	24	1.242	0.004	0.005
51.	RMC QPSK 20MHz 1RB	Left Cheek	2560.0	23.06	24	1.242	0.008	0.010
52.	RMC QPSK 20MHz 1RB	Left Tilted	2560.0	23.06	24	1.242	0.004	0.005
53.	RMC QPSK 20MHz 50%RB	Right Cheek	2535.0	23.49	24	1.125	0.011	0.012
54.	RMC QPSK 20MHz 50%RB	Right Tilted	2535.0	23.49	24	1.125	0.003	0.003
55.	RMC QPSK 20MHz 50%RB	Left Cheek	2535.0	23.49	24	1.125	0.006	0.007
56.	RMC QPSK 20MHz 50%RB	Left Tilted	2535.0	23.49	24	1.125	0.003	0.003

WLAN 2.4GHz – Head SAR Test									
Plot No.	Mode	Test Position Head	Frequency		Output Power (dBm)	Rated Limit (dBm)	Scaling Factor	SAR1g (W/kg)	Scaled SAR1g (W/kg)
			CH.	MHz					
57.	802.11b	Right Cheek	01	2412	14.57	15	1.104	0.335	0.370
58.	802.11b	Right Tilted	01	2412	14.57	15	1.104	0.098	0.108
59.	802.11b	Left Cheek	01	2412	14.57	15	1.104	0.100	0.110
60.	802.11b	Left Tilted	01	2412	14.57	15	1.104	0.006	0.007

**Remark:** Per KDB 447498 D01 v06, if the highest output channel SAR for each exposure position  $\leq 0.8$  W/kg other channels SAR tests are not necessary.

**Body-worn SAR**

GSM850 – Body SAR Test (Gap: 10mm)									
Plot No.	Mode	Test Position Body	Frequency		Output Power (dBm)	Rated Limit (dBm)	Scaling Factor	SAR1g (W/kg)	Scaled SAR1g (W/kg)
			CH.	MHz					
61.	GSM	Back	190	836.6	33.49	34.00	1.125	0.393	0.442
62.	GSM	Front	190	836.6	33.49	34.00	1.125	0.324	0.364

GSM1900 – Body SAR Test (Gap: 10mm)									
Plot No.	Mode	Test Position Body	Frequency		Output Power (dBm)	Rated Limit (dBm)	Scaling Factor	SAR1g (W/kg)	Scaled SAR1g (W/kg)
			CH.	MHz					
63.	GSM	Back	661	1880.0	29.42	30.00	1.143	0.234	0.267
64.	GSM	Front	661	1880.0	29.42	30.00	1.143	0.202	0.231

WCDMA Band 2 – Body SAR Test (Gap: 10mm)									
Plot No.	Mode	Test Position Body	Frequency		Output Power (dBm)	Rated Limit (dBm)	Scaling Factor	SAR1g (W/kg)	Scaled SAR1g (W/kg)
			CH.	MHz					
75	RMC 12.2k	Back Side	9400	1880.0	22.98	23.50	1.127	0.376	0.424
76	RMC 12.2k	Front Side	9400	1880.0	22.98	23.50	1.127	0.33	0.372

WCDMA Band 5 – Body SAR Test (Gap: 10mm)									
Plot No.	Mode	Test Position Body	Frequency		Output Power (dBm)	Rated Limit (dBm)	Scaling Factor	SAR1g (W/kg)	Scaled SAR1g (W/kg)
			CH.	MHz					
80	RMC 12.2k	Back Side	4182	836.6	23.36	23.50	1.033	0.325	0.336
81	RMC 12.2k	Front Side	4182	836.6	23.36	23.50	1.033	0.430	0.444

LTE Band 2–Body SAR Test (Gap: 10mm)									
Plot No.	Mode	Test Position Body	Freque	Output Power (dBm)	Rated Limit (dBm)	Scaling Factor	SAR1g (W/kg)	Scaled SAR1g (W/kg)	
	Modulation, Bandwidth, RB		ncy						MHz
85	RMC QPSK 20MHz 1RB	Back Side	1860.0	22.87	23	1.030	0.280	0.289	
86	RMC QPSK 20MHz 1RB	Front Side	1860.0	22.87	23	1.030	0.266	0.274	
90	RMC QPSK 20MHz 50%RB	Back Side	1880.0	22.64	23	1.086	0.234	0.254	
91	RMC QPSK 20MHz 50%RB	Front Side	1880.0	22.64	23	1.086	0.212	0.230	



LTE Band 4–Body SAR Test (Gap: 10mm)								
Plot No.	Mode	Test Position Body	Frequency	Output Power (dBm)	Rated Limit (dBm)	Scaling Factor	SAR1g (W/kg)	Scaled SAR1g (W/kg)
	Modulation, Bandwidth, RB		MHz					
95	RMC QPSK 20MHz 1RB	Back Side	1720.0	22.75	23	1.059	0.190	0.201
96	RMC QPSK 20MHz 1RB	Front Side	1720.0	22.75	23	1.059	0.167	0.177
100	RMC QPSK 20MHz 50%RB	Back Side	1732.5	22.85	23	1.035	0.159	0.165
101	RMC QPSK 20MHz 50%RB	Front Side	1732.5	22.85	23	1.035	0.132	0.137

LTE Band 5–Body SAR Test (Gap: 10mm)								
Plot No.	Mode	Test Position Body	Frequency	Output Power (dBm)	Rated Limit (dBm)	Scaling Factor	SAR1g (W/kg)	Scaled SAR1g (W/kg)
	Modulation, Bandwidth, RB		MHz					
105	RMC QPSK 10MHz 1RB	Back Side	829.0	23.89	24	1.026	0.172	0.176
106	RMC QPSK 10MHz 1RB	Front Side	829.0	23.89	24	1.026	0.132	0.135
110	RMC QPSK 10MHz 50%RB	Back Side	829.0	23.65	24	1.084	0.143	0.155
111	RMC QPSK 10MHz 50%RB	Front Side	829.0	23.65	24	1.084	0.105	0.114

LTE Band 7–Body SAR Test (Gap: 10mm)								
Plot No.	Mode	Test Position Body	Frequency	Output Power (dBm)	Rated Limit (dBm)	Scaling Factor	SAR1g (W/kg)	Scaled SAR1g (W/kg)
	Modulation, Bandwidth, RB		MHz					
115	RMC QPSK 20MHz 1RB	Back Side	2560.0	23.06	24	1.242	0.142	0.176
116	RMC QPSK 20MHz 1RB	Front Side	2560.0	23.06	24	1.242	0.07	0.087
120	RMC QPSK 20MHz 50%RB	Back Side	2535.0	23.49	24	1.125	0.111	0.125
121	RMC QPSK 20MHz 50%RB	Front Side	2535.0	23.49	24	1.125	0.055	0.062

WLAN 2.4GHz –Body SAR Test									
Plot No.	Mode	Test Position Body	Frequency		Output Power (dBm)	Rated Limit (dBm)	Scaling Factor	SAR1g (W/kg)	Scaled SAR1g (W/kg)
			CH.	MHz					
125	802.11b	Back Side	01	2412	14.57	15	1.104	0.194	0.214
126	802.11b	Front Side	01	2412	14.57	15	1.104	0.103	0.114

**Remark:** Per KDB 447498 D01 v06, if the highest output channel SAR for each exposure position  $\leq 0.8$  W/kg other channels SAR tests are not necessary.

**Hotspot SAR**

GSM850 – Body SAR Test (Gap: 10mm)									
Plot No.	Mode	Test Position Body	Frequency		Output Power (dBm)	Rated Limit (dBm)	Scaling Factor	SAR1g (W/kg)	Scaled SAR1g (W/kg)
			CH.	MHz					
65.	GPRS_4TX	Back Side	251	848.8	27.97	28.50	1.130	0.682	0.771
66.	GPRS_4TX	Front Side	251	848.8	27.97	28.50	1.130	0.602	0.680
67.	GPRS_4TX	Right side	251	848.8	27.97	28.50	1.130	0.352	0.398
68.	GPRS_4TX	Left side	251	848.8	27.97	28.50	1.130	0.122	0.138
69.	GPRS_4TX	Bottom Side	251	848.8	27.97	28.50	1.130	0.135	0.153

GSM1900 – Body SAR Test (Gap: 10mm)									
Plot No.	Mode	Test Position Body	Frequency		Output Power (dBm)	Rated Limit (dBm)	Scaling Factor	SAR1g (W/kg)	Scaled SAR1g (W/kg)
			CH.	MHz					
70.	GPRS_4TX	Back Side	661	1880.0	24.46	25.00	1.132	0.388	0.439
71.	GPRS_4TX	Front Side	661	1880.0	24.46	25.00	1.132	0.391	0.443
72.	GPRS_4TX	Right side	661	1880.0	24.46	25.00	1.132	0.329	0.373
73.	GPRS_4TX	Left side	661	1880.0	24.46	25.00	1.132	0.103	0.117
74.	GPRS_4TX	Bottom Side	661	1880.0	24.46	25.00	1.132	0.103	0.117

WCDMA Band 2 – Body SAR Test (Gap: 10mm)									
Plot No.	Mode	Test Position Body	Frequency		Output Power (dBm)	Rated Limit (dBm)	Scaling Factor	SAR1g (W/kg)	Scaled SAR1g (W/kg)
			CH.	MHz					
75.	RMC 12.2k	Back Side	9400	1880.0	22.98	23.50	1.127	0.376	0.424
76.	RMC 12.2k	Front Side	9400	1880.0	22.98	23.50	1.127	0.33	0.372
77.	RMC 12.2k	Right side	9400	1880.0	22.98	23.50	1.127	0.32	0.361
78.	RMC 12.2k	Left side	9400	1880.0	22.98	23.50	1.127	0.103	0.116
79.	RMC 12.2k	Bottom Side	9400	1880.0	22.98	23.50	1.127	0.102	0.115

WCDMA Band 5 – Body SAR Test (Gap: 10mm)									
Plot No.	Mode	Test Position Body	Frequency		Output Power (dBm)	Rated Limit (dBm)	Scaling Factor	SAR1g (W/kg)	Scaled SAR1g (W/kg)
			CH.	MHz					
80.	RMC 12.2k	Back Side	4182	836.6	23.36	23.50	1.033	0.325	0.336
81.	RMC 12.2k	Front Side	4182	836.6	23.36	23.50	1.033	0.430	0.444
82.	RMC 12.2k	Right side	4182	836.6	23.36	23.50	1.033	0.263	0.272
83.	RMC 12.2k	Left side	4182	836.6	23.36	23.50	1.033	0.116	0.120
84.	RMC 12.2k	Bottom Side	4182	836.6	23.36	23.50	1.033	0.108	0.112

LTE Band 2–Body SAR Test (Gap: 10mm)								
Plot No.	Mode	Test Position Body	Freque ncy	Output Power (dBm)	Rated Limit (dBm)	Scaling Factor	SAR1g (W/kg)	Scaled SAR1g (W/kg)
	Modulation, Bandwidth, RB		MHz					
85.	RMC QPSK 20MHz 1RB	Back Side	1860.0	22.87	23	1.030	0.280	0.289
86.	RMC QPSK 20MHz 1RB	Front Side	1860.0	22.87	23	1.030	0.266	0.274
87.	RMC QPSK 20MHz 1RB	Right side	1860.0	22.87	23	1.030	0.082	0.084
88.	RMC QPSK 20MHz 1RB	Left side	1860.0	22.87	23	1.030	0.08	0.082
89.	RMC QPSK 20MHz 1RB	Bottom Side	1860.0	22.87	23	1.030	0.212	0.218
90.	RMC QPSK 20MHz 50%RB	Back Side	1880.0	22.64	23	1.086	0.234	0.254
91.	RMC QPSK 20MHz 50%RB	Front Side	1880.0	22.64	23	1.086	0.212	0.230
92.	RMC QPSK 20MHz 50%RB	Right side	1880.0	22.64	23	1.086	0.075	0.081
93.	RMC QPSK 20MHz 50%RB	Left side	1880.0	22.64	23	1.086	0.069	0.075
94.	RMC QPSK 20MHz 50%RB	Bottom Side	1880.0	22.64	23	1.086	0.167	0.181

LTE Band 4–Body SAR Test (Gap: 10mm)								
Plot No.	Mode	Test Position Body	Freque ncy	Output Power (dBm)	Rated Limit (dBm)	Scaling Factor	SAR1g (W/kg)	Scaled SAR1g (W/kg)
	Modulation, Bandwidth, RB		MHz					
95.	RMC QPSK 20MHz 1RB	Back Side	1720.0	22.75	23	1.059	0.190	0.201
96.	RMC QPSK 20MHz 1RB	Front Side	1720.0	22.75	23	1.059	0.167	0.177
97.	RMC QPSK 20MHz 1RB	Right side	1720.0	22.75	23	1.059	0.005	0.005
98.	RMC QPSK 20MHz 1RB	Left side	1720.0	22.75	23	1.059	0.005	0.005
99.	RMC QPSK 20MHz 1RB	Bottom Side	1720.0	22.75	23	1.059	0.161	0.171
100.	RMC QPSK 20MHz 50%RB	Back Side	1732.5	22.85	23	1.035	0.159	0.165
101.	RMC QPSK 20MHz 50%RB	Front Side	1732.5	22.85	23	1.035	0.132	0.137
102.	RMC QPSK 20MHz 50%RB	Right side	1732.5	22.85	23	1.035	0.004	0.004
103.	RMC QPSK 20MHz 50%RB	Left side	1732.5	22.85	23	1.035	0.005	0.005
104.	RMC QPSK 20MHz 50%RB	Bottom Side	1732.5	22.85	23	1.035	0.126	0.130

LTE Band 5–Body SAR Test (Gap: 10mm)								
Plot No.	Mode	Test Position Body	Frequency	Output Power (dBm)	Rated Limit (dBm)	Scaling Factor	SAR1g (W/kg)	Scaled SAR1g (W/kg)
	Modulation, Bandwidth, RB		MHz					
105.	RMC QPSK 10MHz 1RB	Back Side	829.0	23.89	24	1.026	0.172	0.176
106.	RMC QPSK 10MHz 1RB	Front Side	829.0	23.89	24	1.026	0.132	0.135
107.	RMC QPSK 10MHz 1RB	Right side	829.0	23.89	24	1.026	0.005	0.005
108.	RMC QPSK 10MHz 1RB	Left side	829.0	23.89	24	1.026	0.005	0.005
109.	RMC QPSK 10MHz 1RB	Bottom Side	829.0	23.89	24	1.026	0.084	0.086
110.	RMC QPSK 10MHz 50%RB	Back Side	844.0	23.65	24	1.084	0.143	0.155
111.	RMC QPSK 10MHz 50%RB	Front Side	844.0	23.65	24	1.084	0.105	0.114
112.	RMC QPSK 10MHz 50%RB	Right side	844.0	23.65	24	1.084	0.005	0.005
113.	RMC QPSK 10MHz 50%RB	Left side	844.0	23.65	24	1.084	0.005	0.005
114.	RMC QPSK 10MHz 50%RB	Bottom Side	844.0	23.65	24	1.084	0.066	0.072

LTE Band 7–Body SAR Test (Gap: 10mm)								
Plot No.	Mode	Test Position Body	Frequency	Output Power (dBm)	Rated Limit (dBm)	Scaling Factor	SAR1g (W/kg)	Scaled SAR1g (W/kg)
	Modulation, Bandwidth, RB		MHz					
115.	RMC QPSK 20MHz 1RB	Back Side	2560.0	23.06	24	1.242	0.142	0.176
116.	RMC QPSK 20MHz 1RB	Front Side	2560.0	23.06	24	1.242	0.07	0.087
117.	RMC QPSK 20MHz 1RB	Right side	2560.0	23.06	24	1.242	0.006	0.007
118.	RMC QPSK 20MHz 1RB	Left side	2560.0	23.06	24	1.242	0.004	0.005
119.	RMC QPSK 20MHz 1RB	Bottom Side	2560.0	23.06	24	1.242	0.11	0.137
120.	RMC QPSK 20MHz 50%RB	Back Side	2535.0	23.49	24	1.125	0.111	0.125
121.	RMC QPSK 20MHz 50%RB	Front Side	2535.0	23.49	24	1.125	0.055	0.062
122.	RMC QPSK 20MHz 50%RB	Right side	2535.0	23.49	24	1.125	0.005	0.006
123.	RMC QPSK 20MHz 50%RB	Left side	2535.0	23.49	24	1.125	0.004	0.004
124.	RMC QPSK 20MHz 50%RB	Bottom Side	2535.0	23.49	24	1.125	0.092	0.103

WLAN 2.4GHz –Body SAR Test									
Plot No.	Mode	Test Position Body	Frequency		Output Power (dBm)	Rated Limit (dBm)	Scaling Factor	SAR1g (W/kg)	Scaled SAR1g (W/kg)
			CH.	MHz					
125.	802.11b	Back Side	01	2412	14.57	15	1.104	0.194	0.214
126.	802.11b	Front Side	01	2412	14.57	15	1.104	0.103	0.114
127.	802.11b	Left side	01	2412	14.57	15	1.104	0.104	0.115
128.	802.11b	Top Side	01	2412	14.57	15	1.104	0.089	0.098

### 9.3 Simultaneous Multi-band Transmission SAR Analysis

#### List of Mode for Simultaneous Multi-band Transmission

No.	Configurations	Head SAR	Body-worn SAR	Hotspot SAR
1	GSM(Voice) + WLAN(Data)	Yes	Yes	-
2	GPRS(Data) + WLAN(Data)	-	-	Yes
3	WCDMA (Voice)+ WLAN(Data)	Yes	Yes	-
4	HSDPA(Data) + WLAN(Data)	-	-	Yes
5	HSUPA(Data) + WLAN(Data)	-	-	Yes
6	LTE(Data) + WLAN(Data)	-	-	Yes
7	GSM(Voice) + Bluetooth(Data)	Yes	Yes	-
8	GPRS (Data) + Bluetooth(Data)	-	-	Yes
9	WCDMA(Voice) + Bluetooth(Data)	Yes	Yes	-
10	HSDPA(Data)+ Bluetooth(Data)	-	-	Yes
11	HSUPA(Data) + Bluetooth(Data)	-	-	Yes
12	LTE(Data) + Bluetooth(Data)	-	-	Yes

#### Remark:

1. GSM and WCDMA share the same antenna, and cannot transmit simultaneously.
2. WLAN and Bluetooth share the same antenna, and cannot transmit simultaneously.
3. According to the KDB 447498 D01 v06, when standalone SAR test exclusion applies to an antenna that transmits simultaneously with other antennas, the standalone SAR must be estimated according to following to determine simultaneous transmission SAR test exclusion:

(max. power of channel, including tune-up tolerance, mW)/(min. test separation distance, mm) $[\sqrt{f(\text{GHz})/x}]$  W/kg for test separation distances  $\leq 50$  mm;

where  $x = 7.5$  for 1-g SAR, and  $x = 18.75$  for 10-g SAR.

For simultaneous transmission analysis, Bluetooth SAR is estimated per KDB 447498 D01 v06 as below:

#### Bluetooth:

Tune-Up Power (dBm)	Max. Power (mW)	Distance (mm)	Frequency (GHz)	X	SAR(1g) 5mm	SAR(1g) 10mm
3.0	2.00	5/10	2.402	7.5	0.083	0.042

4. The maximum SAR summation is calculated based on the same configuration and test position.

## Head SAR

WWAN PCE +WIFI DTS					
WWAN Band		Exposure Position	Max SAR (mW/g)		Summed SAR (mW/g)
			WWAN PCS	WIFI DTS	
GSM	GSM850	Left Cheek	0.386	0.370	0.756
		Left Tilted	0.103	0.108	0.211
		Right Cheek	0.313	0.110	0.423
		Right Tilted	0.096	0.007	0.103
	PCS1900	Left Cheek	0.138	0.370	0.508
		Left Tilted	0.095	0.108	0.203
		Right Cheek	0.050	0.110	0.16
		Right Tilted	0.007	0.007	0.014
	GPRS850	Left Cheek	0.693	0.370	<b>1.063</b>
		Left Tilted	0.244	0.108	0.352
		Right Cheek	0.632	0.110	0.742
		Right Tilted	0.233	0.007	0.24
	GPRS1900	Left Cheek	0.130	0.370	0.5
		Left Tilted	0.071	0.108	0.179
		Right Cheek	0.160	0.110	0.27
		Right Tilted	0.095	0.007	0.102
WCDMA	Band V	Left Cheek	0.246	0.370	0.616
		Left Tilted	0.060	0.108	0.168
		Right Cheek	0.130	0.110	0.24
		Right Tilted	0.047	0.007	0.054
	Band II	Left Cheek	0.507	0.370	0.877
		Left Tilted	0.107	0.108	0.215
		Right Cheek	0.496	0.110	0.606
		Right Tilted	0.117	0.007	0.124
LTE	Band 2	Left Cheek	0.135	0.370	0.505
		Left Tilted	0.053	0.108	0.161
		Right Cheek	0.109	0.110	0.219
		Right Tilted	0.036	0.007	0.043
	Band 4	Left Cheek	0.111	0.370	0.481
		Left Tilted	0.033	0.108	0.141
		Right Cheek	0.095	0.110	0.205
		Right Tilted	0.006	0.007	0.013
	Band 5	Left Cheek	0.146	0.370	0.516
		Left Tilted	0.063	0.108	0.171
		Right Cheek	0.139	0.110	0.249
		Right Tilted	0.033	0.007	0.04
	Band 7	Left Cheek	0.017	0.370	0.387

		Left Tilted	0.005	0.108	0.113
		Right Cheek	0.010	0.110	0.12
		Right Tilted	0.005	0.007	0.012

WWAN PCE + Bluetooth					
WWAN Band		Exposure Position	Max SAR (mW/g)		Summed SAR (mW/g)
			WWAN PCS	BT DSS	
GSM	GSM850	Left Cheek	0.386	0.083	0.469
		Left Tilted	0.103	0.083	0.186
		Right Cheek	0.313	0.083	0.396
		Right Tilted	0.096	0.083	0.179
	PCS1900	Left Cheek	0.138	0.083	0.221
		Left Tilted	0.095	0.083	0.178
		Right Cheek	0.050	0.083	0.133
		Right Tilted	0.007	0.083	0.09
	GPRS850	Left Cheek	0.693	0.083	<b>0.776</b>
		Left Tilted	0.244	0.083	0.327
		Right Cheek	0.632	0.083	0.715
		Right Tilted	0.233	0.083	0.316
	GPRS1900	Left Cheek	0.130	0.083	0.213
		Left Tilted	0.071	0.083	0.154
		Right Cheek	0.160	0.083	0.243
		Right Tilted	0.095	0.083	0.178
WCDMA	Band V	Left Cheek	0.246	0.083	0.329
		Left Tilted	0.060	0.083	0.143
		Right Cheek	0.130	0.083	0.213
		Right Tilted	0.047	0.083	0.13
	Band II	Left Cheek	0.507	0.083	0.59
		Left Tilted	0.107	0.083	0.19
		Right Cheek	0.496	0.083	0.579
		Right Tilted	0.117	0.083	0.2
LTE	Band 2	Left Cheek	0.135	0.083	0.218
		Left Tilted	0.053	0.083	0.136
		Right Cheek	0.109	0.083	0.192
		Right Tilted	0.036	0.083	0.119
	Band 4	Left Cheek	0.111	0.083	0.194
		Left Tilted	0.033	0.083	0.116
		Right Cheek	0.095	0.083	0.178
		Right Tilted	0.006	0.083	0.089
	Band 5	Left Cheek	0.146	0.083	0.229
		Left Tilted	0.063	0.083	0.146
		Right Cheek	0.139	0.083	0.222
		Right Tilted	0.033	0.083	0.116

	Band 7	Left Cheek	0.017	0.083	0.1
		Left Tilted	0.005	0.083	0.088
		Right Cheek	0.010	0.083	0.093
		Right Tilted	0.005	0.083	0.088

**Body-worn SAR**

WWAN PCE + WIFI DTS					
WWAN Band		Exposure Position	Max SAR (mW/g)		Summed SAR (mW/g)
			WWAN PCS	WIFI DTS	
GSM	GSM850	Front	0.442	0.214	<b>0.656</b>
		Back	0.364	0.114	0.478
	PCS1900	Front	0.267	0.214	0.481
		Back	0.231	0.114	0.345
WCDMA	Band V	Front	0.424	0.214	0.638
		Back	0.372	0.114	0.486
	Band II	Front	0.336	0.214	0.55
		Back	0.444	0.114	0.558
LTE	Band 2	Front	0.289	0.214	0.503
		Back	0.274	0.114	0.388
	Band 4	Front	0.201	0.214	0.415
		Back	0.177	0.114	0.291
	Band 5	Front	0.176	0.214	0.39
		Back	0.135	0.114	0.249
	Band 7	Front	0.176	0.214	0.39
		Back	0.087	0.114	0.201

WWAN PCE + Bluetooth					
WWAN Band		Exposure Position	Max SAR (mW/g)		Summed SAR (mW/g)
			WWAN PCS	BT DTS	
GSM	GSM850	Front	0.442	0.042	0.484
		Back	0.364	0.042	0.406
	PCS1900	Front	0.267	0.042	0.309
		Back	0.231	0.042	0.273
WCDMA	Band V	Front	0.424	0.042	0.466
		Back	0.372	0.042	0.414
	Band II	Front	0.336	0.042	0.378
		Back	0.444	0.042	<b>0.486</b>
LTE	Band 2	Front	0.289	0.042	0.331
		Back	0.274	0.042	0.316
	Band 4	Front	0.201	0.042	0.243
		Back	0.177	0.042	0.219
	Band 5	Front	0.176	0.042	0.218
		Back	0.135	0.042	0.177



	Band 7	Back	0.135	0.042	0.177
		Front	0.176	0.042	0.218
		Back	0.087	0.042	0.129

**Hotspot SAR**

WWAN PCE + WLAN DTS					
WWAN Band		Exposure Position	Max SAR (W/kg)		Summed SAR (W/kg)
			WWAN PCS	WLAN DTS	
GSM	GSM850	Front	0.771	0.214	<b>0.985</b>
		Back	0.680	0.114	0.794
		Right side	0.398	-	0.398
		Left side	0.138	0.115	0.253
		Top side	-	0.098	0.098
		Bottom side	0.153	-	0.153
	PCS1900	Front	0.439	0.214	0.653
		Back	0.443	0.114	0.557
		Right side	0.373	-	0.373
		Left side	0.117	0.115	0.232
		Top side	-	0.098	0.098
		Bottom side	0.117	-	0.117
WCDMA	Band V	Front	0.424	0.214	0.638
		Back	0.372	0.114	0.486
		Right side	0.361	-	0.361
		Left side	0.116	0.115	0.231
		Top side	-	0.098	0.098
		Bottom side	0.115	-	0.115
	Band II	Front	0.336	0.214	0.55
		Back	0.444	0.114	0.558
		Right side	0.272	-	0.272
		Left side	0.120	0.115	0.235
		Top side	-	0.098	0.098
		Bottom side	0.112	-	0.112
LTE	B2	Front	0.289	0.214	0.503
		Back	0.274	0.114	0.388
		Right side	0.084	-	0.084
		Left side	0.082	0.115	0.197

		Top side	-	0.098	0.098
		Bottom side	0.218	-	0.218
	B4	Front	0.201	0.214	0.415
		Back	0.177	0.114	0.291
		Right side	0.005	-	0.005
		Left side	0.005	0.115	0.12
		Top side	-	0.098	0.098
		Bottom side	0.171	-	0.171
	B5	Front	0.176	0.214	0.39
		Back	0.135	0.114	0.249
		Right side	0.005	-	0.005
		Left side	0.005	0.115	0.12
		Top side	-	0.098	0.098
		Bottom side	0.086	-	0.086
	B7	Front	0.176	0.214	0.39
		Back	0.087	0.114	0.201
		Right side	0.007	-	0.007
		Left side	0.005	0.115	0.12
		Top side	-	0.098	0.098
		Bottom side	0.137	-	0.137

WWAN PCE + Bluetooth					
WWAN Band		Exposure Position	Max SAR (W/kg)		Summed SAR (W/kg)
			WWAN PCS	WLAN DTS	
GSM	GSM850	Front	0.771	0.042	<b>0.813</b>
		Back	0.680	0.042	0.722
		Right side	0.398	-	0.398
		Left side	0.138	0.042	0.18
		Top side	-	0.042	0.042
		Bottom side	0.153	-	0.153
	PCS1900	Front	0.439	0.042	0.481
		Back	0.443	0.042	0.485
		Right side	0.373	-	0.373
		Left side	0.117	0.042	0.159
		Top side	-	0.042	0.042
		Bottom side	0.117	-	0.117

WCDMA	Band V	Front	0.424	0.042	0.466
		Back	0.372	0.042	0.414
		Right side	0.361	-	0.361
		Left side	0.116	0.042	0.158
		Top side	-	0.042	0.042
		Bottom side	0.115	-	0.115
	Band II	Front	0.336	0.042	0.378
		Back	0.444	0.042	0.486
		Right side	0.272	-	0.272
		Left side	0.120	0.042	0.162
		Top side	-	0.042	0.042
		Bottom side	0.112	-	0.112
LTE	B2	Front	0.289	0.042	0.331
		Back	0.274	0.042	0.316
		Right side	0.084	-	0.084
		Left side	0.082	0.042	0.124
		Top side	-	0.042	0.042
		Bottom side	0.218	-	0.218
	B4	Front	0.201	0.042	0.243
		Back	0.177	0.042	0.219
		Right side	0.005	-	0.005
		Left side	0.005	0.042	0.047
		Top side	-	0.042	0.042
		Bottom side	0.171	-	0.171
	B5	Front	0.176	0.042	0.218
		Back	0.135	0.042	0.177
		Right side	0.005	-	0.005
		Left side	0.005	0.042	0.047
		Top side	-	0.042	0.042
		Bottom side	0.086	-	0.086
	B7	Front	0.176	0.042	0.218
		Back	0.087	0.042	0.129
		Right side	0.007	-	0.007
		Left side	0.005	0.042	0.047
		Top side	-	0.042	0.042
		Bottom side	0.137	-	0.137

## 10. Measurement Uncertainty

### 10.1 Uncertainty for EUT SAR Test

a	b	c	d	e= f(d,k)	f	g	h= c*f/e	i= c*g/e	k
Uncertainty Component	Sec.	Tol (+- %)	Prob. Dist.	Div.	Ci (1g)	Ci (10g)	1g Ui (+- %)	10g Ui (+- %)	Vi
<b>Measurement System</b>									
Probe calibration	E.2.1	7.0	N	1	1	1	7.00	7.00	$\infty$
Axial Isotropy	E.2.2	2.5	R	$\sqrt{3}$	$(1_{Cp})^{1/2}$	$(1_{Cp})^{1/2}$	1.02	1.02	$\infty$
Hemispherical Isotropy	E.2.2	4.0	R	$\sqrt{3}$	$(Cp)^{1/2}$	$(Cp)^{1/2}$	1.63	1.63	$\infty$
Boundary effect	E.2.3	1.0	R	$\sqrt{3}$	1	1	0.58	0.58	$\infty$
Linearity	E.2.4	5.0	R	$\sqrt{3}$	1	1	2.89	2.89	$\infty$
System detection limits	E.2.5	1.0	R	$\sqrt{3}$	1	1	0.58	0.58	$\infty$
Readout Electronics	E.2.6	0.02	N	1	1	1	0.02	0.02	$\infty$
Reponse Time	E.2.7	3.0	R	$\sqrt{3}$	1	1	1.73	1.73	$\infty$
Integration Time	E.2.8	2.0	R	$\sqrt{3}$	1	1	1.15	1.15	$\infty$
RF ambient Conditions – Noise	E.6.1	3.0	R	$\sqrt{3}$	1	1	1.73	1.73	$\infty$
RF ambient Conditions - Reflections	E.6.1	3.0	R	$\sqrt{3}$	1	1	1.73	1.73	$\infty$
Probe positioner Mechanical Tolerance	E.6.2	2.0	R	$\sqrt{3}$	1	1	1.15	1.15	$\infty$
Probe positioning with respect to Phantom Shell	E.6.3	0.05	R	$\sqrt{3}$	1	1	0.03	0.03	$\infty$
Extrapolation, interpolation and integration Algorithms for Max. SAR Evaluation	E.5	5.0	R	$\sqrt{3}$	1	1	2.89	2.89	$\infty$
<b>Test Sample Related</b>									
Test sample positioning	E.4.2	0.03	N	1	1	1	0.03	0.03	N-1
Device Holder Uncertainty	E.4.1	5.00	N	1	1	1	5.00	5.00	
Output power Variation - SAR drift measurement	E.2.9	12.02	R	$\sqrt{3}$	1	1	6.94	6.94	$\infty$
SAR scaling	E6.5	0.0	R	$\sqrt{3}$	1	1	0.0	0.0	$\infty$
<b>Phantom and Tissue Parameters</b>									
Phantom Uncertainty (Shape and thickness tolerances)	E.3.1	0.05	R	$\sqrt{3}$	1	1	0.03	0.03	$\infty$
Uncertainty in SAR correction for deviations in permittivity and conductivity	E3.2	1.9	R	$\sqrt{3}$	1	0.84	1.10	0.90	$\infty$
Liquid conductivity - deviation	E.3.2	5.00	R	$\sqrt{3}$	0.64	0.43	1.85	1.24	$\infty$

from target value										
Liquid conductivity measurement uncertainty	E.3.3	5.00	N	1	0.64	0.43	3.20	2.15	$\infty$	
Liquid permittivity - deviation from target value	E.3.2	0.37	R	$\sqrt{3}$	0.6	0.49	0.13	0.10	$\infty$	
Liquid permittivity measurement uncertainty	E.3.3	10.00	N	1	0.6	0.49	6.00	4.90	$\infty$	
Combined Standard Uncertainty			RSS				12.98	12.53		
Expanded Uncertainty (95% Confidence interval)			K=2				25.32	24.43		

## 10.2 Uncertainty for System Performance Check

a	b	c	d	e= f(d,k)	f	g	h= c*f/e	i= c*g/e	k
Uncertainty Component	Sec.	Tol (+-%)	Prob. Dist.	Div.	Ci (1g)	Ci (10g)	1g Ui (+-%)	10g Ui (+-%)	Vi
<b>Measurement System</b>									
Probe calibration	E.2.1	7.0	N	1	1	1	7.00	7.00	$\infty$
Axial Isotropy	E.2.2	2.5	R	$\sqrt{3}$	$(1_{Cp})^{1/2}$	$(1_{Cp})^{1/2}$	1.02	1.02	$\infty$
Hemispherical Isotropy	E.2.2	4.0	R	$\sqrt{3}$	$(Cp)^{1/2}$	$(Cp)^{1/2}$	1.63	1.63	$\infty$
Boundary effect	E.2.3	1.0	R	$\sqrt{3}$	1	1	0.58	0.58	$\infty$
Linearity	E.2.4	5.0	R	$\sqrt{3}$	1	1	2.89	2.89	$\infty$
System detection limits	E.2.5	1.0	R	$\sqrt{3}$	1	1	0.58	0.58	$\infty$
Modulation response	E.2.5	0	R	$\sqrt{3}$	0	0	0.0	0.0	$\infty$
Readout Electronics	E.2.6	0.02	N	1	1	1	0.02	0.02	$\infty$
Reponse Time	E.2.7	3.0	R	$\sqrt{3}$	1	1	1.73	1.73	$\infty$
Integration Time	E.2.8	2.0	R	$\sqrt{3}$	1	1	1.15	1.15	$\infty$
RF ambient Conditions – Noise	E.6.1	3.0	R	$\sqrt{3}$	1	1	1.73	1.73	$\infty$
RF ambient Conditions - Reflections	E.6.1	3.0	R	$\sqrt{3}$	1	1	1.73	1.73	$\infty$
Probe positioner Mechanical Tolerance	E.6.2	2.0	R	$\sqrt{3}$	1	1	1.15	1.15	$\infty$
Probe positioning with respect to Phantom Shell	E.6.3	0.05	R	$\sqrt{3}$	1	1	0.03	0.03	$\infty$
Extrapolation, interpolation and integration Algorithms for Max.	E.5.2	5.0	R	$\sqrt{3}$	1	1	2.89	2.89	$\infty$

SAR Evaluation									
<b>Dipole</b>									
Dipole axis to liquid Distance	8,E.4.2	1.00	N	$\sqrt{3}$	1	1	0.58	0.58	N-1
Input power and SAR drift measurement	8,6.6.2	12.02	R	$\sqrt{3}$	1	1	6.94	6.94	$\infty$
Deviation of experimental dipole from numerical dipole	E.6.4	5.5	R	$\sqrt{3}$	1	1	3.20	3.20	$\infty$
<b>Phantom and Tissue Parameters</b>									
Phantom Uncertainty (Shape and thickness tolerances)	E.3.1	0.05	R	$\sqrt{3}$	1	1	0.03	0.03	$\infty$
Uncertainty in SAR correction for deviations in permittivity and conductivity	E3.2	2.0	R	$\sqrt{3}$	1	0.84	1.10	1.10	$\infty$
Liquid conductivity - deviation from target value	E.3.2	5.00	R	$\sqrt{3}$	0.64	0.43	1.85	1.24	
Liquid conductivity - measurement uncertainty	E.3.3	5.00	N	1	0.64	0.43	3.20	2.15	
Liquid permittivity - deviation from target value	E.3.2	0.37	R	$\sqrt{3}$	0.6	0.49	0.13	0.10	
Liquid permittivity - measurement uncertainty	E.3.3	10.00	N	1	0.6	0.49	6.00	4.90	M
Combined Standard Uncertainty			RSS				12.00	11.50	
Expanded Uncertainty (95% Confidence interval)			K=2				23.39	22.43	

## Annex A. Plots of System Performance Check

# MEASUREMENT 1

### For Head Liquid

Type: Validation measurement (Fast, 75.00 %)

Date of measurement: 08/20/2017

Measurement duration: 7 minutes 21 seconds

E-field Probe: SSE5 - SN 09/13 EP168; ConvF: 6.93; Calibrated: 06/01/2017

### A. Experimental conditions

<b>Area Scan</b>	dx=8mm dy=8mm
<b>Phantom</b>	Validation plane
<b>Device Position</b>	Dipole
<b>Band</b>	CW835
<b>Signal</b>	Duty Cycle 1:1

### B. SAR Measurement Results

<b>Frequency (MHz)</b>	835.000000
<b>Relative Permittivity (real part)</b>	41.110245
<b>Conductivity (S/m)</b>	0.871245
<b>Power Variation (%)</b>	0.038437
<b>Ambient Temperature</b>	21.1
<b>Liquid Temperature</b>	21.3

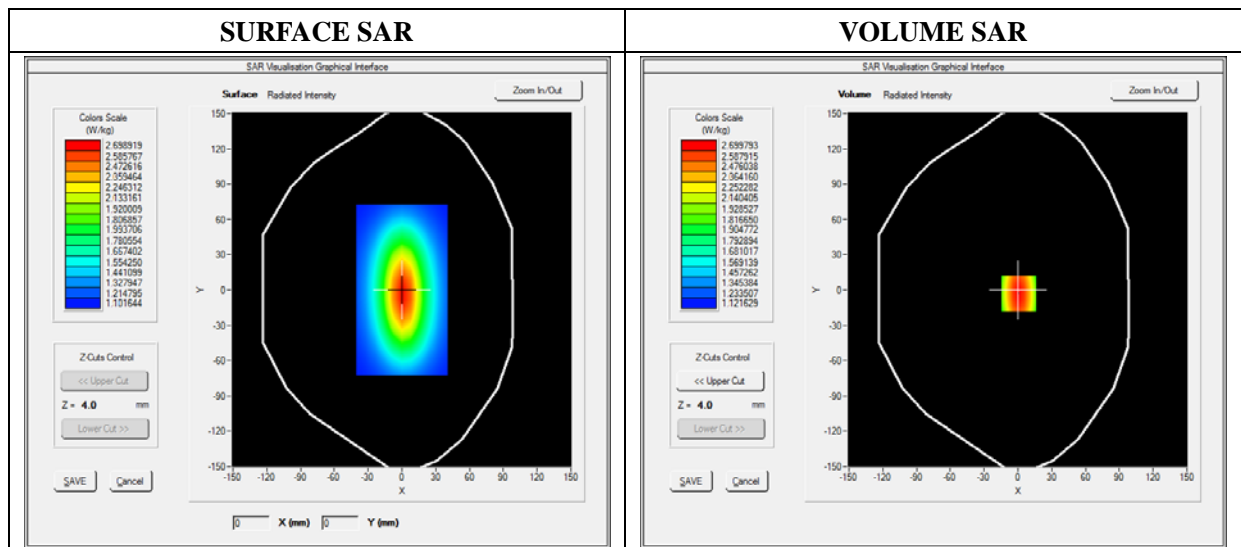

Maximum location: X=0.00, Y=0.00

SAR 10g (W/Kg)	1.129489
SAR 1g (W/Kg)	2.411253

Z Axis Scan

Z (mm)	0.00	4.00	9.00	14.00	19.00	24.00	29.00
SAR (W/Kg)	0.0000	2.4900	1.8942	1.4811	1.3541	1.1123	1.0539

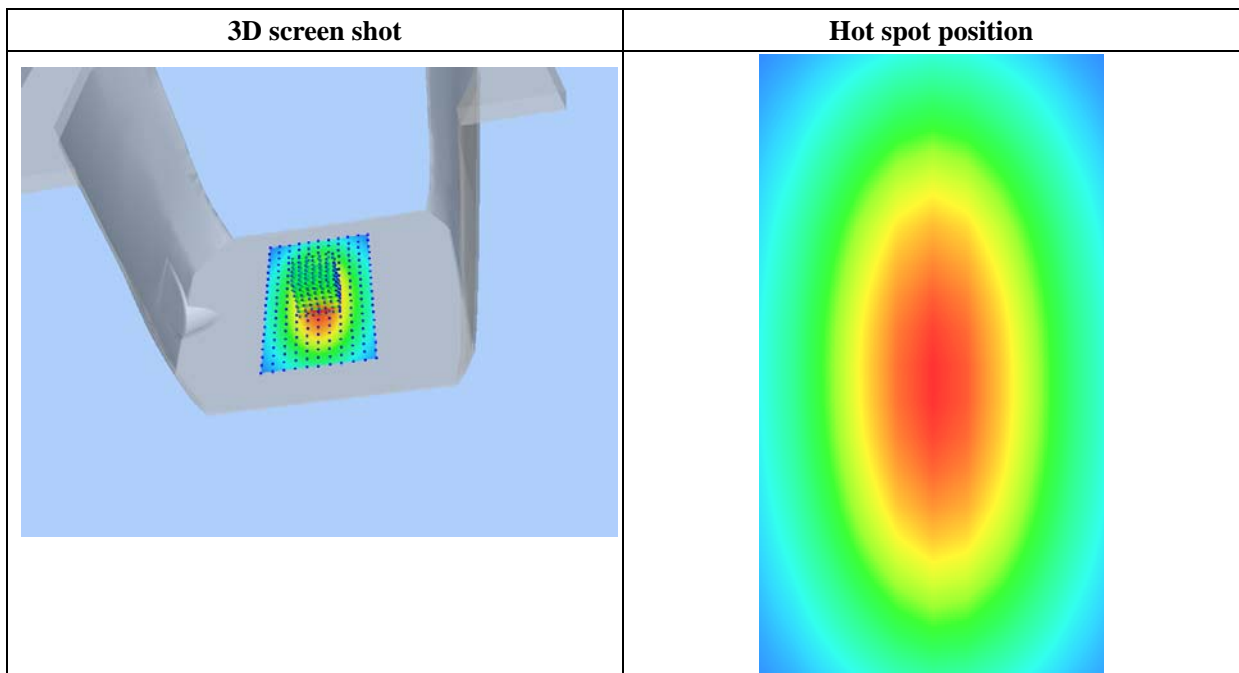
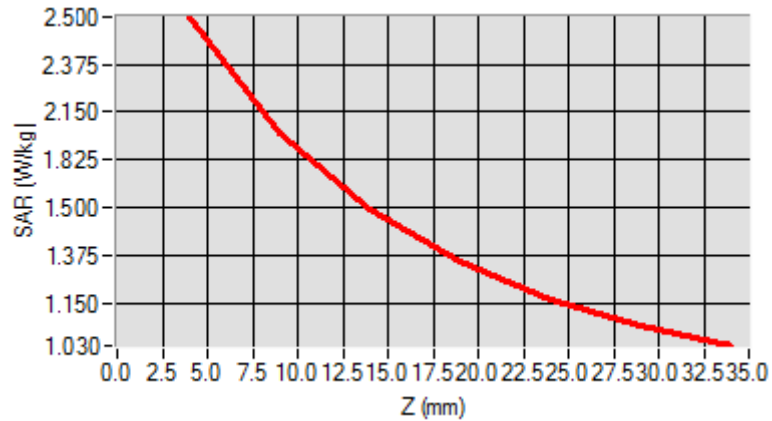



## MEASUREMENT 2

### For Head Liquid

Type: Validation measurement (Fast, 75.00 %)

Date of measurement: 08/20/2017

Measurement duration: 12 minutes 21 seconds

E-field Probe: SSE5 - SN 09/13 EP168; ConvF: 5.84; Calibrated: 06/01/2017

### A. Experimental conditions

<b>Area Scan</b>	dx=8mm dy=8mm
<b>Phantom</b>	Validation plane
<b>Device Position</b>	Dipole
<b>Band</b>	CW1800
<b>Signal</b>	CW (Crest factor: 1.0)

### B. SAR Measurement Results

<b>Frequency (MHz)</b>	1800.000000
<b>Relative Permittivity (real part)</b>	39.024890
<b>Conductivity (S/m)</b>	1.371250
<b>Power Variation (%)</b>	1.401232
<b>Ambient Temperature</b>	21.1
<b>Liquid Temperature</b>	21.2

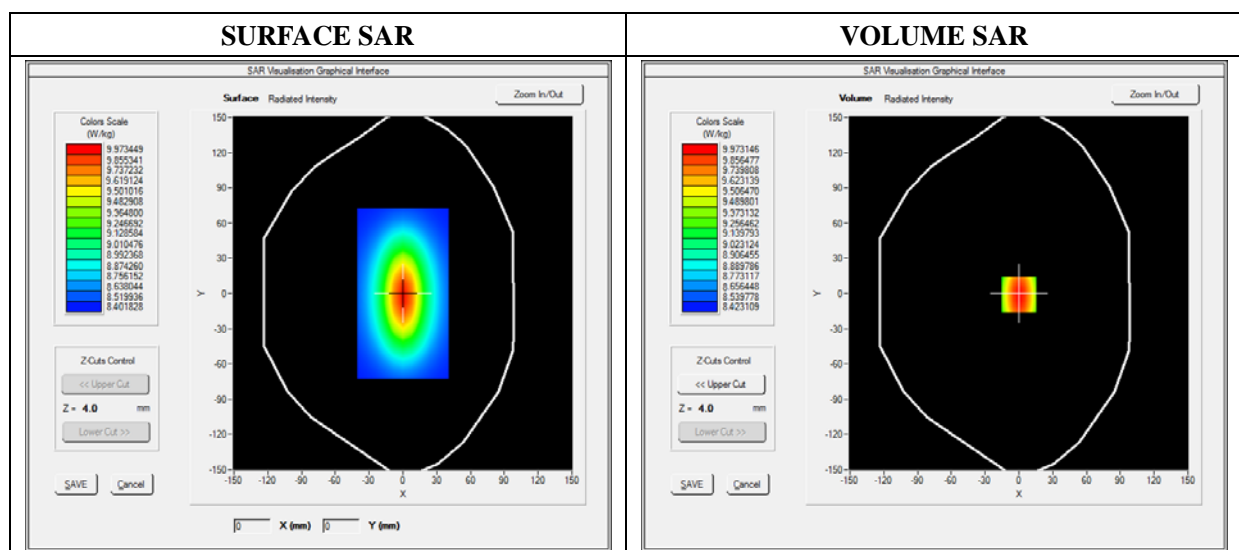

Maximum location: X=0.00, Y=0.00

SAR 10g (W/Kg)	5.171252
SAR 1g (W/Kg)	9.611250

Z Axis Scan

Z (mm)	0.00	4.00	9.00	14.00	19.00	24.00	29.00
SAR (W/Kg)	0.0000	10.3455	7.1125	5.1026	3.425	3.0242	2.1125

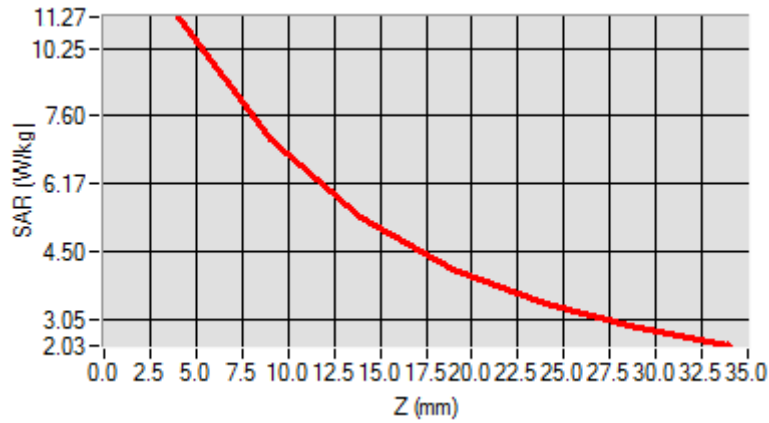

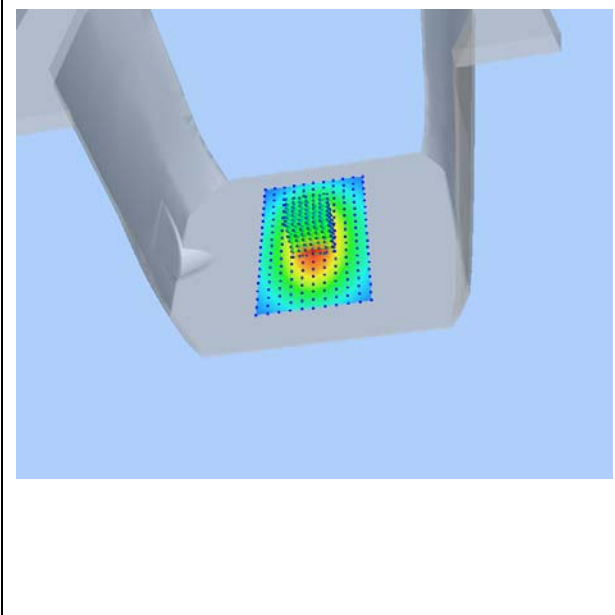
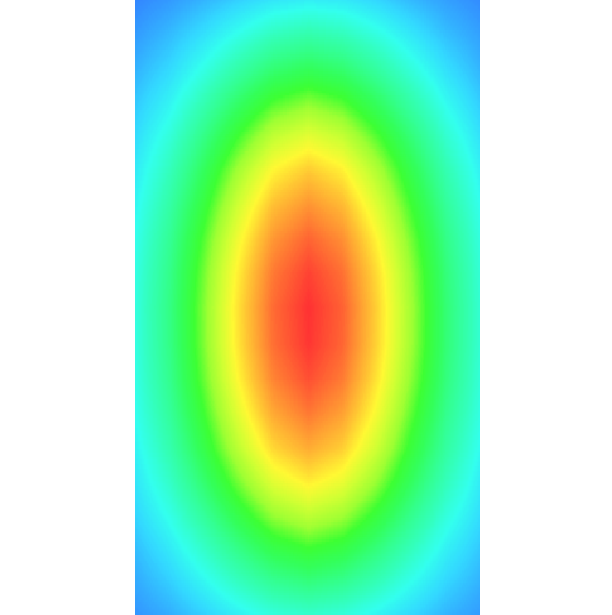
3D screen shot	Hot spot position
	

## MEASUREMENT 3

### For Head Liquid

Type: Validation measurement (Fast, 75.00 %)

Date of measurement: 08/20/2017

Measurement duration: 12 minutes 21 seconds

E-field Probe: SSE5 - SN 09/13 EP168; ConvF: 6.35; Calibrated: 06/01/2017

### A. Experimental conditions

<b>Area Scan</b>	dx=8mm dy=8mm
<b>Phantom</b>	Validation plane
<b>Device Position</b>	Dipole
<b>Band</b>	CW1900
<b>Signal</b>	Duty Cycle 1:1

### B. SAR Measurement Results

<b>Frequency (MHz)</b>	1900.000000
<b>Relative Permittivity (real part)</b>	38.560124
<b>Conductivity (S/m)</b>	1.380369
<b>Power Variation (%)</b>	1.022540
<b>Ambient Temperature</b>	21.1
<b>Liquid Temperature</b>	21.3

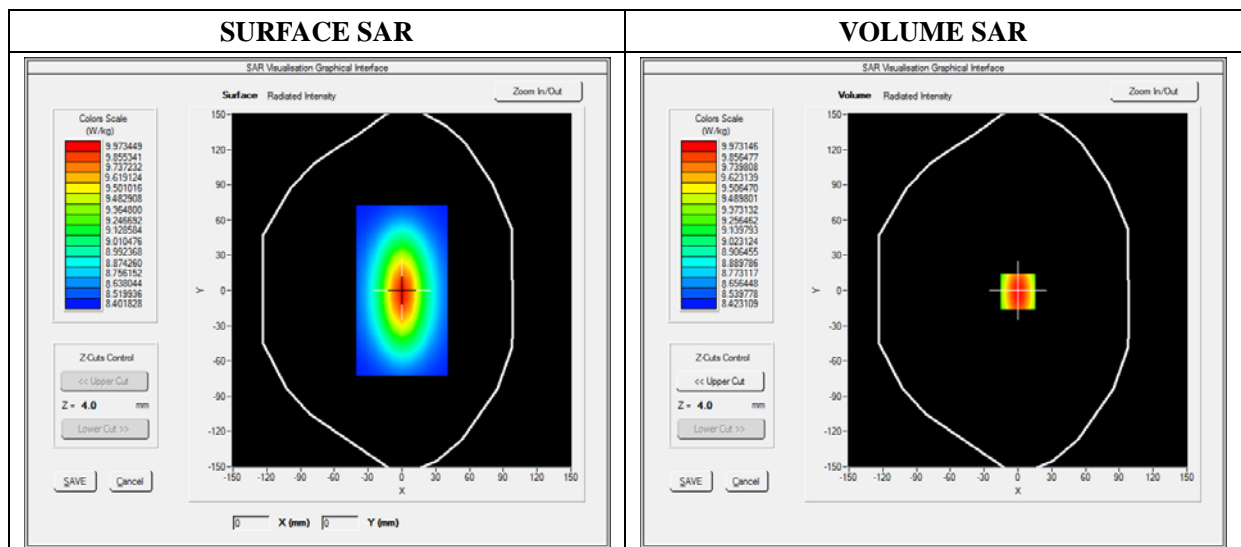

Maximum location: X=0.00, Y=0.00

SAR 10g (W/Kg)	7.174526
SAR 1g (W/Kg)	9.913214

Z Axis Scan

Z (mm)	0.00	4.00	9.00	14.00	19.00	24.00	29.00
SAR (W/Kg)	0.0000	10.2354	6.8400	5.0121	4.1189	3.0522	2.8424

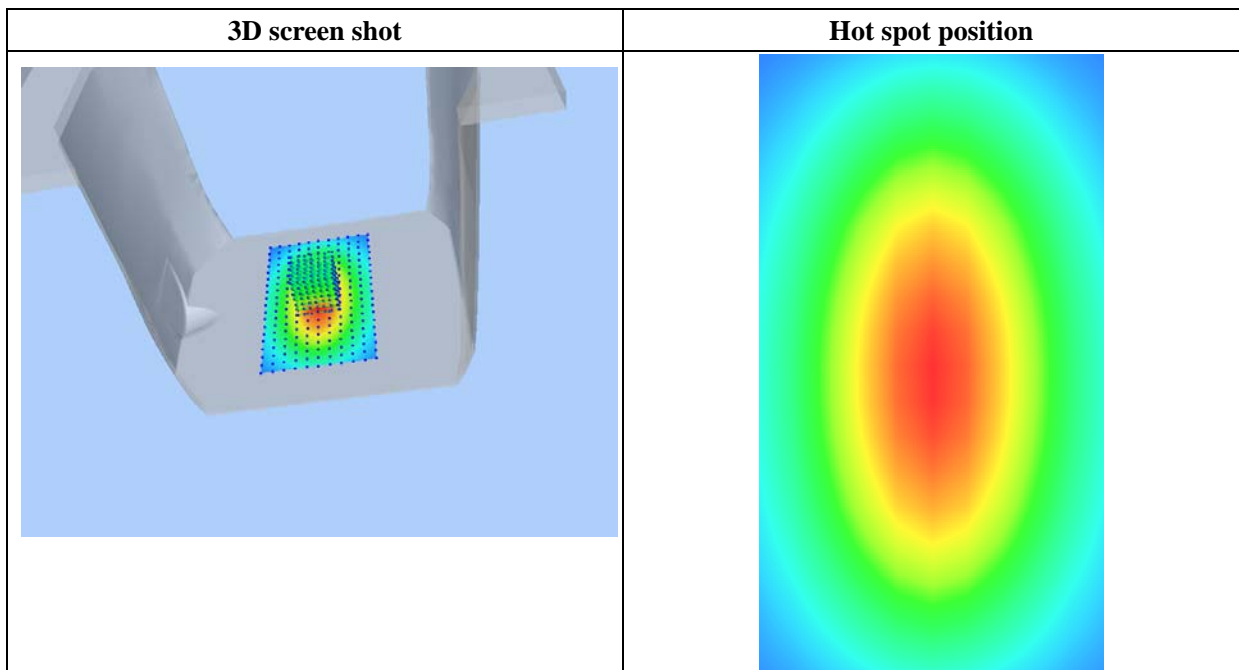
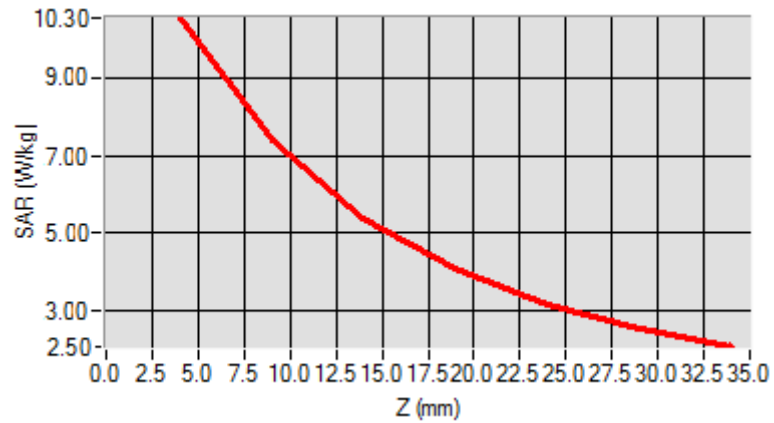

# MEASUREMENT 4

## For Head Liquid

Type: Validation measurement (Fast, 75.00 %)

Date of measurement: 08/20/2017

Measurement duration: 12 minutes 21 seconds

E-field Probe: SSE5 - SN 09/13 EP168; ConvF: 5.64; Calibrated: 06/01/2017

### A. Experimental conditions

<b>Area Scan</b>	dx=8mm dy=8mm
<b>Phantom</b>	Validation plane
<b>Device Position</b>	Dipole
<b>Band</b>	CW2450
<b>Signal</b>	Duty Cycle 1:1

### B. SAR Measurement Results

<b>Frequency (MHz)</b>	2450.000000
<b>Relative Permittivity (real part)</b>	38.153660
<b>Conductivity (S/m)</b>	1.740236
<b>Power Variation (%)</b>	1.141452
<b>Ambient Temperature</b>	21.1
<b>Liquid Temperature</b>	21.2

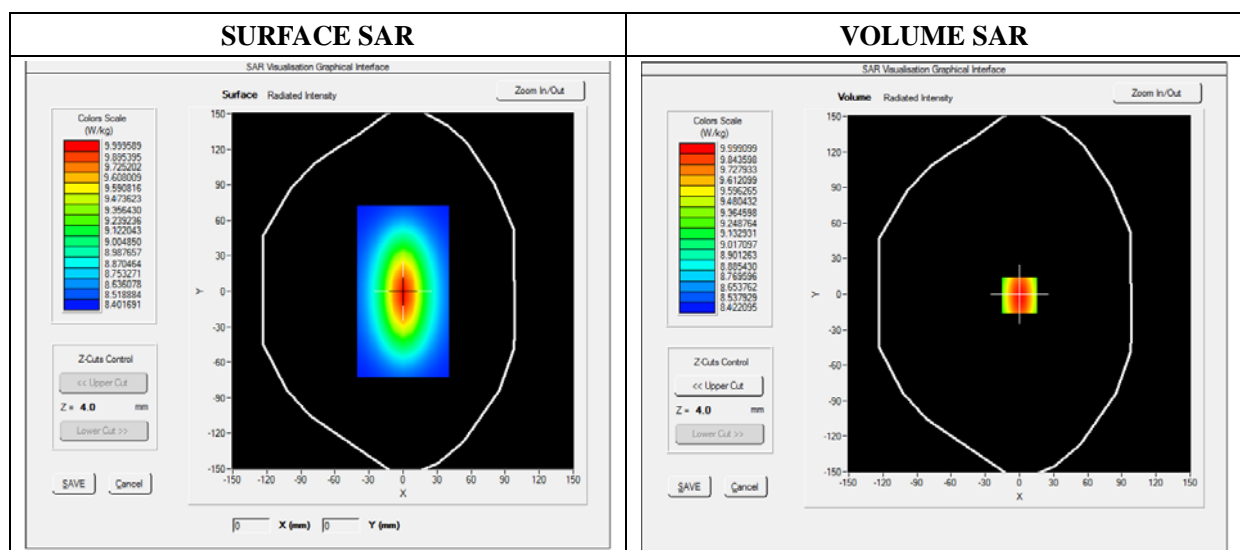

Maximum location: X=0.00, Y=0.00

SAR 10g (W/Kg)	8.020427
SAR 1g (W/Kg)	13.452457

Z Axis Scan

Z (mm)	0.00	4.00	9.00	14.00	19.00	24.00	29.00
SAR (W/Kg)	0.0000	14.1034	12.0012	10.2624	7.4715	5.9022	4.5114

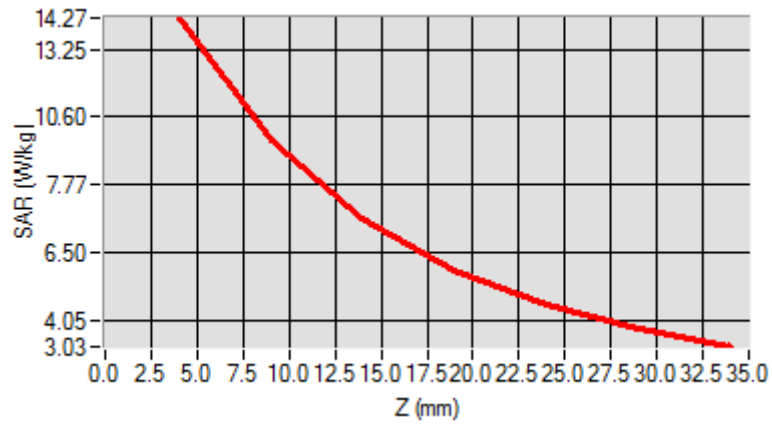

3D screen shot

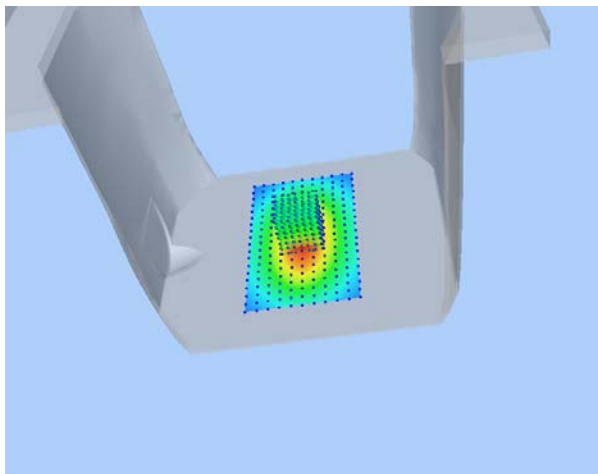

Hot spot position

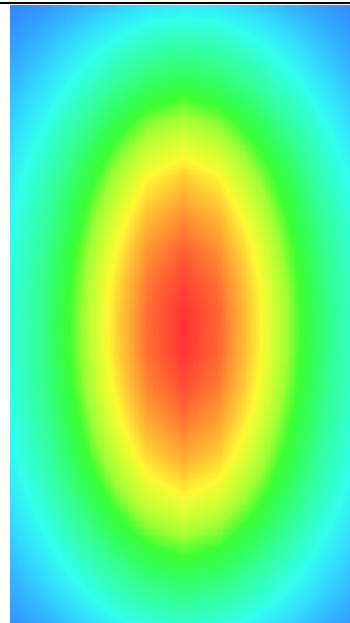

# MEASUREMENT 5

## For Head Liquid

Type: Validation measurement (Fast, 75.00 %)

Date of measurement: 08/20/2017

Measurement duration: 12 minutes 21 seconds

E-field Probe: SSE5 - SN 09/13 EP168; ConvF: 5.37; Calibrated: 06/01/2017

### A. Experimental conditions

Area Scan	dx=8mm dy=8mm
Phantom	Validation plane
Device Position	Dipole
Band	CW2600
Signal	Duty Cycle 1:1

### B. SAR Measurement Results

Frequency (MHz)	2600.000000
Relative Permittivity (real part)	38.631092
Conductivity (S/m)	1.930182
Power Variation (%)	1.028221
Ambient Temperature	21.1
Liquid Temperature	21.2

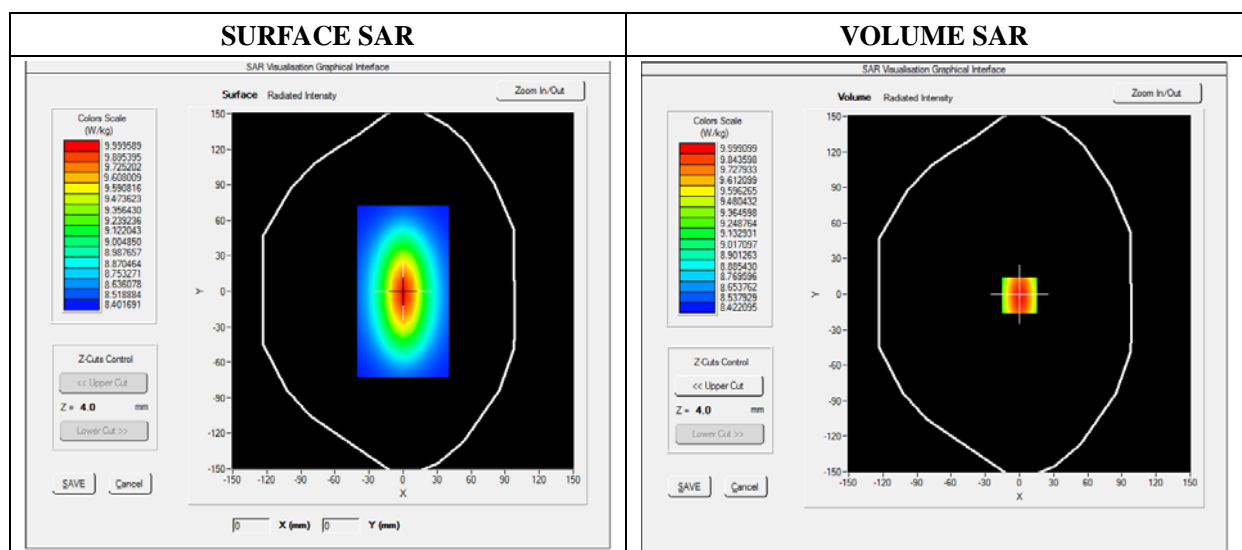

Maximum location: X=0.00, Y=0.00

SAR 10g (W/Kg)	8.270822
SAR 1g (W/Kg)	13.670282

Z Axis Scan

Z (mm)	0.00	4.00	9.00	14.00	19.00	24.00	29.00
SAR (W/Kg)	0.0000	14.1034	12.1354	10.2965	7.4854	5.9354	4.5186

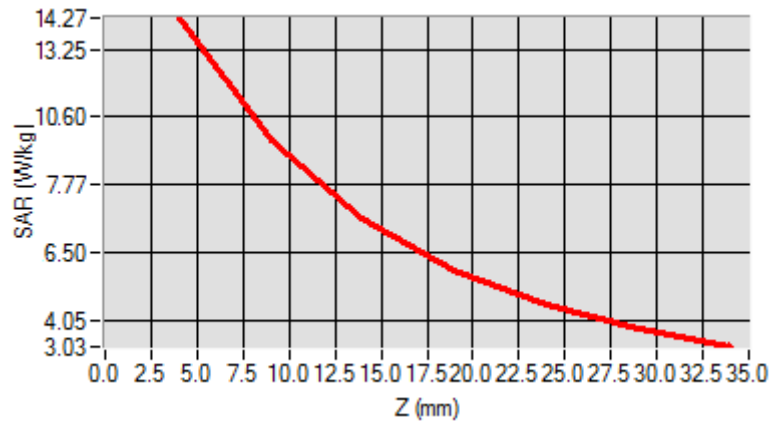

3D screen shot

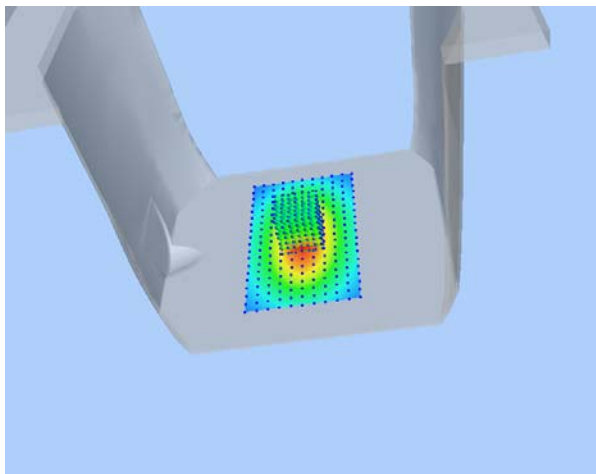

Hot spot position

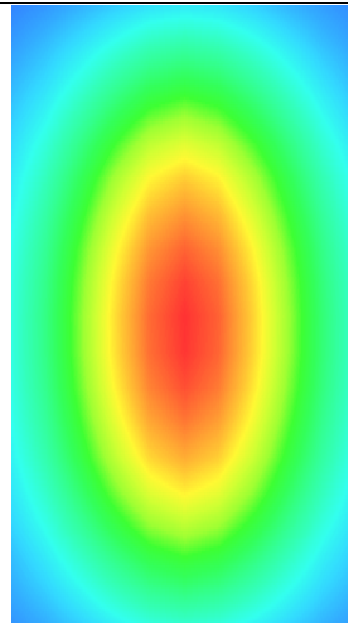



## MEASUREMENT 6

### For Body Liquid

Type: Validation measurement (Fast, 75.00 %)

Date of measurement: 08/20/2017

Measurement duration: 12 minutes 21 seconds

E-field Probe: SSE5 - SN 09/13 EP168; ConvF: 7.13; Calibrated: 06/01/2017

### A. Experimental conditions

<b>Area Scan</b>	dx=8mm dy=8mm
<b>Phantom</b>	Validation plane
<b>Device Position</b>	Dipole
<b>Band</b>	CW835
<b>Signal</b>	Duty Cycle 1:1

### B. SAR Measurement Results

<b>Frequency (MHz)</b>	835.000000
<b>Relative Permittivity (real part)</b>	54.851214
<b>Conductivity (S/m)</b>	0.951454
<b>Power Variation (%)</b>	0.901472
<b>Ambient Temperature</b>	21.1
<b>Liquid Temperature</b>	21.3

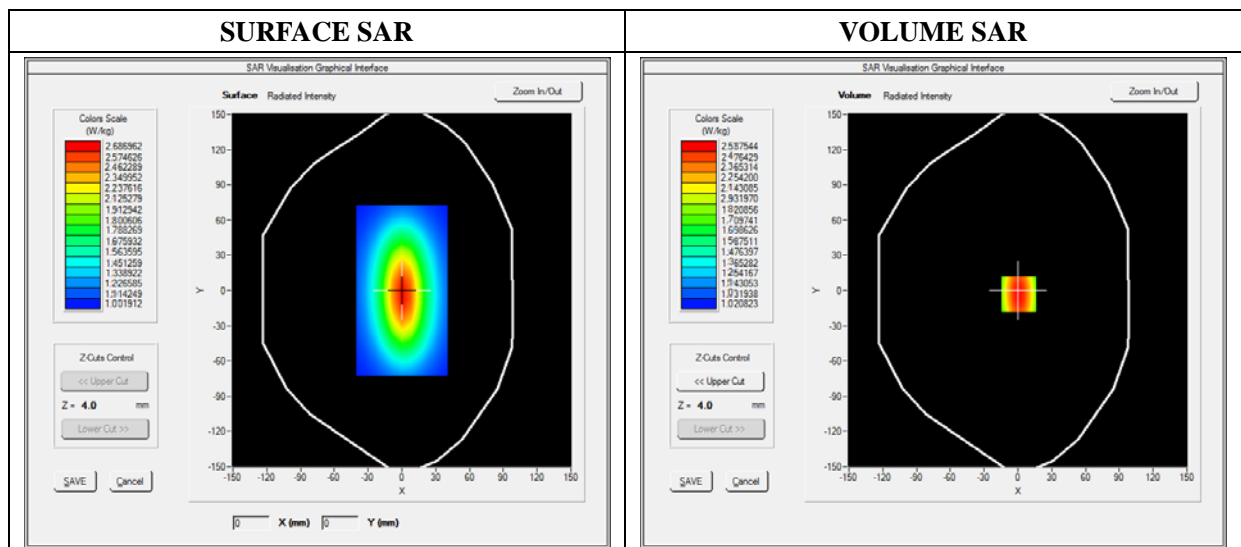

Maximum location: X=0.00, Y=0.00

SAR 10g (W/Kg)	1.028956
SAR 1g (W/Kg)	2.354211

Z Axis Scan

Z (mm)	0.00	4.00	9.00	14.00	19.00	24.00	29.00
SAR (W/Kg)	0.0000	2.5789	1.1300	0.8795	0.5940	0.5011	0.5100

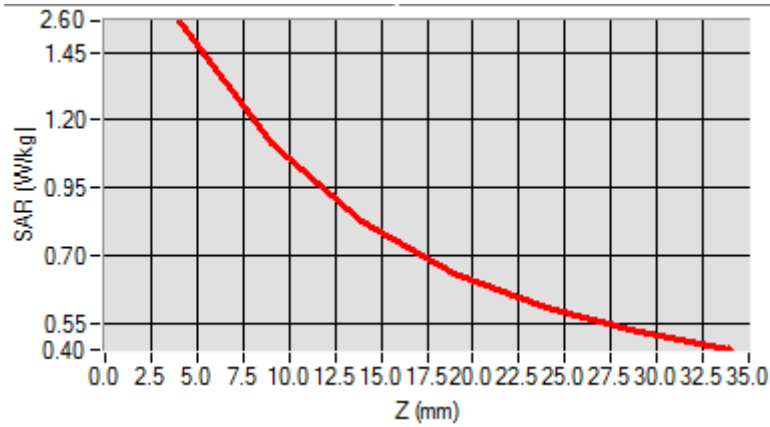

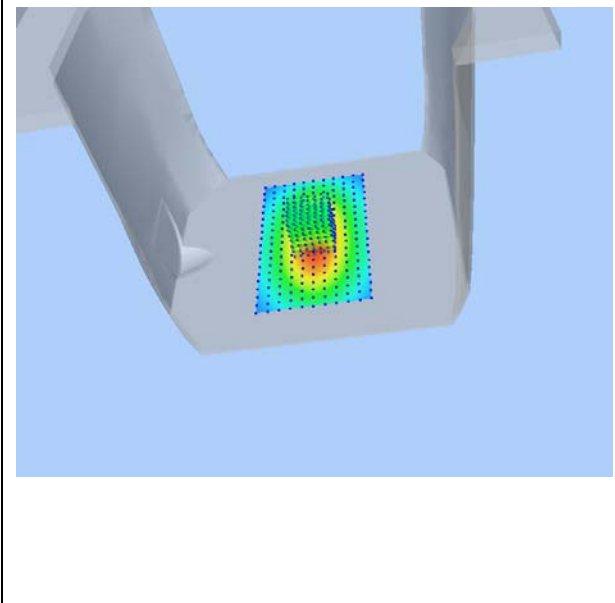
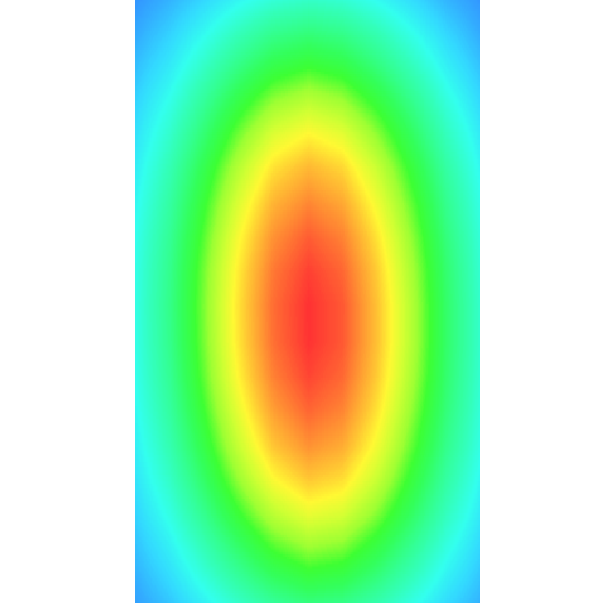
3D screen shot	Hot spot position
	

# MEASUREMENT 7

## For Body Liquid

Type: Validation measurement (Fast, 75.00 %)

Date of measurement: 08/20/2017

Measurement duration: 12 minutes 21 seconds

E-field Probe: SSE5 - SN 09/13 EP168; ConvF: 6.06; Calibrated: 06/01/2017

### A. Experimental conditions

<b>Area Scan</b>	dx=8mm dy=8mm
<b>Phantom</b>	Validation plane
<b>Device Position</b>	Dipole
<b>Band</b>	CW1800
<b>Signal</b>	CW (Crest factor: 1.0)

### B. SAR Measurement Results

<b>Frequency (MHz)</b>	1800.000000
<b>Relative Permittivity (real part)</b>	51.224510
<b>Conductivity (S/m)</b>	1.461261
<b>Power Variation (%)</b>	0.845690
<b>Ambient Temperature</b>	21.1
<b>Liquid Temperature</b>	21.2

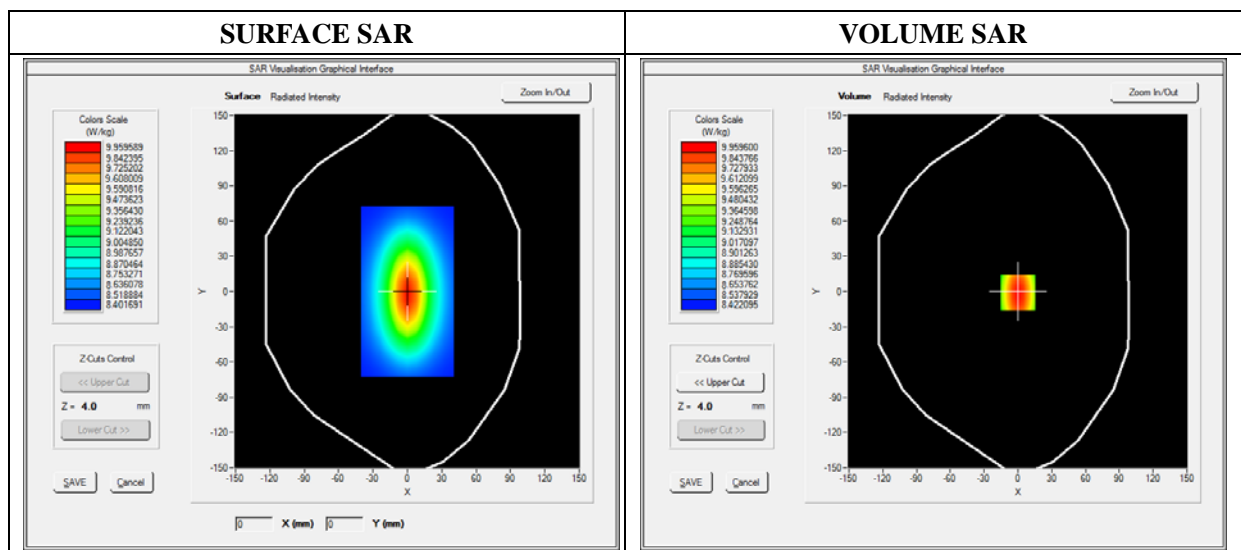

Maximum location: X=0.00, Y=0.00

SAR 10g (W/Kg)	5.221202
SAR 1g (W/Kg)	9.582560

Z Axis Scan

Z (mm)	0.00	4.00	9.00	14.00	19.00	24.00	29.00
SAR (W/Kg)	0.0000	11.2425	9.4123	8.0345	6.9125	6.3092	3.9460

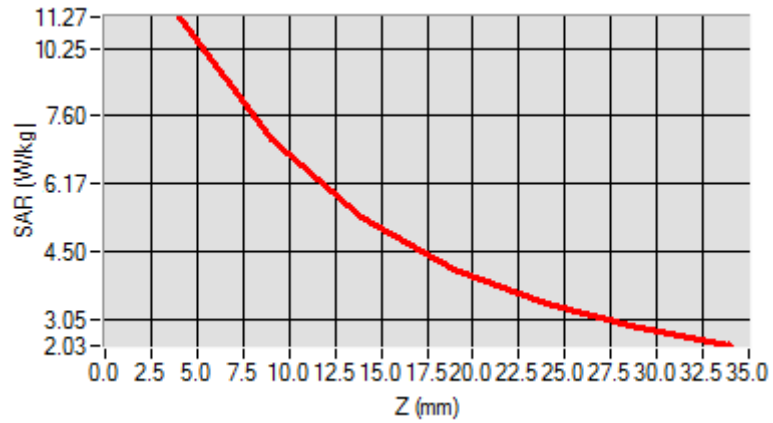

3D screen shot

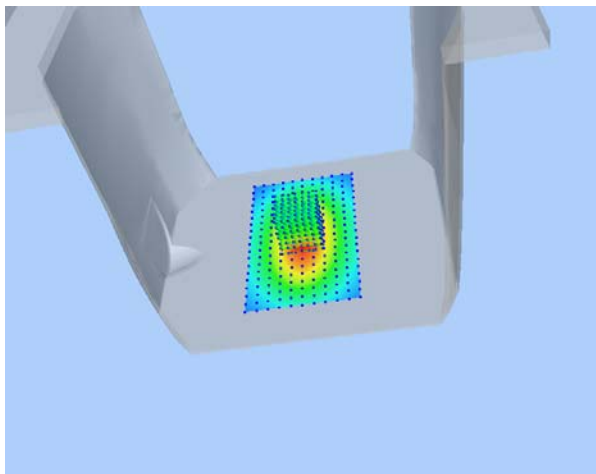

Hot spot position

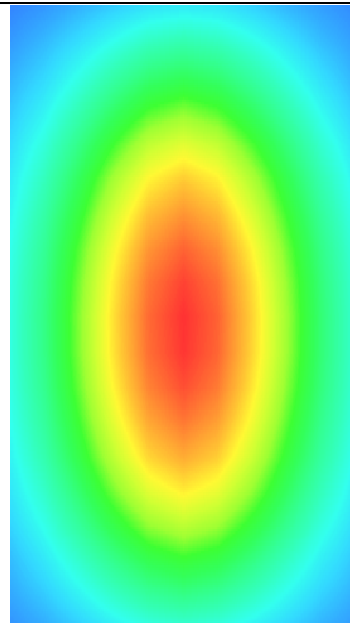

# MEASUREMENT 8

## For Body Liquid

Type: Validation measurement (Fast, 75.00 %)

Date of measurement: 08/20/2017

Measurement duration: 12 minutes 21 seconds

E-field Probe: SSE5 - SN 09/13 EP168; ConvF: 6.55; Calibrated: 06/01/2017

### A. Experimental conditions

<b>Area Scan</b>	dx=8mm dy=8mm
<b>Phantom</b>	Validation plane
<b>Device Position</b>	Dipole
<b>Band</b>	CW1900
<b>Signal</b>	Duty Cycle 1:1

### B. SAR Measurement Results

<b>Frequency (MHz)</b>	1900.000000
<b>Relative Permittivity (real part)</b>	52.420415
<b>Conductivity (S/m)</b>	1.501966
<b>Power Variation (%)</b>	0.541872
<b>Ambient Temperature</b>	21.1
<b>Liquid Temperature</b>	21.3

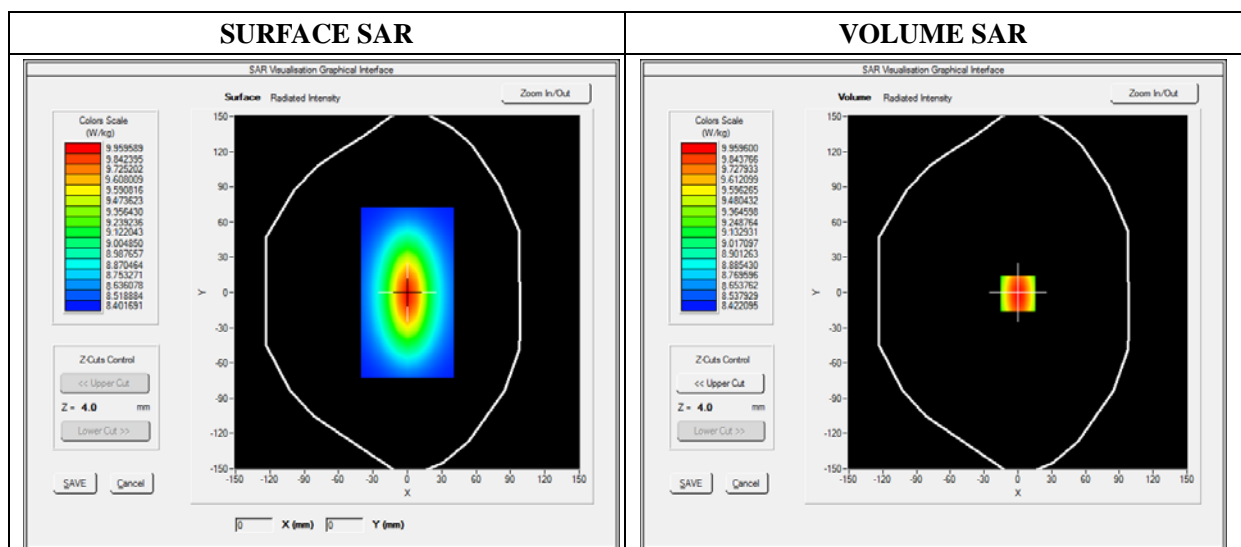

Maximum location: X=0.00, Y=0.00

SAR 10g (W/Kg)	5.134651
SAR 1g (W/Kg)	9.781550

Z Axis Scan

Z (mm)	0.00	4.00	9.00	14.00	19.00	24.00	29.00
SAR (W/Kg)	0.0000	10.2031	6.43001	4.9011	4.5325	3.1201	2.5024

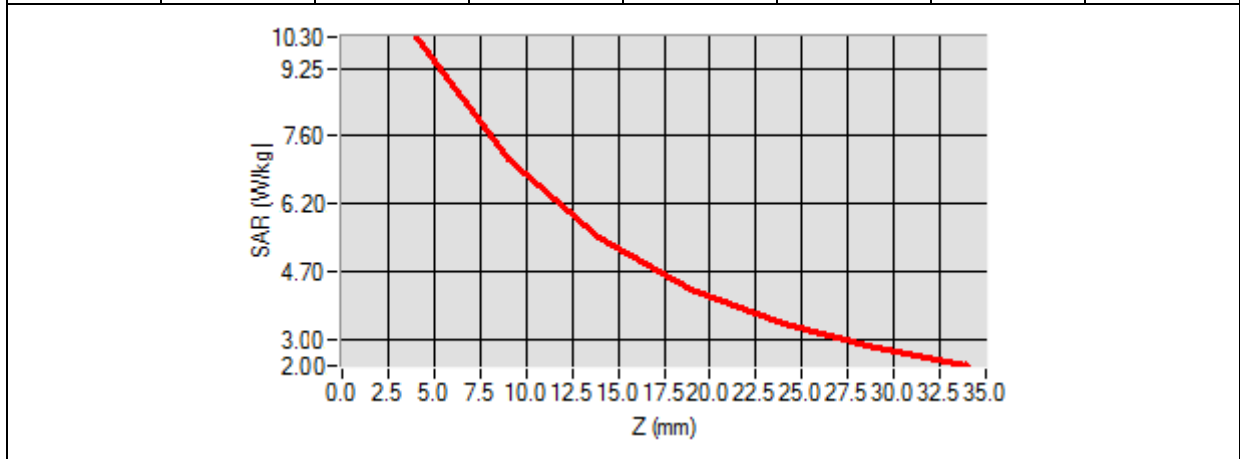

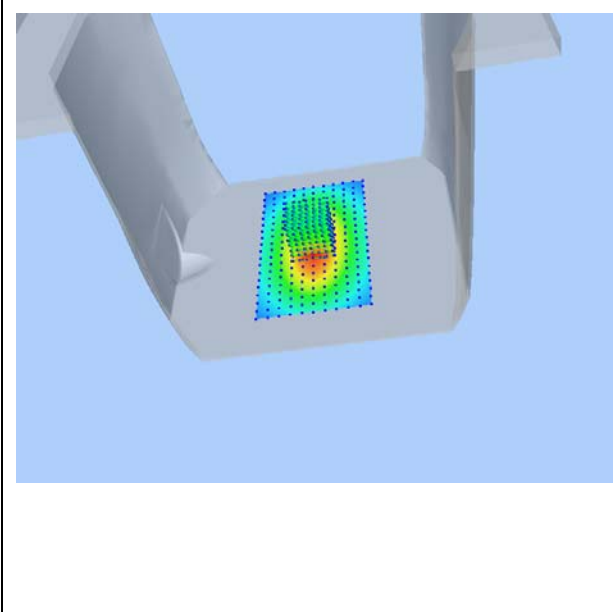
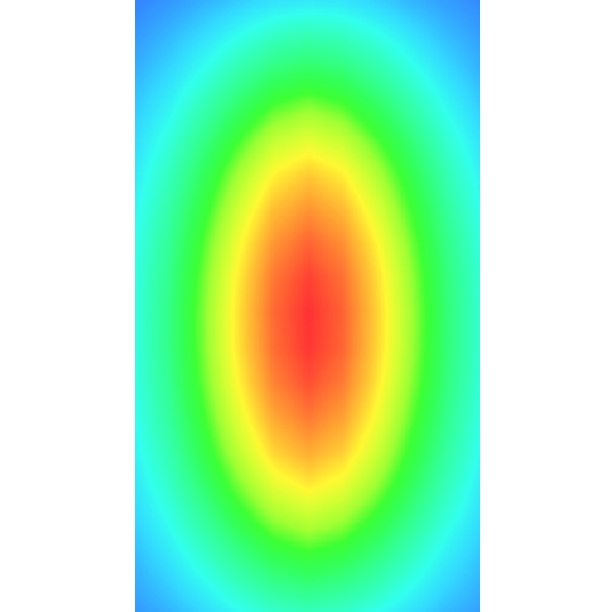
3D screen shot	Hot spot position
	

# MEASUREMENT 9

## For Body Liquid

Type: Validation measurement (Fast, 75.00 %)

Date of measurement: 08/20/2017

Measurement duration: 12 minutes 21 seconds

E-field Probe: SSE5 - SN 09/13 EP168; ConvF: 5.80; Calibrated: 06/01/2017

## A. Experimental conditions

<b>Area Scan</b>	dx=8mm dy=8mm
<b>Phantom</b>	Validation plane
<b>Device Position</b>	Dipole
<b>Band</b>	CW2450
<b>Signal</b>	Duty Cycle 1:1

## B. SAR Measurement Results

<b>Frequency (MHz)</b>	2450.000000
<b>Relative Permittivity (real part)</b>	52.010212
<b>Conductivity (S/m)</b>	1.910255
<b>Power Variation (%)</b>	1.369745
<b>Ambient Temperature</b>	21.1
<b>Liquid Temperature</b>	21.2

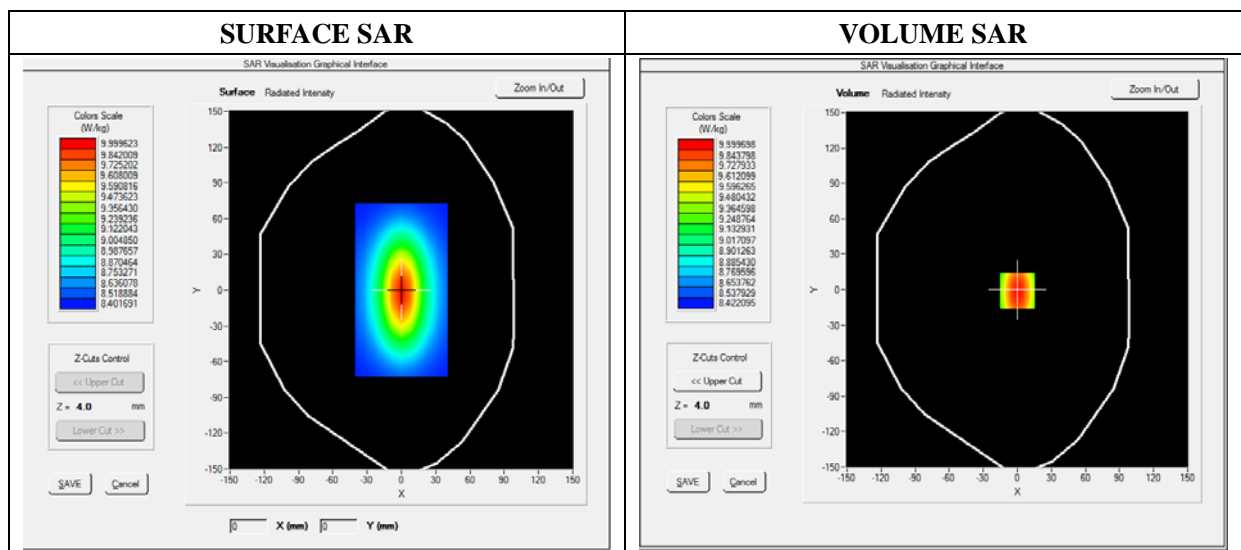

Maximum location: X=0.00, Y=0.00

SAR 10g (W/Kg)	7.119522
SAR 1g (W/Kg)	12.592360

Z Axis Scan

Z (mm)	0.00	4.00	9.00	14.00	19.00	24.00	29.00
SAR (W/Kg)	0.0000	13.3911	11.7951	9.2945	8.5400	6.3712	4.6225

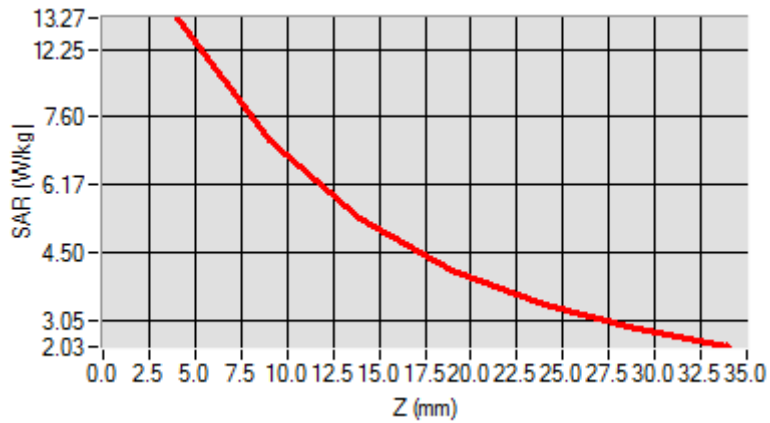

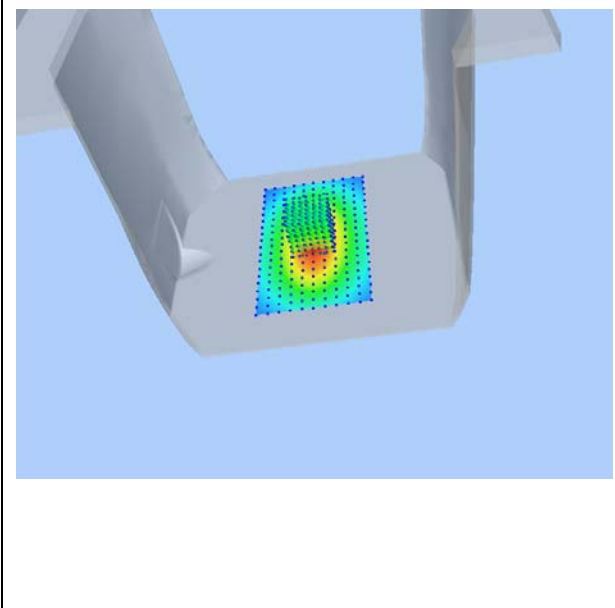
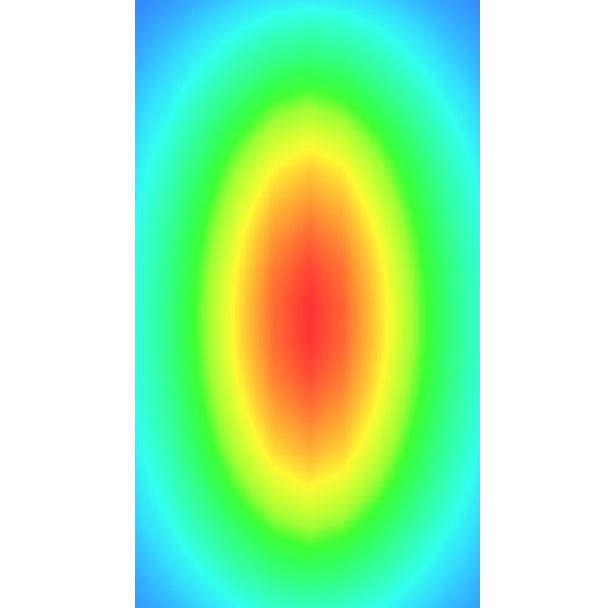
3D screen shot	Hot spot position
	



# MEASUREMENT 10

## For Body Liquid

Type: Validation measurement (Fast, 75.00 %)

Date of measurement: 08/20/2017

Measurement duration: 12 minutes 21 seconds

E-field Probe: SSE5 - SN 09/13 EP168; ConvF: 5.58; Calibrated: 06/01/2017

## A. Experimental conditions

<b>Area Scan</b>	dx=8mm dy=8mm
<b>Phantom</b>	Validation plane
<b>Device Position</b>	Dipole
<b>Band</b>	CW2600
<b>Signal</b>	Duty Cycle 1:1

## B. SAR Measurement Results

<b>Frequency (MHz)</b>	2600.000000
<b>Relative Permittivity (real part)</b>	52.241202
<b>Conductivity (S/m)</b>	2.120943
<b>Power Variation (%)</b>	1.038832
<b>Ambient Temperature</b>	21.1
<b>Liquid Temperature</b>	21.2

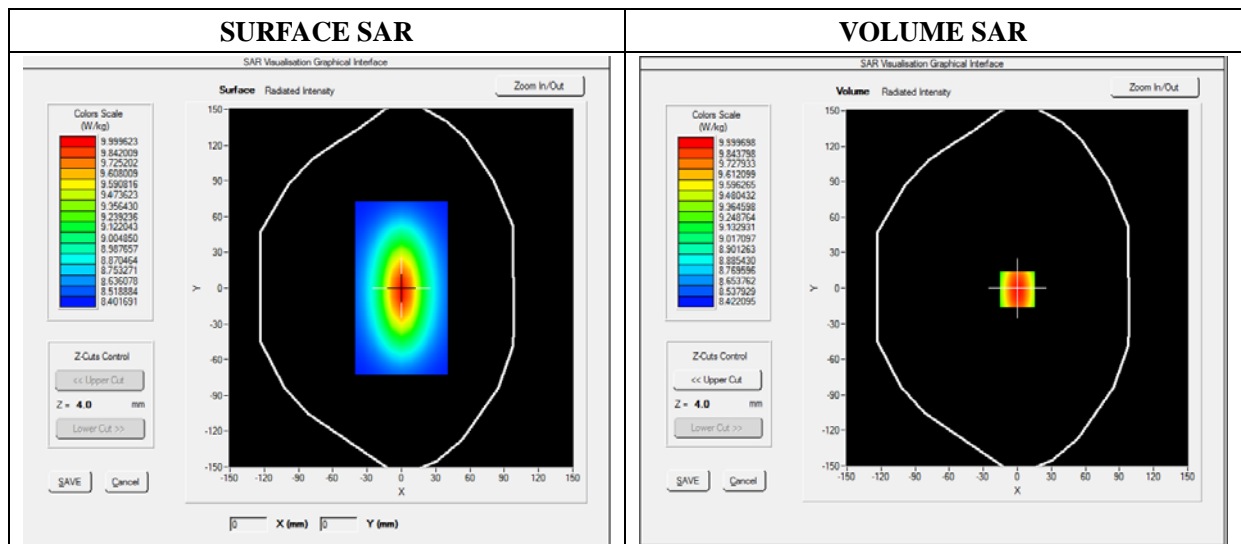

Maximum location: X=0.00, Y=0.00

SAR 10g (W/Kg)	6.083781
SAR 1g (W/Kg)	13.430481

Z Axis Scan

Z (mm)	0.00	4.00	9.00	14.00	19.00	24.00	29.00
SAR (W/Kg)	0.0000	13.6473	11.8441	9.3627	8.5782	6.4357	4.6342

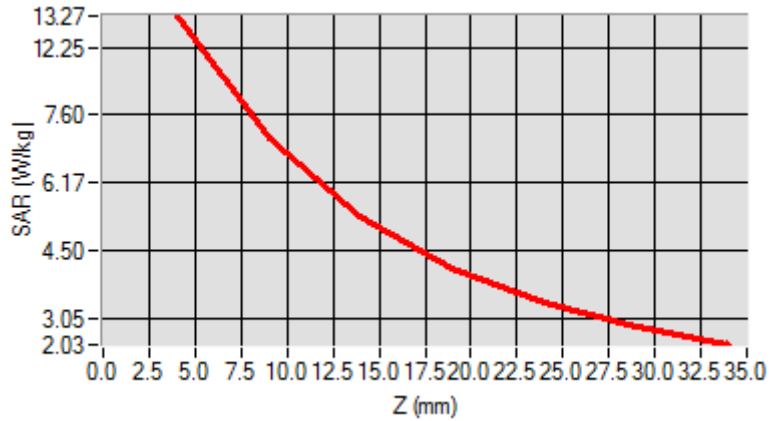

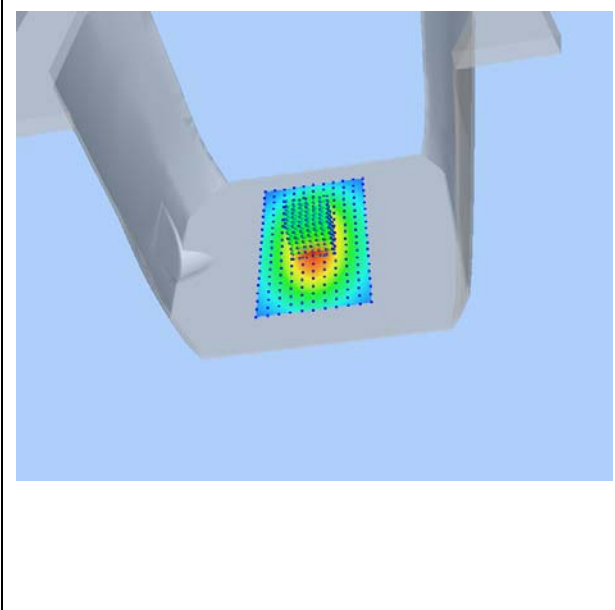
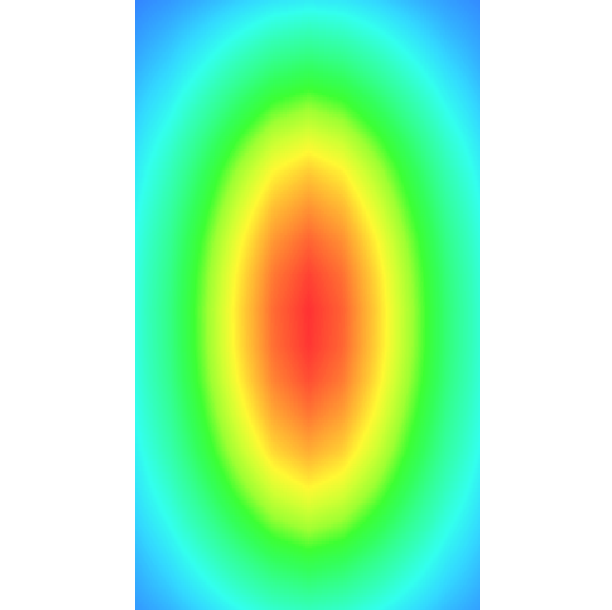
3D screen shot	Hot spot position
	

## Annex B. Plots of SAR Measurement

<b><u>TYPE</u></b>	<b><u>BAND</u></b>	<b><u>PARAMETERS</u></b>
Phone	GSM850	<u>Measurement 1:</u> Right Head with Cheek device position on Middle Channel in GSM mode
Phone	GSM1900	<u>Measurement 5:</u> Right Head with Cheek device position on Middle Channel in GSM mode
Phone	GPRS850_4TX	<u>Measurement 9:</u> Right Head with Cheek device position on High Channel in GPRS mode
Phone	GPRS1900_4TX	<u>Measurement 15:</u> Left Head with Cheek device position on Middle Channel in GPRS mode
Phone	WCDMA1900_RMC	<u>Measurement 17:</u> Right Head with Cheek device position on Middle Channel in WCDMA mode
Phone	WCDMA850_RMC	<u>Measurement 21:</u> Right Head with Cheek device position on Middle Channel in WCDMA mode
Phone	LTE Band 2_RMC	<u>Measurement 25:</u> Right Head with Cheek device position on Low Channel in LTE mode
Phone	LTE Band 4_RMC	<u>Measurement 33:</u> Right Head with Cheek device position on Low Channel in LTE mode
Phone	LTE Band 5_RMC	<u>Measurement 41:</u> Right Head with Cheek device position on Low Channel in LTE mode
Phone	LTE Band 7_RMC	<u>Measurement 49:</u> Right Head with Cheek device position on High Channel in LTE mode
Phone	WiFi_802.11b	<u>Measurement 57:</u> Right Head with Cheek device position on Low Channel in 802.11b mode
Phone	GSM850	<u>Measurement 61:</u> Flat Plane with Back(Body-worn) device position on Middle Channel in GSM mode
Phone	GSM1900	<u>Measurement 63:</u> Flat Plane with Back (Body-worn) device position on Middle Channel in GSM mode
Phone	GPRS850_4TX	<u>Measurement 65:</u> Flat Plane with Back device position on High Channel in GPRS mode
Phone	GPRS1900_4TX	<u>Measurement 71:</u> Flat Plane with Front device position on Middle Channel in GPRS mode
Phone	WCDMA1900_RMC	<u>Measurement 75:</u> Flat Plane with Back side device position on Middle Channel in WCDMA mode
Phone	WCDMA850_RMC	<u>Measurement 81:</u> Flat Plane with Front device position on Middle Channel in WCDMA mode
Phone	LTE Band 2_RMC	<u>Measurement 85:</u> Flat Plane with Back device position on Low Channel in LTE mode
Phone	LTE Band 4_RMC	<u>Measurement 95:</u> Flat Plane with Back device position on Low Channel in LTE mode

<b>Phone</b>	<b>LTE Band 5_RMC</b>	<u>Measurement 105</u> : Flat Plane with Back device position on Low Channel in LTE mode
<b>Phone</b>	<b>LTE Band 7_RMC</b>	<u>Measurement 115</u> : Flat Plane with Back device position on High Channel in LTE mode
<b>Phone</b>	<b>WiFi_802.11b</b>	<u>Measurement 125</u> : Flat Plane with Back side device position on Low Channel in 802.11b mode
<i>Remark: SAR plot is showed the highest measured SAR in each exposure configuration, wireless mode and frequency band combination.</i>		

# MEASUREMENT 1

Type: Phone measurement (Complete)

Date of measurement: 08/20/2017

Measurement duration: 11 minutes 48 seconds

E-field Probe: SSE5 - SN 09/13 EP168; ConvF: 6.93; Calibrated: 06/01/2017

## A. Experimental conditions

<b>Area Scan</b>	sam_direct_droit2_surf8mm.txt
<b>Phantom</b>	Right head
<b>Device Position</b>	Cheek
<b>Band</b>	GSM850
<b>Channels</b>	Middle
<b>Signal</b>	TDMA (Crest factor: 8.0)

## B. SAR Measurement Results

<b>Frequency (MHz)</b>	836.600000
<b>Relative Permittivity (real part)</b>	41.110245
<b>Conductivity (S/m)</b>	0.871245
<b>Power Variation (%)</b>	1.144536
<b>Ambient Temperature</b>	21.1
<b>Liquid Temperature</b>	21.3

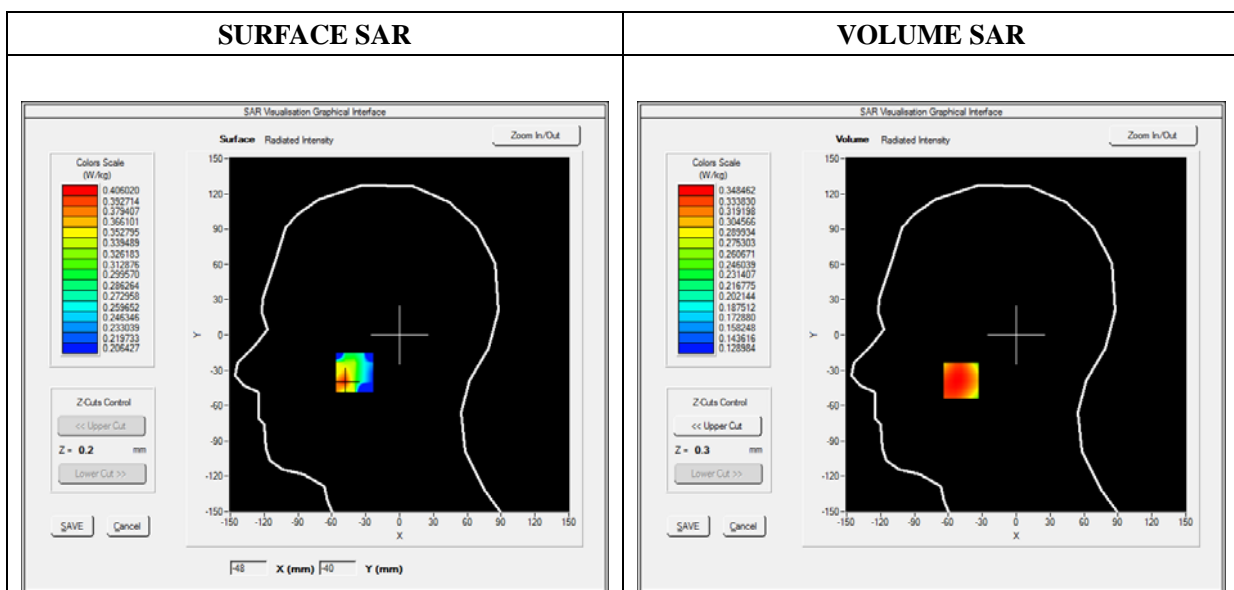



**Maximum location: X=-49.00, Y=-39.00**

**SAR Peak: 0.42 W/kg**

<b>SAR 10g (W/Kg)</b>	<b>0.283730</b>
<b>SAR 1g (W/Kg)</b>	<b>0.342508</b>

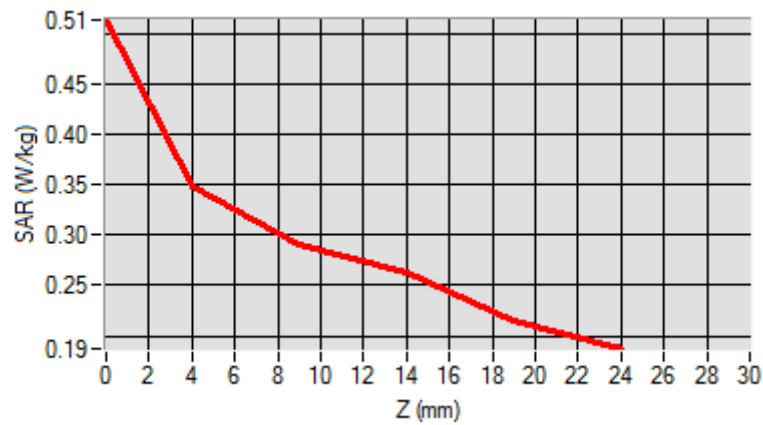
<b>Z (mm)</b>	<b>0.00</b>	<b>4.00</b>	<b>9.00</b>	<b>14.00</b>	<b>19.00</b>
<b>SAR (W/Kg)</b>	<b>0.5132</b>	<b>0.3485</b>	<b>0.2898</b>	<b>0.2630</b>	<b>0.2154</b>

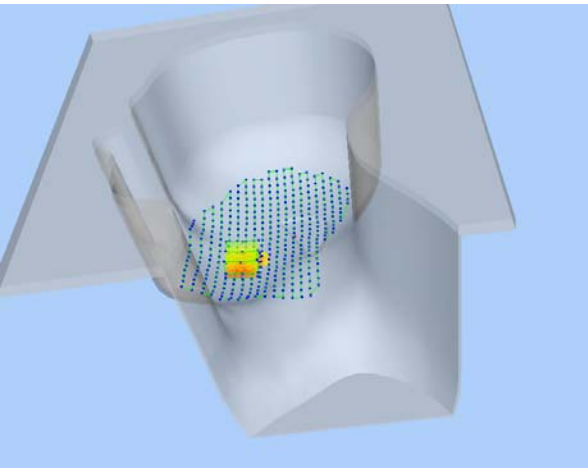

3D screen shot	Hot spot position
 <p>A 3D perspective view of a grey, bowl-shaped device. A grid of small blue dots is overlaid on the inner surface. A small, bright yellow and red area, representing the hot spot, is visible on the grid.</p>	 <p>A 3D visualization of the hot spot, shown as a small, irregular, multi-faceted object with a color gradient from red to yellow.</p>

## MEASUREMENT 5

Type: Phone measurement (Complete)

Date of measurement: 08/20/2017

Measurement duration: 11 minutes 48 seconds

E-field Probe: SSE5 - SN 09/13 EP168; ConvF: 6.35; Calibrated: 06/01/2017

### A. Experimental conditions

<b>Area Scan</b>	sam_direct_droit2_surf8mm.txt
<b>Phantom</b>	Right head
<b>Device Position</b>	Cheek
<b>Band</b>	GSM1900
<b>Channels</b>	Middle
<b>Signal</b>	TDMA (Crest factor: 8.0)

### B. SAR Measurement Results

<b>Frequency (MHz)</b>	1880.000000
<b>Relative Permittivity (real part)</b>	38.560124
<b>Conductivity (S/m)</b>	1.380369
<b>Power Variation (%)</b>	1.442440
<b>Ambient Temperature</b>	21.1
<b>Liquid Temperature</b>	21.3

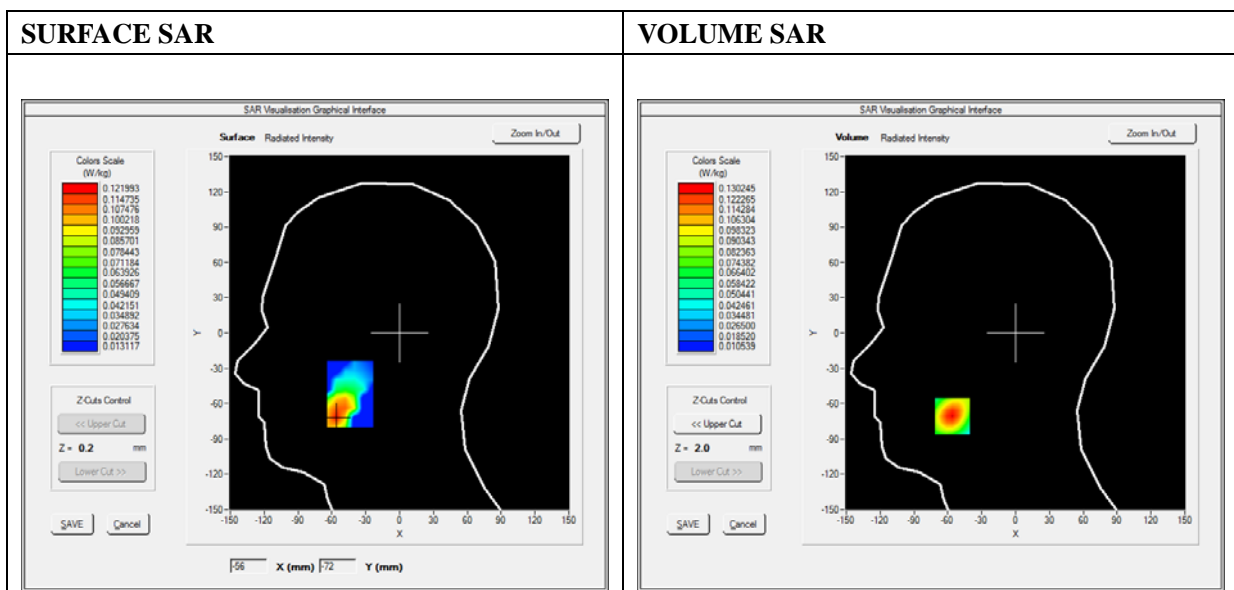

**Maximum location: X=-56.00, Y=-71.00**

**SAR Peak: 0.20 W/kg**

<b>SAR 10g (W/Kg)</b>	0.071028
<b>SAR 1g (W/Kg)</b>	0.121097

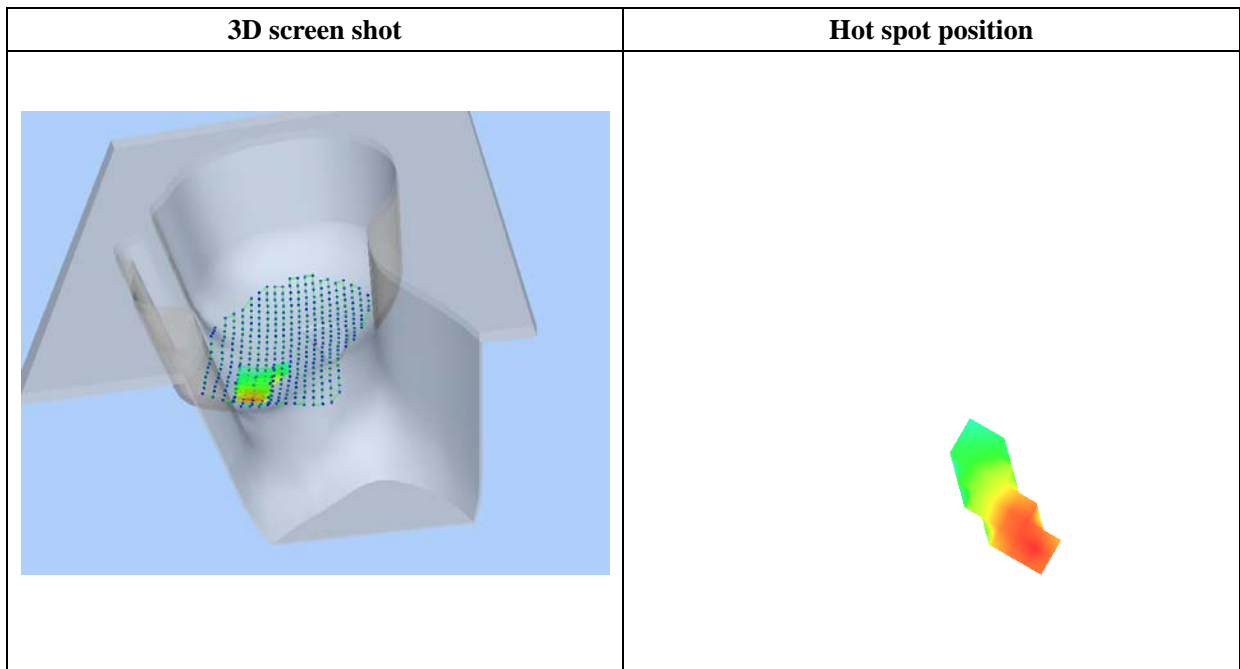
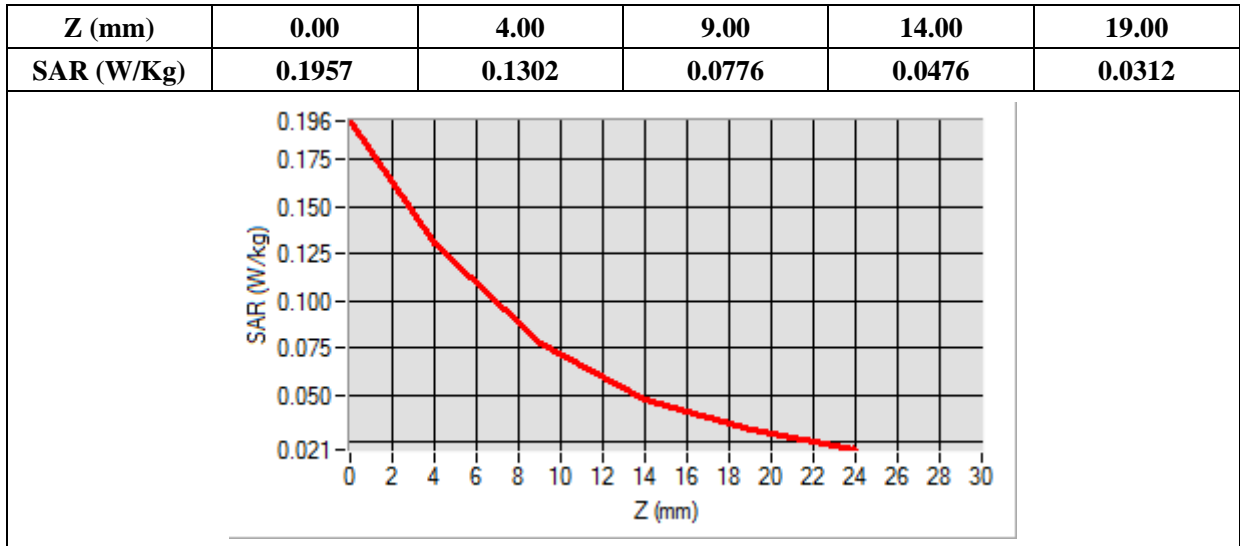



# MEASUREMENT 9

Type: Phone measurement (Complete)

Date of measurement: 08/20/2017

Measurement duration: 11 minutes 48 seconds

E-field Probe: SSE5 - SN 09/13 EP168; ConvF: 6.93; Calibrated: 06/01/2017

## A. Experimental conditions

<b>Area Scan</b>	sam_direct_droit2_surf8mm.txt
<b>Phantom</b>	Right head
<b>Device Position</b>	Cheek
<b>Band</b>	GPRS850_4TX
<b>Channels</b>	High
<b>Signal</b>	Duty Cycle: 1:2

## B. SAR Measurement Results

<b>Frequency (MHz)</b>	848.800000
<b>Relative Permittivity (real part)</b>	41.110245
<b>Conductivity (S/m)</b>	0.871245
<b>Power Variation (%)</b>	1.144536
<b>Ambient Temperature</b>	21.1
<b>Liquid Temperature</b>	21.3

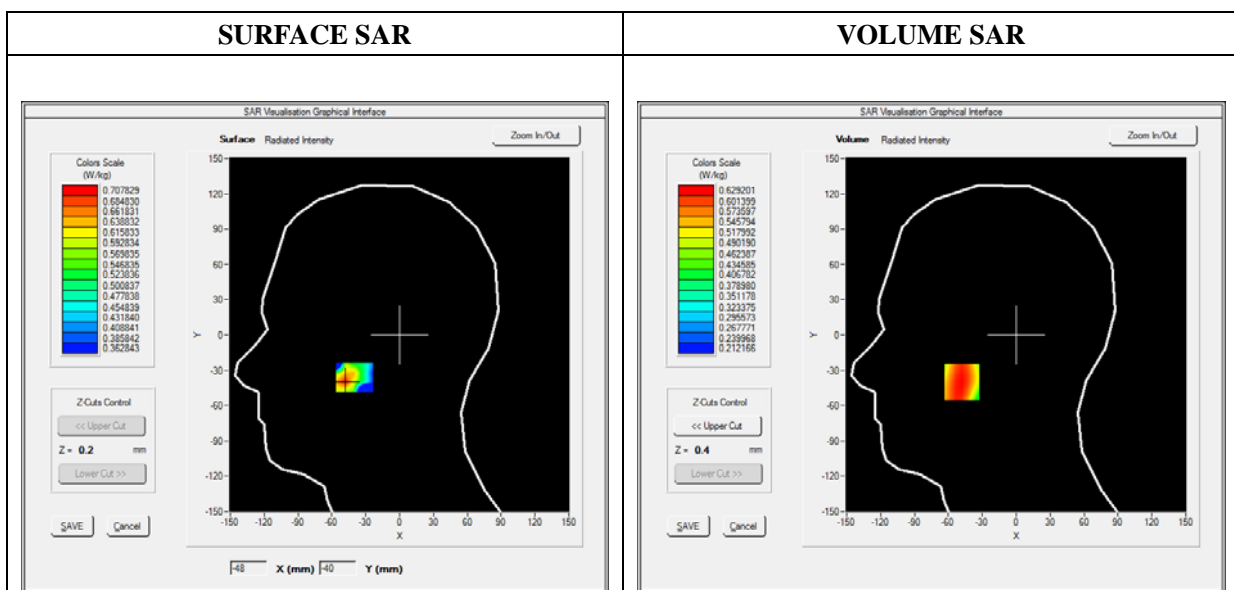



**Maximum location: X=-48.00, Y=-40.00**

**SAR Peak: 0.78 W/kg**

<b>SAR 10g (W/Kg)</b>	<b>0.486676</b>
<b>SAR 1g (W/Kg)</b>	<b>0.612768</b>

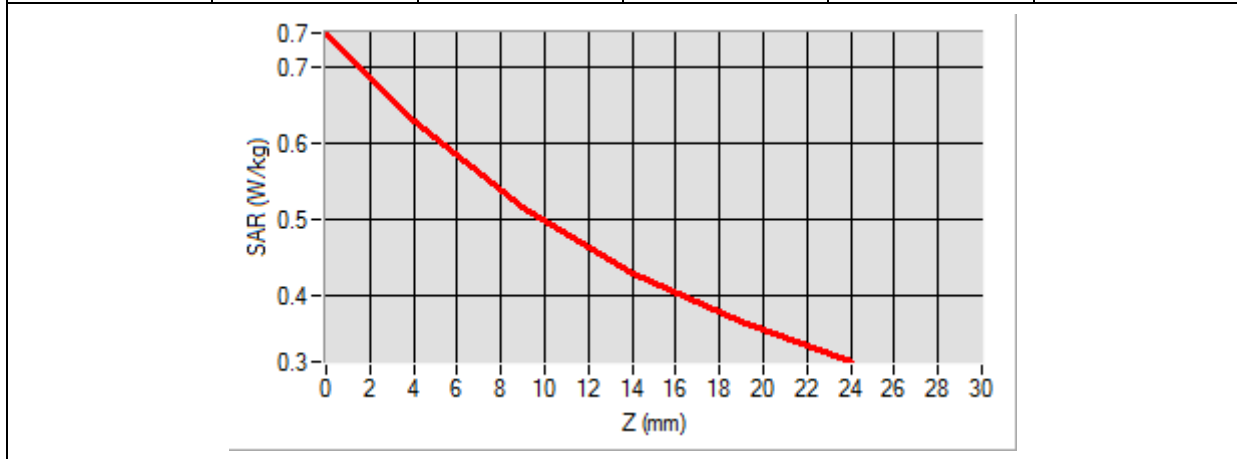
<b>Z (mm)</b>	<b>0.00</b>	<b>4.00</b>	<b>9.00</b>	<b>14.00</b>	<b>19.00</b>
<b>SAR (W/Kg)</b>	<b>0.7444</b>	<b>0.6292</b>	<b>0.5152</b>	<b>0.4301</b>	<b>0.3665</b>

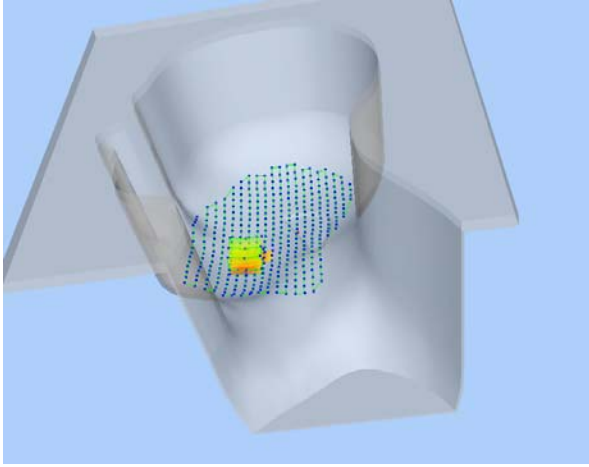

3D screen shot	Hot spot position
	

## MEASUREMENT 15

Type: Phone measurement (Complete)

Date of measurement: 08/20/2017

Measurement duration: 11 minutes 48 seconds

E-field Probe: SSE5 - SN 09/13 EP168; ConvF: 6.35; Calibrated: 06/01/2017

### A. Experimental conditions

<b>Area Scan</b>	sam_direct_droit2_surf8mm.txt
<b>Phantom</b>	Left head
<b>Device Position</b>	Cheek
<b>Band</b>	GPRS1900_4TX
<b>Channels</b>	Middle
<b>Signal</b>	Duty Cycle: 1:2

### B. SAR Measurement Results

<b>Frequency (MHz)</b>	1880.000000
<b>Relative Permittivity (real part)</b>	38.560124
<b>Conductivity (S/m)</b>	1.380369
<b>Power Variation (%)</b>	1.442440
<b>Ambient Temperature</b>	21.1
<b>Liquid Temperature</b>	21.3

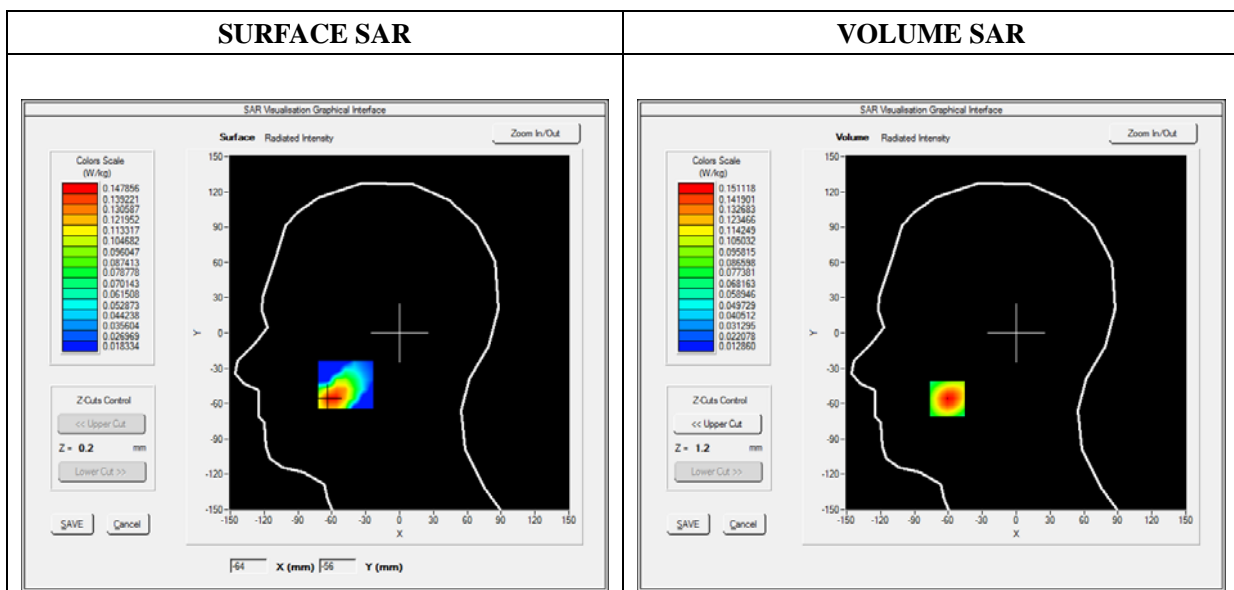

Maximum location: X=-61.00, Y=-56.00

SAR Peak: 0.21 W/kg

SAR 10g (W/Kg)	0.085553
SAR 1g (W/Kg)	0.140932

Z (mm)	0.00	4.00	9.00	14.00	19.00
SAR (W/Kg)	0.2129	0.1511	0.0976	0.0637	0.0425

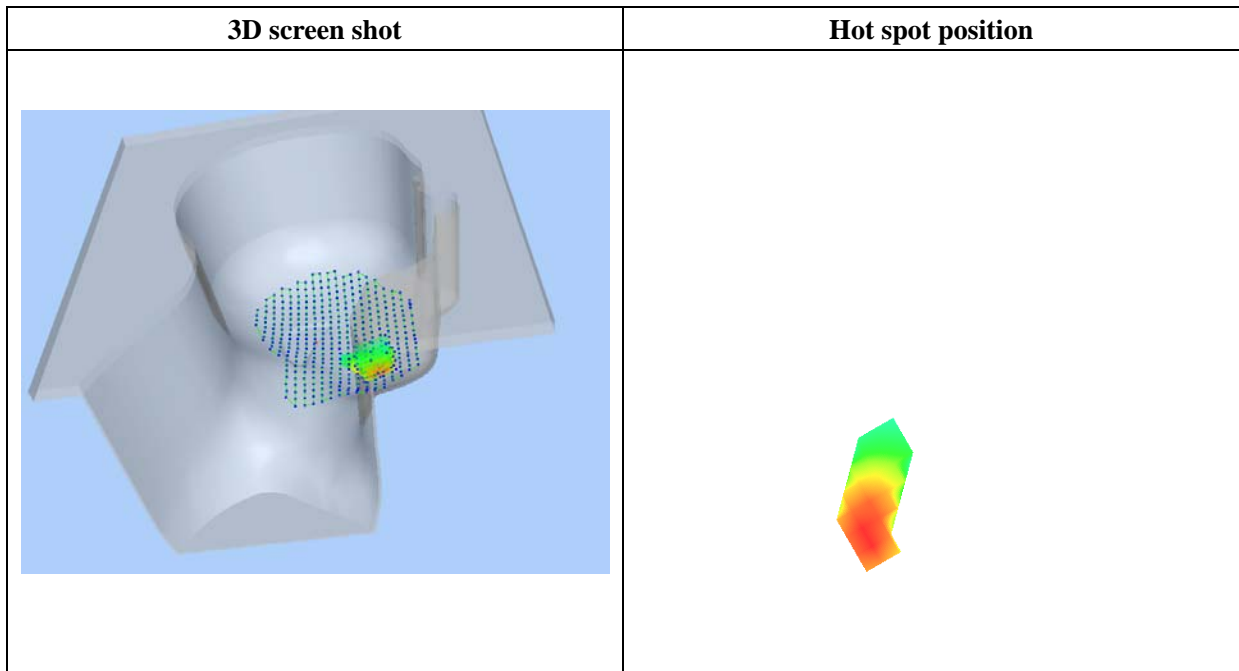
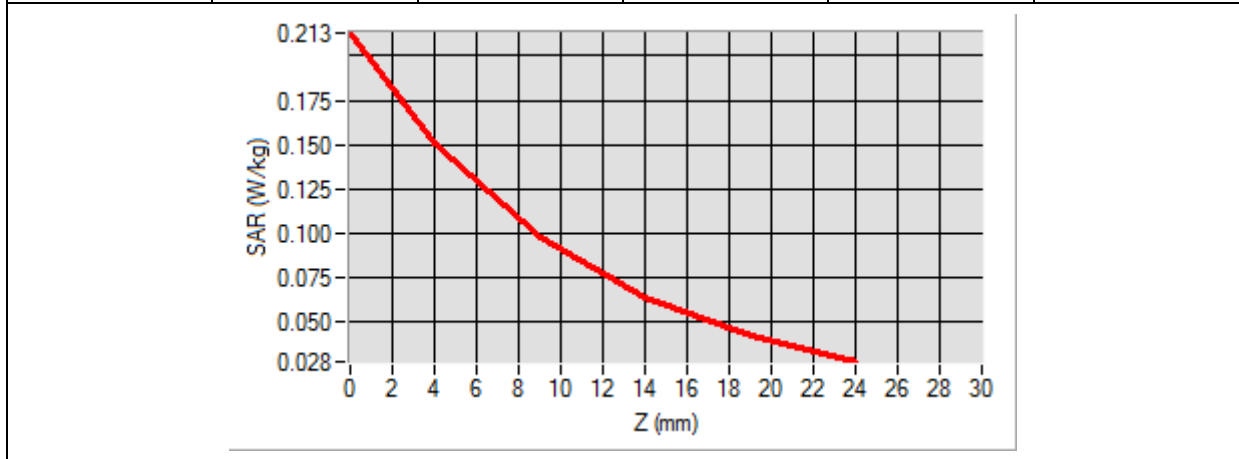

# MEASUREMENT 17

Type: Phone measurement (Complete)

Date of measurement: 08/20/2017

Measurement duration: 12 minutes 3 seconds

E-field Probe: SSE5 - SN 09/13 EP168; ConvF: 6.35; Calibrated: 06/01/2017

## A. Experimental conditions

<b>Area Scan</b>	sam_direct_droit2_surf8mm.txt
<b>Phantom</b>	Right head
<b>Device Position</b>	Cheek
<b>Band</b>	WCDMA1900_RMC
<b>Channels</b>	Middle
<b>Signal</b>	Duty Cycle 1:1

## B. SAR Measurement Results

<b>Frequency (MHz)</b>	1880.000000
<b>Relative Permittivity (real part)</b>	38.560124
<b>Conductivity (S/m)</b>	1.380369
<b>Power Variation (%)</b>	1.524540
<b>Ambient Temperature</b>	21.1
<b>Liquid Temperature</b>	21.3

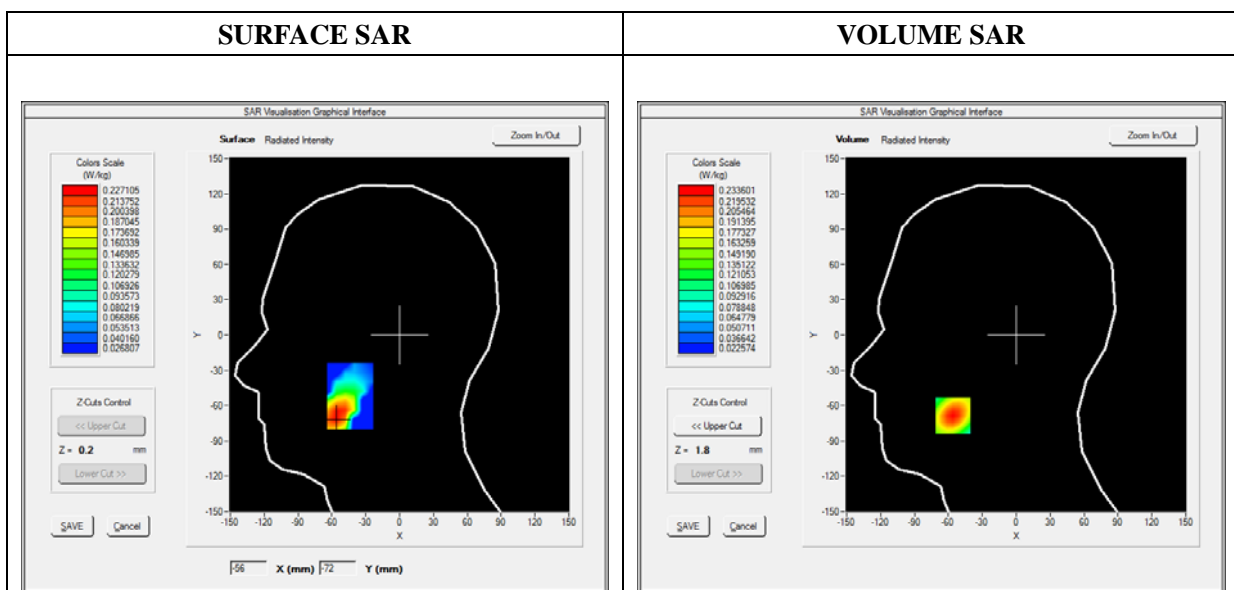

Maximum location: X=-56.00, Y=-69.00

SAR Peak: 0.34 W/kg

SAR 10g (W/Kg)	0.131437
SAR 1g (W/Kg)	0.217868

Z (mm)	0.00	4.00	9.00	14.00	19.00
SAR (W/Kg)	0.3361	0.2336	0.1469	0.0935	0.0613

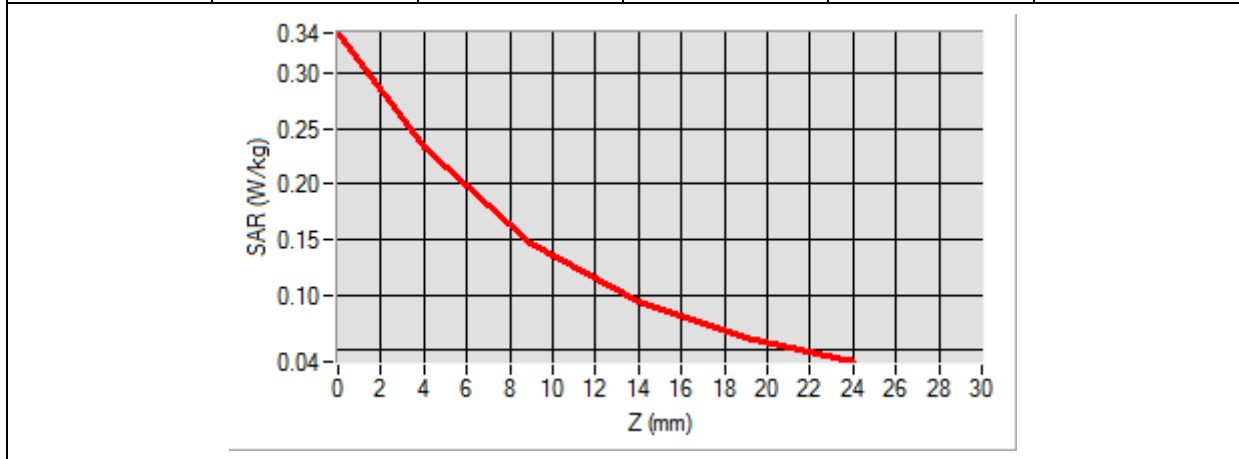

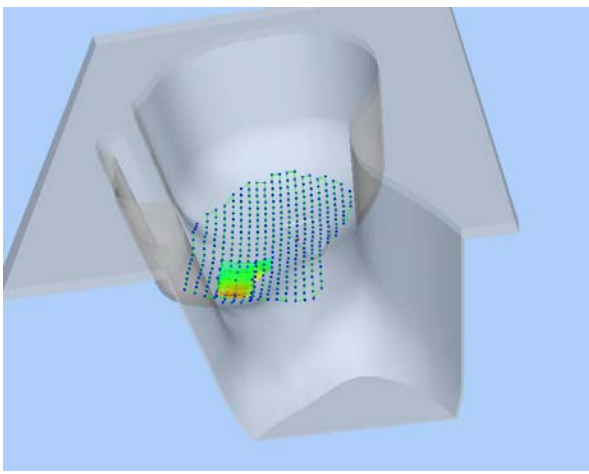
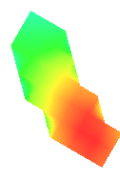
3D screen shot	Hot spot position
	

## MEASUREMENT 21

Type: Phone measurement (Complete)

Date of measurement: 08/20/2017

Measurement duration: 12 minutes 3 seconds

E-field Probe: SSE5 - SN 09/13 EP168; ConvF: 6.93; Calibrated: 06/01/2017

### A. Experimental conditions

<b>Area Scan</b>	sam_direct_droit2_surf8mm.txt
<b>Phantom</b>	Right head
<b>Device Position</b>	Cheek
<b>Band</b>	WCDMA850_RMC
<b>Channels</b>	Middle
<b>Signal</b>	Duty Cycle 1:1

### B. SAR Measurement Results

<b>Frequency (MHz)</b>	836.600000
<b>Relative Permittivity (real part)</b>	41.110245
<b>Conductivity (S/m)</b>	0.871245
<b>Power Variation (%)</b>	1.342427
<b>Ambient Temperature</b>	21.1
<b>Liquid Temperature</b>	21.3

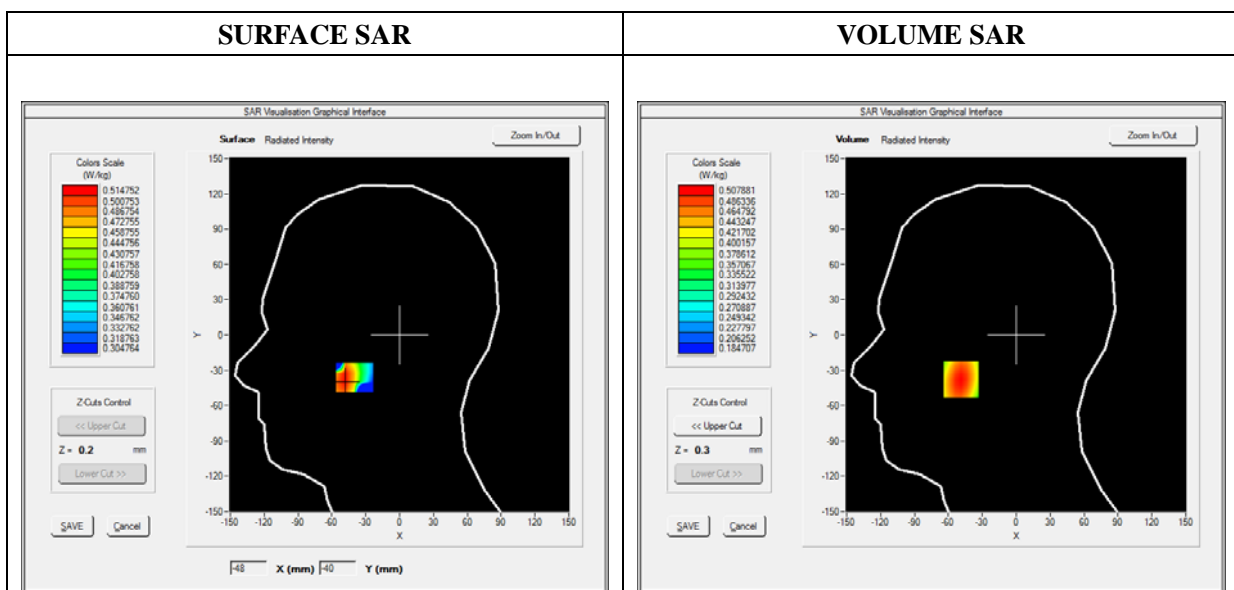

Maximum location: X=-49.00, Y=-38.00

SAR Peak: 0.57 W/kg

SAR 10g (W/Kg)	0.396882
SAR 1g (W/Kg)	0.490658

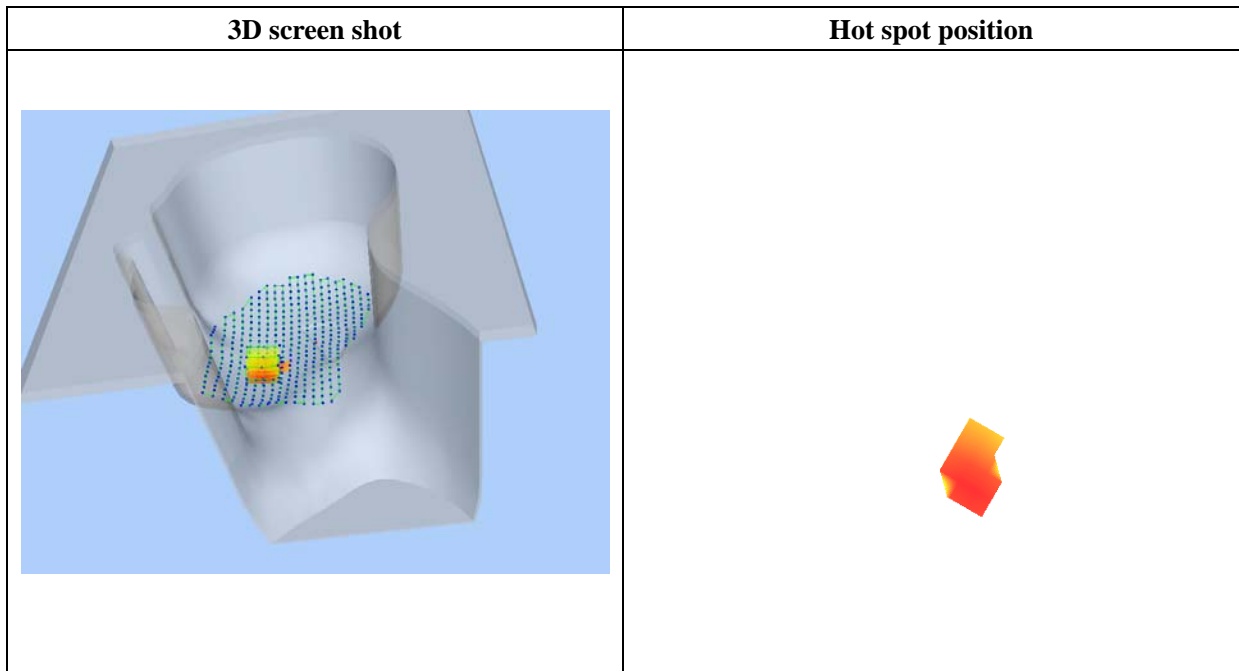
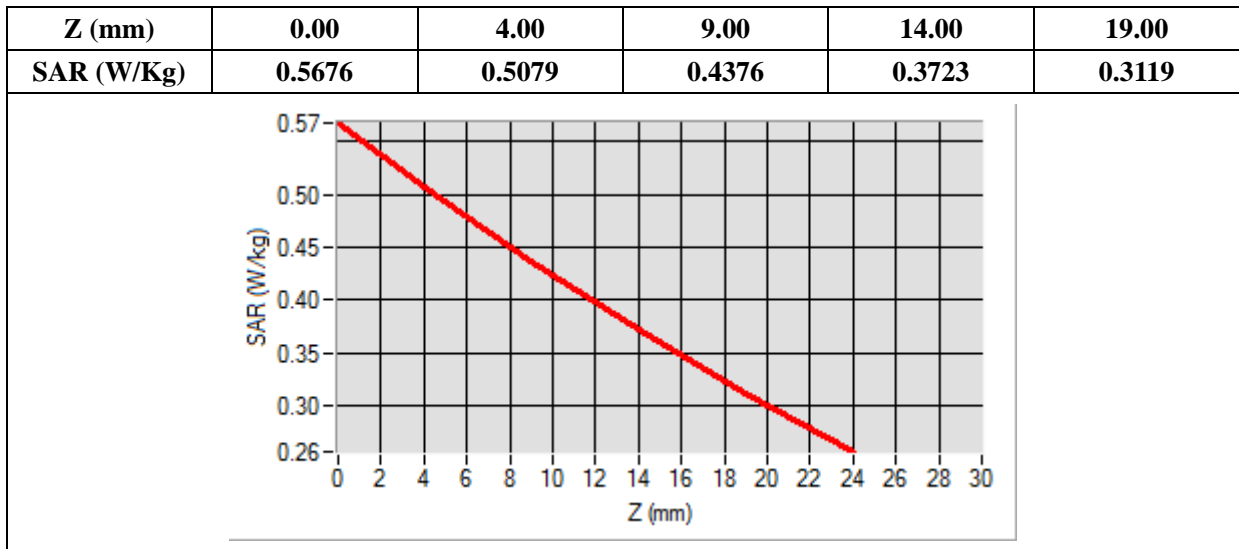



## MEASUREMENT 25

Type: Phone measurement (Complete)

Date of measurement: 08/20/2017

Measurement duration: 12 minutes 3 seconds

E-field Probe: SSE5 - SN 09/13 EP168; ConvF: 6.35; Calibrated: 06/01/2017

### A. Experimental conditions

<b>Area Scan</b>	sam_direct_droit2_surf8mm.txt
<b>Phantom</b>	Right head
<b>Device Position</b>	Cheek
<b>Band</b>	LTE Band 2_RMC
<b>Channels</b>	QPSK, 20MHz, 1RB, Low
<b>Signal</b>	Duty Cycle 1:1

### B. SAR Measurement Results

<b>Frequency (MHz)</b>	1860.000000
<b>Relative Permittivity (real part)</b>	38.560124
<b>Conductivity (S/m)</b>	1.380369
<b>Power Variation (%)</b>	1.743564
<b>Ambient Temperature</b>	21.1
<b>Liquid Temperature</b>	21.3

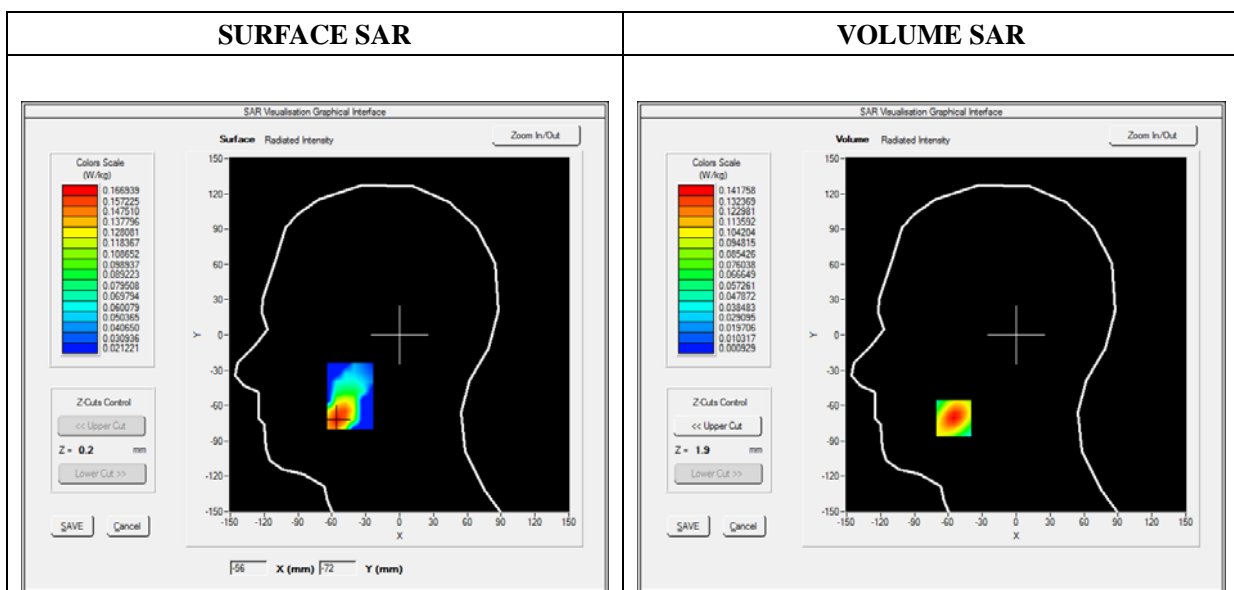



Maximum location: X=-55.00, Y=-71.00

SAR Peak: 0.21 W/kg

SAR 10g (W/Kg)	0.072527
SAR 1g (W/Kg)	0.131314

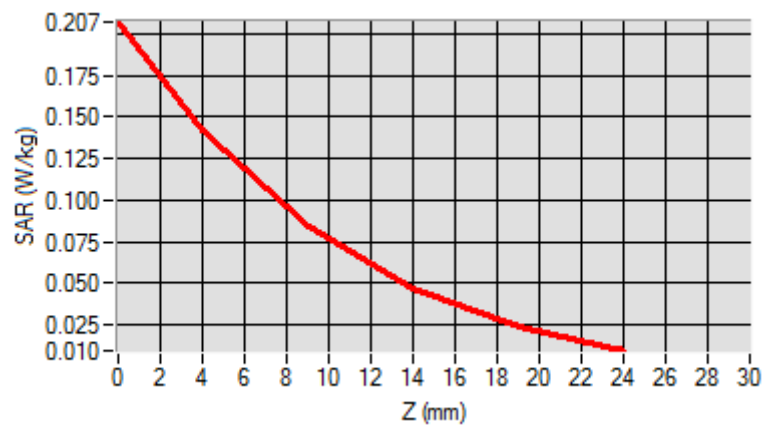
Z (mm)	0.00	4.00	9.00	14.00	19.00
SAR (W/Kg)	0.2073	0.1418	0.0842	0.0470	0.0238

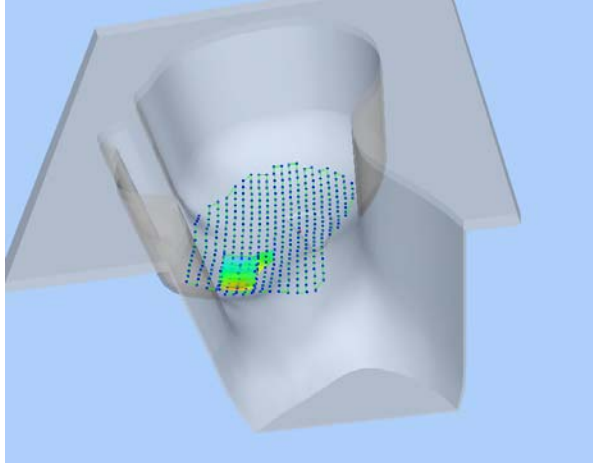

3D screen shot	Hot spot position
	

## MEASUREMENT 33

Type: Phone measurement (Complete)

Date of measurement: 08/20/2017

Measurement duration: 12 minutes 3 seconds

E-field Probe: SSE5 - SN 09/13 EP168; ConvF: 5.84; Calibrated: 06/01/2017

### A. Experimental conditions

<b>Area Scan</b>	sam_direct_droit2_surf8mm.txt
<b>Phantom</b>	Right head
<b>Device Position</b>	Cheek
<b>Band</b>	LTE Band 4_RMC
<b>Channels</b>	QPSK, 20MHz, 1RB, Low
<b>Signal</b>	Duty Cycle 1:1

### B. SAR Measurement Results

<b>Frequency (MHz)</b>	1720.000000
<b>Relative Permittivity (real part)</b>	39.024890
<b>Conductivity (S/m)</b>	1.371250
<b>Power Variation (%)</b>	1.374628
<b>Ambient Temperature</b>	21.1
<b>Liquid Temperature</b>	21.2

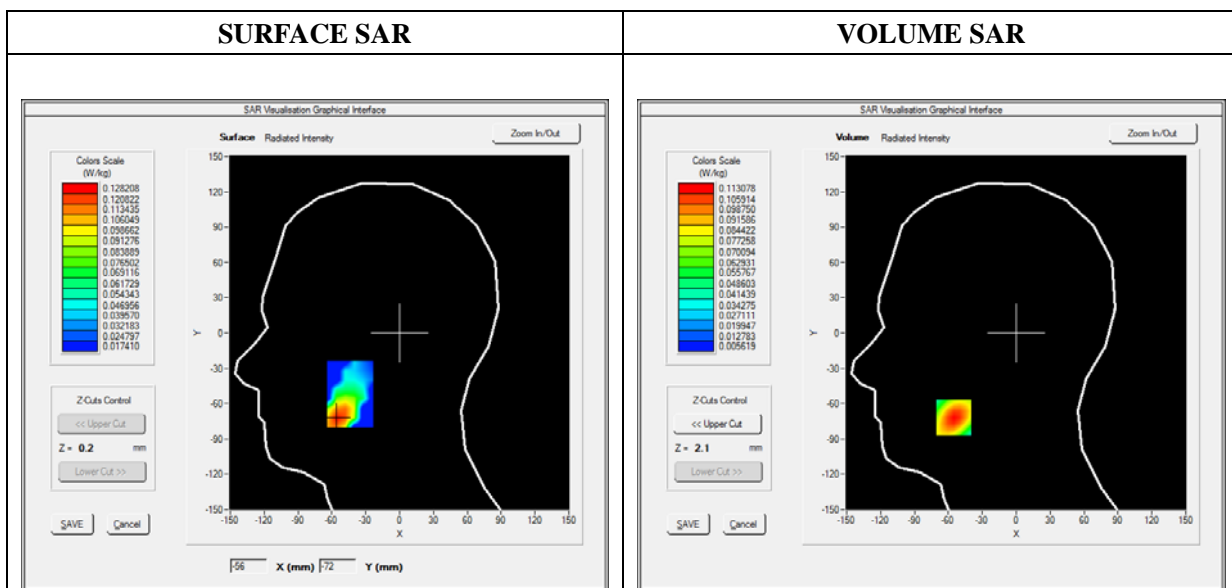

Maximum location: X=-55.00, Y=-72.00

SAR Peak: 0.16 W/kg

SAR 10g (W/Kg)	0.063155
SAR 1g (W/Kg)	0.105087

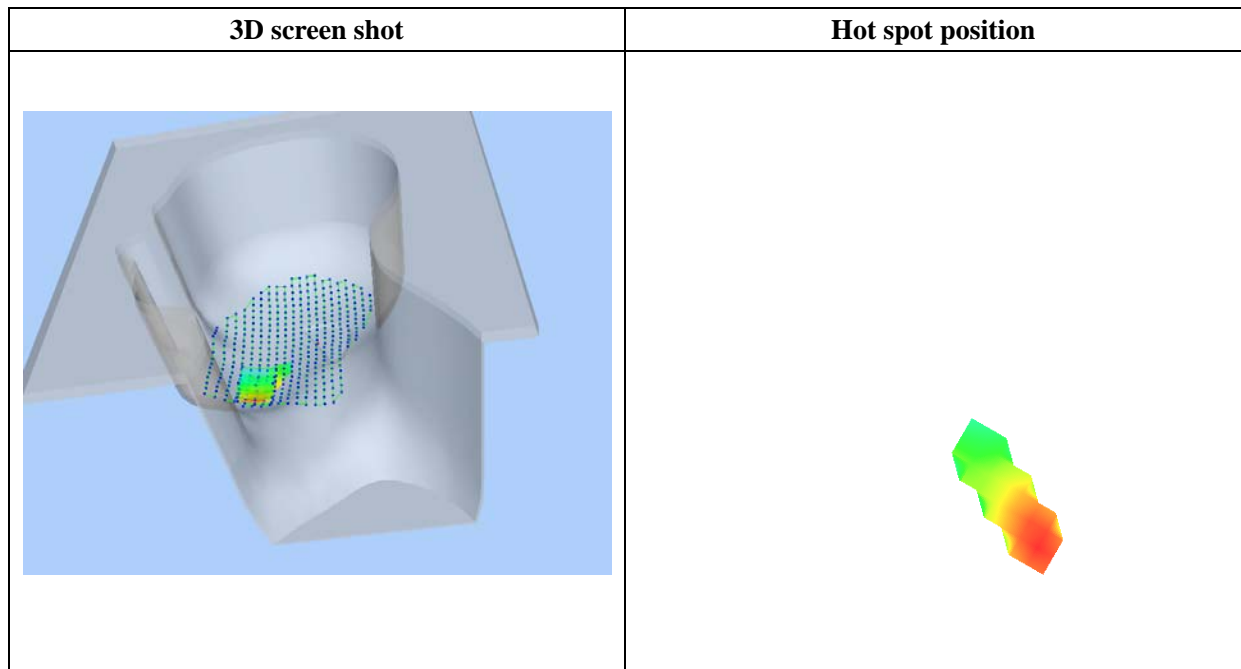
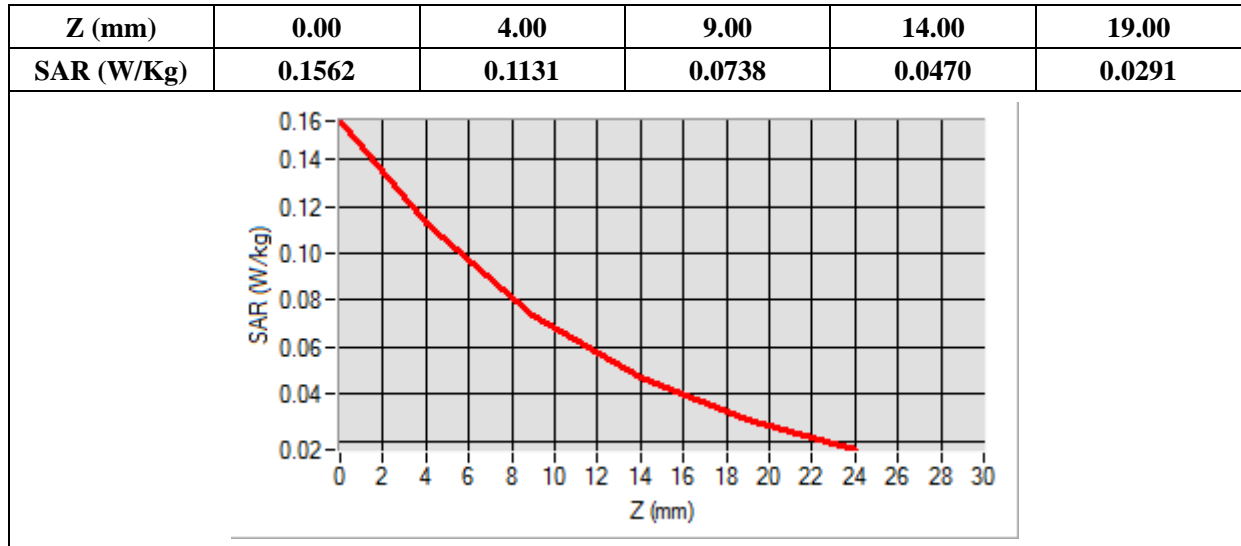

# MEASUREMENT 41

Type: Phone measurement (Complete)

Date of measurement: 08/20/2017

Measurement duration: 12 minutes 3 seconds

E-field Probe: SSE5 - SN 09/13 EP168; ConvF: 6.93; Calibrated: 06/01/2017

## A. Experimental conditions

<b>Area Scan</b>	sam_direct_droit2_surf8mm.txt
<b>Phantom</b>	Right head
<b>Device Position</b>	Cheek
<b>Band</b>	LTE Band 5_RMC
<b>Channels</b>	QPSK, 10MHz, 1RB, Low
<b>Signal</b>	Duty Cycle 1:1

## B. SAR Measurement Results

<b>Frequency (MHz)</b>	829.000000
<b>Relative Permittivity (real part)</b>	41.110245
<b>Conductivity (S/m)</b>	0.871245
<b>Power Variation (%)</b>	0.924535
<b>Ambient Temperature</b>	21.1
<b>Liquid Temperature</b>	21.2

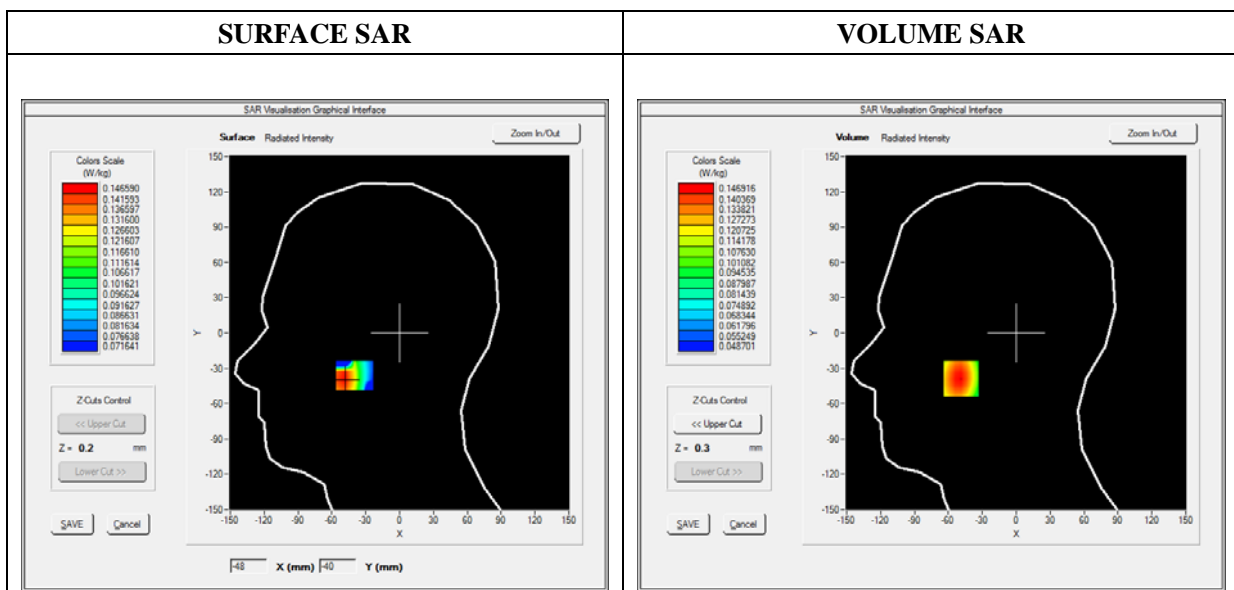



**Maximum location: X=-49.00, Y=-39.00**

**SAR Peak: 0.17 W/kg**

<b>SAR 10g (W/Kg)</b>	<b>0.111769</b>
<b>SAR 1g (W/Kg)</b>	<b>0.141739</b>

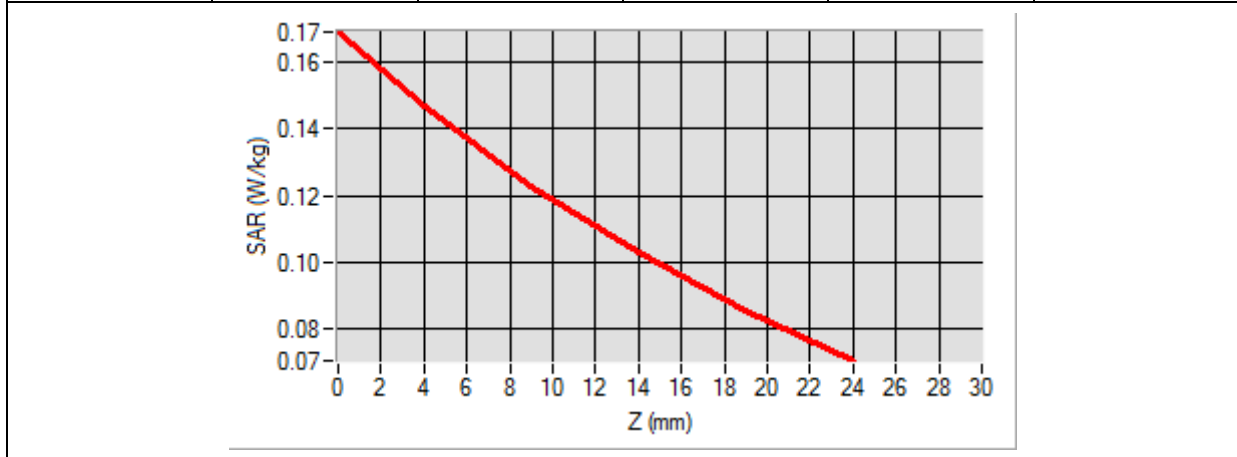
<b>Z (mm)</b>	<b>0.00</b>	<b>4.00</b>	<b>9.00</b>	<b>14.00</b>	<b>19.00</b>
<b>SAR (W/Kg)</b>	<b>0.1691</b>	<b>0.1469</b>	<b>0.1229</b>	<b>0.1027</b>	<b>0.0855</b>

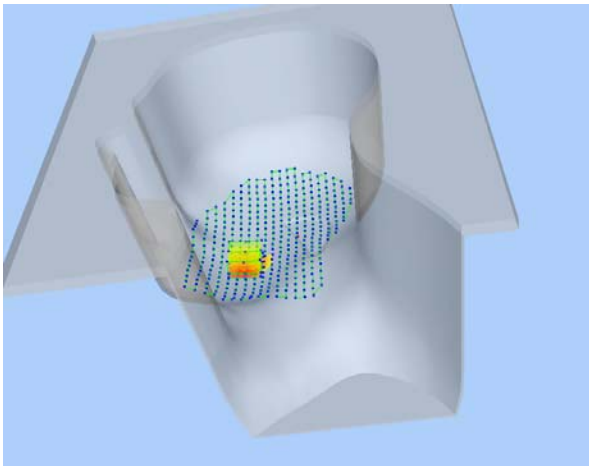

3D screen shot	Hot spot position
	

## MEASUREMENT 49

Type: Phone measurement (Complete)

Date of measurement: 08/20/2017

Measurement duration: 12 minutes 3 seconds

E-field Probe: SSE5 - SN 09/13 EP168; ConvF: 5.37; Calibrated: 06/01/2017

### A. Experimental conditions

<b>Area Scan</b>	sam_direct_droit2_surf8mm.txt
<b>Phantom</b>	Right head
<b>Device Position</b>	Cheek
<b>Band</b>	LTE Band 7_RMC
<b>Channels</b>	QPSK, 20MHz, 1RB, High
<b>Signal</b>	Duty Cycle 1:1

### B. SAR Measurement Results

<b>Frequency (MHz)</b>	2560.000000
<b>Relative Permittivity (real part)</b>	38.631092
<b>Conductivity (S/m)</b>	1.930182
<b>Power Variation (%)</b>	0.924535
<b>Ambient Temperature</b>	21.1
<b>Liquid Temperature</b>	21.2

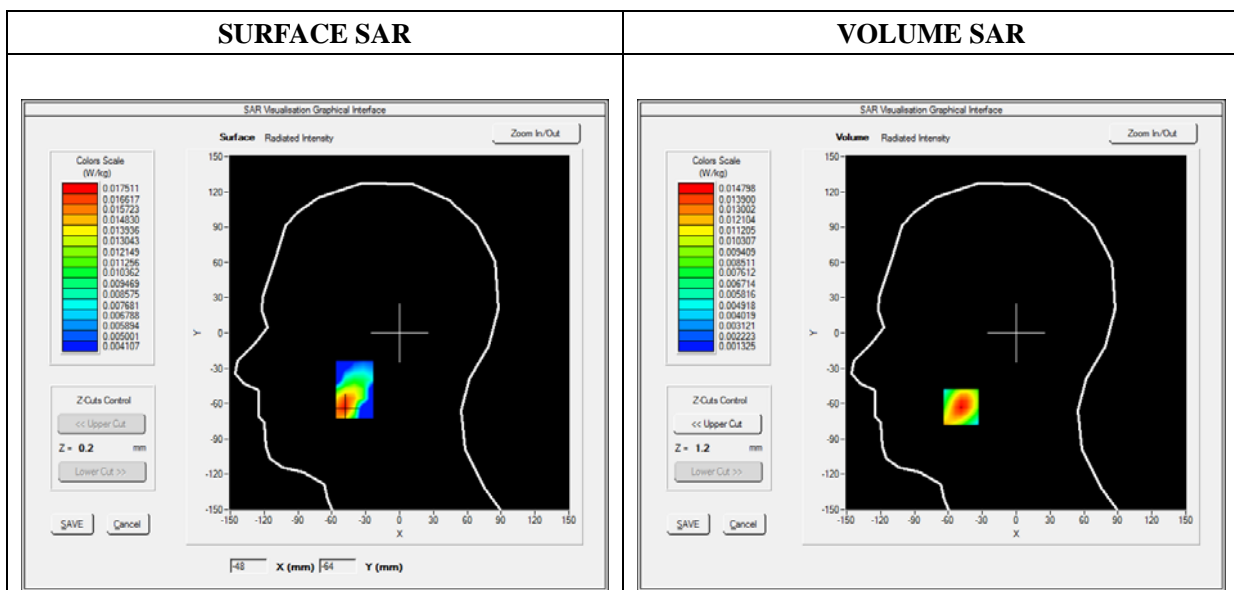

Maximum location: X=-49.00, Y=-63.00

SAR Peak: 0.02 W/kg

SAR 10g (W/Kg)	0.008025
SAR 1g (W/Kg)	0.013834

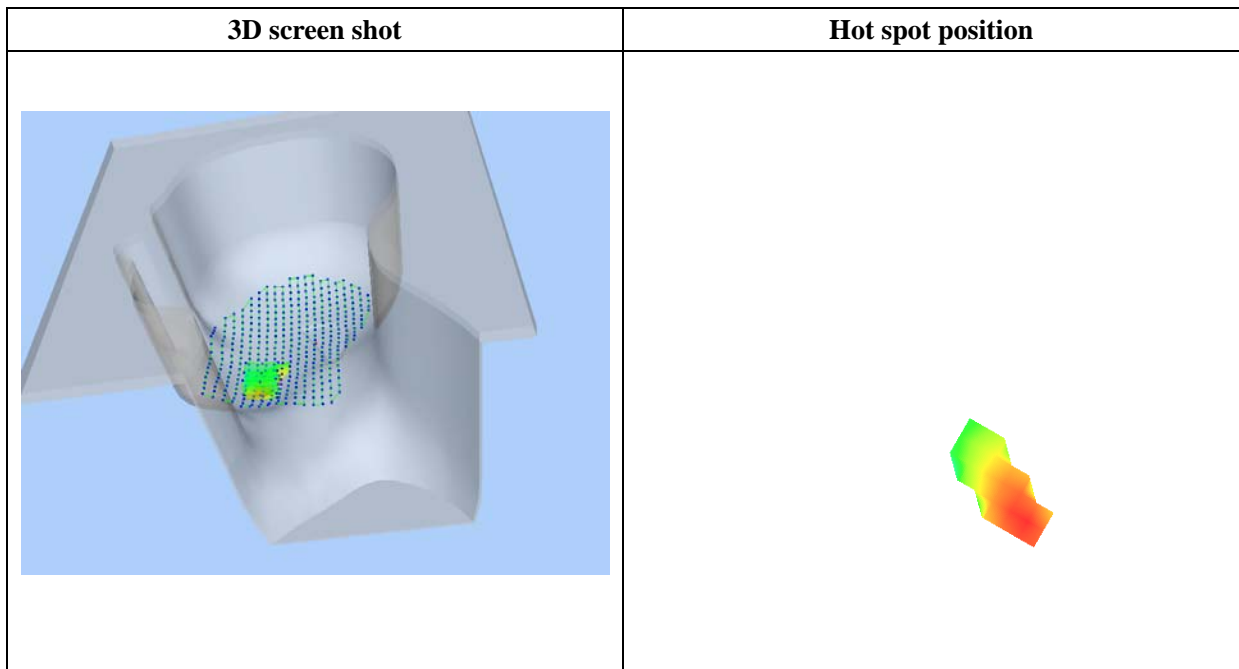
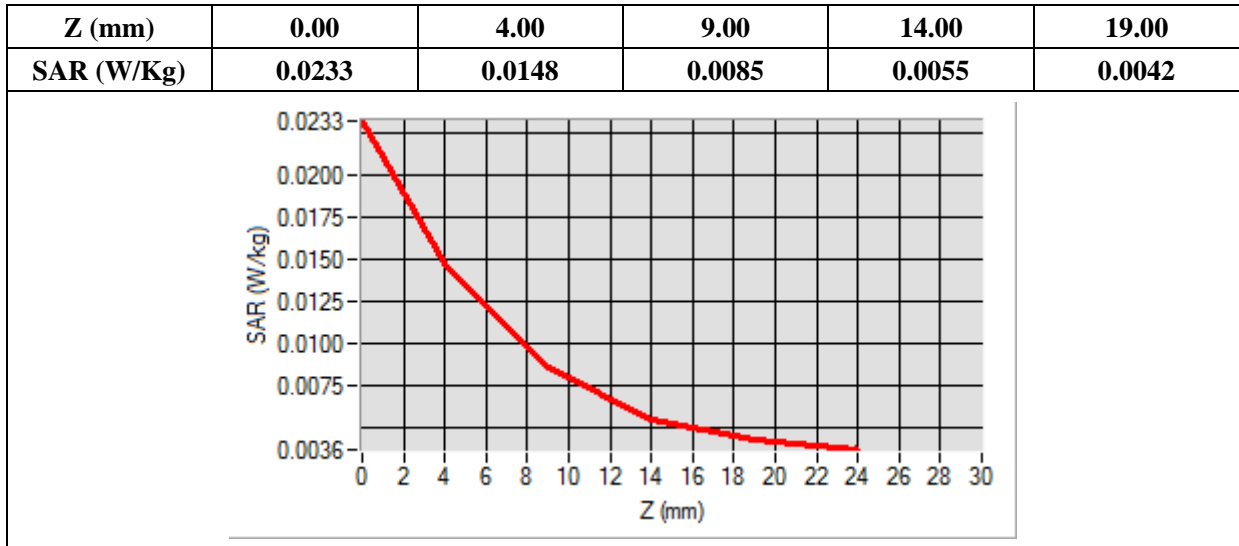



# MEASUREMENT 57

Type: Phone measurement (Complete)

Date of measurement: 08/20/2017

Measurement duration: 12 minutes 3 seconds

E-field Probe: SSE5 - SN 09/13 EP168; ConvF: 5.64; Calibrated: 06/01/2017

## A. Experimental conditions

<b>Area Scan</b>	sam_direct_droit2_surf8mm.txt
<b>Phantom</b>	Right head
<b>Device Position</b>	Cheek
<b>Band</b>	WiFi_802.11b
<b>Channels</b>	Low
<b>Signal</b>	Duty Cycle 1:1

## B. SAR Measurement Results

<b>Frequency (MHz)</b>	2412.000000
<b>Relative Permittivity (real part)</b>	38.153660
<b>Conductivity (S/m)</b>	1.740236
<b>Power Variation (%)</b>	3.234772
<b>Ambient Temperature</b>	21.1
<b>Liquid Temperature</b>	21.2

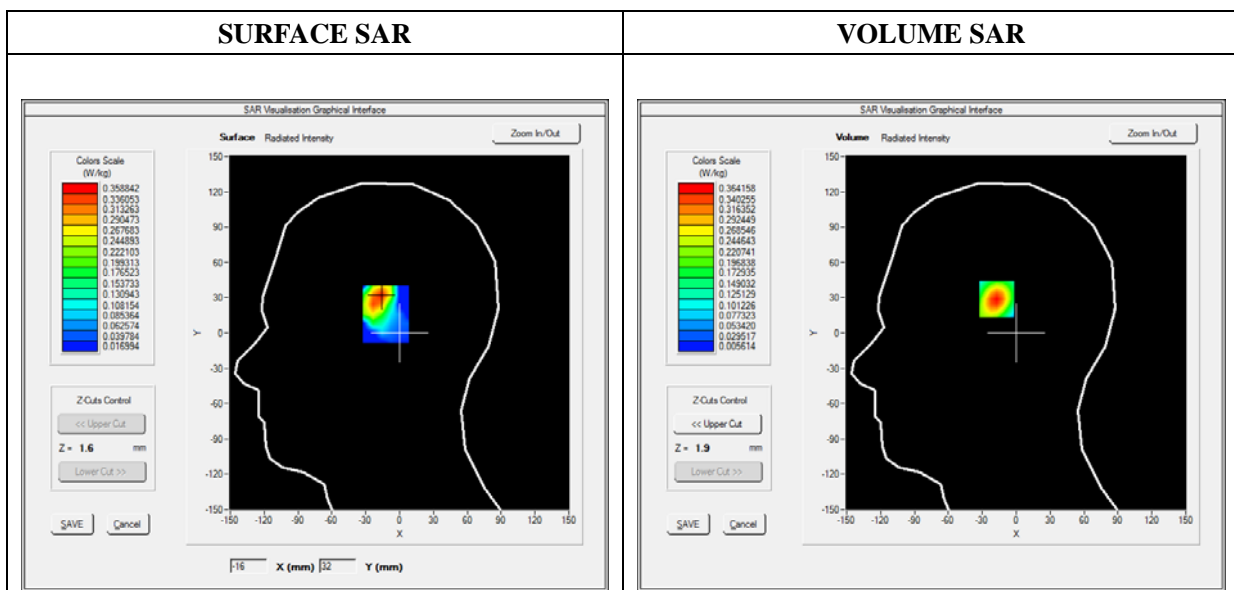

Maximum location: X=-17.00, Y=31.00

SAR Peak: 0.65 W/kg

SAR 10g (W/Kg)	0.162980
SAR 1g (W/Kg)	0.334941

Z (mm)	0.00	4.00	9.00	14.00	19.00
SAR (W/Kg)	0.6507	0.3642	0.1651	0.0741	0.0370

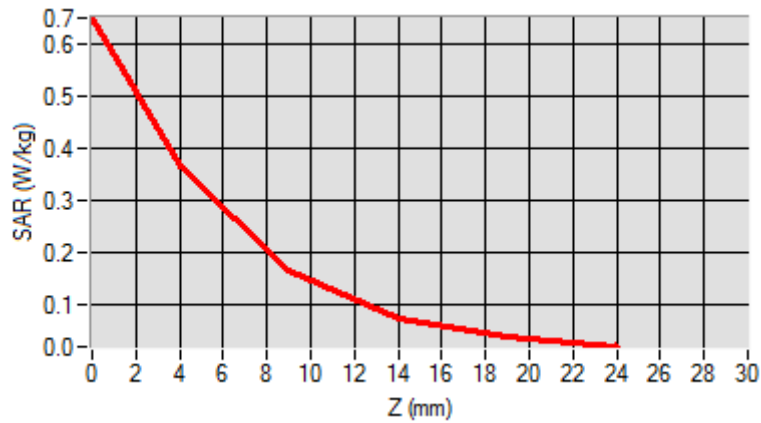

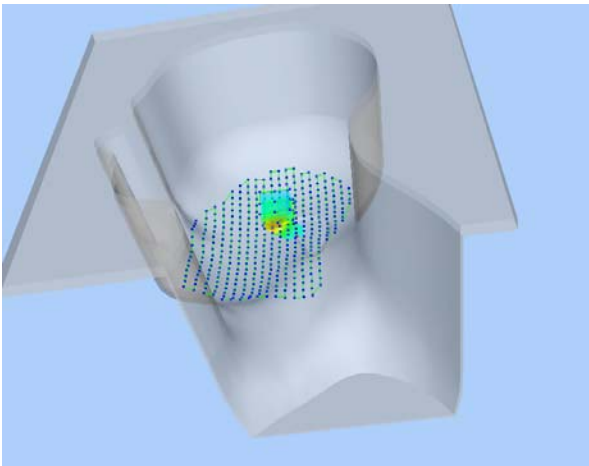
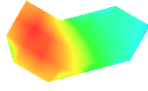
3D screen shot	Hot spot position
	

# MEASUREMENT 61

Type: Phone measurement (Complete)

Date of measurement: 05/22/2017

Measurement duration: 12 minutes 3 seconds

E-field Probe: SSE5 - SN 09/13 EP168; ConvF: 7.13; Calibrated: 06/01/2016

## A. Experimental conditions

<b>Area Scan</b>	sam_direct_droit2_surf8mm.txt
<b>Phantom</b>	Flat Plane
<b>Device Position</b>	Back(Body-worn)
<b>Band</b>	GSM850
<b>Channels</b>	Middle
<b>Signal</b>	TDMA (Crest factor: 8.0)

## B. SAR Measurement Results

<b>Frequency (MHz)</b>	836.600000
<b>Relative Permittivity (real part)</b>	54.851214
<b>Conductivity (S/m)</b>	0.951454
<b>Power Variation (%)</b>	0.785060
<b>Ambient Temperature</b>	21.1
<b>Liquid Temperature</b>	21.3

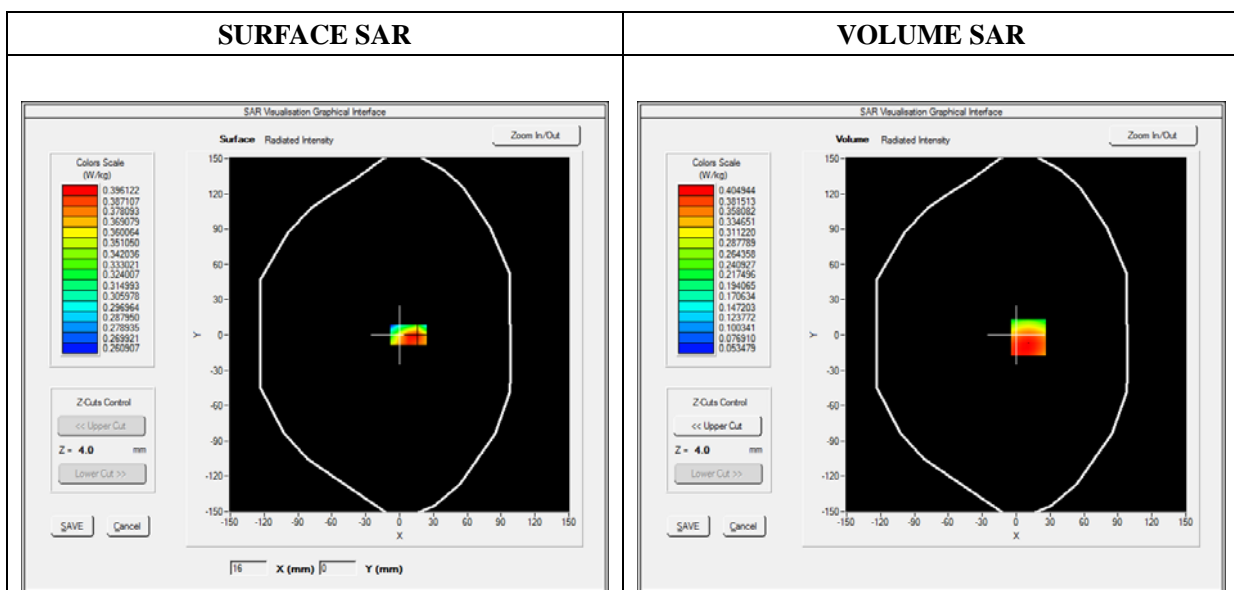



**Maximum location: X=11.00, Y=-2.00**

**SAR Peak: 0.53 W/kg**

<b>SAR 10g (W/Kg)</b>	<b>0.283436</b>
<b>SAR 1g (W/Kg)</b>	<b>0.393342</b>

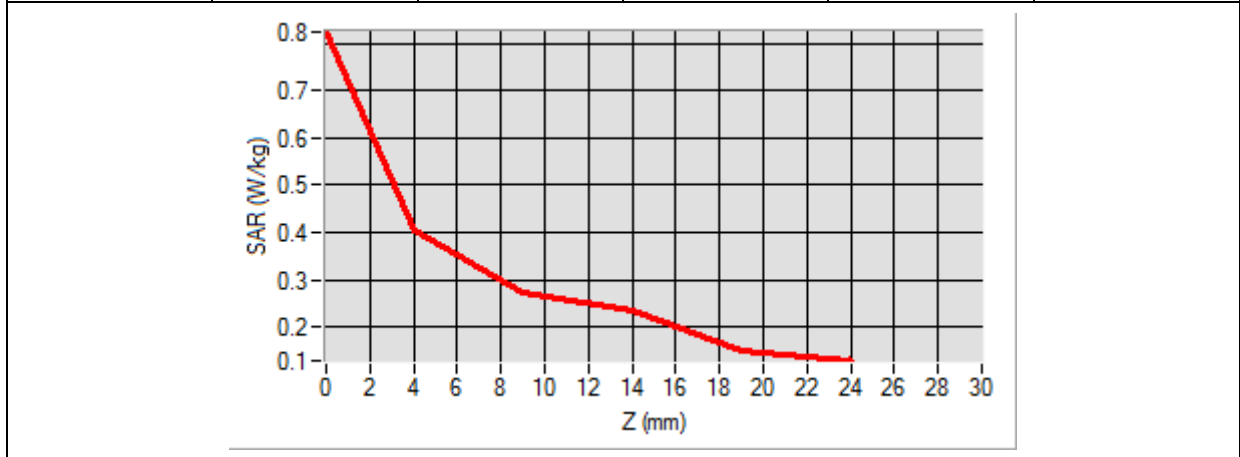
<b>Z (mm)</b>	<b>0.00</b>	<b>4.00</b>	<b>9.00</b>	<b>14.00</b>	<b>19.00</b>
<b>SAR (W/Kg)</b>	<b>0.8234</b>	<b>0.4049</b>	<b>0.2724</b>	<b>0.2338</b>	<b>0.1520</b>

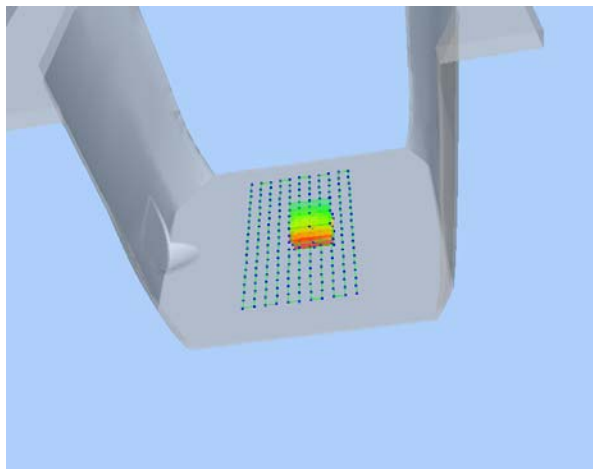

3D screen shot	Hot spot position
	

## MEASUREMENT 63

Type: Phone measurement (Complete)

Date of measurement: 05/22/2017

Measurement duration: 12 minutes 3 seconds

E-field Probe: SSE5 - SN 09/13 EP168; ConvF: 6.55; Calibrated: 06/01/2016

### A. Experimental conditions

<b>Area Scan</b>	sam_direct_droit2_surf8mm.txt
<b>Phantom</b>	Flat Plane
<b>Device Position</b>	Back(Body-worn)
<b>Band</b>	GSM1900
<b>Channels</b>	Middle
<b>Signal</b>	TDMA (Crest factor: 8.0)

### B. SAR Measurement Results

<b>Frequency (MHz)</b>	1880.000000
<b>Relative Permittivity (real part)</b>	52.420415
<b>Conductivity (S/m)</b>	1.501966
<b>Power Variation (%)</b>	0.568946
<b>Ambient Temperature</b>	21.1
<b>Liquid Temperature</b>	21.3

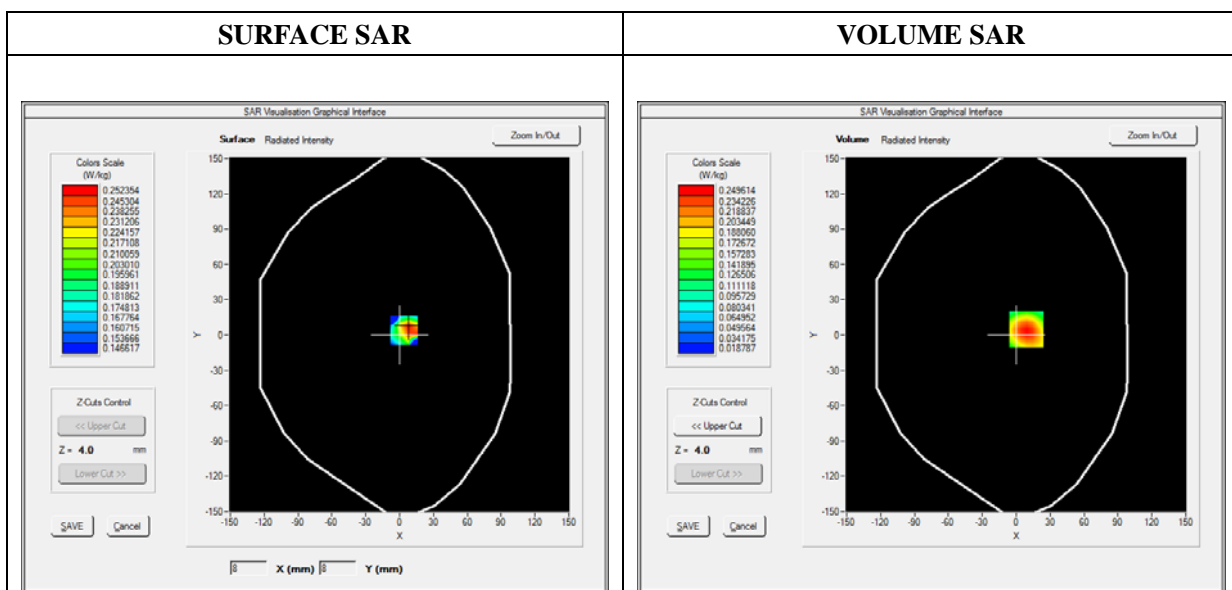



Maximum location: X=9.00, Y=5.00

SAR Peak: 0.38 W/kg

SAR 10g (W/Kg)	0.135743
SAR 1g (W/Kg)	0.234010

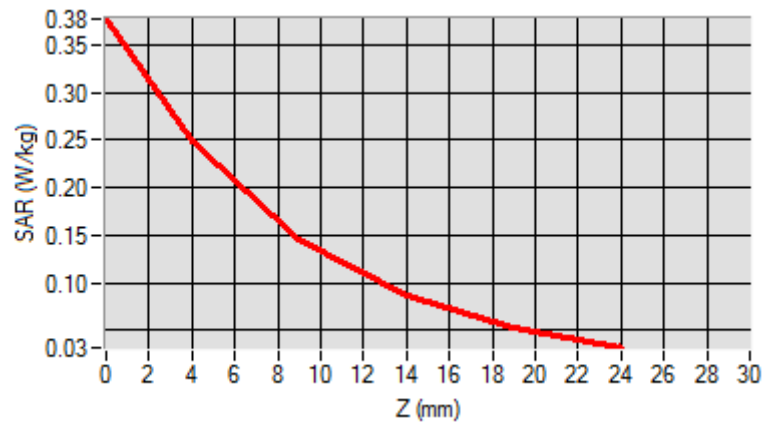
Z (mm)	0.00	4.00	9.00	14.00	19.00
SAR (W/Kg)	0.3769	0.2496	0.1464	0.0866	0.0531

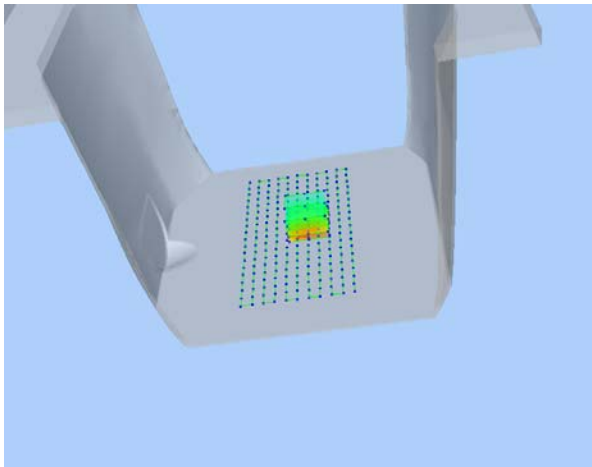

3D screen shot	Hot spot position
	

# MEASUREMENT 65

Type: Phone measurement (Complete)

Date of measurement: 08/20/2017

Measurement duration: 12 minutes 3 seconds

E-field Probe: SSE5 - SN 09/13 EP168; ConvF: 7.13; Calibrated: 06/01/2017

## A. Experimental conditions

<b>Area Scan</b>	sam_direct_droit2_surf8mm.txt
<b>Phantom</b>	Flat plane
<b>Device Position</b>	Back Side
<b>Band</b>	GPRS850_4TX
<b>Channels</b>	High
<b>Signal</b>	Duty Cycle: 1:2

## B. SAR Measurement Results

<b>Frequency (MHz)</b>	<b>848.800000</b>
<b>Relative Permittivity (real part)</b>	54.851214
<b>Conductivity (S/m)</b>	0.951454
<b>Power Variation (%)</b>	0.901472
<b>Ambient Temperature</b>	21.1
<b>Liquid Temperature</b>	21.3

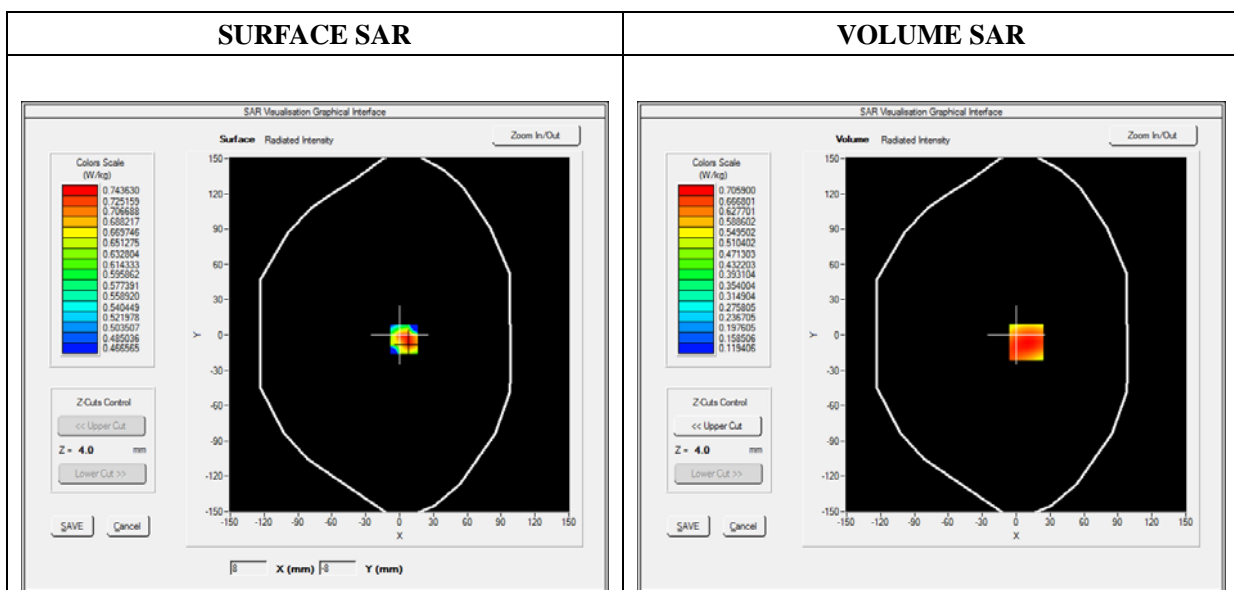



Maximum location: X=9.00, Y=-6.00

SAR Peak: 0.94 W/kg

SAR 10g (W/Kg)	0.492454
SAR 1g (W/Kg)	0.681815

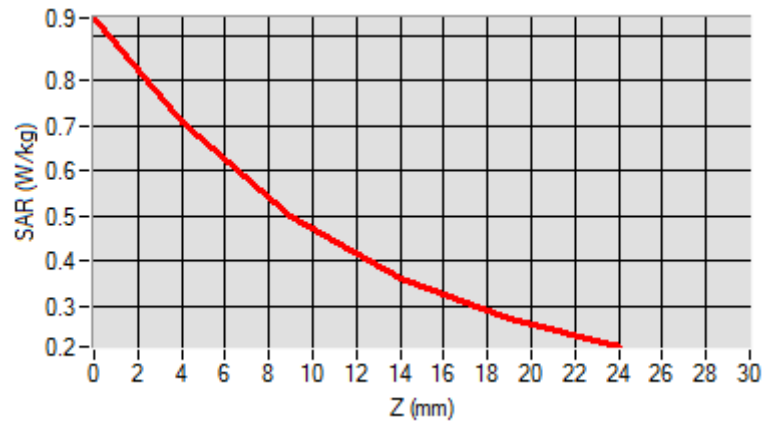
Z (mm)	0.00	4.00	9.00	14.00	19.00
SAR (W/Kg)	0.9387	0.7059	0.4983	0.3622	0.2742

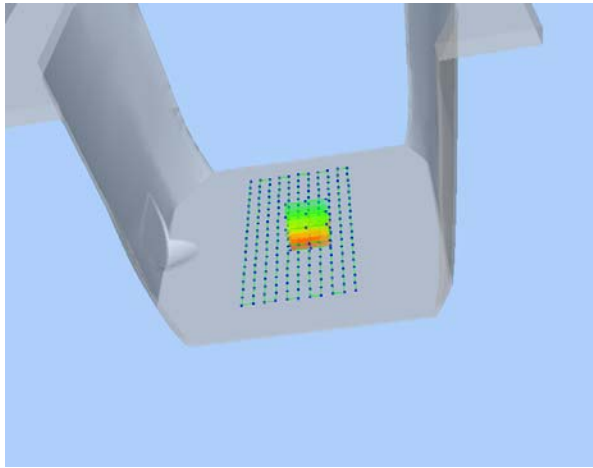

3D screen shot	Hot spot position
	



# MEASUREMENT 71

Type: Phone measurement (Complete)

Date of measurement: 08/20/2017

Measurement duration: 12 minutes 3 seconds

E-field Probe: SSE5 - SN 09/13 EP168; ConvF: 6.55; Calibrated: 06/01/2017

## A. Experimental conditions

<b>Area Scan</b>	sam_direct_droit2_surf8mm.txt
<b>Phantom</b>	Flat plane
<b>Device Position</b>	Front Side
<b>Band</b>	GPRS1900_4TX
<b>Channels</b>	Middle
<b>Signal</b>	Duty Cycle: 1:2

## B. SAR Measurement Results

<b>Frequency (MHz)</b>	1880.000000
<b>Relative Permittivity (real part)</b>	52.420415
<b>Conductivity (S/m)</b>	1.501966
<b>Power Variation (%)</b>	2.483762
<b>Ambient Temperature</b>	21.1
<b>Liquid Temperature</b>	21.3

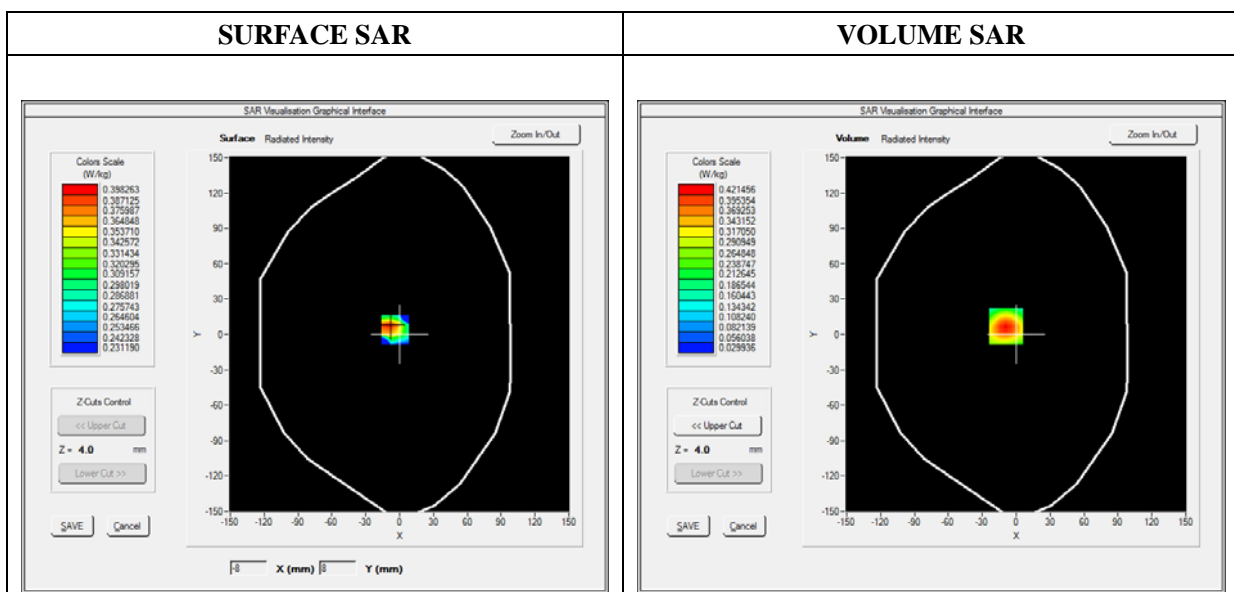

**Maximum location: X=-9.00, Y=7.00**

**SAR Peak: 0.64 W/kg**

<b>SAR 10g (W/Kg)</b>	<b>0.222624</b>
<b>SAR 1g (W/Kg)</b>	<b>0.391280</b>

<b>Z (mm)</b>	<b>0.00</b>	<b>4.00</b>	<b>9.00</b>	<b>14.00</b>	<b>19.00</b>
<b>SAR (W/Kg)</b>	<b>0.6428</b>	<b>0.4215</b>	<b>0.2438</b>	<b>0.1423</b>	<b>0.0865</b>

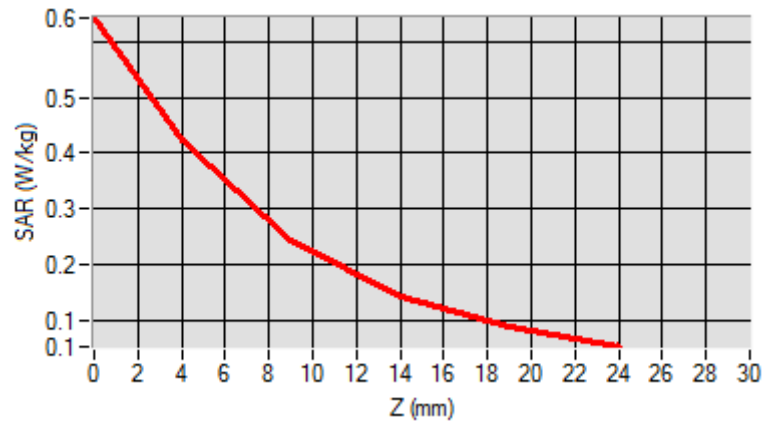

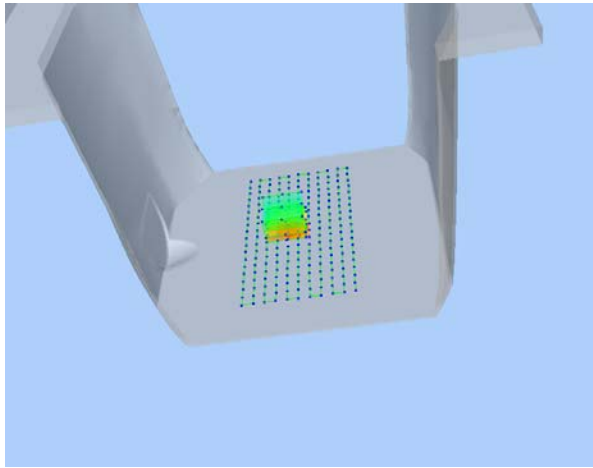
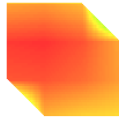
<b>3D screen shot</b>	<b>Hot spot position</b>
	

# MEASUREMENT 75

Type: Phone measurement (Complete)

Date of measurement: 08/20/2017

Measurement duration: 12 minutes 3 seconds

E-field Probe: SSE5 - SN 09/13 EP168; ConvF: 6.55; Calibrated: 06/01/2017

## A. Experimental conditions

<b>Area Scan</b>	sam_direct_droit2_surf8mm.txt
<b>Phantom</b>	Flat Plane
<b>Device Position</b>	Back
<b>Band</b>	WCDMA1900_RMC
<b>Channels</b>	Middle
<b>Signal</b>	Duty Cycle 1:1

## B. SAR Measurement Results

<b>Frequency (MHz)</b>	1880.000000
<b>Relative Permittivity (real part)</b>	52.420415
<b>Conductivity (S/m)</b>	1.501966
<b>Power Variation (%)</b>	1.847552
<b>Ambient Temperature</b>	21.1
<b>Liquid Temperature</b>	21.3

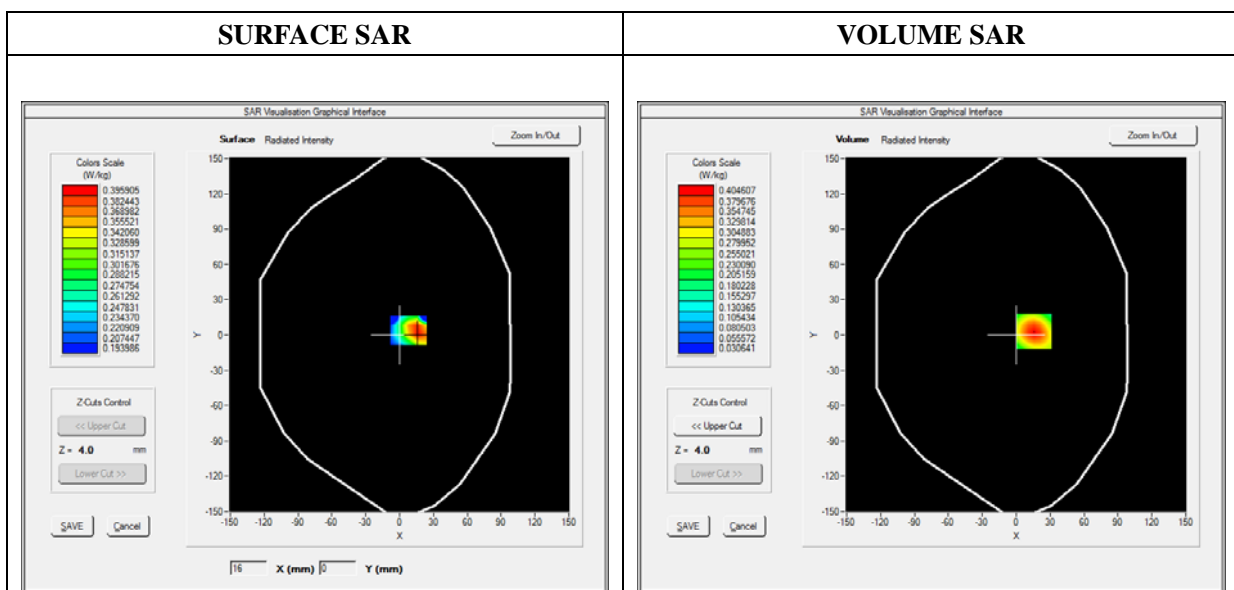

**Maximum location: X=16.00, Y=3.00**

**SAR Peak: 0.62 W/kg**

<b>SAR 10g (W/Kg)</b>	<b>0.215897</b>
<b>SAR 1g (W/Kg)</b>	<b>0.376281</b>

<b>Z (mm)</b>	<b>0.00</b>	<b>4.00</b>	<b>9.00</b>	<b>14.00</b>	<b>19.00</b>
<b>SAR (W/Kg)</b>	<b>0.6227</b>	<b>0.4046</b>	<b>0.2315</b>	<b>0.1343</b>	<b>0.0819</b>

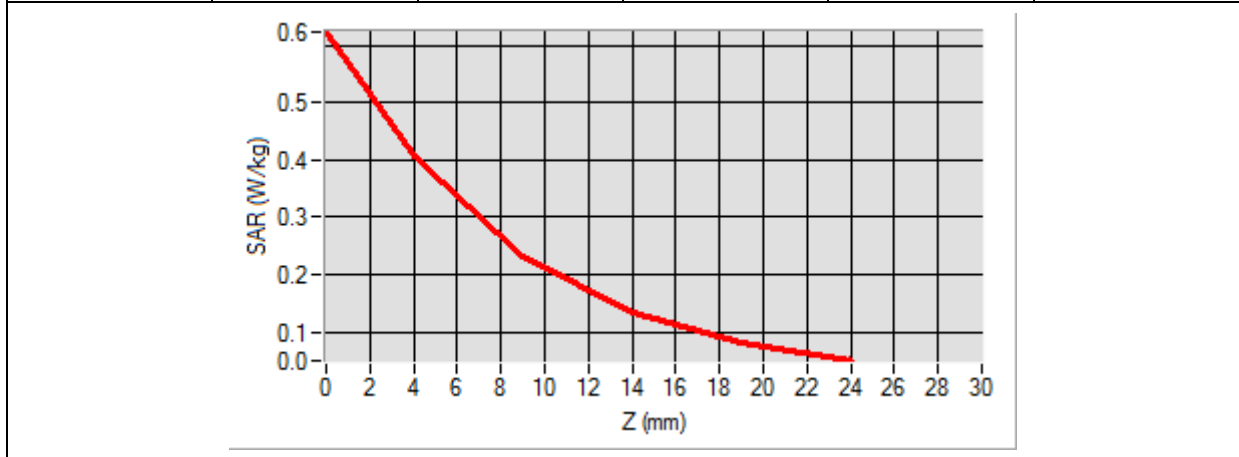

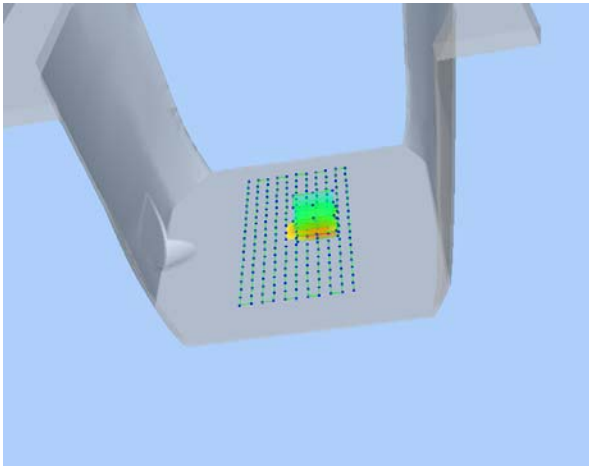
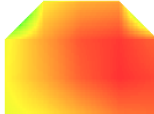
3D screen shot	Hot spot position
	

# MEASUREMENT 81

Type: Phone measurement (Complete)

Date of measurement: 08/20/2017

Measurement duration: 12 minutes 3 seconds

E-field Probe: SSE5 - SN 09/13 EP168; ConvF: 7.13; Calibrated: 06/01/2017

## A. Experimental conditions

<b>Area Scan</b>	sam_direct_droit2_surf8mm.txt
<b>Phantom</b>	Flat Plane
<b>Device Position</b>	Front
<b>Band</b>	WCDMA850_RMC
<b>Channels</b>	Middle
<b>Signal</b>	Duty Cycle 1:1

## B. SAR Measurement Results

<b>Frequency (MHz)</b>	836.600000
<b>Relative Permittivity (real part)</b>	54.851214
<b>Conductivity (S/m)</b>	0.951454
<b>Power Variation (%)</b>	2.341234
<b>Ambient Temperature</b>	21.1
<b>Liquid Temperature</b>	21.3

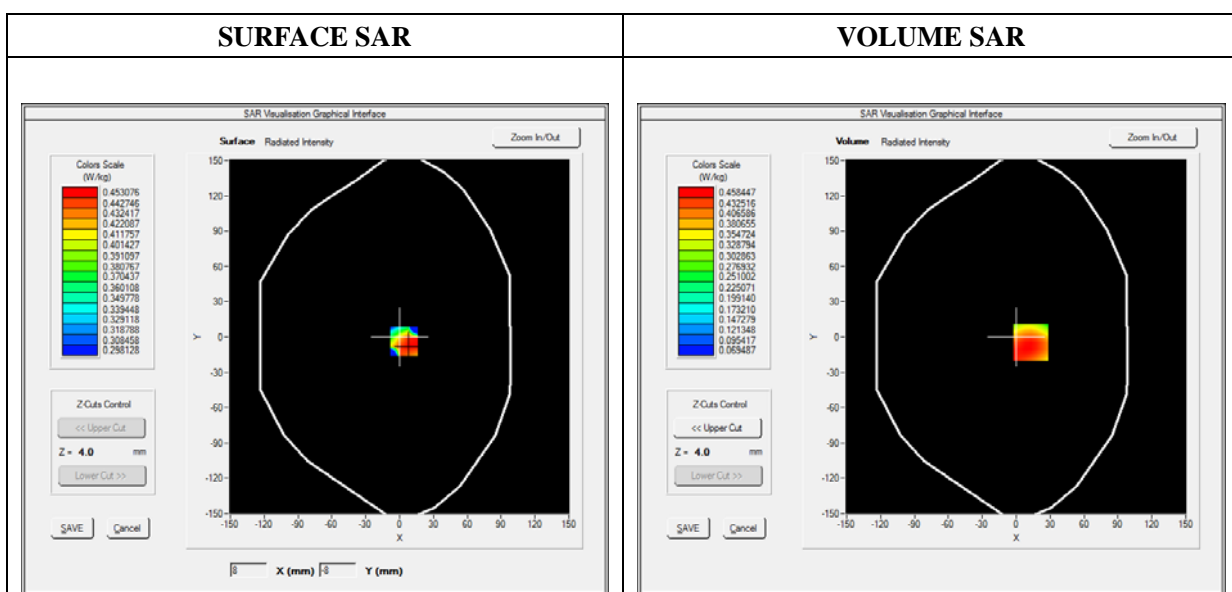



Maximum location: X=13.00, Y=-5.00

SAR Peak: 0.58 W/kg

SAR 10g (W/Kg)	0.324798
SAR 1g (W/Kg)	0.430154

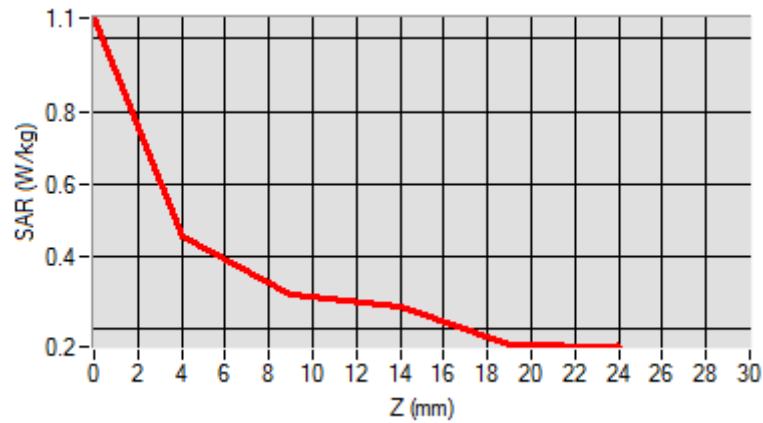
Z (mm)	0.00	4.00	9.00	14.00	19.00
SAR (W/Kg)	1.0578	0.4584	0.2976	0.2650	0.1578

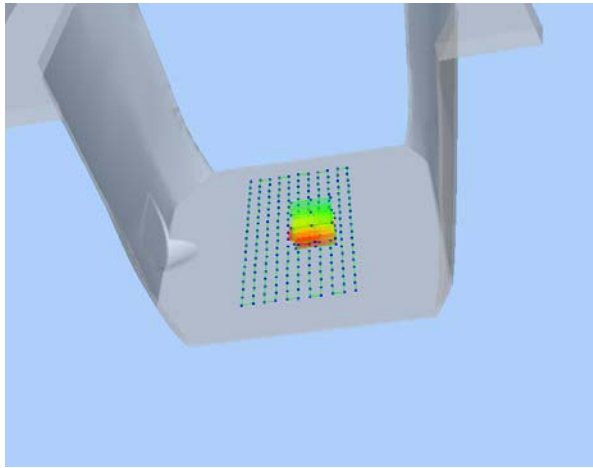

3D screen shot	Hot spot position
	

# MEASUREMENT 85

Type: Phone measurement (Complete)

Date of measurement: 08/20/2017

Measurement duration: 12 minutes 3 seconds

E-field Probe: SSE5 - SN 09/13 EP168; ConvF: 6.55; Calibrated: 06/01/2017

## A. Experimental conditions

<b>Area Scan</b>	sam_direct_droit2_surf8mm.txt
<b>Phantom</b>	Flat Plane
<b>Device Position</b>	Back
<b>Band</b>	LTE Band 2_RMC
<b>Channels</b>	QPSK, 20MHz, 1RB, Low
<b>Signal</b>	Duty Cycle 1:1

## B. SAR Measurement Results

<b>Frequency (MHz)</b>	1860.000000
<b>Relative Permittivity (real part)</b>	52.420415
<b>Conductivity (S/m)</b>	1.501966
<b>Power Variation (%)</b>	1.523573
<b>Ambient Temperature</b>	21.1
<b>Liquid Temperature</b>	21.3

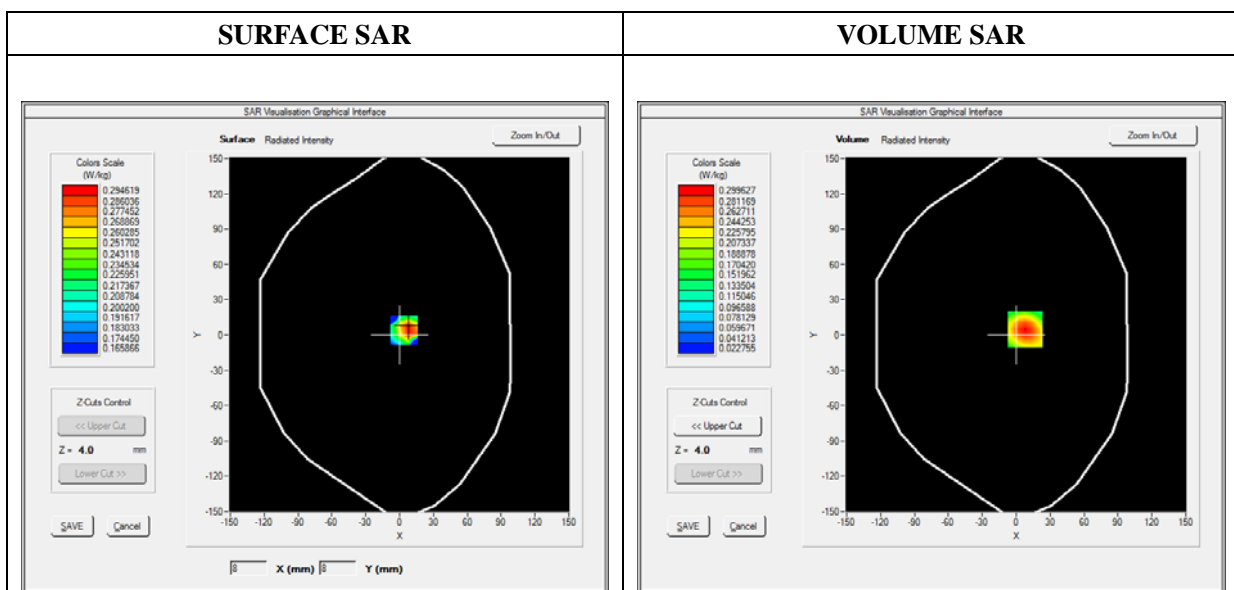



Maximum location: X=8.00, Y=5.00

SAR Peak: 0.46 W/kg

SAR 10g (W/Kg)	0.160961
SAR 1g (W/Kg)	0.279697

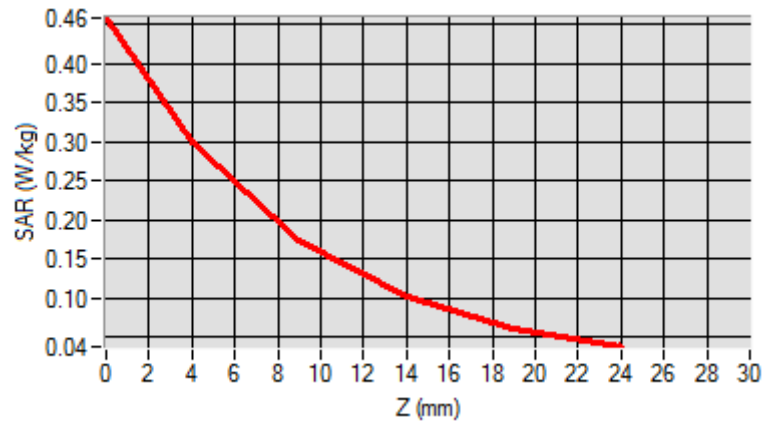
Z (mm)	0.00	4.00	9.00	14.00	19.00
SAR (W/Kg)	0.4582	0.2996	0.1729	0.1011	0.0620

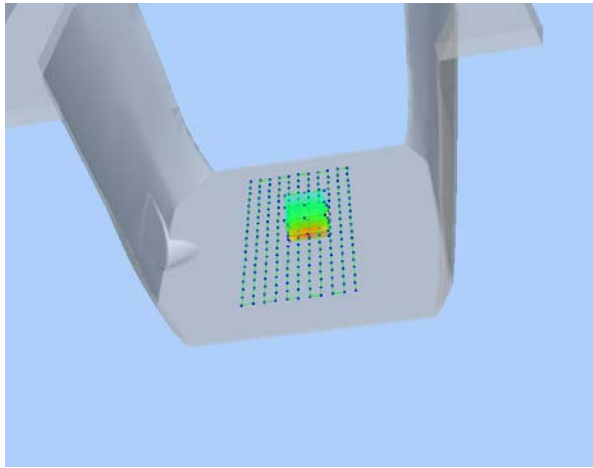

3D screen shot	Hot spot position
	



# MEASUREMENT 95

Type: Phone measurement (Complete)

Date of measurement: 08/20/2017

Measurement duration: 12 minutes 3 seconds

E-field Probe: SSE5 - SN 09/13 EP168; ConvF: 6.06; Calibrated: 06/01/2017

## A. Experimental conditions

<b>Area Scan</b>	sam_direct_droit2_surf8mm.txt
<b>Phantom</b>	Flat Plane
<b>Device Position</b>	Back
<b>Band</b>	LTE Band 4_RMC
<b>Channels</b>	QPSK, 20MHz, 1RB, Low
<b>Signal</b>	Duty Cycle 1:1

## B. SAR Measurement Results

<b>Frequency (MHz)</b>	1720.000000
<b>Relative Permittivity (real part)</b>	51.224510
<b>Conductivity (S/m)</b>	1.461261
<b>Power Variation (%)</b>	0.858383
<b>Ambient Temperature</b>	21.1
<b>Liquid Temperature</b>	21.2

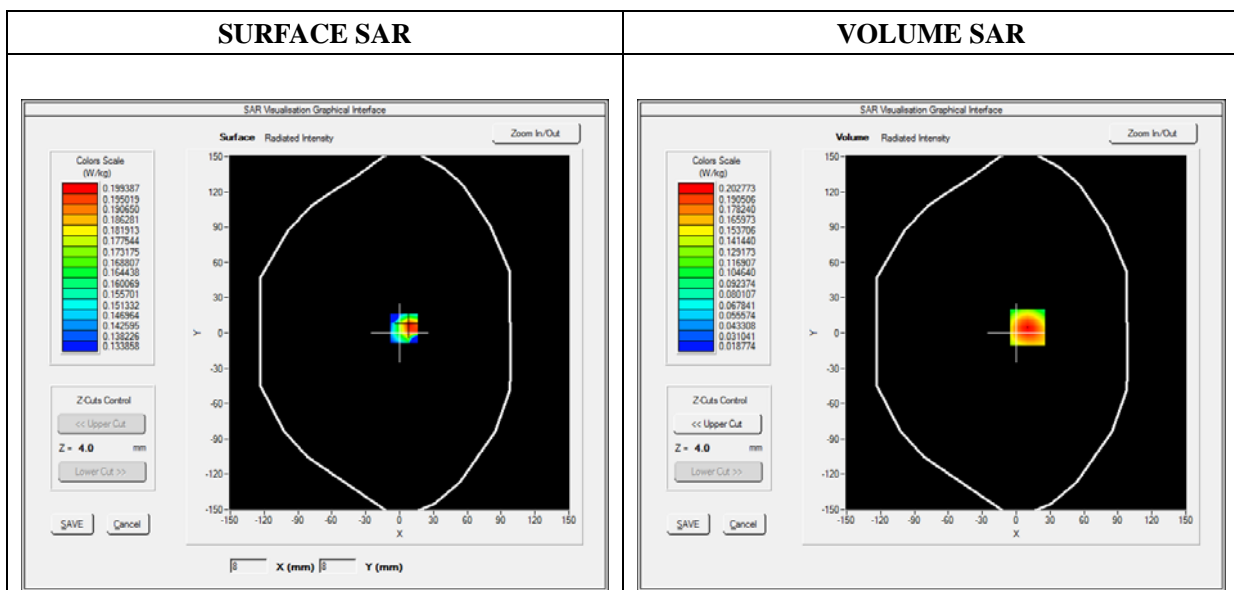



**Maximum location: X=10.00, Y=5.00**

**SAR Peak: 0.30 W/kg**

<b>SAR 10g (W/Kg)</b>	<b>0.113518</b>
<b>SAR 1g (W/Kg)</b>	<b>0.190465</b>

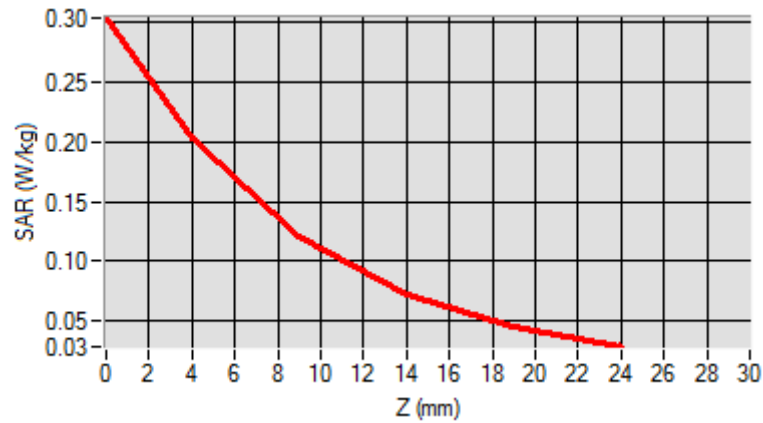
<b>Z (mm)</b>	<b>0.00</b>	<b>4.00</b>	<b>9.00</b>	<b>14.00</b>	<b>19.00</b>
<b>SAR (W/Kg)</b>	<b>0.3034</b>	<b>0.2028</b>	<b>0.1208</b>	<b>0.0729</b>	<b>0.0459</b>

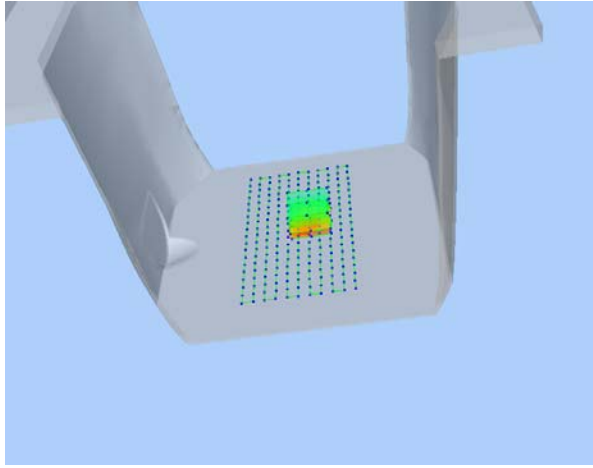

3D screen shot	Hot spot position
	

# MEASUREMENT 105

Type: Phone measurement (Complete)

Date of measurement: 08/20/2017

Measurement duration: 12 minutes 3 seconds

E-field Probe: SSE5 - SN 09/13 EP168; ConvF: 7.13; Calibrated: 06/01/2017

## A. Experimental conditions

<b>Area Scan</b>	sam_direct_droit2_surf8mm.txt
<b>Phantom</b>	Flat Plane
<b>Device Position</b>	Back
<b>Band</b>	LTE Band 5_RMC
<b>Channels</b>	QPSK, 10MHz, 1RB, Low
<b>Signal</b>	Duty Cycle 1:1

## B. SAR Measurement Results

<b>Frequency (MHz)</b>	829.000000
<b>Relative Permittivity (real part)</b>	54.851214
<b>Conductivity (S/m)</b>	0.951454
<b>Power Variation (%)</b>	1.037332
<b>Ambient Temperature</b>	21.1
<b>Liquid Temperature</b>	21.2

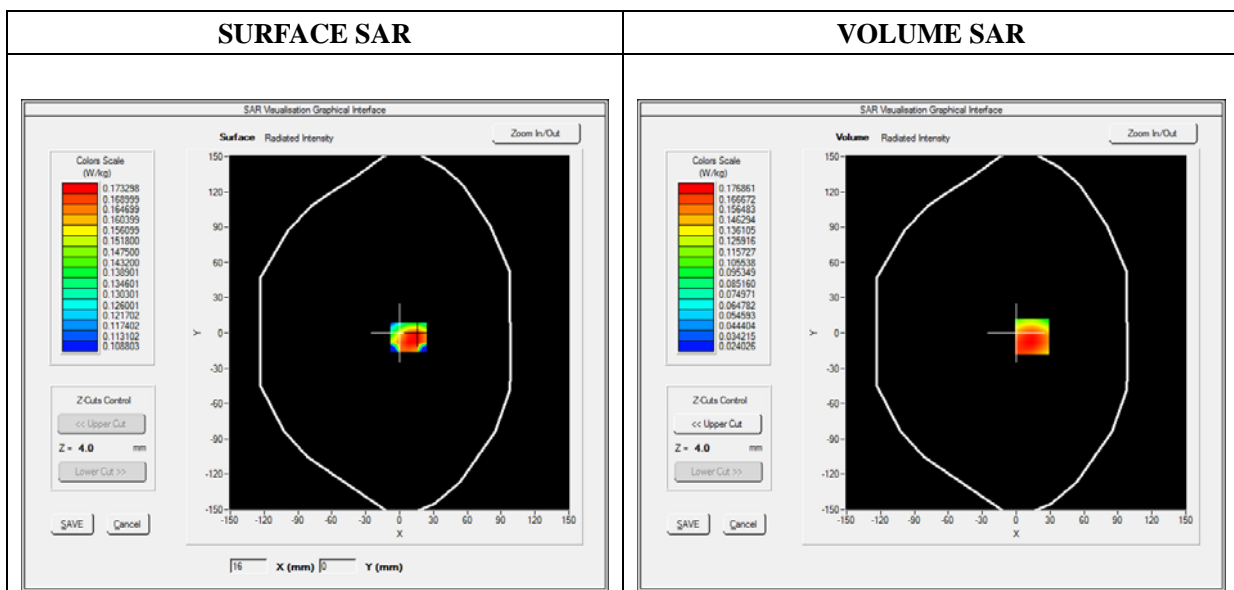



Maximum location: X=14.00, Y=-3.00

SAR Peak: 0.23 W/kg

SAR 10g (W/Kg)	0.123151
SAR 1g (W/Kg)	0.171579

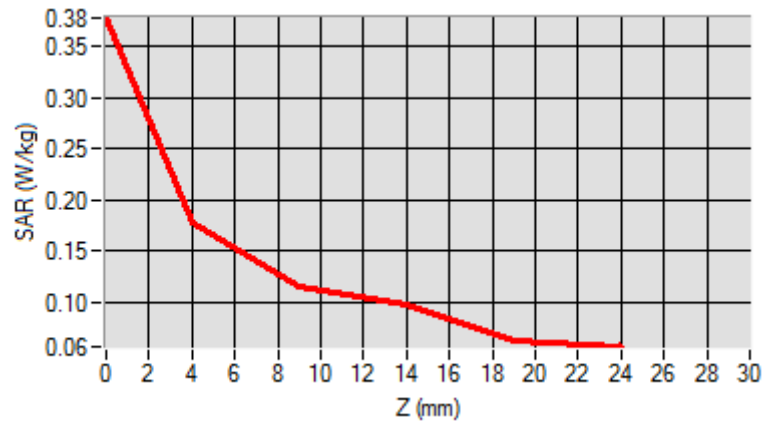
Z (mm)	0.00	4.00	9.00	14.00	19.00
SAR (W/Kg)	0.3778	0.1769	0.1140	0.0972	0.0611

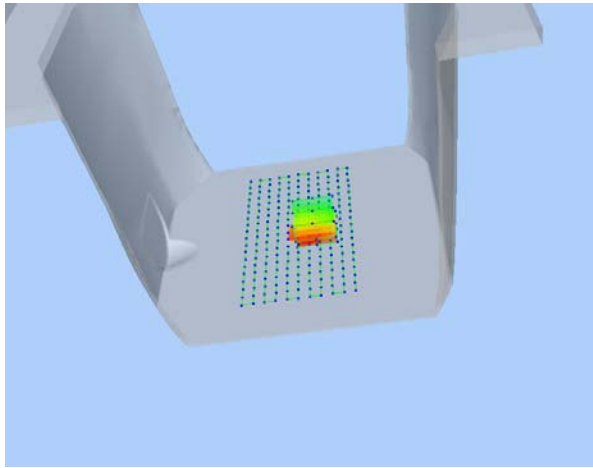

3D screen shot	Hot spot position
	

# MEASUREMENT 115

Type: Phone measurement (Complete)

Date of measurement: 08/20/2017

Measurement duration: 12 minutes 3 seconds

E-field Probe: SSE5 - SN 09/13 EP168; ConvF: 5.58; Calibrated: 06/01/2017

## A. Experimental conditions

<b>Area Scan</b>	sam_direct_droit2_surf8mm.txt
<b>Phantom</b>	Flat Plane
<b>Device Position</b>	Back
<b>Band</b>	LTE Band 7_RMC
<b>Channels</b>	QPSK, 20MHz, 1RB, High
<b>Signal</b>	Duty Cycle 1:1

## B. SAR Measurement Results

<b>Frequency (MHz)</b>	2560.000000
<b>Relative Permittivity (real part)</b>	52.241202
<b>Conductivity (S/m)</b>	2.120943
<b>Power Variation (%)</b>	3.672346
<b>Ambient Temperature</b>	21.1
<b>Liquid Temperature</b>	21.2

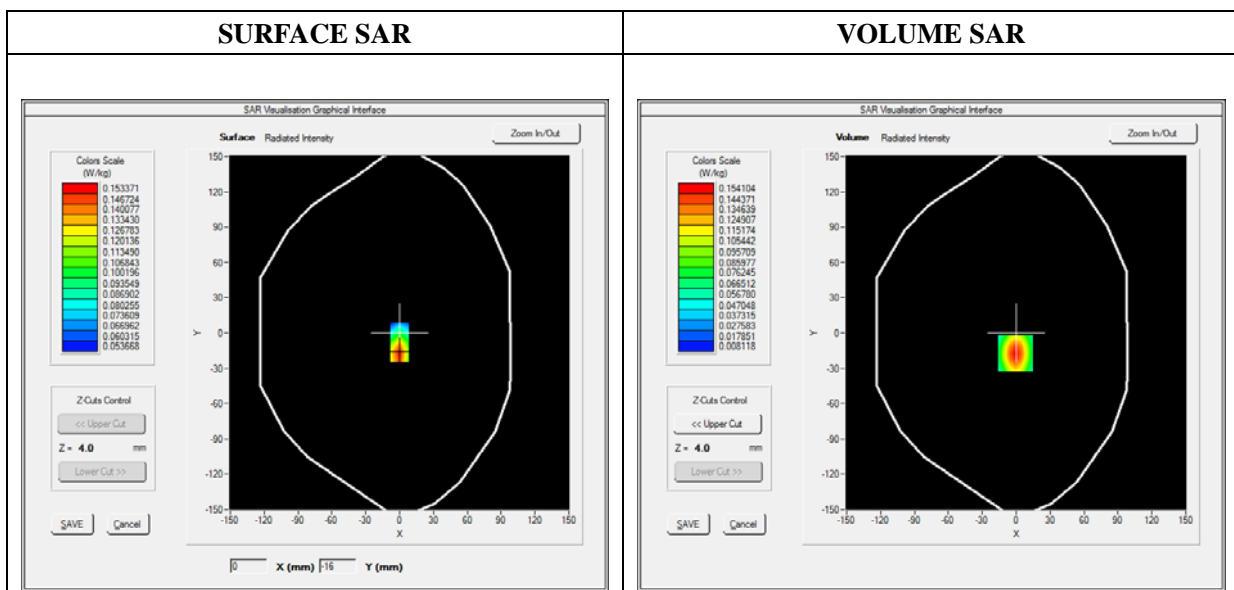



Maximum location: X=-1.00, Y=-17.00

SAR Peak: 0.25 W/kg

SAR 10g (W/Kg)	0.074579
SAR 1g (W/Kg)	0.141757

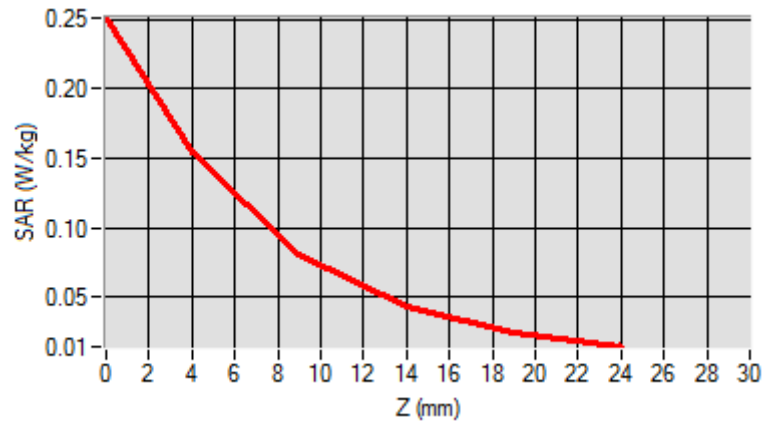
Z (mm)	0.00	4.00	9.00	14.00	19.00
SAR (W/Kg)	0.2512	0.1541	0.0810	0.0430	0.0245

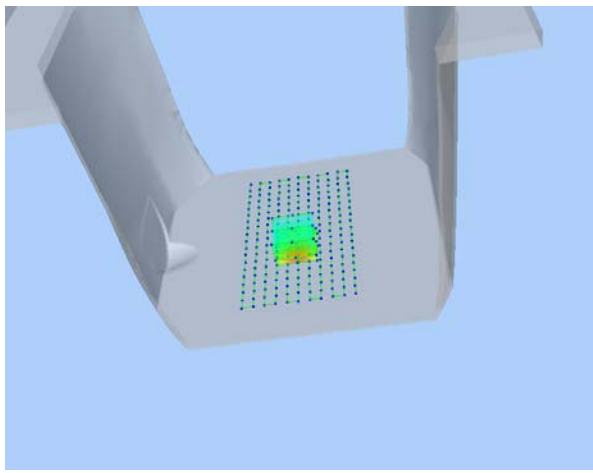

3D screen shot	Hot spot position
	

# MEASUREMENT 125

Type: Phone measurement (Complete)

Date of measurement: 08/20/2017

Measurement duration: 12 minutes 3 seconds

E-field Probe: SSE5 - SN 09/13 EP168; ConvF: 5.80; Calibrated: 06/01/2017

## A. Experimental conditions

<b>Area Scan</b>	sam_direct_droit2_surf8mm.txt
<b>Phantom</b>	Flat Plane
<b>Device Position</b>	Back
<b>Band</b>	WiFi_802.11b
<b>Channels</b>	Low
<b>Signal</b>	Duty Cycle 1:1

## B. SAR Measurement Results

<b>Frequency (MHz)</b>	2412.000000
<b>Relative Permittivity (real part)</b>	52.010212
<b>Conductivity (S/m)</b>	1.910255
<b>Power Variation (%)</b>	2.492743
<b>Ambient Temperature</b>	21.1
<b>Liquid Temperature</b>	21.2

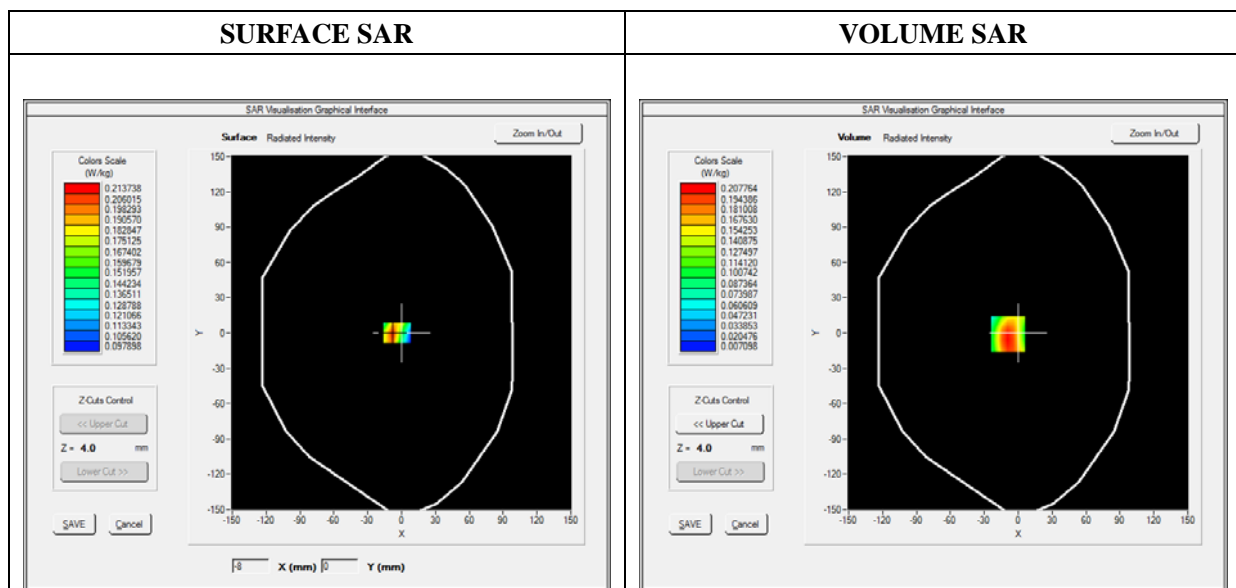



**Maximum location: X=-9.00, Y=-1.00**

**SAR Peak: 0.36 W/kg**

<b>SAR 10g (W/Kg)</b>	<b>0.101053</b>
<b>SAR 1g (W/Kg)</b>	<b>0.194333</b>

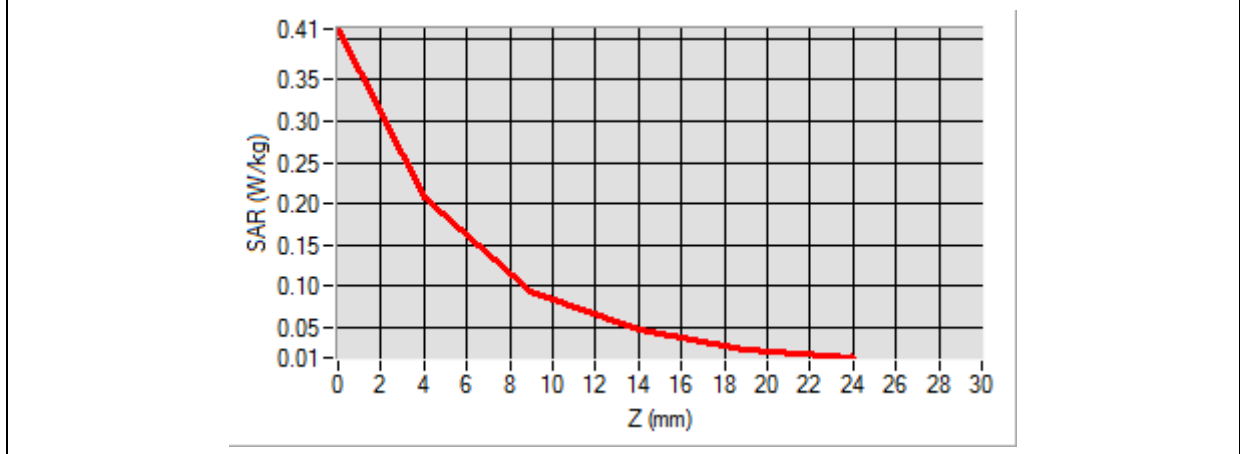
<b>Z (mm)</b>	<b>0.00</b>	<b>4.00</b>	<b>9.00</b>	<b>14.00</b>	<b>19.00</b>
<b>SAR (W/Kg)</b>	<b>0.4114</b>	<b>0.2078</b>	<b>0.0931</b>	<b>0.0482</b>	<b>0.0235</b>

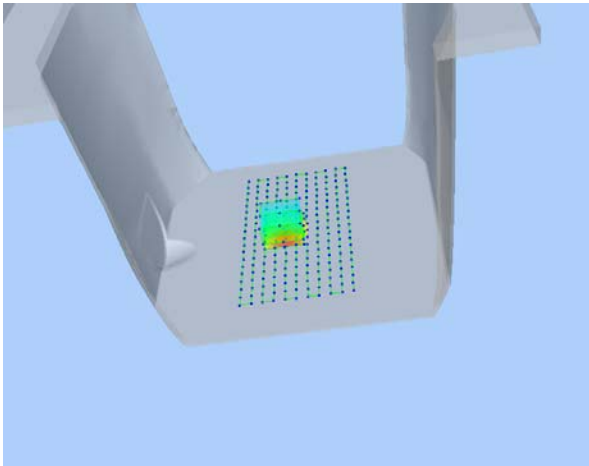

3D screen shot	Hot spot position
	



## Annex C. EUT Photos

---

### EUT View Front



### EUT View Back



## Annex D. Test Setup Photos

---

### Head Exposure Conditions

**Cheek**

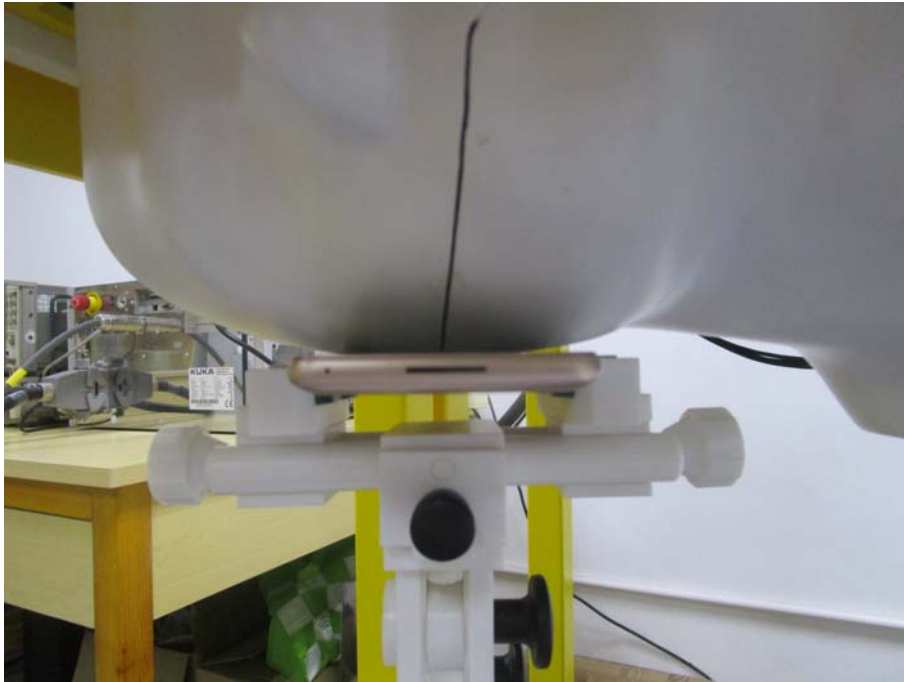

**Tilt**

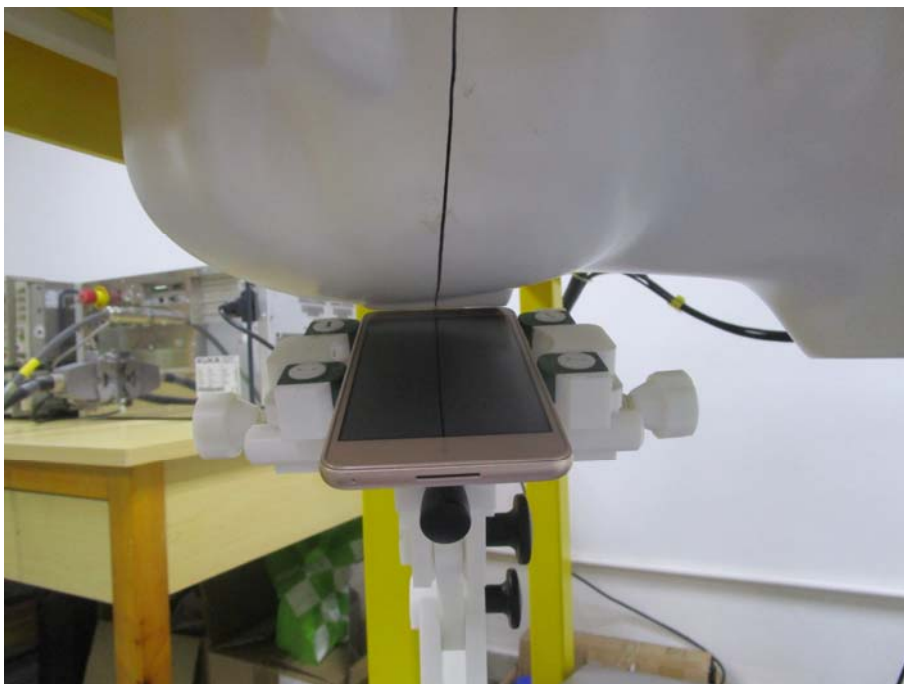

**Check**

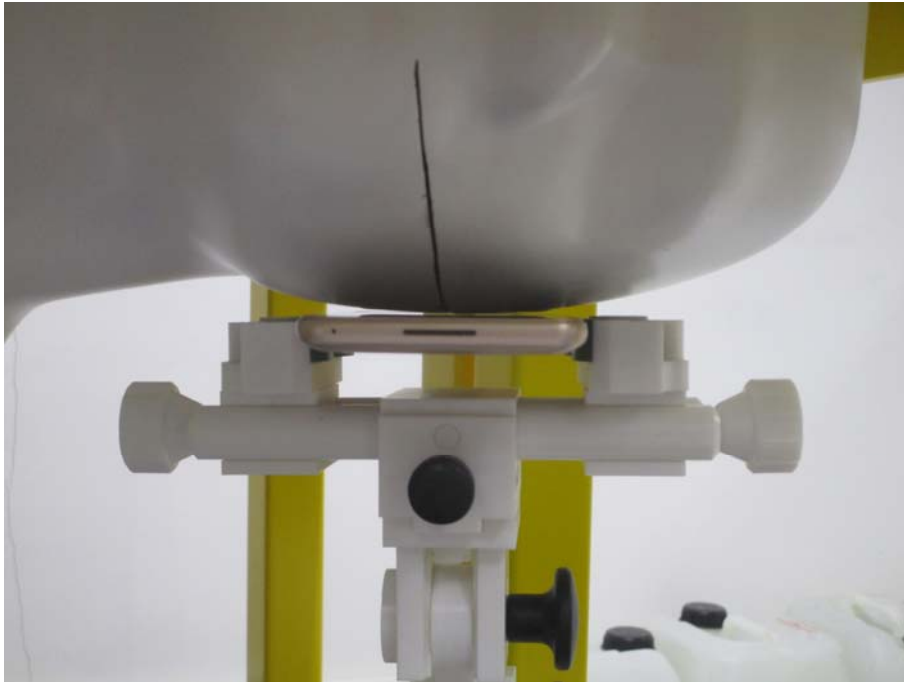

**Tilt**

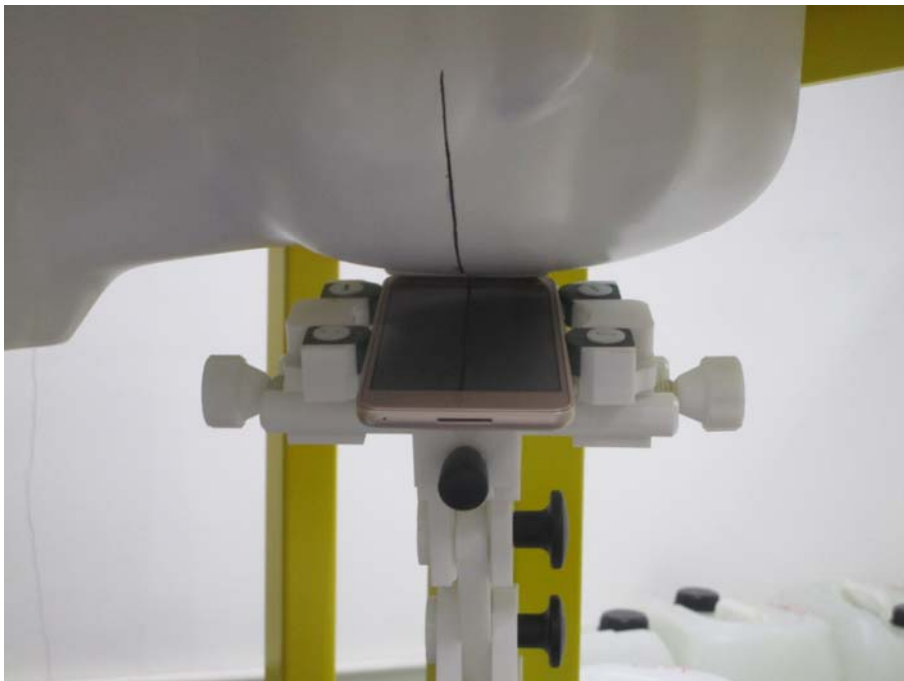

## Body-worn & Hotspot mode Exposure Conditions

### Body Front



### Body Back



## Hotspot Exposure Conditions

### Body Left



### Body Right

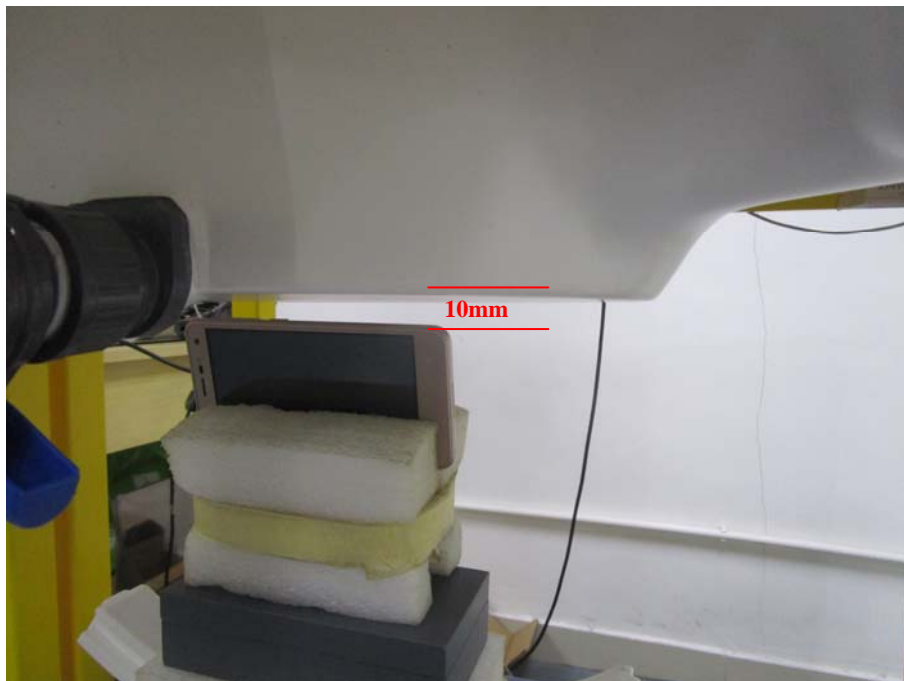

### Body Top



### Body Bottom



## Annex E. Calibration Certificate

---

*Please refer to the exhibit for the calibration certificate*

**\*\*\*\*\* END OF REPORT \*\*\*\*\***