SAR Test Report

Report No.: AGC10211210605FH01

FCC ID : 2ALJJP40

APPLICATION PURPOSE : Original Equipment

PRODUCT DESIGNATION : Mobile phone

BRAND NAME : PCD

MODEL NAME : P40

APPLICANT : PCD, LLC

DATE OF ISSUE : Jul. 19, 2021

STANDARD(S) : IEEE Std. 1528:2013
FCC 47 CFR Part 2§2.1093:2013
IEEE Std C95.1™-2005
IEC 62209-1: 2016

REPORT VERSION : V1.0

Attestation of Global Compliance (Shenzhen) Co., Ltd.



Any report having not been signed by authorized approver, or having been altered without authorization, or having not been stamped by the "Dedicated Testing/Inspection Stamp" is deemed to be invalid. Copying or excerpting portion of, or altering the content of the report is not permitted without the written authorization of AGC. The test results presented in the report apply only to the tested sample. Any objections to report issued by AGC should be submitted to AGC within 15 days after the issuance of the test report. Further enquiry of validity or verification of the test report should be addressed to AGC by agc@agc-cert.com.

Attestation of Global Compliance(Shenzhen)Co., Ltd
Attestation of Global Compliance(Shenzhen)Std & Tech Co., Ltd
Tel: +86-755 2523 4088 E-mail: agc@agc-cert.com Web: <http://cn.agc-cert.com/>



Report Revise Record

Report Version	Revise Time	Issued Date	Valid Version	Notes
V1.0	/	Jul. 19, 2021	Valid	Initial Release

Any report having not been signed by authorized approver, or having been altered without authorization, or having not been stamped by the "Dedicated Testing/Inspection Stamp" is deemed to be invalid. Copying or excerpting portion of, or altering the content of the report is not permitted without the written authorization of AGC. The test results presented in the report apply only to the tested sample. Any objections to report issued by AGC should be submitted to AGC within 15days after the issuance of the test report. Further enquiry of validity or verification of the test report should be addressed to AGC by agc@agc-cert.com.

Attestation of Global Compliance(Shenzhen)Co., Ltd
Attestation of Global Compliance(Shenzhen)Std & Tech Co., Ltd
Tel: +86-755 2523 4088 E-mail: agc@agc-cert.com Web: <http://cn.agc-cert.com/>



Test Report

Applicant Name	PCD, LLC
Applicant Address	1500 Tradeport Drive, Suite A, Orlando, Florida, United States
Manufacturer Name	SHENZHEN HUAYUE WORLDCOM SOFTWARE TECHNOLOGY CO.,LTD
Manufacturer Address	Room 703-704, Building B, Phase 1, Wanke Yuncheng Innovation Valley, Xili Street, Nanshan District, Shenzhen
Factory Name	SHENZHEN HUAYUE WORLDCOM SOFTWARE TECHNOLOGY CO.,LTD
Factory Address	Room 703-704, Building B, Phase 1, Wanke Yuncheng Innovation Valley, Xili Street, Nanshan District, Shenzhen
Product Designation	Mobile phone
Brand Name	PCD
Model Name	P40
EUT Voltage	DC3.7V by battery
Applicable Standard	IEEE Std. 1528:2013 FCC 47 CFR Part 2§2.1093:2013 IEEE Std C95.1™-2005 IEC 62209-1: 2016
Test Date	Jul. 01, 2021 to Jul. 05, 2021
Report Template	AGCRT-US-4G/SAR (2021-04-20)

Note: The results of testing in this report apply to the product/system which was tested only.

Jack Gui

Prepared By

Jack Gui (Project Engineer)

Jul. 05, 2021

Angela Li

Reviewed By

Angela Li (Reviewer)

Jul. 19, 2021

Forrest Lei

Approved By

Forrest Lei (Authorized Officer)

Jul. 19, 2021

Any report having not been signed by authorized approver, or having been altered without authorization, or having not been stamped by the "Dedicated Testing/Inspection Stamp" is deemed to be invalid. Copying or excerpting portion of, or altering the content of the report is not permitted without the written authorization of AGC. The test results presented in the report apply only to the tested sample. Any objections to report issued by AGC should be submitted to AGC within 15 days after the issuance of the test report. Further enquiry of validity or verification of the test report should be addressed to AGC by agc@agc-cert.com.



TABLE OF CONTENTS

1. SUMMARY OF MAXIMUM SAR VALUE	5
2. GENERAL INFORMATION.....	6
2.1. EUT DESCRIPTION.....	6
3. SAR MEASUREMENT SYSTEM.....	8
3.1. THE SATIMO SYSTEM USED FOR PERFORMING COMPLIANCE TESTS CONSISTS OF FOLLOWING ITEMS	8
3.2. COMOSAR E-FIELD PROBE	9
3.3. ROBOT.....	9
3.4. VIDEO POSITIONING SYSTEM	10
3.5. DEVICE HOLDER	10
3.6. SAM TWIN PHANTOM.....	11
4. SAR MEASUREMENT PROCEDURE.....	12
4.1. SPECIFIC ABSORPTION RATE (SAR).....	12
4.2. SAR MEASUREMENT PROCEDURE	13
4.3. RF EXPOSURE CONDITIONS	15
5. TISSUE SIMULATING LIQUID.....	17
5.1. THE COMPOSITION OF THE TISSUE SIMULATING LIQUID.....	17
5.2. TISSUE DIELECTRIC PARAMETERS FOR HEAD AND BODY PHANTOMS	18
5.3. TISSUE CALIBRATION RESULT	19
6. SAR SYSTEM CHECK PROCEDURE	20
6.1. SAR SYSTEM CHECK PROCEDURES	20
6.2. SAR SYSTEM CHECK.....	21
7. EUT TEST POSITION.....	23
7.1. DEFINE TWO IMAGINARY LINES ON THE HANDSET.....	23
7.2. CHEEK POSITION	24
7.3. TILT POSITION.....	24
7.4. BODY WORN POSITION	25
8. SAR EXPOSURE LIMITS	26
9. TEST FACILITY	27
10. TEST EQUIPMENT LIST	28
11. MEASUREMENT UNCERTAINTY	29
12. CONDUCTED POWER MEASUREMENT.....	32
13. TEST RESULTS	51
13.1. SAR TEST RESULTS SUMMARY.....	51
APPENDIX A. SAR SYSTEM CHECK DATA	70
APPENDIX B. SAR MEASUREMENT DATA.....	80
APPENDIX C. TEST SETUP PHOTOGRAPHS.....	130
APPENDIX D. CALIBRATION DATA	137

Any report having not been signed by authorized approver, or having been altered without authorization, or having not been stamped by the "Dedicated Testing/Inspection Stamp" is deemed to be invalid. Copying or excerpting portion of, or altering the content of the report is not permitted without the written authorization of AGC. The test results presented in the report apply only to the tested sample. Any objections to report issued by AGC should be submitted to AGC within 15 days after the issuance of the test report. Further enquiry of validity or verification of the test report should be addressed to AGC by agc@agc-cert.com.



1. SUMMARY OF MAXIMUM SAR VALUE

The maximum results of Specific Absorption Rate (SAR) found during testing for EUT are as follows:

Frequency Band	Highest Reported 1g-SAR(W/kg)			SAR Test Limit (W/kg)
	Head	Body-worn	Hotspot	
GSM 850	0.710	0.930	0.930	1.6
PCS 1900	0.048	0.109	0.109	
UMTS Band II	0.088	0.133	0.133	
UMTS Band V	0.644	0.828	0.828	
LTE Band 2-1RB	0.079	0.116	0.116	
LTE Band 2-50%RB	0.064	0.097	0.097	
LTE Band 4-1RB	0.098	0.126	0.126	
LTE Band 4-50%RB	0.077	0.081	0.081	
LTE Band 66-1RB	0.026	0.080	0.080	
LTE Band 66-50%RB	0.029	0.051	0.051	
WIFI 2.4G	0.464	0.105	0.105	
Simultaneous Reported SAR	1.174			
SAR Test Result	PASS			

This device is compliance with Specific Absorption Rate (SAR) for general population/uncontrolled exposure limits (1.6W/kg) specified in IEEE Std. 1528:2013; FCC 47CFR § 2.1093; IEEE/ANSI C95.1:2005 and the following specific FCC Test Procedures:

- KDB 447498 D01 General RF Exposure Guidance v06
- KDB 648474 D04 Handset SAR v01r03
- KDB 865664 D01 SAR Measurement 100MHz to 6GHz v01r04
- KDB 941225 D01 3G SAR Procedures v03r01
- KDB 941225 D06 Hotspot Mode v02r01
- KDB 248227 D01 802 11 Wi-Fi SAR v02r02
- KDB 941225 D05 SAR for LTE Devices v02r05

Any report having not been signed by authorized approver, or having been altered without authorization, or having not been stamped by the "Dedicated Testing/Inspection Stamp" is deemed to be invalid. Copying or excerpting portion of, or altering the content of the report is not permitted without the written authorization of AGC. The test results presented in the report apply only to the tested sample. Any objections to report issued by AGC should be submitted to AGC within 15days after the issuance of the test report. Further enquiry of validity or verification of the test report should be addressed to AGC by agc@agc-cert.com.

Attestation of Global Compliance(Shenzhen)Co., Ltd
Attestation of Global Compliance(Shenzhen)Std & Tech Co., Ltd
Tel: +86-755 2523 4088 E-mail: agc@agc-cert.com Web: http://cn.agc-cert.com/



2. GENERAL INFORMATION

2.1. EUT Description

General Information	
Product Designation	Mobile phone
Test Model	P40
Sample ID	210629037
Hardware Version	TG92V1.1
Software Version	PCD_P40_CLARO_CENAM_V1.0_20210519
Device Category	Portable
RF Exposure Environment	Uncontrolled
Antenna Type	Internal
GSM and GPRS& EGPRS	
Support Band	<input checked="" type="checkbox"/> GSM 850 <input checked="" type="checkbox"/> PCS 1900 (U.S. Bands) <input type="checkbox"/> GSM 900 <input checked="" type="checkbox"/> DCS 1800 (Non-U.S. Bands)
GPRS & EGPRS Type	Class B
GPRS & EGPRS Class	Class 12(1Tx+4Rx, 2Tx+3Rx, 3Tx+2Rx, 4Tx+1Rx)
TX Frequency Range	GSM 850 : 820-850MHz; PCS 1900: 1850-1910MHz;
RX Frequency Range	GSM 850 : 869~894MHz; PCS 1900: 1930~1990MHz
Release Version	R99
Type of modulation	GMSK for GSM/GPRS; GMSK & 8-PSK for EGPRS
Antenna Gain	GSM850: -0.6dBi; PCS1900: 0.97dBi
Max. Average Power	GSM850: 32.00dBm; PCS1900: 30.11dBm
WCDMA	
Support Band	<input checked="" type="checkbox"/> UMTS FDD Band II <input checked="" type="checkbox"/> UMTS FDD Band V <input type="checkbox"/> UMTS FDD Band IV <input type="checkbox"/> UMTS FDD Band I <input type="checkbox"/> UMTS FDD Band III <input type="checkbox"/> UMTS FDD Band VIII
HS Type	HSPA(HSUPA/HSDPA)
TX Frequency Range	FDD Band II: 1850-1910MHz; FDD Band V: 824-849MHz
RX Frequency Range	FDD Band II: 1930-1990MHz; FDD Band V: 869-894MHz
Release Version	Rel-6
Type of modulation	HSDPA:QPSK/16QAM; HSUPA:BPSK; WCDMA:QPSK
Antenna Gain	Band II: 0.97dBi; Band V: -0.6dBi
Max. Average Power	Band II: 22.47dBm; Band V: 22.47dBm

Any report having not been signed by authorized approver, or having been altered without authorization, or having not been stamped by the "Dedicated Testing/Inspection Stamp" is deemed to be invalid. Copying or excerpting portion of, or altering the content of the report is not permitted without the written authorization of AGC. The test results presented in the report apply only to the tested sample. Any objections to report issued by AGC should be submitted to AGC within 15days after the issuance of the test report. Further enquiry of validity or verification of the test report should be addressed to AGC by agc@agc-cert.com.



EUT Description(Continue)

LTE	
Support Band	<input checked="" type="checkbox"/> FDD Band 2 <input checked="" type="checkbox"/> FDD Band 4 <input type="checkbox"/> FDD Band 5 <input type="checkbox"/> FDD Band 7 <input type="checkbox"/> FDD Band 12 <input type="checkbox"/> FDD Band 17 <input type="checkbox"/> FDD Band 25 <input type="checkbox"/> FDD Band 26 <input type="checkbox"/> TDD Band 41 <input checked="" type="checkbox"/> FDD Band 66 (U.S. Bands) <input type="checkbox"/> FDD Band 1 <input type="checkbox"/> FDD Band 3 <input type="checkbox"/> FDD Band 7 <input type="checkbox"/> FDD Band 8 <input type="checkbox"/> FDD Band 20 <input type="checkbox"/> FDD Band 28 <input type="checkbox"/> TDD Band 38 <input type="checkbox"/> TDD Band 40 <input type="checkbox"/> TDD Band 42 <input type="checkbox"/> TDD Band 43 (Non-U.S. Bands)
TX Frequency Range	Band 2:1850-1910MHz; Band 4:1710-1755MHz; Band 66:1700-1780MHz;
RX Frequency Range	Band 2:1930-1990MHz; Band 4:2110-2155MHz; Band 66:2110-2200MHz;
Release Version	Rel-8
Type of modulation	QPSK, 16QAM
Antenna Gain	Band 2: 0.97dBi; Band 4: 1.1dBi; Band 66: 1.1dBi;
Max. Average Power	Band 2: 22.92dBm; Band 4: 23.80dBm; Band 66: 23.85dBm;
Bluetooth	
Bluetooth Version	<input type="checkbox"/> V2.0 <input type="checkbox"/> V2.1 <input type="checkbox"/> V2.1+EDR <input type="checkbox"/> V3.0 <input type="checkbox"/> V3.0+HS <input type="checkbox"/> V4.0 <input checked="" type="checkbox"/> V4.2
Operation Frequency	2402~2480MHz
Type of modulation	<input checked="" type="checkbox"/> GFSK <input checked="" type="checkbox"/> π/4-DQPSK <input checked="" type="checkbox"/> 8-DPSK
Peak Power	2.04dBm
Antenna Gain	1.3dBi
WIFI	
WIFI Specification	<input type="checkbox"/> 802.11a <input checked="" type="checkbox"/> 802.11b <input checked="" type="checkbox"/> 802.11g <input checked="" type="checkbox"/> 802.11n(20) <input type="checkbox"/> 802.11n(40)
Operation Frequency	2412~2462MHz
Avg. Burst Power	11b: 10.71dBm, 11g: 4.68dBm, 11n(20): 3.72dBm
Antenna Gain	1.3dBi
Accessories	
Battery	Brand name: PCD Model No. : P40 Voltage and Capacitance: 3.7 V & 1400mAh
Earphone	Brand name: N/A Model No. : N/A

- Note:1.CMU200 can measure the average power and Peak power at the same time
 2.The sample used for testing is end product.
 3. The test sample has no any deviation to the test method of standard mentioned in page 1.

Product	Type
	<input checked="" type="checkbox"/> Production unit <input type="checkbox"/> Identical Prototype

Any report having not been signed by authorized approver, or having been altered without authorization, or having not been stamped by the "Dedicated Testing/Inspection Stamp" is deemed to be invalid. Copying or excerpting portion of, or altering the content of the report is not permitted without the written authorization of AGC. The test results presented in the report apply only to the tested sample. Any objections to report issued by AGC should be submitted to AGC within 15days after the issuance of the test report. Further enquiry of validity or verification of the test report should be addressed to AGC by agc@agc-cert.com.



3. SAR MEASUREMENT SYSTEM

3.1. The SATIMO system used for performing compliance tests consists of following items

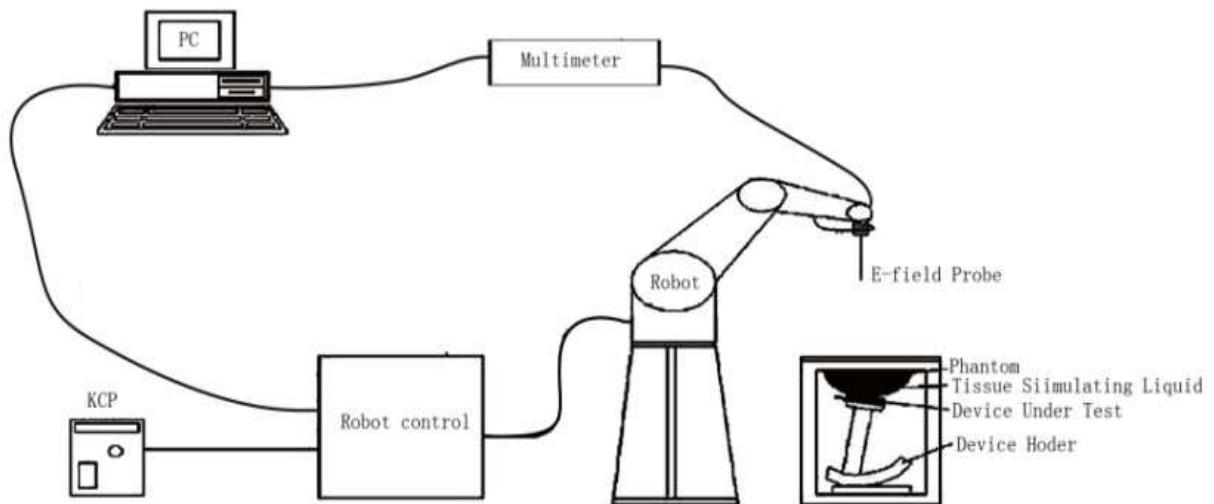

The COMOSAR system for performing compliance tests consists of the following items:

- The PC. It controls most of the bench devices and stores measurement data. A computer running WinXP and the Opensar software.
- The E-Field probe. The probe is a 3-axis system made of 3 distinct dipoles. Each dipole returns a voltage in function of the ambient electric field.
- The Keithley multimeter measures each probe dipole voltages.
- The SAM phantom simulates a human head. The measurement of the electric field is made inside the phantom.
- The liquids simulate the dielectric properties of the human head tissues.
- The network emulator controls the mobile phone under test.
- The validation dipoles are used to measure a reference SAR. They are used to periodically check the bench to make sure that there is no drift of the system characteristics over time.
- The phantom, the device holder and other accessories according to the targeted measurement.

Any report having not been signed by authorized approver, or having been altered without authorization, or having not been stamped by the "Dedicated Testing/Inspection Stamp" is deemed to be invalid. Copying or excerpting portion of, or altering the content of the report is not permitted without the written authorization of AGC. The test results presented in the report apply only to the tested sample. Any objections to report issued by AGC should be submitted to AGC within 15 days after the issuance of the test report. Further enquiry of validity or verification of the test report should be addressed to AGC by agc@agc-cert.com.

3.2. COMOSAR E-Field Probe

The SAR measurement is conducted with the dosimetric probe manufactured by SATIMO. The probe is specially designed and calibrated for use in liquid with high permittivity. The dosimetric probe has special calibration in liquid at different frequency. SATIMO conducts the probe calibration in compliance with international and national standards (e.g. IEEE 1528 and relevant KDB files.) The calibration data are in Appendix D.

Isotropic E-Field Probe Specification

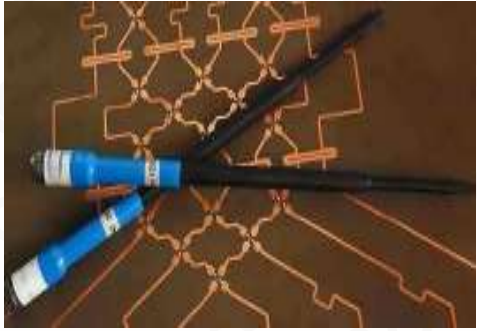
Model	SSE5	
Manufacture	MVG	
Identification No.	SN 03/18 EP327	
Frequency	0.15GHz-3GHz Linearity:±0.08dB(150MHz-3GHz)	
Dynamic Range	0.01W/kg-100W/kg Linearity:±0.08dB	
Dimensions	Overall length:330mm Length of individual dipoles:4.5mm Maximum external diameter:8mm Probe Tip external diameter:5mm Distance between dipoles/ probe extremity:2.7mm	
Application	High precision dosimetric measurements in any exposure scenario (e.g., very strong gradient fields). Only probe which enables compliance testing for frequencies up to 3 GHz with precision of better 30%.	

3.3. Robot

The COMOSAR system uses the KUKA robot from SATIMO SA (France).For the 6-axis controller COMOSAR system, the KUKA robot controller version from SATIMO is used.

The XL robot series have many features that are important for our application:

- High precision (repeatability 0.02 mm)
- High reliability (industrial design)
- Jerk-free straight movements
- Low ELF interference (the closed metallic construction shields against motor control fields)
- 6-axis controller



Any report having not been signed by authorized approver, or having been altered without authorization, or having not been stamped by the "Dedicated Testing/Inspection Stamp" is deemed to be invalid. Copying or excerpting portion of, or altering the content of the report is not permitted without the written authorization of AGC. The test results presented in the report apply only to the tested sample. Any objections to report issued by AGC should be submitted to AGC within 15days after the issuance of the test report. Further enquiry of validity or verification of the test report should be addressed to AGC by agc@agc-cert.com.



3.4. Video Positioning System

The video positioning system is used in OpenSAR to check the probe. Which is composed of a camera, LED, mirror and mechanical parts. The camera is piloted by the main computer with firewire link. During the process, the actual position of the probe tip with respect to the robot arm is measured, as well as the probe length and the horizontal probe offset. The software then corrects all movements, such that the robot coordinates are valid for the probe tip. The repeatability of this process is better than 0.1 mm. If a position has been taught with an aligned probe, the same position will be reached with another aligned probe within 0.1 mm, even if the other probe has different dimensions. During probe rotations, the probe tip will keep its actual position.

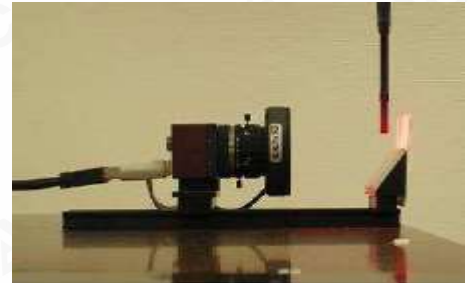

3.5. Device Holder

The COMOSAR device holder is designed to cope with different positions given in the standard. It has two scales for the device rotation (with respect to the body axis) and the device inclination (with respect to the line between the ear reference points). The rotation center for both scales is the ear reference point (EPR). Thus the device needs no repositioning when changing the angles. The COMOSAR device holder has been made out of low-loss POM material having the following dielectric parameters: relative permittivity $\epsilon_r = 3$ and loss tangent $\delta = 0.02$. The amount of dielectric material has been reduced in the closest vicinity of the device, since measurements have suggested that the influence of the clamp on the test results could thus be lowered.

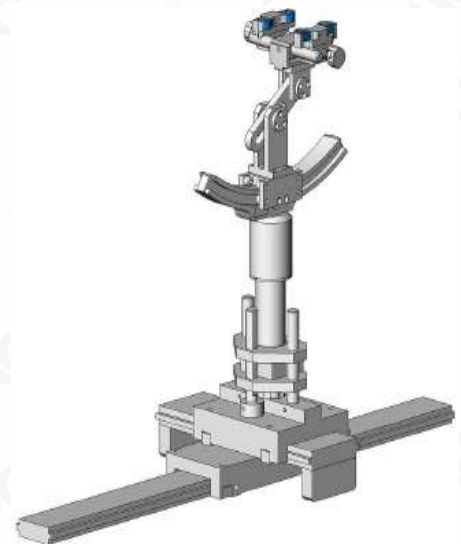

Any report having not been signed by authorized approver, or having been altered without authorization, or having not been stamped by the "Dedicated Testing/Inspection Stamp" is deemed to be invalid. Copying or excerpting portion of, or altering the content of the report is not permitted without the written authorization of AGC. The test results presented in the report apply only to the tested sample. Any objections to report issued by AGC should be submitted to AGC within 15 days after the issuance of the test report. Further enquiry of validity or verification of the test report should be addressed to AGC by agc@agc-cert.com.



3.6. SAM Twin Phantom

The SAM twin phantom is a fiberglass shell phantom with 2mm shell thickness (except the ear region where shell thickness increases to 6mm). It has three measurement areas:

- Left head
- Right head
- Flat phantom



The bottom plate contains three pair of bolts for locking the device holder. The device holder positions are adjusted to the standard measurement positions in the three sections. A white cover is provided to tap the phantom during off-periods to prevent water evaporation and changes in the liquid parameters. On the phantom top, three reference markers are provided to identify the phantom position with respect to the robot.

Any report having not been signed by authorized approver, or having been altered without authorization, or having not been stamped by the "Dedicated Testing/Inspection Stamp" is deemed to be invalid. Copying or excerpting portion of, or altering the content of the report is not permitted without the written authorization of AGC. The test results presented in the report apply only to the tested sample. Any objections to report issued by AGC should be submitted to AGC within 15days after the issuance of the test report. Further enquiry of validity or verification of the test report should be addressed to AGC by agc@agc-cert.com.

Attestation of Global Compliance(Shenzhen)Co., Ltd
Attestation of Global Compliance(Shenzhen)Std & Tech Co., Ltd
Tel: +86-755 2523 4088 E-mail: agc@agc-cert.com Web: http://cn.agc-cert.com/



4. SAR MEASUREMENT PROCEDURE

4.1. Specific Absorption Rate (SAR)

SAR is related to the rate at which energy is absorbed per unit mass in object exposed to a radio field. The SAR distribution in a biological body is complicated and is usually carried out by experimental techniques or numerical modeling. The standard recommends limits for two tiers of groups, occupational/controlled and occupational/uncontrolled, based on a person's awareness and ability to exercise control over his or her exposure. In general, occupational/controlled exposure limits are higher than the limits for general population/uncontrolled.

The SAR definition is the time derivative (rate) of the incremental energy (dW) absorbed by (dissipated in) an incremental mass (dm) contained in a volume element(dv) of given mass density (ρ). The equation description is as below:

$$SAR = \frac{d}{dt} \left(\frac{dW}{dm} \right) = \frac{d}{dt} \left(\frac{dW}{\rho dV} \right)$$

SAR is expressed in units of Watts per kilogram (W/kg)

SAR can be obtained using either of the following equations:

$$SAR = \frac{\sigma E^2}{\rho}$$

$$SAR = c_h \left. \frac{dT}{dt} \right|_{t=0}$$

Where

SAR	is the specific absorption rate in watts per kilogram;
E	is the r.m.s. value of the electric field strength in the tissue in volts per meter;
σ	is the conductivity of the tissue in siemens per metre;
ρ	is the density of the tissue in kilograms per cubic metre;
c _h	is the heat capacity of the tissue in joules per kilogram and Kelvin;
$\left. \frac{dT}{dt} \right _{t=0}$	is the initial time derivative of temperature in the tissue in kelvins per second

Any report having not been signed by authorized approver, or having been altered without authorization, or having not been stamped by the "Dedicated Testing/Inspection Stamp" is deemed to be invalid. Copying or excerpting portion of, or altering the content of the report is not permitted without the written authorization of AGC. The test results presented in the report apply only to the tested sample. Any objections to report issued by AGC should be submitted to AGC within 15days after the issuance of the test report. Further enquiry of validity or verification of the test report should be addressed to AGC by agc@agc-cert.com.



4.2. SAR Measurement Procedure

Step 1: Power Reference Measurement

The Power Reference Measurement and Power Drift Measurement are for monitoring the power drift of the device under test in the batch process. The minimum distance of probe sensors to surface is 2.7mm This distance cannot be smaller than the distance os sensor calibration points to probe tip as `defined in the probe properties,

Step 2: Area Scan

The Area Scan is used as a fast scan in two dimensions to find the area of high field values, before doing a fine measurement around the hot spot. The sophisticated interpolation routines implemented in SATIMO software can find the maximum locations even in relatively coarse grids. When an Area Scan has measured all reachable points, it computes the field maximal found in the scanned area, within a range of the global maximum. The range (in db) is specified in the standards for compliance testing. For example, a 2db range is required in IEEE Standard 1528 and IEC62209 standards, whereby 3db is a requirement when compliance is assessed in accordance with the ARIB standard (Japan) If one Zoom Scan follows the Area Scan, then only the absolute maximum will be taken as reference. For cases where multiple maximum are detected, the number of Zoom Scan has to be increased accordingly.

Area Scan Parameters extracted from KDB 865664 D01 SAR Measurement 100MHz to 6GHz

	≤ 3 GHz	> 3 GHz
Maximum distance from closest measurement point (geometric center of probe sensors) to phantom surface	5 ± 1 mm	$\frac{1}{2} \cdot \delta \cdot \ln(2) \pm 0.5$ mm
Maximum probe angle from probe axis to phantom surface normal at the measurement location	30° ± 1°	20° ± 1°
Maximum area scan spatial resolution: Δx_{Area} , Δy_{Area}	≤ 2 GHz: ≤ 15 mm 2 – 3 GHz: ≤ 12 mm	3 – 4 GHz: ≤ 12 mm 4 – 6 GHz: ≤ 10 mm
	When the x or y dimension of the test device, in the measurement plane orientation, is smaller than the above, the measurement resolution must be ≤ the corresponding x or y dimension of the test device with at least one measurement point on the test device.	

Step 3: Zoom Scan

Zoom Scan are used to assess the peak spatial SAR value within a cubic average volume containing 1g abd 10g of simulated tissue. The Zoom Scan measures points(refer to table below) within a cube whose base faces are centered on the maxima found in a preceding area scan job within the same procedure. When the measurement is done, the Zoom Scan evaluates the averaged SAR for 1g and 10g and displays these values next to the job's label.

Any report having not been signed by authorized approver, or having been altered without authorization, or having not been stamped by the "Dedicated Testing/Inspection Stamp" is deemed to be invalid. Copying or excerpting portion of, or altering the content of the report is not permitted without the written authorization of AGC. The test results presented in the report apply only to the tested sample. Any objections to report issued by AGC should be submitted to AGC within 15days after the issuance of the test report. Further enquiry of validity or verification of the test report should be addressed to AGC by agc@agc-cert.com.



Zoom Scan Parameters extracted from KDB865664 d01 SAR Measurement 100MHz to 6GHz

Maximum zoom scan spatial resolution: Δx_{Zoom} , Δy_{Zoom}		≤ 2 GHz: ≤ 8 mm 2 – 3 GHz: ≤ 5 mm*	3 – 4 GHz: ≤ 5 mm* 4 – 6 GHz: ≤ 4 mm*
Maximum zoom scan spatial resolution, normal to phantom surface	uniform grid: $\Delta z_{Zoom}(n)$	≤ 5 mm	3 – 4 GHz: ≤ 4 mm 4 – 5 GHz: ≤ 3 mm 5 – 6 GHz: ≤ 2 mm
	graded grid	$\Delta z_{Zoom}(1)$: between 1 st two points closest to phantom surface	≤ 4 mm
		$\Delta z_{Zoom}(n>1)$: between subsequent points	$\leq 1.5 \cdot \Delta z_{Zoom}(n-1)$
Minimum zoom scan volume	x, y, z	≥ 30 mm	3 – 4 GHz: ≥ 28 mm 4 – 5 GHz: ≥ 25 mm 5 – 6 GHz: ≥ 22 mm
<p>Note: δ is the penetration depth of a plane-wave at normal incidence to the tissue medium; see draft standard IEEE P1528-2011 for details.</p> <p>* When zoom scan is required and the <i>reported</i> SAR from the <i>area scan based 1-g SAR estimation</i> procedures of KDB 447498 is ≤ 1.4 W/kg, ≤ 8 mm, ≤ 7 mm and ≤ 5 mm zoom scan resolution may be applied, respectively, for 2 GHz to 3 GHz, 3 GHz to 4 GHz and 4 GHz to 6 GHz.</p>			

Step 4: Power Drift Measurement

The Power Drift Measurement measures the field at the same location as the most recent power reference measurement within the same procedure, and with the same settings. The Power Drift Measurement gives the field difference in dB from the reading conducted within the same settings. This allows a user to monitor the power drift of the device under test within a batch process. The measurement procedure is the same as Step 1.

Any report having not been signed by authorized approver, or having been altered without authorization, or having not been stamped by the "Dedicated Testing/Inspection Stamp" is deemed to be invalid. Copying or excerpting portion of, or altering the content of the report is not permitted without the written authorization of AGC. The test results presented in the report apply only to the tested sample. Any objections to report issued by AGC should be submitted to AGC within 15 days after the issuance of the test report. Further enquiry of validity or verification of the test report should be addressed to AGC by agc@agc-cert.com.



4.3. RF Exposure Conditions

Test Configuration and setting:

The EUT is a model of GSM Portable Mobile Station (MS). It supports GSM/GPRS/EGPRS, WCDMA/HSPA, LTE, BT, WIFI, and support hot spot mode.

For WWAN SAR testing, the device was controlled by using a base station emulator. Communication between the device and the emulator were established by air link. The distance between the EUT and the antenna is larger than 50cm, and the output power radiated from the emulator antenna is at least 30db smaller than the output power of EUT.

For WLAN testing, the EUT is configured with the WLAN continuous TX tool through engineering command.

Antenna Location: (the back view)

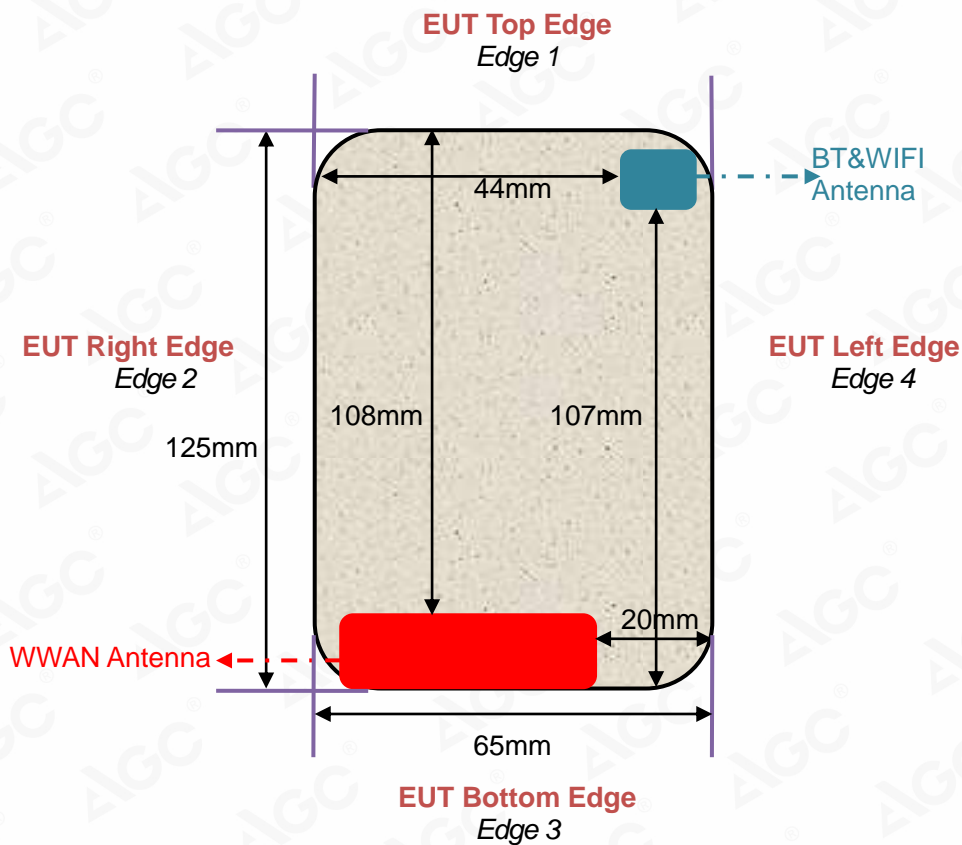

Any report having not been signed by authorized approver, or having been altered without authorization, or having not been stamped by the "Dedicated Testing/Inspection Stamp" is deemed to be invalid. Copying or excerpting portion of, or altering the content of the report is not permitted without the written authorization of AGC. The test results presented in the report apply only to the tested sample. Any objections to report issued by AGC should be submitted to AGC within 15 days after the issuance of the test report. Further enquiry of validity or verification of the test report should be addressed to AGC by agc@agc-cert.com.



For WWAN mode:

Test Configurations	Antenna to edges/surface	SAR required	Note
Head			
Left Touch		Yes	--
Left Tilt		Yes	--
Right Touch		Yes	--
Right Tilt		Yes	--
Body			
Back	<25mm	Yes	--
Front	<25mm	Yes	--
Hotspot			
Back	<25mm	Yes	--
Front	<25mm	Yes	--
Edge 1 (Top)	108mm	No	SAR is not required for the distance between the antenna and the edge is >25mm as per KDB 941225 D06 Hotspot SAR
Edge 2 (Right)	1mm	Yes	--
Edge 3 (Bottom)	1mm	Yes	--
Edge 4 (Left)	20mm	Yes	--

For WLAN mode:

Test Configurations	Antenna to edges/surface	SAR required	Note
Head			
Left Touch		Yes	--
Left Tilt		Yes	--
Right Touch		Yes	--
Right Tilt		Yes	--
Body			
Back	<25mm	Yes	--
Front	<25mm	Yes	--
Hotspot			
Back	<25mm	Yes	--
Front	<25mm	Yes	--
Edge 1 (Top)	1mm	Yes	--
Edge 2 (Right)	44mm	No	SAR is not required for the distance between the antenna and the edge is >25mm as per KDB 941225 D06 Hotspot SAR
Edge 3 (Bottom)	107mm	No	SAR is not required for the distance between the antenna and the edge is >25mm as per KDB 941225 D06 Hotspot SAR
Edge 4 (Left)	1mm	Yes	--

Any report having not been signed by authorized approver, or having been altered without authorization, or having not been stamped by the "Dedicated Testing/Inspection Stamp" is deemed to be invalid. Copying or excerpting portion of, or altering the content of the report is not permitted without the written authorization of AGC. The test results presented in the report apply only to the tested sample. Any objections to report issued by AGC should be submitted to AGC within 15 days after the issuance of the test report. Further enquiry of validity or verification of the test report should be addressed to AGC by agc@agc-cert.com.



5. TISSUE SIMULATING LIQUID

For SAR measurement of the field distribution inside the phantom, the phantom must be filled with homogeneous tissue simulating liquid to a depth of at least 15cm. For head SAR testing the liquid height from the ear reference point (ERP) of the phantom to the liquid top surface is larger than 15cm For body SAR testing, the liquid height from the center of the flat phantom to the liquid top surface is larger than 15cm. The nominal dielectric values of the tissue simulating liquids in the phantom and the tolerance of 10% are listed in 6.2

5.1. The composition of the tissue simulating liquid

Ingredient (% Weight) Frequency (MHz)	Water	Nacl	Polysorbate 20	DGBE	1,2 Propanediol	Triton X-100
835 Head	50.36	1.25	48.39	0.0	0.0	0.0
1750 Head	52.64	0.36	0.0	47	0.0	0.0
1900 Head	54.9	0.18	0.0	44.92	0.0	0.0
2450 Head	71.88	0.16	0.0	7.99	0.0	19.97

Any report having not been signed by authorized approver, or having been altered without authorization, or having not been stamped by the "Dedicated Testing/Inspection Stamp" is deemed to be invalid. Copying or excerpting portion of, or altering the content of the report is not permitted without the written authorization of AGC. The test results presented in the report apply only to the tested sample. Any objections to report issued by AGC should be submitted to AGC within 15 days after the issuance of the test report. Further enquiry of validity or verification of the test report should be addressed to AGC by agc@agc-cert.com.

Attestation of Global Compliance(Shenzhen)Co., Ltd
Attestation of Global Compliance(Shenzhen)Std & Tech Co., Ltd
Tel: +86-755 2523 4088 E-mail: agc@agc-cert.com Web: http://cn.agc-cert.com/



5.2. Tissue Dielectric Parameters for Head and Body Phantoms

The head tissue dielectric parameters recommended by the IEC 62209-1 have been incorporated in the following table. The body tissue dielectric parameters recommended by the IEC 62209-2 have been incorporated in the following table.

Target Frequency (MHz)	head		body	
	ϵ_r	σ (S/m)	ϵ_r	σ (S/m)
300	45.3	0.87	45.3	0.87
450	43.5	0.87	43.5	0.87
750	41.9	0.89	41.9	0.89
835	41.5	0.90	41.5	0.90
900	41.5	0.97	41.5	0.97
915	41.5	1.01	41.5	1.01
1450	40.5	1.20	40.5	1.20
1610	40.3	1.29	40.3	1.29
1750	40.1	1.37	40.1	1.37
1800 – 2000	40.0	1.40	40.0	1.40
2450	39.2	1.80	39.2	1.80
2600	39.0	1.96	39.0	1.96
3000	38.5	2.40	38.5	2.40

(ϵ_r = relative permittivity, σ = conductivity and $\rho = 1000$ kg/m³)

Any report having not been signed by authorized approver, or having been altered without authorization, or having not been stamped by the "Dedicated Testing/Inspection Stamp" is deemed to be invalid. Copying or excerpting portion of, or altering the content of the report is not permitted without the written authorization of AGC. The test results presented in the report apply only to the tested sample. Any objections to report issued by AGC should be submitted to AGC within 15 days after the issuance of the test report. Further enquiry of validity or verification of the test report should be addressed to AGC by agc@agc-cert.com.



5.3. Tissue Calibration Result

The dielectric parameters of the liquids were verified prior to the SAR evaluation using SATIMO Dielectric Probe Kit and R&S Network Analyzer ZVL6.

Tissue Stimulant Measurement for 835MHz					
	Fr. (MHz)	Dielectric Parameters ($\pm 10\%$)		Tissue Temp [°C]	Test time
		ϵ_r 41.5 (37.35-45.65)	δ [s/m] 0.90(0.81-0.99)		
Head	824.2	42.52	0.88	21.3	Jul. 01,2021
	835	41.64	0.92		
	836.4	40.41	0.93		
	836.6	40.41	0.93		
	848.8	38.57	0.96		

Tissue Stimulant Measurement for 1750MHz					
	Fr. (MHz)	Dielectric Parameters ($\pm 10\%$)		Tissue Temp [°C]	Test time
		ϵ_r 40.1 (36.09-44.11)	δ [s/m]1.37(1.233-1.507)		
Head	1732.5	41.35	1.28	21.2	Jul. 05,2021
	1750	39.82	1.38		
	1755	38.69	1.40		

Tissue Stimulant Measurement for 1900MHz					
	Fr. (MHz)	Dielectric Parameters ($\pm 10\%$)		Tissue Temp [°C]	Test time
		ϵ_r 40.00(36.00-44.00)	δ [s/m]1.40(1.26-1.54)		
Head	1880	39.28	1.35	20.7	Jul. 02,2021
	1900	38.51	1.37		

Tissue Stimulant Measurement for 1900MHz					
	Fr. (MHz)	Dielectric Parameters ($\pm 10\%$)		Tissue Temp [°C]	Test time
		ϵ_r 40.00(36.00-44.00)	δ [s/m]1.40(1.26-1.54)		
Head	1880	41.53	1.37	20.3	Jul. 04,2021
	1900	40.13	1.41		

Tissue Stimulant Measurement for 2450MHz					
	Fr. (MHz)	Dielectric Parameters ($\pm 10\%$)		Tissue Temp [°C]	Test time
		ϵ_r 39.2(35.28-43.12)	δ [s/m]1.80(1.62-1.98)		
Head	2437	40.63	1.71	20.5	Jul. 03,2021
	2450	39.96	1.76		

Any report having not been signed by authorized approver, or having been altered without authorization, or having not been stamped by the "Dedicated Testing/Inspection Stamp" is deemed to be invalid. Copying or excerpting portion of, or altering the content of the report is not permitted without the written authorization of AGC. The test results presented in the report apply only to the tested sample. Any objections to report issued by AGC should be submitted to AGC within 15 days after the issuance of the test report. Further enquiry of validity or verification of the test report should be addressed to AGC by agc@agc-cert.com.



6. SAR SYSTEM CHECK PROCEDURE

6.1. SAR System Check Procedures

SAR system check is required to confirm measurement accuracy, according to the tissue dielectric media, probe calibration points and other system operating parameters required for measuring the SAR of a test device. The system verification must be performed for each frequency band and within the valid range of each probe calibration point required for testing the device. The same SAR probe(s) and tissue-equivalent media combinations used with each specific SAR system for system verification must be used for device testing. When multiple probe calibration points are required to cover substantially large transmission bands, independent system verifications are required for each probe calibration point. A system verification must be performed before each series of SAR measurements using the same probe calibration point and tissue-equivalent medium. Additional system verification should be considered according to the conditions of the tissue-equivalent medium and measured tissue dielectric parameters, typically every three to four days when the liquid parameters are remeasured or sooner when marginal liquid parameters are used at the beginning of a series of measurements.

Each SATIMO system is equipped with one or more system check kits. These units, together with the predefined measurement procedures within the SATIMO software, enable the user to conduct the system check and system validation. System kit includes a dipole, and dipole device holder.

The system check verifies that the system operates within its specifications. It's performed daily or before every SAR measurement. The system check uses normal SAR measurement in the flat section of the phantom with a matched dipole at a specified distance. The system check setup is shown as below.

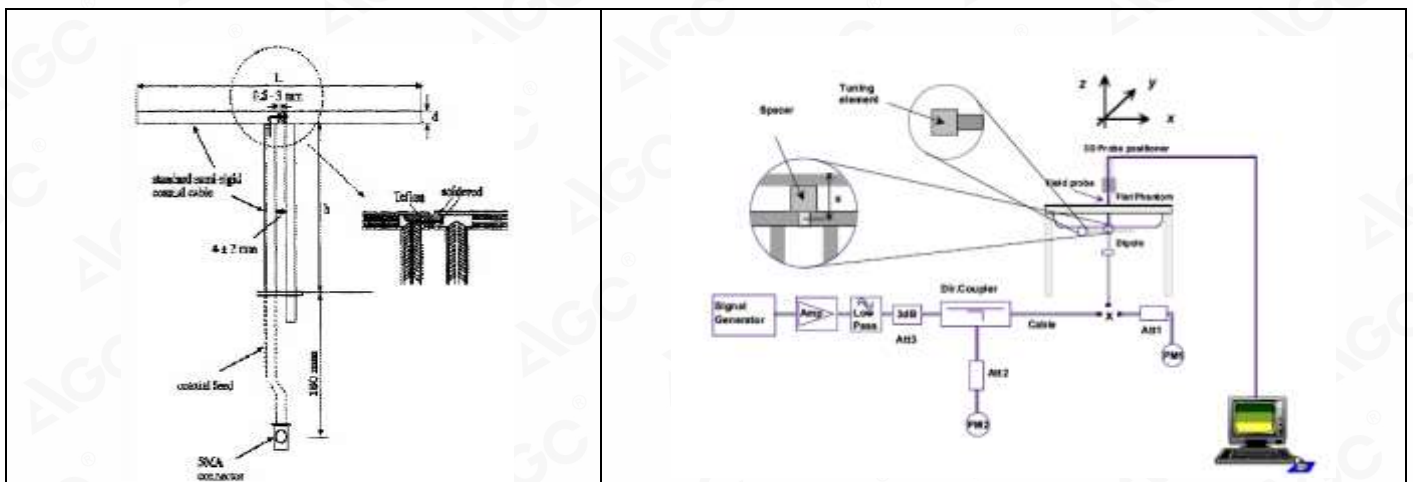

Any report having not been signed by authorized approver, or having been altered without authorization, or having not been stamped by the "Dedicated Testing/Inspection Stamp" is deemed to be invalid. Copying or excerpting portion of, or altering the content of the report is not permitted without the written authorization of AGC. The test results presented in the report apply only to the tested sample. Any objections to report issued by AGC should be submitted to AGC within 15 days after the issuance of the test report. Further enquiry of validity or verification of the test report should be addressed to AGC by agc@agc-cert.com.

Attestation of Global Compliance(Shenzhen)Co., Ltd
Attestation of Global Compliance(Shenzhen)Std & Tech Co., Ltd
Tel: +86-755 2523 4088 E-mail: agc@agc-cert.com Web: http://cn.agc-cert.com/



6.2. SAR System Check

6.2.1. Dipoles

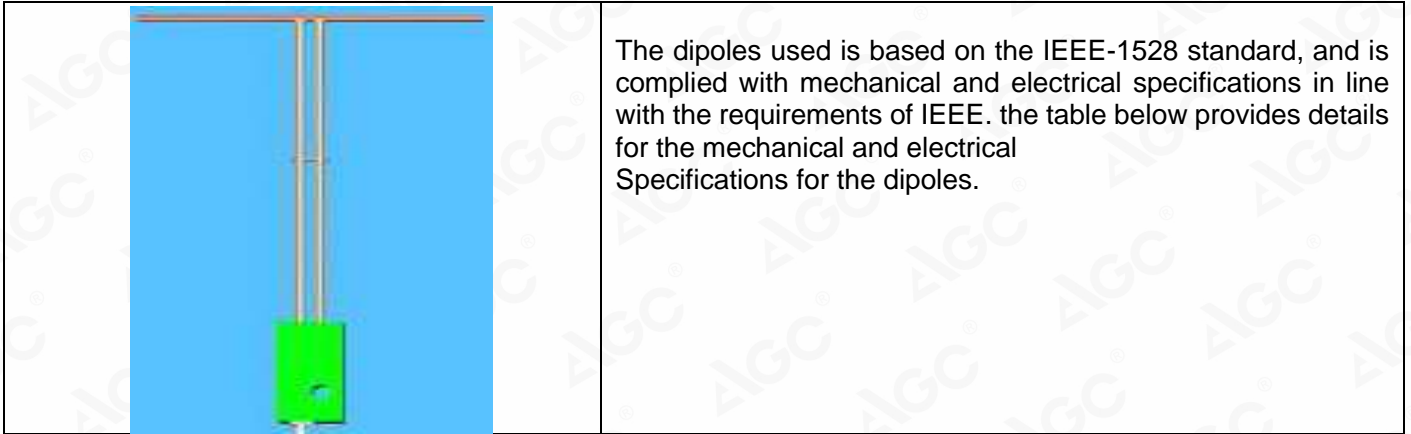

Frequency	L (mm)	h (mm)	d (mm)
835MHz	161.0	89.8	3.6
1800MHz	71.6	41.7	3.6
1900MHz	68	39.5	3.6
2450MHz	51.5	30.4	3.6

Any report having not been signed by authorized approver, or having been altered without authorization, or having not been stamped by the "Dedicated Testing/Inspection Stamp" is deemed to be invalid. Copying or excerpting portion of, or altering the content of the report is not permitted without the written authorization of AGC. The test results presented in the report apply only to the tested sample. Any objections to report issued by AGC should be submitted to AGC within 15days after the issuance of the test report. Further enquiry of validity or verification of the test report should be addressed to AGC by agc@agc-cert.com.

Attestation of Global Compliance(Shenzhen)Co., Ltd
Attestation of Global Compliance(Shenzhen)Std & Tech Co., Ltd
Tel: +86-755 2523 4088 E-mail: agc@agc-cert.com Web: http://cn.agc-cert.com/



6.2.2. System Check Result

System Performance Check at 835MHz &1800MHz &1900MHz &2450MHz for Head								
Validation Kit: SN29/15 DIP 0G835-383& SN46/11 DIP 1G800-186& SN 46/11 DIP 1G900-187& SN46/11 DIP 2G450-189								
Frequency [MHz]	Target Value(W/kg)		Reference Result ($\pm 10\%$)		Tested Value(W/kg)		Tissue Temp. [°C]	Test time
	1g	10g	1g	10g	1g	10g		
835	9.85	6.27	8.865-10.835	5.643-6.897	9.65	6.24	21.3	Jul. 01,2021
1800	39.07	20.29	35.163-42.977	18.261-22.319	40.95	20.95	21.2	Jul. 05,2021
1900	40.25	20.50	36.225-44.275	18.45-22.55	38.40	19.37	20.7	Jul. 02,2021
1900	40.25	20.50	36.225-44.275	18.45-22.55	39.60	19.93	20.3	Jul. 04,2021
2450	53.97	24.01	48.573-59.367	21.609-26.411	52.87	23.66	20.5	Jul. 03,2021

Note:

(1) We use a CW signal of 18dBm for system check, and then all SAR value are normalized to 1W forward power. The result must be within $\pm 10\%$ of target value.

Any report having not been signed by authorized approver, or having been altered without authorization, or having not been stamped by the "Dedicated Testing/Inspection Stamp" is deemed to be invalid. Copying or excerpting portion of, or altering the content of the report is not permitted without the written authorization of AGC. The test results presented in the report apply only to the tested sample. Any objections to report issued by AGC should be submitted to AGC within 15days after the issuance of the test report. Further enquiry of validity or verification of the test report should be addressed to AGC by agc@agc-cert.com.

Attestation of Global Compliance(Shenzhen)Co., Ltd
Attestation of Global Compliance(Shenzhen)Std & Tech Co., Ltd
Tel: +86-755 2523 4088 E-mail: agc@agc-cert.com Web: http://cn.agc-cert.com/



7. EUT TEST POSITION

This EUT was tested in **Right Cheek, Right Tilted, Left Cheek, Left Tilted, Body back, Body front and 4 edges.**

7.1. Define Two Imaginary Lines on the Handset

- (1) The vertical centerline passes through two points on the front side of the handset: the midpoint of the width w_t of the handset at the level of the acoustic output, and the midpoint of the width w_b of the handset.
- (2) The horizontal line is perpendicular to the vertical centerline and passes through the center of the acoustic output. The horizontal line is also tangential to the face of the handset at point A.
- (3) The two lines intersect at point A. Note that for many handsets, point A coincides with the center of the acoustic output; however, the acoustic output may be located elsewhere on the horizontal line. Also note that the vertical centerline is not necessarily to the front face of the handset, especially for clamshell handsets, handsets with flip covers, and other irregularly shaped handsets.

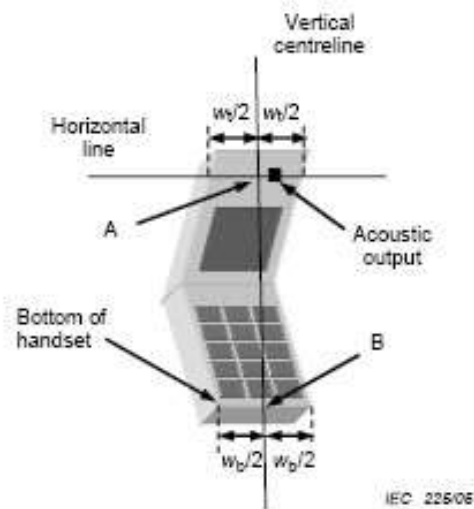
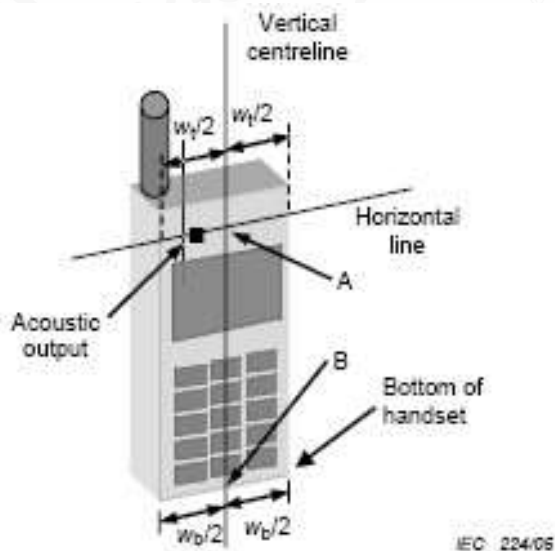

Any report having not been signed by authorized approver, or having been altered without authorization, or having not been stamped by the "Dedicated Testing/Inspection Stamp" is deemed to be invalid. Copying or excerpting portion of, or altering the content of the report is not permitted without the written authorization of AGC. The test results presented in the report apply only to the tested sample. Any objections to report issued by AGC should be submitted to AGC within 15 days after the issuance of the test report. Further enquiry of validity or verification of the test report should be addressed to AGC by agc@agc-cert.com.

7.2. Cheek Position

- (1) To position the device with the vertical center line of the body of the device and the horizontal line crossing the center piece in a plane parallel to the sagittal plane of the phantom. While maintaining the device in this plane, align the vertical center line with the reference plane containing the ear and mouth reference point (M: Mouth, RE: Right Ear, and LE: Left Ear) and align the center of the ear piece with the line RE-LE.
- (2) To move the device towards the phantom with the ear piece aligned with the the line LE-RE until the phone touched the ear. While maintaining the device in the reference plane and maintaining the phone contact with ear, move the bottom of the phone until any point on the front side is in contact with the cheek of the phantom or until contact with the ear is lost



7.3. Tilt Position

- (1) To position the device in the “cheek” position described above.
- (2) While maintaining the device in the reference plane described above and pivoting against the ear, moves it outward away from the mouth by an angle of 15 degrees or until with the ear is lost.



Any report having not been signed by authorized approver, or having been altered without authorization, or having not been stamped by the “Dedicated Testing/Inspection Stamp” is deemed to be invalid. Copying or excerpting portion of, or altering the content of the report is not permitted without the written authorization of AGC. The test results presented in the report apply only to the tested sample. Any objections to report issued by AGC should be submitted to AGC within 15 days after the issuance of the test report. Further enquiry of validity or verification of the test report should be addressed to AGC by agc@agc-cert.com.

7.4. Body Worn Position

- (1) To position the EUT parallel to the phantom surface.
- (2) To adjust the EUT parallel to the flat phantom.
- (3) To adjust the distance between the EUT surface and the flat phantom to **10mm**.

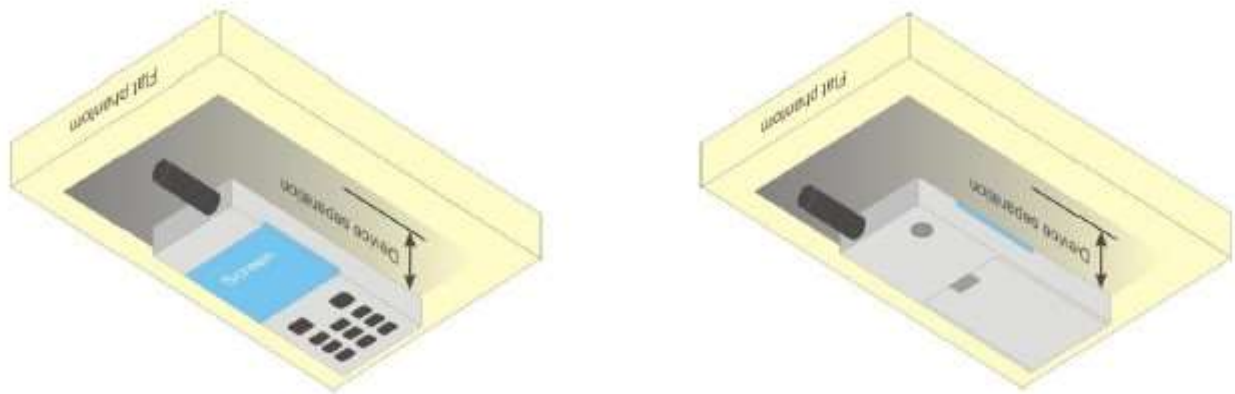

Any report having not been signed by authorized approver, or having been altered without authorization, or having not been stamped by the "Dedicated Testing/Inspection Stamp" is deemed to be invalid. Copying or excerpting portion of, or altering the content of the report is not permitted without the written authorization of AGC. The test results presented in the report apply only to the tested sample. Any objections to report issued by AGC should be submitted to AGC within 15 days after the issuance of the test report. Further enquiry of validity or verification of the test report should be addressed to AGC by agc@agc-cert.com.

Attestation of Global Compliance(Shenzhen)Co., Ltd
Attestation of Global Compliance(Shenzhen)Std & Tech Co., Ltd
Tel: +86-755 2523 4088 E-mail: agc@agc-cert.com Web: <http://cn.agc-cert.com/>



8. SAR EXPOSURE LIMITS

Limits for General Population/Uncontrolled Exposure (W/kg)

Type Exposure	Uncontrolled Environment Limit (W/kg)
Spatial Peak SAR (1g cube tissue for brain or body)	1.60
Spatial Average SAR (Whole body)	0.08
Spatial Peak SAR (Limbs)	4.0

Any report having not been signed by authorized approver, or having been altered without authorization, or having not been stamped by the "Dedicated Testing/Inspection Stamp" is deemed to be invalid. Copying or excerpting portion of, or altering the content of the report is not permitted without the written authorization of AGC. The test results presented in the report apply only to the tested sample. Any objections to report issued by AGC should be submitted to AGC within 15 days after the issuance of the test report. Further enquiry of validity or verification of the test report should be addressed to AGC by agc@agc-cert.com.

Attestation of Global Compliance(Shenzhen)Co., Ltd
Attestation of Global Compliance(Shenzhen)Std & Tech Co., Ltd
Tel: +86-755 2523 4088 E-mail: agc@agc-cert.com Web: <http://cn.agc-cert.com/>



9. TEST FACILITY

Test Site	Attestation of Global Compliance (Shenzhen) Co., Ltd
Location	1-2/F, Building 19, Junfeng Industrial Park, Chongqing Road, Heping Community, Fuhai Street, Bao'an District, Shenzhen, Guangdong, China
Designation Number	CN1259
FCC Test Firm Registration Number	975832
A2LA Cert. No.	5054.02
Description	Attestation of Global Compliance(Shenzhen) Co., Ltd is accredited by A2LA

Any report having not been signed by authorized approver, or having been altered without authorization, or having not been stamped by the "Dedicated Testing/Inspection Stamp" is deemed to be invalid. Copying or excerpting portion of, or altering the content of the report is not permitted without the written authorization of AGC. The test results presented in the report apply only to the tested sample. Any objections to report issued by AGC should be submitted to AGC within 15days after the issuance of the test report. Further enquiry of validity or verification of the test report should be addressed to AGC by agc@agc-cert.com.

Attestation of Global Compliance(Shenzhen)Co., Ltd
Attestation of Global Compliance(Shenzhen)Std & Tech Co., Ltd
Tel: +86-755 2523 4088 E-mail: agc@agc-cert.com Web: http://cn.agc-cert.com/



10. TEST EQUIPMENT LIST

Equipment description	Manufacturer/ Model	Identification No.	Current calibration date	Next calibration date
SAR Probe	MVG	SN 03/18 EP327	Dec. 17,2020	Dec. 16,2021
Phantom	SATIMO	SN_4511_SAM90	Validated. No cal required.	Validated. No cal required.
Liquid	SATIMO	-	Validated. No cal required.	Validated. No cal required.
Comm Tester	Agilent-8960	GB46310822	Aug. 21,2020	Aug. 20,2021
Comm Tester	R&S- CMW500	121209	Aug. 21,2020	Aug. 20,2021
Multimeter	Keithley 2000	1350784	Sep. 07,2020	Sep. 06,2021
SAR Software	SATIMO-OpenSAR	OpenSAR V4_02_32	N/A	N/A
Dipole	SATIMO SID835	SN29/15 DIP 0G835-383	Apr. 26,2019	Apr. 25,2022
Dipole	SATIMO SID1800	SN46/11 DIP 1G800-186	Apr. 26,2019	Apr. 25,2022
Dipole	SATIMO SID1900	SN 46/11 DIP 1G900-187	Apr. 26,2019	Apr. 25,2022
Dipole	SATIMO SID2450	SN46/11 DIP 2G450-189	Apr. 26,2019	Apr. 25,2022
Signal Generator	Agilent-E4438C	US41461365	Aug. 21,2020	Aug. 20,2021
Vector Analyzer	Agilent / E4440A	US41421290	Sep. 06,2020	Sep. 05,2021
Network Analyzer	Rhode & Schwarz ZVL6	SN101443	Oct. 16,2020	Oct. 15,2021
Attenuator	Warison /WATT-6SR1211	S/N:WRJ34AYM2F1	June 09,2021	June 08,2022
Attenuator	Mini-circuits / VAT-10+	31405	June 09,2021	June 08,2022
Amplifier	AS0104-55_55	1004793	June 10,2021	June 09,2022
Directional Couple	Werlatone/ C5571-10	SN99463	May 15,2020	May 14,2022
Directional Couple	Werlatone/ C6026-10	SN99482	May 15,2020	May 14,2022
Power Sensor	NRP-Z21	1137.6000.02	Sep. 08,2020	Sep. 07,2021
Power Sensor	NRP-Z23	100323	Feb. 17,2021	Feb. 16,2022
Power Viewer	R&S	V2.3.1.0	N/A	N/A

Note: Per KDB 865664 Dipole SAR Validation, AGC Lab has adopted 3 years calibration intervals. On annual basis, every measurement dipole has been evaluated and is in compliance with the following criteria:

1. There is no physical damage on the dipole;
2. System validation with specific dipole is within 10% of calibrated value;
3. Return-loss is within 20% of calibrated measurement;
4. Impedance is within 5Ω of calibrated measurement.

Any report having not been signed by authorized approver, or having been altered without authorization, or having not been stamped by the "Dedicated Testing/Inspection Stamp" is deemed to be invalid. Copying or excerpting portion of, or altering the content of the report is not permitted without the written authorization of AGC. The test results presented in the report apply only to the tested sample. Any objections to report issued by AGC should be submitted to AGC within 15days after the issuance of the test report. Further enquiry of validity or verification of the test report should be addressed to AGC by agc@agc-cert.com.



11. MEASUREMENT UNCERTAINTY

SATIMO Uncertainty- SN 03/18 EP327 Measurement uncertainty for DUT averaged over 1 gram / 10 gram.									
Uncertainty Component	Sec.	Tol (+- %)	Prob. Dist.	Div.	Ci (1g)	Ci (10g)	1g Ui (+-%)	10g Ui (+-%)	vi
Measurement System									
Probe calibration	E.2.1	7.000	N	1	1	1	7.000	7.000	∞
Axial Isotropy	E.2.2	0.075	R	$\sqrt{3}$	$\sqrt{0.5}$	$\sqrt{0.5}$	0.031	0.031	∞
Hemispherical Isotropy	E.2.2	0.075	R	$\sqrt{3}$	$\sqrt{0.5}$	$\sqrt{0.5}$	0.031	0.031	∞
Boundary effect	E.2.3	1.000	R	$\sqrt{3}$	1	1	0.577	0.577	∞
Linearity	E.2.4	0.870	R	$\sqrt{3}$	1	1	0.502	0.502	∞
System detection limits	E.2.4	1.000	R	$\sqrt{3}$	1	1	0.577	0.577	∞
Modulation response	E.2.5	3.000	R	$\sqrt{3}$	1	1	1.732	1.732	∞
Readout Electronics	E.2.6	0.021	N	1	1	1	0.021	0.021	∞
Response Time	E.2.7	0.000	R	$\sqrt{3}$	1	1	0.000	0.000	∞
Integration Time	E.2.8	1.400	R	$\sqrt{3}$	1	1	0.808	0.808	∞
RF ambient conditions-Noise	E.6.1	3.000	R	$\sqrt{3}$	1	1	1.732	1.732	∞
RF ambient conditions-reflections	E.6.1	3.000	R	$\sqrt{3}$	1	1	1.732	1.732	∞
Probe positioner mechanical tolerance	E.6.2	1.400	R	$\sqrt{3}$	1	1	0.808	0.808	∞
Probe positioning with respect to phantom shell	E.6.3	1.400	R	$\sqrt{3}$	1	1	0.808	0.808	∞
Extrapolation, interpolation, and integrations algorithms for max. SAR evaluation	E.5	2.300	R	$\sqrt{3}$	1	1	1.328	1.328	∞
Test sample Related									
Test sample positioning	E.4.2	2.6	N	1	1	1	2.600	2.600	∞
Device holder uncertainty	E.4.1	3	N	1	1	1	3.000	3.000	∞
Output power variation—SAR drift measurement	E.2.9	5	R	$\sqrt{3}$	1	1	2.887	2.887	∞
SAR scaling	E.6.5	5	R	$\sqrt{3}$	1	1	2.887	2.887	∞
Phantom and tissue parameters									
Phantom shell uncertainty—shape, thickness, and permittivity	E.3.1	4	R	$\sqrt{3}$	1	1	2.309	2.309	∞
Uncertainty in SAR correction for deviations in permittivity and conductivity	E.3.2	1.9	N	1	1	0.84	1.900	1.596	∞
Liquid conductivity measurement	E.3.3	2.5	R	$\sqrt{3}$	0.78	0.71	1.126	1.025	∞
Liquid permittivity measurement	E.3.3	4	N	1	0.78	0.71	3.120	2.840	M
Liquid conductivity—temperature uncertainty	E.3.4	2.5	R	$\sqrt{3}$	0.23	0.26	0.332	0.375	∞
Liquid permittivity—temperature uncertainty	E.3.4	5	N	1	0.23	0.26	1.150	1.300	M
Combined Standard Uncertainty			RSS				10.525	10.341	
Expanded Uncertainty (95% Confidence interval)			K=2				21.051	20.681	

Any report having not been signed by authorized approver, or having been altered without authorization, or having not been stamped by the "Dedicated Testing/Inspection Stamp" is deemed to be invalid. Copying or excerpting portion of, or altering the content of the report is not permitted without the written authorization of AGC. The test results presented in the report apply only to the tested sample. Any objections to report issued by AGC should be submitted to AGC within 15 days after the issuance of the test report. Further enquiry of validity or verification of the test report should be addressed to AGC by agc@agc-cert.com.



SATIMO Uncertainty- SN 03/18 EP327									
System Validation uncertainty for DUT averaged over 1 gram / 10 gram.									
Uncertainty Component	Sec.	Tol (+- %)	Prob. Dist.	Div.	Ci (1g)	Ci (10g)	1g Ui (+-%)	10g Ui (+-%)	vi
Measurement System									
Probe calibration	E.2.1	7.000	N	1	1	1	7.000	7.000	∞
Axial Isotropy	E.2.2	0.075	R	$\sqrt{3}$	1	1	0.043	0.043	∞
Hemispherical Isotropy	E.2.2	0.075	R	$\sqrt{3}$	0	0	0.000	0.000	∞
Boundary effect	E.2.3	1.000	R	$\sqrt{3}$	1	1	0.577	0.577	∞
Linearity	E.2.4	0.870	R	$\sqrt{3}$	1	1	0.502	0.502	∞
System detection limits	E.2.4	1.0	R	$\sqrt{3}$	1	1	0.58	0.58	∞
Modulation response	E.2.5	3.0	R	$\sqrt{3}$	0	0	0.00	0.00	∞
Readout Electronics	E.2.6	0.021	N	1	1	1	0.021	0.021	∞
Response Time	E.2.7	0.0	R	$\sqrt{3}$	0	0	0.00	0.00	∞
Integration Time	E.2.8	1.4	R	$\sqrt{3}$	0	0	0.00	0.00	∞
RF ambient conditions-Noise	E.6.1	3.0	R	$\sqrt{3}$	1	1	1.73	1.73	∞
RF ambient conditions-reflections	E.6.1	3.0	R	$\sqrt{3}$	1	1	1.73	1.73	∞
Probe positioner mechanical tolerance	E.6.2	1.4	R	$\sqrt{3}$	1	1	0.81	0.81	∞
Probe positioning with respect to phantom shell	E.6.3	1.4	R	$\sqrt{3}$	1	1	0.81	0.81	∞
Extrapolation, interpolation, and integrations algorithms for max. SAR evaluation	E.5	2.3	R	$\sqrt{3}$	1	1	1.33	1.33	∞
System validation source									
Deviation of experimental dipole from numerical dipole	E.6.4	5.0	N	1	1	1	5.00	5.00	∞
Input power and SAR drift measurement	8,6.6.4	5.0	R	$\sqrt{3}$	1	1	2.89	2.89	∞
Dipole axis to liquid distance	8,E.6.6	2.0	R	$\sqrt{3}$	1	1	1.15	1.15	∞
Phantom and set-up									
Phantom shell uncertainty—shape, thickness, and permittivity	E.3.1	4.0	R	$\sqrt{3}$	1	1	2.31	2.31	∞
Uncertainty in SAR correction for deviations in permittivity and conductivity	E.3.2	1.9	N	1	1	0.84	1.90	1.60	∞
Liquid conductivity (temperature uncertainty)	E.3.3	2.5	R	$\sqrt{3}$	0.78	0.71	1.13	1.02	∞
Liquid conductivity (measured)	E.3.3	4	N	1	0.78	0.71	3.12	2.84	M
Liquid permittivity (temperature uncertainty)	E.3.4	2.5	R	$\sqrt{3}$	0.23	0.26	0.33	0.38	∞
Liquid permittivity (measured)	E.3.4	5	N	1	0.23	0.26	1.15	1.30	M
Combined Standard Uncertainty			RSS				10.458	10.272	
Expanded Uncertainty (95% Confidence interval)			K=2				20.916	20.543	

Any report having not been signed by authorized approver, or having been altered without authorization, or having not been stamped by the "Dedicated Testing/Inspection Stamp" is deemed to be invalid. Copying or excerpting portion of, or altering the content of the report is not permitted without the written authorization of AGC. The test results presented in the report apply only to the tested sample. Any objections to report issued by AGC should be submitted to AGC within 15 days after the issuance of the test report. Further enquiry of validity or verification of the test report should be addressed to AGC by agc@agc-cert.com.



SATIMO Uncertainty- SN 03/18 EP327									
System Check uncertainty for DUT averaged over 1 gram / 10 gram.									
Uncertainty Component	Sec.	Tol (+-%)	Prob. Dist.	Div.	Ci (1g)	Ci (10g)	1g Ui (+-%)	10g Ui (+-%)	vi
Measurement System									
Probe calibration drift	E.2.1.3	0.5	N	1	1	1	0.50	0.50	∞
Axial Isotropy	E.2.2	0.075	R	$\sqrt{3}$	0	0	0.00	0.00	∞
Hemispherical Isotropy	E.2.2	0.075	R	$\sqrt{3}$	0	0	0.00	0.00	∞
Boundary effect	E.2.3	1.000	R	$\sqrt{3}$	0	0	0.00	0.00	∞
Linearity	E.2.4	0.870	R	$\sqrt{3}$	0	0	0.00	0.00	∞
System detection limits	E.2.4	1.0	R	$\sqrt{3}$	0	0	0.00	0.00	∞
Modulation response	E.2.5	3.0	R	$\sqrt{3}$	0	0	0.00	0.00	∞
Readout Electronics	E.2.6	0.021	N	1	0	0	0.00	0.00	∞
Response Time	E.2.7	0	R	$\sqrt{3}$	0	0	0.00	0.00	∞
Integration Time	E.2.8	1.4	R	$\sqrt{3}$	0	0	0.00	0.00	∞
RF ambient conditions-Noise	E.6.1	3.0	R	$\sqrt{3}$	0	0	0.00	0.00	∞
RF ambient conditions-reflections	E.6.1	3.0	R	$\sqrt{3}$	0	0	0.00	0.00	∞
Probe positioner mechanical tolerance	E.6.2	1.4	R	$\sqrt{3}$	1	1	0.81	0.81	∞
Probe positioning with respect to phantom shell	E.6.3	1.4	R	$\sqrt{3}$	1	1	0.81	0.81	∞
Extrapolation, interpolation, and integrations algorithms for max. SAR evaluation	E.5	2.3	R	$\sqrt{3}$	0	0	0.00	0.00	∞
System check source (dipole)									
Deviation of experimental dipoles	E.6.4	2.0	N	1	1	1	2.00	2.00	∞
Input power and SAR drift measurement	8,6.6.4	5.0	R	$\sqrt{3}$	1	1	2.89	2.89	∞
Dipole axis to liquid distance	8,E.6.6	2.0	R	$\sqrt{3}$	1	1	1.15	1.15	∞
Phantom and tissue parameters									
Phantom shell uncertainty—shape, thickness, and permittivity	E.3.1	4	R	$\sqrt{3}$	1	1	2.31	2.31	∞
Uncertainty in SAR correction for deviations in permittivity and conductivity	E.3.2	1.9	N	1	1	0.84	1.90	1.60	∞
Liquid conductivity measurement	E.3.3	2.5	R	$\sqrt{3}$	0.78	0.71	1.13	1.02	∞
Liquid permittivity measurement	E.3.3	4	N	1	0.78	0.71	3.12	2.84	M
Liquid conductivity—temperature uncertainty	E.3.4	2.5	R	$\sqrt{3}$	0.23	0.26	0.33	0.38	∞
Liquid permittivity—temperature uncertainty	E.3.4	5	N	1	0.23	0.26	1.15	1.30	M
Combined Standard Uncertainty			RSS				5.562	5.203	
Expanded Uncertainty (95% Confidence interval)			K=2				11.124	10.406	

Any report having not been signed by authorized approver, or having been altered without authorization, or having not been stamped by the "Dedicated Testing/Inspection Stamp" is deemed to be invalid. Copying or excerpting portion of, or altering the content of the report is not permitted without the written authorization of AGC. The test results presented in the report apply only to the tested sample. Any objections to report issued by AGC should be submitted to AGC within 15 days after the issuance of the test report. Further enquiry of validity or verification of the test report should be addressed to AGC by agc@agc-cert.com.



12. CONDUCTED POWER MEASUREMENT GSM BAND

Mode	Frequency(MHz)	Avg. Burst Power(dBm)	Duty cycle Factor(dBm)	Frame Power(dBm)
Maximum Power <1>				
GSM 850	824.2	32.00	-9	23.00
	836.6	31.77	-9	22.77
	848.8	31.96	-9	22.96
GPRS 850 (1 Slot)	824.2	31.55	-9	22.55
	836.6	31.31	-9	22.31
	848.8	31.51	-9	22.51
GPRS 850 (2 Slot)	824.2	30.25	-6	24.25
	836.6	30.02	-6	24.02
	848.8	30.23	-6	24.23
GPRS 850 (3 Slot)	824.2	28.96	-4.26	24.70
	836.6	28.91	-4.26	24.65
	848.8	28.88	-4.26	24.62
GPRS 850 (4 Slot)	824.2	26.81	-3	23.81
	836.6	27.27	-3	24.27
	848.8	27.15	-3	24.15
EGPRS 850 (1 Slot)	824.2	24.20	-9	15.20
	836.6	23.92	-9	14.92
	848.8	24.79	-9	15.79
EGPRS 850 (2 Slot)	824.2	22.35	-6	16.35
	836.6	22.53	-6	16.53
	848.8	22.42	-6	16.42
EGPRS 850 (3 Slot)	824.2	20.43	-4.26	16.17
	836.6	20.81	-4.26	16.55
	848.8	20.67	-4.26	16.41
EGPRS 850 (4 Slot)	824.2	18.83	-3	15.83
	836.6	19.11	-3	16.11
	848.8	19.75	-3	16.75

Any report having not been signed by authorized approver, or having been altered without authorization, or having not been stamped by the "Dedicated Testing/Inspection Stamp" is deemed to be invalid. Copying or excerpting portion of, or altering the content of the report is not permitted without the written authorization of AGC. The test results presented in the report apply only to the tested sample. Any objections to report issued by AGC should be submitted to AGC within 15days after the issuance of the test report. Further enquiry of validity or verification of the test report should be addressed to AGC by agc@agc-cert.com.



GSM BAND CONTINUE

Mode	Frequency(MHz)	Avg. Burst Power(dBm)	Duty cycle Factor(dBm)	Frame Power(dBm)
Maximum Power <1>				
PCS1900	1850.2	30.11	-9	21.11
	1880	29.99	-9	20.99
	1909.8	29.91	-9	20.91
GPRS1900 (1 Slot)	1850.2	29.73	-9	20.73
	1880	29.48	-9	20.48
	1909.8	29.57	-9	20.57
GPRS1900 (2 Slot)	1850.2	27.29	-6	21.29
	1880	27.64	-6	21.64
	1909.8	27.73	-6	21.73
GPRS1900 (3 Slot)	1850.2	26.38	-4.26	22.12
	1880	26.64	-4.26	22.38
	1909.8	26.49	-4.26	22.23
GPRS1900 (4 Slot)	1850.2	25.46	-3	22.46
	1880	25.28	-3	22.28
	1909.8	25.66	-3	22.66
EGPRS1900 (1 Slot)	1850.2	21.91	-9	12.91
	1880	21.55	-9	12.55
	1909.8	21.89	-9	12.89
EGPRS1900 (2 Slot)	1850.2	20.71	-6	14.71
	1880	21.67	-6	15.67
	1909.8	21.19	-6	15.19
EGPRS1900 (3 Slot)	1850.2	18.99	-4.26	14.73
	1880	19.03	-4.26	14.77
	1909.8	18.85	-4.26	14.59
EGPRS1900 (4 Slot)	1850.2	18.15	-3	15.15
	1880	17.91	-3	14.91
	1909.8	18.21	-3	15.21

Note 1:

The Frame Power (Source-based time-averaged Power) is scaled the maximum burst average power based on time slots. The calculated methods are show as following:

- Frame Power = Max burst power (1 Up Slot) – 9 dB
- Frame Power = Max burst power (2 Up Slot) – 6 dB
- Frame Power = Max burst power (3 Up Slot) – 4.26 dB
- Frame Power = Max burst power (4 Up Slot) – 3 dB

Note 2:

SAR is not required for GPRS (1 Slot) Mode because its output power is less than of Voice Mode

Any report having not been signed by authorized approver, or having been altered without authorization, or having not been stamped by the "Dedicated Testing/Inspection Stamp" is deemed to be invalid. Copying or excerpting portion of, or altering the content of the report is not permitted without the written authorization of AGC. The test results presented in the report apply only to the tested sample. Any objections to report issued by AGC should be submitted to AGC within 15days after the issuance of the test report. Further enquiry of validity or verification of the test report should be addressed to AGC by agc@agc-cert.com.



**UMTS BAND
HSDPA Setup Configuration:**

- The EUT was connected to Base Station Agilent E5515C referred to the Setup Configuration.
- The RF path losses were compensated into the measurements.
- A call was established between EUT and Based Station with following setting:
 - (1) Set Gain Factors(β_c and β_d) parameters set according to each
 - (2) Set RMC 12.2Kbps+HSDPA mode.
 - (3) Set Cell Power=-86dBm
 - (4) Set HS-DSCH Configuration Type to FRC (H-set 1, QPSK)
 - (5) Select HSDPA Uplink Parameters
 - (6) Set Delta ACK, Delta NACK and Delta CQI=8
 - (7) Set Ack - Nack Repetition Factor to 3
 - (8) Set CQI Feedback Cycle (k) to 4ms
 - (9) Set CQI Repetition Factor to 2
 - (10) Power Ctrl Mode=All Up bits
- The transmitted maximum output power was recorded.

Table C.10.2.4: β values for transmitter characteristics tests with HS-DPCCH

Sub-test	β_c (Note5)	β_d	β_d (SF)	β_c/β_d	β_{HS} (Note1, Note 2)	CM (dB) (Note 3)	MPR (dB) (Note 3)
1	2/15	15/15	64	2/15	4/15	0.0	0.0
2	12/15(Note 4)	15/15(Note 4)	64	12/15(Note 4)	24/15	1.0	0.0
3	15/15	8/15	64	15/8	30/15	1.5	0.5
4	15/15	4/15	64	15/4	30/15	1.5	0.5

Note 1: $\Delta ACK, \Delta NACK$ and $\Delta CQI = 30/15$ with $\beta_{hs} = 30/15 * \beta_c$.

Note 2: For the HS-DPCCH power mask requirement test in clause 5.2C, 5.7A, and the Error Vector Magnitude (EVM) with HS-DPCCH test in clause 5.13.1A, and HSDPA EVM with phase discontinuity in clause 5.13.1AA, ΔACK and $\Delta NACK = 30/15$ with $\beta_{hs} = 30/15 * \beta_c$, and $\Delta CQI = 24/15$ with $\beta_{hs} = 24/15 * \beta_c$.

Note 3: CM = 1 for $\beta_c/\beta_d = 12/15$, $hs/c = 24/15$. For all other combinations of DPDCH, DPCCH and HS-DPCCH the MPR is based on the relative CM difference. This is applicable for only UEs that support HSDPA in release 6 and later releases.

Note 4: For subtest 2 the c/d ratio of 12/15 for the TFC during the measurement period (TF1, TF0) is achieved by setting the signalled gain factors for the reference TFC (TF1, TF1) to $c = 11/15$ and $d = 15/15$.

Any report having not been signed by authorized approver, or having been altered without authorization, or having not been stamped by the "Dedicated Testing/Inspection Stamp" is deemed to be invalid. Copying or excerpting portion of, or altering the content of the report is not permitted without the written authorization of AGC. The test results presented in the report apply only to the tested sample. Any objections to report issued by AGC should be submitted to AGC within 15days after the issuance of the test report. Further enquiry of validity or verification of the test report should be addressed to AGC by agc@agc-cert.com.



HSUPA Setup Configuration:

- The EUT was connected to Base Station Agilent E5515C referred to the Setup Configuration.
- The RF path losses were compensated into the measurements.
- A call was established between EUT and Base Station with following setting * :
 - (1) Call Configs = 5.2B, 5.9B, 5.10B, and 5.13.2B with QPSK
 - (2) Set the Gain Factors (β_c and β_d) and parameters (AG Index) were set according to each specific sub-test in the following table, C11.1.3, quoted from the TS 34.121
 - (3) Set Cell Power = -86 dBm
 - (4) Set Channel Type = 12.2k + HSPA
 - (5) Set UE Target Power
 - (6) Power Ctrl Mode= Alternating bits
 - (7) Set and observe the E-TFCI
 - (8) Confirm that E-TFCI is equal to the target E-TFCI of 75 for sub-test 1, and other subtest's E-TFCI
- The transmitted maximum output power was recorded.

Table C.11.1.3: β values for transmitter characteristics tests with HS-DPCCH and E-DCH

Sub-test	β_c	β_d	β_d (SF)	β_c/β_d	β_{HS} (Note 1)	β_{ec}	β_{ed} (Note 4) (Note 5)	β_{ed} (SF)	β_{ed} (Code s)	CM (dB) (Note 2)	MPR (dB) (Note 2) (Note 6)	AG Index (Note 5)	E-TF CI
1	11/15 (Note 3)	15/15 (Note 3)	64	11/15 (Note 3)	22/15	209/225	1309/225	4	1	1.0	0.0	20	75
2	6/15	15/15	64	6/15	12/15	12/15	94/75	4	1	3.0	2.0	12	67
3	15/15	9/15	64	15/9	30/15	30/15	β_{ed1} : 47/15 β_{ed2} : 47/15	4	2	2.0	1.0	15	92
4	2/15	15/15	64	2/15	4/15	2/15	56/75	4	1	3.0	2.0	17	71
5	15/15	0	-	-	5/15	5/15	47/15	4	1	1.0	0.0	12	67

Note 1: For sub-test 1 to 4, ΔACK , $\Delta NACK$ and $\Delta CQI = 30/15$ with $\beta_{hs} = 30/15 * \beta_c$. For sub-test 5, ΔACK , $\Delta NACK$ and $\Delta CQI = 5/15$ with $\beta_{hs} = 5/15 * \beta_c$.

Note 2: CM = 1 for $\beta_c/\beta_d = 12/15$, $hs/c = 24/15$. For all other combinations of DPDCH, DPCCH, HS-DPCCH, E-DPDCH and E-DPCCH the MPR is based on the relative CM difference.

Note 3: For subtest 1 the c/ d ratio of 11/15 for the TFC during the measurement period (TF1, TF0) is achieved by setting the signalled gain factors for the reference TFC (TF1, TF1) to c = 10/15 and d = 15/15.

Note 4: In case of testing by UE using E-DPDCH Physical Layer category 1, Sub-test 3 is omitted according to TS25.306 Table 5.1g.

Note 5: β_{ed} cannot be set directly; it is set by Absolute Grant Value.

Note 6: For subtests 2, 3 and 4, UE may perform E-DPDCH power scaling at max power which could results in slightly smaller MPR values.



UMTS BAND II

Mode	Frequency (MHz)	Avg. Burst Power (dBm)
WCDMA 1900 RMC	1852.4	22.47
	1880	21.98
	1907.6	22.31
WCDMA 1900 AMR	1852.4	22.26
	1880	21.89
	1907.6	21.78
HSDPA Subtest 1	1852.4	20.97
	1880	20.79
	1907.6	20.93
HSDPA Subtest 2	1852.4	20.40
	1880	20.03
	1907.6	20.48
HSDPA Subtest 3	1852.4	20.10
	1880	19.93
	1907.6	20.24
HSDPA Subtest 4	1852.4	20.27
	1880	20.30
	1907.6	20.78
HSUPA Subtest 1	1852.4	20.56
	1880	20.31
	1907.6	20.37
HSUPA Subtest 2	1852.4	21.55
	1880	21.73
	1907.6	21.27
HSUPA Subtest 3	1852.4	21.13
	1880	21.18
	1907.6	21.20
HSUPA Subtest 4	1852.4	21.38
	1880	22.15
	1907.6	22.13
HSUPA Subtest 5	1852.4	21.01
	1880	21.68
	1907.6	22.05

Any report having not been signed by authorized approver, or having been altered without authorization, or having not been stamped by the "Dedicated Testing/Inspection Stamp" is deemed to be invalid. Copying or excerpting portion of, or altering the content of the report is not permitted without the written authorization of AGC. The test results presented in the report apply only to the tested sample. Any objections to report issued by AGC should be submitted to AGC within 15 days after the issuance of the test report. Further enquiry of validity or verification of the test report should be addressed to AGC by agc@agc-cert.com.



UMTS BAND V

Mode	Frequency (MHz)	Avg. Burst Power (dBm)
WCDMA 850 RMC	826.4	22.47
	836.4	22.04
	846.6	22.14
WCDMA 850 AMR	826.4	22.28
	836.4	21.99
	846.6	21.70
HSDPA Subtest 1	826.4	21.26
	836.4	20.76
	846.6	20.88
HSDPA Subtest 2	826.4	20.33
	836.4	19.85
	846.6	20.71
HSDPA Subtest 3	826.4	20.16
	836.4	20.04
	846.6	20.07
HSDPA Subtest 4	826.4	20.20
	836.4	20.65
	846.6	20.77
HSUPA Subtest 1	826.4	20.48
	836.4	20.42
	846.6	20.24
HSUPA Subtest 2	826.4	21.52
	836.4	21.58
	846.6	21.34
HSUPA Subtest 3	826.4	21.08
	836.4	21.30
	846.6	21.32
HSUPA Subtest 4	826.4	21.25
	836.4	22.33
	846.6	22.20
HSUPA Subtest 5	826.4	21.14
	836.4	21.82
	846.6	21.88

Any report having not been signed by authorized approver, or having been altered without authorization, or having not been stamped by the "Dedicated Testing/Inspection Stamp" is deemed to be invalid. Copying or excerpting portion of, or altering the content of the report is not permitted without the written authorization of AGC. The test results presented in the report apply only to the tested sample. Any objections to report issued by AGC should be submitted to AGC within 15 days after the issuance of the test report. Further enquiry of validity or verification of the test report should be addressed to AGC by agc@agc-cert.com.



According to 3GPP 25.101 sub-clause 6.2.2 , the maximum output power is allowed to be reduced by following the table.

Table 6.1aA: UE maximum output power with HS-DPCCH and E-DCH

UE Transmit Channel Configuration	CM(db)	MPR(db)
For all combinations of ,DPDCH,DPCCH HS-DPDCH,E-DPDCH and E-DPCCH	$0 \leq CM \leq 3.5$	$MAX(CM-1,0)$

Note: CM=1 for $\beta_d/\beta_{d'}=12/15$, $\beta_{hs}/\beta_c=24/15$.For all other combinations of DPDCH, DPCCH, HS-DPCCH, E-DPDCH and E-DPCCH the MPR is based on the relative CM difference.

The device supports MPR to solve linearity issues (ACLR or SEM) due to the higher peak-to average ratios (PAR) of the HSUPA signal. This prevents saturating the full range of the TX DAC inside of device and provides a reduced power output to the RF transceiver chip according to the Cubic Metric (a function of the combinations of DPDCH, DPCCH, HS-DPCCH, E-DPDCH and E-DPCCH).

When E-DPDCH channels are present the beta gains on those channels are reduced firsts to try to get the power under the allowed limit. If the beta gains are lowered as far as possible, then a hard limiting is applied at the maximum allowed level.

The SW currently recalculates the cubic metric every time the beta gains on the E-DPDCH are reduced. The cubic metric will likely get lower each time this is done .However, there is no reported reduction of maximum output power in the HSUPA mode since the device also provides a compensation for the power back-off by increasing the gain of TX_AGC in the transceiver (PA) device.

The end effect is that the DUT output power is identical to the case where there is no MPR in the device.

Any report having not been signed by authorized approver, or having been altered without authorization, or having not been stamped by the "Dedicated Testing/Inspection Stamp" is deemed to be invalid. Copying or excerpting portion of, or altering the content of the report is not permitted without the written authorization of AGC. The test results presented in the report apply only to the tested sample. Any objections to report issued by AGC should be submitted to AGC within 15days after the issuance of the test report. Further enquiry of validity or verification of the test report should be addressed to AGC by agc@agc-cert.com.



LTE Band

Average Power of LTE Band 2(dBm)								
Bandwidth	Modulation	RB size	RB offset	Target MPR	Channel	Channel	Channel	
					18607	18900	19193	
1.4MHz	QPSK	1	0	0	22.77	22.64	22.75	
			3	0	22.80	22.69	22.66	
			5	0	22.83	22.68	22.76	
		3	0	0	22.79	22.81	22.81	
			2	0	22.78	22.79	22.88	
			3	0	22.76	22.81	22.89	
	6	0	1	21.69	21.65	22.01		
	16QAM	1	0	1	22.12	22.31	21.68	
			3	1	22.07	22.41	21.73	
			5	1	22.14	22.35	21.84	
		3	0	1	21.77	21.68	21.89	
			2	1	21.76	21.85	21.88	
			3	1	21.76	21.88	21.80	
		6	0	2	20.90	20.91	21.16	
		Bandwidth	Modulation	RB size	RB offset	Target MPR	Channel	Channel
						18615	18900	19185
3MHz	QPSK	1	0	0	22.37	22.40	22.72	
			7	0	22.36	22.43	22.84	
			14	0	22.26	22.44	22.83	
		8	0	1	21.39	21.27	21.80	
			4	1	21.39	21.27	21.80	
			7	1	21.38	21.44	21.71	
	15	0	1	21.51	21.36	21.72		
	16QAM	1	0	1	21.76	22.10	21.83	
			7	1	21.80	22.14	21.78	
			14	1	21.69	22.15	21.74	
		8	0	2	20.79	20.57	21.35	
			4	2	20.79	20.58	21.36	
			7	2	20.68	20.66	21.13	
		15	0	2	20.60	20.51	21.16	

Any report having not been signed by authorized approver, or having been altered without authorization, or having not been stamped by the "Dedicated Testing/Inspection Stamp" is deemed to be invalid. Copying or excerpting portion of, or altering the content of the report is not permitted without the written authorization of AGC. The test results presented in the report apply only to the tested sample. Any objections to report issued by AGC should be submitted to AGC within 15days after the issuance of the test report. Further enquiry of validity or verification of the test report should be addressed to AGC by agc@agc-cert.com.



Average Power of LTE Band 2(dBm)								
Bandwidth	Modulation	RB size	RB offset	Target MPR	Channel	Channel	Channel	
					18625	18900	19175	
5MHz	QPSK	1	0	0	22.45	22.48	22.84	
			13	0	22.37	22.54	22.80	
			24	0	22.41	22.63	22.83	
		12	0	1	21.51	21.29	21.82	
			6	1	21.51	21.29	21.82	
			13	1	21.33	21.46	21.83	
	25	0	1	21.31	21.39	21.83		
	16QAM	1	0	1	20.94	21.77	21.47	
			13	1	20.79	21.73	21.57	
			24	1	20.80	21.86	21.56	
		12	0	2	20.63	20.58	21.04	
			6	2	20.63	20.59	21.04	
			13	2	20.58	20.68	20.94	
		25	0	2	20.53	20.59	21.07	
		Bandwidth	Modulation	RB size	RB offset	Target MPR	Channel	Channel
18650							18900	19150
10MHz	QPSK	1	0	0	22.48	22.47	22.76	
			25	0	22.32	22.61	22.83	
			49	0	22.21	22.68	22.90	
		25	0	1	21.33	21.37	21.81	
			13	1	21.33	21.37	21.82	
			25	1	21.33	21.36	21.85	
	50	0	1	21.29	21.42	21.73		
	16QAM	1	0	1	21.85	21.74	21.53	
			25	1	21.73	21.72	21.50	
			49	1	21.65	21.72	21.52	
		25	0	2	20.44	20.64	20.98	
			13	2	20.45	20.65	21.00	
			25	2	20.48	20.77	21.26	
		50	0	2	20.42	20.58	20.87	

Any report having not been signed by authorized approver, or having been altered without authorization, or having not been stamped by the "Dedicated Testing/Inspection Stamp" is deemed to be invalid. Copying or excerpting portion of, or altering the content of the report is not permitted without the written authorization of AGC. The test results presented in the report apply only to the tested sample. Any objections to report issued by AGC should be submitted to AGC within 15 days after the issuance of the test report. Further enquiry of validity or verification of the test report should be addressed to AGC by agc@agc-cert.com.



Average Power of LTE Band 2(dBm)								
Bandwidth	Modulation	RB size	RB offset	Target MPR	Channel	Channel	Channel	
					18675	18900	19125	
15MHz	QPSK	1	0	0	22.46	22.33	22.66	
			38	0	22.39	22.37	22.72	
			74	0	22.46	22.35	22.62	
		36	0	1	21.40	21.28	21.82	
			18	1	21.40	21.28	21.82	
			39	1	21.40	21.27	21.82	
		75	0	1	21.30	21.32	21.75	
		16QAM	1	0	1	22.05	22.17	22.01
				38	1	21.90	22.13	22.32
	74			1	22.00	22.21	22.35	
	36		0	2	20.49	20.50	20.77	
			18	2	20.50	20.53	20.77	
			39	2	20.50	20.58	20.78	
	75	0	2	20.41	20.41	20.83		
	Bandwidth	Modulation	RB size	RB offset	Target MPR	Channel	Channel	Channel
					18700	18900	19100	
20MHz	QPSK	1	0	0	22.57	22.79	22.49	
			50	0	22.40	22.52	22.80	
			99	0	22.46	22.65	22.92	
		50	0	1	21.39	21.69	21.71	
			25	1	21.39	21.69	21.72	
			50	1	21.22	21.87	21.78	
		100	0	1	21.23	21.65	21.89	
		16QAM	1	0	1	22.16	21.70	22.44
				50	1	22.07	21.62	22.51
	99			1	22.53	21.60	22.54	
	50		0	2	20.92	20.51	20.82	
			25	2	20.93	20.52	20.84	
			50	2	21.20	20.63	20.97	
	100		0	2	20.48	20.63	20.90	

Any report having not been signed by authorized approver, or having been altered without authorization, or having not been stamped by the "Dedicated Testing/Inspection Stamp" is deemed to be invalid. Copying or excerpting portion of, or altering the content of the report is not permitted without the written authorization of AGC. The test results presented in the report apply only to the tested sample. Any objections to report issued by AGC should be submitted to AGC within 15days after the issuance of the test report. Further enquiry of validity or verification of the test report should be addressed to AGC by agc@agc-cert.com.



Average Power of LTE Band 4(dBm)								
Bandwidth	Modulation	RB size	RB offset	Target MPR	Channel	Channel	Channel	
					19957	20175	20393	
1.4MHz	QPSK	1	0	0	23.72	23.73	23.36	
			3	0	23.73	23.51	23.43	
			5	0	23.76	23.62	23.34	
		3	0	0	23.73	23.55	23.28	
			2	0	23.71	23.52	23.39	
			3	0	23.77	23.54	23.32	
	6	0	1	22.42	22.69	22.44		
	16QAM	1	0	1	23.43	23.26	22.34	
			3	1	23.45	23.26	22.34	
			5	1	23.49	23.33	22.35	
		3	0	1	22.75	22.52	22.41	
			2	1	22.74	22.53	22.28	
			3	1	22.83	22.46	22.46	
		6	0	2	22.02	21.73	21.56	
		Bandwidth	Modulation	RB size	RB offset	Target MPR	Channel	Channel
19965							20175	20385
3MHz	QPSK	1	0	0	23.48	23.62	23.51	
			7	0	23.52	23.60	23.55	
			14	0	23.38	23.55	23.28	
		8	0	1	22.68	22.50	22.30	
			4	1	22.68	22.50	22.30	
			7	1	22.64	22.48	22.32	
	15	0	1	22.55	22.41	22.31		
	16QAM	1	0	1	23.08	23.32	22.84	
			7	1	23.15	23.37	22.80	
			14	1	23.01	23.31	22.84	
		8	0	2	22.01	21.72	21.84	
			4	2	22.01	21.59	21.84	
			7	2	21.97	21.73	21.79	
		15	0	2	21.92	21.78	21.81	

Any report having not been signed by authorized approver, or having been altered without authorization, or having not been stamped by the "Dedicated Testing/Inspection Stamp" is deemed to be invalid. Copying or excerpting portion of, or altering the content of the report is not permitted without the written authorization of AGC. The test results presented in the report apply only to the tested sample. Any objections to report issued by AGC should be submitted to AGC within 15days after the issuance of the test report. Further enquiry of validity or verification of the test report should be addressed to AGC by agc@agc-cert.com.



Average Power of LTE Band 4(dBm)								
Bandwidth	Modulation	RB size	RB offset	Target MPR	Channel	Channel	Channel	
					19975	20175	20375	
5MHz	QPSK	1	0	0	23.13	23.66	23.16	
			13	0	23.62	23.64	23.19	
			24	0	22.93	23.54	22.99	
		12	0	1	22.76	22.57	22.39	
			6	1	22.76	22.57	22.40	
			13	1	22.71	22.39	22.39	
	25	0	1	22.48	22.44	22.35		
	16QAM	1	0	1	22.05	22.73	22.31	
			13	1	22.05	22.74	22.01	
			24	1	21.98	22.89	22.08	
		12	0	2	21.79	21.66	21.34	
			6	2	21.80	21.66	21.35	
			13	2	21.75	21.66	21.45	
		25	0	2	21.87	21.73	21.44	
		Bandwidth	Modulation	RB size	RB offset	Target MPR	Channel	Channel
20000							20175	20350
10MHz	QPSK	1	0	0	23.02	23.54	23.62	
			25	0	23.34	23.65	23.60	
			49	0	23.28	23.68	23.55	
		25	0	1	22.66	22.49	22.24	
			13	1	22.66	22.49	22.25	
			25	1	22.71	22.53	22.23	
	50	0	1	22.49	22.46	22.40		
	16QAM	1	0	1	23.00	22.77	22.32	
			25	1	22.88	22.83	22.23	
			49	1	22.95	22.79	22.35	
		25	0	2	21.73	21.68	21.74	
			13	2	21.74	21.68	21.75	
			25	2	21.69	21.89	21.73	
		50	0	2	21.77	21.77	21.50	

Any report having not been signed by authorized approver, or having been altered without authorization, or having not been stamped by the "Dedicated Testing/Inspection Stamp" is deemed to be invalid. Copying or excerpting portion of, or altering the content of the report is not permitted without the written authorization of AGC. The test results presented in the report apply only to the tested sample. Any objections to report issued by AGC should be submitted to AGC within 15days after the issuance of the test report. Further enquiry of validity or verification of the test report should be addressed to AGC by agc@agc-cert.com.



Average Power of LTE Band 4(dBm)								
Bandwidth	Modulation	RB size	RB offset	Target MPR	Channel	Channel	Channel	
					20025	20175	20325	
15MHz	QPSK	1	0	0	23.25	23.35	23.56	
			38	0	23.18	23.63	23.54	
			74	0	23.25	23.71	23.46	
		36	0	1	22.68	22.50	22.29	
			18	1	22.68	22.50	22.29	
			39	1	22.67	22.48	22.29	
		75	0	1	22.53	22.47	22.34	
		16QAM	1	0	1	22.98	22.85	23.05
				38	1	22.94	22.75	23.20
	74			1	22.94	22.80	23.06	
	36		0	2	21.81	21.66	21.59	
			18	2	21.82	21.66	21.61	
			39	2	21.71	21.67	21.61	
	75	0	2	21.86	21.67	21.59		
	Bandwidth	Modulation	RB size	RB offset	Target MPR	Channel	Channel	Channel
					20050	20175	20300	
20MHz	QPSK	1	0	0	23.31	23.48	23.66	
			50	0	23.32	23.80	23.60	
			99	0	23.70	23.70	23.45	
		50	0	1	22.60	22.51	22.47	
			25	1	22.60	22.49	22.48	
			50	1	22.68	22.47	22.46	
		100	0	1	22.57	22.53	22.53	
		16QAM	1	0	1	22.94	22.79	23.52
				50	1	22.94	22.80	23.42
	99			1	22.93	22.82	23.44	
	50		0	2	21.80	21.62	21.66	
			25	2	21.80	21.61	21.67	
			50	2	21.75	21.70	21.72	
	100		0	2	21.73	21.71	21.72	

Any report having not been signed by authorized approver, or having been altered without authorization, or having not been stamped by the "Dedicated Testing/Inspection Stamp" is deemed to be invalid. Copying or excerpting portion of, or altering the content of the report is not permitted without the written authorization of AGC. The test results presented in the report apply only to the tested sample. Any objections to report issued by AGC should be submitted to AGC within 15days after the issuance of the test report. Further enquiry of validity or verification of the test report should be addressed to AGC by agc@agc-cert.com.



Average Power of LTE Band 66(dBm)							
Bandwidth	Modulation	RB size	RB offset	Target MPR	Channel	Channel	Channel
					131979	132422	132665
1.4MHz	QPSK	1	0	0	23.54	23.33	22.51
			2	0	23.72	23.44	22.91
			5	0	23.48	23.29	22.52
		3	0	0	23.66	23.33	22.97
			1	0	23.64	23.44	22.79
			3	0	23.59	23.29	22.66
	6	0	1	22.63	22.35	22.23	
	16QAM	1	0	1	23.47	22.88	22.59
			2	1	23.60	22.79	22.71
			5	1	23.45	22.85	22.31
		3	0	1	22.87	22.24	22.52
			1	1	22.84	22.24	22.55
			3	1	23.05	22.24	22.71
	6	0	2	22.12	21.66	21.41	
	Bandwidth	Modulation	RB size	RB offset	Target MPR	Channel	Channel
131987						132422	132657
3MHz	QPSK	1	0	0	23.72	23.34	22.33
			8	0	23.67	23.41	22.44
			14	0	23.75	23.34	22.27
		8	0	1	22.70	22.31	22.31
			4	1	22.70	22.31	22.31
			7	1	22.65	22.27	22.23
	15	0	1	22.52	22.42	22.15	
	16QAM	1	0	1	23.19	23.16	22.40
			8	1	23.11	23.25	22.27
			14	1	23.08	23.28	22.34
		8	0	2	22.07	21.90	21.65
			4	2	22.08	21.75	21.66
			7	2	22.02	21.75	21.67
	15	0	2	21.87	21.65	21.47	

Any report having not been signed by authorized approver, or having been altered without authorization, or having not been stamped by the "Dedicated Testing/Inspection Stamp" is deemed to be invalid. Copying or excerpting portion of, or altering the content of the report is not permitted without the written authorization of AGC. The test results presented in the report apply only to the tested sample. Any objections to report issued by AGC should be submitted to AGC within 15 days after the issuance of the test report. Further enquiry of validity or verification of the test report should be addressed to AGC by agc@agc-cert.com.



Average Power of LTE Band 66(dBm)								
Bandwidth	Modulation	RB size	RB offset	Target MPR	Channel	Channel	Channel	
					131997	132422	132647	
5MHz	QPSK	1	0	0	23.54	23.57	21.92	
			12	0	23.65	23.59	22.51	
			24	0	23.42	23.54	21.93	
		12	0	1	22.69	22.42	22.32	
			6	1	22.70	22.42	22.32	
			13	1	22.76	22.35	22.20	
	25	0	1	22.57	22.41	22.30		
	16QAM	1	0	1	22.14	22.72	22.10	
			12	1	22.10	22.71	22.19	
			24	1	22.12	22.81	22.21	
		12	0	2	21.76	21.63	21.34	
			6	2	21.77	21.64	21.34	
			13	2	21.70	21.71	21.26	
		25	0	2	21.94	21.57	21.31	
		Bandwidth	Modulation	RB size	RB offset	Target MPR	Channel	Channel
132022							132422	132622
10MHz	QPSK	1	0	0	23.47	23.57	21.94	
			24	0	23.58	23.42	22.47	
			49	0	23.70	23.38	22.48	
		25	0	1	22.64	22.24	22.26	
			12	1	22.64	22.24	22.25	
			25	1	22.69	22.36	22.23	
	50	0	1	22.55	22.29	22.29		
	16QAM	1	0	1	22.95	22.98	22.27	
			24	1	22.89	23.17	22.18	
			49	1	22.92	23.14	22.12	
		25	0	2	21.67	21.62	21.60	
			12	2	21.68	21.63	21.61	
			25	2	21.60	21.63	21.50	
		50	0	2	21.71	21.57	21.47	

Any report having not been signed by authorized approver, or having been altered without authorization, or having not been stamped by the "Dedicated Testing/Inspection Stamp" is deemed to be invalid. Copying or excerpting portion of, or altering the content of the report is not permitted without the written authorization of AGC. The test results presented in the report apply only to the tested sample. Any objections to report issued by AGC should be submitted to AGC within 15days after the issuance of the test report. Further enquiry of validity or verification of the test report should be addressed to AGC by agc@agc-cert.com.



Average Power of LTE Band 66(dBm)								
Bandwidth	Modulation	RB size	RB offset	Target MPR	Channel	Channel	Channel	
					132047	132422	132597	
15MHz	QPSK	1	0	0	23.65	23.44	22.45	
			38	0	23.59	23.38	22.35	
			74	0	23.62	23.41	22.32	
		38	0	1	22.69	22.36	22.25	
			18	1	22.69	22.37	22.25	
			37	1	22.69	22.38	22.24	
		75	0	1	22.49	22.33	22.41	
		16QAM	1	0	1	23.00	23.24	23.10
				38	1	22.95	23.14	22.99
	74			1	23.01	23.31	22.96	
	38		0	2	21.76	21.60	21.61	
			18	2	21.76	21.61	21.61	
			37	2	21.77	21.62	21.62	
	75	0	2	21.79	21.61	21.50		
	Bandwidth	Modulation	RB size	RB offset	Target MPR	Channel	Channel	Channel
					132072	132422	132572	
20MHz	QPSK	1	0	0	23.71	23.85	22.80	
			49	0	23.71	23.75	22.44	
			99	0	23.78	23.78	22.88	
		50	0	1	22.64	22.38	22.38	
			25	1	22.64	22.39	22.39	
			50	1	22.64	22.39	22.28	
		100	0	1	22.49	22.45	22.46	
		16QAM	1	0	1	22.56	22.61	23.20
				49	1	22.68	22.65	23.00
	99			1	22.58	22.57	23.00	
	50		0	2	21.72	21.61	21.63	
			25	2	21.73	21.62	21.56	
			50	2	21.79	21.55	21.57	
	100		0	2	21.76	21.57	21.68	

Any report having not been signed by authorized approver, or having been altered without authorization, or having not been stamped by the "Dedicated Testing/Inspection Stamp" is deemed to be invalid. Copying or excerpting portion of, or altering the content of the report is not permitted without the written authorization of AGC. The test results presented in the report apply only to the tested sample. Any objections to report issued by AGC should be submitted to AGC within 15 days after the issuance of the test report. Further enquiry of validity or verification of the test report should be addressed to AGC by agc@agc-cert.com.



The following tests were conducted according to the test requirements outlined in section 6.2 of the 3GPP TS36.101 specification.

UE Power Class: 3 (23 +/- 2dBm). The allowed Maximum Power Reduction (MPR) for the maximum output power due to higher order modulation and transmit bandwidth configuration (resource blocks) is specified in Table 6.2.3.3-1 of the 3GPP TS36.101.

Table 6.2.3.3-1 Maximum Power Reduction (MPR) for Power class3

Modulation	Maximum Power Reduction (MPR) for Power[RB]						MPR(dB)
	1.4MHz	3MHz	5MHz	10MHz	15MHz	20MHz	
QPSK	>5	>4	>8	>12	>16	>18	≤1
16QAM	≤5	≤4	≤8	≤12	≤16	≤18	≤1
16QAM	>5	>4	>8	>12	>16	>18	≤2

The allowed A-MPR values specified below in Table 6.2.4.3-1 of 3GPP TS36.101 are in addition to the allowed MPR requirements. All the measurements below were performed with A-MPR disabled, by using Network Signaling Value of "NS_01".3

Any report having not been signed by authorized approver, or having been altered without authorization, or having not been stamped by the "Dedicated Testing/Inspection Stamp" is deemed to be invalid. Copying or excerpting portion of, or altering the content of the report is not permitted without the written authorization of AGC. The test results presented in the report apply only to the tested sample. Any objections to report issued by AGC should be submitted to AGC within 15days after the issuance of the test report. Further enquiry of validity or verification of the test report should be addressed to AGC by agc@agc-cert.com.



Table 6.2.4.3-1: Additional Maximum Power Reduction (A-MPR) / Spectrum Emission requirements

Network Signaling value	Requirements (sub-clause)	E-UTRA Band	Channel bandwidth (MHz)	Resources Blocks (N_{RB})	A-MPR (dB)
NS_01	6.6.2.1.1	Table 5.2-1	1.4,3,5,10,15,20	Table 5.4.2-1	N/A
NS_03	6.6.2.2.3.1	2,4,10, 23, 25,35,36	3	>5	≤ 1
			5	>6	≤ 1
			10	>6	≤ 1
			15	>8	≤ 1
			20	>10	≤ 1
NS_04	6.6.2.2.3.2	41	5	>6	≤ 1
			10, 15, 20	Table 6.2.4.3-4	
NS_05	6.6.3.3.3.1	1	10,15,20	≥ 50	≤ 1
NS_06	6.6.2.2.3.3	12, 13, 14, 17	1.4, 3, 5, 10	Table 5.4.2-1	N/A
NS_07	6.6.2.2.3.3 6.6.3.3.3.2	13	10	Table 6.2.4.3-2	Table 6.2.4.3-2
NS_08	6.6.3.3.3.3	19	10, 15	> 44	≤ 3
NS_09	6.6.3.3.3.4	21	10, 15	> 40	≤ 1
				> 55	≤ 2
				Table 6.2.4.3-3	
NS_10		20	15, 20	Table 6.2.4.3-3	Table 6.2.4.3-3
NS_11	6.6.2.2.1 6.6.3.3.13	231	1.4, 3, 5, 10,15,20	Table 6.2.4.3-5	Table 6.2.4.3-5
NS_12	6.6.3.3.5	26	1.4, 3, 5	Table 6.2.4.3-6	Table 6.2.4.3-6
NS_13	6.6.3.3.6	26	5	Table 6.2.4.3-7	Table 6.2.4.3-7
NS_14	6.6.3.3.7	26	10, 15	Table 6.2.4.3-8	Table 6.2.4.3-8
NS_15	6.6.3.3.8	26	1.4, 3, 5, 10, 15	Table 6.2.4.3-9 Table 6.2.4.3-10	Table 6.2.4.3-9, Table 6.2.4.3-10
NS_16	6.6.3.3.9	27	3, 5, 10	Table 6.2.4.3-11, Table 6.2.4.3-12, Table 6.2.4.3-13	
NS_17	6.6.3.3.10	28	5, 10	Table 5.4.2-1	N/A
	6.6.3.3.11	28	5	≥ 2	≤ 1
NS_18			10, 15, 20	≥ 1	≤ 4
NS_19			10, 15, 20	Table 6.2.4.3-15	Table 6.2.4.3-15
NS_20			5, 10, 15, 20	Table 6.2.4.3-14	Table 6.2.4.3-14
...					
NS_20	-	-	-	-	-

Any report having not been signed by authorized approver, or having been altered without authorization, or having not been stamped by the "Dedicated Testing/Inspection Stamp" is deemed to be invalid. Copying or excerpting portion of, or altering the content of the report is not permitted without the written authorization of AGC. The test results presented in the report apply only to the tested sample. Any objections to report issued by AGC should be submitted to AGC within 15 days after the issuance of the test report. Further enquiry of validity or verification of the test report should be addressed to AGC by agc@agc-cert.com.



WIFI

Mode	Data Rate (Mbps)	Channel	Frequency(MHz)	Avg. Burst Power(dBm)
802.11b	1	01	2412	10.71
		06	2437	9.17
		11	2462	6.78
802.11g	6	01	2412	4.46
		06	2437	4.68
		11	2462	0.86
802.11n(20)	6.5	01	2412	3.45
		06	2437	3.72
		11	2462	-0.02

Bluetooth_V4.2(BR/EDR)

Modulation	Channel	Frequency(MHz)	Peak Power (dBm)
GFSK	0	2402	1.68
	39	2441	-2.58
	78	2480	-0.63
$\pi/4$ -DQPSK	0	2402	1.77
	39	2441	-1.82
	78	2480	-0.06
8-DPSK	0	2402	2.04
	39	2441	-1.5
	78	2480	0.40

Bluetooth_V4.2(BLE)

Modulation	Channel	Frequency(MHz)	Peak Power (dBm)
GFSK	0	2402	-5.38
	19	2440	-8.69
	39	2480	-6.46

Any report having not been signed by authorized approver, or having been altered without authorization, or having not been stamped by the "Dedicated Testing/Inspection Stamp" is deemed to be invalid. Copying or excerpting portion of, or altering the content of the report is not permitted without the written authorization of AGC. The test results presented in the report apply only to the tested sample. Any objections to report issued by AGC should be submitted to AGC within 15days after the issuance of the test report. Further enquiry of validity or verification of the test report should be addressed to AGC by agc@agc-cert.com.



13. TEST RESULTS

13.1. SAR Test Results Summary

13.1.1. Test position and configuration

Head SAR was performed with the device configured in the positions according to IEEE 1528-2013, Body-worn and 4 Edges SAR was performed with the device 10mm from the phantom.

13.1.2. Operation Mode

1. Per KDB 447498 D01 v06 ,for each exposure position, if the highest 1-g SAR is ≤ 0.8 W/kg, testing for low and high channel is optional.
2. Per KDB 865664 D01 v01r04,for each frequency band, if the measured SAR is ≥ 0.8 W/kg, testing for repeated SAR measurement is required , that the highest measured SAR is only to be tested. When the SAR results are near the limit, the following procedures are required for each device to verify these types of SAR measurement related variation concerns by repeating the highest measured SAR configuration in each frequency band.
 - (1) When the original highest measured SAR is ≥ 0.8 W/kg, repeat that measurement once.
 - (2) Perform a second repeated measurement only if the ratio of largest to smallest SAR for the original and first repeated measurements is >1.20 or when the original or repeated measurement is ≥ 1.45 W/kg.
 - (3) Perform a third repeated measurement only if the original, first and second repeated measurement is ≥ 1.5 W/kg and ratio of largest to smallest SAR for the original, first and second measurement is ≥ 1.20 .
3. Body-worn exposure conditions are intended to voice call operations, therefore GSM voice call mode is selected to be test.
4. Per KDB 648474 D04 v01r03,when the reported SAR for a body-worn accessory measured without a headset connected to the handset is ≤ 1.2 W/kg, SAR testing with a headset connected is not required.
5. Per KDB 248227 D01v02r02,for 2.4GHz 802.11g/n SAR testing is not required when the highest reported SAR for DSSS is adjusted by the ratio of OFDM to DSSS specified maximum output power and the adjusted SAR is ≤ 1.2 W/kg.
6. Per KDB 941225 D06 V02r01, When the same wireless mode transmission configurations for voice and data are required for SAR measurements, the more conservative configuration with a smaller separation distance should be tested for the overlapping SAR configurations.
7. Maximum Scaling SAR in order to calculate the Maximum SAR values to test under the standard Peak Power, Calculation method is as follows:
Maximum Scaling SAR =tested SAR (Max.) \times [maximum turn-up power (mw)/ maximum measurement output power(mw)]
8. Proximity sensor, just for avoiding the wrong operation in the phone screen when call, and has no influence on output power or SAR result
9. Per KDB 941225 D05v02r05, start with the largest channel bandwidth and measure SAR for QPSK with 1RB allocation using the RB offset and required test channel combination with highest maximum output power for RB offsets at the upper edge, middle and lower edge of each required test channel.
10. Per KDB 941125 D05v02r05, 50% RB allocation for QPSK SAR testing follows 1RB QPSK allocation procedure.
11. Per KDB 941125 D05v02r05. For QPSK with 100% RB allocation. SAR is not required when the highest maximum output power for 100% RB allocation is less than the highest maximum output power in 50% and

Any report having not been signed by authorized approver, or having been altered without authorization, or having not been stamped by the "Dedicated Testing/Inspection Stamp" is deemed to be invalid. Copying or excerpting portion of, or altering the content of the report is not permitted without the written authorization of AGC. The test results presented in the report apply only to the tested sample. Any objections to report issued by AGC should be submitted to AGC within 15days after the issuance of the test report. Further enquiry of validity or verification of the test report should be addressed to AGC by agc@agc-cert.com.



1RB allocation and the highest reported SAR is >1.45 W/kg, the remaining required test channels must also be tested.

12. Per KDB 941125 D05v02r05. 16QAM output power for each RB allocation configuration is not 1/2 dB higher than the same configuration in QPSK and the reported SAR for the QPSK configuration is ≤ 1.45 W/kg, Per KDB 941225 D05v02r05, 16QAM SAR testing is not required.
13. Per KDB 941125 D05v02r05. Smaller bandwidth output power for each RB allocation configuration is $>$ not 1/2 dB higher than the same configuration in the largest supported bandwidth, and the reported SAR for the largest supported bandwidth is ≤ 1.45 W/kg. Per KDB 941125 D05v02r05, smaller bandwidth SAR testing is not required.

Any report having not been signed by authorized approver, or having been altered without authorization, or having not been stamped by the "Dedicated Testing/Inspection Stamp" is deemed to be invalid. Copying or excerpting portion of, or altering the content of the report is not permitted without the written authorization of AGC. The test results presented in the report apply only to the tested sample. Any objections to report issued by AGC should be submitted to AGC within 15days after the issuance of the test report. Further enquiry of validity or verification of the test report should be addressed to AGC by agc@agc-cert.com.

Attestation of Global Compliance(Shenzhen)Co., Ltd
Attestation of Global Compliance(Shenzhen)Std & Tech Co., Ltd
Tel: +86-755 2523 4088 E-mail: agc@agc-cert.com Web: <http://cn.agc-cert.com/>



13.1.3. Test Result

SAR MEASUREMENT									
Depth of Liquid (cm):>15					Relative Humidity (%): 51.8				
Product: Mobile phone									
Test Mode: GSM850 with GMSK modulation									
Position	Mode	Ch.	Fr. (MHz)	Power Drift ($\pm 5\%$)	SAR (1g) (W/kg)	Max. Tune-up Power (dBm)	Meas. output Power (dBm)	Scaled SAR (W/kg)	Limit (W/kg)
SIM 1 Card									
Left Cheek	voice	190	836.6	-0.18	0.621	32.10	31.77	0.670	1.6
Left Tilt	voice	190	836.6	-0.25	0.355	32.10	31.77	0.383	1.6
Right Cheek	voice	190	836.6	0.32	0.658	32.10	31.77	0.710	1.6
Right Tilt	voice	190	836.6	-0.04	0.327	32.10	31.77	0.353	1.6
Body back	voice	190	836.6	-0.27	0.621	32.10	31.77	0.670	1.6
Body front	voice	190	836.6	0.10	0.605	32.10	31.77	0.653	1.6
Body back	GPRS-3 slot	128	824.2	-0.16	0.921	29.00	28.96	0.930	1.6
Body back	GPRS-3 slot	190	836.6	0.08	0.848	29.00	28.91	0.866	1.6
Body back	GPRS-3 slot	251	848.8	-0.51	0.806	29.00	28.88	0.829	1.6
Body front	GPRS-3 slot	190	836.6	-0.31	0.719	29.00	28.91	0.734	1.6
Edge 2(Right)	GPRS-3 slot	190	836.6	0.04	0.368	29.00	28.91	0.376	1.6
Edge 3(Bottom)	GPRS-3 slot	190	836.6	-0.07	0.156	29.00	28.91	0.159	1.6
Edge 4(Left)	GPRS-3 slot	190	836.6	-0.12	0.333	29.00	28.91	0.340	1.6

Note:

- When the 1-g Reported SAR is ≤ 0.8 W/kg, testing for low and high channel is optional. Refer to KDB 447498.
- The test separation for body back, body front and 4 Edges is 10mm of all above table.

Any report having not been signed by authorized approver, or having been altered without authorization, or having not been stamped by the "Dedicated Testing/Inspection Stamp" is deemed to be invalid. Copying or excerpting portion of, or altering the content of the report is not permitted without the written authorization of AGC. The test results presented in the report apply only to the tested sample. Any objections to report issued by AGC should be submitted to AGC within 15days after the issuance of the test report. Further enquiry of validity or verification of the test report should be addressed to AGC by agc@agc-cert.com.



SAR MEASUREMENT									
Depth of Liquid (cm):>15					Relative Humidity (%): 49.2				
Product: Mobile phone									
Test Mode: PCS1900 with GMSK modulation									
Position	Mode	Ch.	Fr. (MHz)	Power Drift (<±5%)	SAR (1g) (W/kg)	Max. Tune-up Power (dBm)	Meas. output Power (dBm)	Scaled SAR (W/kg)	Limit (W/kg)
SIM 1 Card									
Left Cheek	voice	661	1880.0	-0.28	0.035	30.20	29.99	0.037	1.6
Left Tilt	voice	661	1880.0	0.34	0.014	30.20	29.99	0.015	1.6
Right Cheek	voice	661	1880.0	-0.42	0.046	30.20	29.99	0.048	1.6
Right Tilt	voice	661	1880.0	-0.16	0.015	30.20	29.99	0.016	1.6
Body back	voice	661	1880.0	0.35	0.057	30.20	29.99	0.060	1.6
Body front	voice	661	1880.0	-0.27	0.044	30.20	29.99	0.046	1.6
Body back	GPRS-4 slot	661	1880	0.11	0.099	25.70	25.28	0.109	1.6
Body front	GPRS-4 slot	661	1880.0	-0.05	0.045	25.70	25.28	0.050	1.6
Edge 2(Right)	GPRS-4 slot	661	1880.0	0.24	0.039	25.70	25.28	0.043	1.6
Edge 3(Bottom)	GPRS-4 slot	661	1880.0	-0.32	0.045	25.70	25.28	0.050	1.6
Edge 4(Left)	GPRS-4 slot	661	1880.0	-0.07	0.010	25.70	25.28	0.011	1.6

Note:

- When the 1-g Reported SAR is ≤ 0.8 W/kg, testing for low and high channel is optional. Refer to KDB 447498.
- The test separation for body back, body front and 4 Edges is 10mm of all above table.

Any report having not been signed by authorized approver, or having been altered without authorization, or having not been stamped by the "Dedicated Testing/Inspection Stamp" is deemed to be invalid. Copying or excerpting portion of, or altering the content of the report is not permitted without the written authorization of AGC. The test results presented in the report apply only to the tested sample. Any objections to report issued by AGC should be submitted to AGC within 15days after the issuance of the test report. Further enquiry of validity or verification of the test report should be addressed to AGC by agc@agc-cert.com.



SAR MEASUREMENT									
Depth of Liquid (cm):>15					Relative Humidity (%): 49.2				
Product: Mobile phone									
Test Mode: WCDMA Band II with QPSK modulation									
Position	Mode	Ch.	Fr. (MHz)	Power Drift ($\pm 5\%$)	SAR (1g) (W/kg)	Max. Tune-up Power (dBm)	Meas. output Power (dBm)	Scaled SAR (W/kg)	Limit (W/kg)
Left Cheek	RMC 12.2kbps	9400	1880	-0.04	0.052	22.50	21.98	0.059	1.6
Left Tilt	RMC 12.2kbps	9400	1880	0.25	0.016	22.50	21.98	0.018	1.6
Right Cheek	RMC 12.2kbps	9400	1880	-0.31	0.078	22.50	21.98	0.088	1.6
Right Tilt	RMC 12.2kbps	9400	1880	-0.05	0.017	22.50	21.98	0.019	1.6
Body back	RMC 12.2kbps	9400	1880	-0.27	0.118	22.50	21.98	0.133	1.6
Body front	RMC 12.2kbps	9400	1880	0.07	0.079	22.50	21.98	0.089	1.6
Edge 2(Right)	RMC 12.2kbps	9400	1880	-0.16	0.041	22.50	21.98	0.046	1.6
Edge 3(Bottom)	RMC 12.2kbps	9400	1880	-0.20	0.064	22.50	21.98	0.072	1.6
Edge 4(Left)	RMC 12.2kbps	9400	1880	0.03	0.012	22.50	21.98	0.014	1.6

Note:

- When the 1-g Reported SAR is ≤ 0.8 W/kg, testing for low and high channel is optional. Refer to KDB 447498.
- The test separation for body back, body front and 4 Edges is 10mm of all above table.

Any report having not been signed by authorized approver, or having been altered without authorization, or having not been stamped by the "Dedicated Testing/Inspection Stamp" is deemed to be invalid. Copying or excerpting portion of, or altering the content of the report is not permitted without the written authorization of AGC. The test results presented in the report apply only to the tested sample. Any objections to report issued by AGC should be submitted to AGC within 15days after the issuance of the test report. Further enquiry of validity or verification of the test report should be addressed to AGC by agc@agc-cert.com.

Attestation of Global Compliance(Shenzhen)Co., Ltd
Attestation of Global Compliance(Shenzhen)Std & Tech Co., Ltd
Tel: +86-755 2523 4088 E-mail: agc@agc-cert.com Web: http://cn.agc-cert.com/



SAR MEASUREMENT									
Depth of Liquid (cm):>15					Relative Humidity (%): 51.8				
Product: Mobile phone									
Test Mode: WCDMA Band V with QPSK modulation									
Position	Mode	Ch.	Fr. (MHz)	Power Drift ($\pm 5\%$)	SAR (1g) (W/kg)	Max. Tune-up Power (dBm)	Meas. output Power (dBm)	Scaled SAR (W/kg)	Limit (W/kg)
Left Cheek	RMC 12.2kbps	4183	836.4	-0.09	0.540	22.50	22.04	0.600	1.6
Left Tilt	RMC 12.2kbps	4183	836.4	-0.26	0.288	22.50	22.04	0.320	1.6
Right Cheek	RMC 12.2kbps	4183	836.4	0.35	0.579	22.50	22.04	0.644	1.6
Right Tilt	RMC 12.2kbps	4183	836.4	-0.24	0.322	22.50	22.04	0.358	1.6
Body back	RMC 12.2kbps	4183	836.4	-0.17	0.745	22.50	22.04	0.828	1.6
Body front	RMC 12.2kbps	4183	836.4	0.10	0.732	22.50	22.04	0.814	1.6
Edge 2(Right)	RMC 12.2kbps	4183	836.4	-0.05	0.461	22.50	22.04	0.513	1.6
Edge 3(Bottom)	RMC 12.2kbps	4183	836.4	-0.13	0.148	22.50	22.04	0.165	1.6
Edge 4(Left)	RMC 12.2kbps	4183	836.4	0.08	0.371	22.50	22.04	0.412	1.6

Note:

- When the 1-g Reported SAR is ≤ 0.8 W/kg, testing for low and high channel is optional. Refer to KDB 447498.
- The test separation for body back, body front and 4 Edges is 10mm of all above table.

Any report having not been signed by authorized approver, or having been altered without authorization, or having not been stamped by the "Dedicated Testing/Inspection Stamp" is deemed to be invalid. Copying or excerpting portion of, or altering the content of the report is not permitted without the written authorization of AGC. The test results presented in the report apply only to the tested sample. Any objections to report issued by AGC should be submitted to AGC within 15days after the issuance of the test report. Further enquiry of validity or verification of the test report should be addressed to AGC by agc@agc-cert.com.



SAR MEASUREMENT												
Depth of Liquid (cm):>15						Relative Humidity (%):52.4						
Product: Mobile phone												
Test Mode: LTE Band 2												
BM MHz	MOD	Position	Test Mode		Ch.	Freq. (MHz)	Power Drift (<±5%)	SAR (1g) (W/kg)	Max. Tune up Power (dBm)	Meas. output Power (dBm)	Scaled SAR (W/kg)	Limit (W/kg)
			UL RB Allocation	UL RB START								
20	QPSK	Left Cheek	1	0	18900	1880	-0.18	0.052	23.00	22.79	0.055	1.6
		Left Tilt	1	0	18900	1880	0.25	0.018	23.00	22.79	0.019	1.6
		Right Cheek	1	0	18900	1880	-0.32	0.075	23.00	22.79	0.079	1.6
		Right Tilt	1	0	18900	1880	-0.07	0.031	23.00	22.79	0.033	1.6
		Body back	1	0	18900	1880	-0.42	0.111	23.00	22.79	0.116	1.6
		Body front	1	0	18900	1880	0.16	0.080	23.00	22.79	0.084	1.6
		Edge 2(Right)	1	0	18900	1880	-0.23	0.046	23.00	22.79	0.048	1.6
		Edge 3(Bottom)	1	0	18900	1880	0.05	0.072	23.00	22.79	0.076	1.6
		Edge 4(Left)	1	0	18900	1880	-0.28	0.013	23.00	22.79	0.014	1.6
20	QPSK	Left Cheek	50%	0	18900	1880	0.24	0.039	21.90	21.69	0.041	1.6
		Left Tilt	50%	0	18900	1880	-0.17	0.014	21.90	21.69	0.015	1.6
		Right Cheek	50%	0	18900	1880	0.16	0.061	21.90	21.69	0.064	1.6
		Right Tilt	50%	0	18900	1880	-0.52	0.024	21.90	21.69	0.025	1.6
		Body back	50%	0	18900	1880	0.30	0.092	21.90	21.69	0.097	1.6
		Body front	50%	0	18900	1880	-0.05	0.061	21.90	21.69	0.064	1.6
		Edge 2(Right)	50%	0	18900	1880	-0.27	0.037	21.90	21.69	0.039	1.6
		Edge 3(Bottom)	50%	0	18900	1880	0.13	0.058	21.90	21.69	0.061	1.6
		Edge 4(Left)	50%	0	18900	1880	0.05	0.011	21.90	21.69	0.012	1.6

Note:

- When the 1-g Reported SAR is ≤ 0.8 W/kg, testing for low and high channel is optional. Refer to KDB 447498.
- The test separation for body back, body front and 4 Edges is 10mm of all above table.

Any report having not been signed by authorized approver, or having been altered without authorization, or having not been stamped by the "Dedicated Testing/Inspection Stamp" is deemed to be invalid. Copying or excerpting portion of, or altering the content of the report is not permitted without the written authorization of AGC. The test results presented in the report apply only to the tested sample. Any objections to report issued by AGC should be submitted to AGC within 15days after the issuance of the test report. Further enquiry of validity or verification of the test report should be addressed to AGC by agc@agc-cert.com.



SAR MEASUREMENT												
Depth of Liquid (cm):>15						Relative Humidity (%):51.2						
Product: Mobile phone												
Test Mode: LTE Band 4												
BM MHz	MOD	Position	Test Mode		Ch.	Freq. (MHz)	Power Drift ($\pm 5\%$)	SAR (1g) (W/kg)	Max. Tuneup Power (dBm)	Meas. output Power (dBm)	Scaled SAR (W/kg)	Limit (W/kg)
			UL RB Allocation	UL RB START								
20	QPSK	Left Cheek	1	0	20175	1732.5	-0.18	0.050	23.90	23.48	0.055	1.6
		Left Tilt	1	0	20175	1732.5	0.26	0.014	23.90	23.48	0.015	1.6
		Right Cheek	1	0	20175	1732.5	-0.35	0.089	23.90	23.48	0.098	1.6
		Right Tilt	1	0	20175	1732.5	-0.27	0.019	23.90	23.48	0.021	1.6
		Body back	1	0	20175	1732.5	0.41	0.114	23.90	23.48	0.126	1.6
		Body front	1	0	20175	1732.5	-0.08	0.076	23.90	23.48	0.084	1.6
		Edge 2(Right)	1	0	20175	1732.5	-0.11	0.038	23.90	23.48	0.042	1.6
		Edge 3(Bottom)	1	0	20175	1732.5	0.06	0.054	23.90	23.48	0.059	1.6
		Edge 4(Left)	1	0	20175	1732.5	-0.38	0.013	23.90	23.48	0.014	1.6
20	QPSK	Left Cheek	50%	0	20175	1732.5	-0.27	0.046	22.70	22.51	0.048	1.6
		Left Tilt	50%	0	20175	1732.5	0.46	0.014	22.70	22.51	0.015	1.6
		Right Cheek	50%	0	20175	1732.5	-0.32	0.074	22.70	22.51	0.077	1.6
		Right Tilt	50%	0	20175	1732.5	-0.16	0.021	22.70	22.51	0.022	1.6
		Body back	50%	0	20175	1732.5	-0.08	0.078	22.70	22.51	0.081	1.6
		Body front	50%	0	20175	1732.5	0.35	0.051	22.70	22.51	0.053	1.6
		Edge 2(Right)	50%	0	20175	1732.5	-0.27	0.029	22.70	22.51	0.030	1.6
		Edge 3(Bottom)	50%	0	20175	1732.5	0.33	0.043	22.70	22.51	0.045	1.6
		Edge 4(Left)	50%	0	20175	1732.5	-0.09	0.010	22.70	22.51	0.010	1.6

Note:

- When the 1-g Reported SAR is ≤ 0.8 W/kg, testing for low and high channel is optional. Refer to KDB 447498.
- The test separation for body back, body front and 4 Edges is 10mm of all above table.

Any report having not been signed by authorized approver, or having been altered without authorization, or having not been stamped by the "Dedicated Testing/Inspection Stamp" is deemed to be invalid. Copying or excerpting portion of, or altering the content of the report is not permitted without the written authorization of AGC. The test results presented in the report apply only to the tested sample. Any objections to report issued by AGC should be submitted to AGC within 15days after the issuance of the test report. Further enquiry of validity or verification of the test report should be addressed to AGC by agc@agc-cert.com.



SAR MEASUREMENT												
Depth of Liquid (cm):>15						Relative Humidity (%):51.2						
Product: LTE smartphone												
Test Mode: LTE Band 66												
BW MHz	MOD	Position	Test Mode		Ch.	Freq. (MHz)	Power Drift (<±5%)	SAR (1g) (W/kg)	Max. Tuneup Power (dBm)	Meas. output Power (dBm)	Scaled SAR (W/Kg)	Limit (W/kg)
			UL RB Allocation	UL RB START								
20	QPSK	Left Cheek	1	0	132422	1755	-0.11	0.025	23.90	23.85	0.025	1.6
		Left Tilt	1	0	132422	1755	0.05	0.007	23.90	23.85	0.007	1.6
		Right Cheek	1	0	132422	1755	-0.26	0.026	23.90	23.85	0.026	1.6
		Right Tilt	1	0	132422	1755	-0.35	0.010	23.90	23.85	0.010	1.6
		Body back	1	0	132422	1755	-0.27	0.079	23.90	23.85	0.080	1.6
		Body front	1	0	132422	1755	0.41	0.053	23.90	23.85	0.054	1.6
		Edge 2(Right)	1	0	132422	1755	-0.19	0.016	23.90	23.85	0.016	1.6
		Edge 3(Bottom)	1	0	132422	1755	0.08	0.029	23.90	23.85	0.029	1.6
		Edge 4(Left)	1	0	132422	1755	-0.27	0.008	23.90	23.85	0.008	1.6
20	QPSK	Left Cheek	50%	0	132422	1755	-0.43	0.018	22.70	22.38	0.019	1.6
		Left Tilt	50%	0	132422	1755	0.15	0.008	22.70	22.38	0.009	1.6
		Right Cheek	50%	0	132422	1755	-0.13	0.027	22.70	22.38	0.029	1.6
		Right Tilt	50%	0	132422	1755	-0.28	0.010	22.70	22.38	0.011	1.6
		Body back	50%	0	132422	1755	-0.27	0.047	22.70	22.38	0.051	1.6
		Body front	50%	0	132422	1755	0.42	0.037	22.70	22.38	0.040	1.6
		Edge 2(Right)	50%	0	132422	1755	0.13	0.026	22.70	22.38	0.028	1.6
		Edge 3(Bottom)	50%	0	132422	1755	-0.31	0.022	22.70	22.38	0.024	1.6
		Edge 4(Left)	50%	0	132422	1755	0.06	0.006	22.70	22.38	0.006	1.6

Note:

- When the 1-g Reported SAR is ≤ 0.8 W/kg, testing for low and high channel is optional. Refer to KDB 447498.
- The test separation for body back, body front and 4 Edges is 10mm of all above table

Any report having not been signed by authorized approver, or having been altered without authorization, or having not been stamped by the "Dedicated Testing/Inspection Stamp" is deemed to be invalid. Copying or excerpting portion of, or altering the content of the report is not permitted without the written authorization of AGC. The test results presented in the report apply only to the tested sample. Any objections to report issued by AGC should be submitted to AGC within 15days after the issuance of the test report. Further enquiry of validity or verification of the test report should be addressed to AGC by agc@agc-cert.com.



SAR MEASUREMENT									
Depth of Liquid (cm):>15					Relative Humidity (%):50.9				
Product: Mobile phone									
Test Mode:802.11b									
Position	Mode	Ch.	Fr. (MHz)	Power Drift (<±5%)	SAR (1g) (W/kg)	Max. Tune-up Power (dBm)	Meas. output Power (dBm)	Scaled SAR (W/kg)	Limit (W/kg)
Left Cheek	DTS	01	2412	-0.13	0.196	10.80	10.71	0.200	1.6
Left Tilt	DTS	01	2412	-0.05	0.092	10.80	10.71	0.094	1.6
Right Cheek	DTS	01	2412	0.24	0.454	10.80	10.71	0.464	1.6
Right Tilt	DTS	01	2412	-0.16	0.228	10.80	10.71	0.233	1.6
Body back	DTS	01	2412	0.20	0.103	10.80	10.71	0.105	1.6
Body front	DTS	01	2412	-0.05	0.069	10.80	10.71	0.070	1.6
Edge 1 (Top)	DTS	01	2412	-0.27	0.030	10.80	10.71	0.031	1.6
Edge 4(Left)	DTS	01	2412	-0.08	0.063	10.80	10.71	0.064	1.6

Note:

- According to KDB248227, SAR is not required for 802.11n HT20/HT40 channels when the maximum average output power is less than 1/4 dB higher than that measured on the corresponding 802.11a/b channels.
- All of above "DTS" means data transmitters.
- The test separation for body back, body front and 4 Edges is 10mm of all above table.

Repeated SAR										
Product: Mobile phone										
Test Mode: GSM850										
Position	Mode	Ch.	Fr. (MHz)	Power Drift (<±5%)	Once SAR (1g) (W/kg)	Power Drift (<±5%)	Twice SAR (1g) (W/kg)	Power Drift (<±5%)	Third SAR (1g) (W/kg)	Limit W/kg
Body back	GPRS-3 slot	128	824.2	0.11	0.907	--	--	--	--	1.6

The second repeated SAR judge reference								
Product: Mobile phone								
Band	Position	Mode	Ch.	Fr. (MHz)	Original SAR (1g) (W/kg)	First SAR (1g) (W/kg)	Ratio	Limit
GSM850	Body back	GPRS-3 slot	128	824.2	0.921	0.907	1.015	<1.2

Any report having not been signed by authorized approver, or having been altered without authorization, or having not been stamped by the "Dedicated Testing/Inspection Stamp" is deemed to be invalid. Copying or excerpting portion of, or altering the content of the report is not permitted without the written authorization of AGC. The test results presented in the report apply only to the tested sample. Any objections to report issued by AGC should be submitted to AGC within 15days after the issuance of the test report. Further enquiry of validity or verification of the test report should be addressed to AGC by agc@agc-cert.com.



Simultaneous Multi-band Transmission Evaluation:
Application Simultaneous Transmission information:

NO	Simultaneous state	Portable Handset		
		Head	Body-worn	Hotspot
1	GSM(voice)+ WLAN 2.4GHz (data)	Yes	Yes	-
2	GSM(voice)+ Bluetooth(data)	-	Yes	-
3	GSM (Data) + WLAN 2.4GHz (data)	-	Yes	Yes
4	GSM (Data) + Bluetooth(data)	-	Yes	Yes
5	WCDMA+ WLAN 2.4GHz (data)	Yes	Yes	Yes
6	WCDMA+ Bluetooth(data)	-	Yes	Yes
7	LTE + WLAN 2.4GHz (data)	Yes	Yes	Yes
8	LTE + Bluetooth(data)	--	Yes	Yes

NOTE:

1. WIFI and BT share the same antenna, and cannot transmit simultaneously.
2. Simultaneous with every transmitter must be the same test position.
3. KDB 447498 D01, BT SAR is excluded as below table.
4. KDB 447498 D01, for handsets the test separation distance is determined by the smallest distance between the outer surface of the device and the user; which is 0mm for head SAR and 10mm for body-worn SAR.
5. According to KDB 447498 D01 4.3.1, Standalone SAR test exclusion is as follow:
For 100 MHz to 6 GHz and test separation distances ≤ 50 mm, the 1-g and 10-g SAR test exclusion thresholds are determined by the following:

$$[(\text{max. power of channel, including tune-up tolerance, mW}) / (\text{min. test separation distance, mm})] \cdot [\sqrt{f(\text{GHz})}] \leq 3.0$$
for 1-g SAR, and ≤ 7.5 for 10-g extremity SAR³⁰, where
 - f(GHz) is the RF channel transmit frequency in GHz
 - Power and distance are rounded to the nearest mW and mm before calculation³¹
 - The result is rounded to one decimal place for comparison
 - The values 3.0 and 7.5 are referred to as numeric thresholds in step b) below
The test exclusions are applicable only when the minimum test separation distance is ≤ 50 mm, and for transmission frequencies between 100 MHz and 6 GHz. When the minimum test separation distance is < 5 mm, a distance of 5 mm according to 4.1 f) is applied to determine SAR test exclusion.
6. If the test separation distance is < 5 mm, 5mm is used for excluded SAR calculation.
7. According to KDB 447498 D01 4.3.2, simultaneous transmission SAR test exclusion is as follow:
 - (1) Simultaneous transmission SAR test exclusion is determined for each operating configuration and exposure condition according to the reported standalone SAR of each applicable simultaneous transmitting antenna.
 - (2) Any transmitters and antennas should be considered when calculating simultaneous mode.
 - (3) For mobile phone and PC, it's the sum of all transmitters and antennas at the same mode with same position in each applicable exposure condition
 - (4) When the standalone SAR test exclusion of section 4.3.2 is applied to an antenna that transmits simultaneously with other antennas, the standalone SAR must be estimated according to the following to det
$$[(\text{max. power of channel, including tune-up tolerance, mW}) / (\text{min. test separation distance, mm})] \cdot [\sqrt{f(\text{GHz})/x}] \text{ W/kg}$$
for test separation distances ≤ 50 mm;
where $x = 7.5$ for 1-g SAR, and $x = 18.75$ for 10-g SAR.

Any report having not been signed by authorized approver, or having been altered without authorization, or having not been stamped by the "Dedicated Testing/Inspection Stamp" is deemed to be invalid. Copying or excerpting portion of, or altering the content of the report is not permitted without the written authorization of AGC. The test results presented in the report apply only to the tested sample. Any objections to report issued by AGC should be submitted to AGC within 15days after the issuance of the test report. Further enquiry of validity or verification of the test report should be addressed to AGC by agc@agc-cert.com.



8. When the sum of SAR is larger than the limit, SAR test exclusion is determined by the SAR to peak location separation ratio. The simultaneous transmitting antennas in each operating mode and exposure condition combination must be considered one pair at a time to determine the SAR to peak location separation ratio to qualify for test exclusion. The ratio is determined by $(SAR1 + SAR2)1.5/R_i$, rounded to two decimal digits, and must be ≤ 0.04 for all antenna pairs in the configuration to qualify for 1-g SAR test exclusion.

Estimated SAR		Max Power including Tune-up Tolerance		Separation Distance (mm)	Estimated SAR (W/kg)
		dBm	mW		
BT	Head	3	1.995	0	0.082
	Body	3	1.995	10	0.041

Any report having not been signed by authorized approver, or having been altered without authorization, or having not been stamped by the "Dedicated Testing/Inspection Stamp" is deemed to be invalid. Copying or excerpting portion of, or altering the content of the report is not permitted without the written authorization of AGC. The test results presented in the report apply only to the tested sample. Any objections to report issued by AGC should be submitted to AGC within 15 days after the issuance of the test report. Further enquiry of validity or verification of the test report should be addressed to AGC by agc@agc-cert.com.



Sum of the SAR for GSM 850 & Wi-Fi & BT:

RF Exposure Conditions	Test Position	Simultaneous Transmission Scenario			Σ1-g SAR (W/kg)	SPLSR (Yes/No)
		GSM 850	Wi-Fi DTS Band	Bluetooth		
Head (voice)	Left Touch	0.670	0.200		0.870	No
	Left Tilt	0.383	0.094		0.477	No
	Right Touch	0.710	0.464		1.174	No
	Right Tilt	0.353	0.233		0.586	No
Body-worn (voice)	Rear	0.670	0.105		0.775	No
		0.670		0.041	0.711	No
	Front	0.653	0.070		0.723	No
		0.653		0.041	0.694	No
Body-worn (Data)	Rear	0.930		0.041	0.971	No
		0.930	0.105		1.035	No
	Front	0.734		0.041	0.775	No
		0.734	0.070		0.804	No
Body-worn (Hotspot)	Edge 4	0.340	0.064		0.404	No
	Edge 4	0.340		0.041	0.381	No

Note:

- According to KDB 447498 D01 General RF Exposure Guidance, when the simultaneous transmission SAR is less than 1.6 W/kg, SPLSR assessment is not required.
- SPLSR mean is “The SAR to Peak Location Separation Ratio “

Any report having not been signed by authorized approver, or having been altered without authorization, or having not been stamped by the “Dedicated Testing/Inspection Stamp” is deemed to be invalid. Copying or excerpting portion of, or altering the content of the report is not permitted without the written authorization of AGC. The test results presented in the report apply only to the tested sample. Any objections to report issued by AGC should be submitted to AGC within 15 days after the issuance of the test report. Further enquiry of validity or verification of the test report should be addressed to AGC by agc@agc-cert.com.



Sum of the SAR for GSM 1900 & Wi-Fi & BT:

RF Exposure Conditions	Test Position	Simultaneous Transmission Scenario			Σ1-g SAR (W/kg)	SPLSR (Yes/No)
		PCS 1900	Wi-Fi DTS Band	Bluetooth		
Head (voice)	Left Touch	0.037	0.200		0.237	No
	Left Tilt	0.015	0.094		0.109	No
	Right Touch	0.048	0.464		0.512	No
	Right Tilt	0.016	0.233		0.249	No
Body-worn (voice)	Rear	0.060	0.105		0.165	No
		0.060		0.041	0.101	No
	Front	0.046	0.070		0.116	No
		0.046		0.041	0.087	No
Body-worn (Data)	Rear	0.109		0.041	0.150	No
		0.109	0.105		0.214	No
	Front	0.050		0.041	0.091	No
		0.050	0.070		0.120	No
Body-worn (Hotspot)	Edge 4	0.011	0.064		0.075	No
	Edge 4	0.011		0.041	0.052	No

Note:

- According to KDB 447498 D01 General RF Exposure Guidance, when the simultaneous transmission SAR is less than 1.6 W/kg, SPLSR assessment is not required.
- SPLSR mean is “The SAR to Peak Location Separation Ratio “

Any report having not been signed by authorized approver, or having been altered without authorization, or having not been stamped by the “Dedicated Testing/Inspection Stamp” is deemed to be invalid. Copying or excerpting portion of, or altering the content of the report is not permitted without the written authorization of AGC. The test results presented in the report apply only to the tested sample. Any objections to report issued by AGC should be submitted to AGC within 15 days after the issuance of the test report. Further enquiry of validity or verification of the test report should be addressed to AGC by agc@agc-cert.com.



Sum of the SAR for WCDMA Band II & Wi-Fi & BT:

RF Exposure Conditions	Test Position	Simultaneous Transmission Scenario			Σ1-g SAR (W/kg)	SPLSR (Yes/No)
		WCDMA Band II	Wi-Fi DTS Band	Bluetooth		
Head	Left Touch	0.059	0.200		0.259	No
	Left Tilt	0.018	0.094		0.112	No
	Right Touch	0.088	0.464		0.552	No
	Right Tilt	0.019	0.233		0.252	No
Body-worn	Rear	0.133	0.105		0.238	No
	Front	0.089	0.070		0.159	No
	Edge 4	0.014	0.064		0.078	No
	Rear	0.133		0.041	0.174	No
	Front	0.089		0.041	0.130	No
	Edge 4	0.014		0.041	0.055	No

Note:

- According to KDB 447498 D01 General RF Exposure Guidance, when the simultaneous transmission SAR is less than 1.6 W/kg, SPLSR assessment is not required.
- SPLSR mean is “The SAR to Peak Location Separation Ratio “

Any report having not been signed by authorized approver, or having been altered without authorization, or having not been stamped by the “Dedicated Testing/Inspection Stamp” is deemed to be invalid. Copying or excerpting portion of, or altering the content of the report is not permitted without the written authorization of AGC. The test results presented in the report apply only to the tested sample. Any objections to report issued by AGC should be submitted to AGC within 15 days after the issuance of the test report. Further enquiry of validity or verification of the test report should be addressed to AGC by agc@agc-cert.com.



Sum of the SAR for WCDMA Band V & Wi-Fi & BT:

RF Exposure Conditions	Test Position	Simultaneous Transmission Scenario			Σ1-g SAR (W/kg)	SPLSR (Yes/No)
		WCDMA Band V	Wi-Fi DTS Band	Bluetooth		
Head	Left Touch	0.600	0.200		0.800	No
	Left Tilt	0.320	0.094		0.414	No
	Right Touch	0.644	0.464		1.108	No
	Right Tilt	0.358	0.233		0.591	No
Body-worn	Rear	0.828	0.105		0.933	No
	Front	0.814	0.070		0.884	No
	Edge 4	0.412	0.064		0.476	No
	Rear	0.828		0.041	0.869	No
	Front	0.814		0.041	0.855	No
	Edge 4	0.412		0.041	0.453	No

Note:

- According to KDB 447498 D01 General RF Exposure Guidance, when the simultaneous transmission SAR is less than 1.6 W/kg, SPLSR assessment is not required.
- SPLSR mean is "The SAR to Peak Location Separation Ratio "

Any report having not been signed by authorized approver, or having been altered without authorization, or having not been stamped by the "Dedicated Testing/Inspection Stamp" is deemed to be invalid. Copying or excerpting portion of, or altering the content of the report is not permitted without the written authorization of AGC. The test results presented in the report apply only to the tested sample. Any objections to report issued by AGC should be submitted to AGC within 15 days after the issuance of the test report. Further enquiry of validity or verification of the test report should be addressed to AGC by agc@agc-cert.com.



Sum of the SAR for LTE Band 2 & Wi-Fi & BT:

RF Exposure Conditions	Test Position	Simultaneous Transmission Scenario			Σ1-g SAR (W/kg)	SPLSR (Yes/No)
		LTE Band 2	Wi-Fi DTS Band	Bluetooth		
1RB						
Head	Left Touch	0.055	0.200		0.255	No
	Left Tilt	0.019	0.094		0.113	No
	Right Touch	0.079	0.464		0.543	No
	Right Tilt	0.033	0.233		0.266	No
Body-worn	Rear	0.116	0.105		0.221	No
	Front	0.084	0.070		0.154	No
	Edge 4	0.014	0.064		0.078	No
	Rear	0.116		0.041	0.157	No
	Front	0.084		0.041	0.125	No
	Edge 4	0.014		0.041	0.055	No
50%RB						
Head	Left Touch	0.041	0.200		0.241	No
	Left Tilt	0.015	0.094		0.109	No
	Right Touch	0.064	0.464		0.528	No
	Right Tilt	0.025	0.233		0.258	No
Body-worn	Rear	0.097	0.105		0.202	No
	Front	0.064	0.070		0.134	No
	Edge 4	0.012	0.064		0.076	No
	Rear	0.097		0.041	0.138	No
	Front	0.064		0.041	0.105	No
	Edge 4	0.012		0.041	0.053	No

Note:

- According to KDB 447498 D01 General RF Exposure Guidance, when the simultaneous transmission SAR is less than 1.6 W/kg, SPLSR assessment is not required.
- SPLSR mean is "The SAR to Peak Location Separation Ratio "

Any report having not been signed by authorized approver, or having been altered without authorization, or having not been stamped by the "Dedicated Testing/Inspection Stamp" is deemed to be invalid. Copying or excerpting portion of, or altering the content of the report is not permitted without the written authorization of AGC. The test results presented in the report apply only to the tested sample. Any objections to report issued by AGC should be submitted to AGC within 15 days after the issuance of the test report. Further enquiry of validity or verification of the test report should be addressed to AGC by agc@agc-cert.com.



Sum of the SAR for LTE Band 4 & Wi-Fi & BT:

RF Exposure Conditions	Test Position	Simultaneous Transmission Scenario			Σ1-g SAR (W/kg)	SPLSR (Yes/No)	
		LTE Band 4	Wi-Fi DTS Band	Bluetooth			
1RB							
Head	Left Touch	0.055	0.200		0.255	No	
	Left Tilt	0.015	0.094		0.109	No	
	Right Touch	0.098	0.464		0.562	No	
	Right Tilt	0.021	0.233		0.254	No	
Body-worn	Rear	0.126	0.105		0.231	No	
	Front	0.084	0.070		0.154	No	
	Edge 4	0.014	0.064		0.078	No	
	Rear	0.126		0.041	0.167	No	
	Front	0.084		0.041	0.125	No	
	Edge 4	0.014		0.041	0.055	No	
	50%RB						
	Head	Left Touch	0.048	0.200		0.248	No
Left Tilt		0.015	0.094		0.109	No	
Right Touch		0.077	0.464		0.541	No	
Right Tilt		0.022	0.233		0.255	No	
Body-worn	Rear	0.081	0.105		0.186	No	
	Front	0.053	0.070		0.123	No	
	Edge 4	0.010	0.064		0.074	No	
	Rear	0.081		0.041	0.122	No	
	Front	0.053		0.041	0.094	No	
	Edge 4	0.010		0.041	0.051	No	

Note:

- According to KDB 447498 D01 General RF Exposure Guidance, when the simultaneous transmission SAR is less than 1.6 W/kg, SPLSR assessment is not required.
- SPLSR mean is "The SAR to Peak Location Separation Ratio "

Any report having not been signed by authorized approver, or having been altered without authorization, or having not been stamped by the "Dedicated Testing/Inspection Stamp" is deemed to be invalid. Copying or excerpting portion of, or altering the content of the report is not permitted without the written authorization of AGC. The test results presented in the report apply only to the tested sample. Any objections to report issued by AGC should be submitted to AGC within 15 days after the issuance of the test report. Further enquiry of validity or verification of the test report should be addressed to AGC by agc@agc-cert.com.



Sum of the SAR for LTE Band 66 & Wi-Fi & BT:

RF Exposure Conditions	Test Position	Simultaneous Transmission Scenario			Σ1-g SAR (W/kg)	SPLSR (Yes/No)	
		LTE Band 66	Wi-Fi DTS Band	Bluetooth			
1RB							
Head	Left Touch	0.025	0.200		0.225	No	
	Left Tilt	0.007	0.094		0.101	No	
	Right Touch	0.026	0.464		0.490	No	
	Right Tilt	0.010	0.233		0.243	No	
Body-worn	Rear	0.080	0.105		0.185	No	
	Front	0.054	0.070		0.124	No	
	Edge 4	0.008	0.064		0.072	No	
	Rear	0.080		0.041	0.121	No	
	Front	0.054		0.041	0.095	No	
	Edge 4	0.008		0.041	0.049	No	
	50%RB						
	Head	Left Touch	0.019	0.200		0.219	No
Left Tilt		0.009	0.094		0.103	No	
Right Touch		0.029	0.464		0.493	No	
Right Tilt		0.011	0.233		0.244	No	
Body-worn	Rear	0.051	0.105		0.156	No	
	Front	0.040	0.070		0.110	No	
	Edge 4	0.006	0.064		0.070	No	
	Rear	0.051		0.041	0.092	No	
	Front	0.040		0.041	0.081	No	
	Edge 4	0.006		0.041	0.047	No	

Note:

- According to KDB 447498 D01 General RF Exposure Guidance, when the simultaneous transmission SAR is less than 1.6 W/kg, SPLSR assessment is not required.
- SPLSR mean is "The SAR to Peak Location Separation Ratio "

Any report having not been signed by authorized approver, or having been altered without authorization, or having not been stamped by the "Dedicated Testing/Inspection Stamp" is deemed to be invalid. Copying or excerpting portion of, or altering the content of the report is not permitted without the written authorization of AGC. The test results presented in the report apply only to the tested sample. Any objections to report issued by AGC should be submitted to AGC within 15 days after the issuance of the test report. Further enquiry of validity or verification of the test report should be addressed to AGC by agc@agc-cert.com.



APPENDIX A. SAR SYSTEM CHECK DATA

Test Laboratory: AGC Lab

Date: Jul. 01,2021

System Check Head 835 MHz

DUT: Dipole 835 MHz Type: SID 835

Communication System CW; Communication System Band: D835 (835.0 MHz); Duty Cycle: 1:1; Conv.F=5.24

Frequency: 835 MHz; Medium parameters used: $f = 835$ MHz; $\sigma=0.92$ mho/m; $\epsilon_r = 41.64$; $\rho = 1000$ kg/m³ ;

Phantom section: Flat Section; Input Power=18dBm

Ambient temperature (°C):21.5, Liquid temperature (°C): 21.3

SATIMO Configuration:

- Probe: SSE5; Calibrated: Dec. 17,2020; Serial No.: SN 03/18 EP327
- Sensor-Surface: 4mm (Mechanical Surface Detection)
- Phantom: SAM twin phantom
- Measurement SW: OpenSAR V4_02_35

Configuration/System Check 835MHz Head/Area Scan: Measurement grid: dx=8mm, dy=8mm

Configuration/System Check 835MHz Head/Zoom Scan: Measurement grid: dx=8mm,dy=8mm, dz=5mm

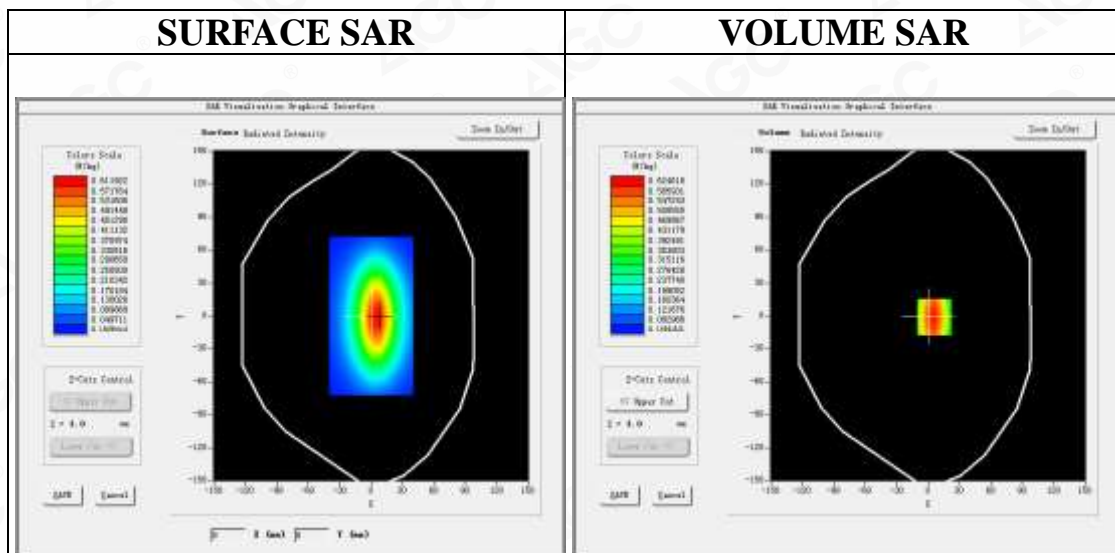

Maximum location: X=6.00, Y=-1.00

SAR Peak: 0.89 W/kg

SAR 10g (W/Kg)	0.393985
SAR 1g (W/Kg)	0.609124

Any report having not been signed by authorized approver, or having been altered without authorization, or having not been stamped by the "Dedicated Testing/Inspection Stamp" is deemed to be invalid. Copying or excerpting portion of, or altering the content of the report is not permitted without the written authorization of AGC. The test results presented in the report apply only to the tested sample. Any objections to report issued by AGC should be submitted to AGC within 15days after the issuance of the test report. Further enquiry of validity or verification of the test report should be addressed to AGC by agc@agc-cert.com.

Attestation of Global Compliance(Shenzhen)Co., Ltd

Attestation of Global Compliance(Shenzhen)Std & Tech Co., Ltd

Tel: +86-755 2523 4088 E-mail: agc@agc-cert.com Web: http://cn.agc-cert.com/



Z (mm)	0.00	4.00	9.00	14.00	19.00	24.00	29.00
SAR (W/Kg)	0.8917	0.6228	0.4036	0.2682	0.1774	0.1236	0.0872

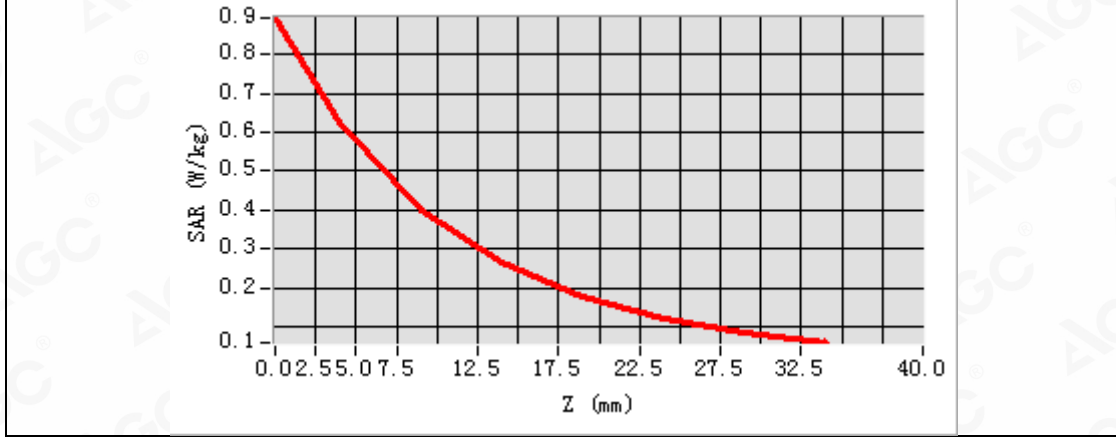

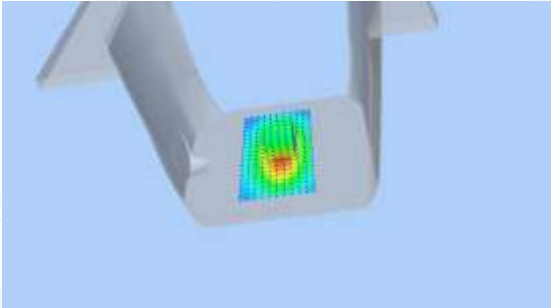
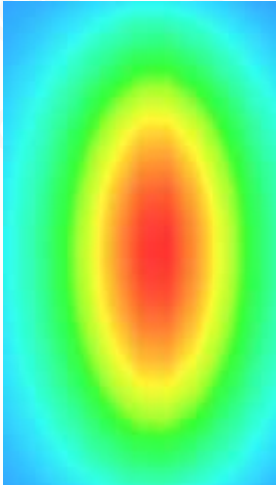
3D screen shot	Hot spot position
	

Any report having not been signed by authorized approver, or having been altered without authorization, or having not been stamped by the "Dedicated Testing/Inspection Stamp" is deemed to be invalid. Copying or excerpting portion of, or altering the content of the report is not permitted without the written authorization of AGC. The test results presented in the report apply only to the tested sample. Any objections to report issued by AGC should be submitted to AGC within 15 days after the issuance of the test report. Further enquiry of validity or verification of the test report should be addressed to AGC by agc@agc-cert.com.



Test Laboratory: AGC Lab
System Check Head 1750MHz

Date: Jul. 05,2021

DUT: Dipole 1800 MHz; Type: SID 1800

Communication System: CW; Communication System Band: D1700 (1750.0 MHz); Duty Cycle:1:1; Conv.F=4.56
Frequency: 1750 MHz; Medium parameters used: $f = 1750\text{MHz}$; $\sigma = 1.38 \text{ mho/m}$; $\epsilon_r = 39.82$; $\rho = 1000 \text{ kg/m}^3$;
Phantom section: Flat Section; Input Power=18dBm
Ambient temperature ($^{\circ}\text{C}$): 21.4, Liquid temperature ($^{\circ}\text{C}$): 21.2

SATIMO Configuration:

Probe: SSE5; Calibrated: Dec. 17,2020; Serial No.: SN 03/18 EP327

- Sensor-Surface: 4mm (Mechanical Surface Detection)
- Phantom: SAM twin phantom
- Measurement SW: OpenSAR V4_02_35

Configuration/System Check 1750MHz Head/Area Scan: Measurement grid: dx=8mm,dy=8mm

Configuration/System Check 1750MHz Head/Zoom Scan: Measurement grid: dx=8mm,dy=8mm, dz=5mm

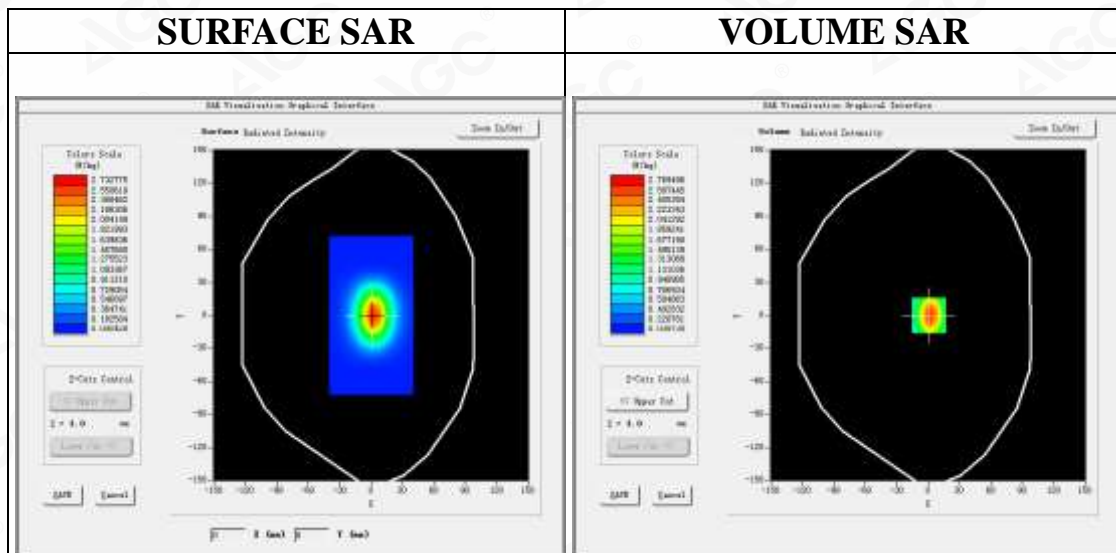

Maximum location: X=1.00, Y=0.00

SAR Peak: 4.52 W/kg

SAR 10g (W/Kg)	1.321824
SAR 1g (W/Kg)	2.583476

Any report having not been signed by authorized approver, or having been altered without authorization, or having not been stamped by the "Dedicated Testing/Inspection Stamp" is deemed to be invalid. Copying or excerpting portion of, or altering the content of the report is not permitted without the written authorization of AGC. The test results presented in the report apply only to the tested sample. Any objections to report issued by AGC should be submitted to AGC within 15days after the issuance of the test report. Further enquiry of validity or verification of the test report should be addressed to AGC by agc@agc-cert.com.

Attestation of Global Compliance(Shenzhen)Co., Ltd

Attestation of Global Compliance(Shenzhen)Std & Tech Co., Ltd

Tel: +86-755 2523 4088 E-mail: agc@agc-cert.com Web: http://cn.agc-cert.com/



Z (mm)	0.00	4.00	9.00	14.00	19.00	24.00	29.00
SAR (W/Kg)	4.5314	2.7683	1.4474	0.7936	0.4437	0.2474	0.1425

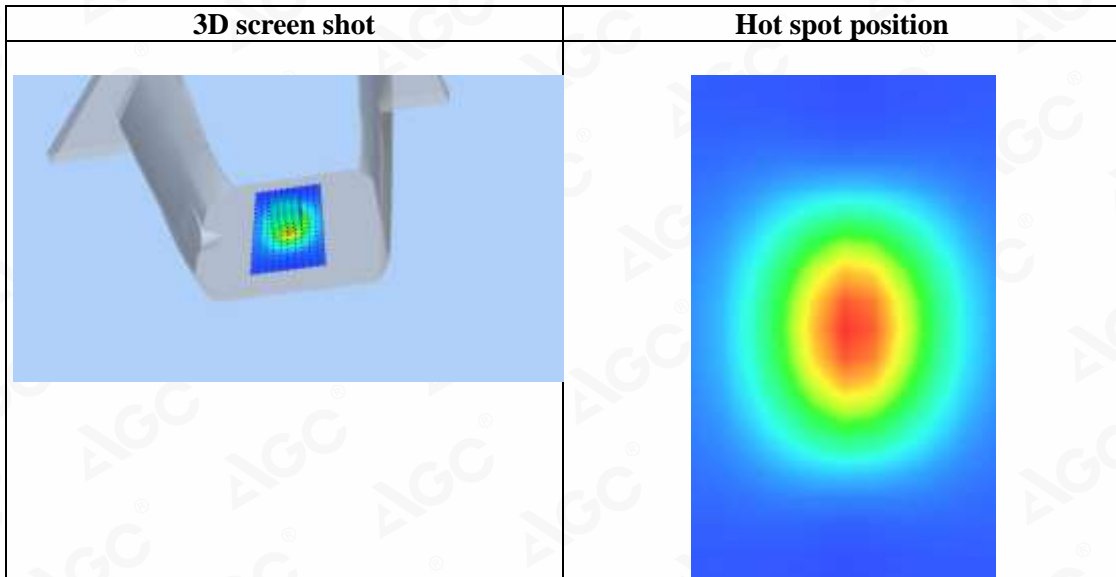
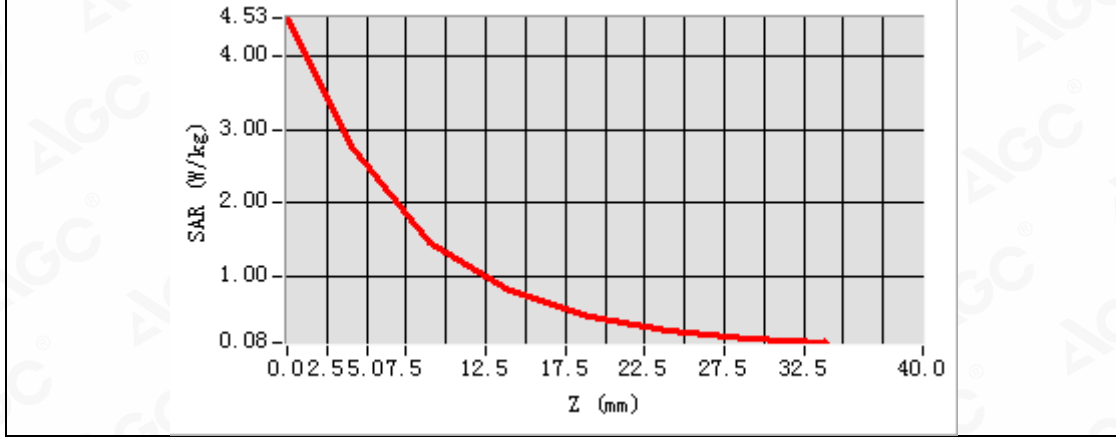

Any report having not been signed by authorized approver, or having been altered without authorization, or having not been stamped by the "Dedicated Testing/Inspection Stamp" is deemed to be invalid. Copying or excerpting portion of, or altering the content of the report is not permitted without the written authorization of AGC. The test results presented in the report apply only to the tested sample. Any objections to report issued by AGC should be submitted to AGC within 15days after the issuance of the test report. Further enquiry of validity or verification of the test report should be addressed to AGC by agc@agc-cert.com.



Test Laboratory: AGC Lab
System Check Head 1900MHz

Date: Jul. 02,2021

DUT: Dipole 1900 MHz; Type: SID 1900

Communication System: CW; Communication System Band: D1900 (1900.0 MHz); Duty Cycle:1:1; Conv.F=4.48
Frequency: 1900 MHz; Medium parameters used: $f = 1800$ MHz; $\sigma = 1.37$ mho/m; $\epsilon_r = 38.51$; $\rho = 1000$ kg/m³ ;
Phantom section: Flat Section; Input Power=18dBm
Ambient temperature (°C):20.9, Liquid temperature (°C): 20.7

SATIMO Configuration:

Probe: SSE5; Calibrated: Dec. 17,2020; Serial No.: SN 03/18 EP327

- Sensor-Surface: 4mm (Mechanical Surface Detection)
- Phantom: SAM twin phantom
- Measurement SW: OpenSAR V4_02_35

Configuration/System Check 1900MHz Head/Area Scan: Measurement grid: dx=8mm, dy=8mm

Configuration/System Check 1900MHz Head/Zoom Scan: Measurement grid: dx=8mm,dy=8mm, dz=5mm

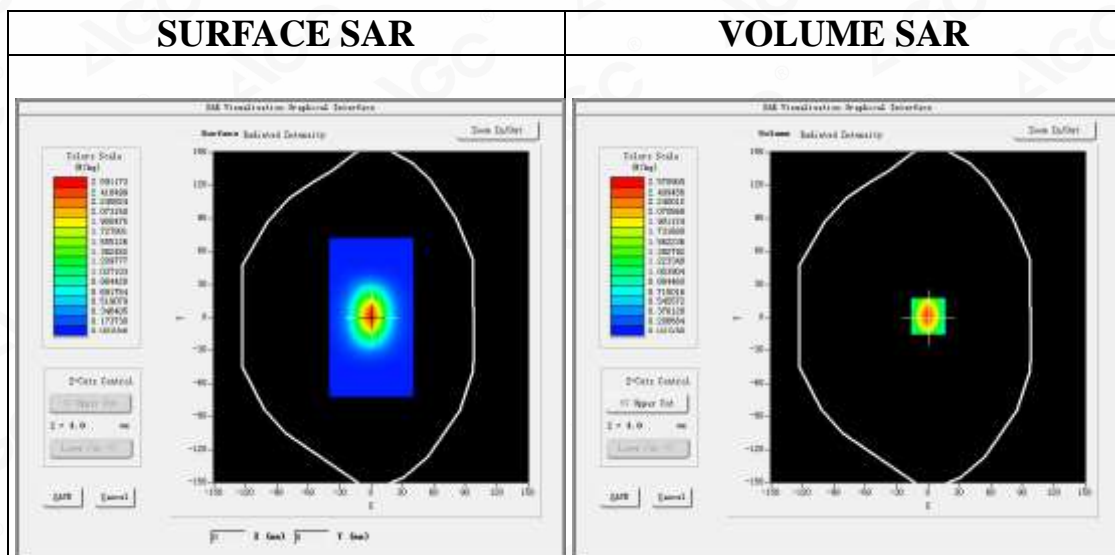

Maximum location: X=0.00, Y=1.00

SAR Peak: 4.13 W/kg

SAR 10g (W/Kg)	1.221872
SAR 1g (W/Kg)	2.422735

Any report having not been signed by authorized approver, or having been altered without authorization, or having not been stamped by the "Dedicated Testing/Inspection Stamp" is deemed to be invalid. Copying or excerpting portion of, or altering the content of the report is not permitted without the written authorization of AGC. The test results presented in the report apply only to the tested sample. Any objections to report issued by AGC should be submitted to AGC within 15days after the issuance of the test report. Further enquiry of validity or verification of the test report should be addressed to AGC by agc@agc-cert.com.

Attestation of Global Compliance(Shenzhen)Co., Ltd

Attestation of Global Compliance(Shenzhen)Std & Tech Co., Ltd

Tel: +86-755 2523 4088 E-mail: agc@agc-cert.com Web: http://cn.agc-cert.com/



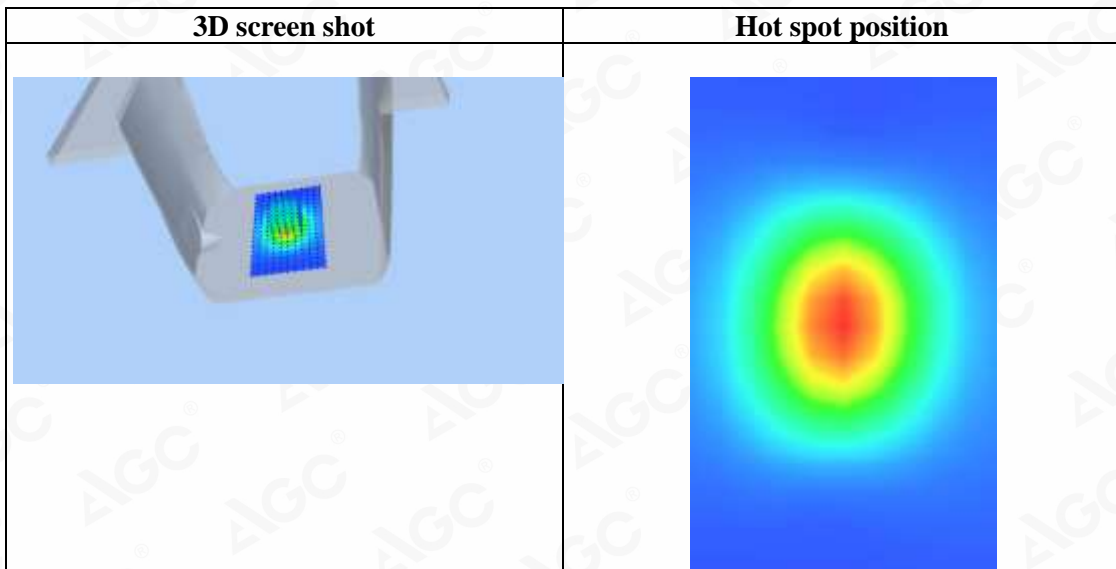
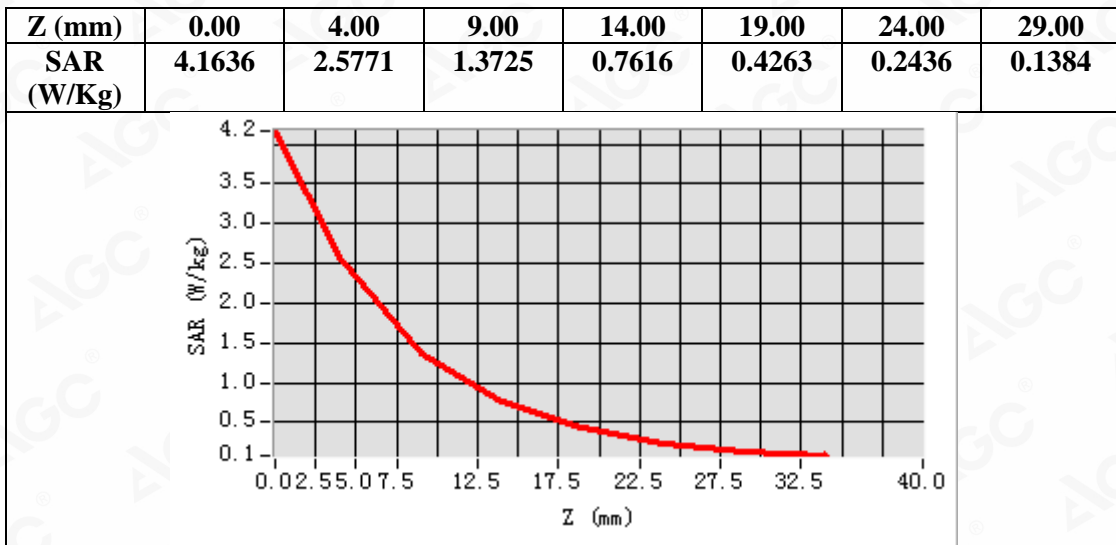

Any report having not been signed by authorized approver, or having been altered without authorization, or having not been stamped by the "Dedicated Testing/Inspection Stamp" is deemed to be invalid. Copying or excerpting portion of, or altering the content of the report is not permitted without the written authorization of AGC. The test results presented in the report apply only to the tested sample. Any objections to report issued by AGC should be submitted to AGC within 15 days after the issuance of the test report. Further enquiry of validity or verification of the test report should be addressed to AGC by agc@agc-cert.com.



Test Laboratory: AGC Lab
System Check Head 1900MHz
DUT: Dipole 1900 MHz; Type: SID 1900

Date: Jul. 04,2021

Communication System: CW; Communication System Band: D1900 (1900.0 MHz); Duty Cycle:1:1; Conv.F=4.48
Frequency: 1900 MHz; Medium parameters used: $f = 1800$ MHz; $\sigma = 1.41$ mho/m; $\epsilon_r = 40.13$; $\rho = 1000$ kg/m³ ;
Phantom section: Flat Section; Input Power=18dBm
Ambient temperature (°C):20.5, Liquid temperature (°C): 20.3

SATIMO Configuration:

Probe: SSE5; Calibrated: Dec. 17,2020; Serial No.: SN 03/18 EP327

- Sensor-Surface: 4mm (Mechanical Surface Detection)
- Phantom: SAM twin phantom
- Measurement SW: OpenSAR V4_02_35

Configuration/System Check 1900MHz Head/Area Scan: Measurement grid: dx=8mm, dy=8mm

Configuration/System Check 1900MHz Head/Zoom Scan: Measurement grid: dx=8mm,dy=8mm, dz=5mm

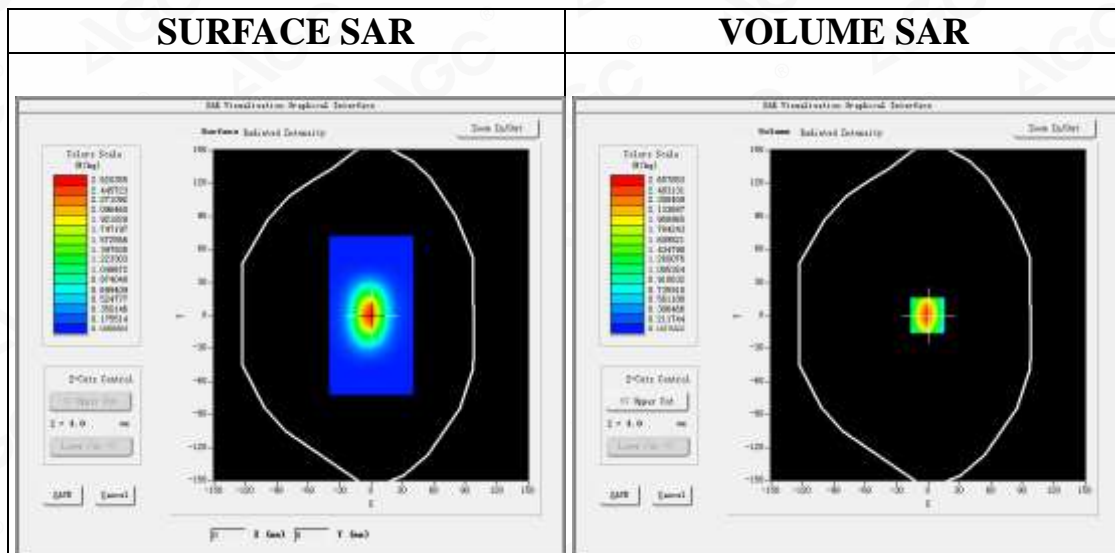

Maximum location: X=-1.00, Y=0.00

SAR Peak: 4.32 W/kg

SAR 10g (W/Kg)	1.257243
SAR 1g (W/Kg)	2.498784



Any report having not been signed by authorized approver, or having been altered without authorization, or having not been stamped by the "Dedicated Testing/Inspection Stamp" is deemed to be invalid. Copying or excerpting portion of, or altering the content of the report is not permitted without the written authorization of AGC. The test results presented in the report apply only to the tested sample. Any objections to report issued by AGC should be submitted to AGC within 15days after the issuance of the test report. Further enquiry of validity or verification of the test report should be addressed to AGC by agc@agc-cert.com.

Attestation of Global Compliance(Shenzhen)Co., Ltd
Attestation of Global Compliance(Shenzhen)Std & Tech Co., Ltd
Tel: +86-755 2523 4088 E-mail: agc@agc-cert.com Web: http://cn.agc-cert.com/

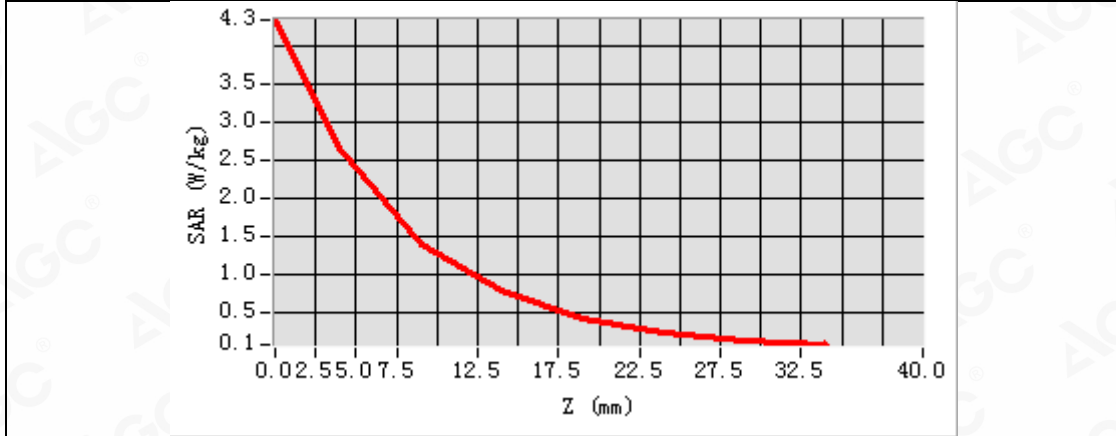

Z (mm)	0.00	4.00	9.00	14.00	19.00	24.00	29.00
SAR (W/Kg)	4.3272	2.6563	1.4025	0.7742	0.4358	0.2473	0.1424

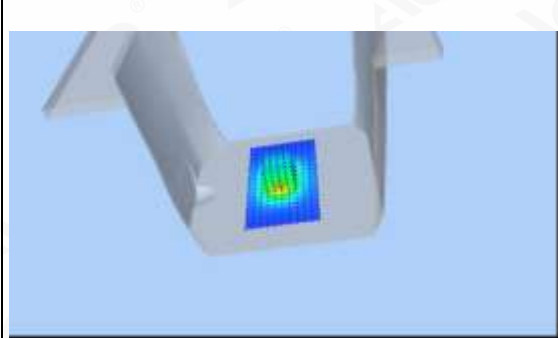

3D screen shot	Hot spot position
	

Any report having not been signed by authorized approver, or having been altered without authorization, or having not been stamped by the "Dedicated Testing/Inspection Stamp" is deemed to be invalid. Copying or excerpting portion of, or altering the content of the report is not permitted without the written authorization of AGC. The test results presented in the report apply only to the tested sample. Any objections to report issued by AGC should be submitted to AGC within 15 days after the issuance of the test report. Further enquiry of validity or verification of the test report should be addressed to AGC by agc@agc-cert.com.



Test Laboratory: AGC Lab
System Check Head 2450 MHz

Date: Jul. 03,2021

DUT: Dipole 2450 MHz Type: SID 2450

Communication System CW; Communication System Band: D2450 (2450.0 MHz); Duty Cycle: 1:1; Conv.F=4.32
Frequency: 2450 MHz; Medium parameters used: $f = 2450$ MHz; $\sigma=1.76$ mho/m; $\epsilon_r = 39.96$; $\rho= 1000$ kg/m³ ;
Phantom section: Flat Section; Input Power=18dBm
Ambient temperature (°C):20.7, Liquid temperature (°C): 20.5

SATIMO Configuration

- Probe: SSE5; Calibrated: Dec. 17,2020; Serial No.: SN 03/18 EP327
- Sensor-Surface: 4mm (Mechanical Surface Detection)
- Phantom: SAM twin phantom
- Measurement SW: OpenSAR V4_02_35

Configuration/System Check 2450MHz Head/Area Scan: Measurement grid: dx=8mm, dy=8mm

Configuration/System Check 2450MHz Head/Zoom Scan: Measurement grid: dx=5mm,dy=5mm, dz=5mm

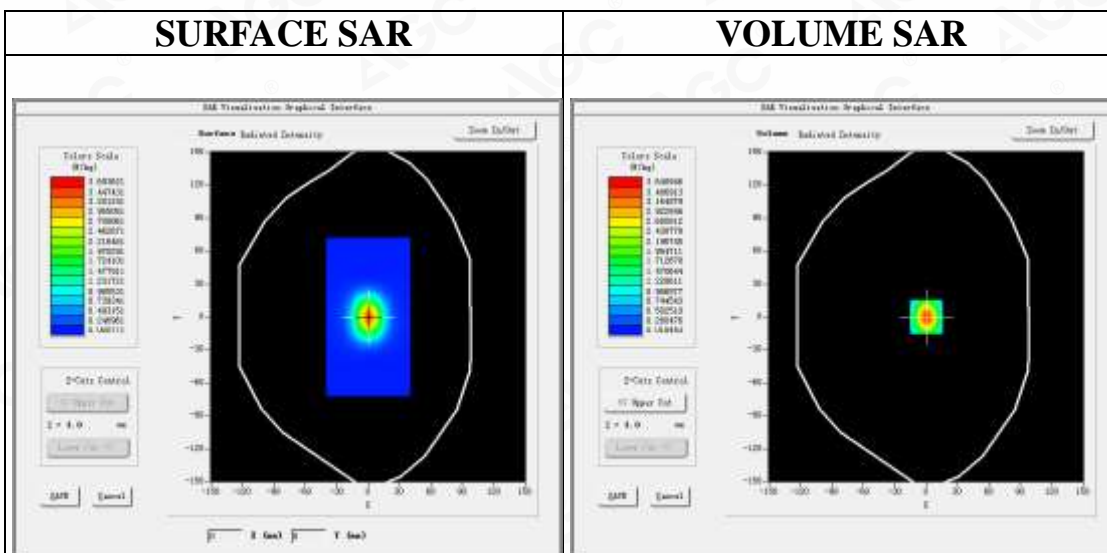

Maximum location: X=0.00, Y=0.00

SAR Peak: 6.28 W/kg

SAR 10g (W/Kg)	1.492874
SAR 1g (W/Kg)	3.335972

Any report having not been signed by authorized approver, or having been altered without authorization, or having not been stamped by the "Dedicated Testing/Inspection Stamp" is deemed to be invalid. Copying or excerpting portion of, or altering the content of the report is not permitted without the written authorization of AGC. The test results presented in the report apply only to the tested sample. Any objections to report issued by AGC should be submitted to AGC within 15 days after the issuance of the test report. Further enquiry of validity or verification of the test report should be addressed to AGC by agc@agc-cert.com.

Attestation of Global Compliance(Shenzhen)Co., Ltd
Attestation of Global Compliance(Shenzhen)Std & Tech Co., Ltd
Tel: +86-755 2523 4088 E-mail: agc@agc-cert.com Web: http://cn.agc-cert.com/



Z (mm)	0.00	4.00	9.00	14.00	19.00	24.00	29.00
SAR (W/Kg)	6.3658	3.6472	1.6936	0.8125	0.3946	0.1937	0.0972

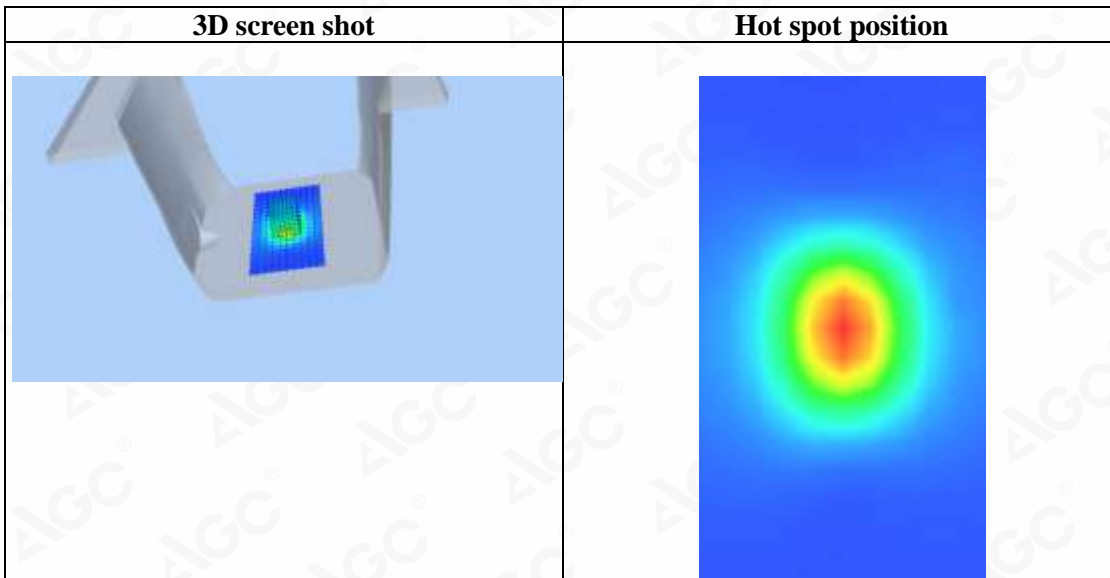
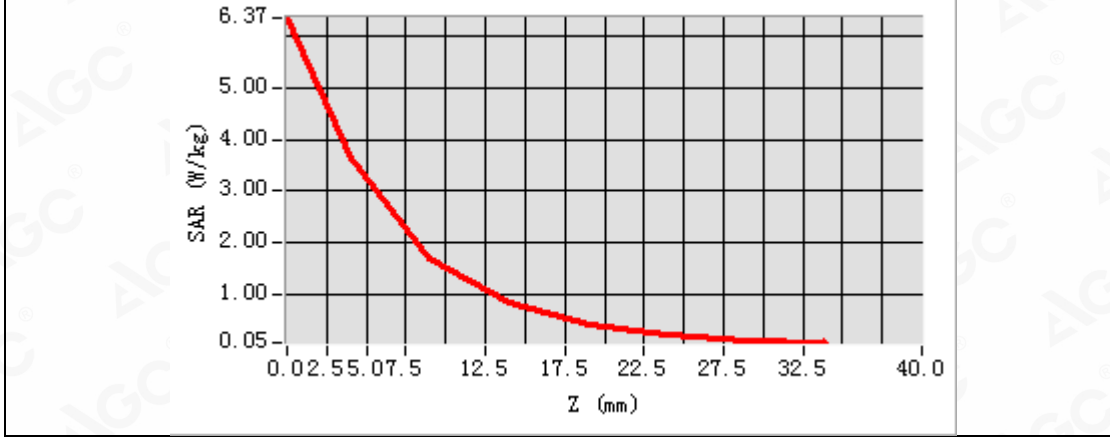

Any report having not been signed by authorized approver, or having been altered without authorization, or having not been stamped by the "Dedicated Testing/Inspection Stamp" is deemed to be invalid. Copying or excerpting portion of, or altering the content of the report is not permitted without the written authorization of AGC. The test results presented in the report apply only to the tested sample. Any objections to report issued by AGC should be submitted to AGC within 15 days after the issuance of the test report. Further enquiry of validity or verification of the test report should be addressed to AGC by agc@agc-cert.com.



APPENDIX B. SAR MEASUREMENT DATA

Test Laboratory: AGC Lab
GSM 850 Mid-Touch-Right <SIM 1>
DUT: Mobile phone; Type: P40

Date: Jul. 01,2021

Communication System: Generic GSM; Communication System Band: GSM 850; Duty Cycle: 1:8.3; Conv.F=5.24;
Frequency: 836.6 MHz; Medium parameters used: $f = 835$ MHz; $\sigma = 0.93$ mho/m; $\epsilon_r = 40.41$; $\rho = 1000$ kg/m³ ;
Phantom section: Right Section
Ambient temperature (°C): 21.5, Liquid temperature (°C): 21.3

SATIMO Configuration:

- Probe: SSE5; Calibrated: Dec. 17,2020; Serial No.: SN 03/18 EP327
- Sensor-Surface: 4mm (Mechanical Surface Detection)
- Phantom: SAM twin phantom
- Measurement SW: OpenSAR V4_02_35

Configuration/GSM 850 Mid-Touch-Right/Area Scan: Measurement grid: dx=8mm, dy=8mm
Configuration/GSM 850 Mid-Touch-Right/Zoom Scan: Measurement grid: dx=8mm,dy=8mm, dz=5mm;

Area Scan	dx=8mm dy=8mm, h= 5.00 mm
ZoomScan	5x5x7,dx=8mm dy=8mm dz=5mm,Complete
Phantom	Right head
Device Position	Cheek
Band	GSM 850
Channels	Middle
Signal	TDMA (Crest factor: 8.0)

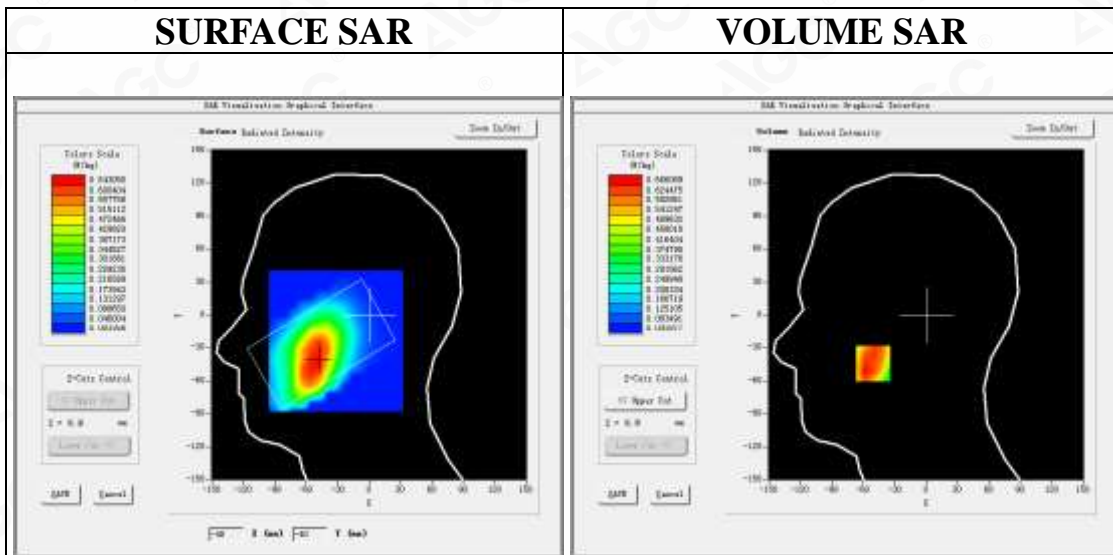

Maximum location: X=-51.00, Y=-44.00
SAR Peak: 1.03 W/kg

SAR 10g (W/Kg)	0.437833
SAR 1g (W/Kg)	0.658267

Any report having not been signed by authorized approver, or having been altered without authorization, or having not been stamped by the "Dedicated Testing/Inspection Stamp" is deemed to be invalid. Copying or excerpting portion of, or altering the content of the report is not permitted without the written authorization of AGC. The test results presented in the report apply only to the tested sample. Any objections to report issued by AGC should be submitted to AGC within 15days after the issuance of the test report. Further enquiry of validity or verification of the test report should be addressed to AGC by agc@agc-cert.com.



Z (mm)	0.00	4.00	9.00	14.00	19.00	24.00	29.00
SAR (W/Kg)	0.9230	0.6661	0.4500	0.2818	0.2485	0.1334	0.1336

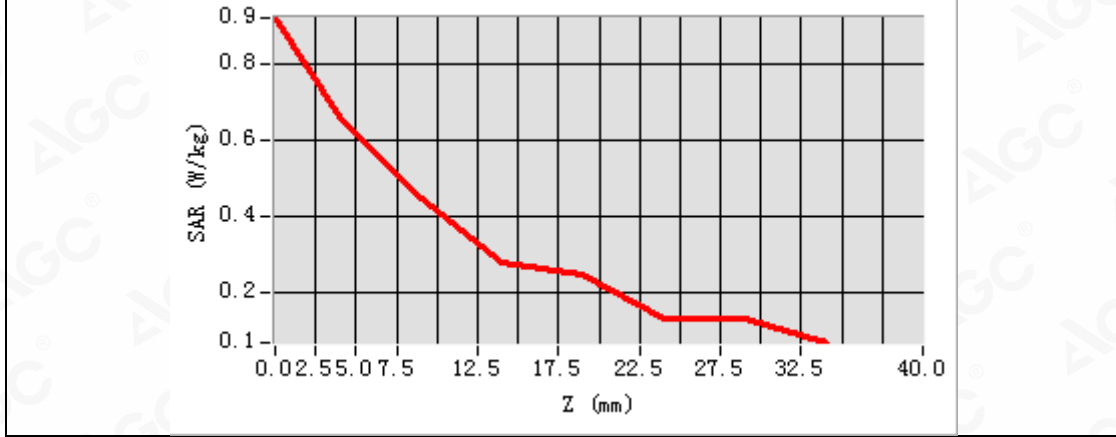

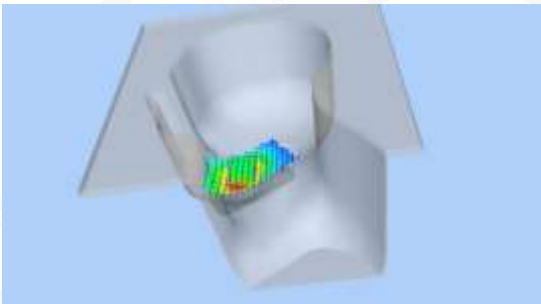
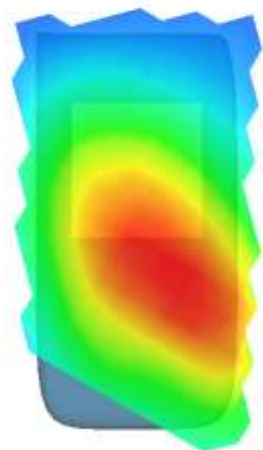
3D screen shot	Hot spot position
	

Any report having not been signed by authorized approver, or having been altered without authorization, or having not been stamped by the "Dedicated Testing/Inspection Stamp" is deemed to be invalid. Copying or excerpting portion of, or altering the content of the report is not permitted without the written authorization of AGC. The test results presented in the report apply only to the tested sample. Any objections to report issued by AGC should be submitted to AGC within 15 days after the issuance of the test report. Further enquiry of validity or verification of the test report should be addressed to AGC by agc@agc-cert.com.



Test Laboratory: AGC Lab
GSM 850 Mid- Body- Back (MS)<SIM 1>
DUT: Mobile phone; Type: P40

Date: Jul. 01,2021

Communication System: Generic GSM; Communication System Band: GSM 850; Duty Cycle: 1:8.3; Conv.F=5.24;
Frequency: 836.6 MHz; Medium parameters used: $f = 835$ MHz; $\sigma = 0.93$ mho/m; $\epsilon_r = 40.41$; $\rho = 1000$ kg/m³ ;
Phantom section: Flat Section
Ambient temperature (°C): 21.5, Liquid temperature (°C): 21.3

SATIMO Configuration:

- Probe: SSE5; Calibrated: Dec. 17,2020; Serial No.: SN 03/18 EP327
- Sensor-Surface: 4mm (Mechanical Surface Detection)
- Phantom: SAM twin phantom
- Measurement SW: OpenSAR V4_02_35

Configuration/GSM 850 Mid-Body-Back/Area Scan: Measurement grid: dx=8mm, dy=8mm
Configuration/GSM 850 Mid-Body-Back/Zoom Scan: Measurement grid: dx=8mm, dy=8mm, dz=5mm;

Area Scan	surf_sam_plan.txt, h= 5.00 mm
ZoomScan	5x5x7,dx=8mm dy=8mm dz=5mm,Complete
Phantom	Validation plane
Device Position	Body Back
Band	GSM 850
Channels	Middle
Signal	TDMA (Crest factor: 8.0)

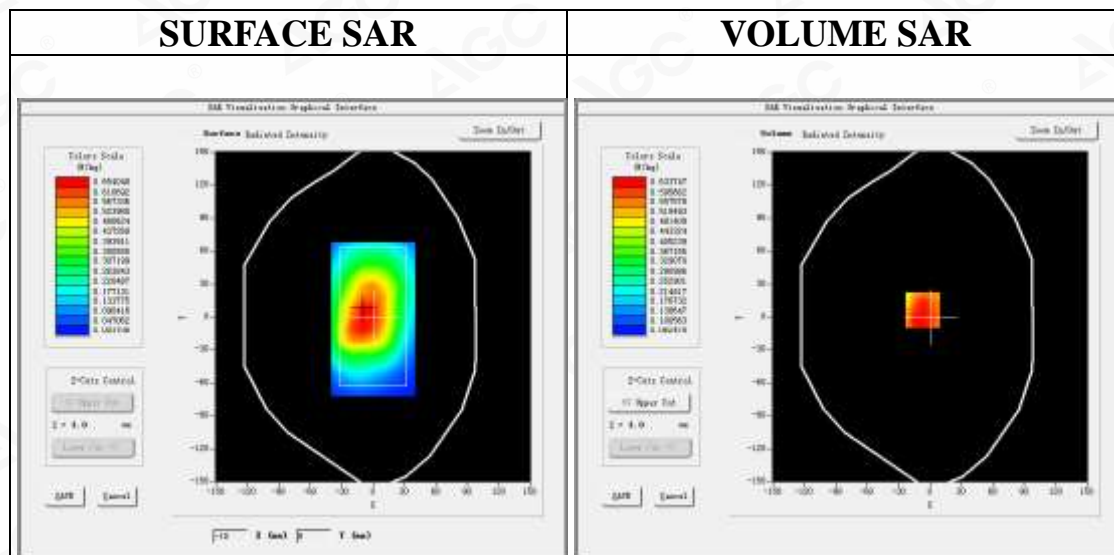

Maximum location: X=-7.00, Y=6.00
SAR Peak: 0.85 W/kg

SAR 10g (W/Kg)	0.449432
SAR 1g (W/Kg)	0.620755

Any report having not been signed by authorized approver, or having been altered without authorization, or having not been stamped by the "Dedicated Testing/Inspection Stamp" is deemed to be invalid. Copying or excerpting portion of, or altering the content of the report is not permitted without the written authorization of AGC. The test results presented in the report apply only to the tested sample. Any objections to report issued by AGC should be submitted to AGC within 15days after the issuance of the test report. Further enquiry of validity or verification of the test report should be addressed to AGC by agc@agc-cert.com.



Z (mm)	0.00	4.00	9.00	14.00	19.00	24.00	29.00
SAR (W/Kg)	0.8529	0.6337	0.4528	0.3309	0.2895	0.1826	0.1674

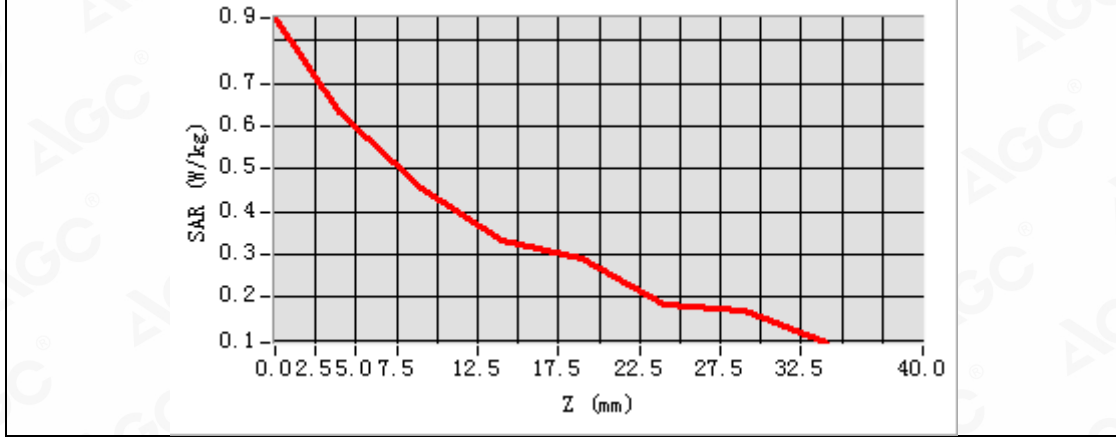

3D screen shot	Hot spot position
	

Any report having not been signed by authorized approver, or having been altered without authorization, or having not been stamped by the "Dedicated Testing/Inspection Stamp" is deemed to be invalid. Copying or excerpting portion of, or altering the content of the report is not permitted without the written authorization of AGC. The test results presented in the report apply only to the tested sample. Any objections to report issued by AGC should be submitted to AGC within 15days after the issuance of the test report. Further enquiry of validity or verification of the test report should be addressed to AGC by agc@agc-cert.com.



Test Laboratory: AGC Lab
GPRS 850 Low- Body- Back (3up)
DUT: Mobile phone; Type: P40

Date: Jul. 01,2021

Communication System: GPRS-3 Slot; Communication System Band: GSM 850; Duty Cycle: 1:2.7; Conv.F=5.24;
Frequency: 824.2 MHz; Medium parameters used: $f = 835$ MHz; $\sigma = 0.88$ mho/m; $\epsilon_r = 42.52$; $\rho = 1000$ kg/m³ ;
Phantom section: Flat Section
Ambient temperature (°C): 21.5, Liquid temperature (°C): 21.3

SATIMO Configuration:

- Probe: SSE5; Calibrated: Dec. 17,2020; Serial No.: SN 03/18 EP327
- Sensor-Surface: 4mm (Mechanical Surface Detection)
- Phantom: SAM twin phantom
- Measurement SW: OpenSAR V4_02_35

Configuration/GPRS 850 Low -Body-Back/Area Scan: Measurement grid: dx=8mm, dy=8mm
Configuration/GPRS 850 Low -Body-Back/Zoom Scan: Measurement grid: dx=8mm, dy=8mm, dz=5mm;

Area Scan	surf_sam_plan.txt, h= 5.00 mm
Zoom Scan	5x5x7,dx=8mm dy=8mm dz=5mm,Complete
Phantom	Validation plane
Device Position	Body Back
Band	GSM 850
Channels	Low
Signal	TDMA (Crest factor: 2.7)

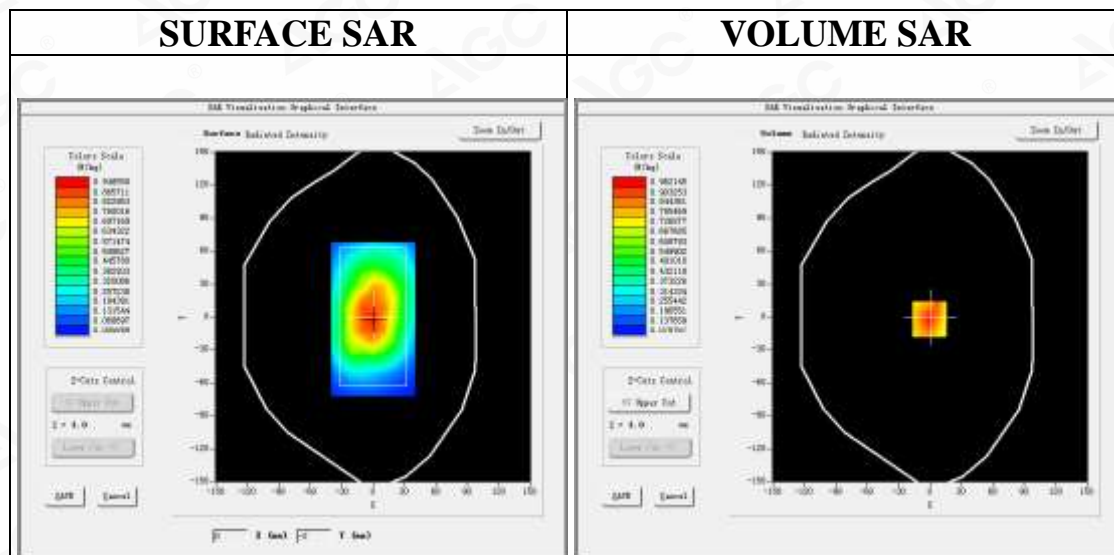

Maximum location: X=-1.00, Y=-2.00
SAR Peak: 1.34 W/kg

SAR 10g (W/Kg)	0.631023
SAR 1g (W/Kg)	0.921206

Any report having not been signed by authorized approver, or having been altered without authorization, or having not been stamped by the "Dedicated Testing/Inspection Stamp" is deemed to be invalid. Copying or excerpting portion of, or altering the content of the report is not permitted without the written authorization of AGC. The test results presented in the report apply only to the tested sample. Any objections to report issued by AGC should be submitted to AGC within 15days after the issuance of the test report. Further enquiry of validity or verification of the test report should be addressed to AGC by agc@agc-cert.com.



Z (mm)	0.00	4.00	9.00	14.00	19.00	24.00	29.00
SAR (W/Kg)	1.2068	0.9621	0.7050	0.5347	0.3703	0.2855	0.2101

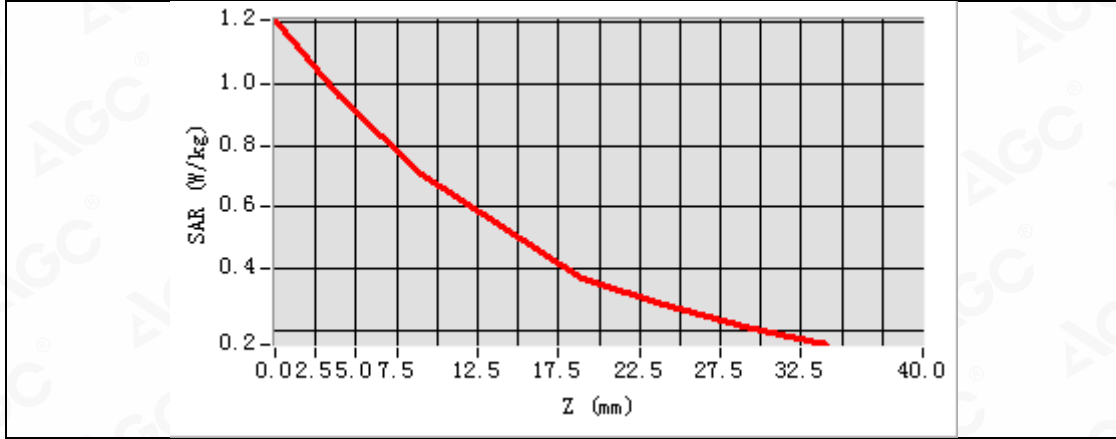

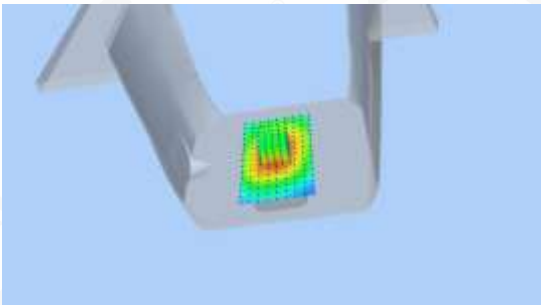
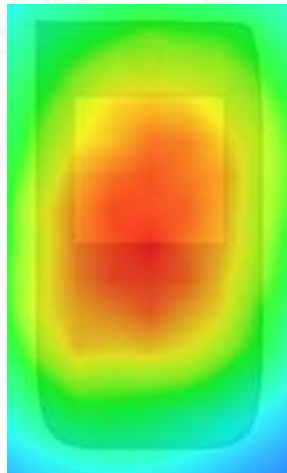
3D screen shot	Hot spot position
	

Any report having not been signed by authorized approver, or having been altered without authorization, or having not been stamped by the "Dedicated Testing/Inspection Stamp" is deemed to be invalid. Copying or excerpting portion of, or altering the content of the report is not permitted without the written authorization of AGC. The test results presented in the report apply only to the tested sample. Any objections to report issued by AGC should be submitted to AGC within 15days after the issuance of the test report. Further enquiry of validity or verification of the test report should be addressed to AGC by agc@agc-cert.com.



Test Laboratory: AGC Lab
PCS 1900 Mid-Touch-Right <SIM 1>
DUT: Mobile phone; Type: P40

Date: Jul. 02,2021

Communication System: Generic GSM; Communication System Band: PCS 1900; Duty Cycle: 1:8.3; Conv.F=4.48;
Frequency: 1880 MHz; Medium parameters used: $f = 1800$ MHz; $\sigma = 1.35$ mho/m; $\epsilon_r = 39.28$; $\rho = 1000$ kg/m³ ;
Phantom section: Right Section
Ambient temperature (°C): 20.9, Liquid temperature (°C): 20.7

SATIMO Configuration:

- Probe: SSE5; Calibrated: Dec. 17,2020; Serial No.: SN 03/18 EP327
- Sensor-Surface: 4mm (Mechanical Surface Detection)
- Phantom: SAM twin phantom
- Measurement SW: OpenSAR V4_02_35

Configuration/PCS1900 Mid-Touch-Right/Area Scan: Measurement grid: dx=8mm, dy=8mm
Configuration/PCS1900 Mid-Touch-Right/Zoom Scan: Measurement grid: dx=8mm,dy=8mm, dz=5mm;

Area Scan	dx=8mm dy=8mm, h= 5.00 mm
ZoomScan	5x5x7,dx=8mm dy=8mm dz=5mm,Complete
Phantom	Right head
Device Position	Cheek
Band	PCS 1900
Channels	Middle
Signal	TDMA (Crest factor: 8.0)

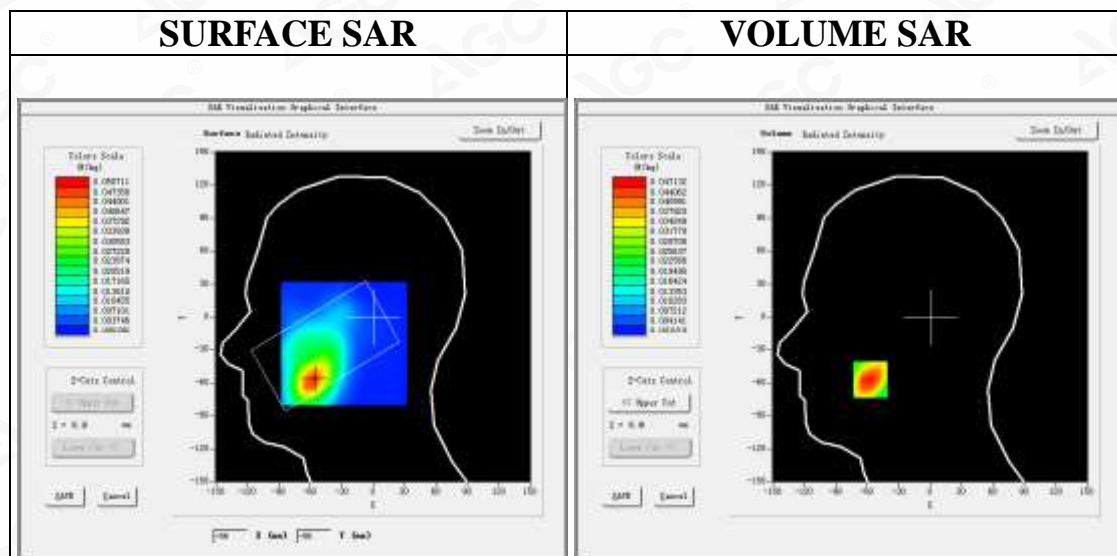

Maximum location: X=-57.00, Y=-57.00
SAR Peak: 0.08 W/kg

SAR 10g (W/Kg)	0.025024
SAR 1g (W/Kg)	0.046109

Any report having not been signed by authorized approver, or having been altered without authorization, or having not been stamped by the "Dedicated Testing/Inspection Stamp" is deemed to be invalid. Copying or excerpting portion of, or altering the content of the report is not permitted without the written authorization of AGC. The test results presented in the report apply only to the tested sample. Any objections to report issued by AGC should be submitted to AGC within 15days after the issuance of the test report. Further enquiry of validity or verification of the test report should be addressed to AGC by agc@agc-cert.com.



Z (mm)	0.00	4.00	9.00	14.00	19.00	24.00	29.00
SAR (W/Kg)	0.0743	0.0471	0.0267	0.0157	0.0099	0.0056	0.0032

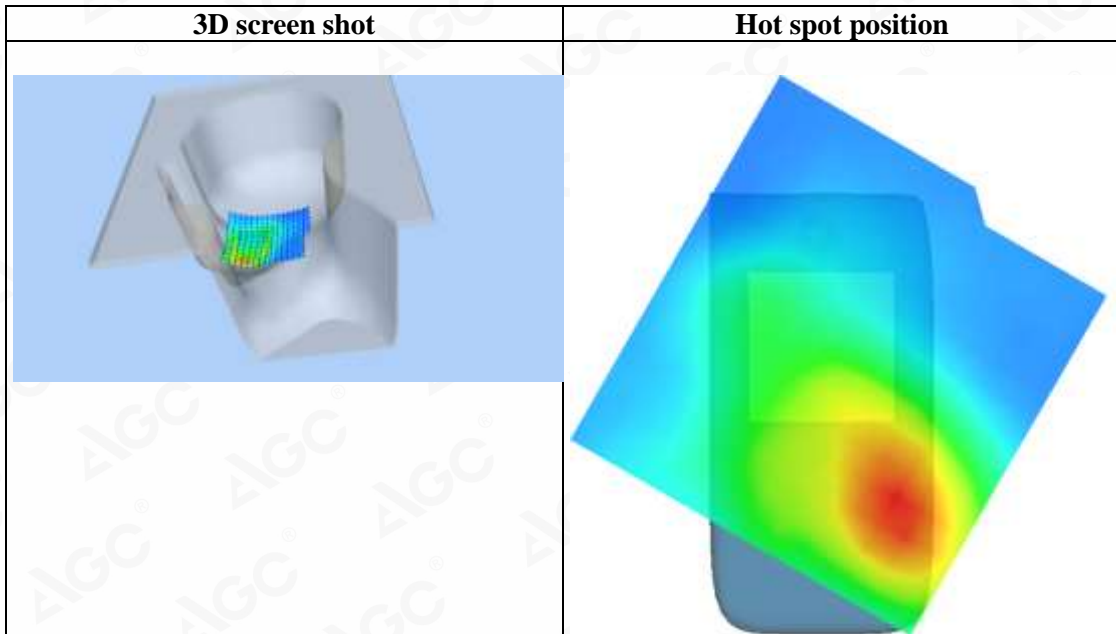
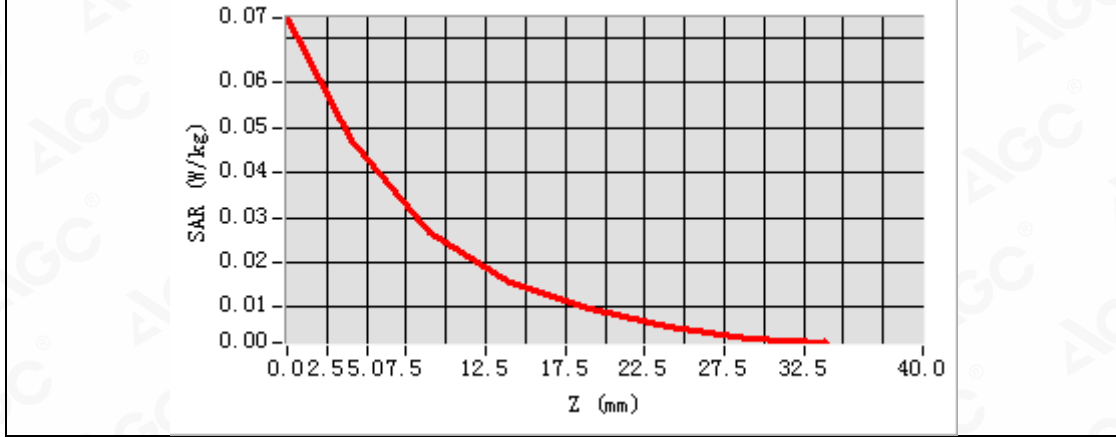

Any report having not been signed by authorized approver, or having been altered without authorization, or having not been stamped by the "Dedicated Testing/Inspection Stamp" is deemed to be invalid. Copying or excerpting portion of, or altering the content of the report is not permitted without the written authorization of AGC. The test results presented in the report apply only to the tested sample. Any objections to report issued by AGC should be submitted to AGC within 15 days after the issuance of the test report. Further enquiry of validity or verification of the test report should be addressed to AGC by agc@agc-cert.com.



Test Laboratory: AGC Lab
PCS 1900 Mid-Body-Back (MS)<SIM 1>
DUT: Mobile phone; Type: P40

Date: Jul. 02,2021

Communication System: Generic GSM; Communication System Band: PCS 1900; Duty Cycle: 1:8.3; Conv.F=4.48;
Frequency: 1880 MHz; Medium parameters used: $f = 1800$ MHz; $\sigma = 1.35$ mho/m; $\epsilon_r = 39.28$; $\rho = 1000$ kg/m³ ;
Phantom section: Flat Section
Ambient temperature (°C): 20.9, Liquid temperature (°C): 20.7

SATIMO Configuration:

- Probe: SSE5; Calibrated: Dec. 17,2020; Serial No.: SN 03/18 EP327
- Sensor-Surface: 4mm (Mechanical Surface Detection)
- Phantom: SAM twin phantom
- Measurement SW: OpenSAR V4_02_35

Configuration/PCS1900 Mid-Body-Back/Area Scan: Measurement grid: dx=8mm, dy=8mm
Configuration/PCS1900 Mid-Body-Back/Zoom Scan: Measurement grid: dx=8mm, dy=8mm, dz=5mm;

Area Scan	surf_sam_plan.txt, h= 5.00 mm
ZoomScan	5x5x7,dx=8mm dy=8mm dz=5mm,Complete
Phantom	Validation plane
Device Position	Body Back
Band	PCS 1900
Channels	Middle
Signal	TDMA (Crest factor: 8.0)

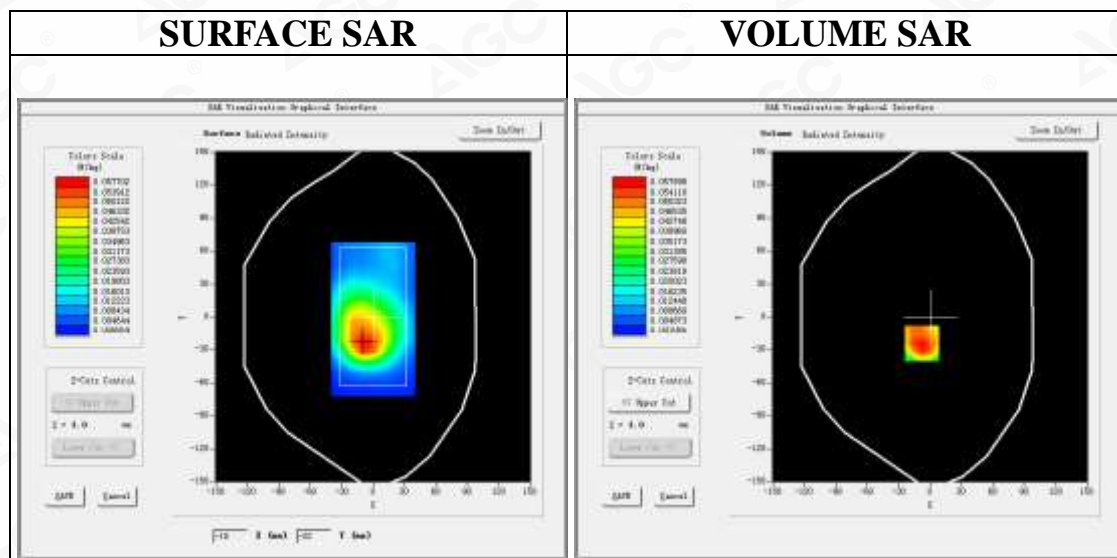

Maximum location: X=-8.00, Y=-24.00
SAR Peak: 0.09 W/kg

SAR 10g (W/Kg)	0.031075
SAR 1g (W/Kg)	0.056993

Any report having not been signed by authorized approver, or having been altered without authorization, or having not been stamped by the "Dedicated Testing/Inspection Stamp" is deemed to be invalid. Copying or excerpting portion of, or altering the content of the report is not permitted without the written authorization of AGC. The test results presented in the report apply only to the tested sample. Any objections to report issued by AGC should be submitted to AGC within 15days after the issuance of the test report. Further enquiry of validity or verification of the test report should be addressed to AGC by agc@agc-cert.com.



Z (mm)	0.00	4.00	9.00	14.00	19.00	24.00	29.00
SAR (W/Kg)	0.0890	0.0579	0.0329	0.0191	0.0108	0.0061	0.0036

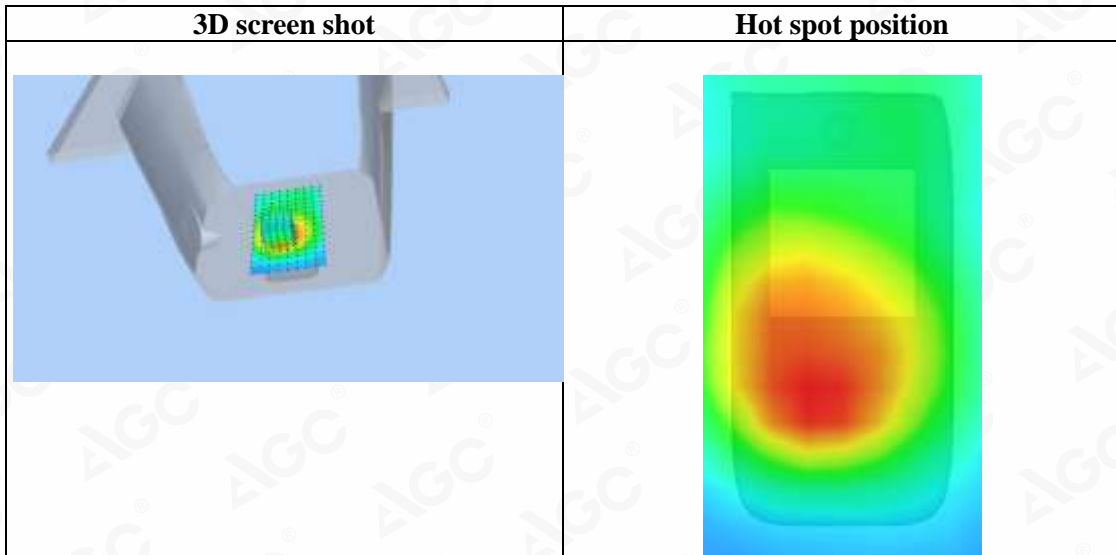
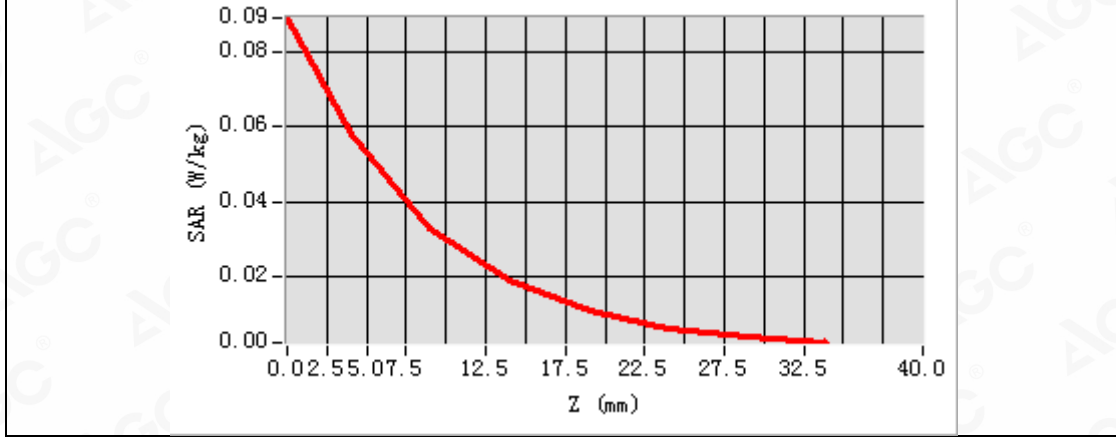

Any report having not been signed by authorized approver, or having been altered without authorization, or having not been stamped by the "Dedicated Testing/Inspection Stamp" is deemed to be invalid. Copying or excerpting portion of, or altering the content of the report is not permitted without the written authorization of AGC. The test results presented in the report apply only to the tested sample. Any objections to report issued by AGC should be submitted to AGC within 15days after the issuance of the test report. Further enquiry of validity or verification of the test report should be addressed to AGC by agc@agc-cert.com.



Test Laboratory: AGC Lab
GPRS 1900 Mid-Body-Back (4up)
DUT: Mobile phone; Type: P40

Date: Jul. 02,2021

Communication System: GPRS-4Slot; Communication System Band: PCS 1900; Duty Cycle: 1:2.1; Conv.F=4.48;
Frequency: 1880 MHz; Medium parameters used: $f = 1800$ MHz; $\sigma = 1.35$ mho/m; $\epsilon_r = 39.28$; $\rho = 1000$ kg/m³ ;
Phantom section: Flat Section
Ambient temperature (°C): 20.9, Liquid temperature (°C): 20.7

SATIMO Configuration:

- Probe: SSE5; Calibrated: Dec. 17,2020; Serial No.: SN 03/18 EP327
- Sensor-Surface: 4mm (Mechanical Surface Detection)
- Phantom: SAM twin phantom
- Measurement SW: OpenSAR V4_02_35

Configuration/GPRS1900 Mid-Body-Back/Area Scan: Measurement grid: dx=8mm, dy=8mm
Configuration/GPRS1900 Mid-Body-Back/Zoom Scan: Measurement grid: dx=8mm, dy=8mm, dz=5mm;

Area Scan	surf_sam_plan.txt, h= 5.00 mm
Zoom Scan	5x5x7,dx=8mm dy=8mm dz=5mm,Complete
Phantom	Validation plane
Device Position	Body Back
Band	PCS 1900
Channels	Middle
Signal	TDMA (Crest factor: 2.0)

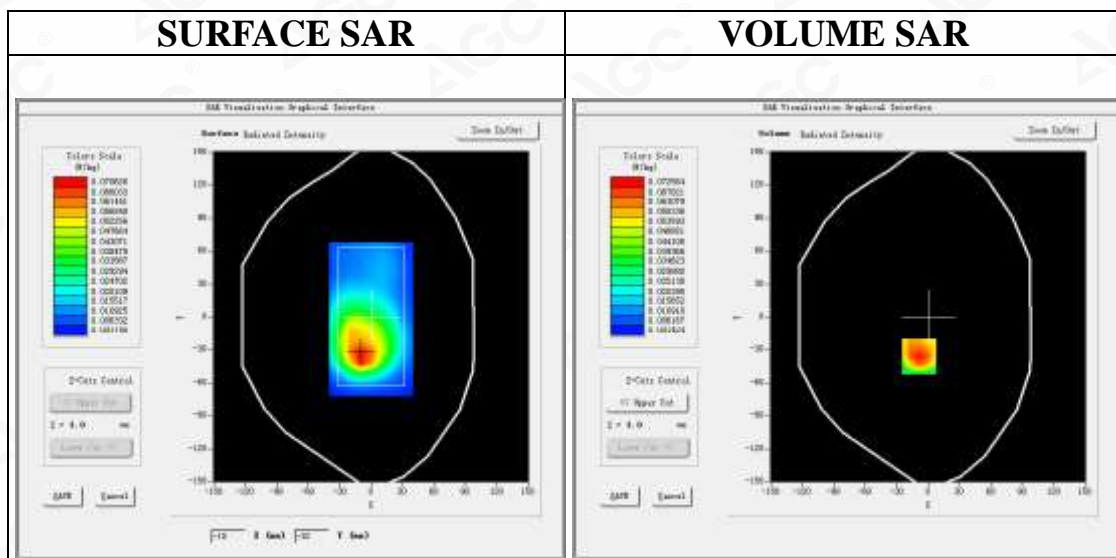

Maximum location: X=-9.00, Y=-36.00

SAR Peak: 0.11 W/kg

SAR 10g (W/Kg)	0.067613
SAR 1g (W/Kg)	0.099381

Any report having not been signed by authorized approver, or having been altered without authorization, or having not been stamped by the "Dedicated Testing/Inspection Stamp" is deemed to be invalid. Copying or excerpting portion of, or altering the content of the report is not permitted without the written authorization of AGC. The test results presented in the report apply only to the tested sample. Any objections to report issued by AGC should be submitted to AGC within 15days after the issuance of the test report. Further enquiry of validity or verification of the test report should be addressed to AGC by agc@agc-cert.com.

Attestation of Global Compliance(Shenzhen)Co., Ltd
Attestation of Global Compliance(Shenzhen)Std & Tech Co., Ltd
Tel: +86-755 2523 4088 E-mail: agc@agc-cert.com Web: http://cn.agc-cert.com/



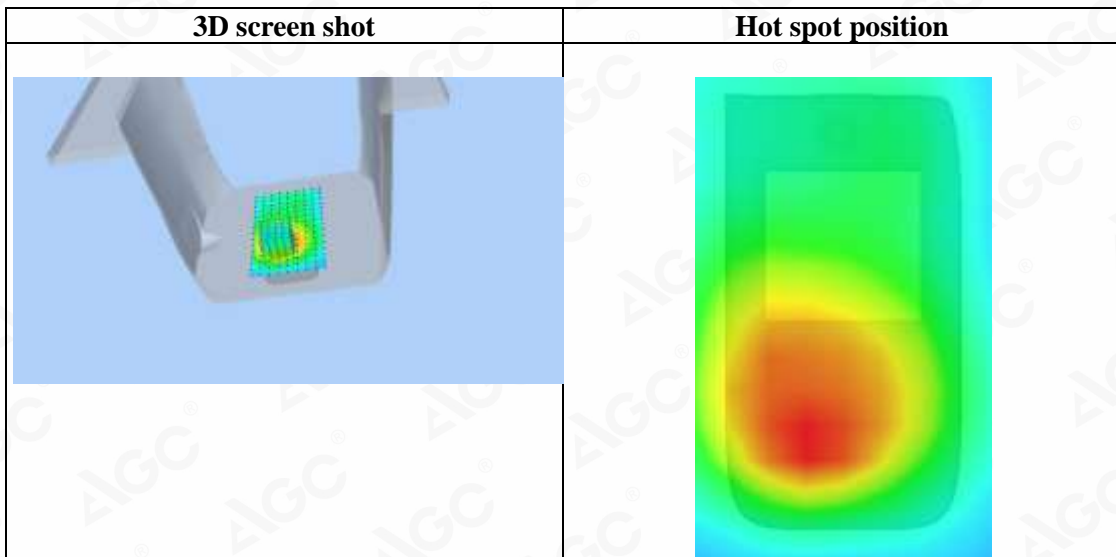
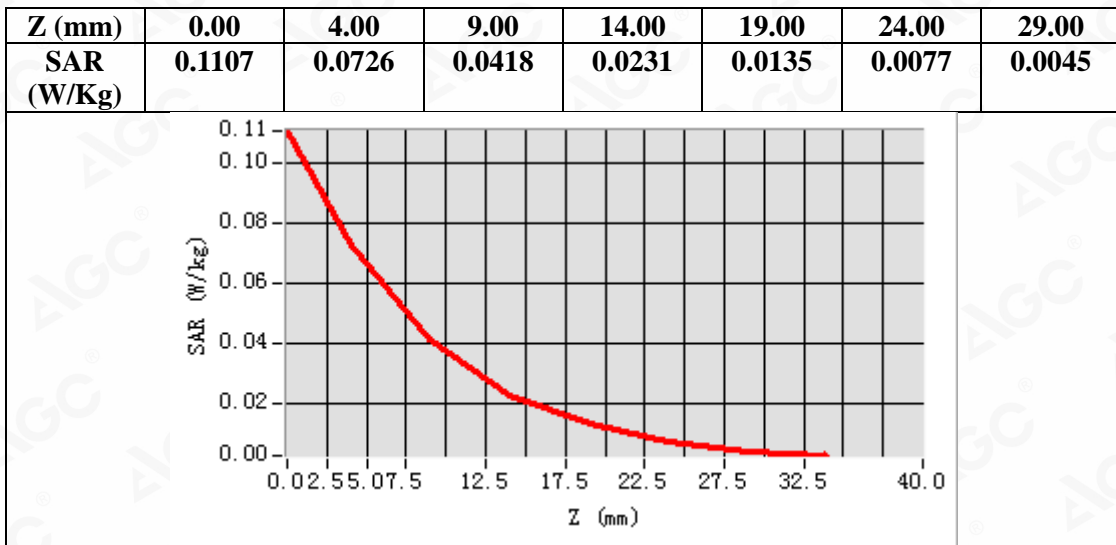

Any report having not been signed by authorized approver, or having been altered without authorization, or having not been stamped by the "Dedicated Testing/Inspection Stamp" is deemed to be invalid. Copying or excerpting portion of, or altering the content of the report is not permitted without the written authorization of AGC. The test results presented in the report apply only to the tested sample. Any objections to report issued by AGC should be submitted to AGC within 15 days after the issuance of the test report. Further enquiry of validity or verification of the test report should be addressed to AGC by agc@agc-cert.com.



Test Laboratory: AGC Lab
WCDMA Band II Mid-Touch-Right (RMC)
DUT: Mobile phone; Type: P40

Date: Jul. 02,2021

Communication System: UMTS; Communication System Band: Band II UTRA/FDD ;Duty Cycle:1:1; Conv.F=4.48;
Frequency: 1880 MHz; Medium parameters used: $f = 1800$ MHz; $\sigma = 1.35$ mho/m; $\epsilon_r = 39.28$; $\rho = 1000$ kg/m³ ;
Phantom section: Right Section
Ambient temperature (°C): 20.9, Liquid temperature (°C): 20.7

SATIMO Configuration:

- Probe: SSE5; Calibrated: Dec. 17,2020; Serial No.: SN 03/18 EP327
- Sensor-Surface: 4mm (Mechanical Surface Detection)
- Phantom: SAM twin phantom
- Measurement SW: OpenSAR V4_02_35

Configuration/WCDMA band II Mid-Touch-Right/Area Scan: Measurement grid: dx=8mm, dy=8mm

Configuration/WCDMA band II Mid-Touch-Right/Zoom Scan: Measurement grid: dx=8mm,dy=8mm, dz=5mm;

Area Scan	dx=8mm dy=8mm, h= 5.00 mm
ZoomScan	5x5x7,dx=8mm dy=8mm dz=5mm,Complete
Phantom	Right head
Device Position	Cheek
Band	WCDMA band II
Channels	Middle
Signal	CDMA (Crest factor: 1.0)

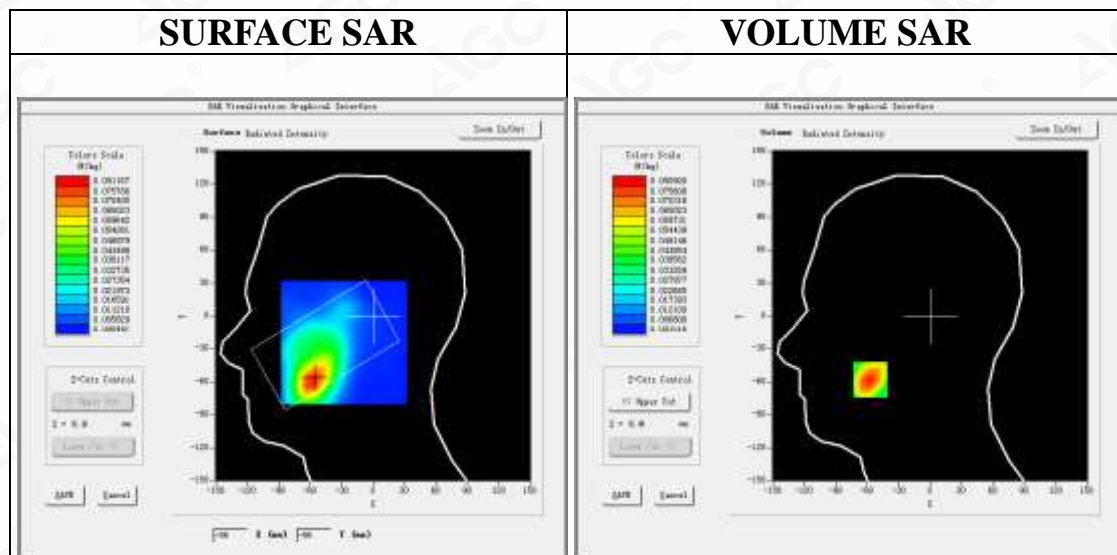

Maximum location: X=-57.00, Y=-58.00

SAR Peak: 0.13 W/kg

SAR 10g (W/Kg)	0.041575
SAR 1g (W/Kg)	0.077863

Any report having not been signed by authorized approver, or having been altered without authorization, or having not been stamped by the "Dedicated Testing/Inspection Stamp" is deemed to be invalid. Copying or excerpting portion of, or altering the content of the report is not permitted without the written authorization of AGC. The test results presented in the report apply only to the tested sample. Any objections to report issued by AGC should be submitted to AGC within 15days after the issuance of the test report. Further enquiry of validity or verification of the test report should be addressed to AGC by agc@agc-cert.com.

Attestation of Global Compliance(Shenzhen)Co., Ltd
Attestation of Global Compliance(Shenzhen)Std & Tech Co., Ltd
Tel: +86-755 2523 4088 E-mail: agc@agc-cert.com Web: http://cn.agc-cert.com/



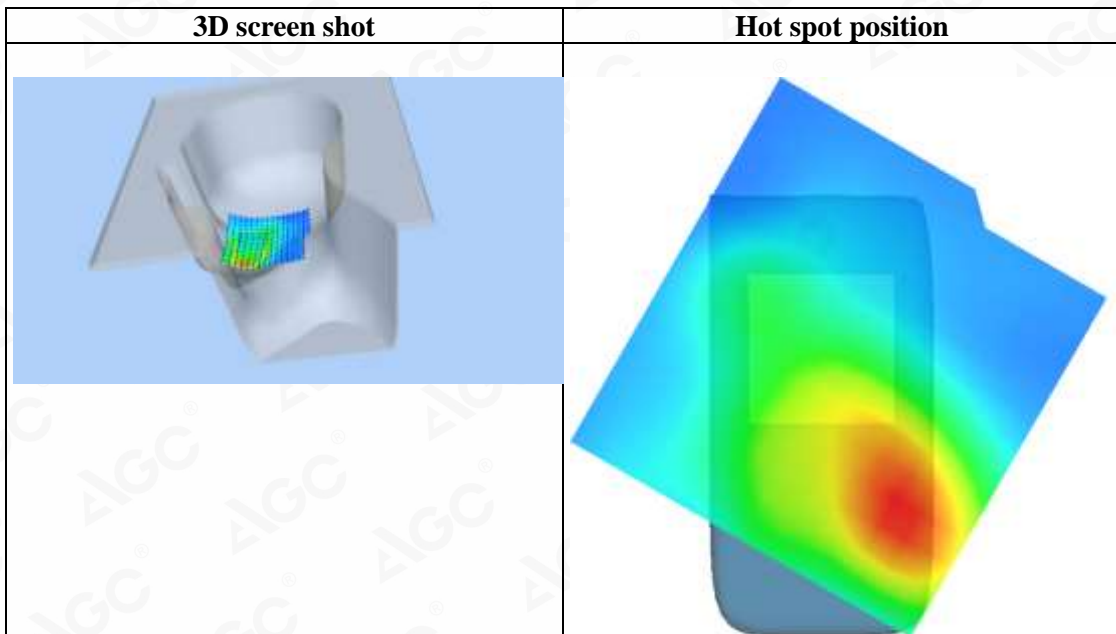
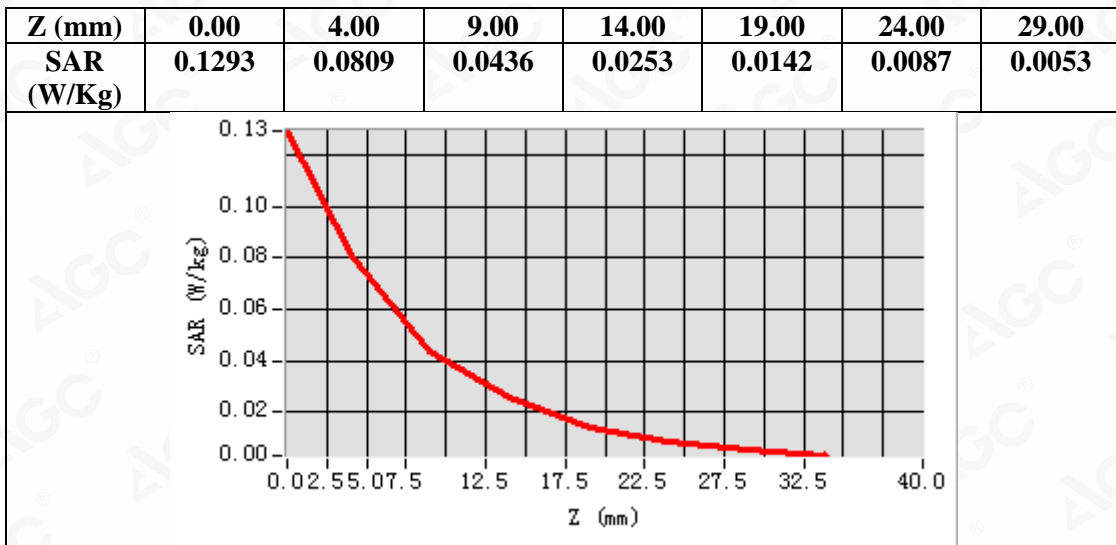

Any report having not been signed by authorized approver, or having been altered without authorization, or having not been stamped by the "Dedicated Testing/Inspection Stamp" is deemed to be invalid. Copying or excerpting portion of, or altering the content of the report is not permitted without the written authorization of AGC. The test results presented in the report apply only to the tested sample. Any objections to report issued by AGC should be submitted to AGC within 15 days after the issuance of the test report. Further enquiry of validity or verification of the test report should be addressed to AGC by agc@agc-cert.com.



Test Laboratory: AGC Lab
WCDMA Band II Mid-Body-Towards Grounds (RMC 12.2kbps)
DUT: Mobile phone; Type: P40

Date: Jul. 02,2021

Communication System: UMTS; Communication System Band: Band II UTRA/FDD ;Duty Cycle:1:1; Conv.F=4.48;
Frequency: 1880 MHz; Medium parameters used: $f = 1800$ MHz; $\sigma=1.35$ mho/m; $\epsilon_r=39.28$; $\rho= 1000$ kg/m³ ;
Phantom section: Flat Section
Ambient temperature (°C): 20.9, Liquid temperature (°C): 20.7

SATIMO Configuration:

- Probe: SSE5; Calibrated: Dec. 17,2020; Serial No.: SN 03/18 EP327
- Sensor-Surface: 4mm (Mechanical Surface Detection)
- Phantom: SAM twin phantom
- Measurement SW: OpenSAR V4_02_35

Configuration/ WCDMA band II Mid-Body-back/Area Scan: Measurement grid: dx=8mm, dy=8mm
Configuration/ WCDMA band II Mid-Body-back/Zoom Scan: Measurement grid: dx=8mm,dy=8mm, dz=5mm;

Area Scan	surf_sam_plan.txt, h= 5.00 mm
ZoomScan	5x5x7,dx=8mm dy=8mm dz=5mm,Complete
Phantom	Validation plane
Device Position	Body Back
Band	WCDMA band II
Channels	Middle
Signal	CDMA (Crest factor: 1.0)

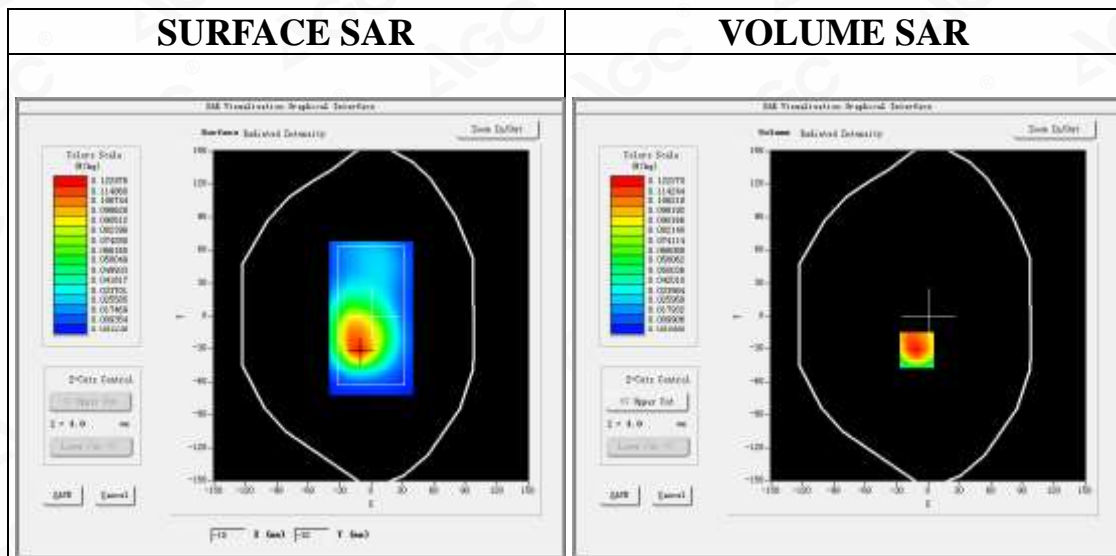

Maximum location: X=-11.00, Y=-31.00

SAR Peak: 0.19 W/kg

SAR 10g (W/Kg)	0.065014
SAR 1g (W/Kg)	0.117780

Any report having not been signed by authorized approver, or having been altered without authorization, or having not been stamped by the "Dedicated Testing/Inspection Stamp" is deemed to be invalid. Copying or excerpting portion of, or altering the content of the report is not permitted without the written authorization of AGC. The test results presented in the report apply only to the tested sample. Any objections to report issued by AGC should be submitted to AGC within 15days after the issuance of the test report. Further enquiry of validity or verification of the test report should be addressed to AGC by agc@agc-cert.com.

Attestation of Global Compliance(Shenzhen)Co., Ltd
Attestation of Global Compliance(Shenzhen)Std & Tech Co., Ltd
Tel: +86-755 2523 4088 E-mail: agc@agc-cert.com Web: http://cn.agc-cert.com/



Z (mm)	0.00	4.00	9.00	14.00	19.00	24.00	29.00
SAR (W/Kg)	0.1885	0.1223	0.0696	0.0401	0.0231	0.0134	0.0076

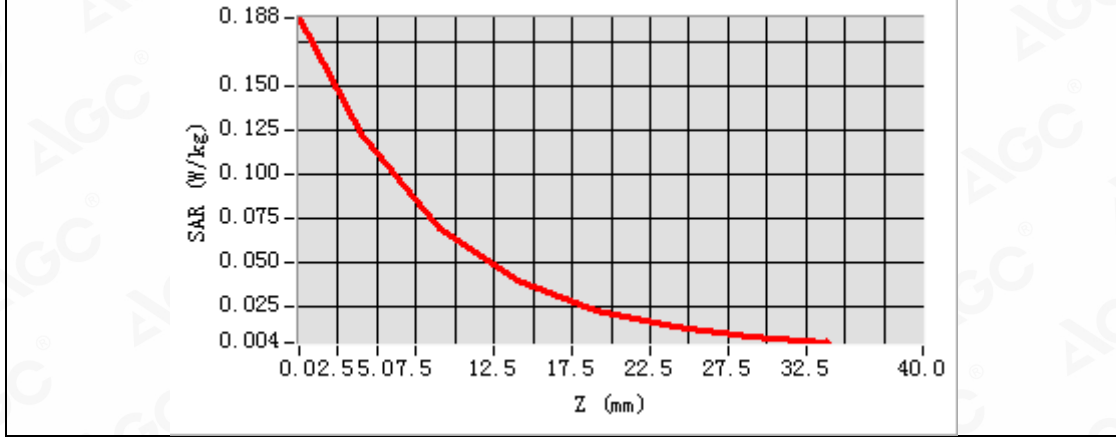

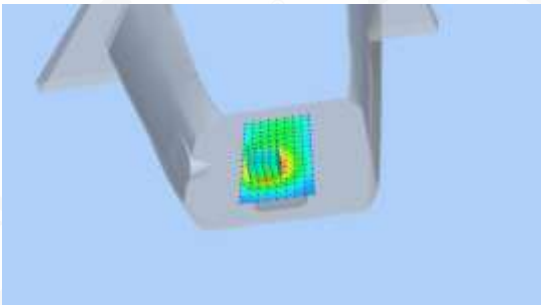
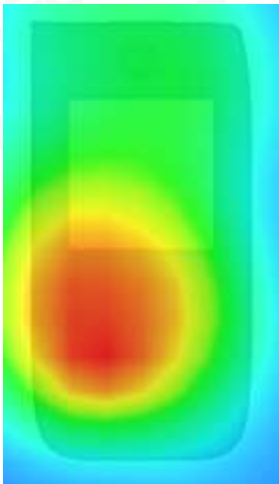
3D screen shot	Hot spot position
	

Any report having not been signed by authorized approver, or having been altered without authorization, or having not been stamped by the "Dedicated Testing/Inspection Stamp" is deemed to be invalid. Copying or excerpting portion of, or altering the content of the report is not permitted without the written authorization of AGC. The test results presented in the report apply only to the tested sample. Any objections to report issued by AGC should be submitted to AGC within 15 days after the issuance of the test report. Further enquiry of validity or verification of the test report should be addressed to AGC by agc@agc-cert.com.



Test Laboratory: AGC Lab

Date: Jul. 01,2021

WCDMA Band V Mid-Touch-Right (RMC)

DUT: Mobile phone; Type: P40

Communication System: UMTS; Communication System Band: BAND V UTRA/FDD ; Duty Cycle:1: 1; Conv.F=5.24; Frequency: 836.4 MHz; Medium parameters used: $f = 835\text{MHz}$; $\sigma = 0.93\text{ mho/m}$; $\epsilon_r = 40.41$; $\rho = 1000\text{ kg/m}^3$; Phantom section: Right Section Ambient temperature ($^{\circ}\text{C}$): 21.5, Liquid temperature ($^{\circ}\text{C}$): 21.3

SATIMO Configuration:

- Probe: SSE5; Calibrated: Dec. 17,2020; Serial No.: SN 03/18 EP327
- Sensor-Surface: 4mm (Mechanical Surface Detection)
- Phantom: SAM twin phantom
- Measurement SW: OpenSAR V4_02_35

Configuration/ WCDMA Band V Mid-Touch- Right /Area Scan: Measurement grid: dx=8mm, dy=8mm

Configuration/ WCDMA Band V Mid-Touch- Right /Zoom Scan: Measurement grid: dx=8mm, dy=8mm, dz=5mm

Area Scan	dx=8mm dy=8mm, h= 5.00 mm
ZoomScan	5x5x7,dx=8mm dy=8mm dz=5mm,Complete
Phantom	Right head
Device Position	Cheek
Band	WCDMA Band V
Channels	Middle
Signal	CDMA (Crest factor: 1.0)

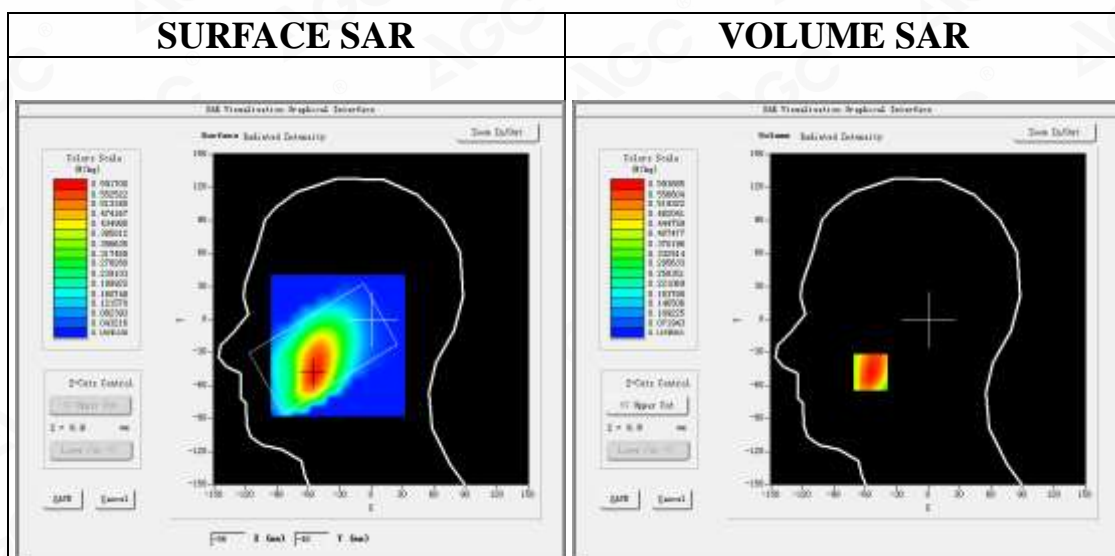

Maximum location: X=-55.00, Y=-48.00

SAR Peak: 0.83 W/kg

SAR 10g (W/Kg)	0.393691
SAR 1g (W/Kg)	0.579184

Any report having not been signed by authorized approver, or having been altered without authorization, or having not been stamped by the "Dedicated Testing/Inspection Stamp" is deemed to be invalid. Copying or excerpting portion of, or altering the content of the report is not permitted without the written authorization of AGC. The test results presented in the report apply only to the tested sample. Any objections to report issued by AGC should be submitted to AGC within 15days after the issuance of the test report. Further enquiry of validity or verification of the test report should be addressed to AGC by agc@agc-cert.com.

Attestation of Global Compliance(Shenzhen)Co., Ltd
Attestation of Global Compliance(Shenzhen)Std & Tech Co., Ltd
Tel: +86-755 2523 4088 E-mail: agc@agc-cert.com Web: http://cn.agc-cert.com/



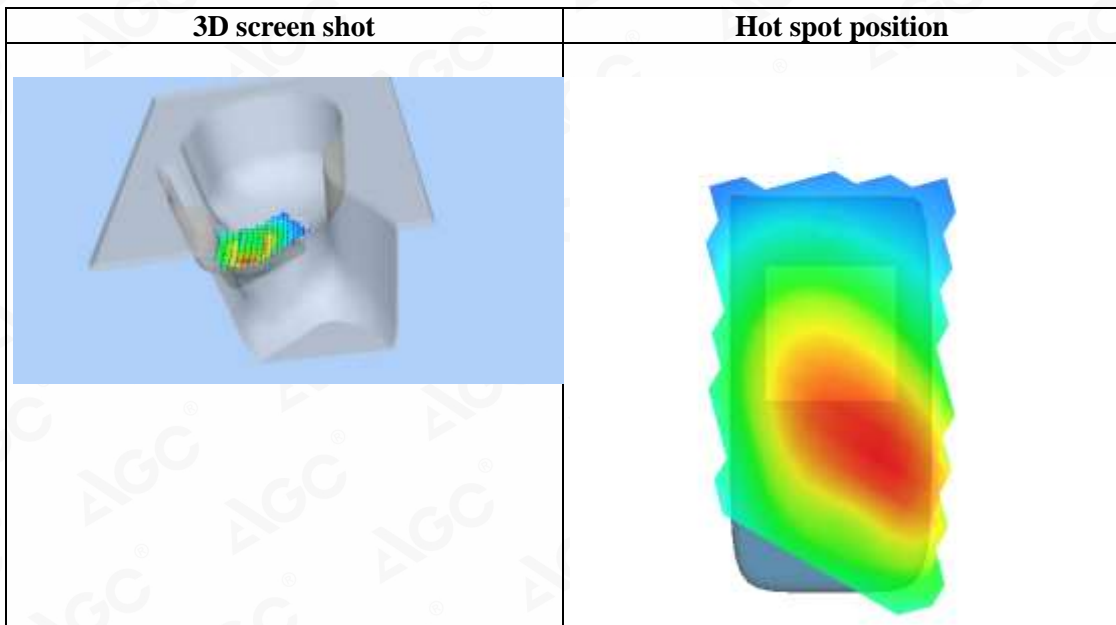
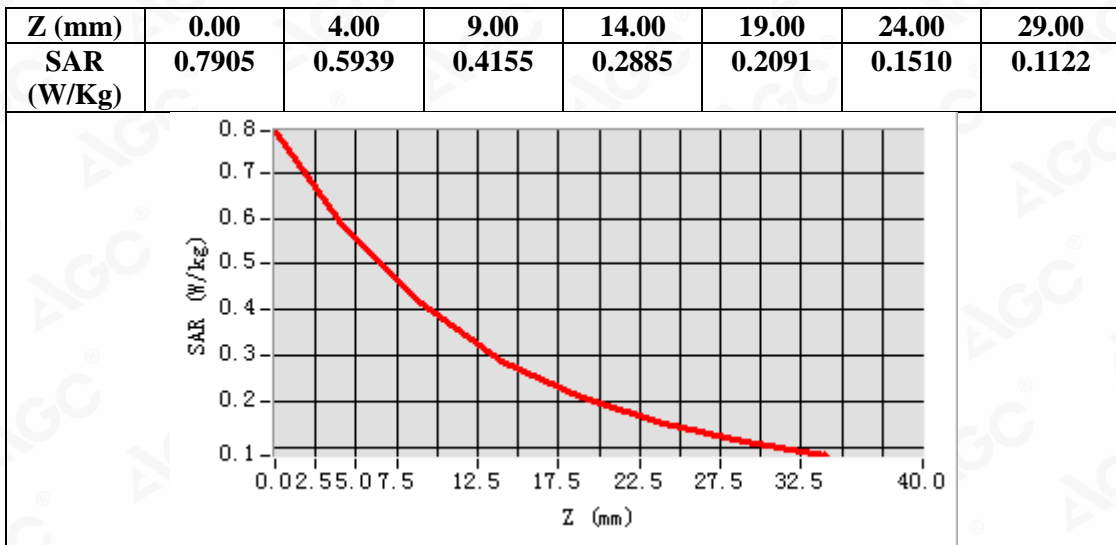

Any report having not been signed by authorized approver, or having been altered without authorization, or having not been stamped by the "Dedicated Testing/Inspection Stamp" is deemed to be invalid. Copying or excerpting portion of, or altering the content of the report is not permitted without the written authorization of AGC. The test results presented in the report apply only to the tested sample. Any objections to report issued by AGC should be submitted to AGC within 15 days after the issuance of the test report. Further enquiry of validity or verification of the test report should be addressed to AGC by agc@agc-cert.com.



Test Laboratory: AGC Lab

Date: Jul. 01,2021

WCDMA Band V Mid-Body-Towards Grounds (RMC)

DUT: Mobile phone; Type: P40

Communication System: UMTS; Communication System Band: BAND V UTRA/FDD; Duty Cycle:1: 1; Conv.F=5.24; Frequency: 836.4 MHz; Medium parameters used: $f = 835\text{MHz}$; $\sigma = 0.93 \text{ mho/m}$; $\epsilon_r = 40.41$; $\rho = 1000 \text{ kg/m}^3$; Phantom section: Flat Section Ambient temperature ($^{\circ}\text{C}$): 21.5, Liquid temperature ($^{\circ}\text{C}$): 21.3

SATIMO Configuration:

- Probe: SSE5; Calibrated: Dec. 17,2020; Serial No.: SN 03/18 EP327
- Sensor-Surface: 4mm (Mechanical Surface Detection)
- Phantom: SAM twin phantom
- Measurement SW: OpenSAR V4_02_35

Configuration/ WCDMA Band V Mid-Body-Back/Area Scan: Measurement grid: dx=8mm, dy=8mm

Configuration/ WCDMA Band V Mid-Body-Back/Zoom Scan: Measurement grid: dx=8mm,dy=8mm, dz=5mm;

Area Scan	surf_sam_plan.txt, h= 5.00 mm
ZoomScan	5x5x7,dx=8mm dy=8mm dz=5mm,Complete
Phantom	Validation plane
Device Position	Body Back
Band	WCDMA Band V
Channels	Middle
Signal	CDMA (Crest factor: 1.0)

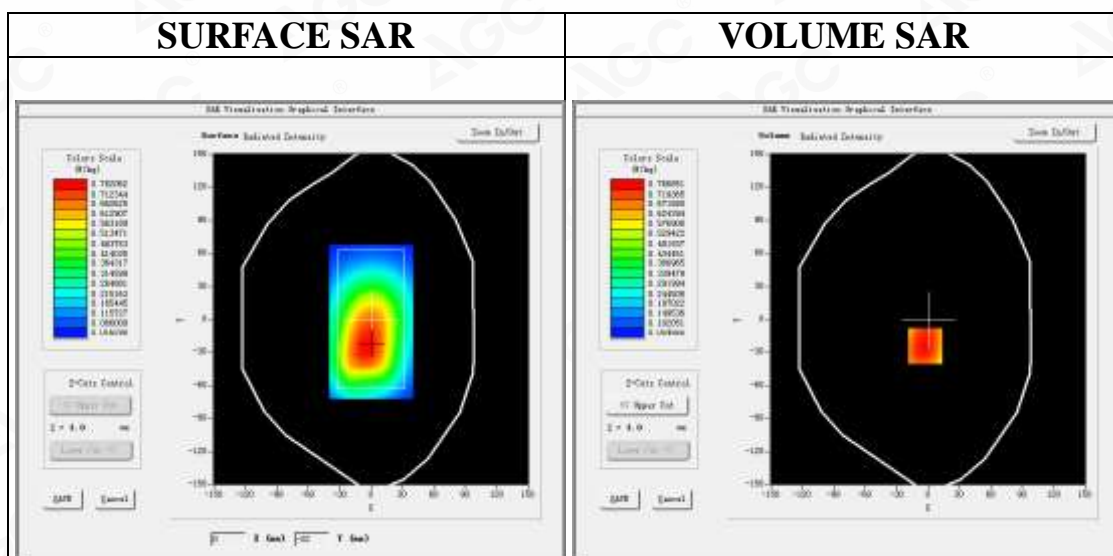

Maximum location: X=-3.00, Y=-24.00

SAR Peak: 1.00 W/kg

SAR 10g (W/Kg)	0.533103
SAR 1g (W/Kg)	0.744944

Any report having not been signed by authorized approver, or having been altered without authorization, or having not been stamped by the "Dedicated Testing/Inspection Stamp" is deemed to be invalid. Copying or excerpting portion of, or altering the content of the report is not permitted without the written authorization of AGC. The test results presented in the report apply only to the tested sample. Any objections to report issued by AGC should be submitted to AGC within 15days after the issuance of the test report. Further enquiry of validity or verification of the test report should be addressed to AGC by agc@agc-cert.com.



Z (mm)	0.00	4.00	9.00	14.00	19.00	24.00	29.00
SAR (W/Kg)	0.9624	0.7669	0.5714	0.4180	0.3062	0.2227	0.1611

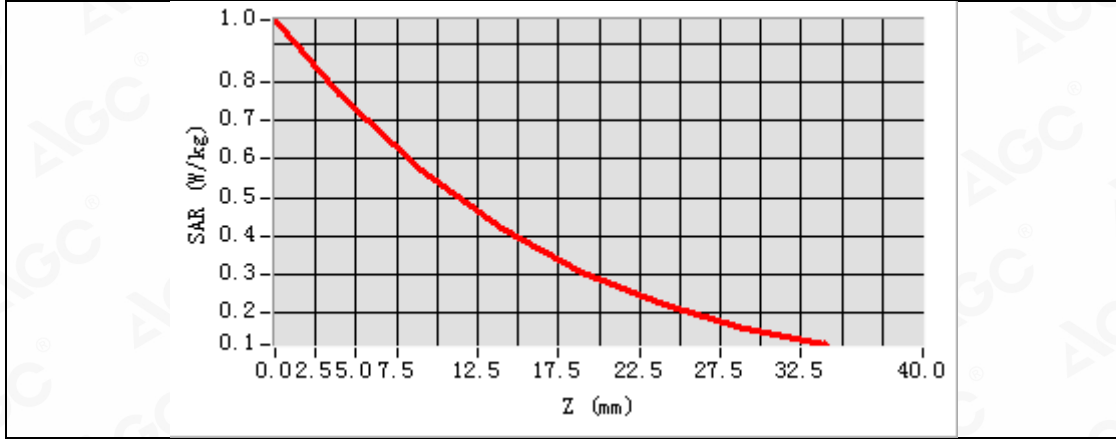

Any report having not been signed by authorized approver, or having been altered without authorization, or having not been stamped by the "Dedicated Testing/Inspection Stamp" is deemed to be invalid. Copying or excerpting portion of, or altering the content of the report is not permitted without the written authorization of AGC. The test results presented in the report apply only to the tested sample. Any objections to report issued by AGC should be submitted to AGC within 15days after the issuance of the test report. Further enquiry of validity or verification of the test report should be addressed to AGC by agc@agc-cert.com.



Test Laboratory: AGC Lab
LTE Band 2 Mid-Touch-Right (1 RB#0)
DUT: Mobile phone; Type: P40

Date: Jul. 04,2021

Communication System: LTE; Communication System Band: LTE Band 2; Duty Cycle:1:1; Conv.F=4.48;
Frequency:1880MHz; Medium parameters used: $f=1900$ MHz; $\sigma=1.37$ mho/m; $\epsilon_r=41.53$; $\rho=1000$ kg/m³ ;
Phantom section: Right Section
Ambient temperature (°C): 20.5, Liquid temperature (°C): 20.3

SATIMO Configuration:

- Probe: SSE5; Calibrated: Dec. 17,2020; Serial No.: SN 03/18 EP327
- Sensor-Surface: 4mm (Mechanical Surface Detection)
- Phantom: SAM twin phantom
- Measurement SW: OpenSAR V4_02_35

Configuration/ LTE Band 2 Mid- Touch-Right /Area Scan: Measurement grid: dx=8mm, dy=8mm
Configuration/ LTE Band 2 Mid- Touch-Right /Zoom Scan: Measurement grid: dx=8mm,dy=8mm, dz=5mm;

Area Scan	dx=8mm dy=8mm, h= 5.00 mm
Zoom Scan	5x5x7,dx=8mm dy=8mm dz=5mm
Phantom	Right head
Device Position	Cheek
Band	LTE Band 2
Channels	Middle
Signal	OFDM (Crest factor: 1.0)

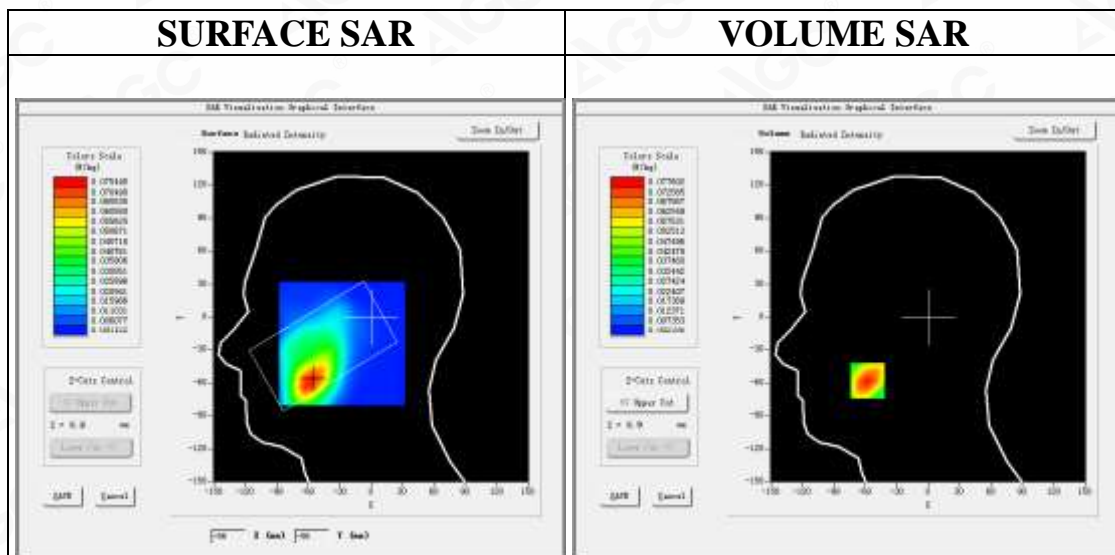

Maximum location: X=-58.00, Y=-58.00
SAR Peak: 0.12 W/kg

SAR 10g (W/Kg)	0.041250
SAR 1g (W/Kg)	0.074540

Any report having not been signed by authorized approver, or having been altered without authorization, or having not been stamped by the "Dedicated Testing/Inspection Stamp" is deemed to be invalid. Copying or excerpting portion of, or altering the content of the report is not permitted without the written authorization of AGC. The test results presented in the report apply only to the tested sample. Any objections to report issued by AGC should be submitted to AGC within 15days after the issuance of the test report. Further enquiry of validity or verification of the test report should be addressed to AGC by agc@agc-cert.com.



Z (mm)	0.00	4.00	9.00	14.00	19.00	24.00	29.00
SAR (W/Kg)	0.1214	0.0776	0.0436	0.0258	0.0153	0.0092	0.0058

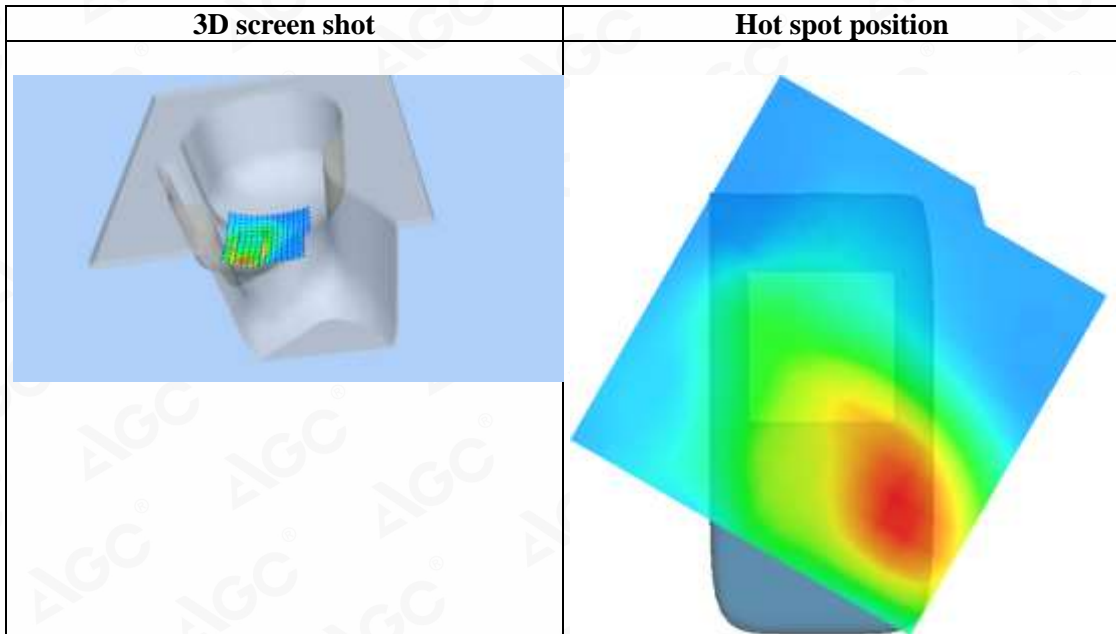
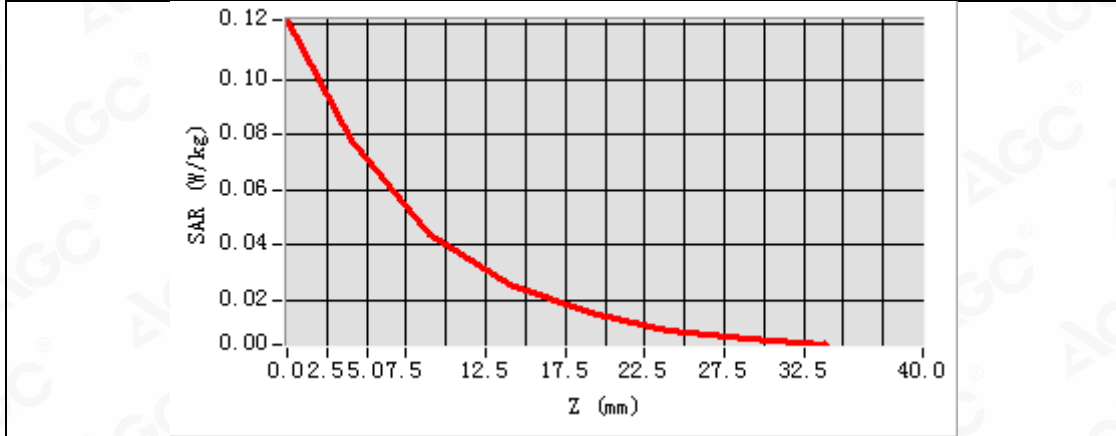

Any report having not been signed by authorized approver, or having been altered without authorization, or having not been stamped by the "Dedicated Testing/Inspection Stamp" is deemed to be invalid. Copying or excerpting portion of, or altering the content of the report is not permitted without the written authorization of AGC. The test results presented in the report apply only to the tested sample. Any objections to report issued by AGC should be submitted to AGC within 15 days after the issuance of the test report. Further enquiry of validity or verification of the test report should be addressed to AGC by agc@agc-cert.com.



Test Laboratory: AGC Lab
LTE Band 2 Mid-Body-Back (1 RB#0)
DUT: Mobile phone; Type: P40

Date: Jul. 04,2021

Communication System: LTE; Communication System Band: LTE Band 2; Duty Cycle:1:1; Conv.F=4.48;
Frequency:1880MHz; Medium parameters used: $f = 1800$ MHz; $\sigma = 1.37$ mho/m; $\epsilon_r = 41.53$; $\rho = 1000$ kg/m³ ;
Phantom section: Flat Section
Ambient temperature (°C): 20.5, Liquid temperature (°C): 20.3

SATIMO Configuration:

- Probe: SSE5; Calibrated: Dec. 17,2020; Serial No.: SN 03/18 EP327
- Sensor-Surface: 4mm (Mechanical Surface Detection)
- Phantom: SAM twin phantom
- Measurement SW: OpenSAR V4_02_35

Configuration/ LTE Band 2 Mid-Body-back/Area Scan: Measurement grid: dx=8mm, dy=8mm
Configuration/ LTE Band 2 Mid-Body-back/Zoom Scan: Measurement grid: dx=8mm,dy=8mm, dz=5mm;

Area Scan	surf_sam_plan.txt, h= 5.00 mm
Zoom Scan	5x5x7,dx=8mm dy=8mm dz=5mm
Phantom	Validation plane
Device Position	Body Back
Band	LTE Band 2
Channels	Middle
Signal	OFDM (Crest factor: 1.0)

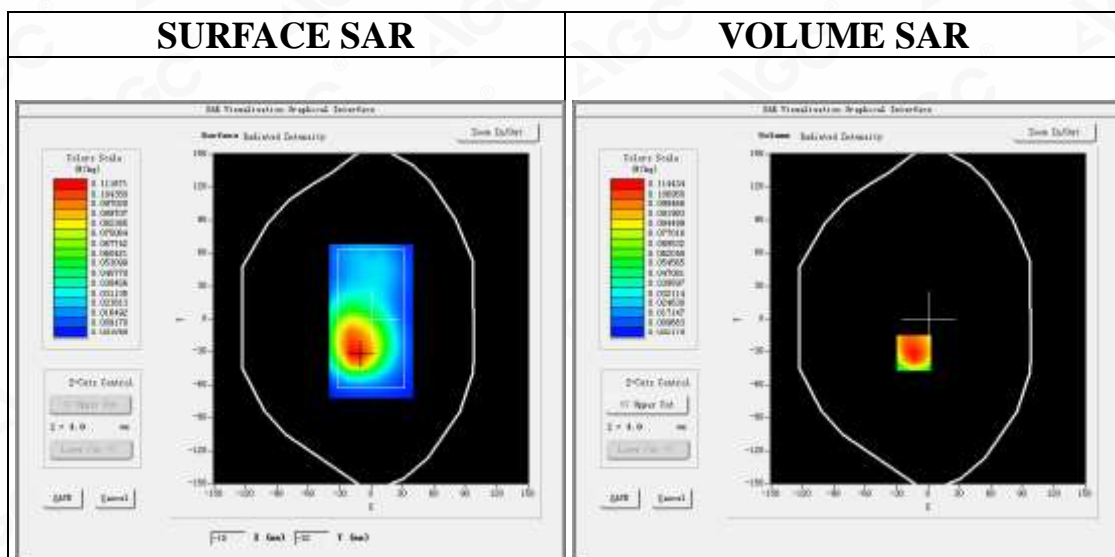

Maximum location: X=-14.00, Y=-31.00
SAR Peak: 0.18 W/kg

SAR 10g (W/Kg)	0.061909
SAR 1g (W/Kg)	0.111430

Any report having not been signed by authorized approver, or having been altered without authorization, or having not been stamped by the "Dedicated Testing/Inspection Stamp" is deemed to be invalid. Copying or excerpting portion of, or altering the content of the report is not permitted without the written authorization of AGC. The test results presented in the report apply only to the tested sample. Any objections to report issued by AGC should be submitted to AGC within 15days after the issuance of the test report. Further enquiry of validity or verification of the test report should be addressed to AGC by agc@agc-cert.com.



Z (mm)	0.00	4.00	9.00	14.00	19.00	24.00	29.00
SAR (W/Kg)	0.1744	0.1144	0.0662	0.0391	0.0229	0.0134	0.0080

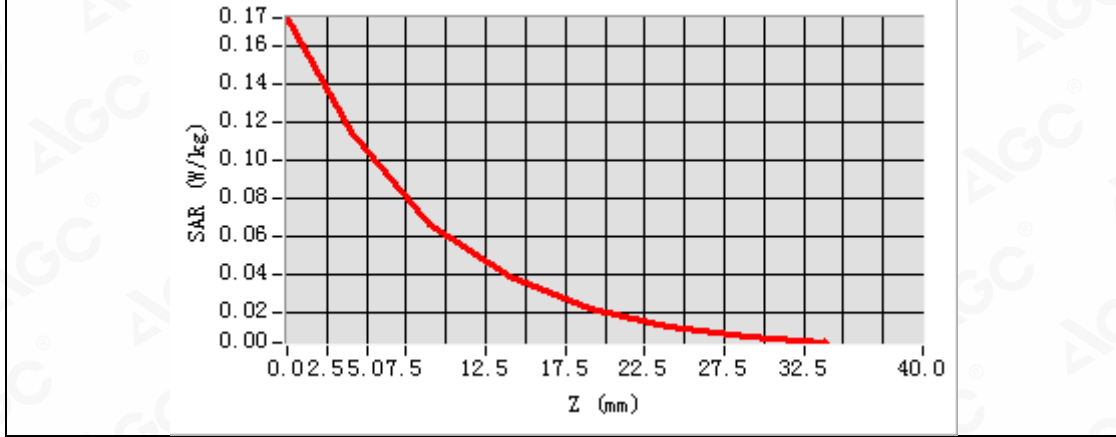

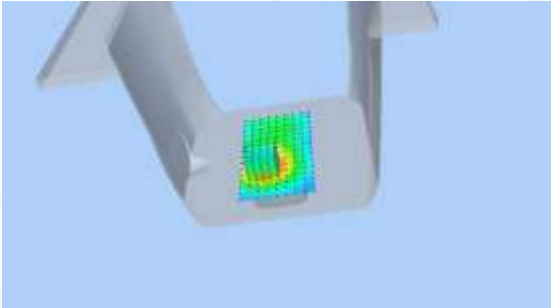
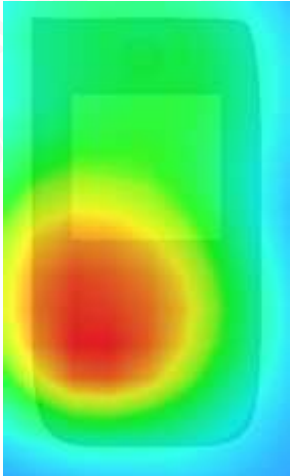
3D screen shot	Hot spot position
	

Any report having not been signed by authorized approver, or having been altered without authorization, or having not been stamped by the "Dedicated Testing/Inspection Stamp" is deemed to be invalid. Copying or excerpting portion of, or altering the content of the report is not permitted without the written authorization of AGC. The test results presented in the report apply only to the tested sample. Any objections to report issued by AGC should be submitted to AGC within 15 days after the issuance of the test report. Further enquiry of validity or verification of the test report should be addressed to AGC by agc@agc-cert.com.



Test Laboratory: AGC Lab
LTE Band 2 Mid-Touch-Right (50% RB#0)
DUT: Mobile phone; Type: P40

Date: Jul. 04,2021

Communication System: LTE; Communication System Band: LTE Band 2; Duty Cycle:1:1; Conv.F=4.48;
Frequency:1880MHz; Medium parameters used: $f=1900$ MHz; $\sigma=1.37$ mho/m; $\epsilon_r=41.53$; $\rho=1000$ kg/m³ ;
Phantom section: Right Section
Ambient temperature (°C): 20.5, Liquid temperature (°C): 20.3

SATIMO Configuration:

- Probe: SSE5; Calibrated: Dec. 17,2020; Serial No.: SN 03/18 EP327
- Sensor-Surface: 4mm (Mechanical Surface Detection)
- Phantom: SAM twin phantom
- Measurement SW: OpenSAR V4_02_35

Configuration/ LTE Band 2 Mid- Touch-Right /Area Scan: Measurement grid: dx=8mm, dy=8mm
Configuration/ LTE Band 2 Mid- Touch-Right /Zoom Scan: Measurement grid: dx=8mm,dy=8mm, dz=5mm;

Area Scan	dx=8mm dy=8mm, h= 5.00 mm
Zoom Scan	5x5x7,dx=8mm dy=8mm dz=5mm
Phantom	Right head
Device Position	Cheek
Band	LTE Band 2
Channels	Middle
Signal	OFDM (Crest factor: 1.0)

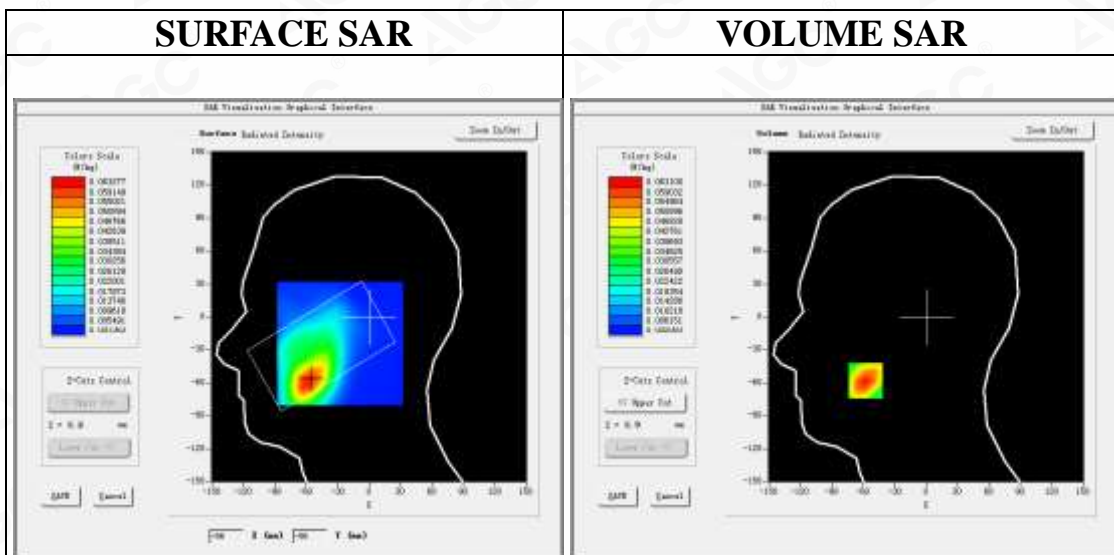

Maximum location: X=-58.00, Y=-58.00
SAR Peak: 0.10 W/kg

SAR 10g (W/Kg)	0.033807
SAR 1g (W/Kg)	0.060760

Any report having not been signed by authorized approver, or having been altered without authorization, or having not been stamped by the "Dedicated Testing/Inspection Stamp" is deemed to be invalid. Copying or excerpting portion of, or altering the content of the report is not permitted without the written authorization of AGC. The test results presented in the report apply only to the tested sample. Any objections to report issued by AGC should be submitted to AGC within 15days after the issuance of the test report. Further enquiry of validity or verification of the test report should be addressed to AGC by agc@agc-cert.com.

Attestation of Global Compliance(Shenzhen)Co., Ltd
Attestation of Global Compliance(Shenzhen)Std & Tech Co., Ltd
Tel: +86-755 2523 4088 E-mail: agc@agc-cert.com Web: http://cn.agc-cert.com/



Z (mm)	0.00	4.00	9.00	14.00	19.00	24.00	29.00
SAR (W/Kg)	0.0985	0.0631	0.0356	0.0214	0.0130	0.0079	0.0052

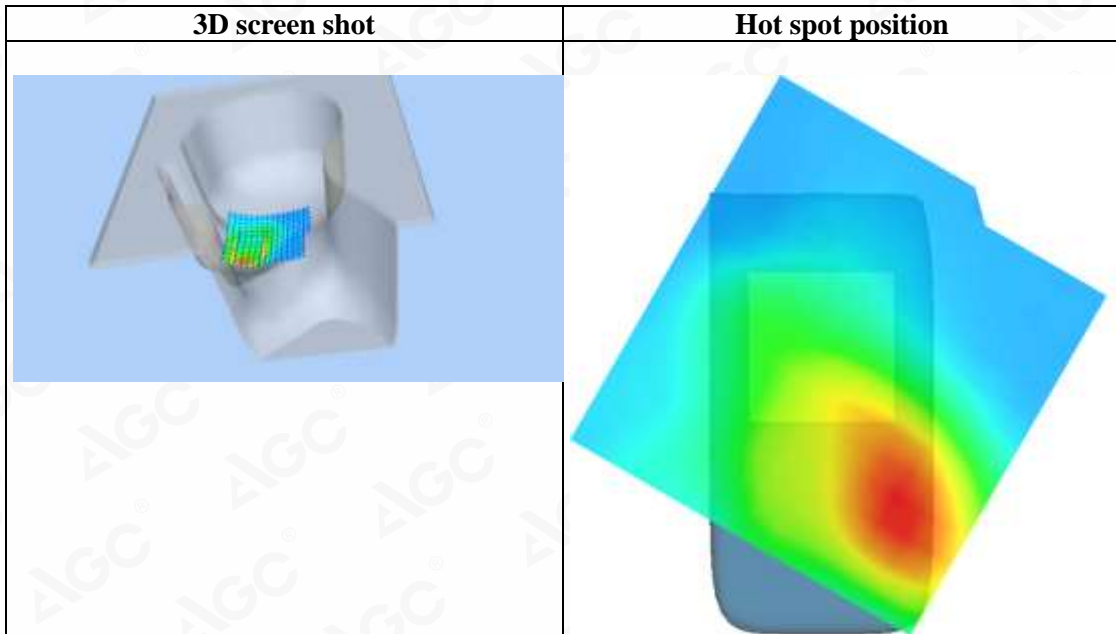
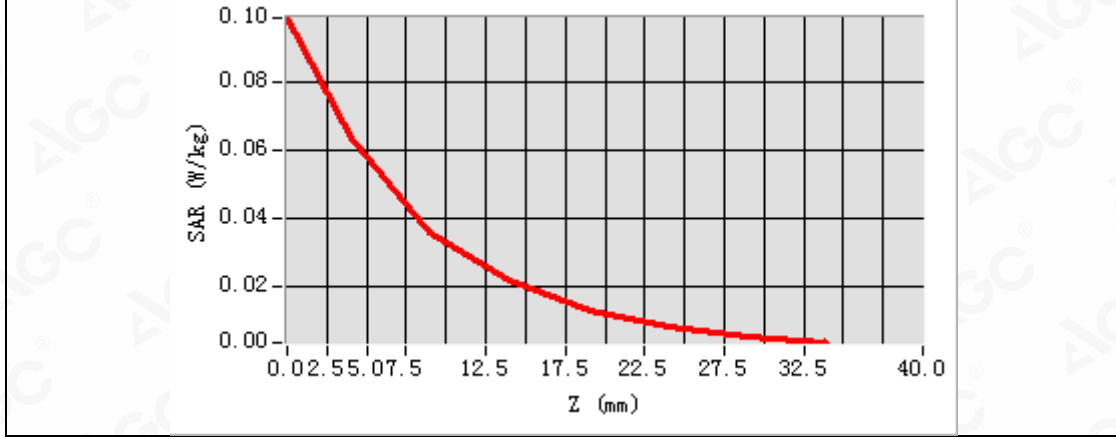

Any report having not been signed by authorized approver, or having been altered without authorization, or having not been stamped by the "Dedicated Testing/Inspection Stamp" is deemed to be invalid. Copying or excerpting portion of, or altering the content of the report is not permitted without the written authorization of AGC. The test results presented in the report apply only to the tested sample. Any objections to report issued by AGC should be submitted to AGC within 15 days after the issuance of the test report. Further enquiry of validity or verification of the test report should be addressed to AGC by agc@agc-cert.com.



Test Laboratory: AGC Lab
LTE Band 2 Mid-Body-Back (50% RB#0)
DUT: Mobile phone; Type: P40

Date: Jul. 04,2021

Communication System: LTE; Communication System Band: LTE Band 2; Duty Cycle:1:1; Conv.F=4.48;
Frequency:1880MHz; Medium parameters used: $f = 1800$ MHz; $\sigma = 1.37$ mho/m; $\epsilon_r = 41.53$; $\rho = 1000$ kg/m³ ;
Phantom section: Flat Section
Ambient temperature (°C): 20.5, Liquid temperature (°C): 20.3

SATIMO Configuration:

- Probe: SSE5; Calibrated: Dec. 17,2020; Serial No.: SN 03/18 EP327
- Sensor-Surface: 4mm (Mechanical Surface Detection)
- Phantom: SAM twin phantom
- Measurement SW: OpenSAR V4_02_35

Configuration/ LTE Band 2 Mid-Body-back/Area Scan: Measurement grid: dx=8mm, dy=8mm
Configuration/ LTE Band 2 Mid-Body-back/Zoom Scan: Measurement grid: dx=8mm,dy=8mm, dz=5mm;

Area Scan	surf_sam_plan.txt, h= 5.00 mm
Zoom Scan	5x5x7,dx=8mm dy=8mm dz=5mm
Phantom	Validation plane
Device Position	Body Back
Band	LTE Band 2
Channels	Middle
Signal	OFDM (Crest factor: 1.0)

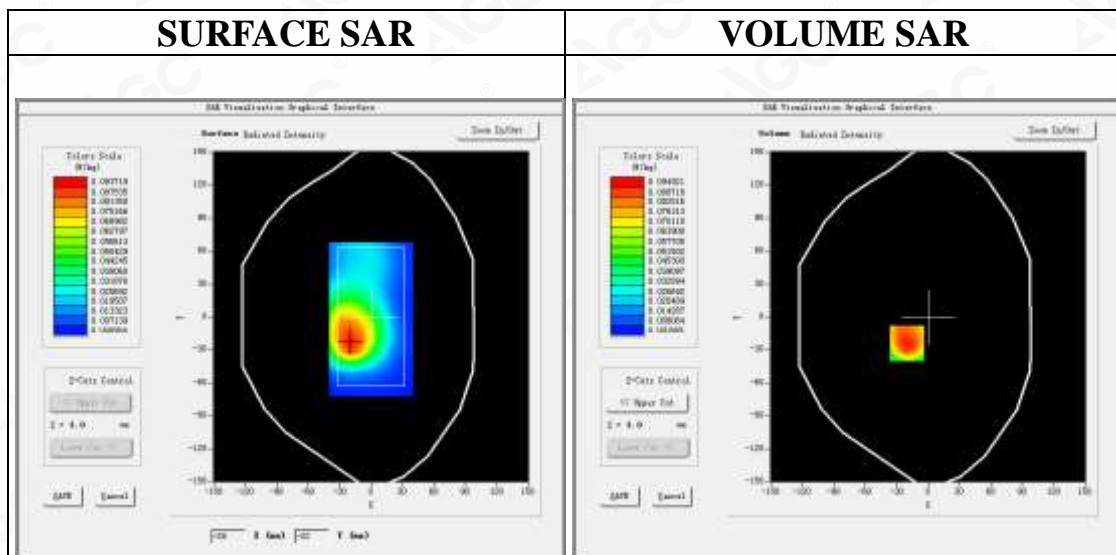

Maximum location: X=-20.00, Y=-24.00
SAR Peak: 0.15 W/kg

SAR 10g (W/Kg)	0.051148
SAR 1g (W/Kg)	0.092150

Any report having not been signed by authorized approver, or having been altered without authorization, or having not been stamped by the "Dedicated Testing/Inspection Stamp" is deemed to be invalid. Copying or excerpting portion of, or altering the content of the report is not permitted without the written authorization of AGC. The test results presented in the report apply only to the tested sample. Any objections to report issued by AGC should be submitted to AGC within 15days after the issuance of the test report. Further enquiry of validity or verification of the test report should be addressed to AGC by agc@agc-cert.com.



Z (mm)	0.00	4.00	9.00	14.00	19.00	24.00	29.00
SAR (W/Kg)	0.1455	0.0949	0.0545	0.0321	0.0187	0.0110	0.0066

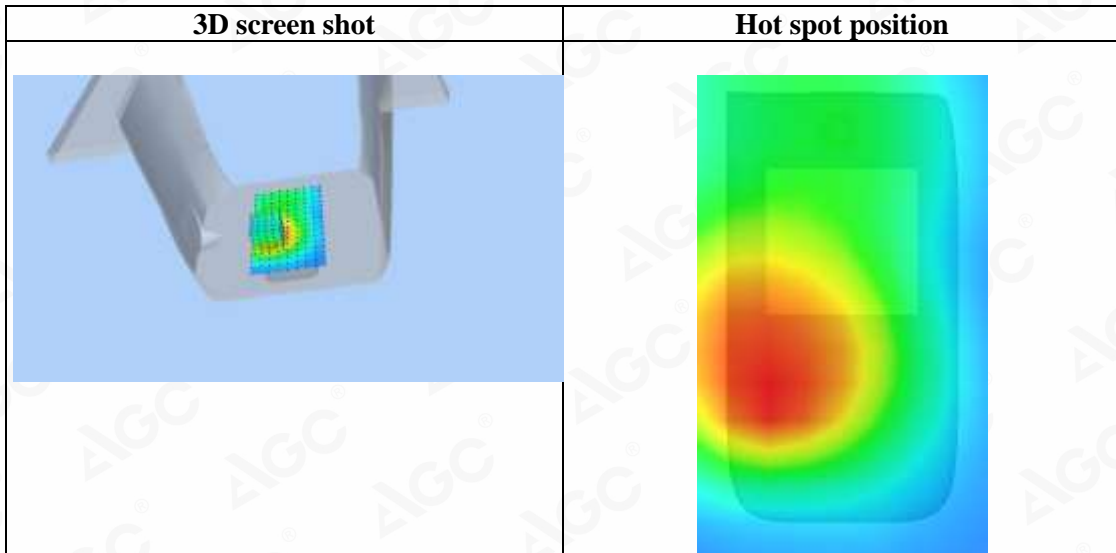
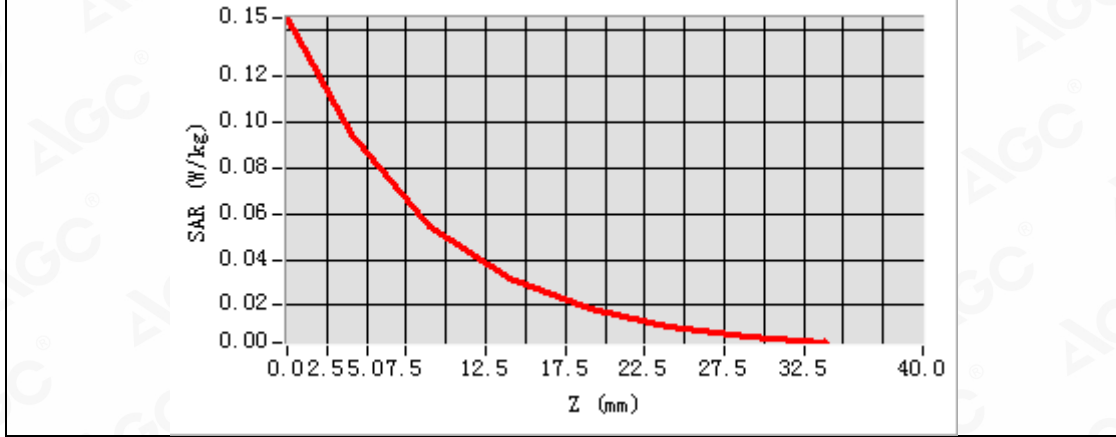

Any report having not been signed by authorized approver, or having been altered without authorization, or having not been stamped by the "Dedicated Testing/Inspection Stamp" is deemed to be invalid. Copying or excerpting portion of, or altering the content of the report is not permitted without the written authorization of AGC. The test results presented in the report apply only to the tested sample. Any objections to report issued by AGC should be submitted to AGC within 15days after the issuance of the test report. Further enquiry of validity or verification of the test report should be addressed to AGC by agc@agc-cert.com.



Test Laboratory: AGC Lab
LTE Band 4 Mid-Touch-Right (1 RB#0)
DUT: Mobile phone; Type: P40

Date: Jul. 05,2021

Communication System: LTE; Communication System Band: LTE Band 4; Duty Cycle:1:1; Conv.F=4.48;
Frequency:1732.5 MHz; Medium parameters used: $f = 1750$ MHz; $\sigma = 1.28$ mho/m; $\epsilon_r = 41.35$; $\rho = 1000$ kg/m³ ;
Phantom section: Right Section
Ambient temperature (°C): 21.4, Liquid temperature (°C): 21.2

SATIMO Configuration:

- Probe: SSE5; Calibrated: Dec. 17,2020; Serial No.: SN 03/18 EP327
- Sensor-Surface: 4mm (Mechanical Surface Detection)
- Phantom: SAM twin phantom
- Measurement SW: OpenSAR V4_02_35

Configuration/ LTE Band 4 Mid- Touch-Right /Area Scan: Measurement grid: dx=8mm, dy=8mm
Configuration/ LTE Band 4 Mid- Touch-Right /Zoom Scan: Measurement grid: dx=8mm,dy=8mm, dz=5mm;

Area Scan	dx=8mm dy=8mm, h= 5.00 mm
Zoom Scan	5x5x7,dx=8mm dy=8mm dz=5mm
Phantom	Right head
Device Position	Cheek
Band	LTE Band 4
Channels	Middle
Signal	OFDM (Crest factor: 1.0)

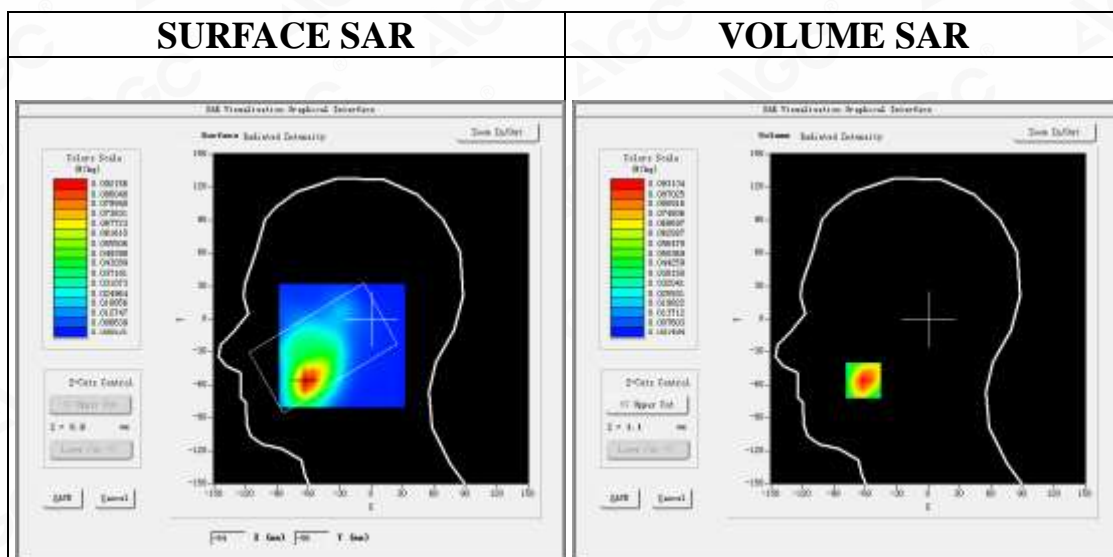

Maximum location: X=-62.00, Y=-56.00
SAR Peak: 0.15 W/kg

SAR 10g (W/Kg)	0.047534
SAR 1g (W/Kg)	0.088831

Any report having not been signed by authorized approver, or having been altered without authorization, or having not been stamped by the "Dedicated Testing/Inspection Stamp" is deemed to be invalid. Copying or excerpting portion of, or altering the content of the report is not permitted without the written authorization of AGC. The test results presented in the report apply only to the tested sample. Any objections to report issued by AGC should be submitted to AGC within 15days after the issuance of the test report. Further enquiry of validity or verification of the test report should be addressed to AGC by agc@agc-cert.com.



Z (mm)	0.00	4.00	9.00	14.00	19.00	24.00	29.00
SAR (W/Kg)	0.1478	0.0931	0.0507	0.0291	0.0161	0.0092	0.0053

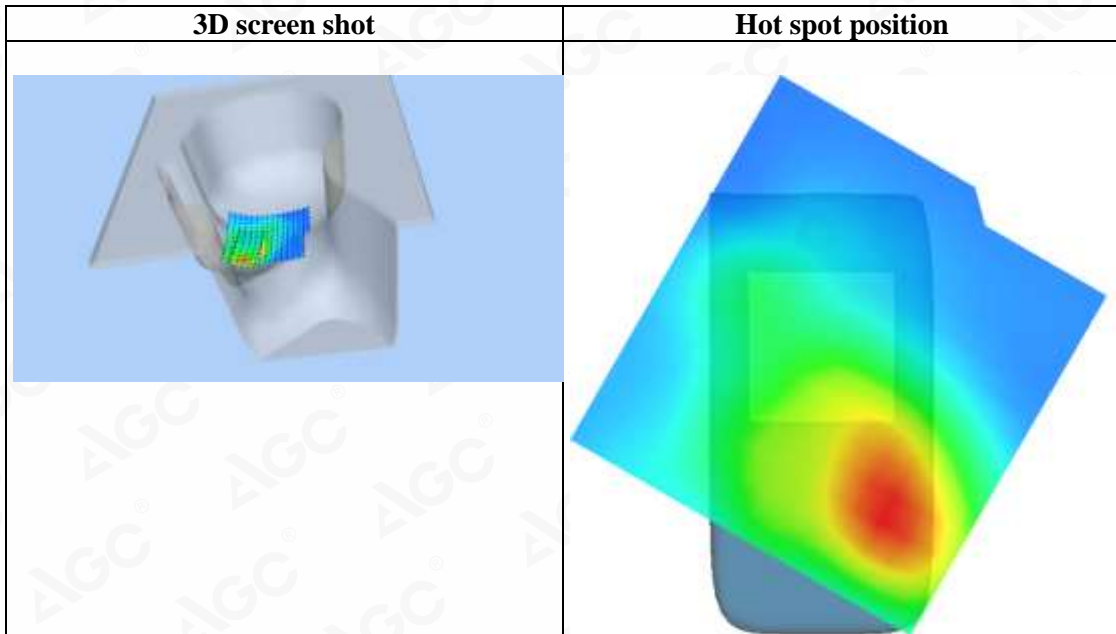
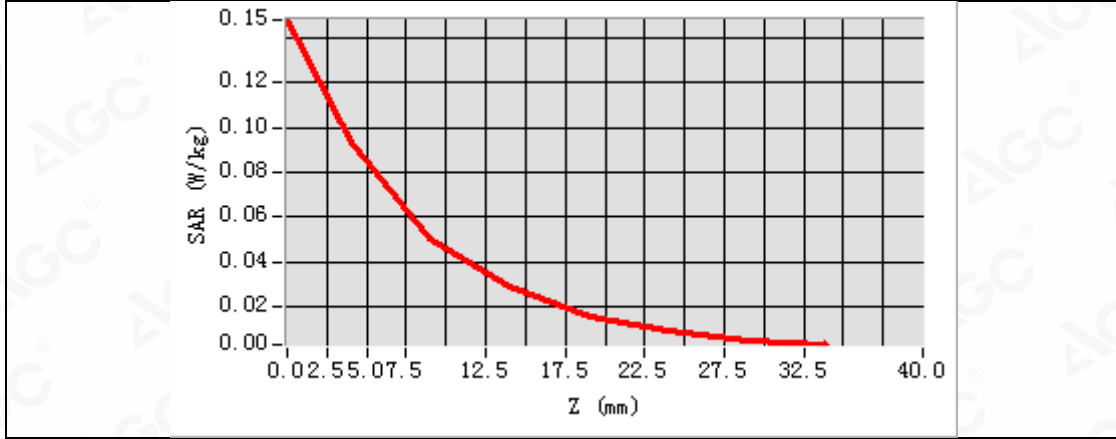

Any report having not been signed by authorized approver, or having been altered without authorization, or having not been stamped by the "Dedicated Testing/Inspection Stamp" is deemed to be invalid. Copying or excerpting portion of, or altering the content of the report is not permitted without the written authorization of AGC. The test results presented in the report apply only to the tested sample. Any objections to report issued by AGC should be submitted to AGC within 15 days after the issuance of the test report. Further enquiry of validity or verification of the test report should be addressed to AGC by agc@agc-cert.com.



Test Laboratory: AGC Lab
LTE Band 4 Mid-Body-Back (1 RB#0)
DUT: Mobile phone; Type: P40

Date: Jul. 05,2021

Communication System: LTE; Communication System Band: LTE Band 4; Duty Cycle:1:1; Conv.F=4.48;
Frequency:1732.5 MHz; Medium parameters used: $f = 1800$ MHz; $\sigma = 1.28$ mho/m; $\epsilon_r = 41.35$; $\rho = 1000$ kg/m³ ;
Phantom section: Flat Section
Ambient temperature (°C): 21.4, Liquid temperature (°C): 21.2

SATIMO Configuration:

- Probe: SSE5; Calibrated: Dec. 17,2020; Serial No.: SN 03/18 EP327
- Sensor-Surface: 4mm (Mechanical Surface Detection)
- Phantom: SAM twin phantom
- Measurement SW: OpenSAR V4_02_35

Configuration/ LTE Band 4 Mid-Body-back/Area Scan: Measurement grid: dx=8mm, dy=8mm
Configuration/ LTE Band 4 Mid-Body-back/Zoom Scan: Measurement grid: dx=8mm,dy=8mm, dz=5mm;

Area Scan	surf_sam_plan.txt, h= 5.00 mm
Zoom Scan	5x5x7,dx=8mm dy=8mm dz=5mm
Phantom	Validation plane
Device Position	Body Back
Band	LTE Band 4
Channels	Middle
Signal	OFDM (Crest factor: 1.0)

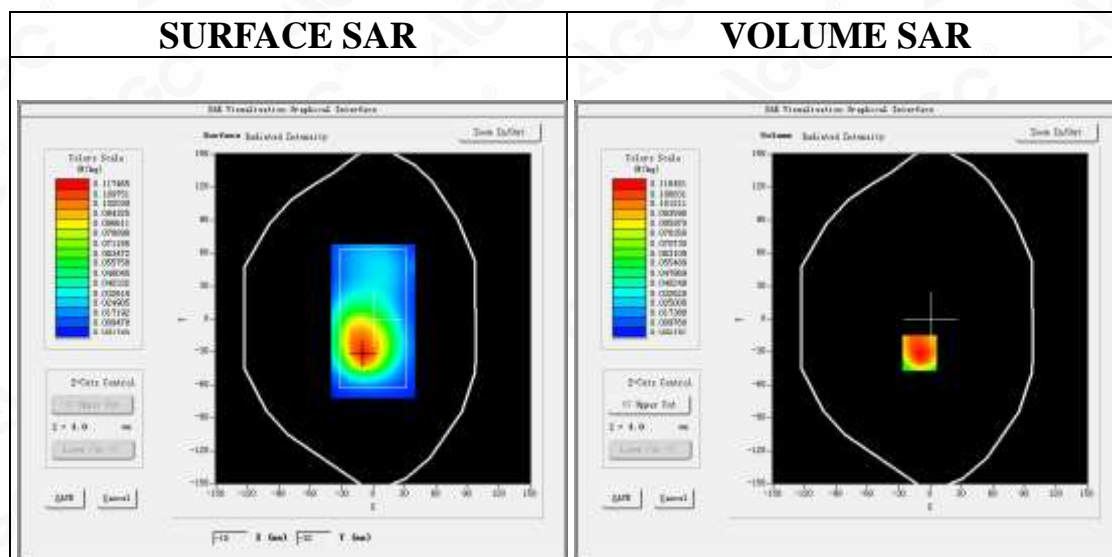

Maximum location: X=-10.00, Y=-31.00
SAR Peak: 0.18 W/kg

SAR 10g (W/Kg)	0.063588
SAR 1g (W/Kg)	0.113675

Any report having not been signed by authorized approver, or having been altered without authorization, or having not been stamped by the "Dedicated Testing/Inspection Stamp" is deemed to be invalid. Copying or excerpting portion of, or altering the content of the report is not permitted without the written authorization of AGC. The test results presented in the report apply only to the tested sample. Any objections to report issued by AGC should be submitted to AGC within 15days after the issuance of the test report. Further enquiry of validity or verification of the test report should be addressed to AGC by agc@agc-cert.com.



Z (mm)	0.00	4.00	9.00	14.00	19.00	24.00	29.00
SAR (W/Kg)	0.1778	0.1165	0.0671	0.0395	0.0230	0.0135	0.0079

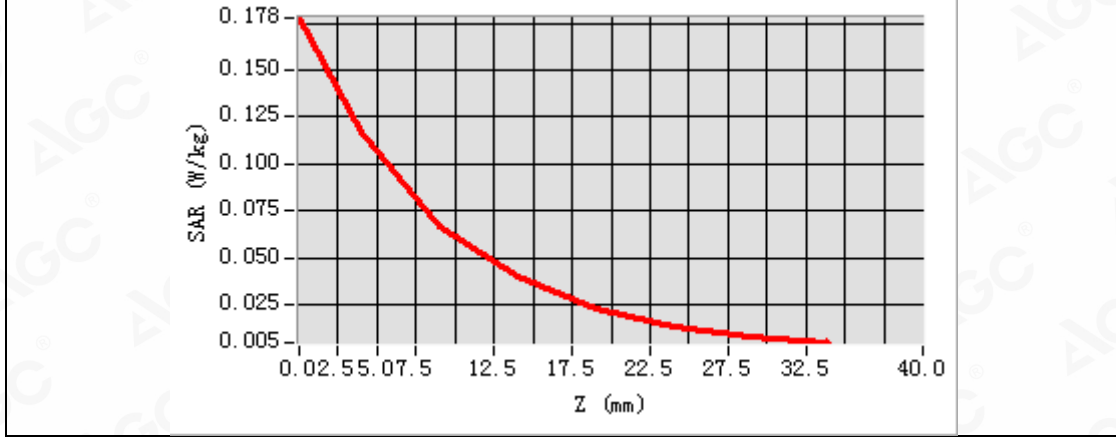

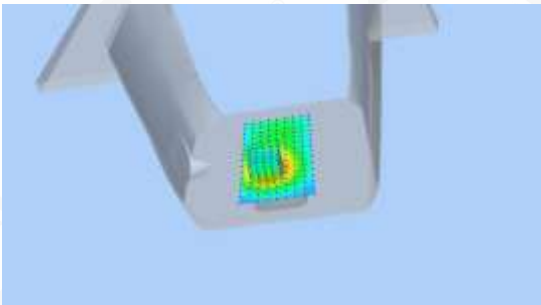
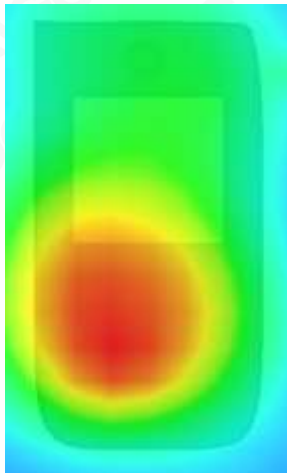
3D screen shot	Hot spot position
	

Any report having not been signed by authorized approver, or having been altered without authorization, or having not been stamped by the "Dedicated Testing/Inspection Stamp" is deemed to be invalid. Copying or excerpting portion of, or altering the content of the report is not permitted without the written authorization of AGC. The test results presented in the report apply only to the tested sample. Any objections to report issued by AGC should be submitted to AGC within 15 days after the issuance of the test report. Further enquiry of validity or verification of the test report should be addressed to AGC by agc@agc-cert.com.



Test Laboratory: AGC Lab
LTE Band 4 Mid-Touch-Right (50% RB#0)
DUT: Mobile phone; Type: P40

Date: Jul. 05,2021

Communication System: LTE; Communication System Band: LTE Band 4; Duty Cycle:1:1; Conv.F=4.48;
Frequency:1732.5 MHz; Medium parameters used: f =1750 MHz; $\sigma = 1.28$ mho/m; $\epsilon_r = 41.35$; $\rho = 1000$ kg/m³ ;
Phantom section: Right Section
Ambient temperature (°C): 21.4, Liquid temperature (°C): 21.2

SATIMO Configuration:

- Probe: SSE5; Calibrated: Dec. 17,2020; Serial No.: SN 03/18 EP327
- Sensor-Surface: 4mm (Mechanical Surface Detection)
- Phantom: SAM twin phantom
- Measurement SW: OpenSAR V4_02_35

Configuration/ LTE Band 4 Mid- Touch-Right /Area Scan: Measurement grid: dx=8mm, dy=8mm
Configuration/ LTE Band 4 Mid- Touch-Right /Zoom Scan: Measurement grid: dx=8mm,dy=8mm, dz=5mm;

Area Scan	dx=8mm dy=8mm, h= 5.00 mm
Zoom Scan	5x5x7,dx=8mm dy=8mm dz=5mm
Phantom	Right head
Device Position	Cheek
Band	LTE Band 4
Channels	Middle
Signal	OFDM (Crest factor: 1.0)

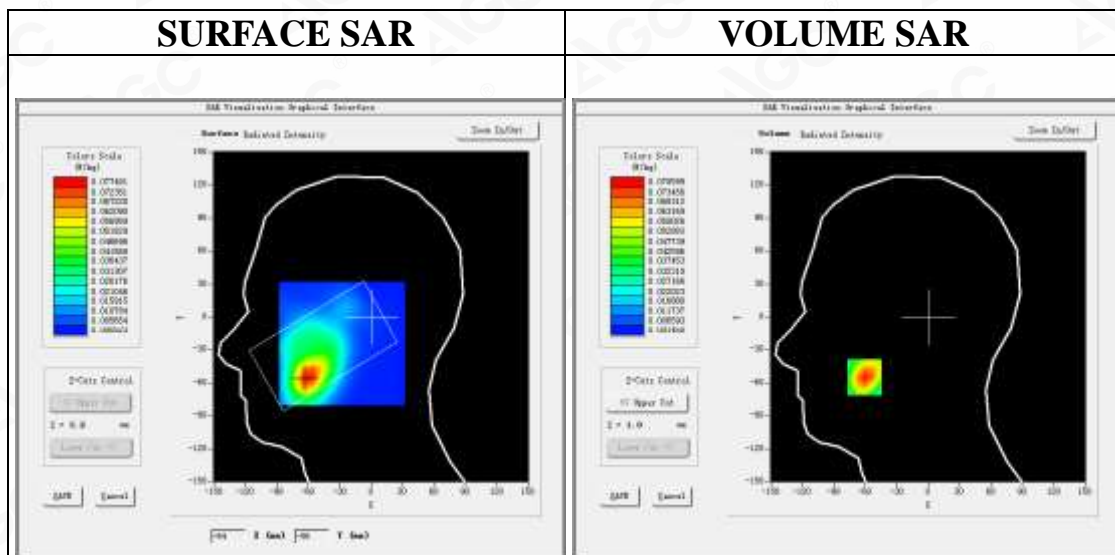

Maximum location: X=-61.00, Y=-55.00
SAR Peak: 0.12 W/kg

SAR 10g (W/Kg)	0.039859
SAR 1g (W/Kg)	0.074411

Any report having not been signed by authorized approver, or having been altered without authorization, or having not been stamped by the "Dedicated Testing/Inspection Stamp" is deemed to be invalid. Copying or excerpting portion of, or altering the content of the report is not permitted without the written authorization of AGC. The test results presented in the report apply only to the tested sample. Any objections to report issued by AGC should be submitted to AGC within 15days after the issuance of the test report. Further enquiry of validity or verification of the test report should be addressed to AGC by agc@agc-cert.com.



Z (mm)	0.00	4.00	9.00	14.00	19.00	24.00	29.00
SAR (W/Kg)	0.1236	0.0786	0.0432	0.0247	0.0136	0.0079	0.0045

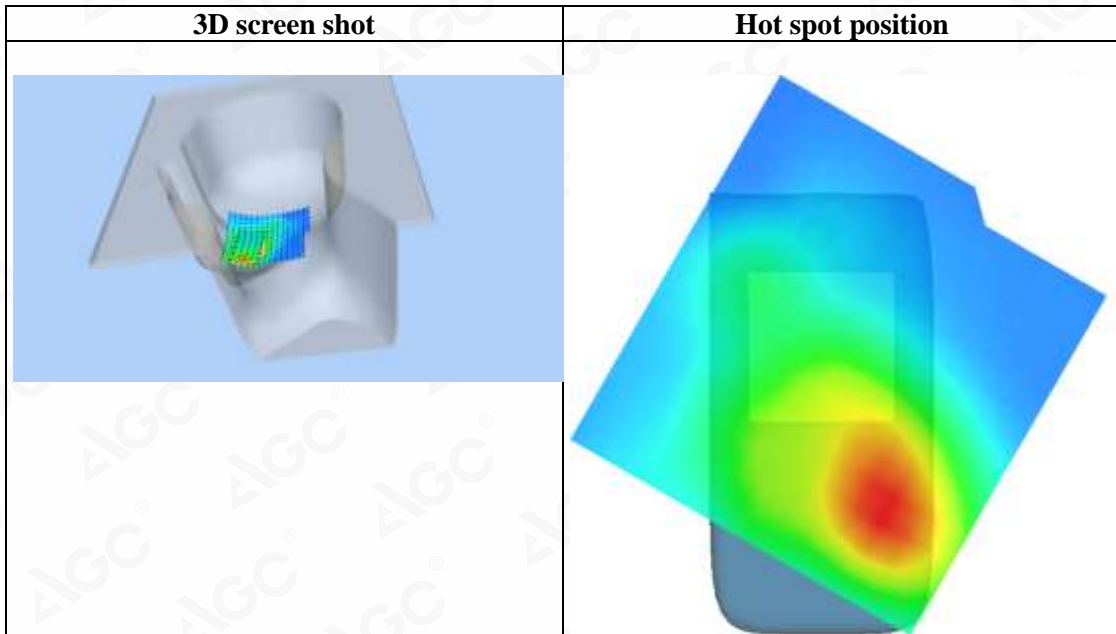
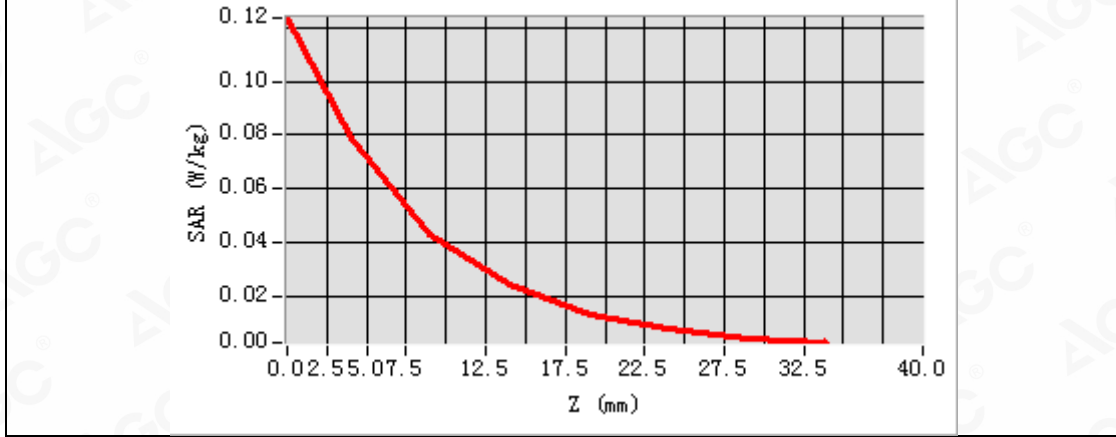

Any report having not been signed by authorized approver, or having been altered without authorization, or having not been stamped by the "Dedicated Testing/Inspection Stamp" is deemed to be invalid. Copying or excerpting portion of, or altering the content of the report is not permitted without the written authorization of AGC. The test results presented in the report apply only to the tested sample. Any objections to report issued by AGC should be submitted to AGC within 15 days after the issuance of the test report. Further enquiry of validity or verification of the test report should be addressed to AGC by agc@agc-cert.com.



Test Laboratory: AGC Lab
LTE Band 4 Mid-Body-Back (50% RB#0)
DUT: Mobile phone; Type: P40

Date: Jul. 05,2021

Communication System: LTE; Communication System Band: LTE Band 4; Duty Cycle:1:1; Conv.F=4.48;
Frequency:1732.5 MHz; Medium parameters used: $f = 1800$ MHz; $\sigma = 1.28$ mho/m; $\epsilon_r = 41.35$; $\rho = 1000$ kg/m³ ;
Phantom section: Flat Section
Ambient temperature (°C): 21.4, Liquid temperature (°C): 21.2

SATIMO Configuration:

- Probe: SSE5; Calibrated: Dec. 17,2020; Serial No.: SN 03/18 EP327
- Sensor-Surface: 4mm (Mechanical Surface Detection)
- Phantom: SAM twin phantom
- Measurement SW: OpenSAR V4_02_35

Configuration/ LTE Band 4 Mid-Body-back/Area Scan: Measurement grid: dx=8mm, dy=8mm
Configuration/ LTE Band 4 Mid-Body-back/Zoom Scan: Measurement grid: dx=8mm,dy=8mm, dz=5mm;

Area Scan	surf_sam_plan.txt, h= 5.00 mm
Zoom Scan	5x5x7,dx=8mm dy=8mm dz=5mm
Phantom	Validation plane
Device Position	Body Back
Band	LTE Band 4
Channels	Middle
Signal	OFDM (Crest factor: 1.0)

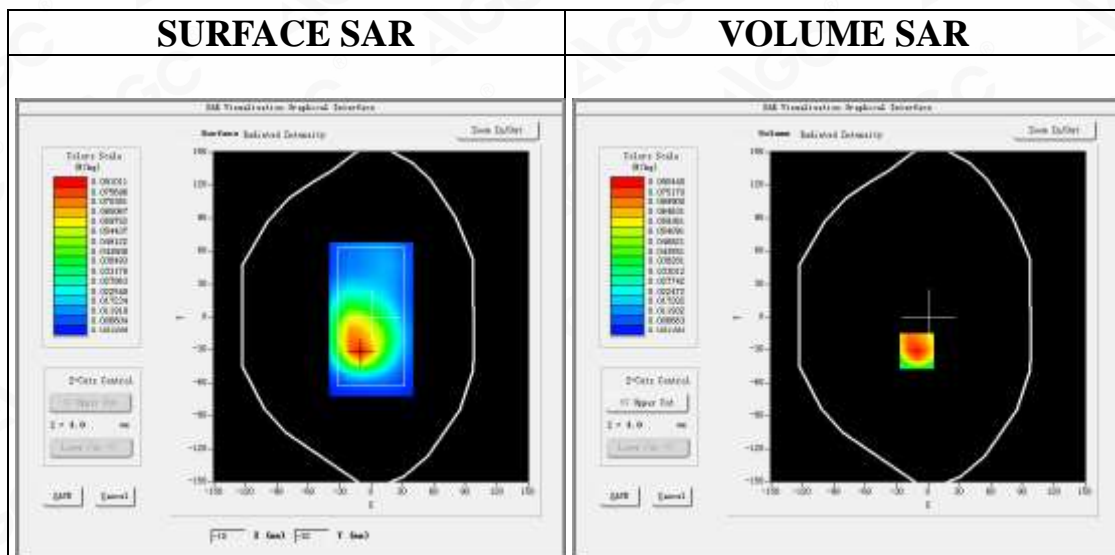

Maximum location: X=-11.00, Y=-31.00
SAR Peak: 0.13 W/kg

SAR 10g (W/Kg)	0.042333
SAR 1g (W/Kg)	0.077524

Any report having not been signed by authorized approver, or having been altered without authorization, or having not been stamped by the "Dedicated Testing/Inspection Stamp" is deemed to be invalid. Copying or excerpting portion of, or altering the content of the report is not permitted without the written authorization of AGC. The test results presented in the report apply only to the tested sample. Any objections to report issued by AGC should be submitted to AGC within 15days after the issuance of the test report. Further enquiry of validity or verification of the test report should be addressed to AGC by agc@agc-cert.com.



Z (mm)	0.00	4.00	9.00	14.00	19.00	24.00	29.00
SAR (W/Kg)	0.1250	0.0804	0.0452	0.0259	0.0150	0.0085	0.0050

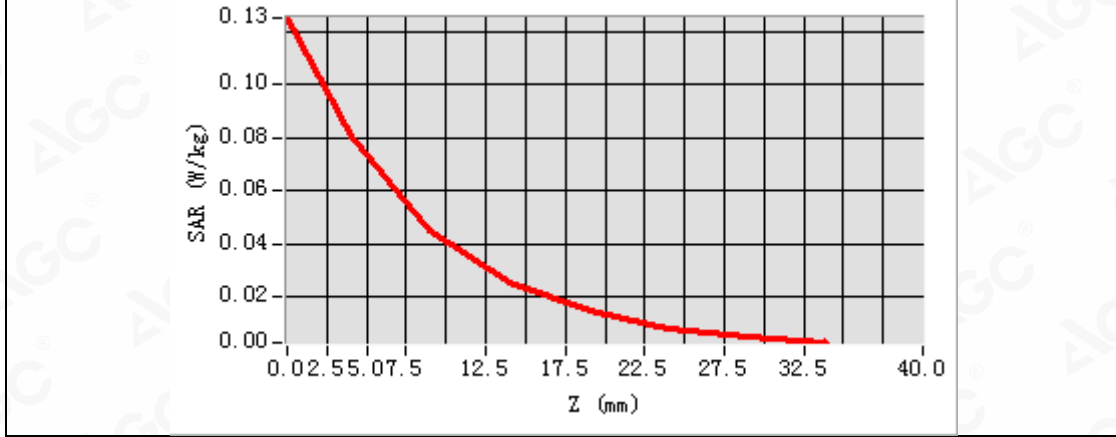

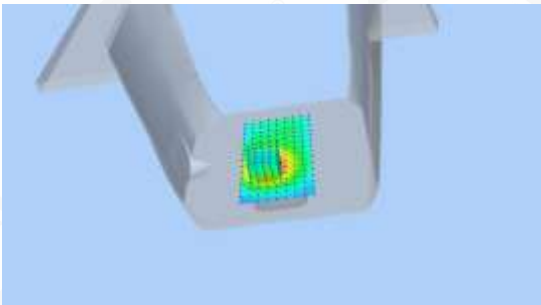
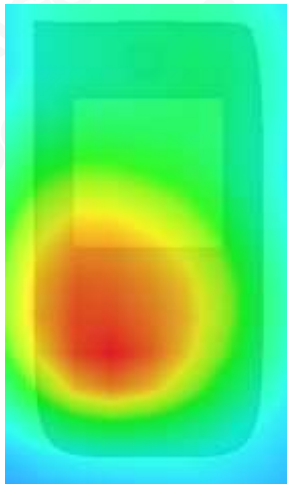
3D screen shot	Hot spot position
	

Any report having not been signed by authorized approver, or having been altered without authorization, or having not been stamped by the "Dedicated Testing/Inspection Stamp" is deemed to be invalid. Copying or excerpting portion of, or altering the content of the report is not permitted without the written authorization of AGC. The test results presented in the report apply only to the tested sample. Any objections to report issued by AGC should be submitted to AGC within 15 days after the issuance of the test report. Further enquiry of validity or verification of the test report should be addressed to AGC by agc@agc-cert.com.



Test Laboratory: AGC Lab
LTE Band 66 Mid-Touch-Right (1 RB#0)
DUT: Mobile phone; Type: P40

Date: Jul. 05,2021

Communication System: LTE; Communication System Band: LTE Band 66; Duty Cycle:1:1; Conv.F=4.48;
Frequency:1755 MHz; Medium parameters used: $f = 1750$ MHz; $\sigma = 1.40$ mho/m; $\epsilon_r = 38.69$; $\rho = 1000$ kg/m³ ;
Phantom section: Right Section
Ambient temperature (°C): 21.4, Liquid temperature (°C): 21.2

SATIMO Configuration:

- Probe: SSE5; Calibrated: Dec. 17,2020; Serial No.: SN 03/18 EP327
- Sensor-Surface: 4mm (Mechanical Surface Detection)
- Phantom: SAM twin phantom
- Measurement SW: OpenSAR V4_02_35

Configuration/ LTE Band 66 Mid- Touch-Right /Area Scan: Measurement grid: dx=8mm, dy=8mm

Configuration/ LTE Band 66 Mid- Touch-Right /Zoom Scan: Measurement grid: dx=8mm, dy=8mm, dz=5mm;

Area Scan	dx=8mm dy=8mm, h= 5.00 mm
Zoom Scan	5x5x7,dx=8mm dy=8mm dz=5mm
Phantom	Right head
Device Position	Cheek
Band	LTE Band 66
Channels	Middle
Signal	OFDM (Crest factor: 1.0)

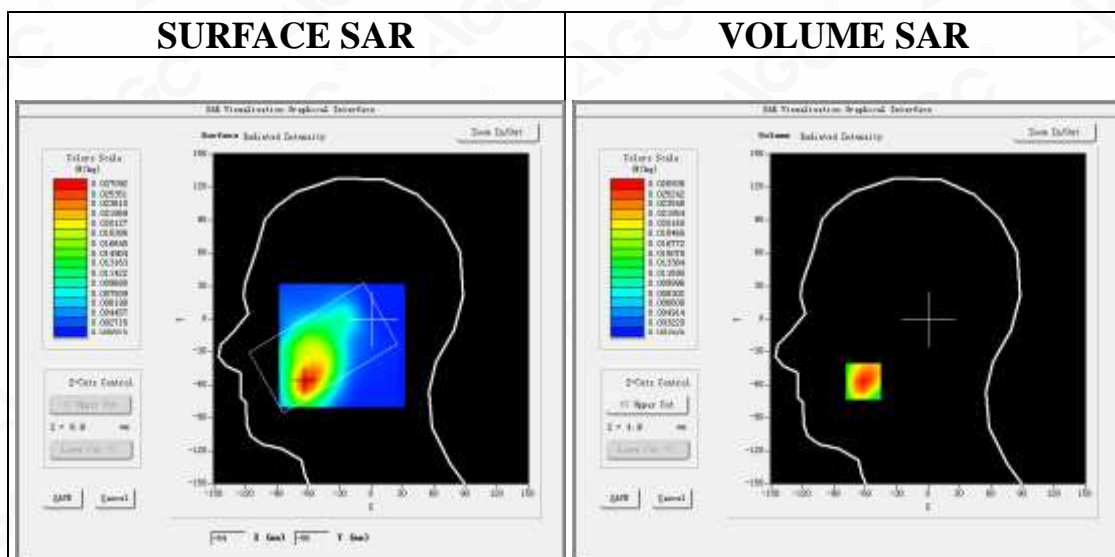

Maximum location: X=-62.00, Y=-57.00

SAR Peak: 0.04 W/kg

SAR 10g (W/Kg)	0.015270
SAR 1g (W/Kg)	0.025924

Any report having not been signed by authorized approver, or having been altered without authorization, or having not been stamped by the "Dedicated Testing/Inspection Stamp" is deemed to be invalid. Copying or excerpting portion of, or altering the content of the report is not permitted without the written authorization of AGC. The test results presented in the report apply only to the tested sample. Any objections to report issued by AGC should be submitted to AGC within 15days after the issuance of the test report. Further enquiry of validity or verification of the test report should be addressed to AGC by agc@agc-cert.com.



Z (mm)	0.00	4.00	9.00	14.00	19.00	24.00	29.00
SAR (W/Kg)	0.0414	0.0269	0.0157	0.0096	0.0063	0.0040	0.0028

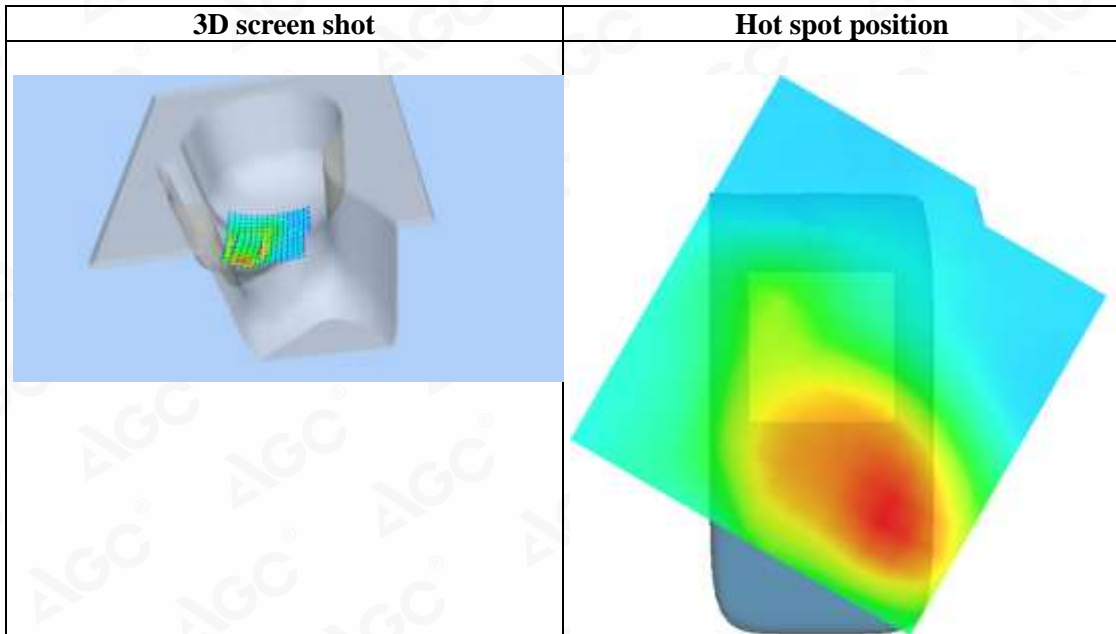
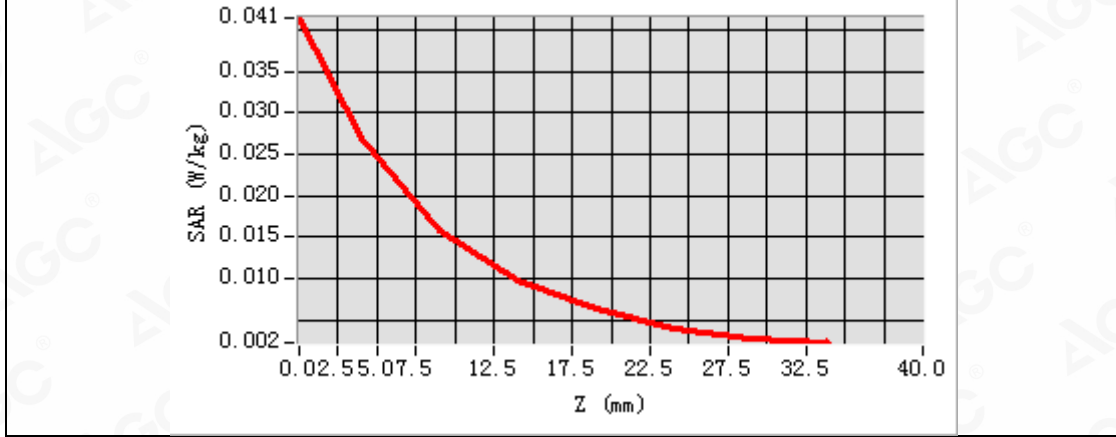

Any report having not been signed by authorized approver, or having been altered without authorization, or having not been stamped by the "Dedicated Testing/Inspection Stamp" is deemed to be invalid. Copying or excerpting portion of, or altering the content of the report is not permitted without the written authorization of AGC. The test results presented in the report apply only to the tested sample. Any objections to report issued by AGC should be submitted to AGC within 15 days after the issuance of the test report. Further enquiry of validity or verification of the test report should be addressed to AGC by agc@agc-cert.com.



Test Laboratory: AGC Lab
LTE Band 66 Mid-Body-Back (1 RB#0)
DUT: Mobile phone; Type: P40

Date: Jul. 05,2021

Communication System: LTE; Communication System Band: LTE Band 66; Duty Cycle:1:1; Conv.F=4.48;
Frequency:1755 MHz; Medium parameters used: $f = 1800$ MHz; $\sigma=1.40$ mho/m; $\epsilon_r = 38.69$; $\rho= 1000$ kg/m³ ;
Phantom section: Flat Section
Ambient temperature (°C): 21.4, Liquid temperature (°C): 21.2

SATIMO Configuration:

- Probe: SSE5; Calibrated: Dec. 17,2020; Serial No.: SN 03/18 EP327
- Sensor-Surface: 4mm (Mechanical Surface Detection)
- Phantom: SAM twin phantom
- Measurement SW: OpenSAR V4_02_35

Configuration/ LTE Band 66 Mid-Body-back/Area Scan: Measurement grid: dx=8mm, dy=8mm

Configuration/ LTE Band 66 Mid-Body-back/Zoom Scan: Measurement grid: dx=8mm,dy=8mm, dz=5m;

Area Scan	surf_sam_plan.txt, h= 5.00 mm
Zoom Scan	5x5x7,dx=8mm dy=8mm dz=5mm
Phantom	Validation plane
Device Position	Body Back
Band	LTE Band 66
Channels	Middle
Signal	OFDM (Crest factor: 1.0)

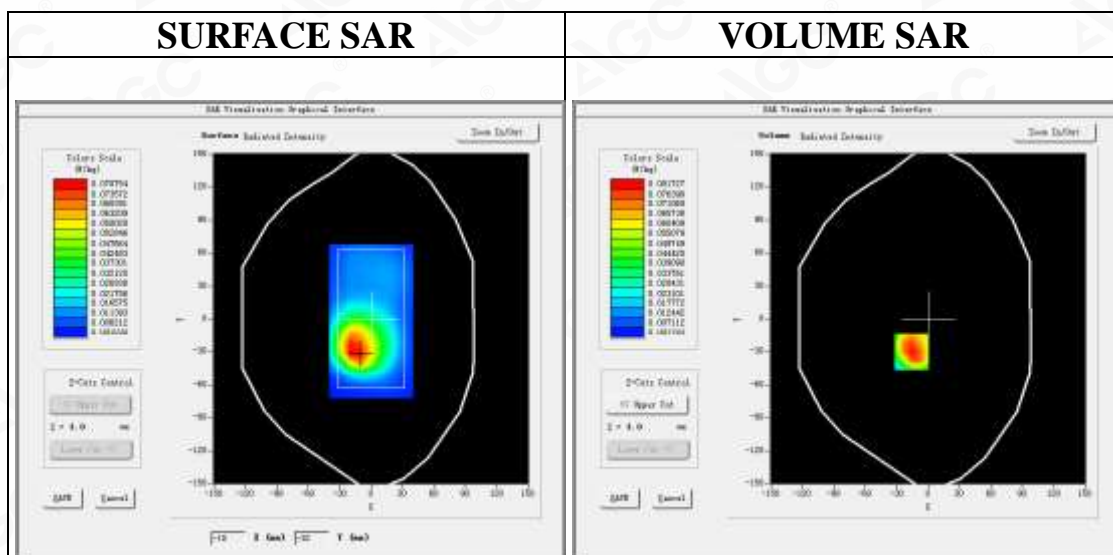

Maximum location: X=-16.00, Y=-30.00

SAR Peak: 0.13 W/kg

SAR 10g (W/Kg)	0.042936
SAR 1g (W/Kg)	0.078557

Any report having not been signed by authorized approver, or having been altered without authorization, or having not been stamped by the "Dedicated Testing/Inspection Stamp" is deemed to be invalid. Copying or excerpting portion of, or altering the content of the report is not permitted without the written authorization of AGC. The test results presented in the report apply only to the tested sample. Any objections to report issued by AGC should be submitted to AGC within 15days after the issuance of the test report. Further enquiry of validity or verification of the test report should be addressed to AGC by agc@agc-cert.com.

Attestation of Global Compliance(Shenzhen)Co., Ltd
Attestation of Global Compliance(Shenzhen)Std & Tech Co., Ltd
Tel: +86-755 2523 4088 E-mail: agc@agc-cert.com Web: http://cn.agc-cert.com/



Z (mm)	0.00	4.00	9.00	14.00	19.00	24.00	29.00
SAR (W/Kg)	0.1266	0.0817	0.0465	0.0273	0.0163	0.0098	0.0060

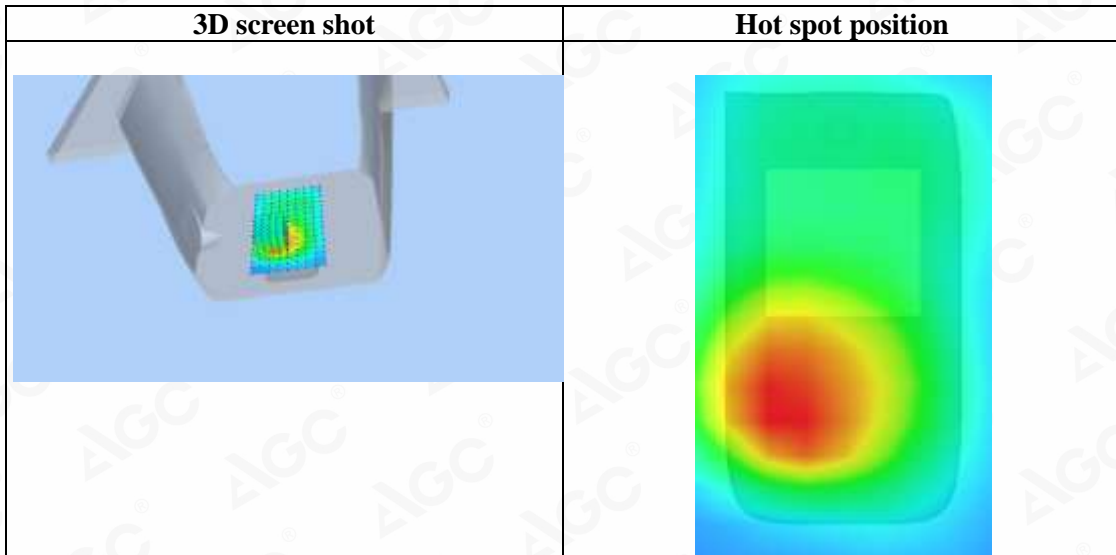
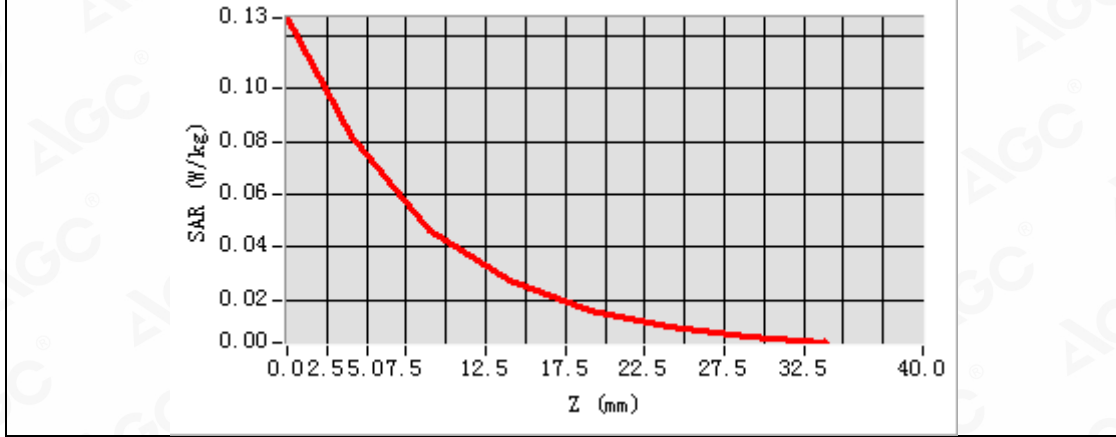

Any report having not been signed by authorized approver, or having been altered without authorization, or having not been stamped by the "Dedicated Testing/Inspection Stamp" is deemed to be invalid. Copying or excerpting portion of, or altering the content of the report is not permitted without the written authorization of AGC. The test results presented in the report apply only to the tested sample. Any objections to report issued by AGC should be submitted to AGC within 15 days after the issuance of the test report. Further enquiry of validity or verification of the test report should be addressed to AGC by agc@agc-cert.com.



Test Laboratory: AGC Lab
LTE Band 66 Mid-Touch-Right (50% RB#0)
DUT: Mobile phone; Type: P40

Date: Jul. 05,2021

Communication System: LTE; Communication System Band: LTE Band 66; Duty Cycle:1:1; Conv.F=4.48;
Frequency:1755 MHz; Medium parameters used: $f = 1750$ MHz; $\sigma = 1.40$ mho/m; $\epsilon_r = 38.69$; $\rho = 1000$ kg/m³ ;
Phantom section: Right Section
Ambient temperature (°C): 21.4, Liquid temperature (°C): 21.2

SATIMO Configuration:

- Probe: SSE5; Calibrated: Dec. 17,2020; Serial No.: SN 03/18 EP327
- Sensor-Surface: 4mm (Mechanical Surface Detection)
- Phantom: SAM twin phantom
- Measurement SW: OpenSAR V4_02_35

Configuration/ LTE Band 66 Mid- Touch-Right /Area Scan: Measurement grid: dx=8mm, dy=8mm

Configuration/ LTE Band 66 Mid- Touch-Right /Zoom Scan: Measurement grid: dx=8mm, dy=8mm, dz=5mm;

Area Scan	dx=8mm dy=8mm, h= 5.00 mm
Zoom Scan	5x5x7,dx=8mm dy=8mm dz=5mm
Phantom	Right head
Device Position	Cheek
Band	LTE Band 66
Channels	Middle
Signal	OFDM (Crest factor: 1.0)

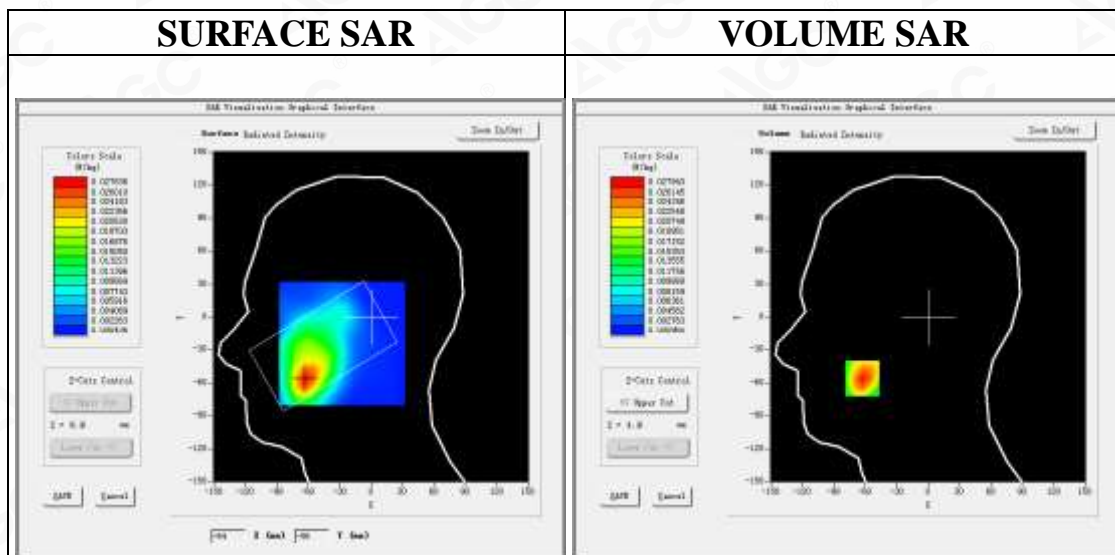

Maximum location: X=-63.00, Y=-56.00

SAR Peak: 0.04 W/kg

SAR 10g (W/Kg)	0.015008
SAR 1g (W/Kg)	0.026641

Any report having not been signed by authorized approver, or having been altered without authorization, or having not been stamped by the "Dedicated Testing/Inspection Stamp" is deemed to be invalid. Copying or excerpting portion of, or altering the content of the report is not permitted without the written authorization of AGC. The test results presented in the report apply only to the tested sample. Any objections to report issued by AGC should be submitted to AGC within 15days after the issuance of the test report. Further enquiry of validity or verification of the test report should be addressed to AGC by agc@agc-cert.com.



Z (mm)	0.00	4.00	9.00	14.00	19.00	24.00	29.00
SAR (W/Kg)	0.0429	0.0279	0.0161	0.0093	0.0057	0.0035	0.0022

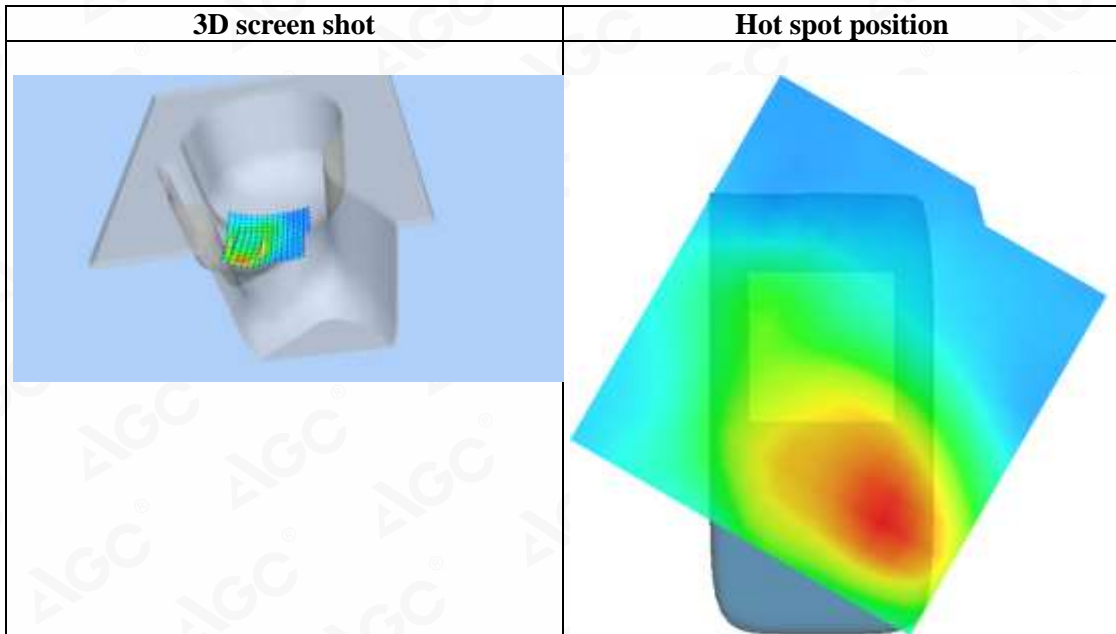
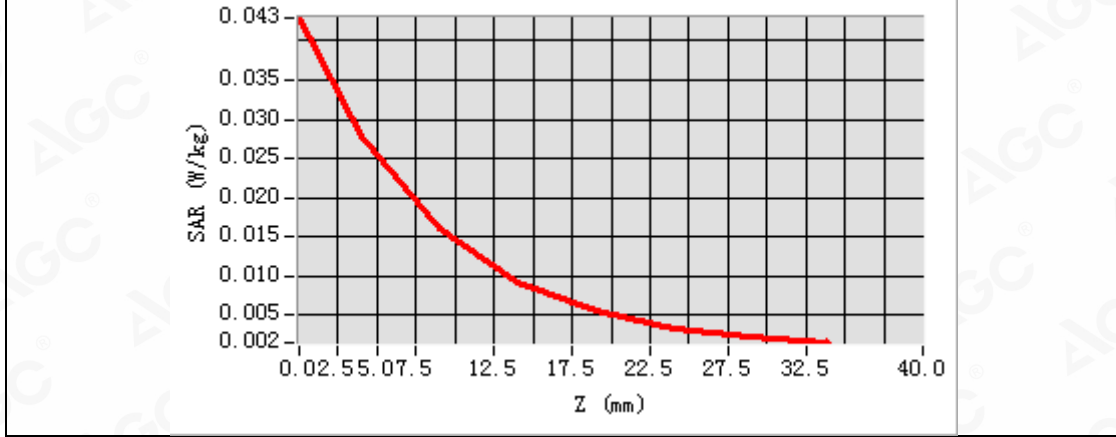

Any report having not been signed by authorized approver, or having been altered without authorization, or having not been stamped by the "Dedicated Testing/Inspection Stamp" is deemed to be invalid. Copying or excerpting portion of, or altering the content of the report is not permitted without the written authorization of AGC. The test results presented in the report apply only to the tested sample. Any objections to report issued by AGC should be submitted to AGC within 15 days after the issuance of the test report. Further enquiry of validity or verification of the test report should be addressed to AGC by agc@agc-cert.com.



Test Laboratory: AGC Lab
LTE Band 66 Mid-Body-Back (50% RB#0)
DUT: Mobile phone; Type: P40

Date: Jul. 05,2021

Communication System: LTE; Communication System Band: LTE Band 66; Duty Cycle:1:1; Conv.F=4.48;
Frequency:1755 MHz; Medium parameters used: $f = 1800$ MHz; $\sigma = 1.40$ mho/m; $\epsilon_r = 38.69$; $\rho = 1000$ kg/m³ ;
Phantom section: Flat Section
Ambient temperature (°C): 21.4, Liquid temperature (°C): 21.2

SATIMO Configuration:

- Probe: SSE5; Calibrated: Dec. 17,2020; Serial No.: SN 03/18 EP327
- Sensor-Surface: 4mm (Mechanical Surface Detection)
- Phantom: SAM twin phantom
- Measurement SW: OpenSAR V4_02_35

Configuration/ LTE Band 66 Mid-Body-back/Area Scan: Measurement grid: dx=8mm, dy=8mm

Configuration/ LTE Band 66 Mid-Body-back/Zoom Scan: Measurement grid: dx=8mm,dy=8mm, dz=5m;

Area Scan	surf_sam_plan.txt, h= 5.00 mm
Zoom Scan	5x5x7,dx=8mm dy=8mm dz=5mm
Phantom	Validation plane
Device Position	Body Back
Band	LTE Band 66
Channels	Middle
Signal	OFDM (Crest factor: 1.0)

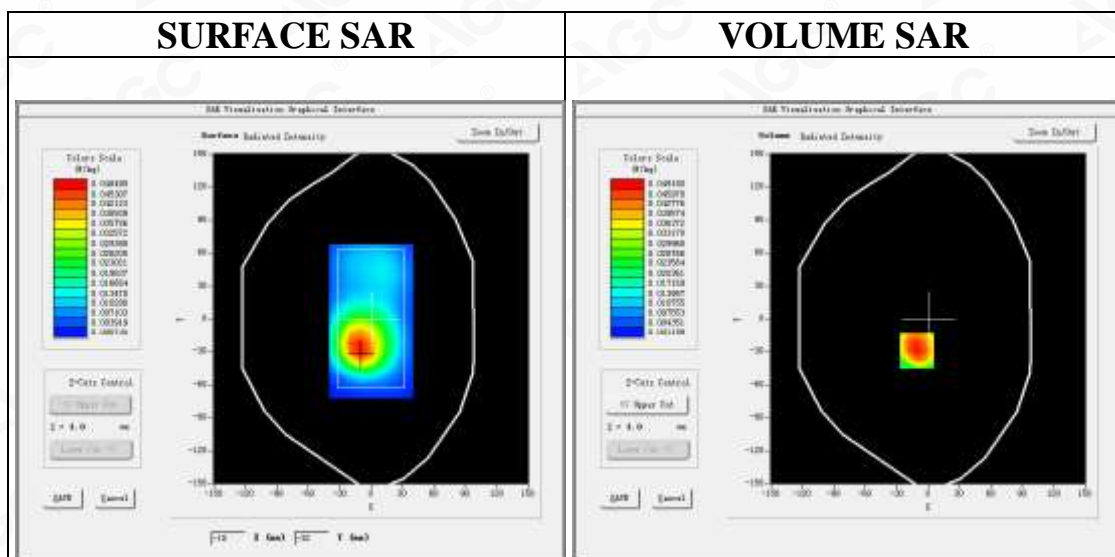

Maximum location: X=-11.00, Y=-29.00

SAR Peak: 0.07 W/kg

SAR 10g (W/Kg)	0.027610
SAR 1g (W/Kg)	0.047431

Any report having not been signed by authorized approver, or having been altered without authorization, or having not been stamped by the "Dedicated Testing/Inspection Stamp" is deemed to be invalid. Copying or excerpting portion of, or altering the content of the report is not permitted without the written authorization of AGC. The test results presented in the report apply only to the tested sample. Any objections to report issued by AGC should be submitted to AGC within 15days after the issuance of the test report. Further enquiry of validity or verification of the test report should be addressed to AGC by agc@agc-cert.com.



Z (mm)	0.00	4.00	9.00	14.00	19.00	24.00	29.00
SAR (W/Kg)	0.0744	0.0492	0.0290	0.0173	0.0106	0.0063	0.0038

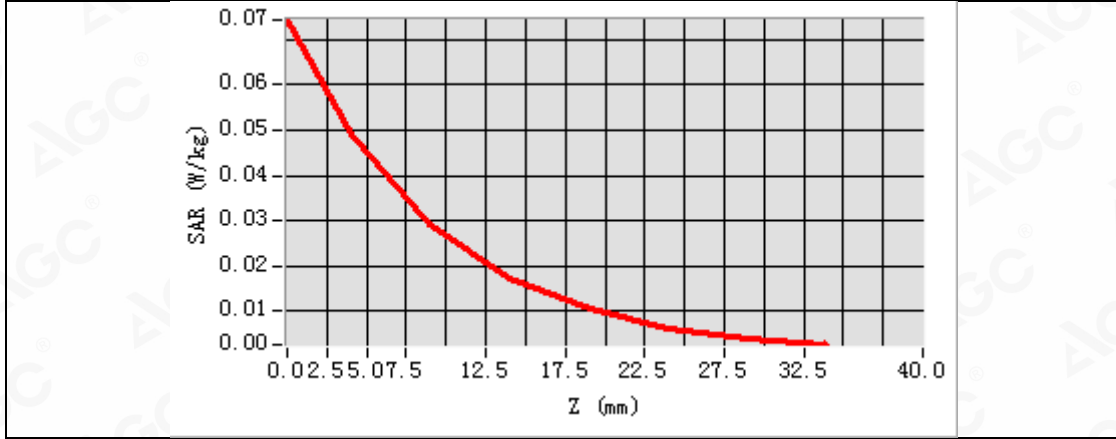

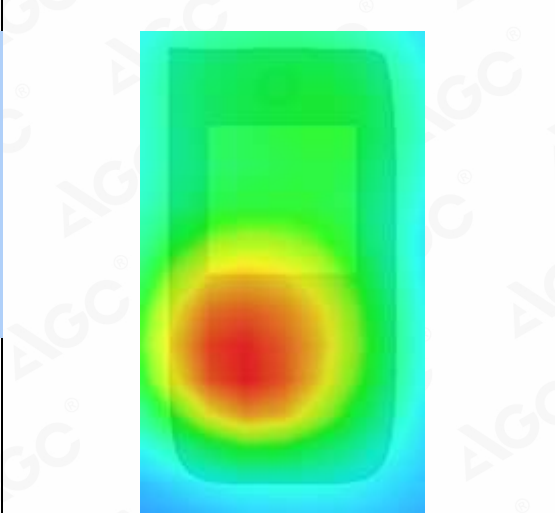
3D screen shot	Hot spot position
	

Any report having not been signed by authorized approver, or having been altered without authorization, or having not been stamped by the "Dedicated Testing/Inspection Stamp" is deemed to be invalid. Copying or excerpting portion of, or altering the content of the report is not permitted without the written authorization of AGC. The test results presented in the report apply only to the tested sample. Any objections to report issued by AGC should be submitted to AGC within 15 days after the issuance of the test report. Further enquiry of validity or verification of the test report should be addressed to AGC by agc@agc-cert.com.



WIFI MODE

Test Laboratory: AGC Lab
802.11b Mid-Touch-Right
DUT: Mobile phone; Type: P40

Date: Jul. 03,2021

Communication System: Wi-Fi; Communication System Band: 802.11b; Duty Cycle: 1:1; Conv.F=4.32;
Frequency: 2437 MHz; Medium parameters used: $f = 2450$ MHz; $\sigma = 1.71$ mho/m; $\epsilon_r = 40.63$ $\rho = 1000$ kg/m³ ;
Phantom section: Right Section
Ambient temperature (°C):20.7, Liquid temperature (°C): 20.5

SATIMO Configuration:

- Probe: SSE5; Calibrated: Dec. 17,2020; Serial No.: SN 03/18 EP327
- Sensor-Surface: 4mm (Mechanical Surface Detection)
- Phantom: SAM twin phantom
- Measurement SW: OpenSAR V4_02_35

Configuration/802.11b Mid- Touch-Right/Area Scan: Measurement grid: dx=8mm, dy=8mm
Configuration/802.11b Mid- Touch-Right/Zoom Scan: Measurement grid: dx=5mm,dy=5mm, dz=5mm

Area Scan	dx=8mm dy=8mm, h= 5.00 mm
ZoomScan	7x7x7,dx=5mm dy=5mm dz=5mm
Phantom	Right head
Device Position	Cheek
Band	2450MHz
Channels	Middle
Signal	Crest factor: 1.0

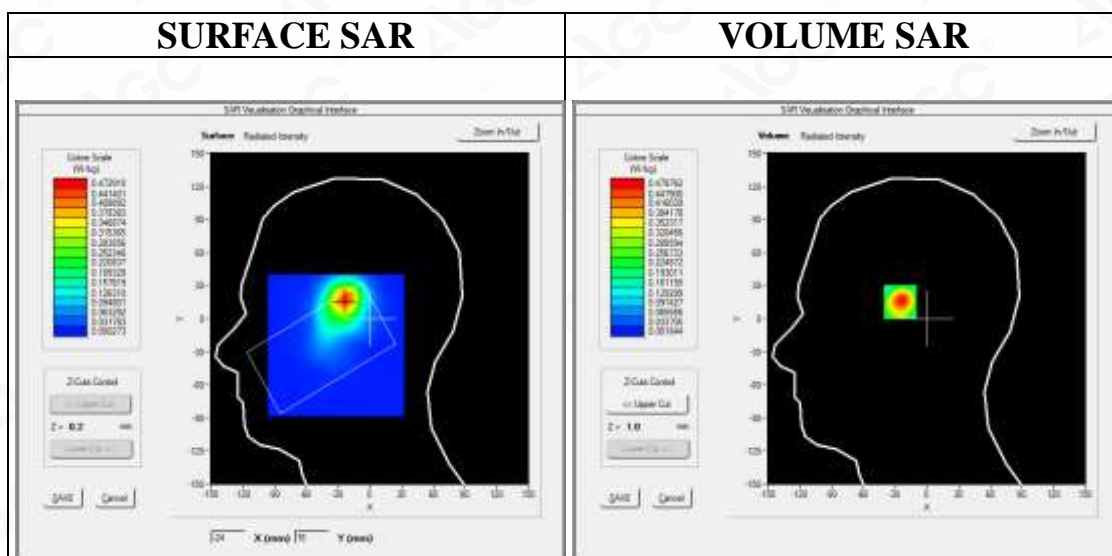

Maximum location: X=-24.00, Y=17.00
SAR Peak: 0.85 W/kg

SAR 10g (W/Kg)	0.210579
SAR 1g (W/Kg)	0.454246

Any report having not been signed by authorized approver, or having been altered without authorization, or having not been stamped by the "Dedicated Testing/Inspection Stamp" is deemed to be invalid. Copying or excerpting portion of, or altering the content of the report is not permitted without the written authorization of AGC. The test results presented in the report apply only to the tested sample. Any objections to report issued by AGC should be submitted to AGC within 15days after the issuance of the test report. Further enquiry of validity or verification of the test report should be addressed to AGC by agc@agc-cert.com.



Z (mm)	0.00	4.00	9.00	14.00	19.00	24.00	29.00
SAR (W/Kg)	0.8259	0.4798	0.2267	0.1071	0.0505	0.0236	0.0112

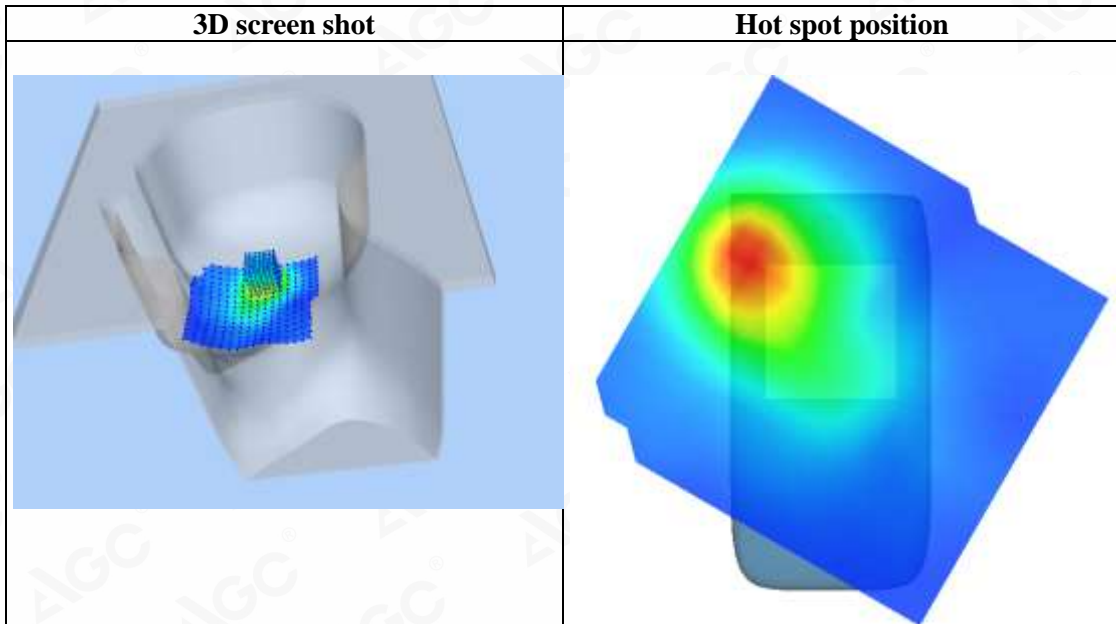
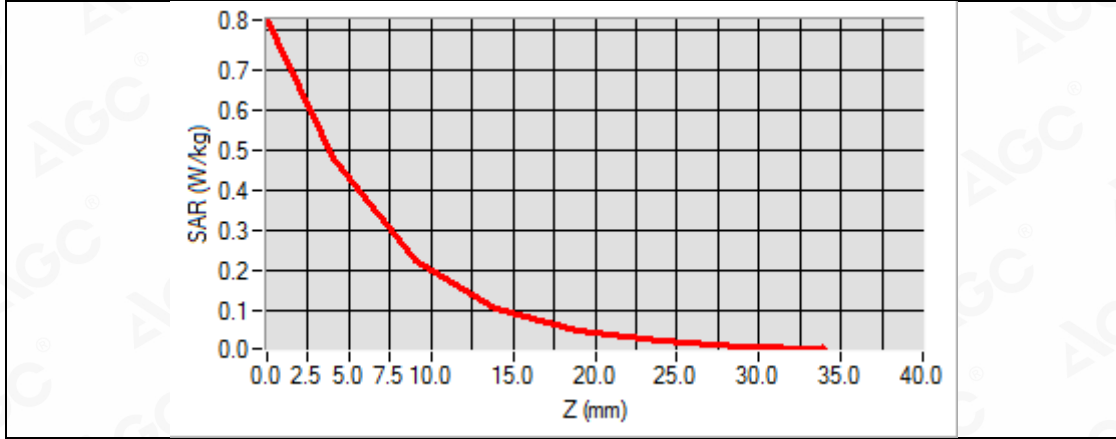

Any report having not been signed by authorized approver, or having been altered without authorization, or having not been stamped by the "Dedicated Testing/Inspection Stamp" is deemed to be invalid. Copying or excerpting portion of, or altering the content of the report is not permitted without the written authorization of AGC. The test results presented in the report apply only to the tested sample. Any objections to report issued by AGC should be submitted to AGC within 15 days after the issuance of the test report. Further enquiry of validity or verification of the test report should be addressed to AGC by agc@agc-cert.com.



Test Laboratory: AGC Lab
802.11b Mid-Body-Worn- Back
DUT: Mobile phone; Type: P40

Date: Jul. 03,2021

Communication System: Wi-Fi; Communication System Band: 802.11b; Duty Cycle: 1:1; Conv.F=4.32;
Frequency: 2437 MHz; Medium parameters used: $f = 2450$ MHz; $\sigma = 1.71$ mho/m; $\epsilon_r = 40.63$; $\rho = 1000$ kg/m³ ;
Phantom section: Flat Section
Ambient temperature (°C):20.7, Liquid temperature (°C): 20.5

SATIMO Configuration:

- Probe: SSE5; Calibrated: Dec. 17,2020; Serial No.: SN 03/18 EP327
- Sensor-Surface: 4mm (Mechanical Surface Detection)
- Phantom: SAM twin phantom
- Measurement SW: OpenSAR V4_02_35

Configuration/802.11b Mid- Body- Back /Area Scan: Measurement grid: dx=8mm, dy=8mm
Configuration/802.11b Mid- Body- Back /Zoom Scan: Measurement grid: dx=5mm,dy=5mm, dz=5mm;

Area Scan	surf_sam_plan.txt, h= 5.00 mm
ZoomScan	7x7x7,dx=5mm dy=5mm dz=5mm
Phantom	Validation plane
Device Position	Body Back
Band	2450MHz
Channels	Middle
Signal	Crest factor: 1.0

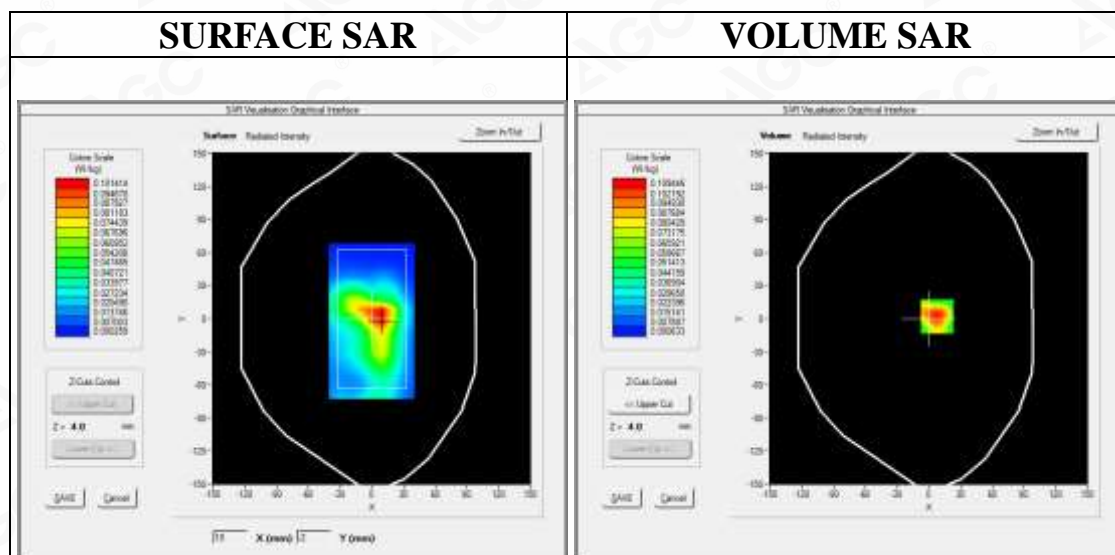

Maximum location: X=8.00, Y=2.00
SAR Peak: 0.19 W/kg

SAR 10g (W/Kg)	0.051110
SAR 1g (W/Kg)	0.103327

Any report having not been signed by authorized approver, or having been altered without authorization, or having not been stamped by the "Dedicated Testing/Inspection Stamp" is deemed to be invalid. Copying or excerpting portion of, or altering the content of the report is not permitted without the written authorization of AGC. The test results presented in the report apply only to the tested sample. Any objections to report issued by AGC should be submitted to AGC within 15days after the issuance of the test report. Further enquiry of validity or verification of the test report should be addressed to AGC by agc@agc-cert.com.



Z (mm)	0.00	4.00	9.00	14.00	19.00	24.00	29.00
SAR (W/Kg)	0.1861	0.1094	0.0528	0.0252	0.0119	0.0052	0.0022

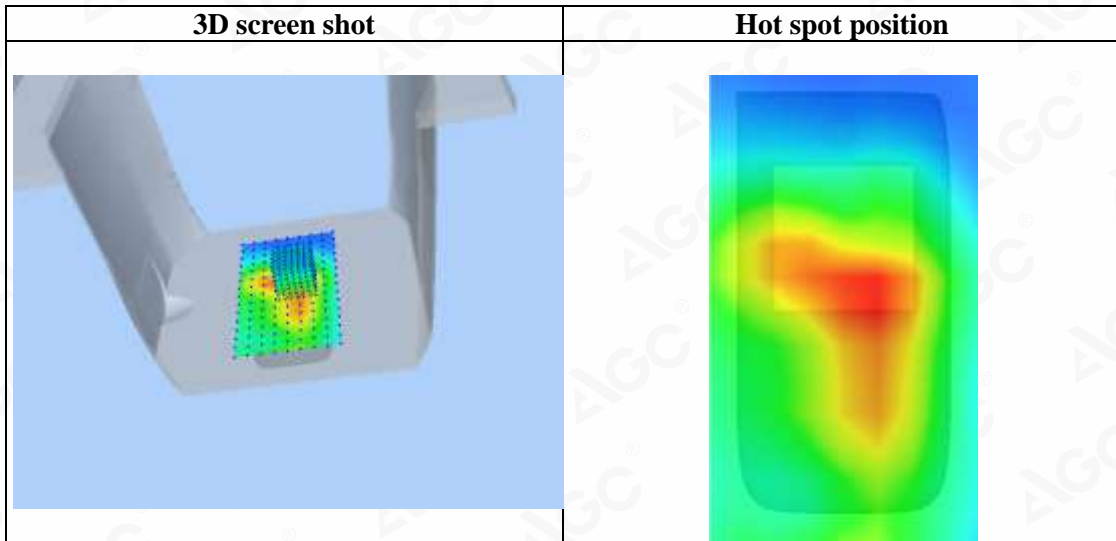
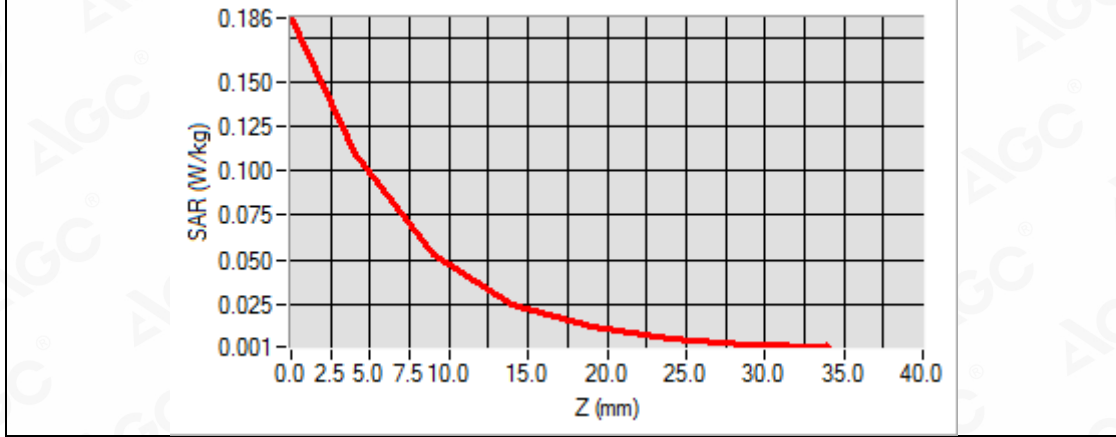

Any report having not been signed by authorized approver, or having been altered without authorization, or having not been stamped by the "Dedicated Testing/Inspection Stamp" is deemed to be invalid. Copying or excerpting portion of, or altering the content of the report is not permitted without the written authorization of AGC. The test results presented in the report apply only to the tested sample. Any objections to report issued by AGC should be submitted to AGC within 15 days after the issuance of the test report. Further enquiry of validity or verification of the test report should be addressed to AGC by agc@agc-cert.com.



Repeated SAR
Test Laboratory: AGC Lab
GPRS 850 Low- Body- Back (3up)
DUT: Mobile phone; Type: P40

Date: Jul. 01,2021

Communication System: GPRS-3 Slot; Communication System Band: GSM 850; Duty Cycle: 1:2.7; Conv.F=5.24;
 Frequency: 824.2 MHz; Medium parameters used: $f = 835$ MHz; $\sigma = 0.88$ mho/m; $\epsilon_r = 42.52$; $\rho = 1000$ kg/m³ ;
 Phantom section: Flat Section
 Ambient temperature (°C): 21.5, Liquid temperature (°C): 21.3

SATIMO Configuration:

- Probe: SSE5; Calibrated: Dec. 17,2020; Serial No.: SN 03/18 EP327
- Sensor-Surface: 4mm (Mechanical Surface Detection)
- Phantom: SAM twin phantom
- Measurement SW: OpenSAR V4_02_35

Configuration/GPRS 850 Low -Body-Back/Area Scan: Measurement grid: dx=8mm, dy=8mm
Configuration/GPRS 850 Low -Body-Back/Zoom Scan: Measurement grid: dx=8mm,dy=8mm, dz=5mm;

Area Scan	surf_sam_plan.txt, h= 5.00 mm
Zoom Scan	5x5x7,dx=8mm dy=8mm dz=5mm,Complete
Phantom	Validation plane
Device Position	Body Back
Band	GSM 850
Channels	Low
Signal	TDMA (Crest factor: 2.7)

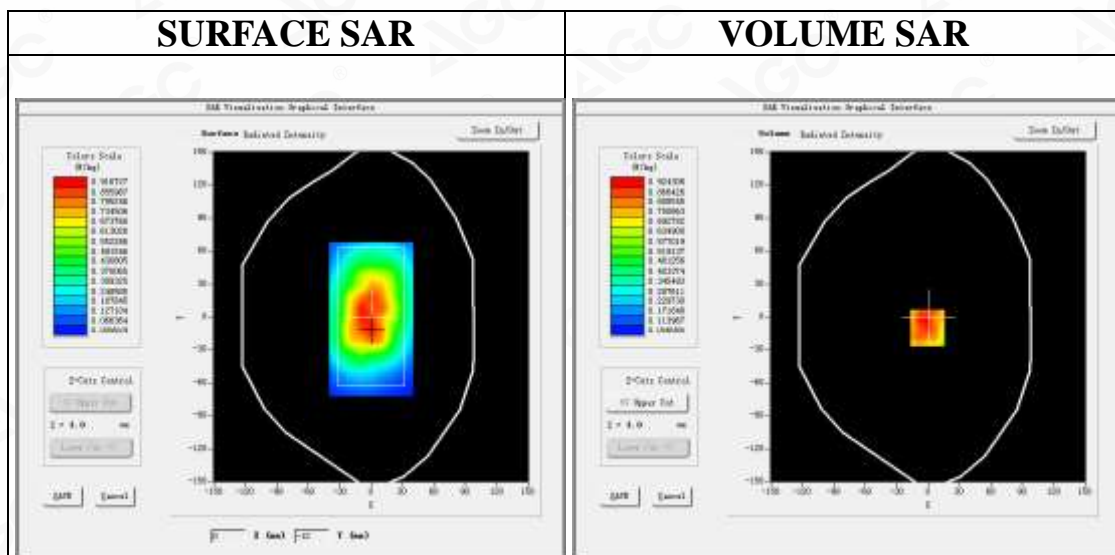

Maximum location: X=-1.00, Y=-10.00
SAR Peak: 1.28 W/kg

SAR 10g (W/Kg)	0.623192
SAR 1g (W/Kg)	0.906790

Any report having not been signed by authorized approver, or having been altered without authorization, or having not been stamped by the "Dedicated Testing/Inspection Stamp" is deemed to be invalid. Copying or excerpting portion of, or altering the content of the report is not permitted without the written authorization of AGC. The test results presented in the report apply only to the tested sample. Any objections to report issued by AGC should be submitted to AGC within 15days after the issuance of the test report. Further enquiry of validity or verification of the test report should be addressed to AGC by agc@agc-cert.com.



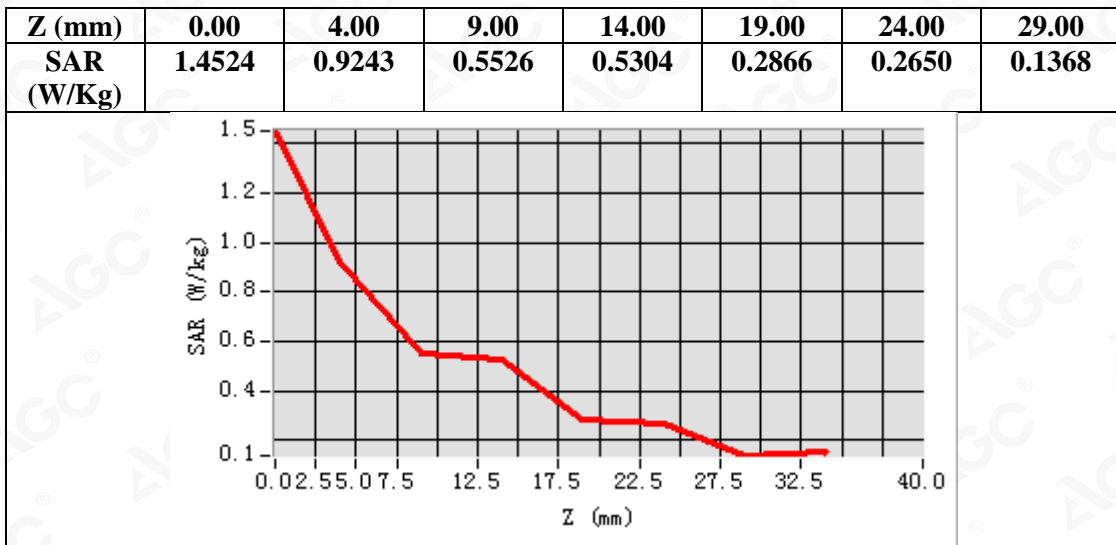

Any report having not been signed by authorized approver, or having been altered without authorization, or having not been stamped by the "Dedicated Testing/Inspection Stamp" is deemed to be invalid. Copying or excerpting portion of, or altering the content of the report is not permitted without the written authorization of AGC. The test results presented in the report apply only to the tested sample. Any objections to report issued by AGC should be submitted to AGC within 15days after the issuance of the test report. Further enquiry of validity or verification of the test report should be addressed to AGC by agc@agc-cert.com.



APPENDIX C. TEST SETUP PHOTOGRAPHS LEFT-CHEEK TOUCH



LEFT-TILT 15°

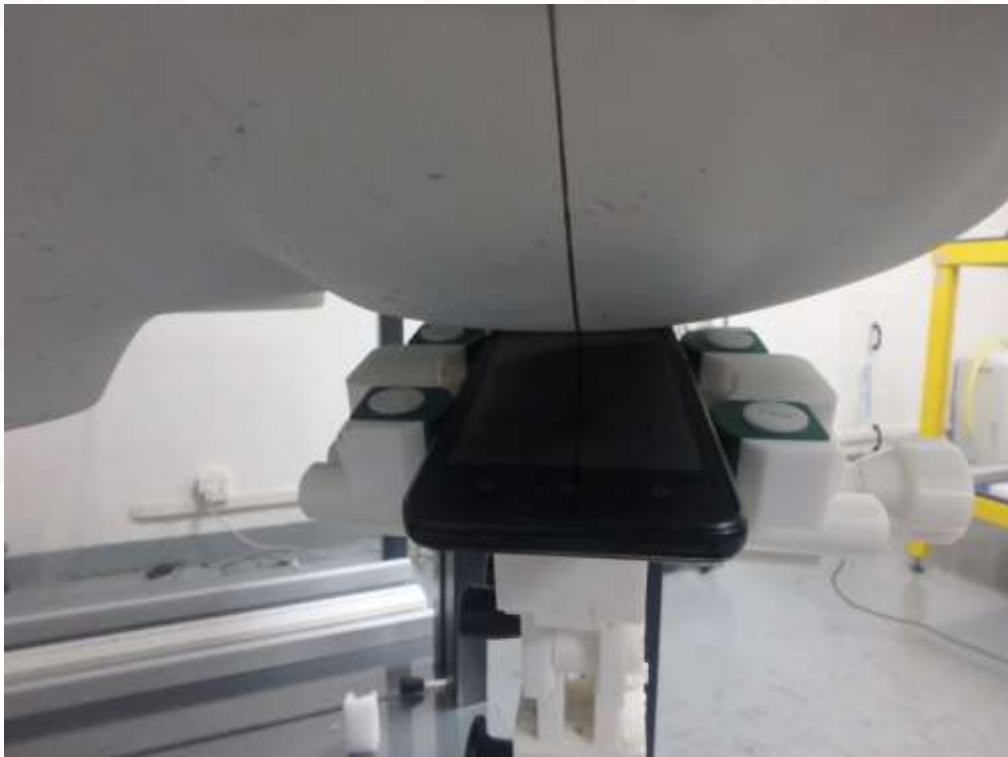

Any report having not been signed by authorized approver, or having been altered without authorization, or having not been stamped by the "Dedicated Testing/Inspection Stamp" is deemed to be invalid. Copying or excerpting portion of, or altering the content of the report is not permitted without the written authorization of AGC. The test results presented in the report apply only to the tested sample. Any objections to report issued by AGC should be submitted to AGC within 15days after the issuance of the test report. Further enquiry of validity or verification of the test report should be addressed to AGC by agc@agc-cert.com.

Attestation of Global Compliance(Shenzhen)Co., Ltd
Attestation of Global Compliance(Shenzhen)Std & Tech Co., Ltd
Tel: +86-755 2523 4088 E-mail: agc@agc-cert.com Web: <http://cn.agc-cert.com/>



RIGHT- CHEEK TOUCH

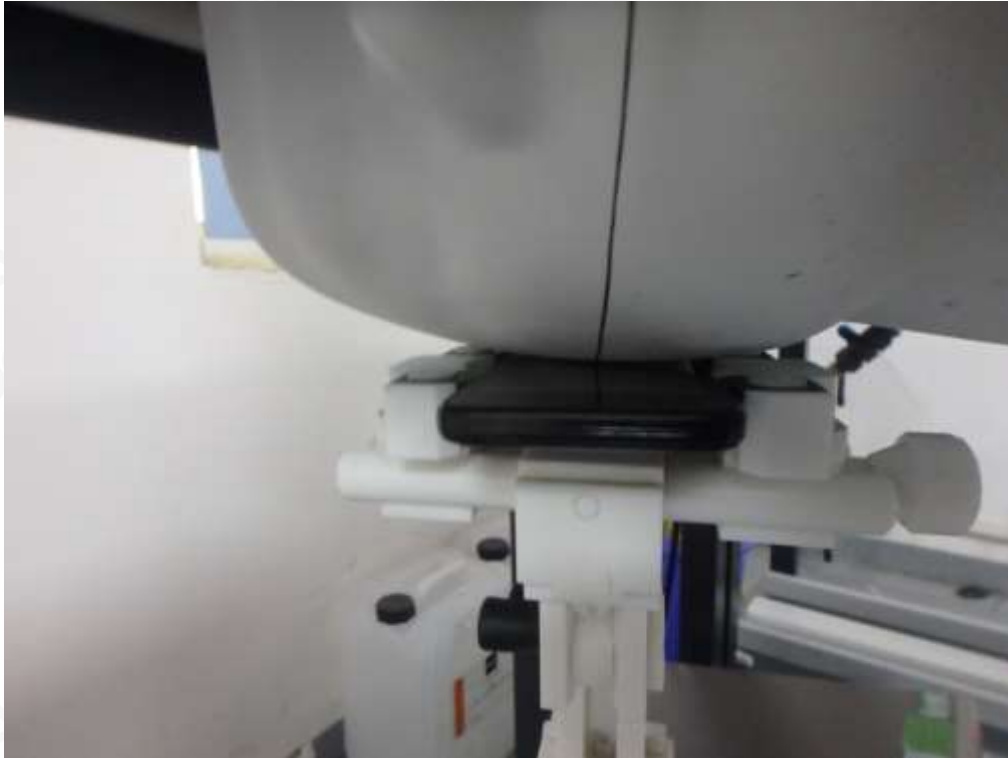

RIGHT-TILT 15°

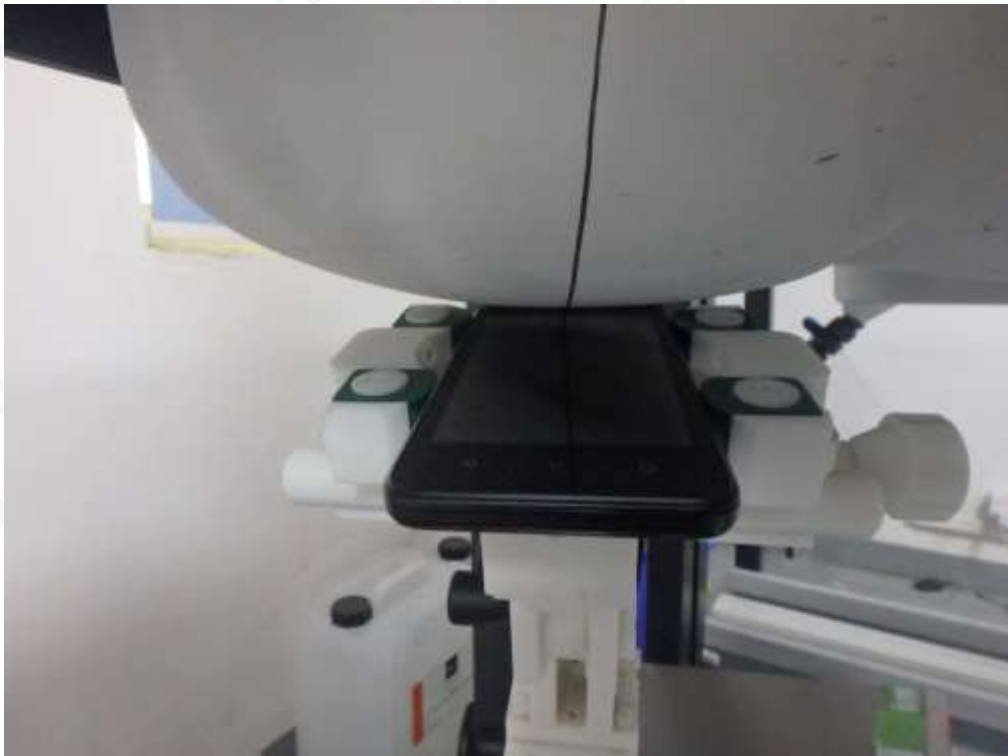

Any report having not been signed by authorized approver, or having been altered without authorization, or having not been stamped by the "Dedicated Testing/Inspection Stamp" is deemed to be invalid. Copying or excerpting portion of, or altering the content of the report is not permitted without the written authorization of AGC. The test results presented in the report apply only to the tested sample. Any objections to report issued by AGC should be submitted to AGC within 15days after the issuance of the test report. Further enquiry of validity or verification of the test report should be addressed to AGC by agc@agc-cert.com.

Attestation of Global Compliance(Shenzhen)Co., Ltd
Attestation of Global Compliance(Shenzhen)Std & Tech Co., Ltd
Tel: +86-755 2523 4088 E-mail: agc@agc-cert.com Web: <http://cn.agc-cert.com/>



Body Back 10mm



Body Front 10mm



Any report having not been signed by authorized approver, or having been altered without authorization, or having not been stamped by the "Dedicated Testing/Inspection Stamp" is deemed to be invalid. Copying or excerpting portion of, or altering the content of the report is not permitted without the written authorization of AGC. The test results presented in the report apply only to the tested sample. Any objections to report issued by AGC should be submitted to AGC within 15days after the issuance of the test report. Further enquiry of validity or verification of the test report should be addressed to AGC by agc@agc-cert.com.

Attestation of Global Compliance(Shenzhen)Co., Ltd
Attestation of Global Compliance(Shenzhen)Std & Tech Co., Ltd
Tel: +86-755 2523 4088 E-mail: agc@agc-cert.com Web: <http://cn.agc-cert.com/>



Edge 1(Top) 10mm-Hotspot Mode

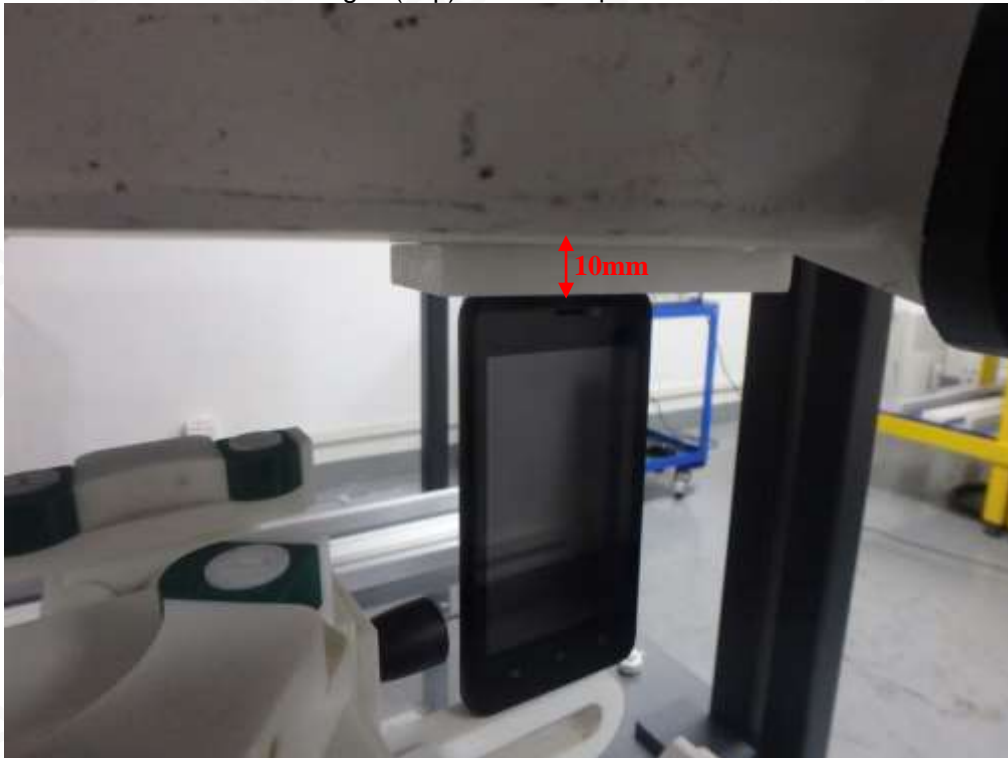

Edge 2(Right) 10mm-Hotspot Mode

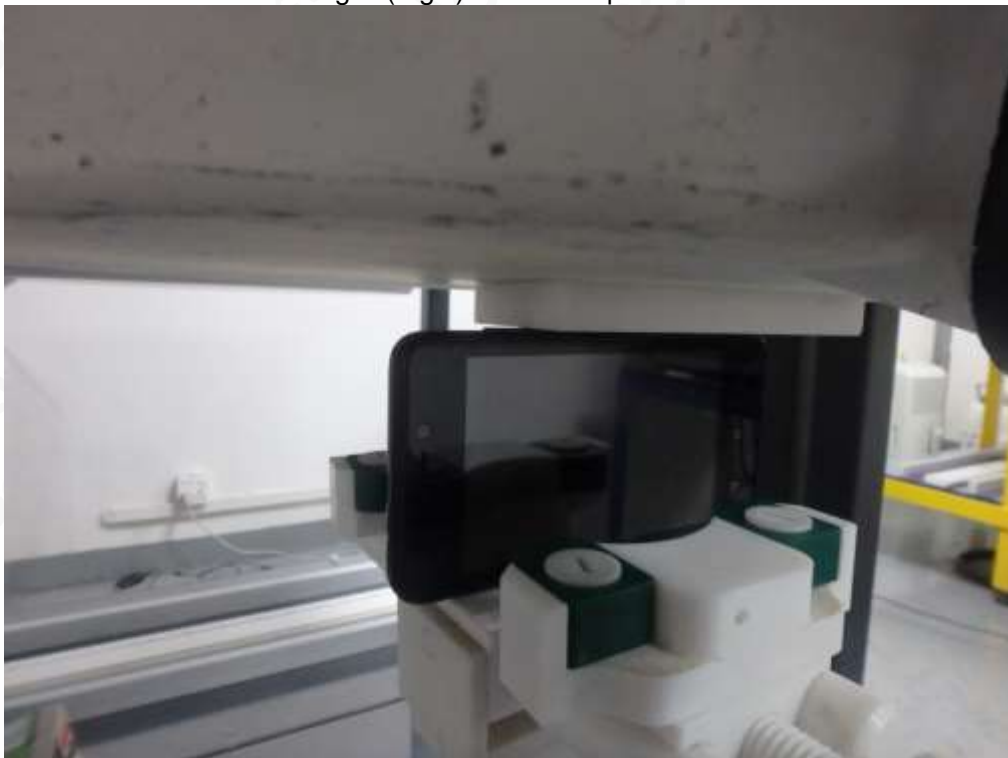

Any report having not been signed by authorized approver, or having been altered without authorization, or having not been stamped by the "Dedicated Testing/Inspection Stamp" is deemed to be invalid. Copying or excerpting portion of, or altering the content of the report is not permitted without the written authorization of AGC. The test results presented in the report apply only to the tested sample. Any objections to report issued by AGC should be submitted to AGC within 15days after the issuance of the test report. Further enquiry of validity or verification of the test report should be addressed to AGC by agc@agc-cert.com.

Attestation of Global Compliance(Shenzhen)Co., Ltd
Attestation of Global Compliance(Shenzhen)Std & Tech Co., Ltd
Tel: +86-755 2523 4088 E-mail: agc@agc-cert.com Web: <http://cn.agc-cert.com/>



Edge 3(Bottom) 10mm-Hotspot Mode

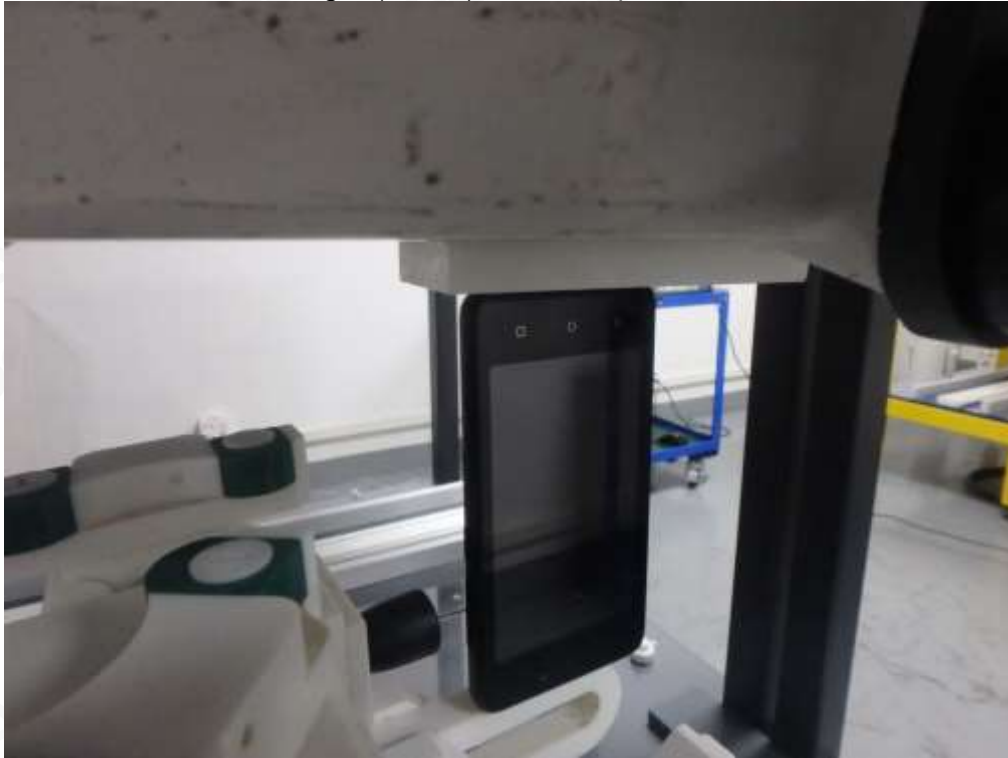

Edge 4(Left) 10mm-Hotspot Mode

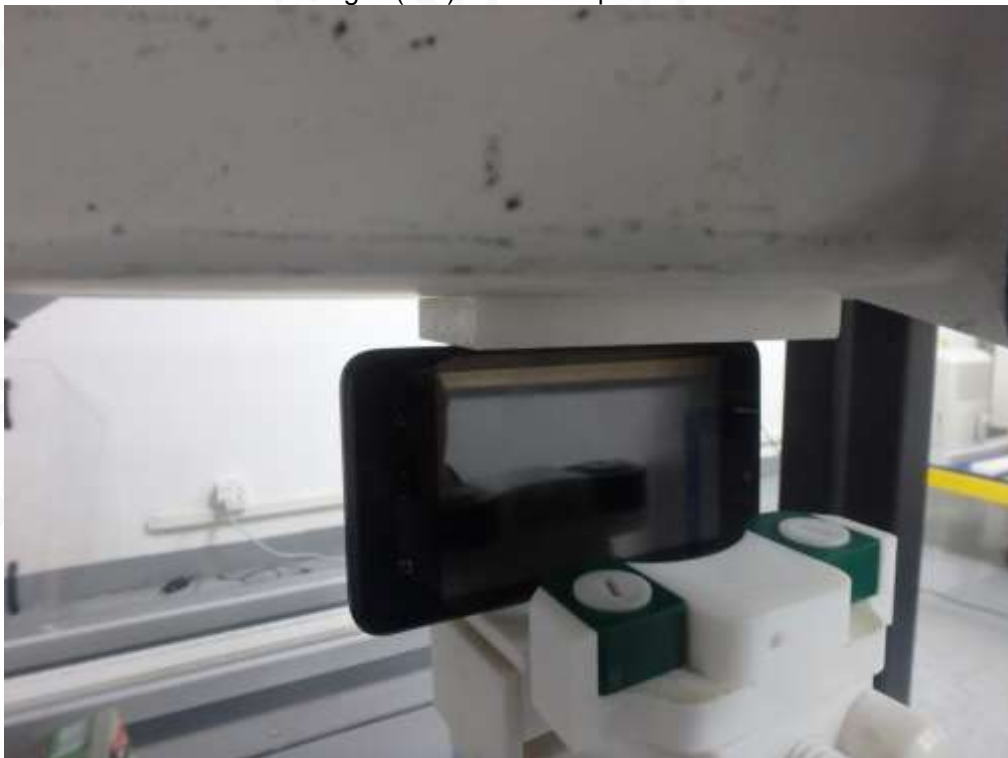

Any report having not been signed by authorized approver, or having been altered without authorization, or having not been stamped by the "Dedicated Testing/Inspection Stamp" is deemed to be invalid. Copying or excerpting portion of, or altering the content of the report is not permitted without the written authorization of AGC. The test results presented in the report apply only to the tested sample. Any objections to report issued by AGC should be submitted to AGC within 15days after the issuance of the test report. Further enquiry of validity or verification of the test report should be addressed to AGC by agc@agc-cert.com.

Attestation of Global Compliance(Shenzhen)Co., Ltd
Attestation of Global Compliance(Shenzhen)Std & Tech Co., Ltd
Tel: +86-755 2523 4088 E-mail: agc@agc-cert.com Web: <http://cn.agc-cert.com/>



DEPTH OF THE LIQUID IN THE PHANTOM—ZOOM IN

Note : The position used in the measurement were according to IEEE 1528-2013

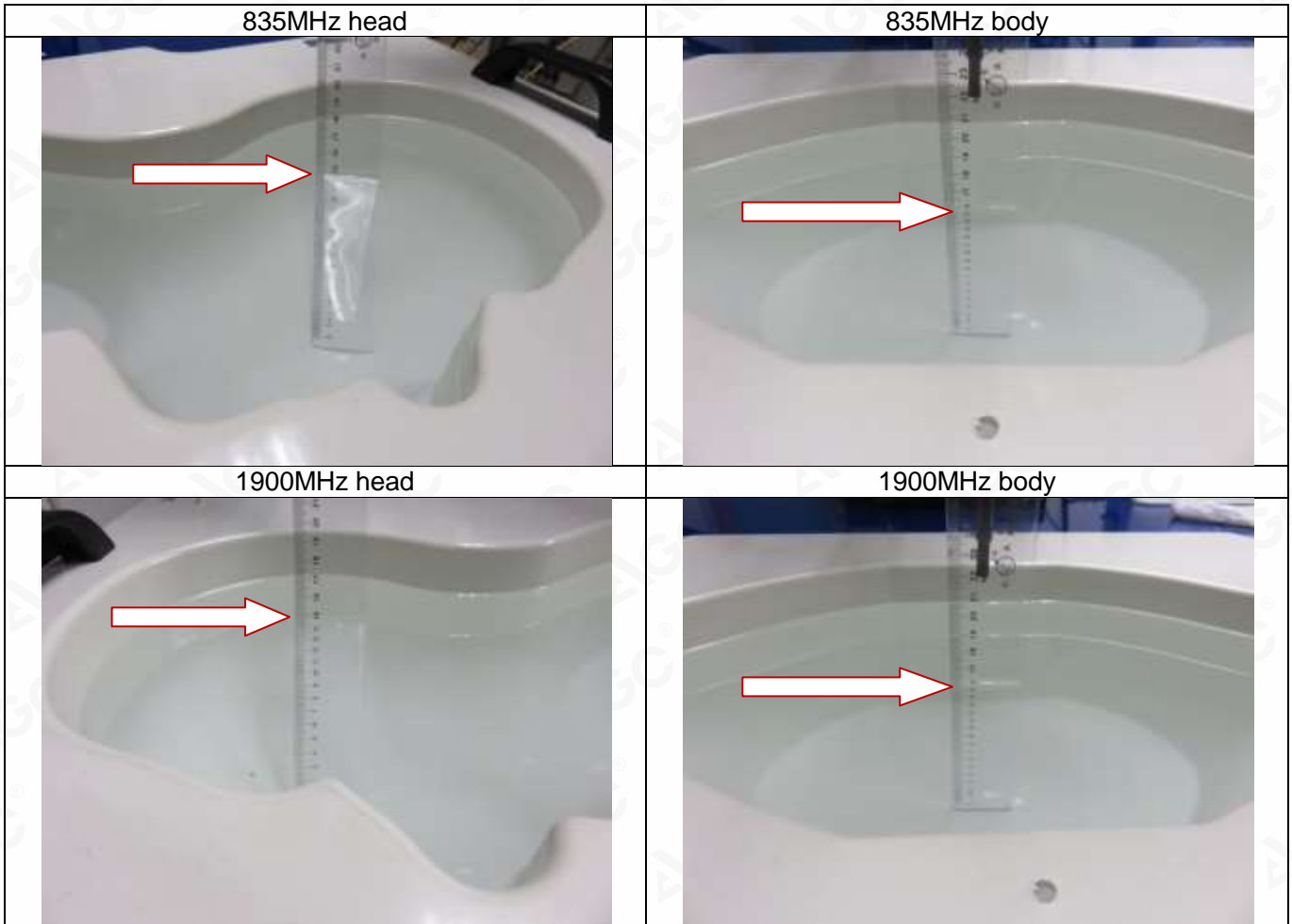

Any report having not been signed by authorized approver, or having been altered without authorization, or having not been stamped by the "Dedicated Testing/Inspection Stamp" is deemed to be invalid. Copying or excerpting portion of, or altering the content of the report is not permitted without the written authorization of AGC. The test results presented in the report apply only to the tested sample. Any objections to report issued by AGC should be submitted to AGC within 15days after the issuance of the test report. Further enquiry of validity or verification of the test report should be addressed to AGC by agc@agc-cert.com.

Attestation of Global Compliance(Shenzhen)Co., Ltd
Attestation of Global Compliance(Shenzhen)Std & Tech Co., Ltd
Tel: +86-755 2523 4088 E-mail: agc@agc-cert.com Web: http://cn.agc-cert.com/



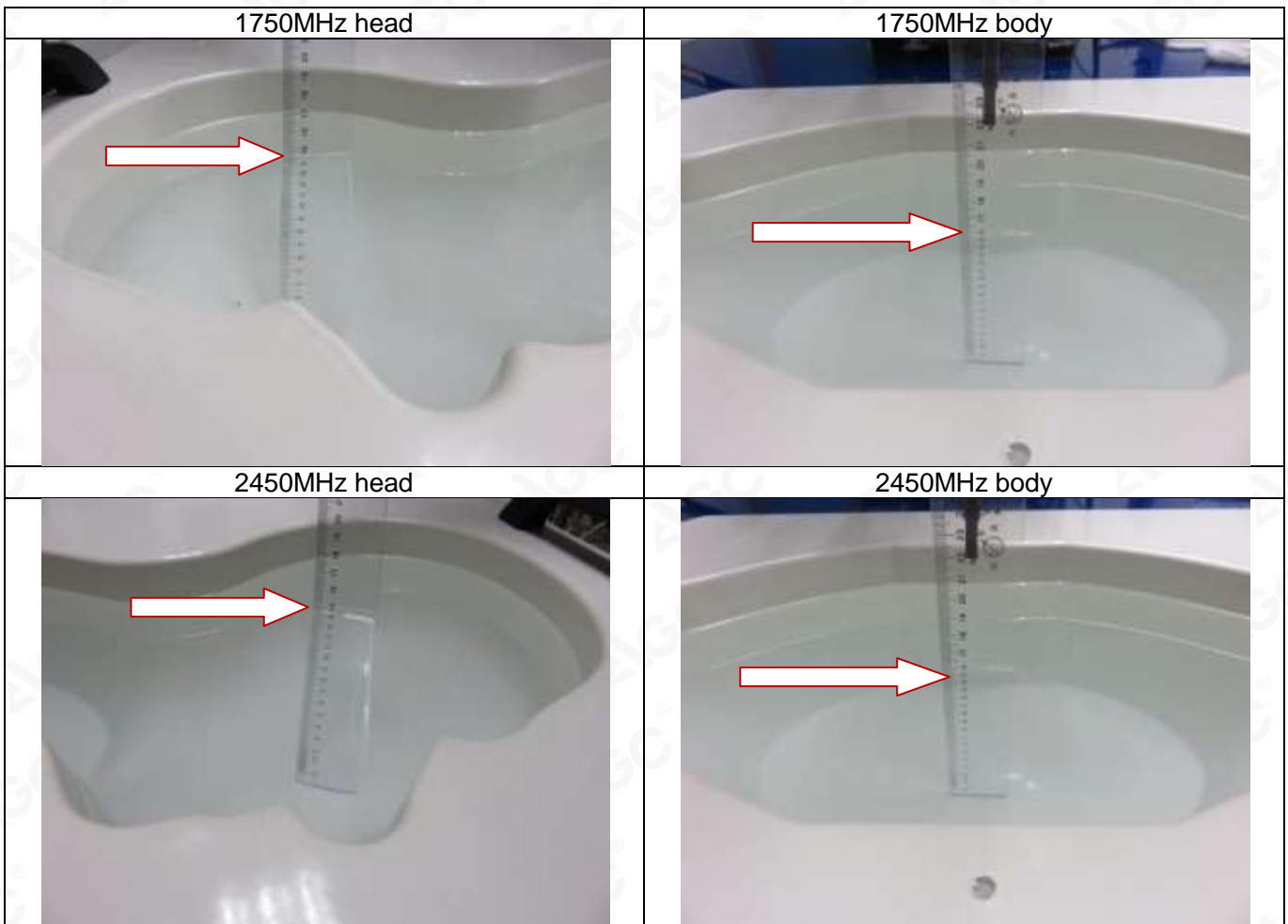

Any report having not been signed by authorized approver, or having been altered without authorization, or having not been stamped by the "Dedicated Testing/Inspection Stamp" is deemed to be invalid. Copying or excerpting portion of, or altering the content of the report is not permitted without the written authorization of AGC. The test results presented in the report apply only to the tested sample. Any objections to report issued by AGC should be submitted to AGC within 15days after the issuance of the test report. Further enquiry of validity or verification of the test report should be addressed to AGC by agc@agc-cert.com.

Attestation of Global Compliance(Shenzhen)Co., Ltd
Attestation of Global Compliance(Shenzhen)Std & Tech Co., Ltd
Tel: +86-755 2523 4088 E-mail: agc@agc-cert.com Web: <http://cn.agc-cert.com/>



APPENDIX D. CALIBRATION DATA

Refer to Attached files.

Any report having not been signed by authorized approver, or having been altered without authorization, or having not been stamped by the "Dedicated Testing/Inspection Stamp" is deemed to be invalid. Copying or excerpting portion of, or altering the content of the report is not permitted without the written authorization of AGC. The test results presented in the report apply only to the tested sample. Any objections to report issued by AGC should be submitted to AGC within 15days after the issuance of the test report. Further enquiry of validity or verification of the test report should be addressed to AGC by agc@agc-cert.com.

Attestation of Global Compliance(Shenzhen)Co., Ltd
Attestation of Global Compliance(Shenzhen)Std & Tech Co., Ltd
Tel: +86-755 2523 4088 E-mail: agc@agc-cert.com Web: <http://cn.agc-cert.com/>





Conditions of Issuance of Test Reports

1. All samples and goods are accepted by the Attestation of Global Compliance (Shenzhen) Co., Ltd (the “Company”) solely for testing and reporting in accordance with the following terms and conditions. The company provides its services on the basis that such terms and conditions constitute express agreement between the company and any person, firm or company requesting its services (the “Clients”).
2. Any report issued by Company as a result of this application for testing services (the “Report”) shall be issued in confidence to the Clients and the Report will be strictly treated as such by the Company. It may not be reproduced either in its entirety or in part and it may not be used for advertising or other unauthorized purposes without the written consent of the Company. The Clients to whom the Report is issued may, however, show or send it, or a certified copy thereof prepared by the Company to its customer, supplier or other persons directly concerned. The Company will not, without the consent of the Clients, enter into any discussion or correspondence with any third party concerning the contents of the Report, unless required by the relevant governmental authorities, laws or court orders.
3. The Company shall not be called or be liable to be called to give evidence or testimony on the Report in a court of law without its prior written consent, unless required by the relevant governmental authorities, laws or court orders.
4. The non-CMA report issued by AGC is only permitted to be used by the client as internal reference use and shall not be used for public demonstration purpose.
5. In the event of the improper use of the report as determined by the Company, the Company reserves the right to withdraw it, and to adopt any other additional remedies which may be appropriate.
6. Samples submitted for testing are accepted on the understanding that the Report issued cannot form the basis of, or be the instrument for, any legal action against the Company.
7. The Company will not be liable for or accept responsibility for any loss or damage however arising from the use of information contained in any of its Reports or in any communication whatsoever about its said tests or investigations.
8. Clients wishing to use the Report in court proceedings or arbitration shall inform the Company to that effect prior to submitting the sample for testing.
9. The Company is not responsible for recalling the electronic version of the original report when any revision is made to them. The Client assumes the responsibility to providing the revised version to any interested party who uses them.
10. Subject to the variable length of retention time for test data and report stored hereinto as otherwise specifically required by individual accreditation authorities, the Company will only keep the supporting test data and information of the test report for a period of six years. The data and information will be disposed of after the aforementioned retention period has elapsed. Under no circumstances shall we provide any data and information which has been disposed of after retention period. Under no circumstances shall we be liable for damage of any kind, including (but not limited to) compensatory damages, lost profits, lost data, or any form of special, incidental, indirect, consequential or punitive damages of any kind, whether based on breach of contract of warranty, tort (including negligence), product liability or otherwise, even if we are informed in advance of the possibility of such damages.

Any report having not been signed by authorized approver, or having been altered without authorization, or having not been stamped by the “Dedicated Testing/Inspection Stamp” is deemed to be invalid. Copying or excerpting portion of, or altering the content of the report is not permitted without the written authorization of AGC. The test results presented in the report apply only to the tested sample. Any objections to report issued by AGC should be submitted to AGC within 15 days after the issuance of the test report. Further enquiry of validity or verification of the test report should be addressed to AGC by agc@agc-cert.com.

